

Test Report

Verified code: 707630

Report No.: E20221011998501-4

Customer: OnePlus Technology (Shenzhen) Co., Ltd.

Address: 18C02, 18C03, 18C04 and 18C05, Shum Yip Terra Building, Binhe Avenue North, Futian District, Shenzhen, China

Sample Name: Wireless Earbuds

Sample Model: E507A

Receive Sample Date: Oct.12,2022

Test Date: Oct.19,2022 ~ Oct.22,2022

Reference Document: IEEE Std. 1528:2013
47 CFR FCC Part 2.1093
IEEE Std. C95.1:2019

Test Result: Pass

Prepared by: *Wen Wen*

Reviewed by: *Wu Haoming*

Approved by: *Xiao Liang*

GUANGZHOU GRG METROLOGY & TEST CO., LTD

Issued Date: 2022-11-04

GUANGZHOU GRG METROLOGY & TEST CO., LTD

Address: No.163 Xipingyun Road, Huangpu Avenue, Tianhe District, Guangzhou (510656)

Tel: (+86) 400-602-0999 FAX: (+86) 020-38698685 Web: <http://www.grgtest.com>



Statement

1. The report is invalid without "special seal for inspection and testing"; some copies are invalid; The report is invalid if it is altered or missing; The report is invalid without the signature of the person who prepared, reviewed and approved it.
2. The sample information is provided by the client and responsible for its authenticity; The content of the report is only valid for the samples sent this time.
3. When there are reports in both Chinese and English, the Chinese version will prevail when the language problems are inconsistent.
4. If there is any objection concerning the report, please inform us within 15 days from the date of receiving the report.
5. Without the agreement of the laboratory, the client is not authorized to use the test results for unapproved propaganda.

TABLE OF CONTENTS

1.	GENERAL INFORMATION	5
2.	GENERAL INFORMATION OF EUT.....	6
2.1	STATEMENT OF COMPLIANCE	6
2.2	GENERAL DESCRIPTION	7
2.3	LABORATORY ENVIRONMENT	8
3.	LABORATORY AND ACCREDITATIONS	9
3.1	LABORATORY.....	9
3.2	ACCREDITATIONS	9
4.	MEASUREMENT UNCERTAINTY	10
5.	SAR MEASUREMENTS SYSTEM.....	11
5.1	DEFINITION OF SPECIFIC ABSORPTION RATE (SAR)	11
5.2	SAR SYSTEM	12
5.3	E-FIELD PROBE.....	13
5.4	DATA ACQUISITION ELECTRONICS (DAE)	14
5.5	ROBOT	15
5.6	MEASUREMENT SERVER	16
5.7	PHANTOM.....	17
5.8	DEVICE HOLDER	18
5.9	DATA STORAGE AND EVALUATION	19
6.	TEST EQUIPMENT LIST.....	21
7.	SYSTEM VERIFICATION PROCEDURE.....	22
7.1	TISSUE VERIFICATION	22
7.2	SYSTEM CHECK PROCEDURE.....	23
8.	SAR MEASUREMENT VARIABILITY	25
9.	EUT TESTING POSITION	26
9.1	BODY WORN POSITION	26
10.	MEASUREMENT PROCEDURES.....	27
10.1	SPATIAL PEAK SAR EVALUATION.....	27
10.2	POWER REFERENCE MEASUREMENT	27
10.3	AREA SCAN PROCEDURES.....	28
10.4	ZOOM SCAN PROCEDURES.....	29
10.5	VOLUME SCAN PROCEDURES	30
10.6	POWER DRIFT MONITORING.....	30
11.	CONDUCTED POWER	31
12.	SAR TEST RESULTS SUMMARY.....	33
13.	SIMULTANEOUS TRANSMISSION ANALYSIS.....	34
	APPENDIX A. SYSTEM CHECKING SCANS	35
	APPENDIX B. MEASUREMENT SCANS	36
	APPENDIX C. RELEVANT PAGES FROM PROBE CALIBRATION REPORT(S).....	38
	APPENDIX D: PHOTOGRAPH OF SET UP	38
	APPENDIX E: PHOTOGRAPH OF THE EUT	38

REPORT ISSUED HISTORY

Report Version	Report No.	Description	Compile Date
1.0	E20221011998501-4	Original Issue	2022-10-28

----- The following blanks -----

1. GENERAL INFORMATION

Applicant	OnePlus Technology (Shenzhen) Co., Ltd.
Address	18C02, 18C03, 18C04 and 18C05, Shum Yip Terra Building, Binhe Avenue North, Futian District, Shenzhen, China
Manufacturer	OnePlus Technology (Shenzhen) Co., Ltd.
Address	18C02, 18C03, 18C04 and 18C05, Shum Yip Terra Building, Binhe Avenue North, Futian District, Shenzhen, China
Standard(s)	<p>IEEE Std 1528-2013 Recommended Practice for Determining the Peak Spatial-Average Specific Absorption Rate (SAR) in the Human Head from Wireless Communications Devices: Measurement Techniques</p> <p>47 CFR FCC Part 2.1093 Radio frequency radiation exposure evaluation: portable devices</p> <p>ANSI Std C95.1-2019 Safety Levels with Respect to Human Exposure to Radio Frequency Electromagnetic Fields, 3 kHz - 300 GHz.</p> <p>KDB 447498 D01 v06 General RF Exposure Guidance</p> <p>KDB 865664 D01 v01r04 SAR measurement 100 MHz to 6 GHz</p> <p>KDB 865664 D02 v01r02 RF Exposure Reporting</p>

----- The following blanks -----

2. GENERAL INFORMATION OF EUT

2.1 STATEMENT OF COMPLIANCE

Frequency Band	DUT	Mode	Test Position	Highest Reported SAR(W/Kg)	Mass Average (g)	SAR Test Limit (W/Kg)
Bluetooth	Left Ear	DH5	Right Side	0.508	1	1.6
	Right Ear	DH5	Left Side	0.516	1	1.6
Test Result			PASS			

Note:

This device is in compliance with Specific Absorption Rate (SAR) for general population/uncontrolled exposure limits (1.6 W/kg for localized Head, Neck and Trunk 1g SAR, 4.0 W/Kg for localized Limbs 10g SAR) specified in FCC 47 CFR part 2 (2.1093) and ANSI/IEEE C95.1-2019, and had been tested in accordance with the measurement methods and procedures specified in IEEE 1528-2013 and IEC 62209-2:2019.

----- The following blanks -----

2.2 GENERAL DESCRIPTION

Equipment	Wireless Earbuds		
Brand Name	ONEPLUS		
Model Name	E507A		
Series Model	/		
Model Difference	/		
Sample No.	E20221011998501-0003		
FCC ID	2ABZ2-E507A		
Device Type	Portable device		
HW Version	X22E2_0		
SW Version	V087		
Frequency Range	Band	TX (MHz)	RX (MHz)
	Bluetooth	2402-2480	
Device class	Class B		
Type of Modulation:	BR+EDR: GFSK for 1Mbps, $\pi/4$ -DQPSK for 2Mbps, 8DPSK for 3Mbps BT-LE: GFSK for 1 Mbps & 2 Mbps		
Antenna Specification:	Integrated antenna with Left earphone:-2.0dBi Right earphone:-2.6dBi		
Test Channels (low-mid-high):	0-39-78 (BR+EDR) 0-19-39 (BT-LE)		
Operating Mode:	Maximum continuous output		
Other Information			
Power Supply:			
Battery Specification:			
Sample submitting way:	<input checked="" type="checkbox"/> Provided by customer <input type="checkbox"/> Sampling		
Note:	/		

2.3 LABORATORY ENVIRONMENT

Temperature	Min. = 18 °C, Max. = 25 °C
Relative humidity	Min. = 30%, Max. = 70%
Ground system resistance	< 0.5Ω
Ambient noise is checked and found very low and in compliance with requirement of standards. Reflection of surrounding objects is minimized and in compliance with requirement of standards.	

----- The following blanks -----

3. LABORATORY AND ACCREDITATIONS

3.1 LABORATORY

The tests and measurements refer to this report were performed by Shenzhen EMC Laboratory of Guangzhou GRG Metrology & Test Co., Ltd.	
Add.:	No.1301 Guanguang Road Xinlan Community, Guanlan Street, Longhua District Shenzhen, 518110, People's Republic of China.
P.C.:	518110
Tel :	0755-61180008
Fax:	0755-61180008

3.2 ACCREDITATIONS

Our laboratories are accredited and approved by the following approval agencies according to ISO/IEC 17025.

USA A2LA(Certificate #2861.01)

The measuring facility of laboratories has been authorized or registered by the following approval agencies.

Canada ISED (Company Number: 24897, CAB identifier:CN0069)

USA FCC (Registration Number: 759402, Designation Number:CN1198)

Copies of granted accreditation certificates are available for downloading from our web site, <http://www.grgtest.com>

----- The following blanks -----

4. MEASUREMENT UNCERTAINTY

Per KDB865664 D01 SAR Measurement 100 MHz to 6 GHz, when the highest measured 1-g SAR within a frequency band is < 1.5 W/kg, the extensive SAR measurement uncertainty analysis described in IEEE Std 1528-2013 is not required in SAR reports submitted for equipment approval. The equivalent ratio (1.5/1.6) is applied to extremity and occupational exposure conditions.

----- The following blanks -----

5. SAR MEASUREMENTS SYSTEM

5.1 DEFINITION OF SPECIFIC ABSORPTION RATE (SAR)

SAR is related to the rate at which energy is absorbed per unit mass in an object exposed to a radio field. The SAR distribution in a biological body is complicated and is usually carried out by experimental techniques or numerical modeling. The standard recommends limits for two tiers of groups, occupational/controlled and general population/uncontrolled, based on a person's awareness and ability to exercise control over his or her exposure. In general, occupational/controlled exposure limits are higher than the limits for general population/uncontrolled.

The SAR definition is the time derivative (rate) of the incremental energy (dW) absorbed by (dissipated in) an incremental mass (dm) contained in a volume element (dv) of a given density (ρ). The equation description is as below:

$$\text{SAR} = \frac{d}{dt} \left(\frac{dW}{dm} \right) = \frac{d}{dt} \left(\frac{dW}{\rho dv} \right)$$

SAR is expressed in units of Watts per kilogram (W/kg) SAR measurement can be related to the electrical field in the tissue by

$$\text{SAR} = \frac{\sigma E^2}{\rho}$$

Where: σ is the conductivity of the tissue;
 ρ is the mass density of the tissue and E is the RMS electrical field strength.

----- The following blanks -----

5.2 SAR SYSTEM

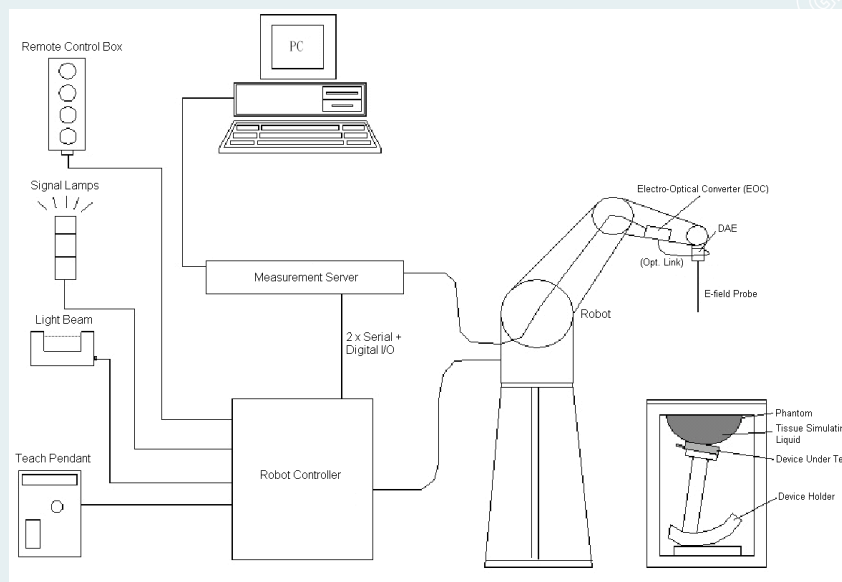

DASy System Configurations

The DASy system for performance compliance tests is illustrated above graphically. This system consists of the following items:

- A standard high precision 6-axis robot with controller, a teach pendant and software
- A data acquisition electronic (DAE) attached to the robot arm extension
- A dosimetric probe equipped with an optical surface detector system
- The electro-optical converter (EOC) performs the conversion between optical and electrical signals
- A measurement server performs the time critical tasks such as signal filtering, control of the robot operation and fast movement interrupts.
- A probe alignment unit which improves the accuracy of the probe positioning
- A computer operating Windows XP
- DASy software
- Remote control with teach pendant and additional circuitry for robot safety such as warning lamps, etc.
- The SAM twin phantom
- A device holder
- Tissue simulating liquid
- Dipole for evaluating the proper functioning of the system

Components are described in details in the following sub-sections.

5.3 E-FIELD PROBE

The SAR measurement is conducted with the dosimetric probe (manufactured by SPEAG). The probe is specially designed and calibrated for use in liquid with high permittivity. The dosimetric probe has special calibration in liquid at different frequency. This probe has a built in optical surface detection system to prevent from collision with phantom.

➤ **E-Field Probe Specification**
 <ES3DV3 Probe>

Construction	Symmetrical design with triangular core Interleaved sensors Built-in shielding against static charges PEEK enclosure material (resistant to organic solvents, e.g., DGBE)	 <p style="text-align: center;">Photo of ES3DV3</p>
Calibration	ISO/IEC 17025 calibration service available	
Frequency	10 MHz to 6 GHz Linearity: ±0.2 dB (30 MHz to 6 GHz)	
Directivity	±0.3 dB in HSL (rotation around probe axis) ±0.5 dB in tissue material (rotation normal to probe axis)	
Dynamic Range	10 µW/g to > 100 mW/g Linearity: ± 0.2dB	
Dimensions	Overall length: 330 mm (Tip: 20 mm) Tip diameter: 2.5 mm (Body: 12 mm) Distance from probe tip to dipole centers: 1.0 mm	

➤ **E-Field Probe Calibration**

Each probe needs to be calibrated according to a dosimetric assessment procedure with accuracy better than ± 10%. The spherical isotropy shall be evaluated and within ± 0.25dB. The sensitivity parameters (NormX, NormY, and NormZ), the diode compression parameter (DCP) and the conversion factor (ConvF) of the probe are tested. The calibration data can be referred to appendix C of this report.

5.4 DATA ACQUISITION ELECTRONICS (DAE)

The data acquisition electronics (DAE) consists of a highly sensitive electrometer-grade preamplifier with auto-zeroing, a channel and gain-switching multiplexer, a fast 16 bit AD-converter and a command decoder and control logic unit. Transmission to the measurement server is accomplished through an optical downlink for data and status information as well as an optical uplink for commands and the clock.

The input impedance of the DAE is 200M Ω ; the inputs are symmetrical and floating. Common mode rejection is above 80dB.



Photo of DAE

----- The following blanks -----

5.5 ROBOT

The SPEAG DASY system uses the high precision robots (DASY5: TX60XL) type from Stäubli SA (France). For the 6-axis controller system, the robot controller version (DASY5: CS8c) from Stäubli is used. The Stäubli robot series have many features that are important for our application:

- High precision (repeatability ± 0.035 mm)
- High reliability (industrial design)
- Jerk-free straight movements
- Low ELF interference (the closed metallic construction shields against motor control fields)

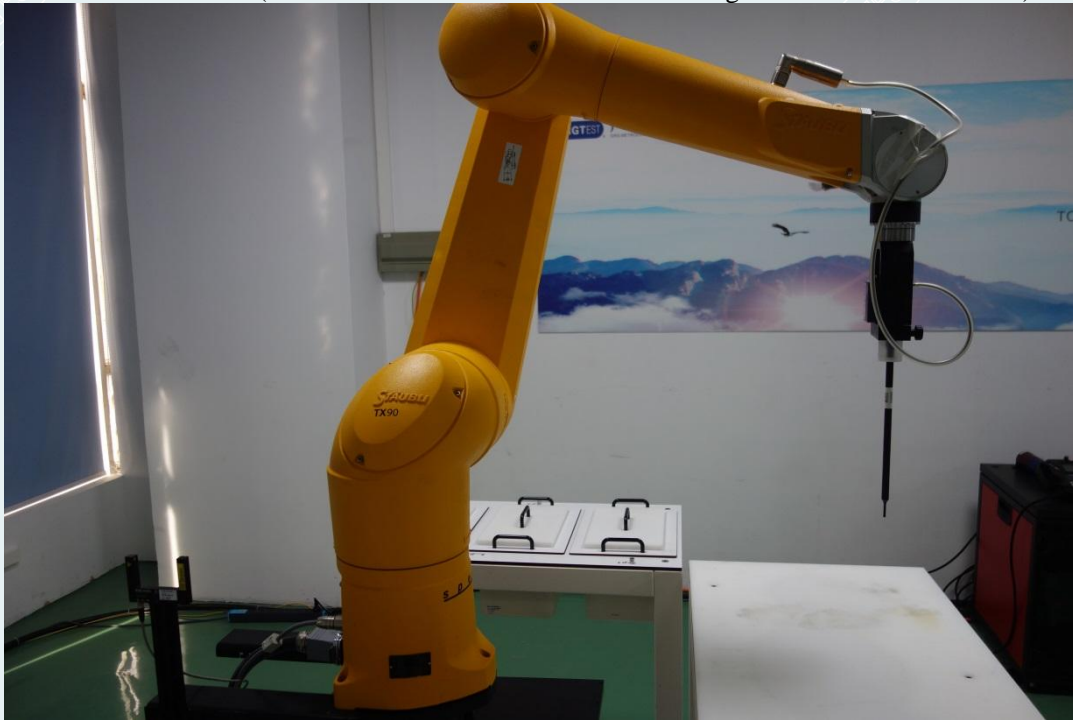

Photo of DASY5

----- The following blanks -----

5.6 MEASUREMENT SERVER

The measurement server is based on a PC/104 CPU board with CPU (DASY5: 400 MHz, Intel Celeron), chip disk (DASY5: 128 MB), RAM (DASY5: 128 MB). The necessary circuits for communication with the DAE electronic box, as well as the 16 bit AD converter system for optical detection and digital I/O interface are contained on the DASY I/O board, which is directly connected to the PC/104 bus of the CPU board.

The measurement server performs all the real-time data evaluation for field measurements and surface detection, controls robot movements and handles safety operations.



Photo of Server for DASY5

----- The following blanks -----

5.7 PHANTOM

<SAM Twin Phantom>

Shell Thickness	2 ±0.2 mm; Center ear point: 6 ±0.2 mm	 <p>Photo of SAM Phantom</p>
Filling Volume	Approx. 25 liters	
Dimensions	Length: 1000 mm; Width: 500 mm; Height: adjustable feet	
Measurement Areas	Left Hand, Right Hand, Flat Phantom	

The bottom plate contains three pair of bolts for locking the device holder. The device holder positions are adjusted to the standard measurement positions in the three sections. A white cover is provided to tap the phantom during off-periods to prevent water evaporation and changes in the liquid parameters. On the phantom top, three reference markers are provided to identify the phantom position with respect to the robot.

----- The following blanks -----

5.8 DEVICE HOLDER

The SAR in the phantom is approximately inversely proportional to the square of the distance between the source and the liquid surface. For a source at 5 mm distance, a positioning uncertainty of $\pm 0.5\text{mm}$ would produce a SAR uncertainty of $\pm 20\%$. Accurate device positioning is therefore crucial for accurate and repeatable measurements. The positions in which the devices must be measured are defined by the standards.

The DASY device holder is designed to cope with different positions given in the standard. It has two scales for the device rotation (with respect to the body axis) and the device inclination (with respect to the line between the ear reference points). The rotation center for both scales is the ear reference point (ERP). Thus the device needs no repositioning when changing the angles.

The DASY device holder is constructed of low-loss POM material having the following dielectric parameters: relative permittivity $\epsilon = 3$ and loss tangent $\delta = 0.02$. The amount of dielectric material has been reduced in the closest vicinity of the device, since measurements have suggested that the influence of the clamp on the test results could thus be lowered.



Device Holder

5.9 DATA STORAGE AND EVALUATION

➤ Data Storage

The DASY software stores the assessed data from the data acquisition electronics as raw data (in microvolt readings from the probe sensors), together with all the necessary software parameters for the data evaluation (probe calibration data, liquid parameters and device frequency and modulation data) in measurement files. The post-processing software evaluates the desired unit and format for output each time the data is visualized or exported. This allows verification of the complete software setup even after the measurement and allows correction of erroneous parameter settings. For example, if a measurement has been performed with an incorrect crest factor parameter in the device setup, the parameter can be corrected afterwards and the data can be reevaluated.

The measured data can be visualized or exported in different units or formats, depending on the selected probe type (e.g., [V/m], [A/m], [mW/g]). Some of these units are not available in certain situations or give meaningless results, e.g., a SAR-output in a non-lose media, will always be zero. Raw data can also be exported to perform the evaluation with other software packages.

➤ Data Evaluation

The DASY post-processing software (SEMCAD) automatically executes the following procedures to calculate the field units from the microvolt readings at the probe connector. The parameters used in the evaluation are stored in the configuration modules of the software:

Probe parameters:	- Sensitivity	Norm _i , a _{i0} , a _{i1} , a _{i2}
	- Conversion factor	ConvF _i
	- Diode compression point	dcp _i
Device parameters:	- Frequency	f
	- Crest factor	cf
Media parameters:	- Conductivity	σ
	- Density	ρ

These parameters must be set correctly in the software. They can be found in the component documents or they can be imported into the software from the configuration files issued for the DASY components. In the direct measuring mode of the multi-meter option, the parameters of the actual system setup are used. In the scan visualization and export modes, the parameters stored in the corresponding document files are used.

The first step of the evaluation is a linearization of the filtered input signal to account for the compression characteristics of the detector diode. The compensation depends on the input signal, the diode type and the DC-transmission factor from the diode to the evaluation electronics. If the exciting field is pulsed, the crest factor of the signal must be known to correctly compensate for peak power.

The formula for each channel can be given as:

$$V_i = U_i + U_i^2 \cdot \frac{cf}{dcp_i}$$

with V_i = compensated signal of channel i , ($i = x, y, z$)
 U_i = input signal of channel i , ($i = x, y, z$)
 cf = crest factor of exciting field (DASY parameter)
 dcp_i = diode compression point (DASY parameter)

From the compensated input signals, the primary field data for each channel can be evaluated:

$$\text{E-field Probes: } \mathbf{E}_i = \sqrt{\frac{V_i}{\text{Norm}_i \cdot \text{ConvF}}}$$

H-field Probes:
$$H_i = \sqrt{V_i \cdot \frac{a_{i0} + a_{i1}f + a_{i2}f^2}{f}}$$

with V_i = compensated signal of channel i , ($i = x, y, z$)

$Norm_i$ = sensor sensitivity of channel i , ($i = x, y, z$), $\mu V/(V/m)^2$ for E-field Probes

ConvF = sensitivity enhancement in solution

a_{ij} = sensor sensitivity factors for H-field probes

f = carrier frequency [GHz]

E_i = electric field strength of channel i in V/m

H_i = magnetic field strength of channel i in A/m

The RSS value of the field components gives the total field strength (Hermitian magnitude):

$$E_{tot} = \sqrt{E_x^2 + E_y^2 + E_z^2}$$

The primary field data are used to calculate the derived field units.

$$SAR = E_{tot}^2 \cdot \frac{\sigma}{\rho \cdot 1000}$$

with SAR = local specific absorption rate in mW/g

E_{tot} = total field strength in V/m

σ = conductivity in [mho/m] or [Siemens/m]

ρ = equivalent tissue density in g/cm^3

Note that the density is set to 1, to account for actual head tissue density rather than the density of the tissue simulating liquid.

----- The following blanks -----

6. TEST EQUIPMENT LIST

Kind of Equipment	Manufacturer	Type No.	Serial No.	Last Calibration	Calibrated Until
2450MHz Dipole	SPEAG	D2450V2	933	2021.04.14	2023.04.13
ES3DV3 SAR Probe	SPEAG	ES3DV3	SN 3308	2022.03.09	2023.03.08
Data Acquisition Electronics	SPEAG	DAE4	SN 796	2022.03.09	2023.03.08
ENA Series Network Analyzer	Keysight	85032F	MY53202809	2022.05.30	2023.05.29
DAK	SPEAG	DAK-3.5	1056	N/A	N/A
Twin SAM Phantom1	SPEAG	QD000P40CD	1743	N/A	N/A
SAM Twin Phantom2	SPEAG	QD000P40CD	1745	N/A	N/A
2mm Triple Flat Phantom	SPEAG	QD000P51CA	1134/3	N/A	N/A
Power Meter	Anritsu	ML2495A	1204003	2022.03.01	2023.02.28
Power Sensor	Anritsu	MA2411B	1126150	2022.03.02	2023.03.01
Spectrum Analyzer	Keysight	N9010A	MY55370330	2021.11.09	2022.11.08
Signal generator	R&S	SMA100A	100434	2022.08.20	2023.08.19

Remark:

1. "N/A" denotes no model name, serial No. or calibration specified.
2. *Thesetestequipmentshavebeenrecalibratedbetweenthetestperiods.Allthesetestequipments were within the valid period when the tests were performed.
3. Per KDB865664 D01 requirements for dipole calibration, the test laboratory has adopted three-year extended calibration interval. Each measured dipole is expected to evaluate with the following criteria at least on annual interval in Appendix C.
 - a) There is no physical damage on the dipole;
 - b) System check with specific dipole is within 10% of calibrated value;
 - c) The most recent return-loss result , measured at least annually, deviates by no more than 20% from the previous measurement;
 - d) The most recent measurement of the real or imaginary parts of the impedance, measured at least annually is within 5Ω from the previous measurement.

----- The following blanks -----

7. SYSTEM VERIFICATION PROCEDURE

7.1 TISSUE VERIFICATION

For the measurement of the field distribution inside the SAM phantom with DASY, the phantom must be filled with around 25 liters of homogeneous body tissue simulating liquid. For head SAR testing, the liquid height from the ear reference point (ERP) of the phantom to the liquid top surface is larger than 15 cm, which is shown in Fig. 6.1. For body SAR testing, the liquid height from the center of the flat phantom to the liquid top surface is larger than 15 cm, which is shown as followed:

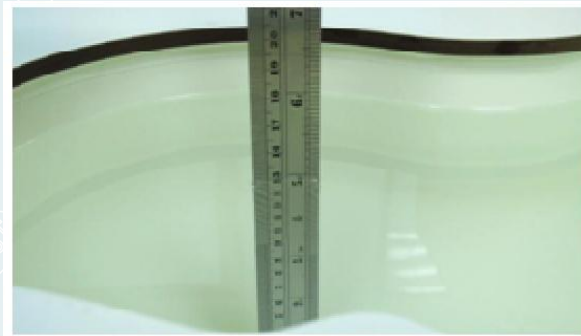

Photo of 2450HSL Liquid Height for Head SAR

Frequency (MHz)	Water (%)	Sugar (%)	Cellulose (%)	Salt (%)	Preventol (%)	DGBE (%)	Conductivity (σ)	Permittivity (ϵ_r)
For Head								
2450	55.0	0	0	0	0	45.0	1.80	39.2

The following table shows the measuring results for simulating liquid.

Tissue Type	Measured Frequency (MHz)	Target Value ($\pm 10\%$)		Measured Value		Tissue temperature ($^{\circ}\text{C}$)	Measured Date
		ϵ_r	$\sigma(\text{S/M})$	ϵ_r	$\sigma(\text{S/M})$		
2450 HSL	2450	39.20 (35.28~43.12)	1.80 (1.62~1.98)	39.36	1.87	21.7	2022-10-22
	2400	39.30 (37.34~41.27)	1.75 (1.66~1.84)	39.84	1.83		
	2500	39.13 (37.17~41.08)	1.85 (1.76~1.94)	39.30	1.89		

Note:

- 1) The dielectric parameters of the tissue-equivalent liquid should be measured under similar ambient conditions and within 2°C of the conditions expected during the SAR evaluation to satisfy protocol requirements.
- 2) KDB 865664 was ensured to be applied for probe calibration frequencies greater than or equal to 50MHz of the EUT frequencies.
- 3) The above measured tissue parameters were used in the DASY software to perform interpolation via the DASY software to determine actual dielectric parameters at the test frequencies. The SAR test plots may slightly differ from the table above since the DASY rounds to three significant digits.

7.2 SYSTEM CHECK PROCEDURE

Each DASY system is equipped with one or more system validation kits. These units, together with the predefined measurement procedures within the DASY software, enable the user to conduct the system performance check and system validation. System validation kit includes a dipole, tripod holder to fix it underneath the flat phantom and a corresponding distance holder.

➤ Purpose of System Performance check

The system performance check verifies that the system operates within its specifications. System and operator errors can be detected and corrected. It is recommended that the system performance check be performed prior to any usage of the system in order to guarantee reproducible results. The system performance check uses normal SAR measurements in a simplified setup with a well characterized source. This setup was selected to give a high sensitivity to all parameters that might fail or vary over time. The system check does not intend to replace the calibration of the components, but indicates situations where the system uncertainty is exceeded due to drift or failure.

➤ System Setup

In the simplified setup for system evaluation, the EUT is replaced by a calibrated dipole and the power source is replaced by a continuous wave that comes from a signal generator. The calibrated dipole must be placed beneath the flat phantom section of the SAM twin phantom with the correct distance holder. The distance holder should touch the phantom surface with a light pressure at the reference marking and be oriented parallel to the long side of the phantom. The equipment setup is shown below:

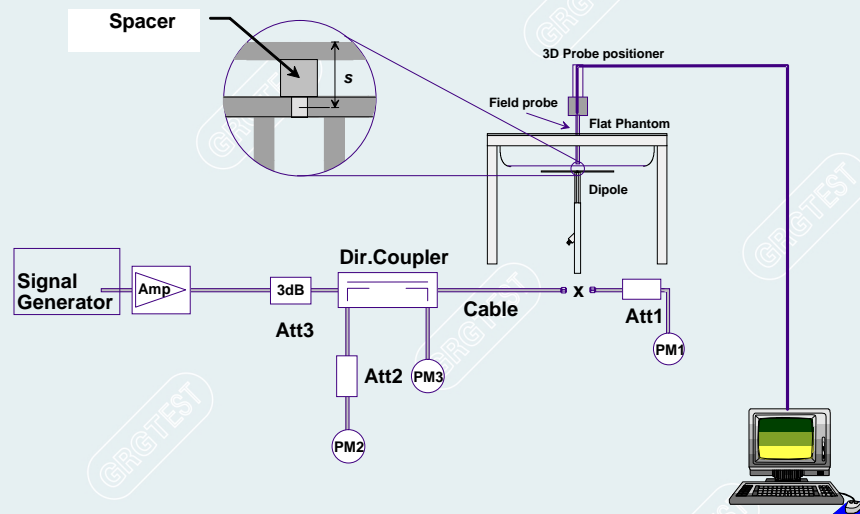

System Setup for System Evaluation

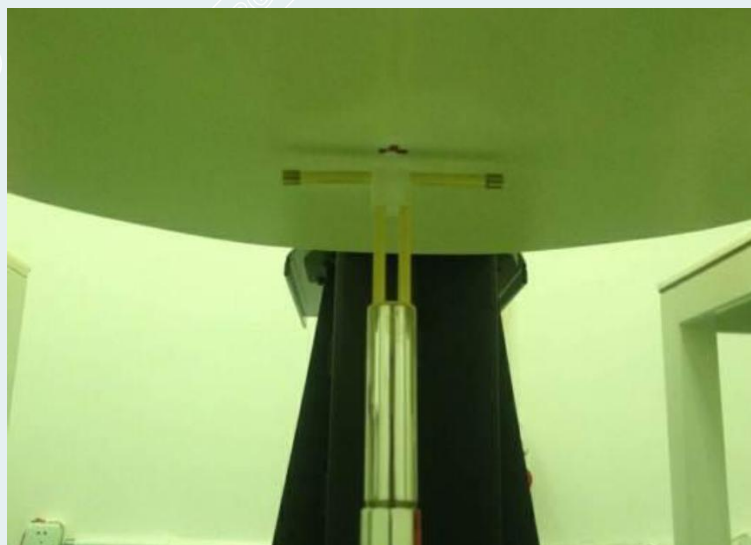

Photo of Dipole Setup

➤ **Validation Results**

Comparing to the original SAR value provided by SPEAG, the verification data should be within its specification of 10%. The table below shows the target SAR and measured SAR after normalized to 1W input power. It indicates that the system performance check can meet the variation criterion and the plots can be referred to Appendix A of this report.

Dipole	Tissue Type	Target Value(W/Kg) ($\pm 10\%$) (Normalized to 1W)		Measured Value (W/Kg) (100mW)		Measured Value (W/Kg)(1W)		Tissue temperature ($^{\circ}\text{C}$)	Measured Date
		1g	10g	1g	10g	1g	10g		
D245 0V2	2450 HSL	52.20 (46.98~57.42)	23.60 (21.24~25.96)	5.07	2.39	50.7	23.9	21.7	2022-10-22

Target and Measurement SAR after Normalized

----- The following blanks -----

8. SAR MEASUREMENT VARIABILITY

Per KDB865664 D01 SAR measurement 100 MHz to 6 GHz, SAR measurement variability must be assessed for each frequency band, which is determined by the SAR probe calibration point and tissue-equivalent medium used for the device measurements. The additional measurements are repeated after the completion of all measurements requiring the same head or body tissue-equivalent medium in a frequency band. The test device should be returned to ambient conditions (normal room temperature) with the battery fully charged before it is re-mounted on the device holder for the repeated measurement(s) to minimize any unexpected variations in the repeated results.

- 1) Repeated measurement is not required when the original highest measured SAR is < 0.80 W/kg; steps 2) through 4) do not apply.
- 2) When the original highest measured SAR is ≥ 0.80 W/kg, repeat that measurement once.
- 3) Perform a second repeated measurement only if the ratio of largest to smallest SAR for the original and first repeated measurements is > 1.20 or when the original or repeated measurement is ≥ 1.45 W/kg (~ 10% from the 1-g SAR limit).
- 4) Perform a third repeated measurement only if the original, first or second repeated measurement is ≥ 1.5 W/kg and the ratio of largest to smallest SAR for the original, first and second repeated measurements is > 1.20 .

The same procedures should be adapted for measurements according to extremity and occupational exposure limits by applying a factor of 2.5 for extremity exposure and a factor of 5 for occupational exposure to the corresponding SAR thresholds.

The detailed repeated measurement results are shown in Chapter 12.

9. EUT TESTING POSITION

9.1 BODY WORN POSITION

Body-worn operating configurations are tested with the belt-clips and holsters attached to the device and positioned against a flat phantom in a normal use configuration. Per KDB 648474 D04, body-worn accessory exposure is typically related to voice mode operations when handsets are carried in body-worn accessories. The body-worn accessory procedures in FCC KDB 447498 D01 should be used to test for body-worn accessory SAR compliance, without a headset connected to it. This enables the test results for such configuration to be compatible with that required for hotspot mode when the body-worn accessory test separation distance is greater than or equal to that required for hotspot mode, when applicable. When the reported SAR for body-worn accessory, measured without a headset connected to the handset is < 1.2 W/kg, the highest reported SAR configuration for that wireless mode and frequency band should be repeated for that body-worn accessory with a headset attached to the handset.

Accessories for body-worn operation configurations are divided into two categories: those that do not contain metallic components and those that do contain metallic components. When multiple accessories that do not contain metallic components are supplied with the device, the device is tested with only the accessory that dictates the closest spacing to the body. Then multiple accessories that contain metallic components are test with the device with each accessory. If multiple accessories share an identical metallic component (i.e. the same metallic belt-chip used with different holsters with no other metallic components) only the accessory that dictates the closest spacing to the body is tested.

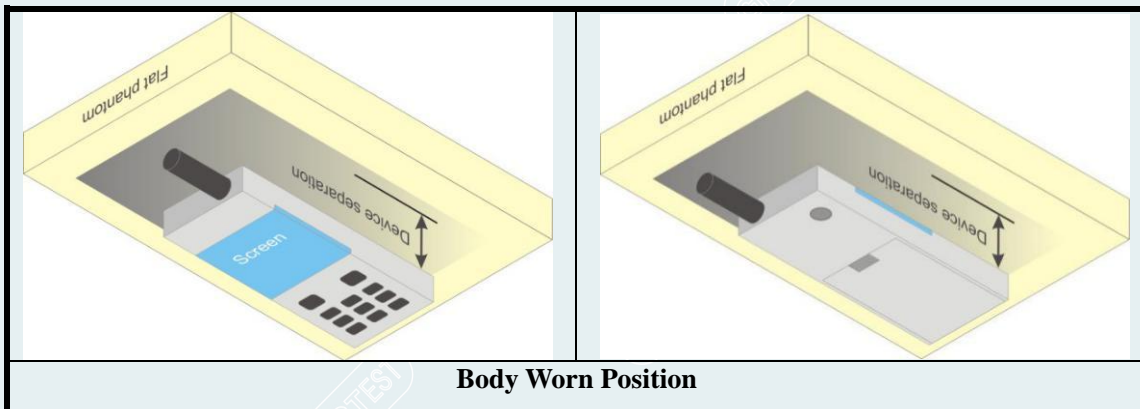

----- The following blanks -----

10. MEASUREMENT PROCEDURES

The measurement procedures are as follows:

- (a) Use base station simulator (if applicable) or engineering software to transmit RF power continuously (continuous Tx) in the middle channel.
- (b) Keep EUT to radiate maximum output power or 100% duty factor (if applicable)
- (c) Measure output power through RF cable and power meter.
- (d) Place the EUT in the positions as setup photos demonstrates.
- (e) Set scan area, grid size and other setting on the DASY software.
- (f) Measure SAR transmitting at the middle channel for all applicable exposure positions.
- (g) Identify the exposure position and device configuration resulting the highest SAR
- (h) Measure SAR at the lowest and highest channels at the worst exposure position and device configuration if applicable.

According to the test standard, the recommended procedure for assessing the peak spatial-average SAR value consists of the following steps:

- (a) Power reference measurement
- (b) Area scan
- (c) Zoom scan
- (d) Power drift measurement

10.1 SPATIAL PEAK SAR EVALUATION

The procedure for spatial peak SAR evaluation has been implemented according to the test standard. It can be conducted for 1g and 10g, as well as for user-specific masses. The DASY software includes all numerical procedures necessary to evaluate the spatial peak SAR value.

The base for the evaluation is a "cube" measurement. The measured volume must include the 1g and 10g cubes with the highest averaged SAR values. For that purpose, the center of the measured volume is aligned to the interpolated peak SAR value of a previously performed area scan.

The entire evaluation of the spatial peak values is performed within the post-processing engine (SEMCAD). The system always gives the maximum values for the 1g and 10g cubes. The algorithm to find the cube with highest averaged SAR is divided into the following stages:

- (a) Extraction of the measured data (grid and values) from the Zoom Scan
- (b) Calculation of the SAR value at every measurement point based on all stored data (A/D values and measurement parameters)
- (c) Generation of a high-resolution mesh within the measured volume
- (d) Interpolation of all measured values from the measurement grid to the high-resolution grid
- (e) Extrapolation of the entire 3-D field distribution to the phantom surface over the distance from sensor to surface
- (f) Calculation of the averaged SAR within masses of 1g and 10g

10.2 POWER REFERENCE MEASUREMENT

The Power Reference Measurement and Power Drift Measurements are for monitoring the power drift of the device under test in the batch process. The minimum distance of probe sensors to surface determines the closest measurement point to phantom surface. This distance cannot be smaller than the distance of sensor calibration points to probe tip as defined in the probe properties.

10.3 AREA SCAN PROCEDURES

The area scan is used as a fast scan in two dimensions to find the area of high field values, before doing a fine measurement around the hot spot. The sophisticated interpolation routines implemented in DASYS software can find the maximum found in the scanned area, within a range of the global maximum. The range (in dB) is specified in the standards for compliance testing. For example, a 2 dB range is required in IEEE standard 1528 and IEC 62209 standards, whereby 3 dB is a requirement when compliance is assessed in accordance with the ARIB standard (Japan), if only one zoom scan follows the area scan, then only the absolute maximum will be taken as reference. For cases where multiple maximums are detected, the number of zoom scans has to be increased accordingly.

Area scan parameters extracted from FCC KDB 865664 D01 SAR measurement 100 MHz to 6 GHz.

	≤ 3 GHz	> 3 GHz
Maximum distance from closest measurement point (geometric center of probe sensors) to phantom surface	5 ± 1 mm	$\frac{1}{2} \cdot \delta \cdot \ln(2) \pm 0.5$ mm
Maximum probe angle from probe axis to phantom surface normal at the measurement location	30° ± 1°	20° ± 1°
Maximum area scan spatial resolution: Δx_{Area} , Δy_{Area}	≤ 2 GHz: ≤ 15 mm 2 – 3 GHz: ≤ 12 mm	3 – 4 GHz: ≤ 12 mm 4 – 6 GHz: ≤ 10 mm
	When the x or y dimension of the test device, in the measurement plane orientation, is smaller than the above, the measurement resolution must be ≤ the corresponding x or y dimension of the test device with at least one measurement point on the test device.	

----- The following blanks -----

10.4 ZOOM SCAN PROCEDURES

Zoom scans are used to assess the peak spatial SAR values within a cubic averaging volume containing 1 gram and 10 grams of simulated tissue. The zoom scan measures points (refer to table below) within a cube whose base faces are centered on the maxima found in a preceding area scan job within the same procedure. When the measurement is done, the zoom scan evaluates the averaged SAR for 1 gram and 10 grams and displays these values next to the job's label.

Zoom scan parameters extracted from FCC KDB 865664 D01 SAR measurement 100 MHz to 6 GHz.

			≤ 3 GHz	> 3 GHz
Maximum zoom scan spatial resolution: Δx_{Zoom} , Δy_{Zoom}			≤ 2 GHz: ≤ 8 mm 2 – 3 GHz: ≤ 5 mm*	3 – 4 GHz: ≤ 5 mm* 4 – 6 GHz: ≤ 4 mm*
Maximum zoom scan spatial resolution, normal to phantom surface	uniform grid: $\Delta z_{Zoom}(n)$		≤ 5 mm	3 – 4 GHz: ≤ 4 mm 4 – 5 GHz: ≤ 3 mm 5 – 6 GHz: ≤ 2 mm
	graded grid	$\Delta z_{Zoom}(1)$: between 1 st two points closest to phantom surface	≤ 4 mm	3 – 4 GHz: ≤ 3 mm 4 – 5 GHz: ≤ 2.5 mm 5 – 6 GHz: ≤ 2 mm
		$\Delta z_{Zoom}(n>1)$: between subsequent points	≤ 1.5 · $\Delta z_{Zoom}(n-1)$	
Minimum zoom scan volume	x, y, z	≥ 30 mm	3 – 4 GHz: ≥ 28 mm 4 – 5 GHz: ≥ 25 mm 5 – 6 GHz: ≥ 22 mm	
Note: δ is the penetration depth of a plane-wave at normal incidence to the tissue medium; see draft standard IEEE P1528-2011 for details. * When zoom scan is required and the <i>reported</i> SAR from the <i>area scan based 1-g SAR estimation</i> procedures of KDB 447498 is ≤ 1.4 W/kg, ≤ 8 mm, ≤ 7 mm and ≤ 5 mm zoom scan resolution may be applied, respectively, for 2 GHz to 3 GHz, 3 GHz to 4 GHz and 4 GHz to 6 GHz.				

10.5 VOLUME SCAN PROCEDURES

The volume scan is used for assess overlapping SAR distributions for antennas transmitting in different frequency bands. It is equivalent to an oversized zoom scan used in standalone measurements. The measurement volume will be used to enclose all the simultaneous transmitting antennas. For antennas transmitting simultaneously in different frequency bands, the volume scan is measured separately in each frequency band. In order to sum correctly to compute the 1g aggregate SAR, the EUT remain in the same test position for all measurements and all volume scan use the same spatial resolution and grid spacing. When all volume scan were completed, the software, SEMCAD post-processor can combine and subsequently superpose these measurement data to calculating the multi-band SAR.

10.6 POWER DRIFT MONITORING

All SAR testing is under the EUT install full charged battery and transmit maximum output power. In DASY measurement software, the power reference measurement and power drift measurement procedures are used for monitoring the power drift of EUT during SAR test. Both these procedures measure the field at a specified reference position before and after the SAR testing. The software will calculate the field difference in dB. If the power drift more than $\pm 0.2\text{dB}$, the SAR will be retested.

----- The following blanks -----

11. CONDUCTED POWER

<Bluetooth Conducted Average Power>

Left Ear

Mode	Channel	Frequency (MHz)	Conducted Average Power (dBm)	Tune-up Limit (dBm)
GFSK	00	2402	11.07	12.50
	39	2441	11.18	
	78	2480	11.12	
$\pi/4$ DQPSK	00	2402	7.74	9.50
	39	2441	7.95	
	78	2480	7.88	
8DPSK	00	2402	7.75	9.50
	39	2441	7.96	
	78	2480	7.87	
BT-LE 1M	00	2402	6.48	8.00
	19	2440	6.64	
	39	2480	6.62	
BT-LE 2M	00	2402	4.97	6.80
	19	2440	5.32	
	39	2480	5.27	

Right Ear

Mode	Channel	Frequency (MHz)	Conducted Average Power (dBm)	Tune-up Limit (dBm)
GFSK	00	2402	11.57	12.50
	39	2441	11.65	
	78	2480	11.43	
$\pi/4$ DQPSK	00	2402	8.09	9.50
	39	2441	8.26	
	78	2480	8.08	
8DPSK	00	2402	8.15	9.50
	39	2441	8.26	
	78	2480	8.08	
BT-LE 1M	00	2402	6.76	8.00
	19	2440	6.89	
	39	2480	6.77	
BT-LE 2M	00	2402	5.28	6.80
	19	2440	5.53	
	39	2480	5.41	

Note:

- Per KDB 447498 D01Chapter 4.3.1, the 1-g and 10-g SAR test exclusion thresholds for 100 MHz to 6 GHz at test separation distances ≤ 50 mm are determined by:

$$\frac{[(\text{max. power of channel, including tune-up tolerance, mW}) / (\text{min. test separation distance, mm})] \cdot \sqrt{f(\text{GHz})}}{\leq 3.0 \text{ for 1-g SAR and } \leq 7.5 \text{ for 10-g extremity SAR}}$$

$$f(\text{GHz}) \text{ is the RF channel transmit frequency in GHz}$$
 Power and distance are rounded to the nearest mW and mm before calculation
 The result is rounded to one decimal place for comparison

Left Ear

Mode	Tune-up Limit (dBm)	Separation Distance (mm)	Frequency (GHz)	Result	exclusion thresholds
BT(BR+EDR)	13.00	0	2.480	6.30	3
BT(LE 1M)	8.00	0	2.480	1.99	3

Right Ear

Mode	Tune-up Limit (dBm)	Separation Distance (mm)	Frequency (GHz)	Result	exclusion thresholds
BT(BR+EDR)	13.00	0	2.480	6.30	3
BT(LE 1M)	8.00	0	2.480	1.99	3

- Per KDB 447498 D01Chapter 4.3.1, when the minimum test separation distance is < 5 mm, a distance of 5 mm is applied to determine SAR test exclusion. The test exclusion threshold BT(BR+EDR) which is > 3 , so SAR test is required.
- Per KDB 447498 D01Chapter 4.3.2b), When an antenna qualifies for the standalone SAR test exclusion of 4.3.1 and also transmits simultaneously with other antennas, the standalone SAR value must be estimated according to the following to determine the simultaneous transmission SAR test exclusion criteria:

$$\frac{[(\text{max. power of channel, including tune-up tolerance, mW}) / (\text{min. test separation distance, mm})] \cdot \sqrt{f(\text{GHz})/x}}{\text{W/kg, for test separation distances } \leq 50 \text{ mm;}}$$
 where $x = 7.5$ for 1-g SAR and $x = 18.75$ for 10-g SAR.
 0.4 W/kg for 1-g SAR and 1.0 W/kg for 10-g SAR, when the test separation distance is > 50 mm.

----- The following blanks -----

12. SAR TEST RESULTS SUMMARY

General Note:

- Per KDB 447498 D01v05r01, the reported SAR is the measured SAR value adjusted for maximum tune-up tolerance.

Scaling Factor = tune-up limit power (mW) / EUT RF power (mW), where tune-up limit is the maximum rated power among all production units.

Reported SAR(W/kg)= Measured SAR(W/kg) Scaling Factor*

- Per KDB 447498 D01v05r01, for each exposure position, if the highest output channel reported SAR \leq 0.8W/kg, other channels SAR testing are not necessary
- Per KDB865664 D01, for each frequency band, repeated SAR measurement is required only when the measured SAR is \geq 0.8W/Kg; if the deviation among the repeated measurement is \leq 20%,and the measured SAR <1.45W/Kg, only one repeated measurement is required.

Left Earphone

Band	Mode	Test Position	Gap (mm)	Freq. (MHz)	Average Power (dBm)	Tune-Up Limit (dBm)	Scaling Factor	Power Drift (dB)	Measured SAR _{1g} (W/kg)	Reported SAR _{1g} (W/kg)	Plot No.
Bluetooth	DH5	Rear Side	0	2441	11.18	12.50	1.36	-0.11	0.204	0.276	
Bluetooth	DH5	Front Side	0	2441	11.18	12.50	1.36	-0.64	0.017	0.023	
Bluetooth	DH5	Top Side	0	2441	11.18	12.50	1.36	-0.43	0.042	0.057	
Bluetooth	DH5	Bottom Side	0	2441	11.18	12.50	1.36	-0.17	0.023	0.031	
Bluetooth	DH5	Left Side	0	2441	11.18	12.50	1.36	-0.05	0.248	0.336	
Bluetooth	DH5	Right Side	0	2441	11.18	12.50	1.36	-0.08	0.375	0.508	

Right Earphone

Band	Mode	Test Position	Gap (mm)	Freq. (MHz)	Average Power (dBm)	Tune-Up Limit (dBm)	Scaling Factor	Power Drift (dB)	Measured SAR _{1g} (W/kg)	Reported SAR _{1g} (W/kg)	Plot No.
Bluetooth	DH5	Rear Side	0	2441	11.65	12.50	1.22	-0.09	0.246	0.299	#2
Bluetooth	DH5	Front Side	0	2441	11.65	12.50	1.22	-0.04	0.085	0.103	
Bluetooth	DH5	Top Side	0	2441	11.65	12.50	1.22	-0.29	0.062	0.075	
Bluetooth	DH5	Bottom Side	0	2441	11.65	12.50	1.22	-0.28	0.025	0.030	
Bluetooth	DH5	Left Side	0	2441	11.65	12.50	1.22	-0.03	0.424	0.516	
Bluetooth	DH5	Right Side	0	2441	11.65	12.50	1.22	-0.07	0.309	0.376	

13. SIMULTANEOUS TRANSMISSION ANALYSIS

N/A.

----- **The following blanks** -----

APPENDIX A. SYSTEM CHECKING SCANS**2022-10-22****2450MHz Head System Check**

Communication System: UID 0, CW (0); Frequency: 2450 MHz

Medium parameters used (interpolated): $f = 2450$ MHz; $\sigma = 1.866$ S/m; $\epsilon_r = 39.361$; $\rho = 1000$ kg/m³

Phantom section: Flat Section

DASY Configuration:

- Probe: ES3DV3 - SN3308; ConvF(4.78, 4.78, 4.78); Calibrated: 2022/3/9;
- Sensor-Surface: 3mm (Mechanical Surface Detection), $z = 2.0, 32.0$
- Electronics: DAE4 Sn796; Calibrated: 2022/3/9
- Phantom: Left Twin-SAM V5.0 (20deg probe tilt); Type: QD 000 P40 CD;
- DASY52 52.10.0(1442); SEMCAD X 14.6.10(7413)

Configuration/Body 100mW 3/Area Scan (7x13x1): Measurement grid: $dx=10$ mm, $dy=10$ mm

Maximum value of SAR (measured) = 6.67 W/kg

Configuration/Body 100mW 3/Zoom Scan (7x7x7)/Cube 0: Measurement grid: $dx=5$ mm, $dy=5$ mm, $dz=5$ mm

Reference Value = 63.83 V/m; Power Drift = 0.04 dB

Peak SAR (extrapolated) = 10.2 W/kg

SAR(1 g) = 5.07 W/kg; SAR(10 g) = 2.39 W/kg

Maximum value of SAR (measured) = 6.68 W/kg

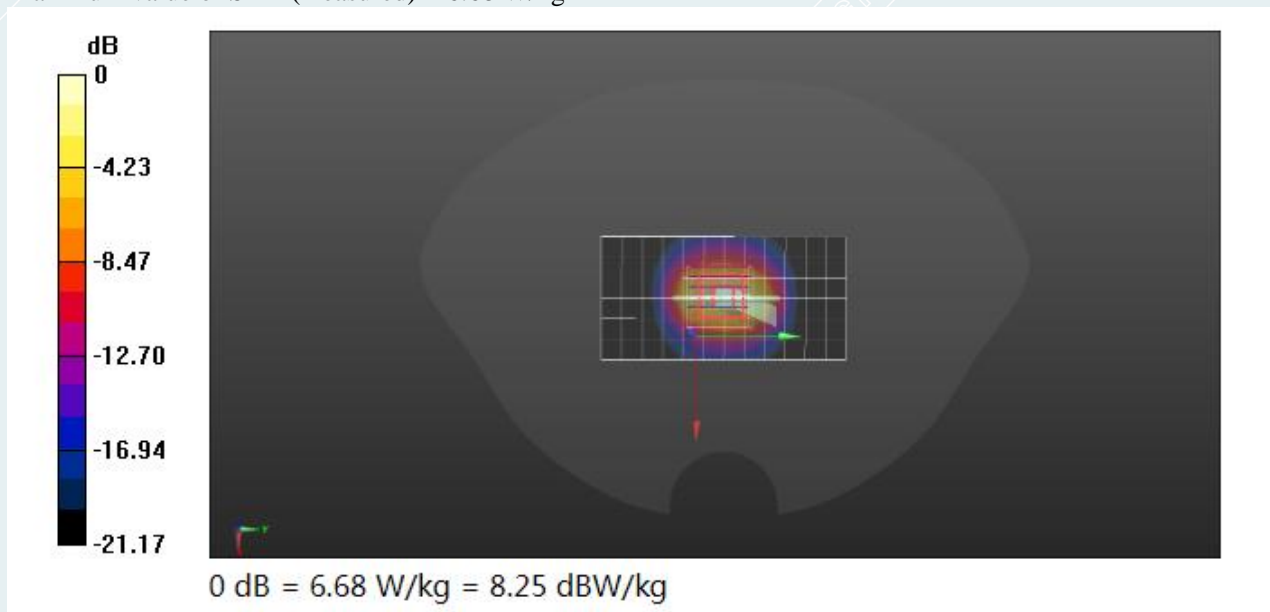

APPENDIX B. MEASUREMENT SCANS**2022-10-22****Left Ear Bluetooth DH5_Right Face_Ch39 #1**

Communication System: UID 0, Bluetooth(GFSK,DH5) (0); Frequency: 2441 MHz
 Medium parameters used (interpolated): $f = 2441$ MHz; $\sigma = 1.828$ S/m; $\epsilon_r = 39.362$; $\rho = 1000$ kg/m³
 Phantom section: Flat Section

DASY Configuration:

- Probe: ES3DV3 - SN3308; ConvF(4.78, 4.78, 4.78); Calibrated: 2022/3/9;
- Sensor-Surface: 3mm (Mechanical Surface Detection), $z = 2.0, 32.0$
- Electronics: DAE4 Sn796; Calibrated: 2022/3/9
- Phantom: Left Twin-SAM V5.0 (20deg probe tilt); Type: QD 000 P40 CD;
- DASY52 52.10.0(1442); SEMCAD X 14.6.10(7413)

Left Ear/Right Face Mid/Area Scan (6x8x1): Measurement grid: $dx=10$ mm, $dy=10$ mm
 Maximum value of SAR (measured) = 0.325 W/kg

Left Ear/Right Face Mid/Zoom Scan (7x7x7)/Cube 0: Measurement grid: $dx=5$ mm, $dy=5$ mm, $dz=5$ mm
 Reference Value = 10.15 V/m; Power Drift = -0.08 dB
 Peak SAR (extrapolated) = 2.60 W/kg
SAR(1 g) = 0.375 W/kg; SAR(10 g) = 0.113 W/kg
 Maximum value of SAR (measured) = 1.26 W/kg

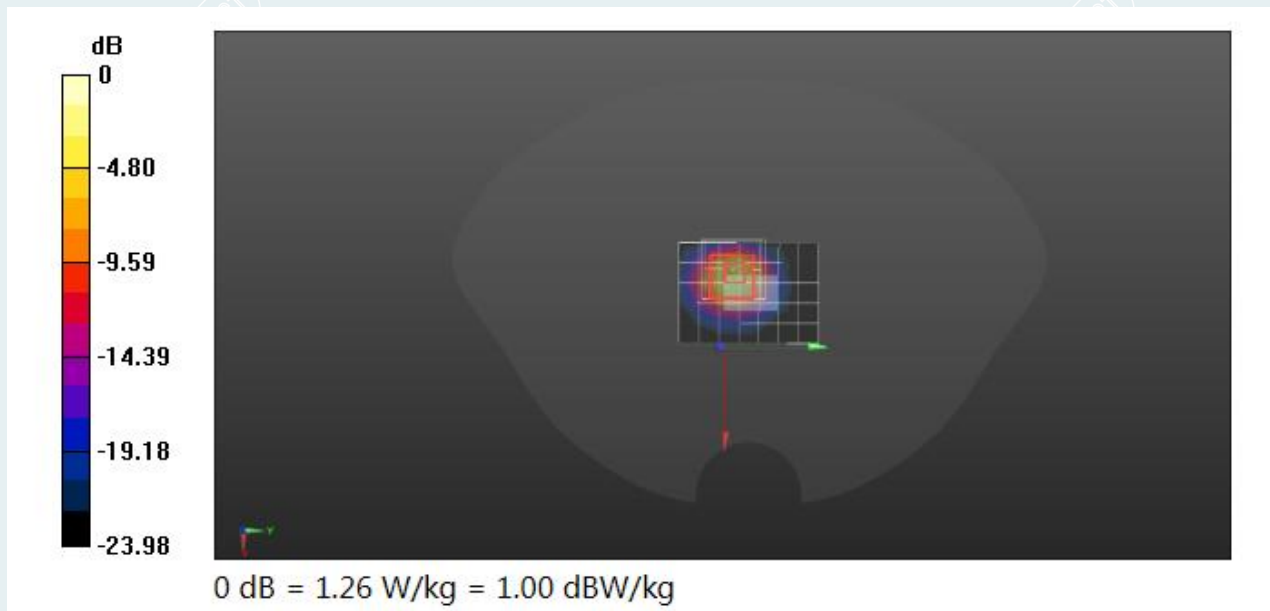

2022-10-22

Right Ear Bluetooth DH5_Left Face_Ch39 #2

Communication System: UID 0, Bluetooth(GFSK,DH5) (0); Frequency: 2441 MHz
Medium parameters used (interpolated): $f = 2441$ MHz; $\sigma = 1.828$ S/m; $\epsilon_r = 39.362$; $\rho = 1000$ kg/m³
Phantom section: Flat Section

DASY Configuration:

- Probe: ES3DV3 - SN3308; ConvF(4.78, 4.78, 4.78); Calibrated: 2022/3/9;
- Sensor-Surface: 3mm (Mechanical Surface Detection), $z = 2.0, 32.0$
- Electronics: DAE4 Sn796; Calibrated: 2022/3/9
- Phantom: Left Twin-SAM V5.0 (20deg probe tilt); Type: QD 000 P40 CD;
- DASY52 52.10.0(1442); SEMCAD X 14.6.10(7413)

Right Ear/Left Face Mid/Area Scan (6x8x1): Measurement grid: $dx=10$ mm, $dy=10$ mm
Maximum value of SAR (measured) = 1.02 W/kg

Right Ear/Left Face Mid/Zoom Scan (7x7x7)/Cube 0: Measurement grid: $dx=5$ mm, $dy=5$ mm, $dz=5$ mm
Reference Value = 12.08 V/m; Power Drift = -0.03 dB
Peak SAR (extrapolated) = 3.11 W/kg
SAR(1 g) = 0.424 W/kg; SAR(10 g) = 0.138 W/kg
Maximum value of SAR (measured) = 1.62 W/kg

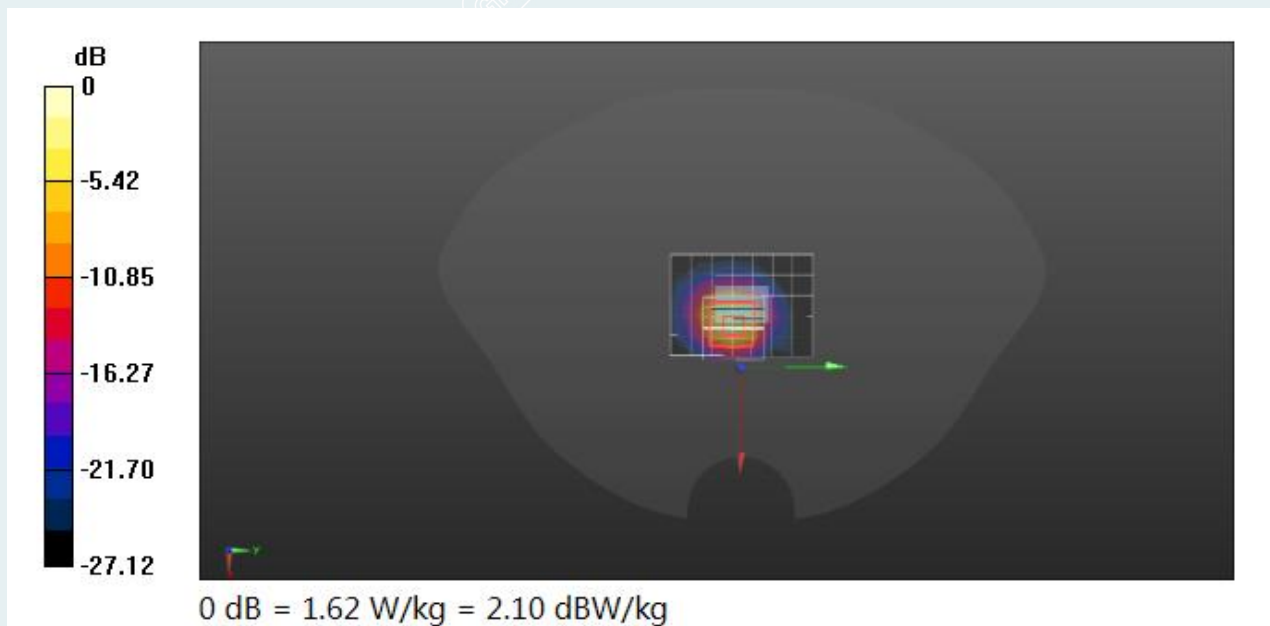

APPENDIX C. RELEVANT PAGES FROM PROBE CALIBRATION REPORT(S)

Please refer to the attached document Calibration reports.

APPENDIX D: PHOTOGRAPH OF SET UP

Please refer to the attached document E20221011998501-9-Test photo.

APPENDIX E: PHOTOGRAPH OF THE EUT

Please refer to the attached document E20221011998501-10-EUT photo.

----- End of Report -----