



### FCC/IC - TEST REPORT

Report Number : **68.912.19.0006.01** Date of Issue: May 05, 2019

Model : E302A

Product Type : OnePlus Bullets Wireless 2

Applicant : OnePlus Technology (Shenzhen) Co., Ltd.

Address : 18C02, 18C03, 18C04 and 18C05, Shum Yip Terra Building,

Binhe Avenue North, Futian District, Shenzhen China

Factory : Goertek Intelligence Technology Co., Ltd.

Address : Building#3, No.3 Industrial West Road, High Tech Industrial

Development Zone of Songshan Lake, Dongguan City,

Guangdong, China

Test Result :  Positive     Negative

Total pages including Appendices : 32

*TÜV SÜD Certification and Testing (China) Co., Ltd. Shenzhen Branch is a subcontractor to TÜV SÜD Product Service GmbH according to the principles outlined in ISO 17025.*

*TÜV SÜD Certification and Testing (China) Co., Ltd. Shenzhen Branch reports apply only to the specific samples tested under stated test conditions. Construction of the actual test samples has been documented. It is the manufacturer's responsibility to assure that additional production units of this model are manufactured with identical electrical and mechanical components. The manufacturer/importer is responsible to the Competent Authorities in Europe for any modifications made to the production units which result in non-compliance to the relevant regulations. TÜV SÜD Certification and Testing (China) Co., Ltd. Shenzhen Branch shall have no liability for any deductions, inferences or generalizations drawn by the client or others from TÜV SÜD Certification and Testing (China) Co., Ltd. Shenzhen Branch issued reports.*

*This report is the confidential property of the client. As a mutual protection to our clients, the public and ourselves, extracts from the test report shall not be reproduced except in full without our written approval.*



# 1 Table of Contents

1	Table of Contents.....	2
2	Details about the Test Laboratory .....	3
3	Description of the Equipment Under Test.....	4
4	Summary of Test Standards .....	5
5	Summary of Test Results .....	6
6	General Remarks.....	7
7	Test Setups .....	8
8	Systems test configuration.....	9
9	Technical Requirement.....	10
9.1	Conducted peak output power.....	10
9.2	Power spectral density .....	13
9.3	6 dB Bandwidth and 99% Occupied Bandwidth.....	16
9.4	Spurious RF conducted emissions.....	21
9.5	Band edge.....	25
9.6	Spurious radiated emissions for transmitter .....	27
10	Test Equipment List.....	31
11	System Measurement Uncertainty .....	32



## 2 Details about the Test Laboratory

### Details about the Test Laboratory

#### Test Site 1

Company name: TÜV SÜD Certification and Testing (China) Co., Ltd. Shenzhen Branch  
Building 12 & 13, Zhiheng Wisdomland Business Park, Nantou Checkpoint  
Road 2, Nanshan District  
Shenzhen 518052  
P.R. China

Telephone: 86 755 8828 6998

Fax: 86 755 828 5299

FCC Registration 514049

No.:

IC Registration 10320A -1

No.:

### 3 Description of the Equipment Under Test

Product:	OnePlus Bullets Wireless 2
Model no.:	E302A
FCC ID:	2ABZ2-E302A
IC:	12739A-E302A
Options and accessories:	USB Cable
Rating:	3.85VDC, 129mAh (Supplied by rechargeable Li-ion battery) 5VDC (Charged by USB port)
RF Transmission Frequency:	2402MHz-2480MHz
No. of Operated Channel:	40
Modulation:	GFSK
Antenna Type:	PIFA FPC Antenna
Antenna Gain:	-2.8dBi
Description of the EUT:	The Equipment Under Test (EUT) is a OnePlus Bullets Wireless 2 operated at 2.4GHz

## 4 Summary of Test Standards

Test Standards	
FCC Part 15 Subpart C 10-1-2017 Edition	PART 15 - RADIO FREQUENCY DEVICES Subpart C - Intentional Radiators
RSS-Gen Issue 5 April 2018	General Requirements and Information for the Certification of Radio Apparatus
RSS-247 Issue 2 February 2017	Digital Transmission Systems (DTSS), Frequency Hopping Systems (FHSS) and License-Exempt Local Area Network (LE-LAN) Devices

All the test methods were according to KDB558074 D01 v04 DTS Measurement Guidance and ANSI C63.10 (2013).

## 5 Summary of Test Results

Technical Requirements							
FCC Part 15 Subpart C/RSS-247 Issue 2/RSS-Gen Issue 5							
Test Condition			Pages	Test Site	Test Result		
					Pass	Fail	N/A
§15.207	RSS-Gen, 8.8	Conducted emission AC power port	--	--	<input type="checkbox"/>	<input type="checkbox"/>	<input checked="" type="checkbox"/>
§15.247 (b) (1)	RSS-247 5.4(d)	Conducted peak output power	10	Site 1	<input checked="" type="checkbox"/>	<input type="checkbox"/>	<input type="checkbox"/>
§15.247(a)(1)	RSS-247 5.1(a) & RSS-Gen 6.7	20dB bandwidth	---	---	<input type="checkbox"/>	<input type="checkbox"/>	<input checked="" type="checkbox"/>
§15.247(a)(1)	RSS-247 5.1(b)	Carrier frequency separation	---	---	<input type="checkbox"/>	<input type="checkbox"/>	<input checked="" type="checkbox"/>
§15.247(a)(1)(iii)	RSS-247 5.1(d)	Number of hopping frequencies	---	---	<input type="checkbox"/>	<input type="checkbox"/>	<input checked="" type="checkbox"/>
§15.247(a)(1)(iii)	RSS-247 5.1(d)	Dwell Time	---	---	<input type="checkbox"/>	<input type="checkbox"/>	<input checked="" type="checkbox"/>
§15.247(a)(2)	RSS-247 5.2(a)	6dB bandwidth and 99% Occupied Bandwidth	13	Site 1	<input checked="" type="checkbox"/>	<input type="checkbox"/>	<input type="checkbox"/>
§15.247(e)	RSS-247 5.2(b)	Power spectral density	16	Site 1	<input checked="" type="checkbox"/>	<input type="checkbox"/>	<input type="checkbox"/>
§15.247(d)	RSS-247 5.5	Spurious RF conducted emissions	21	Site 1	<input checked="" type="checkbox"/>	<input type="checkbox"/>	<input type="checkbox"/>
§15.247(d)	RSS-247 5.5	Band edge	25	Site 1	<input checked="" type="checkbox"/>	<input type="checkbox"/>	<input type="checkbox"/>
§15.247(d) & §15.209	RSS-247 5.5 & RSS-Gen 6.13	Spurious radiated emissions for transmitter	27	Site 1	<input checked="" type="checkbox"/>	<input type="checkbox"/>	<input type="checkbox"/>
§15.203	RSS-Gen 6.8	Antenna requirement	See note 1		<input checked="" type="checkbox"/>	<input type="checkbox"/>	<input type="checkbox"/>

Note 1: N/A=Not Applicable.

Note 2: The EUT uses a PIFA FPC antenna, which gain is -2.8dBi. In accordance to §15.203, it is considered sufficiently to comply with the provisions of this section.



## 6 General Remarks

### Remarks

This submittal(s) (test report) is intended for FCC ID: 2ABZ2-E302A, IC: 12739A-E302A complies with Section 15.207, 15.209, 15.247 of the FCC Part 15, Subpart C, RSS-247 and RSS-Gen rules.

Note: The report is BLE only

### SUMMARY:

All tests according to the regulations cited on page 5 were

n - Performed

o - **Not** Performed

The Equipment under Test

n - **Fulfills** the general approval requirements.

o - **Does not** fulfill the general approval requirements.

Sample Received Date: January 9, 2019

Testing Start Date: January 10, 2019

Testing End Date: March 5, 2019

- TÜV SÜD Certification and Testing (China) Co., Ltd. Shenzhen Branch -

Reviewed by:

Phoebe Hu  
EMC Section Manager

Prepared by:

Mark Chen  
EMC Project Engineer

Tested by:

Carry Cai  
EMC Test Engineer

## 7 Test Setups

Below 1GHz

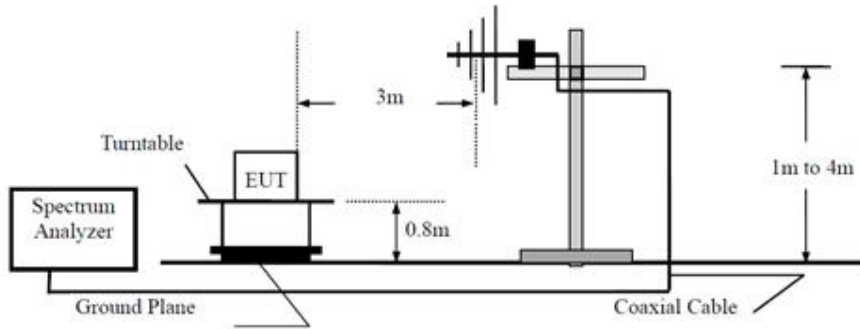

Above 1GHz

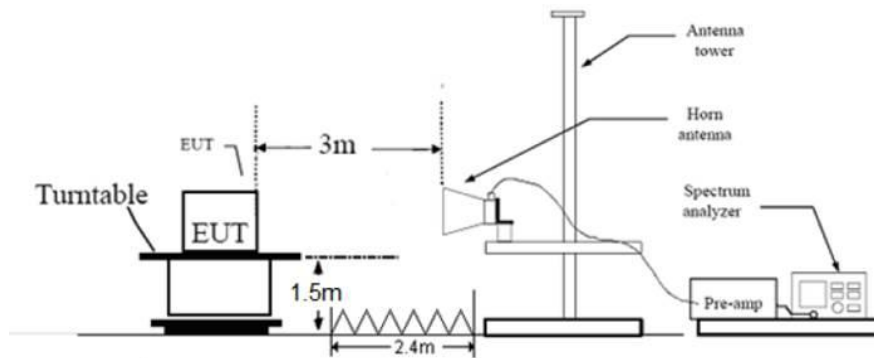

Conducted RF test setups

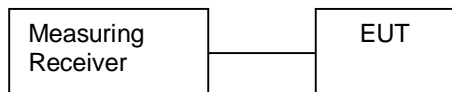



## 8 Systems test configuration

Auxiliary Equipment Used during Test:

DESCRIPTION	MANUFACTURER	MODEL NO.(SHIELD)	S/N(LENGTH)
Notebook	Lenovo	X220	---

Test software: InstallBlueSuiteCda-3-1\_4\_758 Test tool, which used to control the EUT in continues transmitting mode.

The system was configured to channel 0, 19, and 39 for the test.



## 9 Technical Requirement

### 9.1 Conducted peak output power

#### Test Method

1. Use the following spectrum analyzer settings:  
 RBW > the 6dB bandwidth of the emission being measured, VBW≥3RBW, Span≥3RBW  
 Sweep = auto, Detector function = peak, Trace = max hold.
2. Add a correction factor to the display.
3. Allow the trace to stabilize. Use the marker-to-peak function to set the marker to the peak of the emission. The indicated level is the peak output power.

#### Limits

According to §15.247 (b) (1), conducted peak output power limit as below:

Frequency Range MHz	Limit W	Limit dBm
2400-2483.5	≤1	≤30

**For e.i.r.p**

Frequency Range MHz	Limit W	Limit dBm
2400-2483.5	≤4	≤36

Test result as below table

Frequency MHz	Conducted Peak Output Power dBm	E.I.R.P dBm	Result
Low channel 2402MHz	9.27	6.47	Pass
Middle channel 2440MHz	9.07	6.27	Pass
High channel 2480MHz	8.76	5.96	Pass



### Low channel 2402MHz

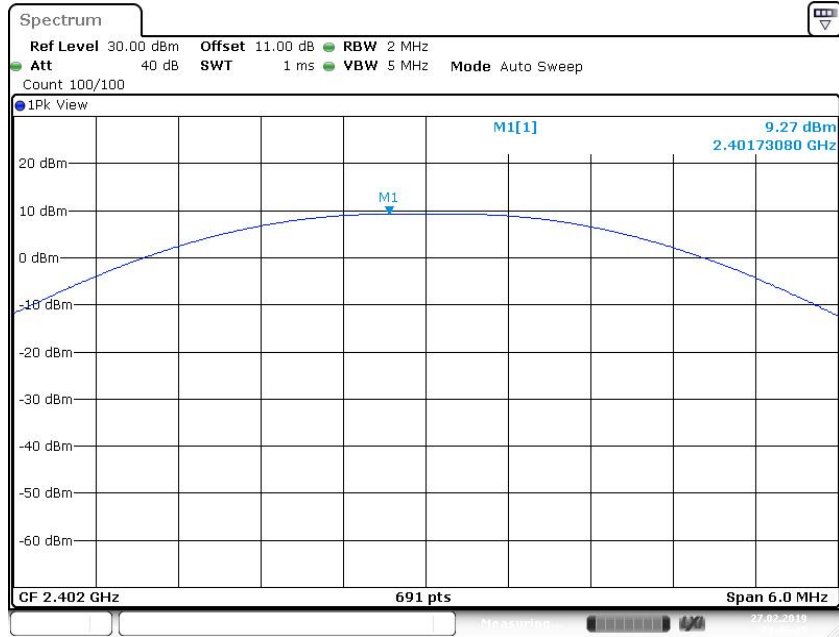

Date: 27 FEB 2019 09:45:26

### Middle channel 2440MHz

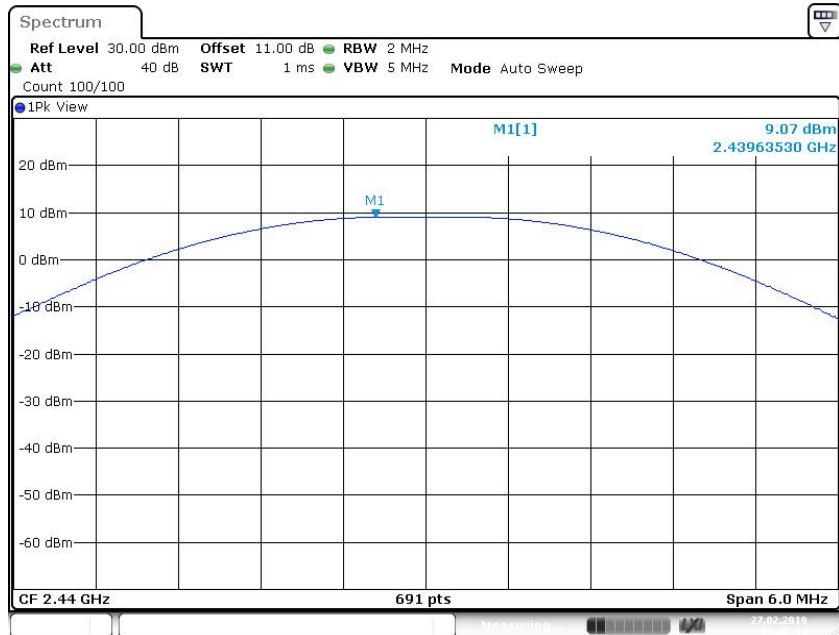

Date: 27 FEB 2019 09:47:15



### High channel 2480MHz

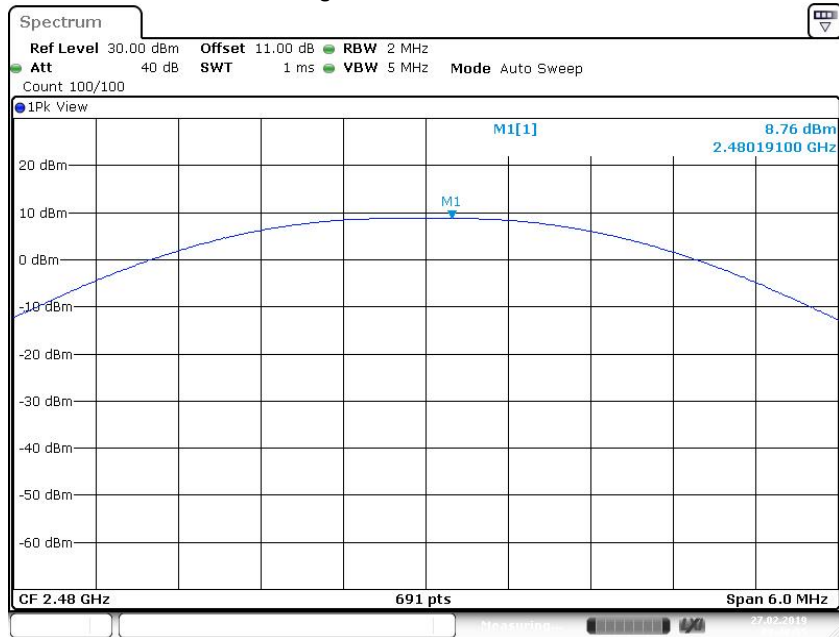



## 9.2 Power spectral density

### Test Method

This procedure shall be used if maximum peak conducted output power was used to demonstrate compliance:

1. Set analyzer center frequency to DTS channel center frequency. RBW=3kHz, VBW≥3RBW, Span=1.5 times DTS bandwidth, Detector=Peak, Sweep=auto, Trace= max hold.
2. Allow trace to fully stabilize, use the peak marker function to determine the maximum amplitude level within the RBW.
3. Repeat above procedures until other frequencies measured were completed.

### Limit

Limit [dBm]

≤8

### Test result

Frequency MHz	Power spectral density dBm	Result
Top channel 2402MHz	-0.55	Pass
Middle channel 2440MHz	-0.78	Pass
Bottom channel 2480MHz	-1.05	Pass



### Low channel 2402MHz

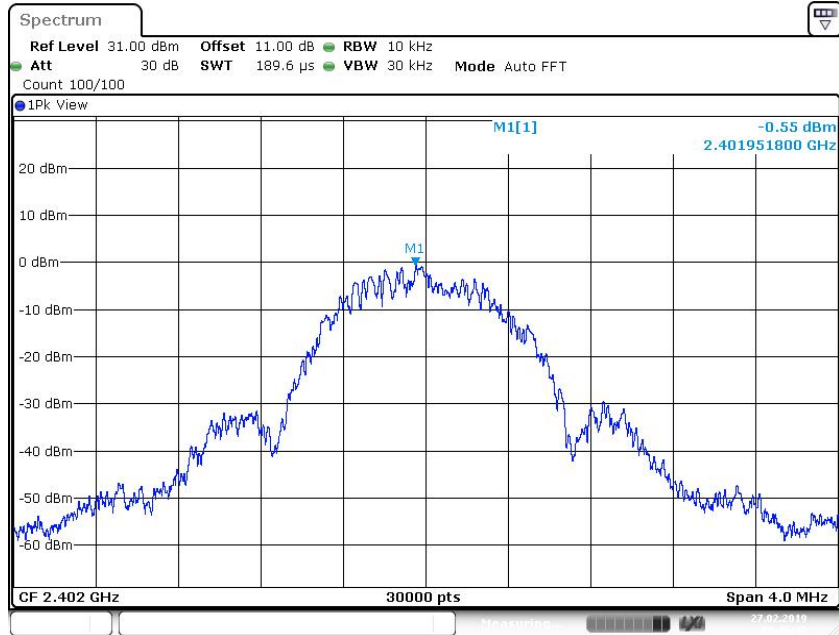

Date: 27 FEB 2019 09:45:32

### Middle channel 2440MHz

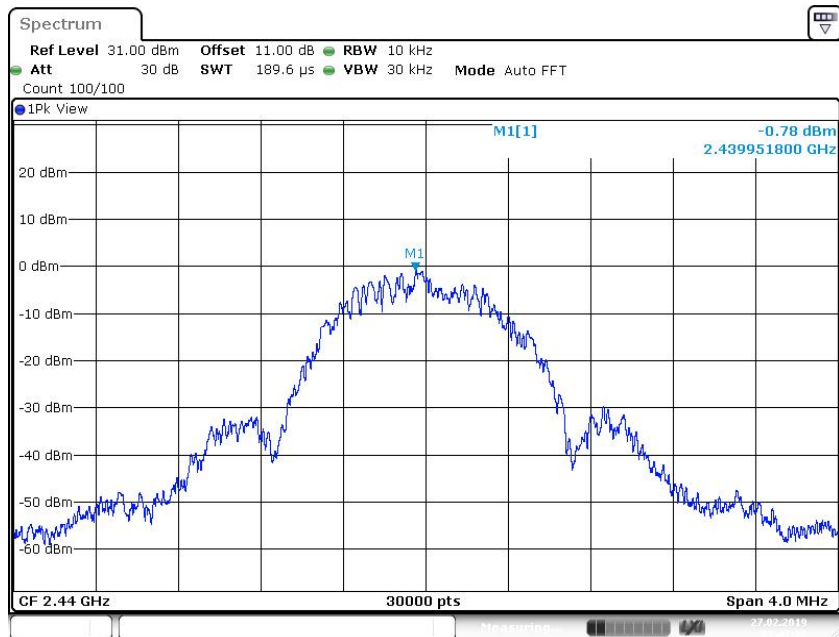

Date: 27 FEB 2019 09:47:21



### High channel 2480MHz

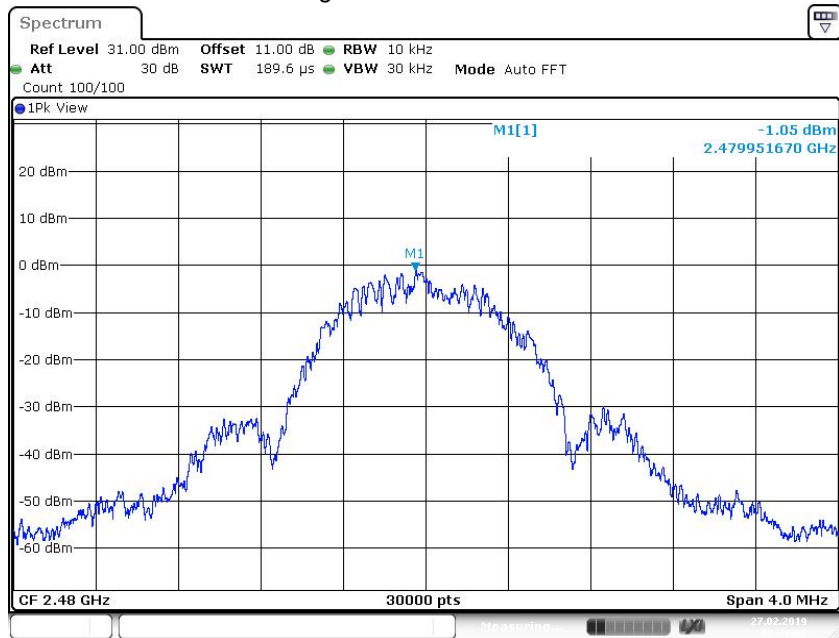

Date: 27 FEB 2019 09:49:01



### 9.3 6 dB Bandwidth and 99% Occupied Bandwidth

#### Test Method

1. Use the following spectrum analyzer settings:  
RBW=100K, VBW≥3RBW, Sweep = auto, Detector function = peak, Trace = max hold
2. Use the automatic bandwidth measurement capability of an instrument, may be employed using the X dB bandwidth mode with X set to 6 dB, care shall be taken so that the bandwidth measurement is not influenced by any intermediate power nulls in the fundamental emission that might be ≥ 6 dB.
3. Allow the trace to stabilize, record the X dB Bandwidth value.

#### Limit

Limit [kHz]

≥500

#### Test result

Frequency MHz	6dB bandwidth kHz	99 bandwidth kHz	Result
Bottom channel 2402MHz	736	1043	Pass
Middle channel 2440MHz	732	1039	Pass
Top channel 2480MHz	728	1043	Pass





**6 dB Bandwidth**

Low channel 2402MHz

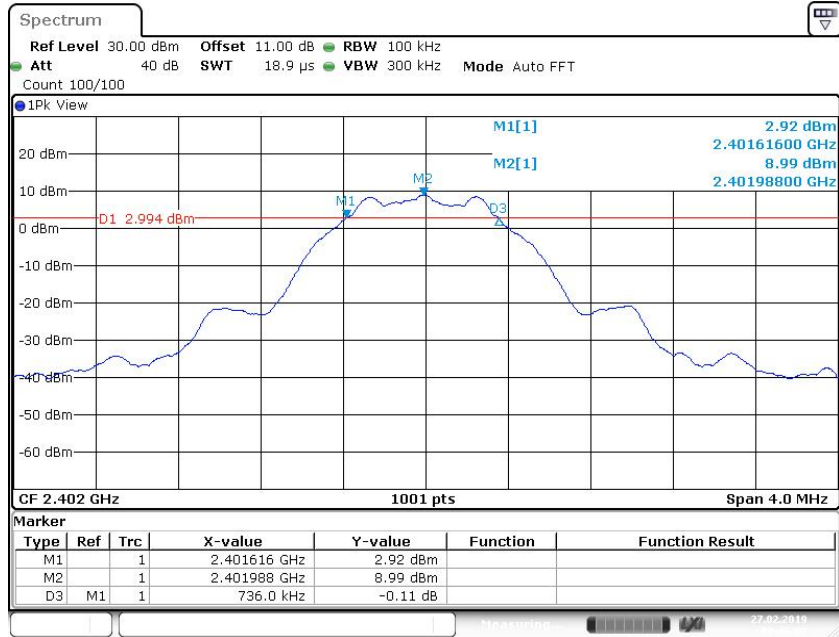

Date: 27 FEB 2019 09:45:07

Middle channel 2440MHz

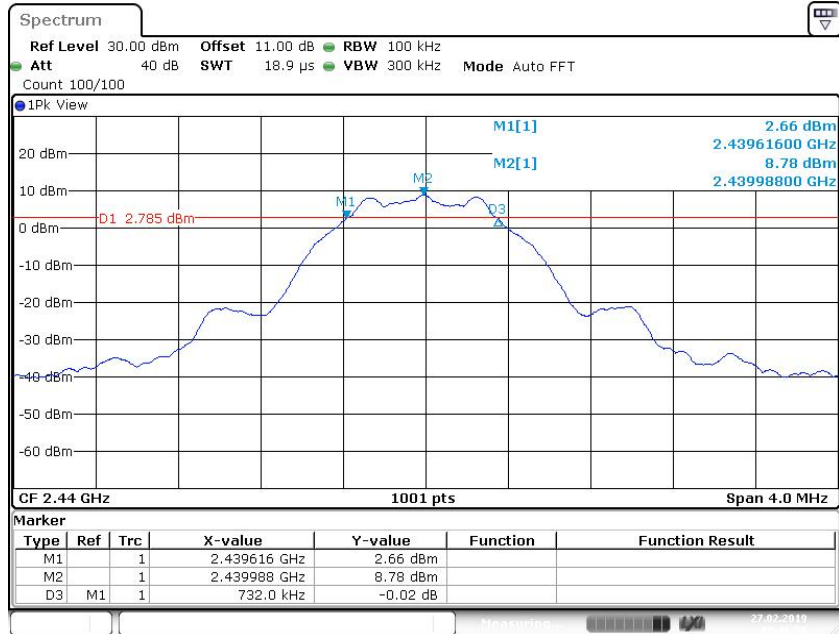

Date: 27 FEB 2019 09:46:56



### High channel 2480MHz

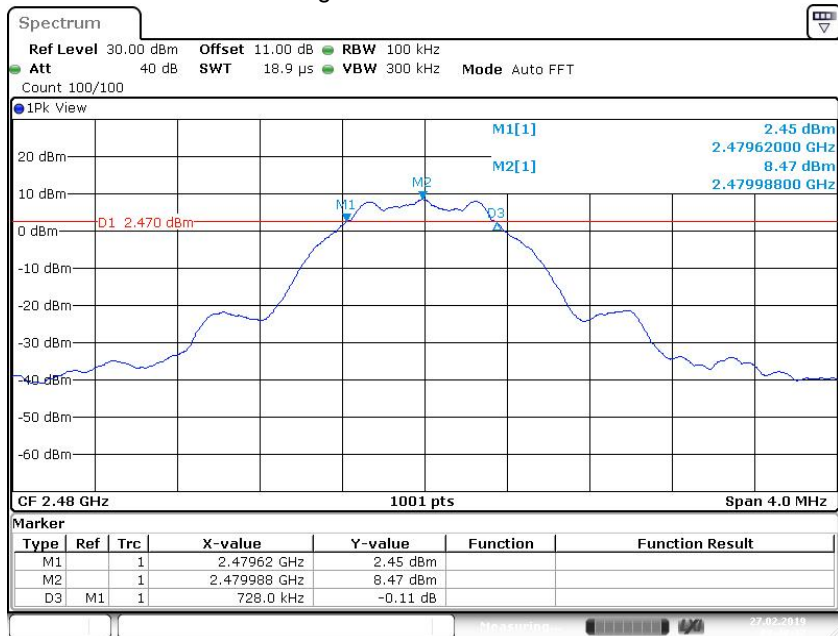

Date: 27 FEB 2019 09:48:37



### 99 Bandwidth

Low channel 2402MHz

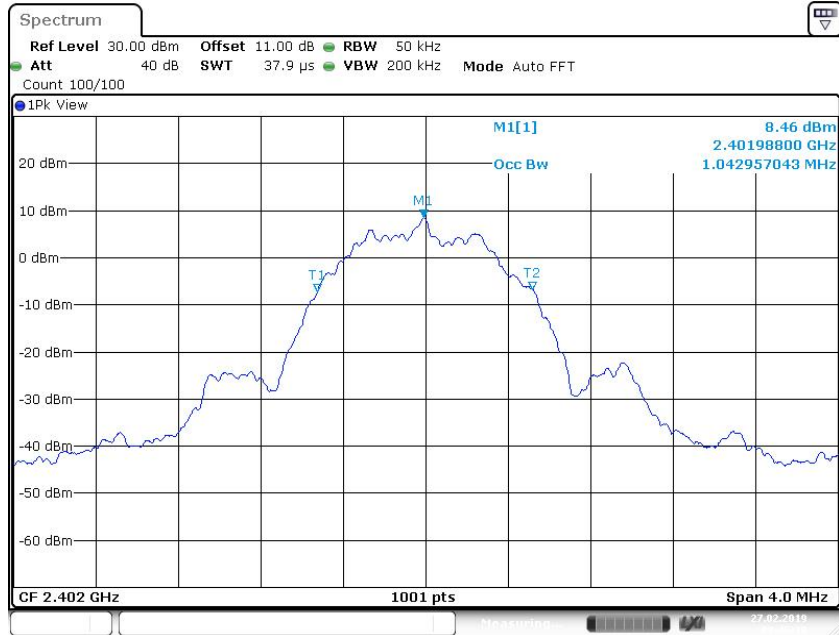

Middle channel 2440MHz

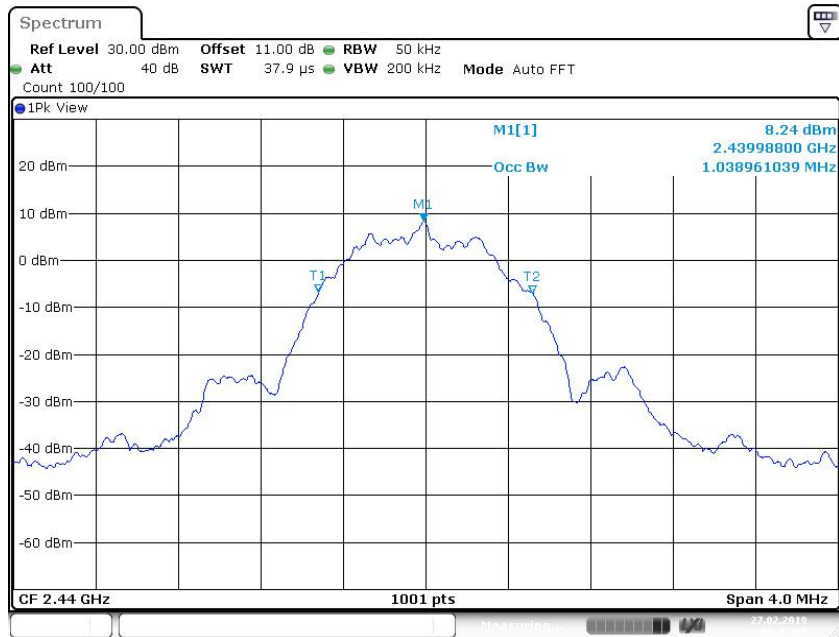



### High channel 2480MHz

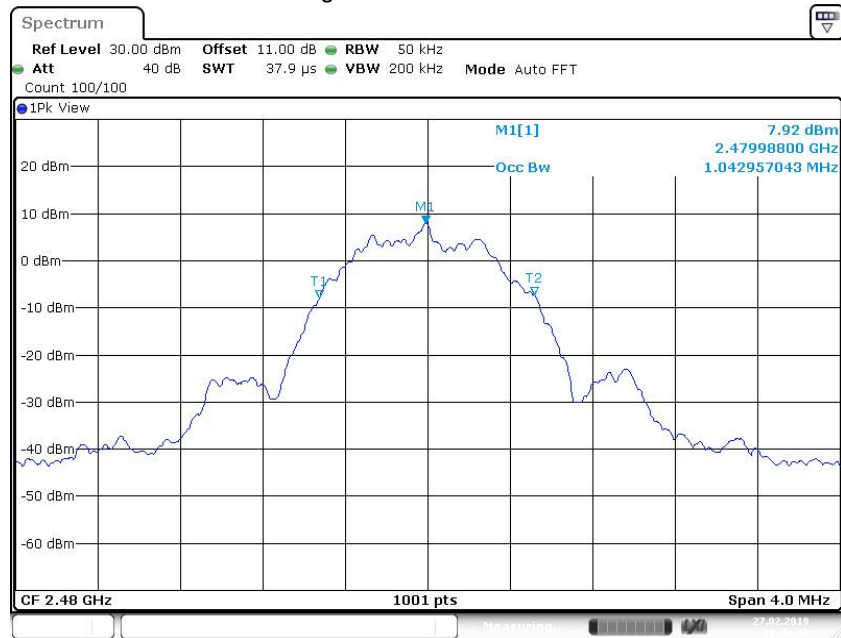



## 9.4 Spurious RF conducted emissions

### Test Method

1. Establish a reference level by using the following procedure:
  - a. Set RBW=100 kHz. VBW $\geq$ 3RBW. Detector =peak, Sweep time = auto couple, Trace mode = max hold.
  - b. Allow trace to fully stabilize, use the peak marker function to determine the maximum PSD level.
2. Use the maximum PSD level to establish the reference level.
  - a. Set the center frequency and span to encompass frequency range to be measured.
  - b. Use the peak marker function to determine the maximum amplitude level. Ensure that the amplitude of all unwanted emissions outside of the authorized frequency band (excluding restricted frequency bands) are attenuated by at least the minimum requirements, report the three highest emissions relative to the limit.
3. Repeat above procedures until other frequencies measured were completed.

### Limit

Frequency Range MHz	Limit (dBc)
30-25000	-20

### Spurious RF conducted emissions

2402MHz

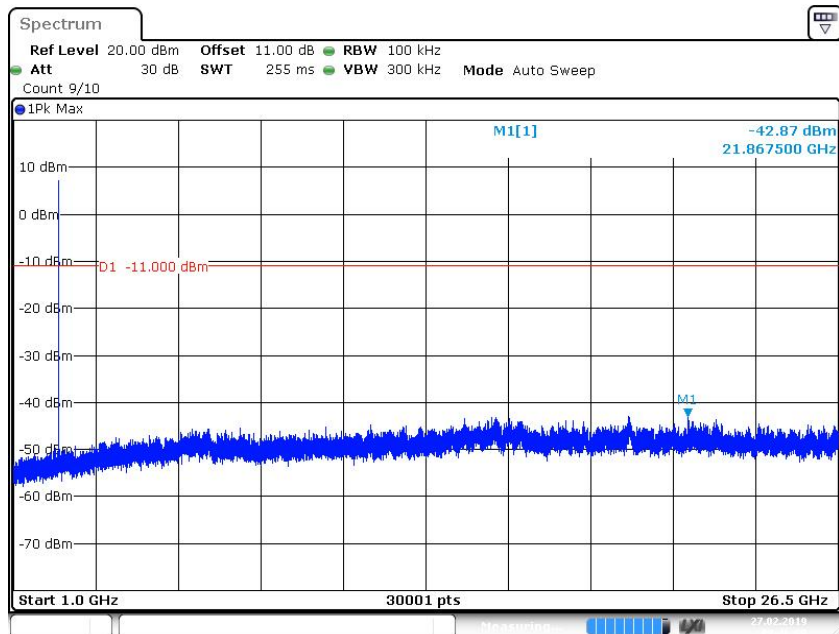
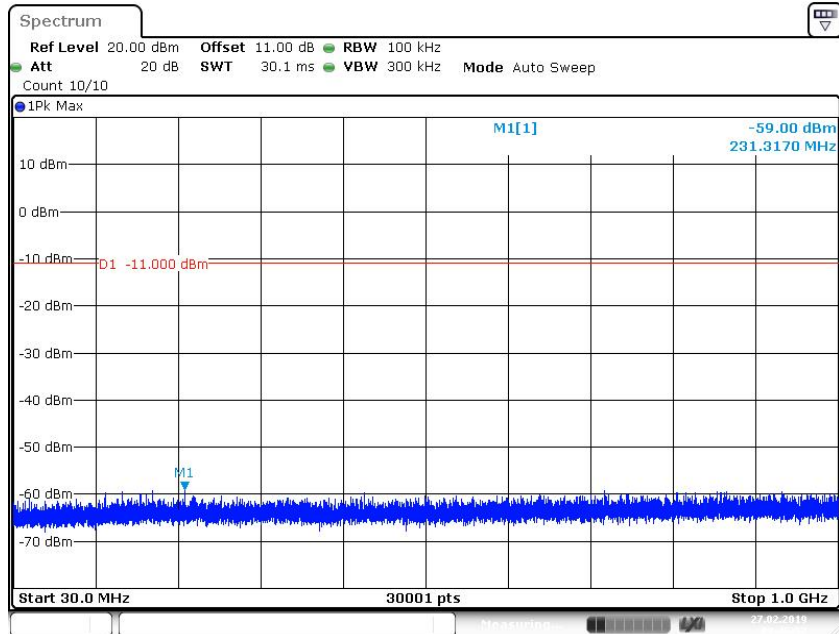



### 2440MHz

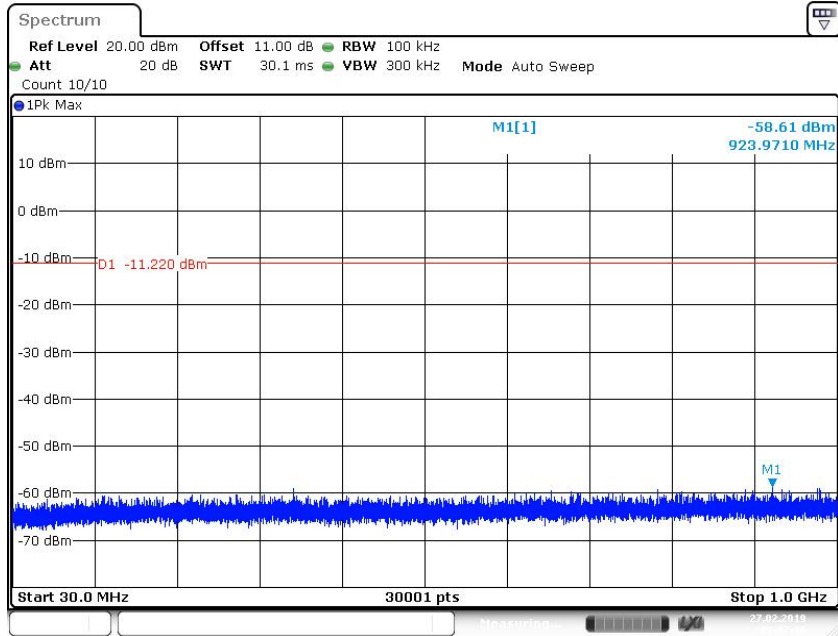

Date: 27.FEB.2019 09:47:36

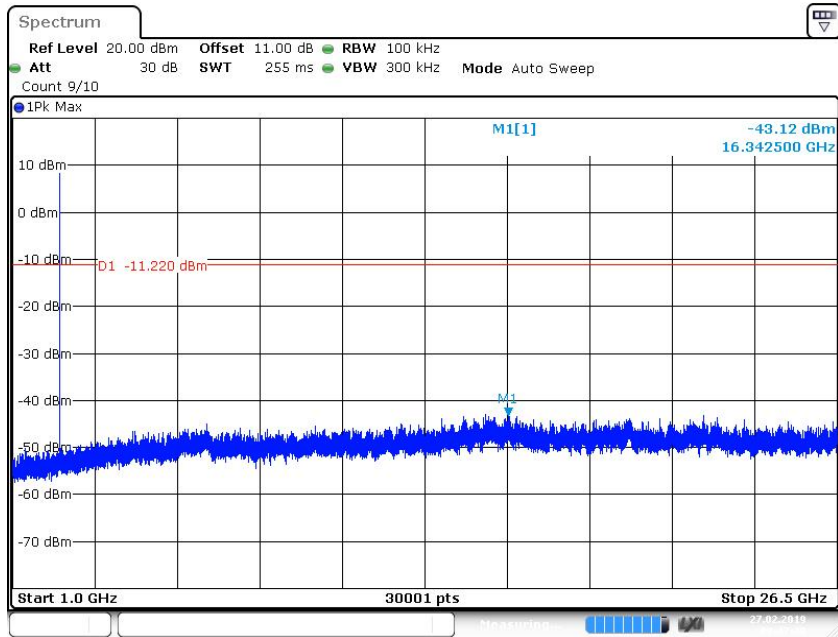

Date: 27.FEB.2019 09:47:48



### 2480MHz

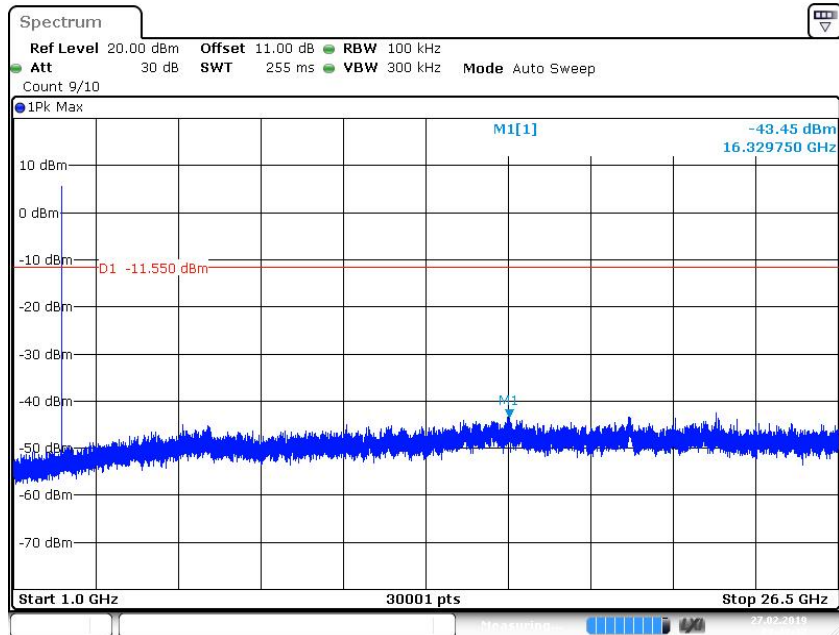
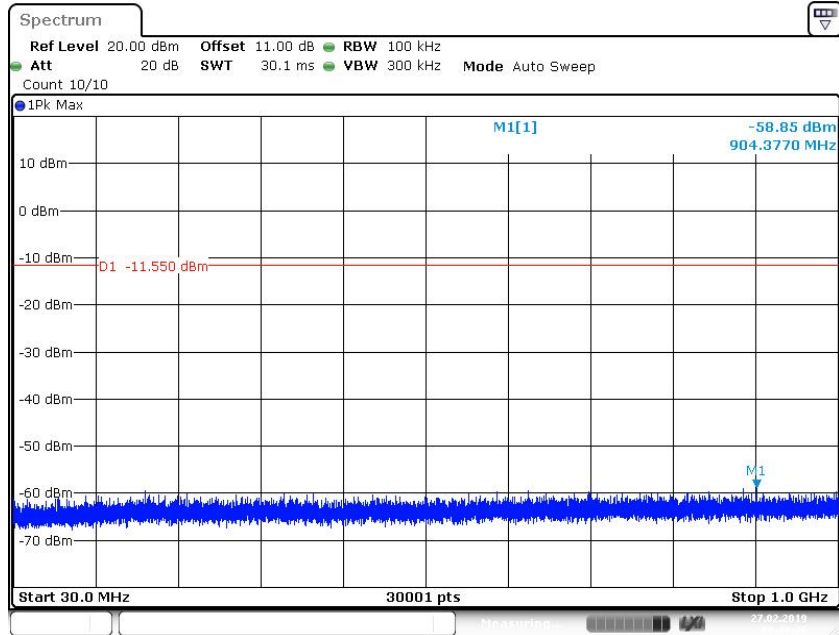



## 9.5 Band edge

### Test Method

- 1 Use the following spectrum analyzer settings:  
Span = wide enough to capture the peak level of the in-band emission and all spurious  
RBW = 100 kHz, VBW  $\geq$  RBW, Sweep = auto, Detector function = peak, Trace = max hold.
- 2 Allow the trace to stabilize, use the peak and delta measurement to record the result.
- 3 The level displayed must comply with the limit specified in this Section.

### Limit

Frequency Range MHz	Limit (dBc)
30-25000	-20

**Band edge testing**

**2402MHz**

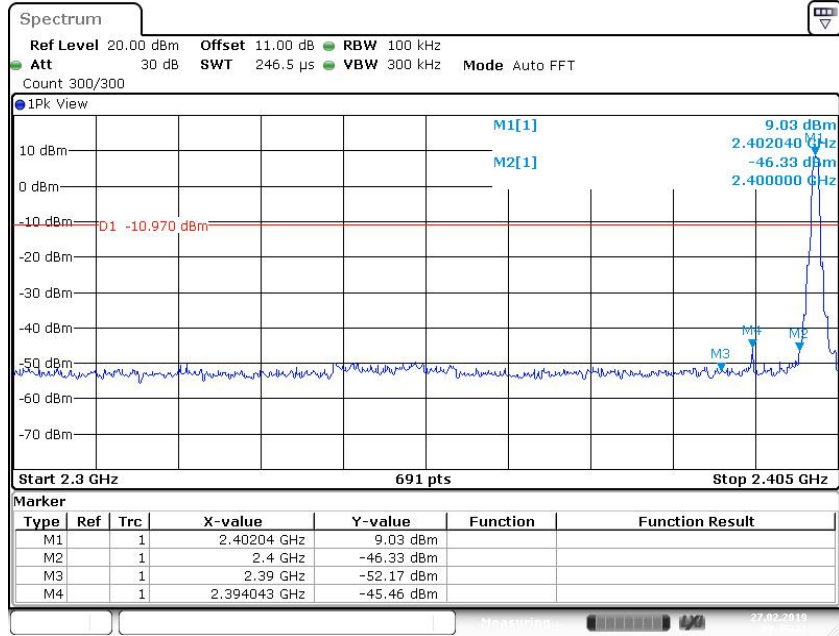

Date: 27 FEB 2019 09:45:42

**2480MHz**

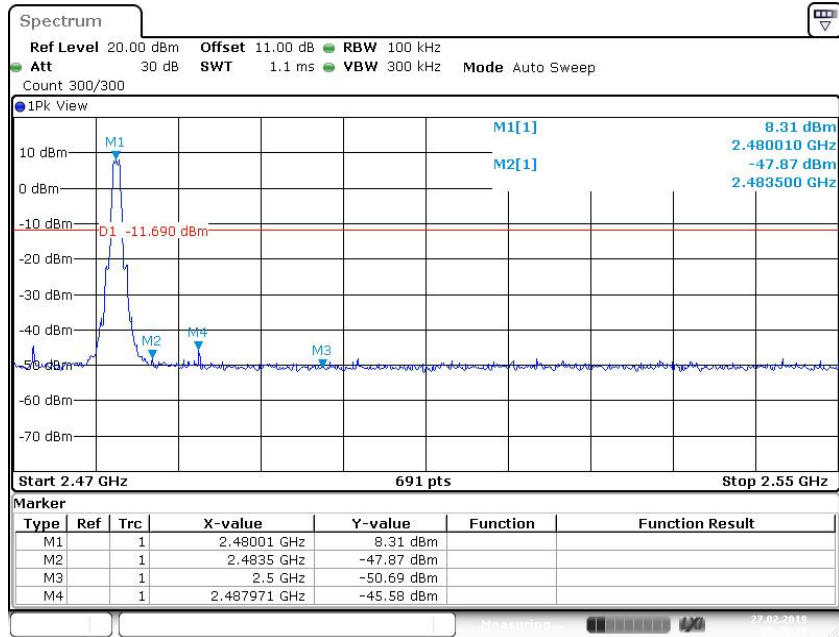

Date: 27 FEB 2019 09:49:11

## 9.6 Spurious radiated emissions for transmitter

### Test Method

- 1: The EUT was placed on a turn table which is 1.5m above ground plane for above 1GHz and 0.8m above ground for below 1GHz at 3 meter chamber room for test. The table was rotated 360 degrees to determine the position of the highest radiation.
- 2: The EUT was set 3 meters away from the interference – receiving antenna, which was mounted on the top of a variable – height antenna tower.
- 3: The height of antenna is varied from one meter to four meters above the ground to determine the maximum value of the field strength. Both horizontal and vertical polarizations of the antenna are set to make the measurement.
- 4: For each suspected emission, the EUT was arranged to its worst case and then the antenna was tuned to heights from 1 meter to 4 meters and the rotatable table was turned from 0 degrees to 360 degrees to find the maximum reading.
- 5: Use the following spectrum analyzer settings According to C63.10:  
For Above 1GHz  
Span = wide enough to capture the peak level of the in-band emission and all spurious  
RBW = 1MHz, VBW $\geq$ RBW for peak measurement and VBW = 10Hz for average measurement, Sweep = auto, Detector function = peak, Trace = max hold.  
For Below 1GHz  
Use the following spectrum analyzer settings:  
Span = wide enough to capture the peak level of the in-band emission and all spurious  
RBW = 100 KHz, VBW $\geq$ RBW for peak measurement, Sweep = auto, Detector function = peak, Trace = max hold.

### Note:

- 1: The resolution bandwidth and video bandwidth of test receiver/spectrum analyzer is 120 KHz for Quasi-peak detection (QP) at frequency below 1GHz.
- 2: The resolution bandwidth of test receiver/spectrum analyzer is 1MHz and the video bandwidth is 3MHz for peak detection (PK) at frequency above 1GHz.
- 3: The resolution bandwidth of test receiver/spectrum analyzer is 1MHz and the video bandwidth is 3MHz for RMS Average ((duty cycle < 98%) for Average detection (AV) at frequency above 1GHz, then the measurement results was added to a correction factor (20log(1/duty cycle)).
- 4: The resolution bandwidth of test receiver/spectrum analyzer is 1MHz and the video bandwidth is 10Hz (duty cycle > 98%) for Average detection (AV) at frequency above 1GHz.

## Limit

The radio emission outside the operating frequency band shall be at least 20 dB below that in the 100 kHz bandwidth within the band that contains the highest level of the desired power. Radiated emissions which fall in the restricted bands, as defined in section 15.205, must comply with the radiated emission limits specified in section 15.209.

Frequency MHz	Field Strength uV/m	Field Strength dB $\mu$ V/m	Detector
30-88	100	40	QP
88-216	150	43.5	QP
216-960	200	46	QP
960-1000	500	54	QP
Above 1000	500	54	AV
Above 1000	5000	74	PK

## Spurious radiated emissions for transmitter

### Transmitting spurious emission test result as below:

#### Low channel 2402MHz Test Result

Frequency Band	Frequency	Emission Level	Polarization	Limit	Detector	Margin	Correct factor (dB)	Result
	MHz	dBuV/m		dBuV/m		dBuV/m		
30-1000MHz	869.21*	26.60	H	46	QP	19.40	-16.0	Pass
	869.00*	30.00	V	46	QP	16.00	-16.0	Pass
1000-25000MHz	4803.28*	38.27	H	74	PK	35.73	2.7	Pass
	--	--	H	54	AV	--	--	Pass
	4803.75*	39.58	V	74	PK	34.42	2.7	Pass
	--	--	V	54	AV	--	--	Pass

#### Middle channel 2440MHz Test Result

Frequency Band	Frequency	Emission Level	Polarization	Limit	Detector	Margin	Correct factor (dB)	Result
	MHz	dBuV/m		dBuV/m		dBuV/m		
30-1000MHz	--	--	H	43.5	QP	--	--	Pass
	--	--	H	46	QP	--	--	Pass
1000-25000MHz	4879.69*	42.20	H	74	PK	31.80	2.9	Pass
	--	--	H	54	AV	--	--	Pass
	4879.69*	40.53	V	74	PK	33.47	2.9	Pass
	--	--	V	54	AV	--	--	Pass

## High channel 2480MHz Test Result

Frequency Band	Frequency	Emission Level	Polarization	Limit	Detector	Margin	Correct factor (dB)	Result
	MHz	dBuV/m		dBμV/m		dBuV/m		
30-1000MHz	--	--	H	43.5	QP	--	--	Pass
	--	--	H	46	QP	--	--	Pass
1000-25000MHz	4959.84*	42.25	H	74	PK	31.75	3.3	Pass
	--	--	H	54	AV	--	--	Pass
	4959.84*	43.81	V	74	PK	30.19	3.3	Pass
	--	--	V	54	AV	--	--	Pass

## Remark:

- (1) "\*" means the emission(s) appear within the restrict bands shall follow the requirement of section 15.205.
- (2) Data of measurement within this frequency range shown "--" in the table above means the reading of emissions are the noise floor or attenuated more than 10dB below the permissible limits or the field strength is too small to be measured.
- (3) Above 1GHz: Corrector factor = Antenna Factor + Cable Loss- Amplifier Gain  
Below 1GHz: Corrector factor = Antenna Factor + Cable Loss

## 10 Test Equipment List

### List of Test Instruments

#### Radiated Spurious Emission Test

Description	Manufacturer	Model no.	Serial no.	Cal. due date
Signal Analyzer	Rohde & Schwarz	FSV40	101031	2019-7-6
Trilog Super Broadband Test Antenna	Schwarzbeck	VULB 9163	708	2019-7-13
Horn Antenna	Rohde & Schwarz	HF907	102295	2019-7-13
Wideband Horn Antenna	Q-PAR	QWH-SL-18-40-K-SG	12827	2019-7-12
Pre-amplifier	Rohde & Schwarz	SCU 18	102230	2019-7-6
Pre-amplifier	Rohde & Schwarz	SCU 40A	100432	2019-7-6
Fully Anechoic Chamber	TDK	8X4X4	--	2020-7-7
Test software	Rohde & Schwarz	EMC32	Version 9.15.00	N/A

#### RF Test System

Description	Manufacturer	Model no.	Serial no.	cal. due date
Signal Analyzer	Rohde & Schwarz	FSV40	101030	2019-7-6



## 11 System Measurement Uncertainty

For a 95% confidence level, the measurement expanded uncertainties for defined systems, in accordance with the recommendations of ISO 17025 were:

System Measurement Uncertainty	
Test Items	Extended Uncertainty
Radiated Spurious Emission 25MHz-3000MHz	Horizontal: 4.80dB; Vertical: 4.87dB;
Radiated Spurious Emission 3000MHz-18000MHz	Horizontal: 4.59dB; Vertical: 4.58dB;
Radiated Spurious Emission 18000MHz-40000MHz	Horizontal: 5.05dB; Vertical: 5.04dB;
Conducted RF test	RF Power Conducted: 1.16dB Frequency test involved: 0.6×10 <sup>-7</sup> or 1%