



PART 2 Test Under Dynamic Transmission Condition

No. I23Z60483-SEM03

For

OnePlus Technology (Shenzhen) Co., Ltd.

Mobile Phone

Model Name: CPH2551

with

Hardware Version: 11

Software Version: OxygenOS 13.2

FCC ID: 2ABZ2-AA541

Issued Date: 2023-6-30

Note:

The test results in this test report relate only to the devices specified in this report. This report shall not be reproduced except in full without the written approval of CTTL.

Test Laboratory:

CTTL, Telecommunication Technology Labs, CAICT
No. 52, Huayuan North Road, Haidian District, Beijing, P. R. China 100191.
Tel: +86(0)10-62304633-2512, Fax: +86(0)10-62304633-2504
Email: ctl_terminals@caict.ac.cn, website: www.caict.ac.cn



REPORT HISTORY

Report Number	Revision	Issue Date	Description
I23Z60483-SEM03	Rev.0	2023-6-30	Initial creation of test report

TABLE OF CONTENT

1 TEST LABORATORY	4
1.1 TESTING LOCATION	4
1.2 TESTING ENVIRONMENT	4
1.3 PROJECT DATA	4
1.4 SIGNATURE	4
2 INTRODUCTION.....	5
3 TX VARYING TRANSMISSION TEST CASES AND TEST PROPOSAL	6
4 SAR TIME AVERAGING VALIDATION TEST PROCEDURES.....	9
4.1 TEST SEQUENCE DETERMINATION FOR VALIDATION	9
4.2 TEST CONFIGURATION SELECTION CRITERIA FOR VALIDATING SMART TRANSMITFEATURE	9
4.3 TEST PROCEDURES FOR CONDUCTED POWER MEASUREMENTS	12
4.4 TEST PROCEDURE FOR TIME-VARYING SAR MEASUREMENTS	20
5 TEST CONFIGURATIONS	22
5.1 WWAN (SUB-6) TRANSMISSION	22
6 CONDUCTED POWER TEST RESULTS FOR SUB-6 SMART TRANSMIT FEATURE VALIDATION	25
6.1 MEASUREMENT SETUP.....	25
6.2 <i>PLIMIT</i> AND <i>P_{MAX}</i> MEASUREMENT RESULTS.....	28
6.3 TIME-VARYING TX POWER MEASUREMENT RESULTS	29
6.4 CHANGE IN CALL TEST RESULTS (TEST CASE 9).....	62
6.5 CHANGE IN TECHNOLOGY/BAND TEST RESULTS (TEST CASE 10).....	64
6.6 CHANGE IN ANTENNA TEST RESULTS (TEST CASE 13).....	66
6.7 CHANGE IN DSI TEST RESULTS (TEST CASE 11)	68
6.8 SWITCH IN SAR EXPOSURE TEST RESULTS LTE B2 NR N77 (TEST CASE 12)	70
6.9 CHANGE IN TIME WINDOW TEST RESULTS (TEST CASE 14).....	72
7 SAR TEST RESULTS FOR SUB-6 SMART TRANSMIT FEATURE	74
7.1 MEASUREMENT SETUP.....	74
7.2 SAR MEASUREMENT RESULTS FOR TIME-VARYING TX POWER TRANSMISSION SCENARIO	75
8 CONCLUSIONS.....	92
APPENDIX A. TEST SEQUENCES	93
APPENDIX B TEST PROCEDURES FOR SUB6 NR + LTE RADIO	96
APPENDIX C DASY6 SYSTEM VALIDATION	98
APPENDIX D CALIBRATION CERTIFICATE OF PROBE AND DIPOLE	104

1 Test Laboratory

1.1 Testing Location

Company Name:	CTTL
Address:	No. 52, Huayuan North Road, Haidian District, Beijing, P. R. China 100191.

1.2 Testing Environment

Temperature:	18°C~25°C,
Relative humidity:	30%~ 70%
Ground system resistance:	< 0.5 Ω
Ambient noise & Reflection:	< 0.012 W/kg

1.3 Project Data

Project Leader:	Qi Dianyuan
Test Engineer:	Wang Meng
Testing Start Date:	June 16,2023
Testing End Date:	June 29,2023

1.4 Signature



Wang Meng
(Prepared this test report)



Qi Dianyuan
(Reviewed this test report)

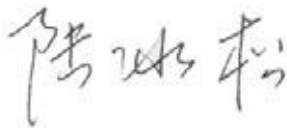

Lu Bingsong
Deputy Director of the laboratory
(Approved this test report)

2 Introduction

The equipment under test (EUT) is a smart phone. It contains the Qualcomm modem supporting 2G/3G/4G technologies and 5G NR Sub-6 GHz technologies. These modems enable Qualcomm Smart Transmit feature to control and manage transmitting power in real time and to ensure at all times the time-averaged RF exposure is in compliance with the FCC requirement.

This purpose of the Part 2 report is to demonstrate the EUT complies with FCC RF exposure requirement under Tx varying transmission scenarios, thereby validity of Qualcomm Smart Transmit feature for FCC equipment authorization of Model CPH2551. This EUT does not support mmW 5G WWAN therefore disregard all references to mmW PD.

The P_{limit} used in this report is determined in Part 0 reports.

Refer to Compliance summary report for product description and terminology used in this report.

DUT contains embedded file system (EFS) version 19 configured for the Second generation (GEN2).

3 Tx Varying Transmission Test Cases and Test Proposal

To validate time averaging feature and demonstrate the compliance in Tx varying transmission conditions, the following transmission scenarios are covered in Part 2 test:

1. During a time-varying Tx power transmission: To prove that the Smart Transmit feature accounts for Tx power variations in time accurately.
2. During a call disconnect and re-establish scenario: To prove that the Smart Transmit feature accounts for history of past Tx power transmissions accurately.
3. During technology/band handover: To prove that the Smart Transmit feature functions correctly during transitions in technology/band.
4. During DSI (Device State Index) change: To prove that the Smart Transmit feature functions correctly during transition from one device state (DSI) to another.
5. During antenna (or beam) switch: To prove that the Smart Transmit feature functions correctly during transitions in antenna (such as AsDiv scenario) or beams (different antenna array configurations).
6. SAR vs. PD exposure switching during sub-6+mmW transmission: To prove that the Smart Transmit feature functions correctly and ensures total RF exposure compliance during transitions in SAR dominant exposure, SAR+PD exposure, and PD dominant exposure scenarios.
7. During time window switch: To prove that the Smart Transmit feature correctly handles the transition from one time window to another specified by FCC, and maintains the normalized time-averaged RF exposure to be less than normalized FCC limit of 1.0 at all times
8. SAR exposure switching between two active radios (radio1 and radio2): To prove that the Smart Transmit feature functions correctly and ensures total RF exposure compliance when exposure varies among SAR_radio1 only, SAR_radio1 + SAR_radio2, and SAR_radio2 only scenarios.

As described in Part 0 report, the RF exposure is proportional to the Tx power for a SAR- and PD-characterized wireless device. Thus, feature validation in Part 2 can be effectively performed through conducted (for $f < 6\text{GHz}$) and radiated (for $f \geq 6\text{GHz}$) power measurement. Therefore, the compliance demonstration under dynamic transmission conditions and feature validation are done in conducted/radiated power measurement setup for transmission scenario 1 through 7.

To add confidence in the feature validation, the time-averaged SAR and PD measurements are also performed but only performed for transmission scenario 1 to avoid the complexity in SAR and PD measurement (such as, for scenario 3 requiring change in SAR probe calibration file to accommodate different bands and/or tissue simulating liquid).

The strategy for testing in Tx varying transmission condition is outlined as follows:

- Demonstrate the total RF exposure averaged over FCC defined time windows does not exceed FCC's SAR and PD limits, through time-averaged power measurements
 - Measure conducted Tx power (for $f < 6\text{GHz}$) versus time, and radiated Tx power (EIRP for $f > 10\text{GHz}$) versus time.
 - Convert it into RF exposure and divide by respective FCC limits to get normalized exposure versus time.
 - Perform running time-averaging over FCC defined time windows.
 - Demonstrate that the total normalized time-averaged RF exposure is less than 1 for all transmission scenarios (i.e., transmission scenarios 1, 2, 3, 4, 5, 6, 7, and 8) at all times.

Mathematical expression:

- For sub-6 transmission only:

$$1g_or_10gSAR(t) = \frac{\text{conducted_Tx_power}(t)}{\text{conducted_Tx_power_P_limit}} * 1g_or_10gSAR_P_limit \quad (1a)$$

$$\frac{\frac{1}{T_{SAR}} \int_{t-T_{SAR}}^t 1g_or_10gSAR(t) dt}{FCC\ SAR\ limit} \leq 1 \quad (1b)$$

- For sub-6+mmW transmission:

$$1g_or_10gSAR(t) = \frac{\text{conducted_Tx_power}(t)}{\text{conducted_Tx_power_P_limit}} * 1g_or_10gSAR_P_limit \quad (2a)$$

$$4cm^2PD(t) = \frac{\text{radiated_Tx_power}(t)}{\text{radiated_Tx_power_input_power_limit}} * 4cm^2PD_input_power_limit \quad (2b)$$

$$\frac{\frac{1}{T_{SAR}} \int_{t-T_{SAR}}^t 1g_or_10gSAR(t) dt}{FCC\ SAR\ limit} + \frac{\frac{1}{T_{PD}} \int_{t-T_{PD}}^t 4cm^2PD(t) dt}{FCC\ 4cm^2\ PD\ limit} \leq 1 \quad (2c)$$

where, $\text{conducted_Tx_power}(t)$, $\text{conducted_Tx_power_P_limit}$, and $1g_or_10gSAR_P_limit$ correspond to the measured instantaneous conducted Tx power, measured conducted Tx power at P_{limit} , and measured $1gSAR$ or $10gSAR$ values at P_{limit} corresponding to sub-6 transmission. Similarly, $\text{radiated_Tx_power}(t)$, $\text{radiated_Tx_power_input_power_limit}$, and $4cm^2PD_input_power_limit$ correspond to the measured instantaneous radiated Tx power, radiated Tx power at input_power_limit (i.e., radiated power limit), and $4cm^2PD$ value at input_power_limit corresponding to mmW transmission. Both P_{limit} and input_power_limit are the parameters pre-defined in Part 0 and loaded via Embedded File System (EFS) onto the EUT. T_{SAR} is the FCC defined time window for sub-6 radio; T_{PD} is the FCC defined time window for mmW radio.

- Demonstrate the total RF exposure averaged over FCC defined time windows does not exceed FCC's SAR and PD limits, through time-averaged SAR and PD measurements. Note as mentioned earlier, this measurement is performed for transmission scenario 1 only.

- For sub-6 transmission only, measure instantaneous SAR versus time; for LTE+sub6 NR transmission, request low power (or all-down bits) on LTE so that measured SAR predominantly corresponds to sub6 NR.
- For LTE + mmW transmission, measure instantaneous E-field versus time for mmW radio and instantaneous conducted power versus time for LTE radio.
- Convert it into RF exposure and divide by respective FCC limits to obtain normalized exposure versus time.
- Perform time averaging over FCC defined time window.
- Demonstrate that the total normalized time-averaged RF exposure is less than 1 for transmission scenario 1 at all times.

Mathematical expression:

- For sub-6 transmission only:

$$1g_or_10gSAR(t) = \frac{pointSAR(t)}{pointSAR_P_{limit}} * 1g_or_10gSAR(t)_P_{limit} \quad (3a)$$

$$\frac{\frac{1}{T_{SAR}} \int_{t-T_{SAR}}^t 1g_or_10gSAR(t) dt}{FCC\ SAR\ limit} \leq 1 \quad (3b)$$

- For LTE+mmW transmission:

$$1g_or_10gSAR(t) = \frac{conducted_Tx_power(t)}{conducted_Tx_power_P_{limit}} * 1g_or_10gSAR_P_{limit} \quad (4a)$$

$$4cm^2PD(t) = \frac{[pointE(t)]^2}{[pointE_input.power.limit]^2} * 4cm^2PD_input.power.limit \quad (4b)$$

$$\frac{\frac{1}{T_{SAR}} \int_{t-T_{SAR}}^t 1g_or_10gSAR(t) dt}{FCC\ SAR\ limit} + \frac{\frac{1}{T_{PD}} \int_{t-T_{PD}}^t 4cm^2PD(t) dt}{FCC\ 4cm^2PD\ limit} \leq 1 \quad (4c)$$

where, $pointSAR(t)$, $pointSAR_P_{limit}$, and $1g_or_10gSAR_P_{limit}$ correspond to the measured instantaneous point SAR, measured point SAR at P_{limit} , and measured $1gSAR$ or $10gSAR$ values at P_{limit} corresponding to sub-6 transmission. Similarly, $pointE(t)$, $pointE_input.power.limit$, and $4cm^2PD_input.power.limit$ correspond to the measured instantaneous E-field, E-field at $input.power.limit$, and $4cm^2PD$ value at $input.power.limit$ corresponding to mmW transmission.

NOTE: cDASY6 measurement system by Schmid & Partner Engineering AG (SPEAG) of Zurich, Switzerland measures relative E-field, and provides ratio of

$$\frac{[pointE(t)]^2}{[pointE_input.power.limit]^2} \text{ versus time.}$$

4 SAR Time Averaging Validation Test Procedures

This chapter provides the test plan and test procedure for validating Qualcomm Smart Transmit feature for sub-6 transmission. The 100 seconds time window for operating $f < 3\text{GHz}$ is used as an example to detail the test procedures in this chapter. The same test plan and test procedures described in this chapter apply to 60 seconds time window for operating $f \geq 3\text{GHz}$.

4.1 Test sequence determination for validation

Following the FCC recommendation, two test sequences having time-variation in Tx power are predefined for sub-6 ($f < 6\text{GHz}$) validation:

- Test sequence 1: request EUT's Tx power to be at maximum power, measured P_{max}^{\dagger} , for 80s, then requesting for half of the maximum power, i.e., measured $P_{max}/2$, for the rest of the time.
- Test sequence 2: request EUT's Tx power to vary with time. This sequence is generated relative to measured P_{max} , measured P_{limit} and calculated $P_{reserve}$ ($=$ measured P_{limit} in dBm - $Reserve_power_margin$ in dB) of EUT based on measured P_{limit} .

The details for generating these two test sequences is described and listed in Appendix A.

Note: For test sequence generation, "measured P_{limit} " and "measured P_{max} " are used instead of the " P_{limit} " specified in EFS entry and " P_{max} " specified for the device, because Smart Transmit feature operates against the actual power level of the " P_{limit} " that was calibrated for the EUT. The "measured P_{limit} " accurately reflects what the feature is referencing to, therefore, it should be used during feature validation testing. The RF tune up and device-to-device variation are already considered in Part 0 report prior to determining P_{limit} .

4.2 Test configuration selection criteria for validating Smart Transmit feature

For validating Smart Transmit feature, this section provides a general guidance to select test cases. In practice, an adjustment can be made in test case selection. The justification/clarification may be provided.

4.2.1 Test configuration selection for time-varying Tx power transmission

The Smart Transmit time averaging feature operation is independent of bands, modes, and channels for a given technology. Hence, validation of Smart Transmit in one band/mode/channel per technology is sufficient. Two bands per technology are proposed and selected for this testing to provide high confidence in this validation.

The criteria for the selection are based on the P_{limit} values determined in Part 0 report. Select two bands* in each supported technology that correspond to least** and highest*** P_{limit} values that are less than P_{max} for validating Smart Transmit.

* If one P_{limit} level applies to all the bands within a technology, then only one band needs to be tested. In this case, within the bands having the same P_{limit} , the radio configuration (e.g., # of RBs, channel#) and device position that correspond to the highest *measured* 1g SAR at P_{limit} shown in Part 1 report is selected.

** In case of multiple bands having the same least P_{limit} within the technology, then select the band having the highest *measured* 1g SAR at P_{limit} .

*** The band having a higher P_{limit} needs to be properly selected so that the power limiting enforced by Smart Transmit can be validated using the pre-defined test sequences. If the highest P_{limit} in a technology is too high where the power limiting enforcement is not needed when testing with the pre-defined test sequences, then the next highest level is checked. This process is continued within the technology until the second band for validation testing is determined.

4.2.2 Test configuration selection for change in call

The criteria to select a test configuration for call-drop measurement is:

- Select technology/band with least P_{limit} among all supported technologies/bands, and select the radio configuration (e.g., # of RBs, channel#) in this technology/band that corresponds to the highest *measured* 1g SAR at P_{limit} listed in Part 1 report.
- In case of multiple bands having same least P_{limit} , then select the band having the highest *measured* 1g SAR at P_{limit} in Part 1 report.

This test is performed with the EUT's Tx power requested to be at maximum power, the above band selection will result in Tx power enforcement (i.e., EUT forced to have Tx power at $P_{reserve}$) for longest duration in one FCC defined time window. The call change (call drop/reestablish) is performed during the Tx power enforcement duration (i.e., during the time when EUT is forced to have Tx power at $P_{reserve}$). One test is sufficient as the feature operation is independent of technology and band.

4.2.3 Test configuration selection for change in technology/band

The selection criteria for this measurement is, for a given antenna, to have EUT switch from a technology/band with lowest P_{limit} within the technology group (in case of multiple bands having the same P_{limit} , then select the band with highest *measured* 1g SAR at P_{limit}) to a technology/band with highest P_{limit} within the technology group, in case of multiple bands having the same P_{limit} , then select the band with lowest *measured* 1g SAR at P_{limit} in Part 1 report, or vice versa.

This test is performed with the EUT's Tx power requested to be at maximum power, the technology/band switch is performed during Tx power enforcement duration (i.e., during the time when EUT is forced to have Tx power at $P_{reserve}$).

4.2.4 Test configuration selection for change in antenna

The criteria to select a test configuration for antenna switch measurement is:

- Whenever possible and supported by the EUT, first select antenna switch configuration within the same technology/band (i.e., same technology and band combination).
- Then, select any technology/band that supports multiple Tx antennas, and has the highest difference in P_{limit} among all supported antennas.
- In case of multiple bands having same difference in P_{limit} among supported antennas, then select the band having the highest *measured* 1g SAR at P_{limit} in Part 1 report.

This test is performed with the EUT's Tx power requested to be at maximum power in selected technology/band, and antenna change is conducted during Tx power enforcement duration (i.e.,

during the time when EUT is forced to have Tx power at $P_{reserve}$).

4.2.5 Test configuration selection for change in DSI

The criteria to select a test configuration for DSI change test is:

- Select a technology/band having the $P_{limit} < P_{max}$ within any technology and DSI group, and for the same technology/band having a different P_{limit} in any other DSI group. Note that the selected DSI transition need to be supported by the device.

This test is performed with the EUT's Tx power requested to be at maximum power in selected technology/band, and DSI change is conducted during Tx power enforcement duration (i.e., during the time when EUT is forced to have Tx power at $P_{reserve}$).

4.2.6 Test configuration selection for SAR exposure switching

If supported, the test configuration for SAR exposure switching should cover:

1. SAR exposure switch when two active radios are in the same time window
2. SAR exposure switch when two active radios are in different time windows. One test with two active radios in any two different time windows is sufficient as Smart Transmit operation is the same for RF exposure switch in any combination of two different time windows. For device supporting LTE + mmW NR, this test is covered in Section 8.2.3 and 8.2.4.

The Smart Transmit time averaging operation is independent of the source of SAR exposure (for example, LTE vs. Sub6 NR) and ensures total time-averaged RF exposure compliance. Hence, validation of Smart Transmit in any one simultaneous SAR transmission scenario (i.e., one combination for LTE + Sub6 NR transmission) is sufficient, where the SAR exposure varies among SAR_{radio1} only, $SAR_{radio1} + SAR_{radio2}$, and SAR_{radio2} only scenarios.

The criteria to select a test configuration for validating Smart Transmit feature during SAR exposure switching scenarios is:

- Select any two < 6GHz technologies/bands that the EUT supports simultaneous transmission (for example, LTE+Sub6 NR).
- Among all supported simultaneous transmission configurations, the selection order is
 1. select one configuration where both P_{limit} of radio1 and radio2 is less than their corresponding P_{max} , preferably, with different P_{limits} . If this configuration is not available, then,
 2. select one configuration that has P_{limit} less than its P_{max} for at least one radio. If this cannot be found, then,
 3. select one configuration that has P_{limit} of radio1 and radio2 greater than P_{max} but with least $(P_{limit} - P_{max})$ delta.

Test for one simultaneous transmission scenario is sufficient as the feature operation is the same.

4.3 Test procedures for conducted power measurements

This section provides general conducted power measurement procedures to perform compliance test under dynamic transmission scenarios described in Section 2. In practice, an adjustment can be made in these procedures. The justification/clarification may be provided.

4.3.1 Time-varying Tx power transmission scenario

This test is performed with the two pre-defined test sequences described in Section 3.1 for all the technologies and bands selected in Section 3.2.1. The purpose of the test is to demonstrate the effectiveness of power limiting enforcement and that the time-averaged SAR (corresponding time-averaged Tx power) does not exceed the FCC limit at all times (see Eq. (1a) and (1b)).

Test procedure

· P_{max} , measure P_{limit} and calculate $P_{reserve}$ (= measured P_{limit} in dBm – $Reserve_power_margin$ in dB) and follow Section 3.1 to generate the test sequences for all the technologies and bands selected in Section 3.2.1. Both test sequence 1 and test sequence 2 are created based on measured P_{max} and measured P_{limit} of the EUT. Test condition to measure P_{max} and P_{limit} is:

- Measure P_{max} with Smart Transmit disabled and callbox set to request maximum power.
- Measure P_{limit} with Smart Transmit enabled and $Reserve_power_margin$ set to 0 dB; callbox set to request maximum power.

2. Set $Reserve_power_margin$ to actual (intended) value (3dB for this EUT based on Part 1 report) and reset power on EUT to enable Smart Transmit, establish radio link in desired radio configuration, with callbox requesting the EUT's Tx power to be at pre-defined test sequence 1, measure and record Tx power versus time, and then convert the conducted Tx power into 1g SAR or 1g SAR value (see Eq. (1a)) using measured P_{limit} from above Step 1. Perform running time average to determine time-averaged power and 1g SAR or 1g SAR versus time as illustrated in Figure 3-1 where using 100-seconds time window as an example.

Note: In Eq.(1a), instantaneous Tx power is converted into instantaneous 1g SAR or 1g SAR value by applying the measured worst-case 1g SAR or 1g SAR value at P_{limit} for the corresponding technology/band/antenna/DSI reported in Part 1 report.

Note: For an easier computation of the running time average, 0 dBm can be added at the beginning of the test sequences the length of the responding time window, for example, add 0dBm for 100-seconds so the running time average can be directly performed starting with the first 100-seconds data using excel spreadsheet. This technique applies to all tests performed in this Part 2 report for easier time-averaged computation using excel spreadsheet.

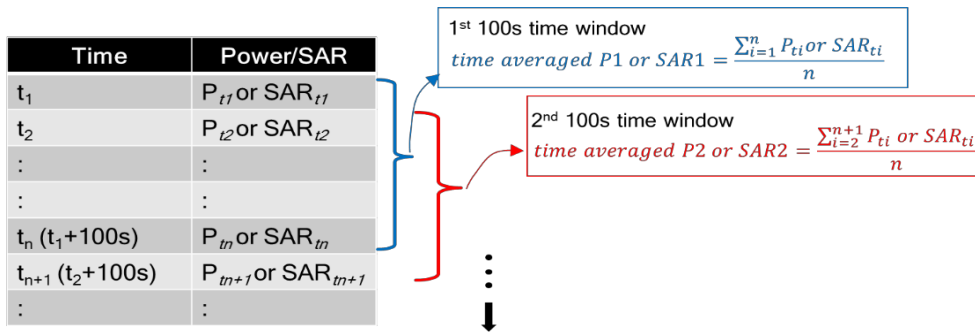

Figure 3-1 100s running average illustration

3. Make one plot containing:

- a. Instantaneous Tx power versus time measured in Step 2,
- b. Requested Tx power used in Step 2 (test sequence 1),
- c. Computed time-averaged power versus time determined in Step 2,
- d. Time-averaged power limit (corresponding to FCC SAR limit of 1.6 W/kg for 1g SAR or 1.6W/kg for 1g SAR) given by:

$$Time\ averaged\ power\ limit = meas. P_{limit} + 10 \times \log\left(\frac{FCC\ SAR\ limit}{meas.SAR_Plimit}\right) \quad (5a)$$

where $meas. P_{limit}$ and $meas. SAR_Plimit$ correspond to measured power at P_{limit} and measured SAR at P_{limit} .

Make another plot containing:

- a Amputed time-averaged 1g SAR or 1g SAR versus time determined in Step 2
 - b SARlimit of 1.6W/kg or FCC 1g SAR limit of 1.6W/kg.
4. Repeat Steps 2 ~ 4 for pre-defined test sequence 2 and replace the requested Tx power (test sequence 1) in Step 2 with test sequence 2.
 5. Repeat Steps 2 ~ 5 for all the selected technologies and bands.

The validation criteria are, at all times, the time-averaged power versus time shown in Step 3 plot shall not exceed the time-averaged power limit (defined in Eq. (5a)), in turn, the time- averaged 1g SAR or 1g SAR versus time shown in Step 4 plot shall not exceed the FCC limit of 1.6 W/kg for 1g SAR or 1.6 W/kg for 1g SAR (i.e., Eq. (1b)).

4.3.2 Change in call scenario

This test is to demonstrate that Smart Transmit feature accurately accounts for the past Tx powers during time-averaging when a new call is established.

The call disconnects and re-establishment needs to be performed during power limit enforcement, i.e., when the EUT's Tx power is at $P_{reserve}$ level, to demonstrate the continuity of RF exposure management and limiting in call change scenario. In other words, the RF exposure averaged over any FCC defined time window (including the time windows containing the call change) doesn't exceed FCC limit of 1.6 W/kg for 1g SAR or 1.6 W/kg for 1g SAR.

Test procedure

1. Measure P_{limit} for the technology/band selected in Section 3.2.2. Measure P_{limit} with Smart Transmit enabled and *Reserve_power_margin* set to 0 dB; callbox set to request maximum power.
2. Set *Reserve_power_margin* to actual (intended) value and reset power on EUT to enable Smart Transmit.
3. Establish radio link with callbox in the selected technology/band.
4. Request EUT's Tx power at 0 dBm for at least one time window specified for the selected technology/band, followed by requesting EUT's Tx power to be at maximum power for about ~60 seconds, and then drop the call for ~10 seconds. Afterwards, re-establish another call in the same radio configuration (i.e., same technology/band/channel) and continue callbox requesting EUT's Tx power to be at maximum power for the remaining time of at least another full duration of the specified time window. Measure and record Tx power versus time. Once the measurement is done, extract instantaneous Tx power versus time, convert the measured conducted Tx power into 1g SAR or 1g SAR value using Eq. (1a), and then perform the running time average to determine time-averaged power and 1g SAR or 1g SAR versus time.

Note: In Eq.(1a), instantaneous Tx power is converted into instantaneous 1g SAR or 1g SAR value by applying the measured worst-case 1g SAR or 1g SAR value at P_{limit} for the corresponding technology/band/antenna/DSI reported in Part 1 report.

5. Make one plot containing: (a) instantaneous Tx power versus time, (b) requested power, (c) computed time-averaged power, (d) time-averaged power limit calculated using Eq.(5a).
6. Make another plot containing: (a) computed time-averaged 1g SAR or 1g SAR versus time, and (b) FCC limit of 1.6 W/kg for 1g SAR or 1.6 W/kg for 1g SAR.

The validation criteria are, at all times, the time-averaged power versus time shall not exceed the time- averaged power limit (defined in Eq.(5a)), in turn, the time-averaged 1g SAR or 1g SAR versus time shall not exceed the FCC limit of 1.6 W/kg for 1g SAR or 1.6 W/kg for 1g SAR (i.e., Eq. (1b)).

4.3.3 Change in technology and band

This test is to demonstrate the correct power control by Smart Transmit during technology switches and/or band handovers.

Similar to the change in call test in Section 3.3.2, to validate the continuity of RF exposure limiting during the transition, the technology and band handover needs to be performed when EUT's Tx power is at $P_{reserve}$ level (i.e., during Tx power enforcement) to make sure that the EUT's Tx power from previous $P_{reserve}$ level to the new $P_{reserve}$ level (corresponding to new technology/band). Since the P_{limit} could vary with technology and band, Eq. (1a) can be written as follows to convert the instantaneous Tx power in 1g SAR or 1g SAR exposure for the two given radios, respectively:

$$1g_or_10gSAR_1(t) = \frac{conducted_Tx_power_1(t)}{conducted_Tx_power_P_{limit_1}} * 1g_or_10gSAR_P_{limit_1} \quad (6a)$$

$$1g_or_10gSAR_2(t) = \frac{conducted_Tx_power_2(t)}{conducted_Tx_power_P_{limit_2}} * 1g_or_10gSAR_P_{limit_2} \quad (6b)$$

$$\frac{1}{T_{SAR}} \left[\int_{t-T_{SAR}}^{t_1} \frac{1g_or_10gSAR_1(t)}{FCC\ SAR\ limit} dt + \int_{t-T_{SAR}}^t \frac{1g_or_10gSAR_2(t)}{FCC\ SAR\ limit} dt \right] \leq 1 \quad (6c)$$

where, $conducted_Tx_power_1(t)$, $conducted_Tx_power_P_{limit_1}$, and $1g_or_1g\ SAR_P_{limit_1}$ correspond to the measured instantaneous conducted Tx power, measured conducted Tx power at P_{limit} , and measured 1g SAR or 1g SAR value at P_{limit} of technology1/band1; $conducted_Tx_power_2(t)$, $conducted_Tx_power_P_{limit_2}(t)$, and $1g_or_1g\ SAR_P_{limit_2}$ correspond to the measured instantaneous conducted Tx power, measured conducted Tx power at P_{limit} , and measured 1g SAR or 1g SAR value at P_{limit} of technology2/band2. Transition from technology1/band1 to the technology2/band2 happens at time- instant ' t_i '.

Test procedure

1. Measure P_{limit} for both the technologies and bands selected in Section 3.2.3. Measure P_{limit} with Smart Transmit enabled and *Reserve_power_margin* set to 0 dB; callbox set to request maximum power.
2. Set *Reserve_power_margin* to actual (intended) value and reset power on EUT to enable Smart Transmit
3. Establish radio link with callbox in first technology/band selected.
4. Request EUT's Tx power at 0 dBm for at least one time window specified for the selected technology/band, followed by requesting EUT's Tx power to be at maximum power for about ~60 seconds, and then switch to second technology/band selected. Continue with callbox requesting EUT's Tx power to be at maximum power for the remaining time of at least another full duration of the specified time window. Measure and record Tx power versus time for the full duration of the test.
5. Once the measurement is done, extract instantaneous Tx power versus time, and convert the conducted Tx power into 1g SAR or 1g SAR value using Eq. (6a) and (6b) and corresponding measured P_{limit} values from Step 1 of this section. Perform the running time average to determine

time-averaged power and 1g SAR or 1g SAR versus time.

Note: In Eq.(6a) & (6b), instantaneous Tx power is converted into instantaneous 1g SAR or 1g SAR value by applying the measured worst-case 1g SAR or 1g SAR value at P_{limit} for the corresponding technology/band/antenna/DSI reported in Part 1 report.

6. Make one plot containing: (a) instantaneous Tx power versus time, (b) requested power, (c) computed time-averaged power, (d) time-averaged power limit calculated using Eq.(5a).
7. Make another plot containing: (a) computed time-averaged 1g SAR or 1g SAR versus time, and (b) FCC limit of 1.6 W/kg for 1g SAR or 1.6 W/kg for 1g SAR.

The validation criteria are, at all times, the time-averaged 1g SAR or 1g SAR versus time shall not exceed the FCC limit of 1.6 W/kg for 1g SAR or 1.6 W/kg for 1g SAR (i.e., Eq. (6c)).

4.3.4 Change in antenna

This test is to demonstrate the correct power control by Smart Transmit during antenna switches from one antenna to another. The test procedure is identical to Section 3.3.3, by replacing technology/band switch operation with antenna switch. The validation criteria are, at all times, the time-averaged 1g SAR or 1g SAR versus time shall not exceed FCC limit of 1.6 W/kg for 1g SAR or 1.6 W/kg for 1g SAR.

Note: If the EUT does not support antenna switch within the same technology/band, but has multiple antennas to support different frequency bands, then the antenna switch test is included as part of change in technology and band (Section 3.3.3) test.

4.3.5 Change in DSI

This test is to demonstrate the correct power control by Smart Transmit during DSI switches from one DSI to another. The test procedure is identical to Section 3.3.3, by replacing technology/band switch operation with DSI switch. The validation criteria are, at all times, the time-averaged 1g SAR or 1g SAR versus time shall not exceed FCC limit of 1.6 W/kg for 1g SAR or 4.0 W/kg for 10g SAR.

4.3.6 Change in time window

This test is to demonstrate the correct power control by Smart Transmit during the change in averaging time window when a specific band handover occurs. FCC specifies time-averaging windows of 100s for Tx frequency < 3GHz, and 60s for Tx frequency between 3GHz and 6GHz.

To validate the continuity of RF exposure limiting during the transition, the band handover test needs to be performed when EUT handovers from operation band less than 3GHz to greater than 3GHz and vice versa. The equations (3a) and (3b) in Section 2 can be written as follows for transmission scenario having change in time window,

$$1gSAR_1(t) = \frac{\text{conducted_Tx_power_1}(t)}{\text{conducted_Tx_power_P}_{limit_1}} * 1g_or\ 10g_SAR_P_{limit_1} \quad (7a)$$

$$1gSAR_2(t) = \frac{\text{conducted_Tx_power_2}(t)}{\text{conducted_Tx_power_P}_{limit_2}} * 1g_or\ 10g_SAR_P_{limit_2} \quad (7b)$$

$$\frac{1}{T1_{SAR}} \left[\int_{t-T1_{SAR}}^{t_1} \frac{1g_or\ 10g_SAR_1(t)}{FCC\ SAR\ limit} dt \right] + \frac{1}{T2_{SAR}} \left[\int_{t-T2_{SAR}}^t \frac{1g_or\ 10g_SAR_2(t)}{FCC\ SAR\ limit} dt \right] \leq 1 \quad (7c)$$

where, *conducted_Tx_power_1(t)*, *conducted_Tx_power_P_{limit_1}(t)*, and *1g_or 10g_SAR_P_{limit_1}* correspond to the instantaneous Tx power, conducted Tx power at *P_{limit_1}*, and compliance *1g_or 10g_SAR* values at *P_{limit_1}* of band1 with time-averaging window '*T1_{SAR}*'; *conducted_Tx_power_2(t)*, *conducted_Tx_power_P_{limit_2}(t)*, and *1g_or 10g_SAR_P_{limit_2}* correspond to the instantaneous Tx power, conducted Tx power at *P_{limit_2}*, and compliance *1g_or 10g_SAR* values at *P_{limit_2}* of band2 with time-averaging window '*T2_{SAR}*'. One of the two bands is less than 3GHz, another is greater than 3GHz. Transition from first band with time-averaging window '*T1_{SAR}*' to the second band with time-averaging window '*T2_{SAR}*' happens at time-instant '*t₁*'.

Test procedure

8. Measure *P_{limit}* for both the technologies and bands selected in Section 3.2.6. Measure *P_{limit}* with Smart Transmit enabled and *Reserve_power_margin* set to 0 dB, *callbox* set to request maximum power.
9. Set *Reserve_power_margin* to actual (intended) value and enable Smart Transmit

Transition from 100s time window to 60s time window, and vice versa

10. Establish radio link with *callbox* in the technology/band having 100s time window selected in Section 3.2.6.
11. Request EUT's Tx power to be at 0 dBm for at least 100 seconds, followed by requesting EUT's Tx power to be at maximum power for about ~140 seconds, and then switch to second technology/band (having 60s time window) selected in Section 3.2.6. Continue with *callbox* requesting EUT's Tx power to be at maximum power for about ~60s in this second technology/band, and then switch back to the first technology/band. Continue with *callbox* requesting EUT's Tx power to be at maximum power for at least another 100s. Measure and record Tx power versus time for the entire duration of the test.
12. Once the measurement is done, extract instantaneous Tx power versus time, and

convert the conducted Tx power into 1gSAR or 10gSAR value (see Eq. (7a) and (7b)) using corresponding technology/band Step 1 result, and then perform 100s running average to determine time-averaged 1gSAR or 10gSAR versus time. Note that in Eq.(7a) & (7b), instantaneous Tx power is converted into instantaneous 1gSAR or 10gSAR value by applying the worst-case 1gSAR or 10gSAR value tested in Part 1 for the selected technologies/bands at P_{limit}.

13. Make one plot containing: (a) instantaneous Tx power versus time measured in Step 4.

14. Make another plot containing: (a) instantaneous 1gSAR versus time determined in Step 5, (b) computed time-averaged 1gSAR versus time determined in Step 5, and (c) corresponding regulatory $1gSAR_{limit}$ of 1.6W/kg.

Transition from 60s time window to 100s time window, and vice versa

15. Establish radio link with callbox in the technology/band having 60s time window selected in Section 3.2.6.

16. Request EUT's Tx power to be at 0 dBm for at least 60 seconds, followed by requesting EUT's Tx power to be at maximum power for about ~80 seconds, and then switch to second technology/band (having 100s time window) selected in Section 3.2.6. Continue with callbox requesting EUT's Tx power to be at maximum power for about ~100s in this second technology/band, and then switch back to the first technology/band. Continue with callbox requesting EUT's Tx power to be at maximum power for the remaining time for a total test time of 500 seconds. Measure and record Tx power versus time for the entire duration of the test.

17. Repeat above Step 5~7 to generate the plots

The validation criteria is, at all times, the time-averaged 1gSAR or 10gSAR versus time shall not exceed the regulatory 1gSAR_{limit} of 1.6W/kg.

4.3.7 SAR exposure switching

This test is to demonstrate that Smart Transmit feature accurately accounts for switching in exposures among SAR from radio1 only, SAR from both radio1 and radio2, and SAR from radio2 only scenarios, and ensures total time-averaged RF exposure complies with the FCC limit. Here, radio1 represents primary radio (for example, LTE anchor in a NR non-standalone mode call) and radio2 represents secondary radio (for example, sub6 NR or mmW NR). The detailed test procedure for SAR exposure switching in the case of LTE+Sub6 NR non-standalone mode transmission scenario is provided in Appendix B.2.

Test procedure

1. Measure conducted Tx power corresponding to P_{limit} for radio1 and radio2 in selected band. Test condition to measure conducted P_{limit} is:
 - Establish device in call with the callbox for radio1 technology/band. Measure conducted Tx power corresponding to radio1 P_{limit} with Smart Transmit enabled and *Reserve_power_margin* set to 0 dB, callbox set to request maximum power.
 - Repeat above step to measure conducted Tx power corresponding to radio2 P_{limit} . If radio2 is dependent on radio1 (for example, non-standalone mode of Sub6 NR requiring radio1 LTE as anchor), then establish radio1 + radio2 call with callbox, and request all down bits for radio1 LTE. In this scenario, with callbox requesting maximum power from radio2 Sub6 NR, measured conducted Tx power corresponds to radio2 P_{limit} (as radio1 LTE is at all-down bits)
 2. Set *Reserve_power_margin* to actual (intended) value, with EUT setup for radio1 + radio2 call. In this description, it is assumed that radio2 has lower priority than radio1. Establish device in radio1+radio2 call, and request all-down bits or low power on radio1, with callbox requesting EUT's Tx power to be at maximum power in radio2 for at least one time window. After one time window, set callbox to request EUT's Tx power to be at maximum power on radio1, i.e., all-up bits. Continue radio1+radio2 call with both radios at maximum power for at least one time window, and drop (or request all-down bits on) radio2. Continue radio1 at maximum power for at least one time window. Record the conducted Tx power for both radio1 and radio2 for the entire duration of this test.
 3. Once the measurement is done, extract instantaneous Tx power versus time for both radio1 and radio2 links. Convert the conducted Tx power for both these radios into 1g SAR or 1g SAR value (see Eq. (6a) and (6b)) using corresponding technology/band P_{limit} measured in Step 1, and then perform the running time average to determine time-averaged 1g SAR or 1g SAR versus time.
 4. Make one plot containing: (a) instantaneous Tx power versus time measured in Step 2.
 5. Make another plot containing: (a) instantaneous 1g SAR versus time determined in Step 3, (b) computed time-averaged 1g SAR versus time determined in Step 3, and (c) corresponding regulatory 1g SAR_{limit} of 1.6W/kg or 1g SAR_{limit of 1.6W/kg}.
- The validation criteria is, at all times, the time-averaged 1g SAR or 1g SAR versus time shall not exceed the regulatory 1g SAR_{limit} of 1.6W/kg or 1g SAR_{limit of 1.6W/kg}

4.4 Test procedure for time-varying SAR measurements

This section provides general time-varying SAR measurement procedures to perform compliance test under dynamic transmission scenarios described in Section 2. In practice, an adjustment can be made in these procedures. The justification/clarification may be provided.

To perform the validation through SAR measurement for transmission scenario 1 described in Section 2, the “path loss” between callbox antenna and EUT needs to be calibrated to ensure that the EUT Tx power reacts to the requested power from callbox in a radiated call. It should be noted that when signaling in closed loop mode, protocol-level power control is in play, resulting in EUT not solely following callbox TPC (Tx power control) commands. In other words, EUT response has many dependencies (RSSI, quality of signal, path loss variation, fading, etc.,) other than just TPC commands. These dependencies have less impact in conducted setup (as it is a controlled environment and the path loss can be very well calibrated) but have significant impact on radiated testing in an uncontrolled environment, such as SAR test setup. Therefore, the deviation in EUT Tx power from callbox requested power is expected, however the time-averaged SAR should not exceed FCC SAR requirement at all times as Smart Transmit controls Tx power at EUT.

The following steps are for time averaging feature validation through SAR measurement:

1. “Path Loss” calibration: Place the EUT against the phantom in the worst-case position determined based on Section 3.2.1. For each band selected, prior to SAR measurement, perform “path loss” calibration between callbox antenna and EUT. Since the SAR test environment is not controlled and well calibrated for OTA (Over the Air) test, extreme care needs to be taken to avoid the influence from reflections. The test setup is described in Section 6.1.
2. Time averaging feature validation:
 - i For a given radio configuration (technology/band) selected in Section 3.2.1, enable Smart Transmit and set *Reserve_power_margin* to 0 dB, with callbox to request maximum power, perform area scan, conduct pointSAR measurement at peak location of the area scan. This point SAR value, *pointSAR_P_{limit}*, corresponds to point SAR at the measured *P_{limit}* (i.e., measured *P_{limit}* from the EUT in Step 1 of Section 3.3.1).
 - ii Set *Reserve_power_margin* to actual (intended) value and reset power on EUT to enable Smart Transmit. Note, if *Reserve_power_margin* cannot be set wirelessly, care must be taken to re-position the EUT in the exact same position relative to the SAM phantom as in above Step 2.i. Establish radio link in desired radio configuration, with callbox requesting the EUT’s Tx power at power levels described by test sequence 1 generated in Step 1 of Section 3.3.1, conduct point SAR measurement versus time at peak location of the area scan determined in Step 2.i of this section. Once the measurement is done, extract instantaneous point SAR vs time data, *pointSAR(t)*, and convert it into instantaneous 1g SAR or 1g SAR vs. time using Eq. (3a), re-written below:

$$1g_or_10gSAR(t) = \frac{pointSAR(t)}{pointSAR_P_{limit}} * 1g_or_10gSAR_P_{limit}$$

where, *pointSAR_P_{limit}* is the value determined in Step 2.i, and *pointSAR(t)* is the instantaneous point SAR measured in Step 2.ii, *1g_or_10gSAR_P_{limit}* is the measured 1g SAR or 1g SAR value listed in Part 1 report.

iii Perform 100s running average to determine time-averaged 1g SAR or 1g SAR versus time. iv
Make one plot containing: (a) time-averaged 1g SAR or 1g SAR versus time determined in
Step 2.iii of this section, (b) FCC limit of 1.6 W/kg for 1g SAR or 1.6 W/kg for 1g SAR.

v Repeat 2.ii ~ 2.iv for test sequence 2 generated in Step 1 of Section
3.3.1.

vi Repeat 2.i ~ 2.v for all the technologies and bands selected in Section
3.2.1.

The time-averaging validation criteria for SAR measurement is that, at all times, the time-averaged
1g SAR or 1g SAR versus time shall not exceed FCC limit of 1.6 W/kg for 1g SAR or 1.6 W/kg for
1g SAR (i.e., Eq. (3b)).

Note: Maximum tune up target power, P_{max} , is configured in NV settings in EUT to limit maximum transmitting power. This power is converted into peak power in NV settings for TDD schemes. The EUT maximum allowed output power is equal to P_{max} + device uncertainty.

Based on selection criteria described in Section 4.2.1, the selected technologies/bands for testing time-varying test sequences are highlighted in Table 5-1. During Part 2 testing, the *Reserve_power_margin*(dB) for this EUT is set to 3dB in EFS.

The radio configurations used in Part 2 test for selected technologies, bands, DSIs and antennas are listed in Table 5-2. The corresponding worst-case radio configuration 1g SAR or 1g SAR values for selected technology/band/DSI are extracted from Part 1 report and are listed in the last column of Table 5-2.

Based on equations (1a), (2a), (3a) and (4a), it is clear that Part 2 testing outcome is normalized quantity, which implies that it can be applied to any radio configuration within a selected technology/band/DSI. Thus, as long as applying the worst-case SAR obtained from the worst radio configuration in Part 1 testing to calculate time-varying SAR exposure in equations (1a), (2a), (3a) and (4a), the accuracy in compliance demonstration remains the same.

Table 5-2: Radio configurations selected for Part 2 test

Test case #	Test scenario	Tech	Band	Ant	DSI	Channel	Freq (MHz)	BW	RB size	RB offset	mode	position	Position details	Part 1 worst-case radio config 1g measured at Plimit(W/kg)
1	time-varying Tx power transmission	GSM	1900	2	2	661	1880	\	\	\	3TX	Top	10mm	0.488
2		GSM	1900	2	14	661	1880	\	\	\	1TX	Top	0mm	0.563
3		WCDMA	1700	2	1	1312	1712.4	\	\	\	RMC	Top	11mm	0.928
4		WCDMA	1700	2	14	1412	1732.4	\	\	\	RMC	Front	0mm	0.639
5		LTE	B41(PC2)	2	1	41490	2680	20M	1	0	QPSK	Top	11mm	0.64
6		LTE	7	2	14	20850	2510	20M	50	0	QPSK	Top	0mm	0.737
7		Sub6 NR	N77-L	0	5	633334	3500.01	10M	12	6	DFT-OFDM QPSK	Left Cheek	0mm	0.839
8		Sub6 NR	N77-L	7	14	636332	3544.98	10M	12	6	DFT-OFDM QPSK	Top	0mm	0.369
9	Call Drop	WCDMA	1700	2	1	1312	1712.4	\	\	\	RMC	Top	11mm	0.928
10	band switch	WCDMA	1700	2	1	1312	1712.4	\	\	\	RMC	Top	11mm	0.928
		LTE	B7	2	1	21100	2535	20M	1	99	QPSK	Top	11mm	0.49
11	Change In DSI	WCDMA	1700	2	1	1312	1712.4	\	\	\	RMC	Top	11mm	0.928
		WCDMA	1700	2	14	1412	1732.4	\	\	\	RMC	Front	0mm	0.639
12	SARvsSAR	LTE	B2	2	5	19100	1900	20M	50	50	QPSK	Right Tilt	0mm	0.988
		Sub6 NR	N77-L	0	5	633334	3500.01	10M	12	6	DFT-OFDM QPSK	Left Cheek	0mm	0.839
13	Antenna switch	WCDMA	1700	2	1	1312	1712.4	\	\	\	RMC	Top	11mm	0.928
		WCDMA	1700	3	11	1412	1732.4	\	\	\	RMC	Front	0mm	0.642
14	Window switch	Sub6 NR	N41	2	5	537000	2685	10M	12	6	DFT-OFDM QPSK	Right Tilt	0mm	1.15
		Sub6 NR	N77-L	2	5	633334	3500.01	10M	12	6	DFT-OFDM QPSK	Right Tilt	0mm	0.704

Note that the EUT has a several DSI states to manage power for different RF exposure conditions, detail DSI states and trigger conditions shown on the following table, the maximum 1gSAR/or 10gSAR among all exposure scenarios is used in Smart Transmit feature for time averaging operation.

Exposure conditions	DSI	SAR design target W/kg(1g)	Remark
stand-alone	1/2/5/11/12/13	1.2	/
simultaneous transmission	6/7/10/14/15/16	0.9	/

Based on the selection criteria described in Section 4.2, the radio configurations for the Tx varying transmission test cases listed in Section 2 are:

1. Technologies and bands for time-varying Tx power transmission: The test case 1~8 listed in Table 4-2 are selected to test with the test sequences defined in Section 5.1 in both time-varying conducted power measurement and time-varying SAR measurement.
2. Technology and band for change in call test: The test case 9 listed in Table 5-2 is selected for performing the call drop test in WCDMA1700 in conducted power setup.
3. Technologies and bands for change in technology/band test: The test case 10 listed in Table 5-2 is selected for handover test from a technology/band to another technology/band, in conducted power setup.
4. Technologies and bands for change in DSI: The test case 11 listed in Table 5-2 is selected for DSI switch test by establishing a call in WCDMA1700 in DSI=1, and then handing over to DSI = 14 exposure scenario in conducted power setup.
5. Technologies and bands for switch in SAR exposure: The test case 12 listed in Table 5-2 are selected for SAR exposure switching test in one of the supported simultaneous WWAN transmission scenario, i.e., LTE + Sub6 NR active in the same 100s time window, in conducted power setup.
6. Technologies and bands for change in technology/band test: The test case 13 listed in Table 5-2 is selected for handover test from a antenna to another antenna, in conducted power setup.
7. Technologies and bands for change in time-window: The test case 14 listed in Table 5-2 is selected for for time window switch between 100s window (NR Band41) and 60s (NR Band77) in conducted power setup.

6 Conducted Power Test Results for Sub-6 Smart Transmit Feature Validation

6.1 Measurement setup

The Rohde & Schwarz CMW500 callbox is used in this test. The test setup picture and schematic are shown in Figures 6-1a & 6-1c for measurements with a single antenna of EUT, and in Figures 6-1b & 6-1d for measurements involving antenna switch (see Appendix C for missing figures). For single antenna measurement, one port (RF1 COM) of the callbox is connected to the RF port of the EUT using a directional coupler. For antenna & technology switch measurement, two ports (RF1 COM and RF3 COM) of the callbox used for signaling two different technologies are connected to a combiner, which is in turn connected to a directional coupler. The other end of the directional coupler is connected to a splitter to connect to two RF ports of the EUT corresponding to the two antennas of interest. In both the setups, power meter is used to tap the directional coupler for measuring the conducted output power of the EUT. For time averaging validation test (Section 4.3.1), call drop test (Section 4.3.2), and DSI switch test (Section 4.3.4), only RF1 COM port of the callbox is used to communicate with the EUT. For technology/band switch measurement (Section. 4.3.3), both RF1 COM and RF3 COM port of callbox are used to switch from one technology communicating on RF1 COM port to another technology communicating on RF3 COM port. Note that for this EUT, antenna switch test (Section 4.3.4) is included within time-window switch test (Section 4.3.6) as the selected technology/band combinations for the time-window switch test are on two different antennas. All the path losses from RF port of EUT to the callbox RF COM port and to the power meter are calibrated and automatically entered as offsets in the callbox and the power meter via test scripts on the PC used to control callbox and power meter.

LTE+Sub6 NR test setup:

If LTE conducted port and Sub6 NR conducted port are same on this EUT (i.e., they share the same antenna), then low-/high-pass filter is used to separate LTE and Sub6 NR signals for power meter measurement via directional couplers, as shown in below Figures 5-1a, 5-1b & 5-1c.

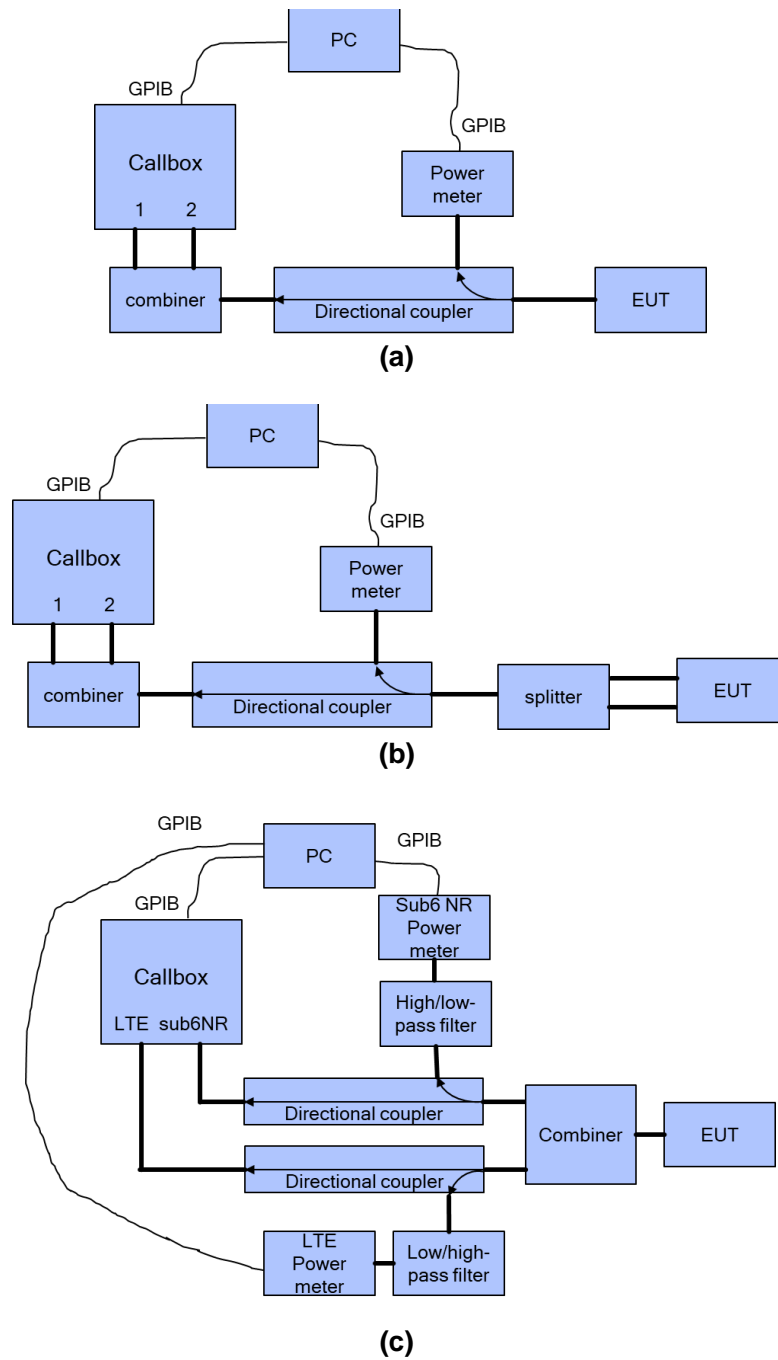

Figure 6-1 Example conducted power measurement setup

Both the callbox and power meter are connected to the PC using GPIB cables. Two test scripts are custom made for automation, and the test duration set in the test scripts is 500 seconds.

For time-varying Tx power measurement, the PC runs the 1st test script to send GPIB commands to control the callbox's requested power versus time, while at the same time to record the conducted power measured at EUT RF port using the power meter. The commands sent to the callbox to request power are:

- 0dBm for 100 seconds
- Test sequence 1 or test sequence 2 (defined in Section 3.1 and generated in Section 3.2.1), for 360 seconds
- Stay at the last power level of test sequence 1 or test sequence 2 for the remaining time. Power meter readings are periodically recorded every 100ms. A running average of this measured Tx power over 100 seconds is performed in the post-data processing to determine the 100s-time averaged power.

For call drop, technology/band/antenna switch, and DSI switch tests, after the call is established, the callbox is set to request the EUT's Tx power at 0dBm for 100 seconds while simultaneously starting the 2nd test script runs at the same time to start recording the Tx power measured at EUT RF port using the power meter. After the initial 100 seconds since starting the Tx power recording, the callbox is set to request maximum power from the EUT for the rest of the test. Note that the call drop/re-establish, or technology/band/antenna switch or DSI switch is manually performed when the Tx power of EUT is at $P_{reserve}$ level. See Section 3.3 for detailed test procedure of call drop test, technology/band/antenna switch test and DSI switch test.

6.2 Plimit and Pmax measurement results

The measured Plimit for all the selected radio configurations given in Table 5-2 are listed in below Table6-1. Pmax was also measured for radio configurations selected for testing time-varying Tx power transmission scenarios in order to generate test sequences following the test procedures in Section 4.1.

Table 6-1: Measured Plimit and Pmax of selected radio configurations

Test case #	Test scenario	Tech	Band	Ant	DSI	Channel	Freq (MHz)	BW	RB size	RB offset	mode	position	Position details	measured plimit (dBm)	measured pmax (dBm)	Plimit EFS setting (dBm)	Target pmax (dBm)	
1	time-varying Tx power transmission	GSM	1900	2	2	661	1880	\	\	\	3TX	Top	0mm	24.91	25.88	24.70	25.70	
2		GSM	1900	2	14	661	1880	\	\	\	1TX	Top	10mm	20.98	30.79	20.00	30.50	
3		WCDMA	1700	2	1	1312	1712.4	\	\	\	RMC	Top	11mm	24.08	25.25	23.50	24.50	
4		WCDMA	1700	2	14	1412	1732.4	\	\	\	RMC	Front	0mm	13.11	25.25	12.50	24.50	
5		LTE	B41(PC2)	2	1	41490	2680	20M	1	0	0	QPSK	Top	11mm	25.88	26.39	25.20	26.20
6		LTE	7	2	14	20850	2510	20M	50	0	0	QPSK	Top	0mm	10.42	25.28	9.70	24.70
7		Sub6 NR	N77-L	0	5	633334	3500.01	10M	12	6	6	DFT-OFDM QPSK	Left Cheek	0mm	24.24	25.57	24.00	25.50
8		Sub6 NR	N77-L	7	14	636332	3544.98	10M	12	6	6	DFT-OFDM QPSK	Top	0mm	6.02	23.33	5.80	23.30
9	Call Drop	WCDMA	1700	2	1	1312	1712.4	\	\	\	RMC	Top	11mm	24.08	25.25	23.50	24.50	
10	band switch	WCDMA	1700	2	1	1312	1712.4	\	\	\	RMC	Top	11mm	24.08	25.25	23.50	24.50	
		LTE	B7	2	1	21100	2535	20M	1	99	0	QPSK	Top	11mm	21.22	24.91	21.20	24.70
11	Change In DSI	WCDMA	1700	2	1	1312	1712.4	\	\	\	RMC	Top	11mm	24.08	25.25	23.50	24.50	
		WCDMA	1700	2	14	1412	1732.4	\	\	\	RMC	Front	0mm	13.11	25.25	12.50	24.50	
12	SARreSAR	LTE	B2	2	5	19100	1900	20M	50	50	0	QPSK	Right Tilt	0mm	22.54	24.71	22.50	24.50
		Sub6 NR	N77-L	0	5	633334	3500.01	10M	12	6	6	DFT-OFDM QPSK	Left Cheek	0mm	24.24	25.73	24.00	25.50
13	Antenna switch	WCDMA	1700	2	1	1312	1712.4	\	\	\	RMC	Top	11mm	24.08	25.25	23.50	24.50	
		WCDMA	1700	3	11	1412	1732.4	\	\	\	RMC	Front	0mm	14.68	24.09	15.00	24.00	
14	Window switch	Sub6 NR	N41	2	5	537000	2685	10M	12	6	6	DFT-OFDM QPSK	Right Tilt	0mm	19.08	27.26	18.00	26.50
		Sub6 NR	N77-L	2	5	633334	3500.01	10M	12	6	6	DFT-OFDM QPSK	Right Tilt	0mm	22.54	26.79	22.50	26.50

Total uncertainty	Uncertainty dB 2G	Uncertainty dB 3/4G	Uncertainty dB NR
	1	0.8	1.2

Note: the device uncertainty of P_{max} is provided by manufacturer

6.3 Time-varying Tx power measurement results

The measurement setup is shown in Figures 6-1(a) and 6-1(c). The purpose of the time-varying Tx power measurement is to demonstrate the effectiveness of power limiting enforcement and that the time- averaged Tx power when represented in time-averaged 1g SAR or 1g SAR values does not exceed FCC limit as shown in Eq. (1a) and (1b), rewritten below:

$$1g_or_10gSAR(t) = \frac{conducted_Tx_power(t)}{conducted_Tx_power_P_{limit}} * 1g_or_10gSAR_P_{limit} \quad (1a)$$

$$\frac{\frac{1}{T_{SAR}} \int_{t-T_{SAR}}^t 1g_or_10gSAR(t) dt}{FCC\ SAR\ limit} \leq 1 \quad (1b)$$

where, *conducted_Tx_power(t)*, *conducted_Tx_power_Plimit*, and *1g_or_10gSAR_Plimit* correspond to the measured instantaneous conducted Tx power, measured conducted Tx power at P_{limit}, and measured 1g SAR and 1g SAR values at P_{limit} reported in Part 1 test (listed in Table 5-2 of this report as well).

Following the test procedure in Section 4.3, the conducted Tx power measurement for all selected configurations are reported in this section. In all the conducted Tx power plots, the dotted line represents the requested power by callbox (test sequence 1 or test sequence 2), the blue curve represents the instantaneous conducted Tx power measured using power meter, the green curve represents time- averaged power and red line represents the conducted power limit that corresponds to FCC limit of 1.6 W/kg for 1g SAR or 1.6 W/kg for 1g SAR .

Similarly, in all the 1g or 1g SAR plots (when converted using Eq. (1a)), the green curve represents the 100s/60s-time averaged 1g SAR or 1g SAR value calculated based on instantaneous 1g SAR or 1g SAR ; and the red line limit represents the FCC limit of 1.6 W/kg for 1g SAR or 1.6 W/kg for 1g SAR .

6.3.1 GSM1900 (Test case 1)

Test result for test sequence 1:

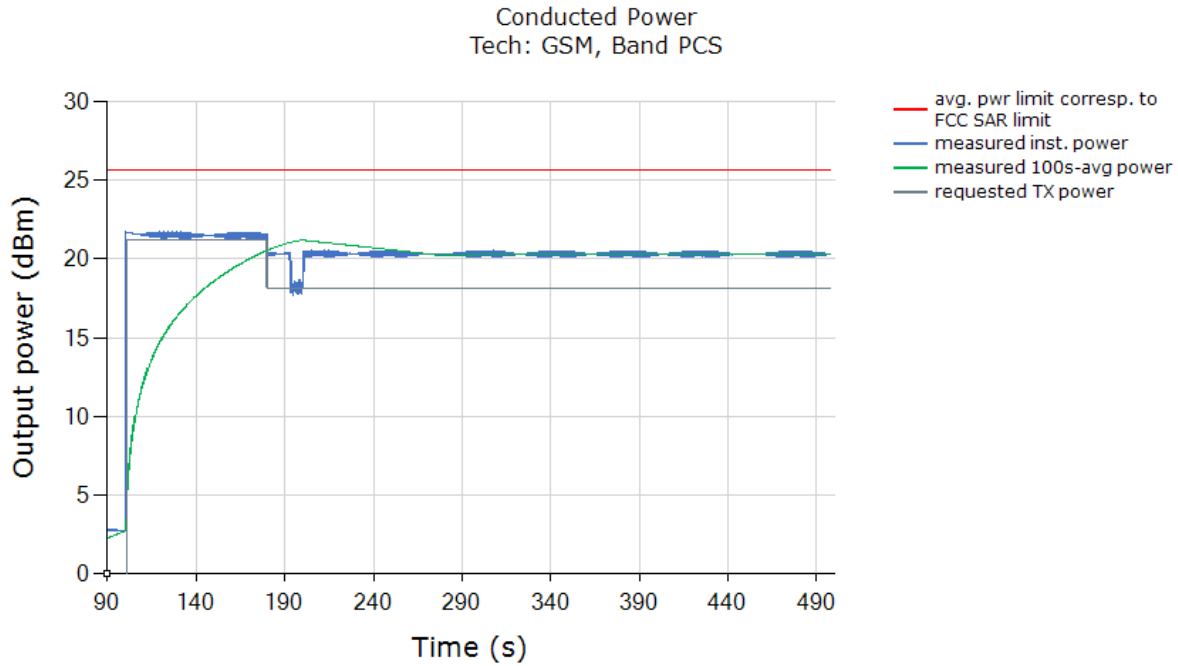

Above time-averaged conducted Tx power is converted/calculated into time-averaged 1g SAR using Equation (1a) and plotted below to demonstrate that the time-averaged 1g SAR versus time does not exceed the FCC limit of 1.6 W/kg for 1gSAR:

SAR
Tech: GSM, Band PCS

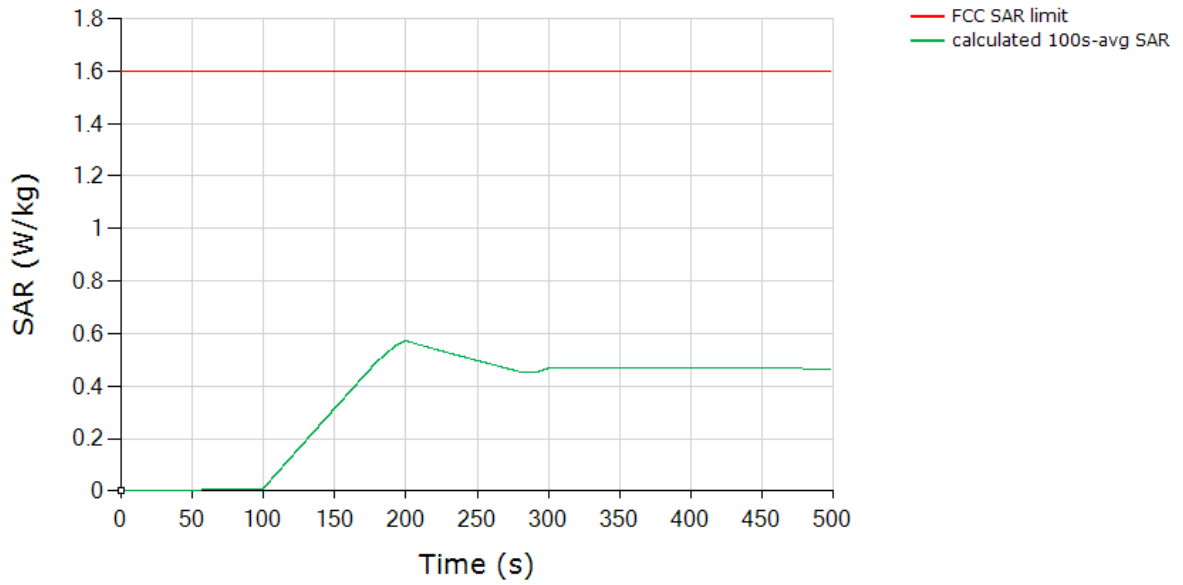

	(W/kg)
FCC 1gSAR limit	1.6
Max 100s-time averaged 1gSAR (green curve)	0.573
Validated: Max time averaged SAR (green curve) is within device uncertainty of measured SAR at Plimit	

Test result for test sequence 2:

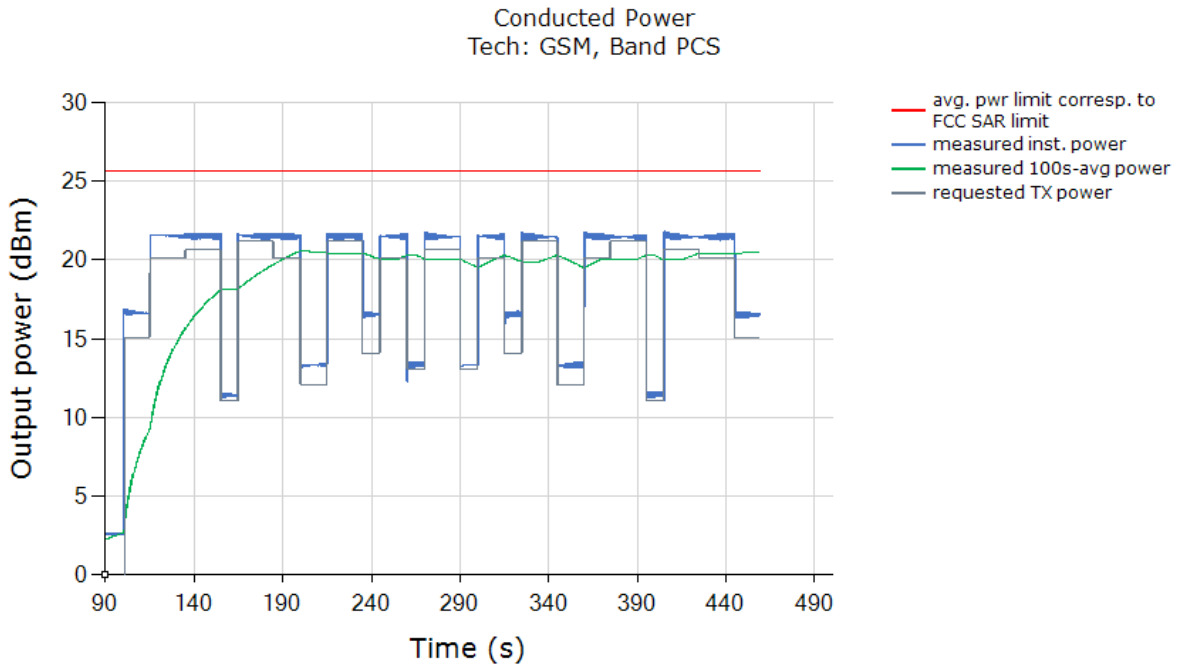

Above time-averaged conducted Tx power is converted/calculated into time-averaged 1g SAR using Equation (1a) and plotted below to demonstrate that the time-averaged 1g SAR versus time does not exceed the FCC limit of 1.6 W/kg for 1gSAR:

SAR
Tech: GSM, Band PCS

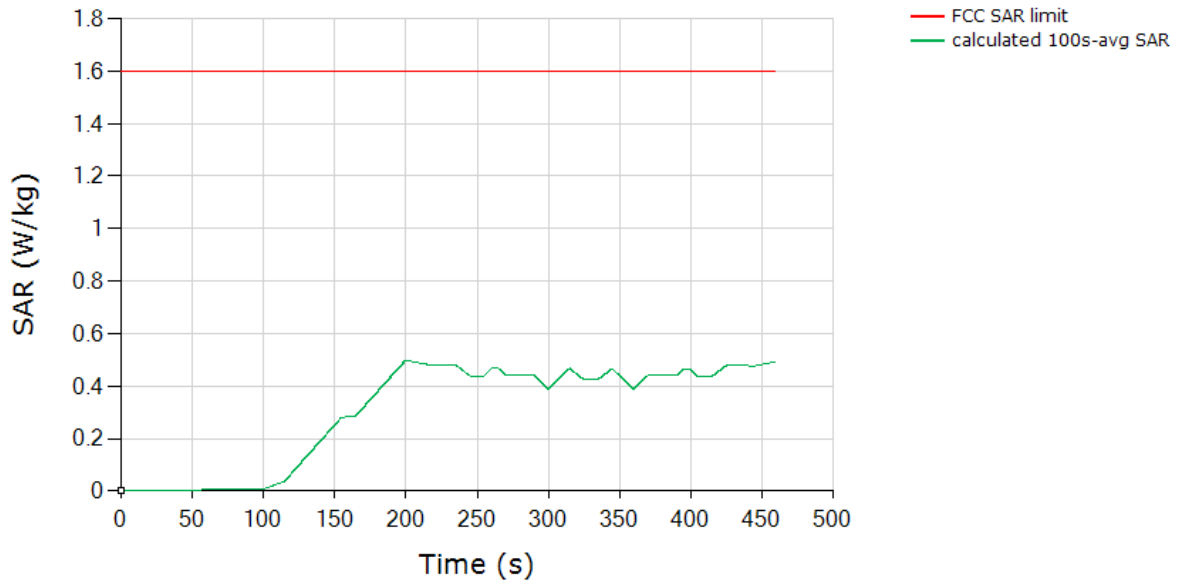

	(W/kg)
FCC 1gSAR limit	1.6
Max 100s-time averaged 1gSAR (green curve)	0.498
Validated: Max time averaged SAR (green curve) is within device uncertainty of measured SAR at Plimit	

6.3.2 GSM1900 (Test case 2)

Test result for test sequence 1:

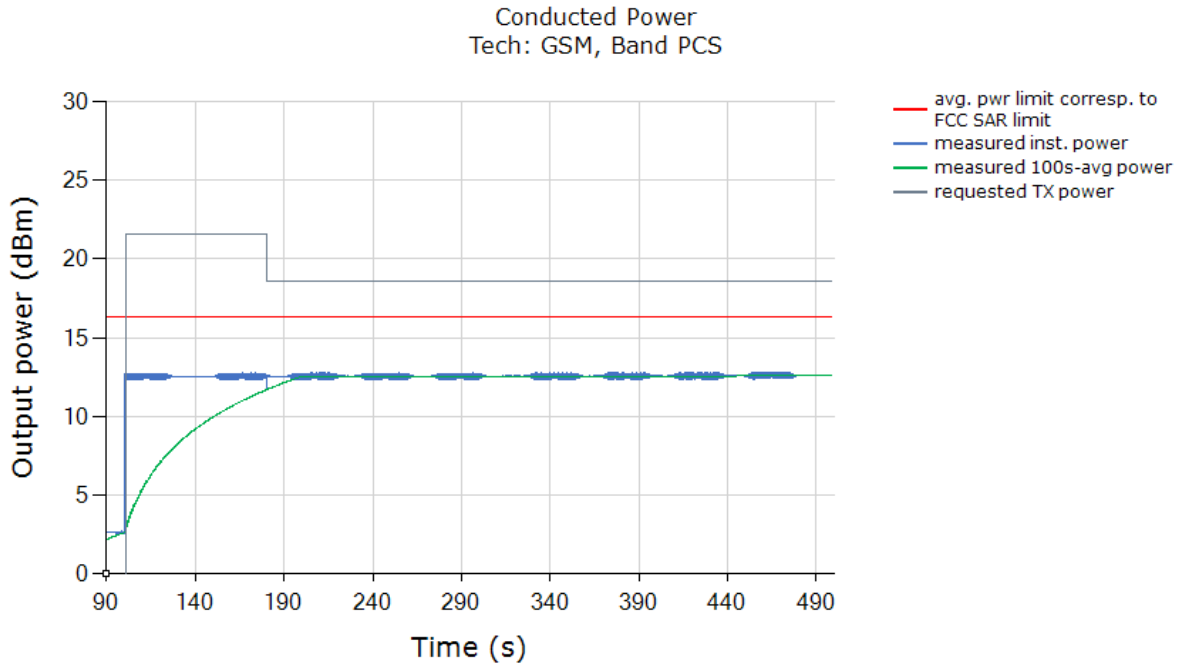

Above time-averaged conducted Tx power is converted/calculated into time-averaged 1g SAR using Equation (1a) and plotted below to demonstrate that the time-averaged 1g SAR versus time does not exceed the FCC limit of 1.6 W/kg for 1gSAR:

SAR
Tech: GSM, Band PCS

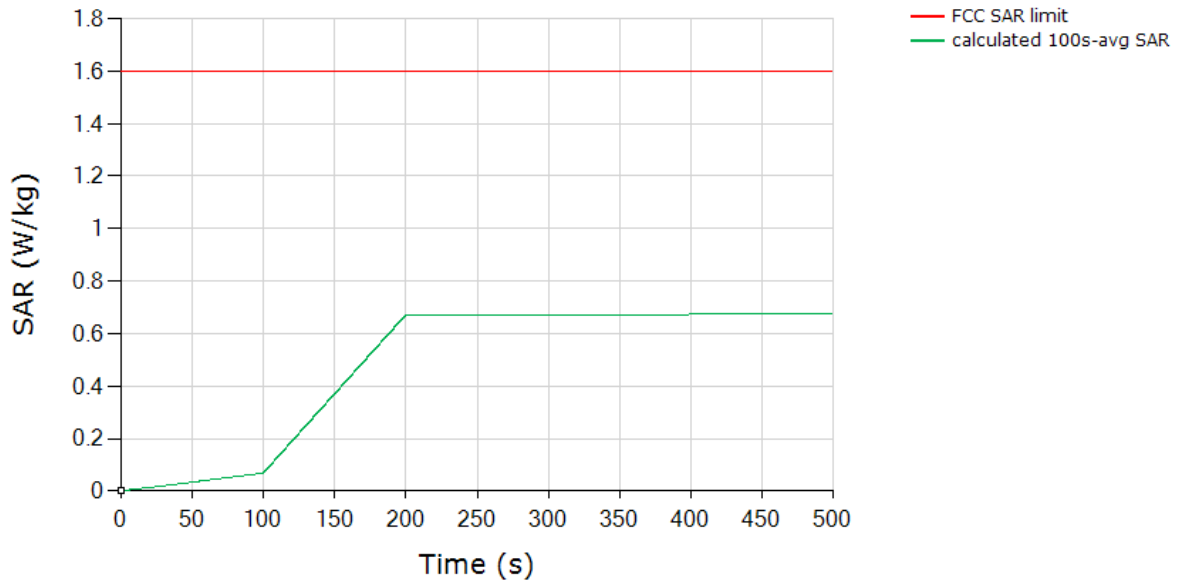

	(W/kg)
FCC 1gSAR limit	1.6
Max 100s-time averaged 1gSAR (green curve)	0.675
Validated: Max time averaged SAR (green curve) is within device uncertainty of measured SAR at Plimit	

Test result for test sequence 2:

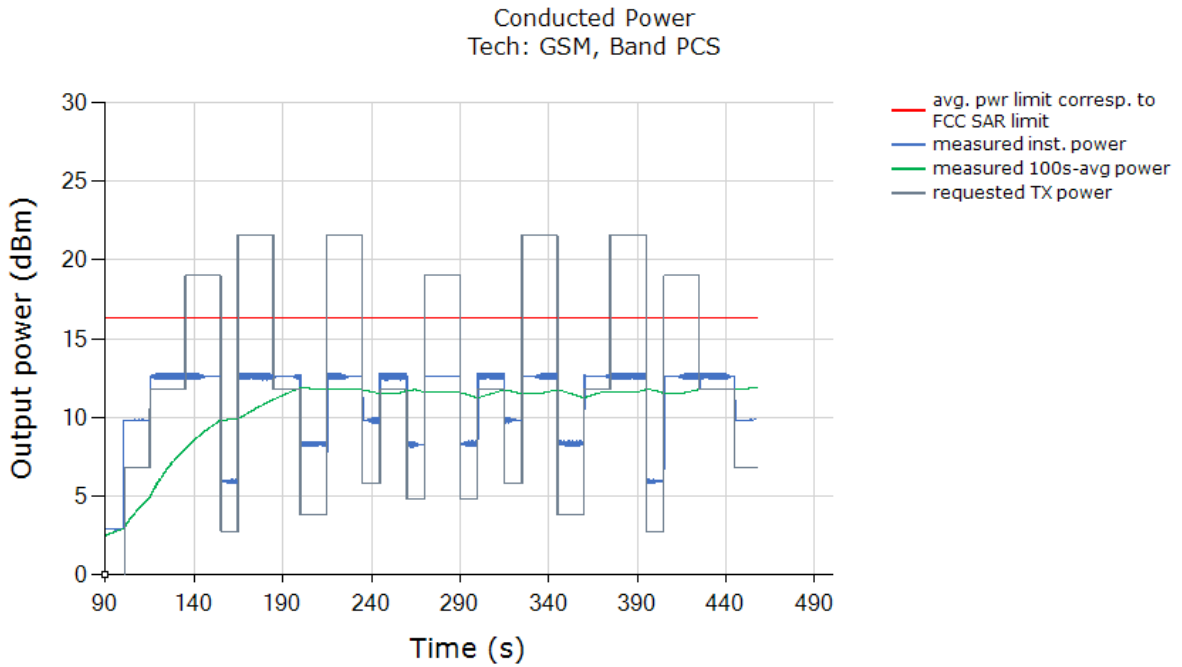

Above time-averaged conducted Tx power is converted/calculated into time-averaged 1g SAR using Equation (1a) and plotted below to demonstrate that the time-averaged 1g SAR versus time does not exceed the FCC limit of 1.6 W/kg for 1gSAR:

SAR
Tech: GSM, Band PCS

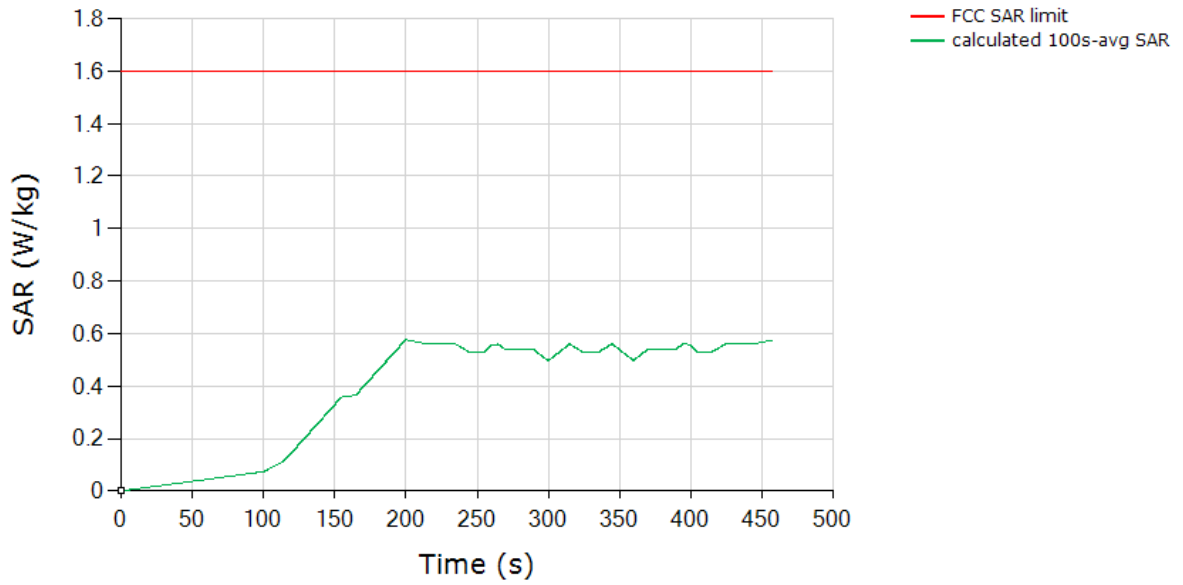

	(W/kg)
FCC 1gSAR limit	1.6
Max 100s-time averaged 1gSAR (green curve)	0.576
Validated: Max time averaged SAR (green curve) is within device uncertainty of measured SAR at Plimit	

6.3.3 WCDMA1700 (Test case 3)

Test result for test sequence 1:

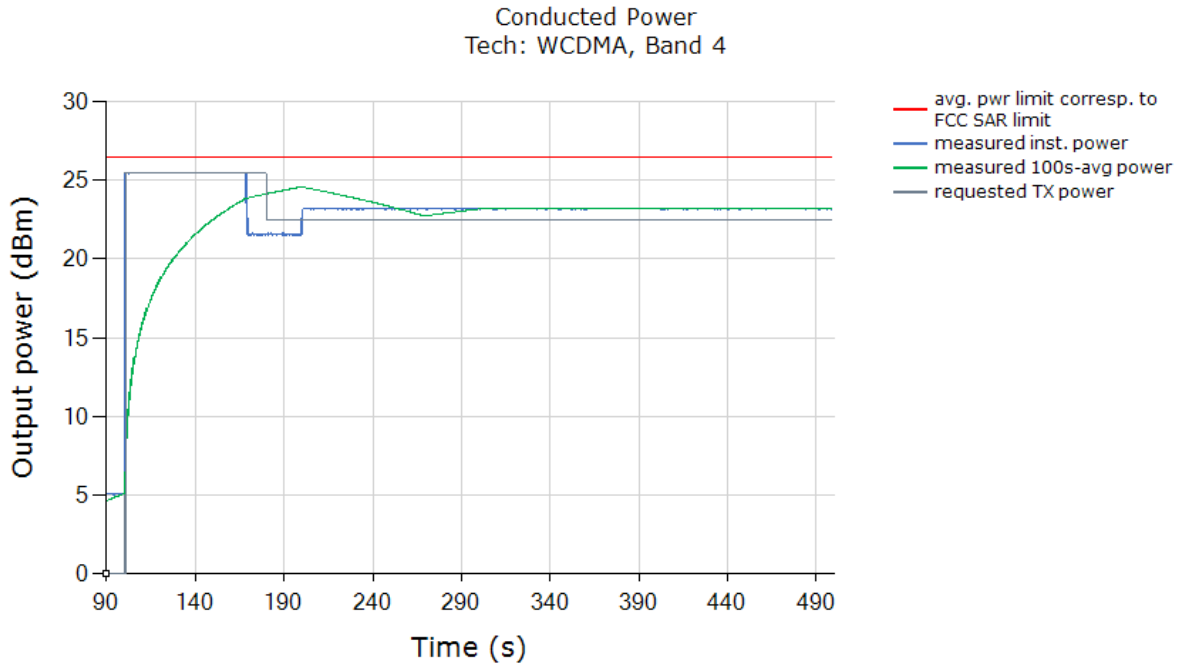

Above time-averaged conducted Tx power is converted/calculated into time-averaged 1g SAR using Equation (1a) and plotted below to demonstrate that the time-averaged 1g SAR versus time does not exceed the FCC limit of 1.6 W/kg for 1gSAR:

SAR
Tech: WCDMA, Band 4

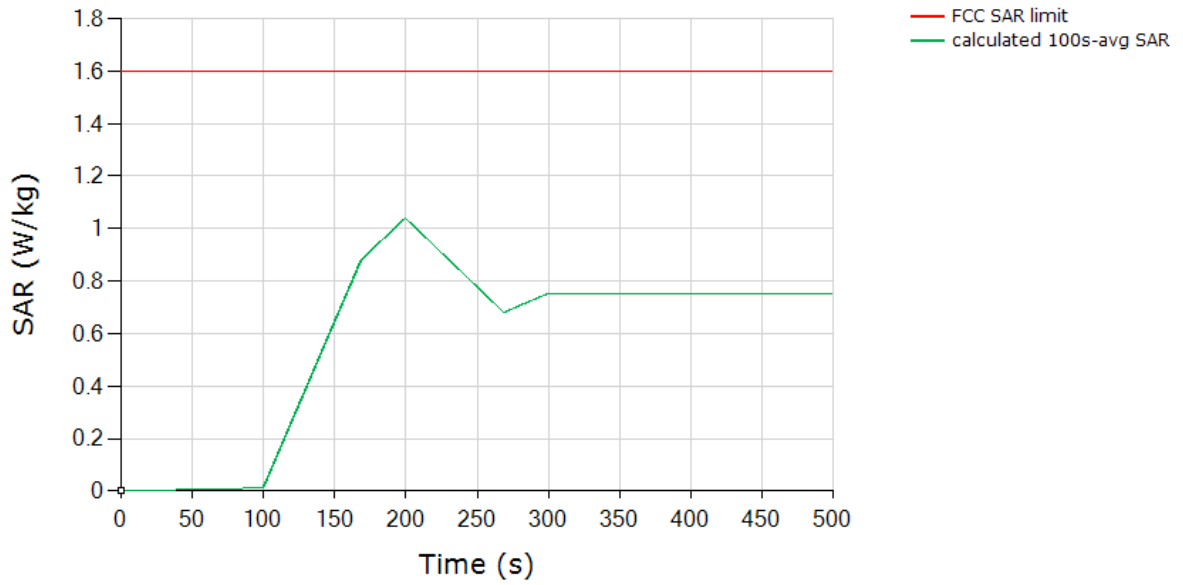

	(W/kg)
FCC 1gSAR limit	1.6
Max 100s-time averaged 1gSAR (green curve)	1.039
Validated: Max time averaged SAR (green curve) is within device uncertainty of measured SAR at Plimit	

Test result for test sequence 2:

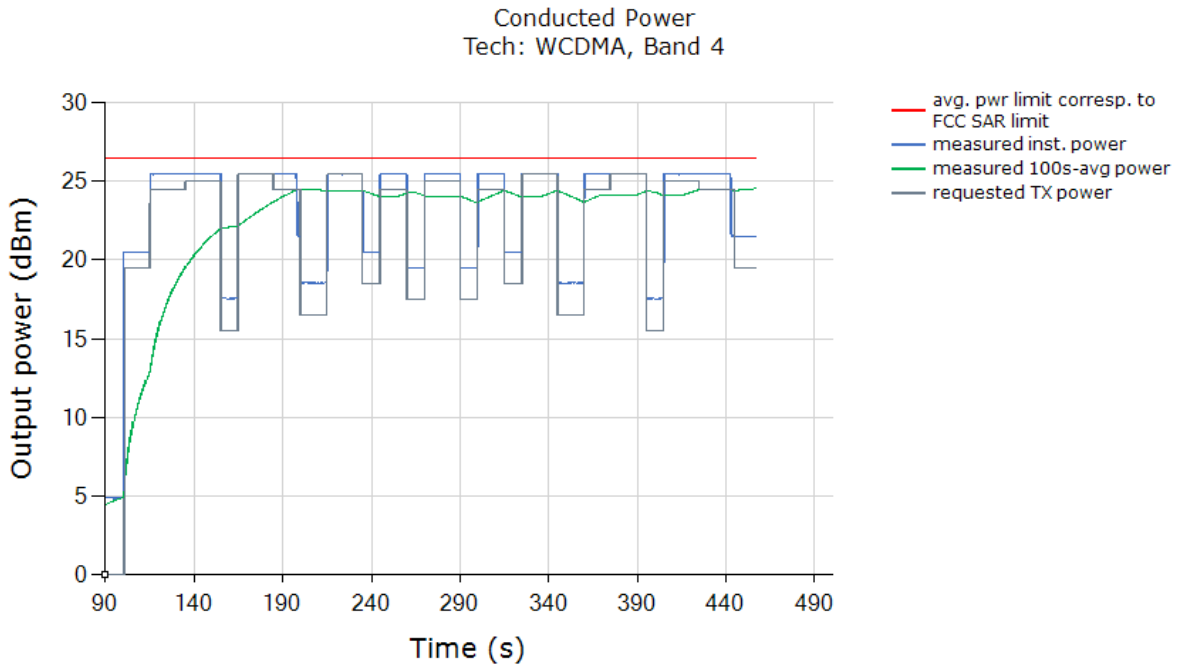

Above time-averaged conducted Tx power is converted/calculated into time-averaged 1g SAR using Equation (1a) and plotted below to demonstrate that the time-averaged 1g SAR versus time does not exceed the FCC limit of 1.6 W/kg for 1gSAR:

SAR
Tech: WCDMA, Band 4

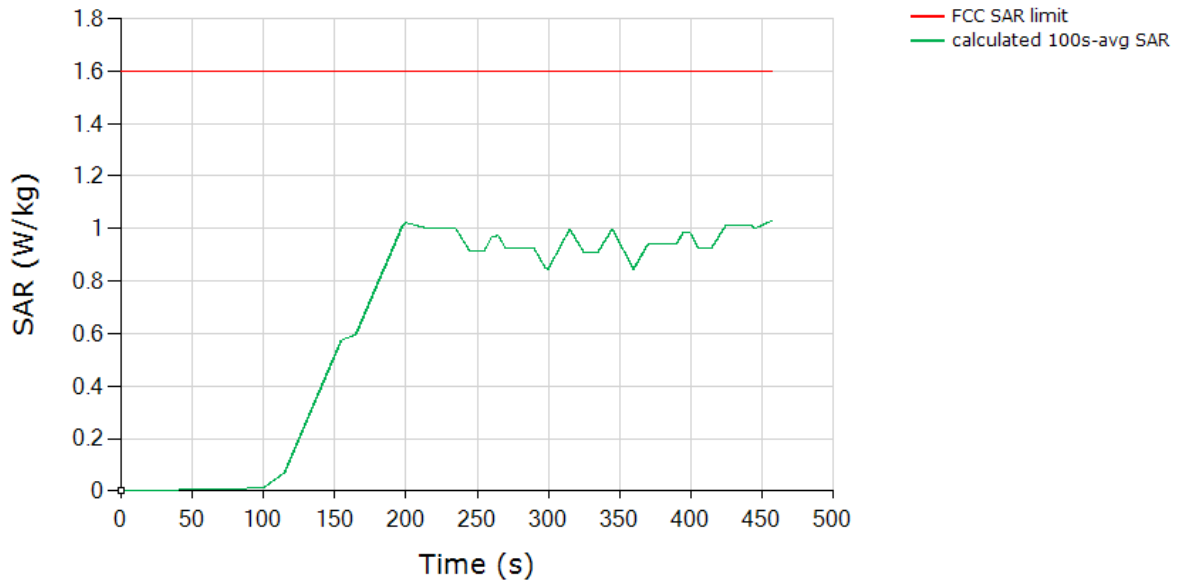

	(W/kg)
FCC 1gSAR limit	1.6
Max 100s-time averaged 1gSAR (green curve)	1.03
Validated: Max time averaged SAR (green curve) is within device uncertainty of measured SAR at Plimit	

6.3.4 WCDMA1700 (Test case 4)

Test result for test sequence 1:

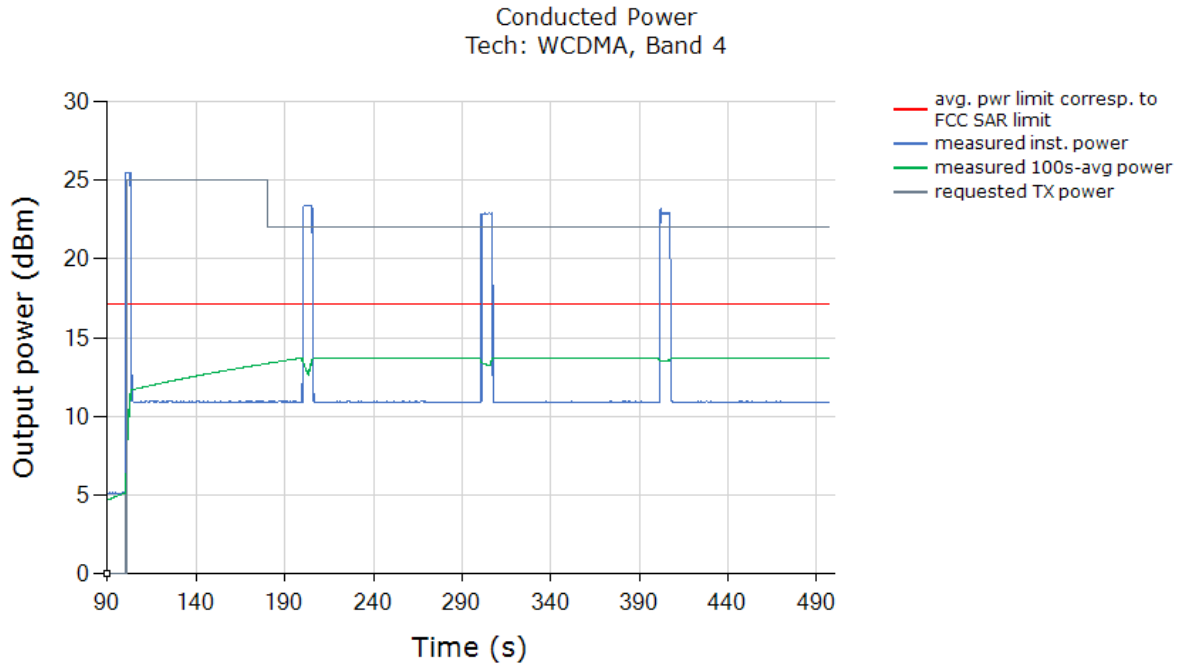

Above time-averaged conducted Tx power is converted/calculated into time-averaged 1g SAR using Equation (1a) and plotted below to demonstrate that the time-averaged 1g SAR versus time does not exceed the FCC limit of 1.6 W/kg for 1gSAR:

SAR
Tech: WCDMA, Band 4

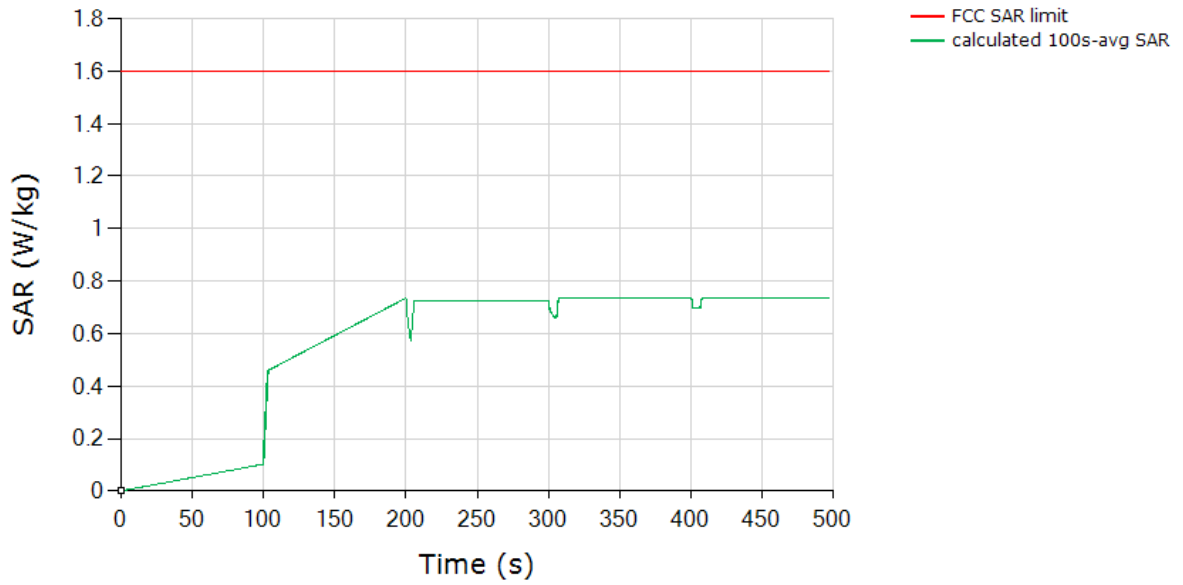

	(W/kg)
FCC 1gSAR limit	1.6
Max 100s-time averaged 1gSAR (green curve)	0.734
Validated: Max time averaged SAR (green curve) is within device uncertainty of measured SAR at Plimit	

Test result for test sequence 2:

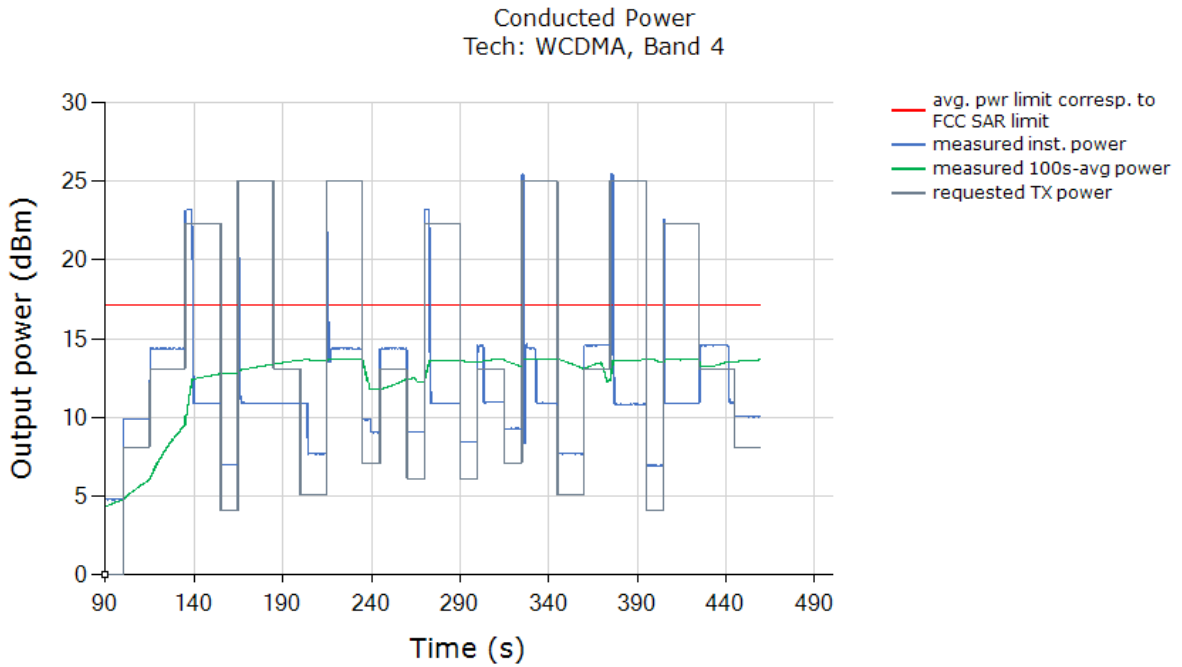

Above time-averaged conducted Tx power is converted/calculated into time-averaged 1g SAR using Equation (1a) and plotted below to demonstrate that the time-averaged 1g SAR versus time does not exceed the FCC limit of 1.6 W/kg for 1gSAR:

SAR
Tech: WCDMA, Band 4

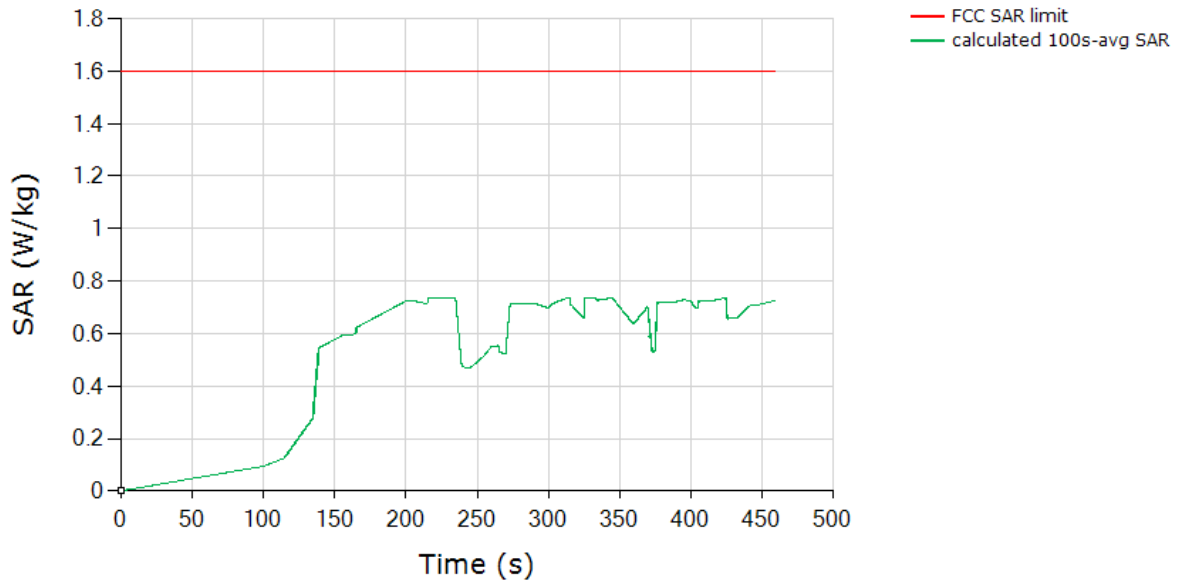

	(W/kg)
FCC 1gSAR limit	1.6
Max 100s-time averaged 1gSAR (green curve)	0.738
Validated: Max time averaged SAR (green curve) is within device uncertainty of measured SAR at Plimit	

6.3.5 LTE B41 PC2 (Test case 5)

Test result for test sequence 1:

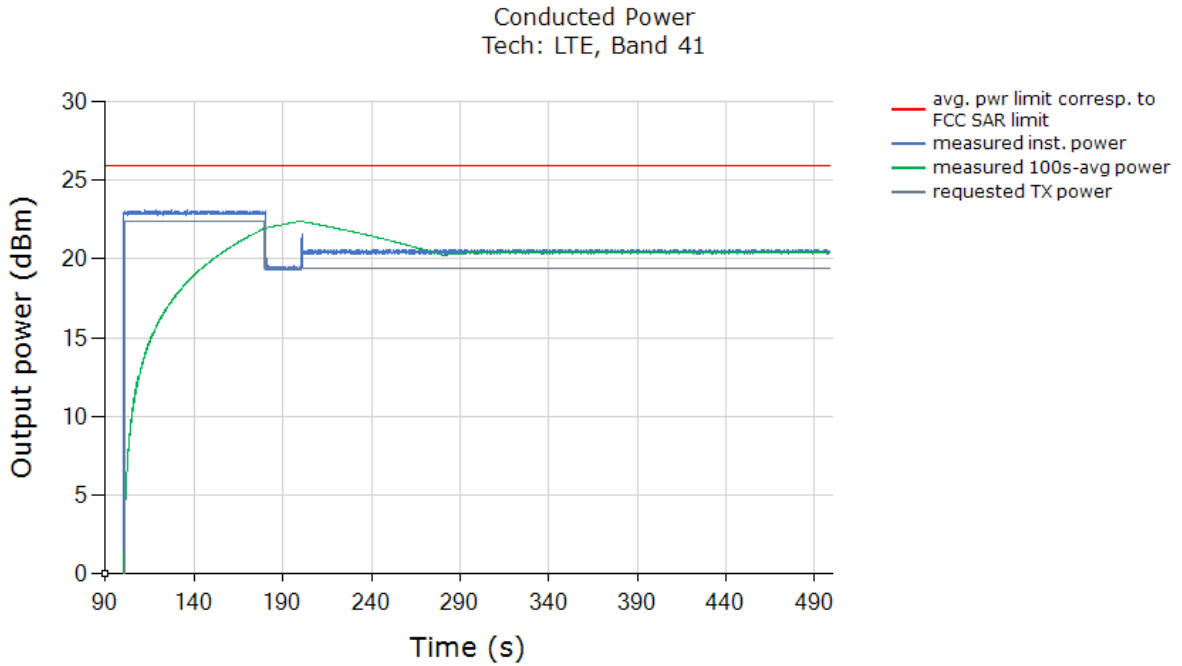

Above time-averaged conducted Tx power is converted/calculated into time-averaged 1g SAR using Equation (1a) and plotted below to demonstrate that the time-averaged 1g SAR versus time does not exceed the FCC limit of 1.6 W/kg for 1gSAR:

SAR
Tech: LTE, Band 41

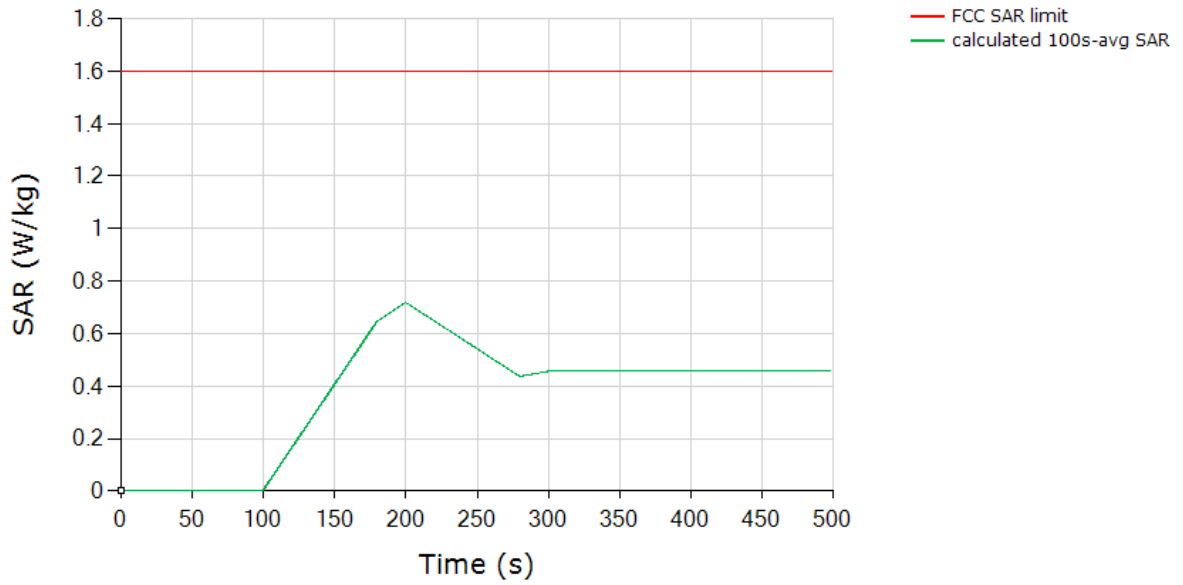

	(W/kg)
FCC 1gSAR limit	1.6
Max 100s-time averaged 1gSAR (green curve)	0.718
Validated: Max time averaged SAR (green curve) is within device uncertainty of measured SAR at Plimit	

Test result for test sequence 2:

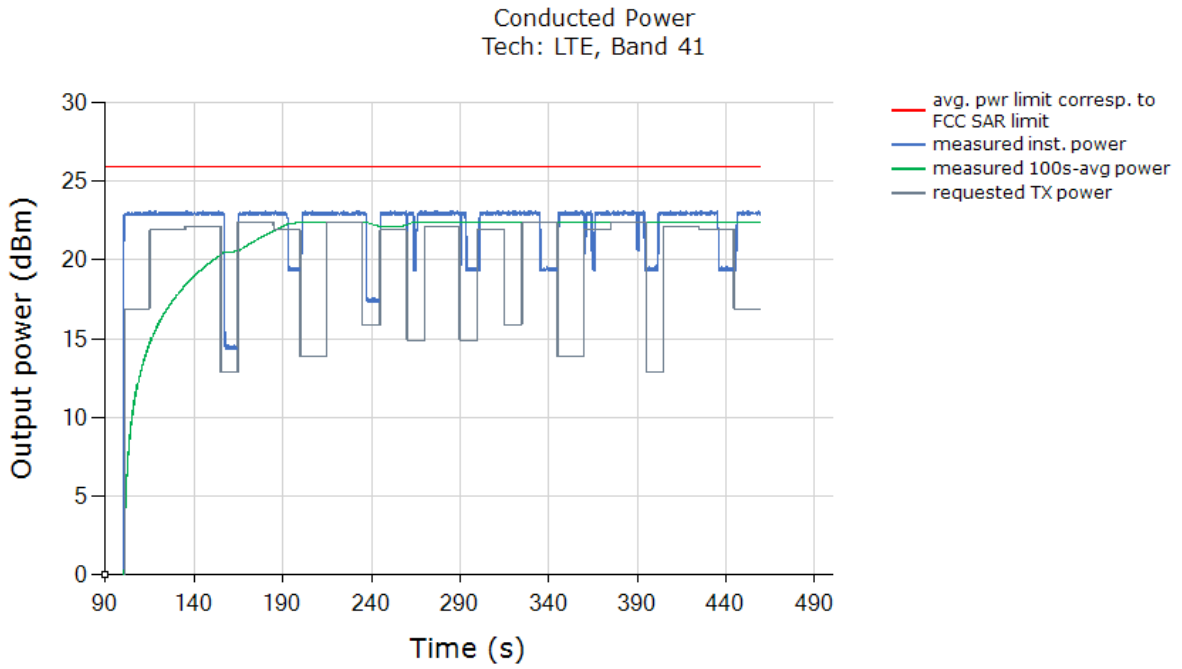

Above time-averaged conducted Tx power is converted/calculated into time-averaged 1g SAR using Equation (1a) and plotted below to demonstrate that the time-averaged 1g SAR versus time does not exceed the FCC limit of 1.6 W/kg for 1gSAR:

SAR
Tech: LTE, Band 41

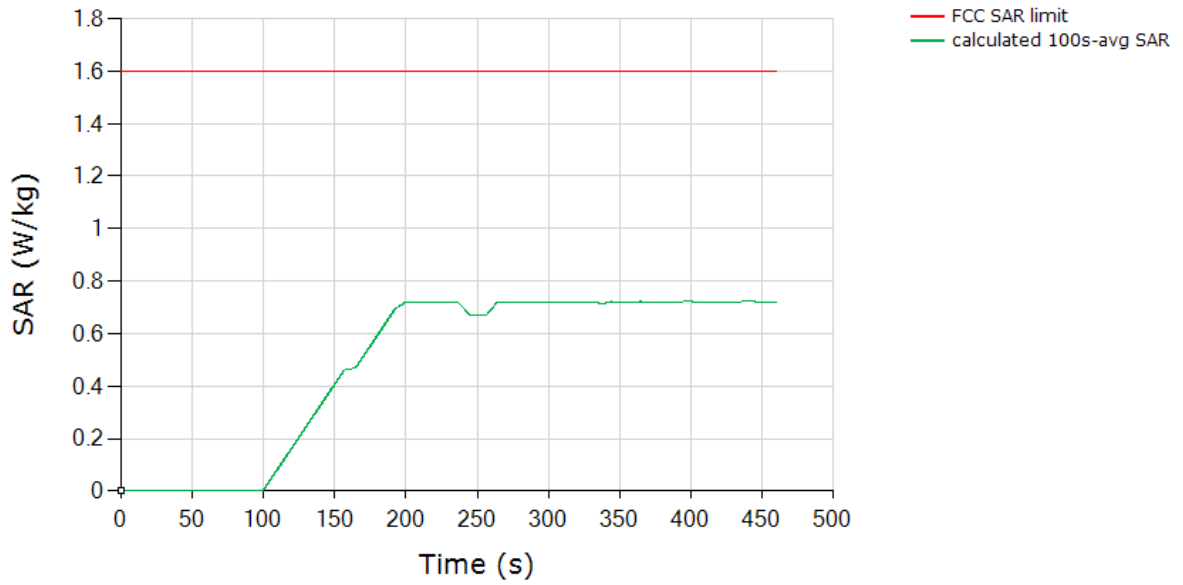

	(W/kg)
FCC 1gSAR limit	1.6
Max 100s-time averaged 1gSAR (green curve)	0.722
Validated: Max time averaged SAR (green curve) is within device uncertainty of measured SAR at Plimit	

6.3.6 LTE B7 (Test case 6)

Test result for test sequence 1:

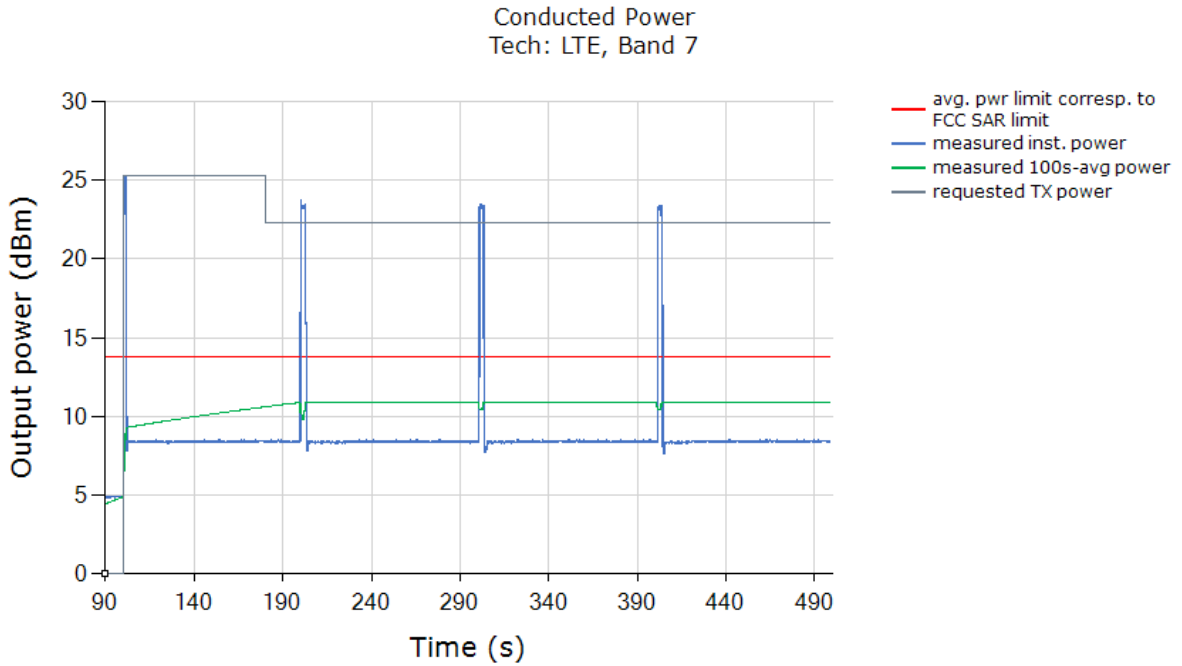

Above time-averaged conducted Tx power is converted/calculated into time-averaged 1g SAR using Equation (1a) and plotted below to demonstrate that the time-averaged 1g SAR versus time does not exceed the FCC limit of 1.6 W/kg for 1gSAR:

SAR
Tech: LTE, Band 7

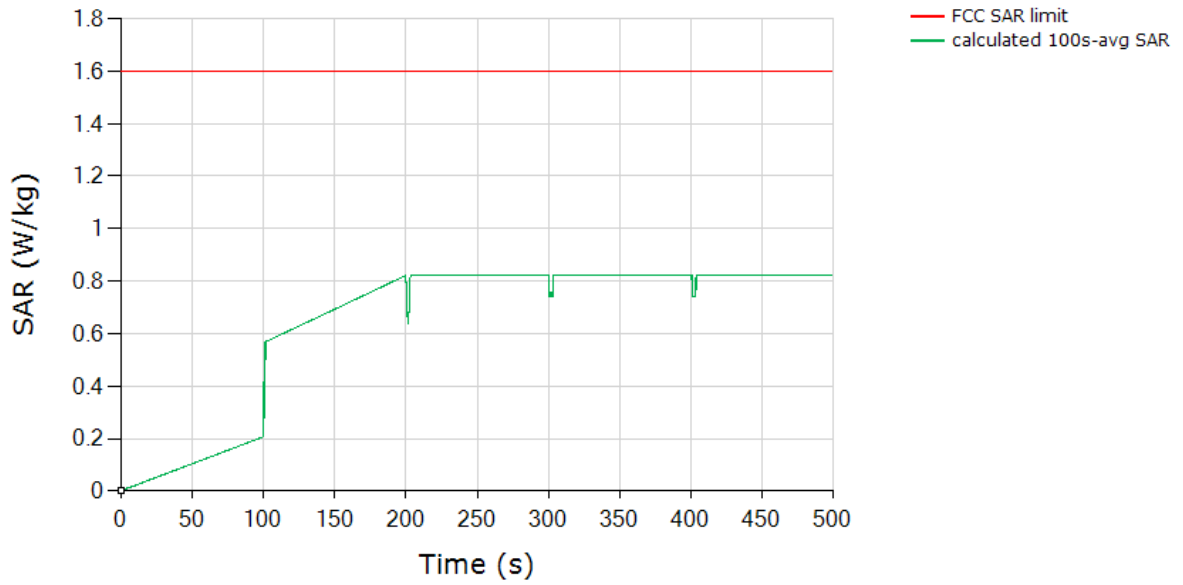

	(W/kg)
FCC 1gSAR limit	1.6
Max 100s-time averaged 1gSAR (green curve)	0.824
Validated: Max time averaged SAR (green curve) is within device uncertainty of measured SAR at Plimit	

Test result for test sequence 2:

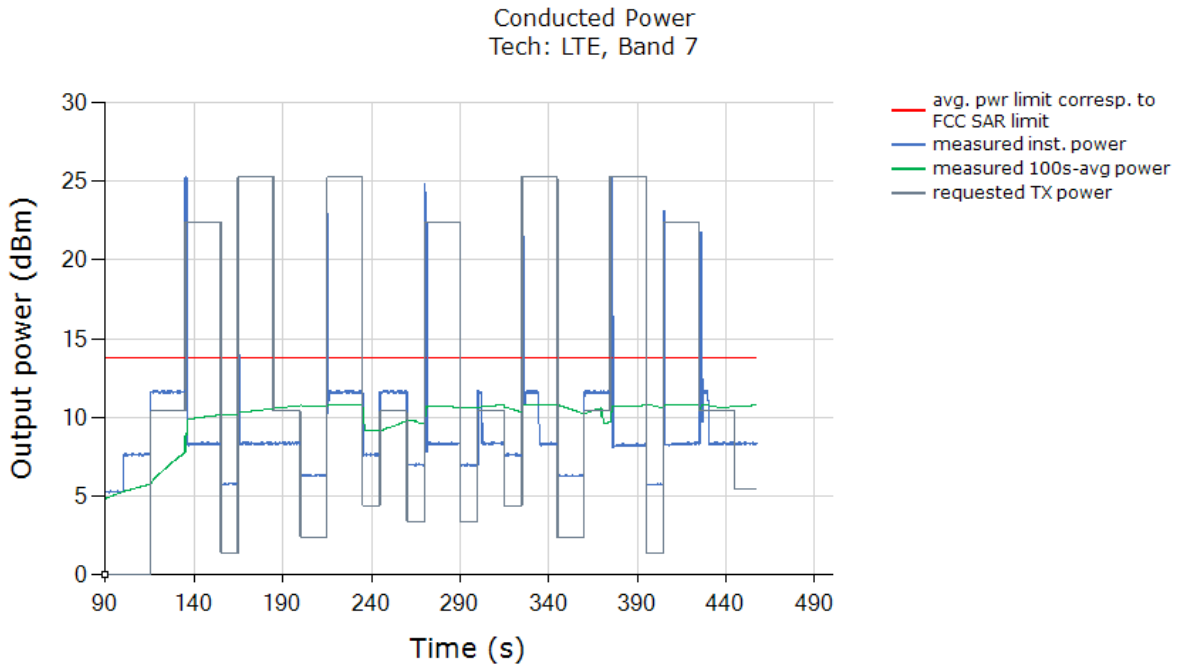

Above time-averaged conducted Tx power is converted/calculated into time-averaged 1g SAR using Equation (1a) and plotted below to demonstrate that the time-averaged 1g SAR versus time does not exceed the FCC limit of 1.6 W/kg for 1gSAR:

SAR
Tech: LTE, Band 7

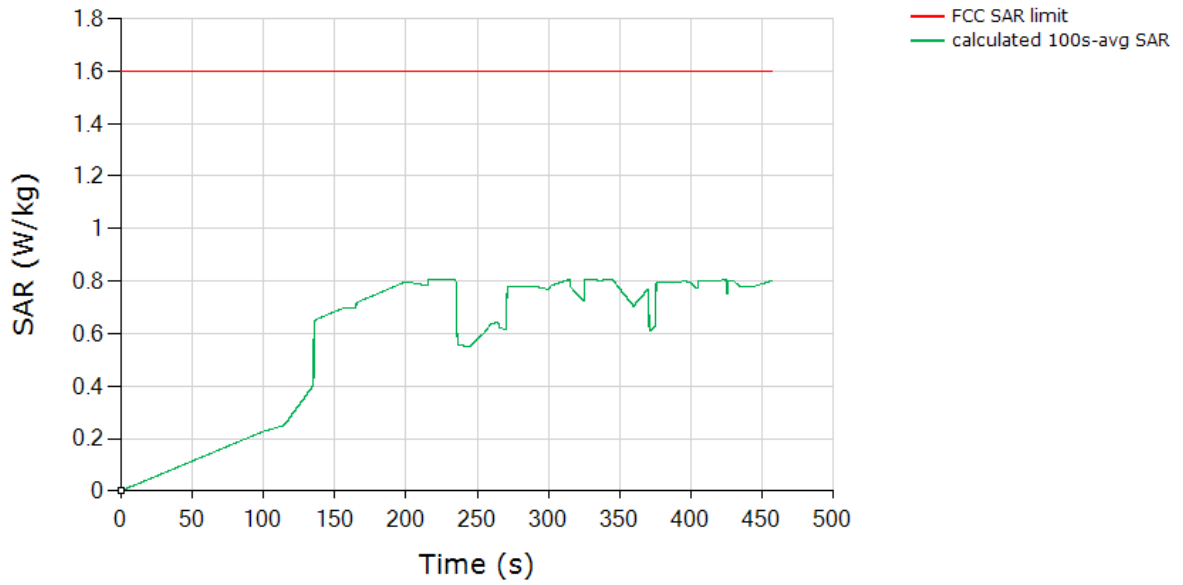

	(W/kg)
FCC 1gSAR limit	1.6
Max 100s-time averaged 1gSAR (green curve)	0.807
Validated: Max time averaged SAR (green curve) is within device uncertainty of measured SAR at Plimit	

6.3.7 SUB6G N77 (Test case 7)

Test result for test sequence 1:

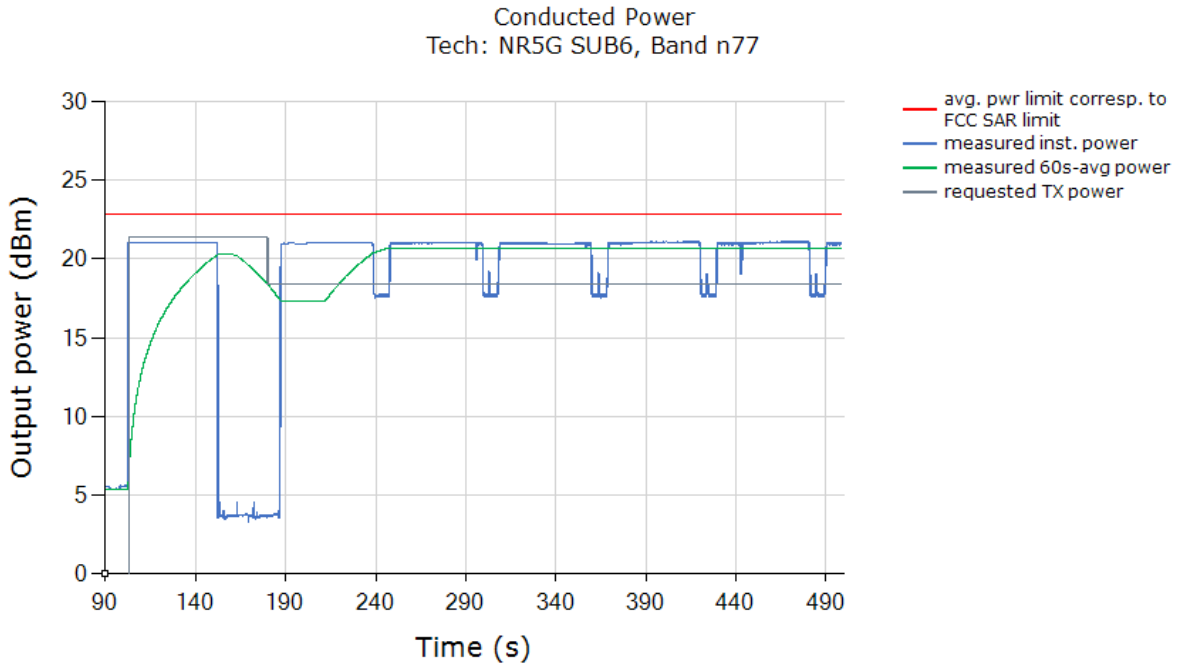

Above time-averaged conducted Tx power is converted/calculated into time-averaged 1g SAR using Equation (1a) and plotted below to demonstrate that the time-averaged 1g SAR versus time does not exceed the FCC limit of 1.6 W/kg for 1gSAR:

SAR
Tech: NR5G SUB6, Band n77

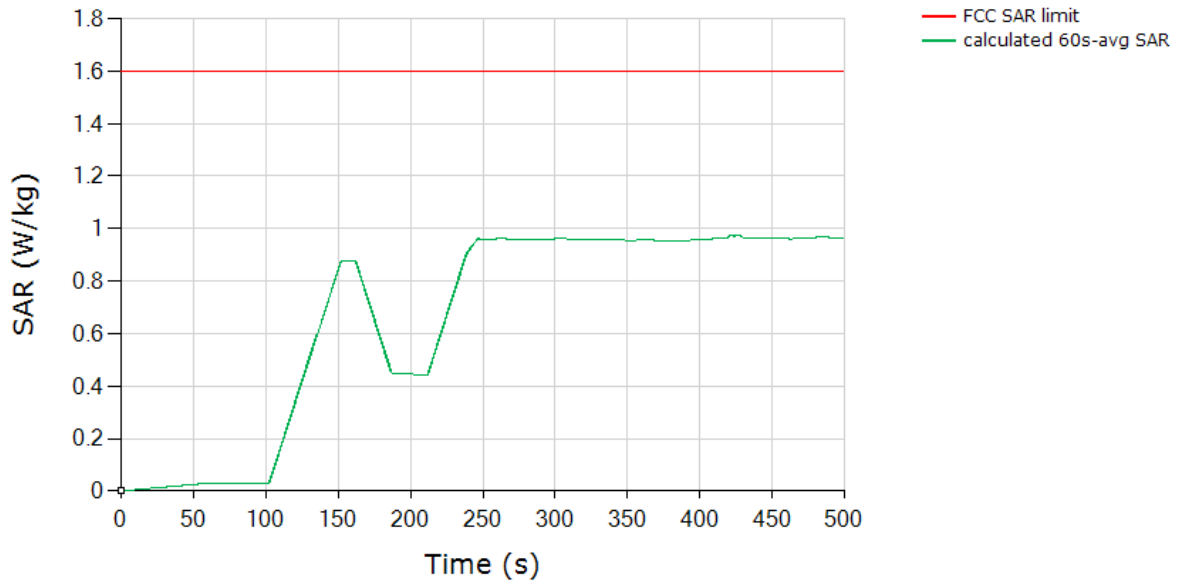

	(W/kg)
FCC 1gSAR limit	1.6
Max 100s-time averaged 1gSAR (green curve)	0.971
Validated: Max time averaged SAR (green curve) is within device uncertainty of measured SAR at Plimit	

Test result for test sequence 2:

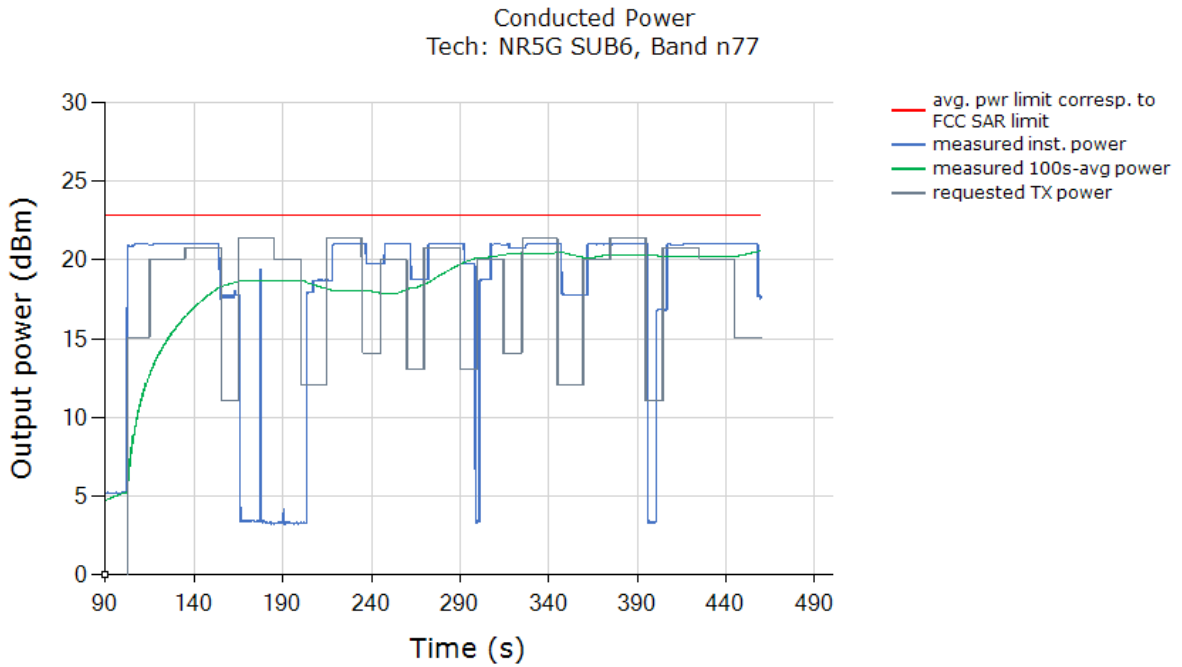

Above time-averaged conducted Tx power is converted/calculated into time-averaged 1g SAR using Equation (1a) and plotted below to demonstrate that the time-averaged 1g SAR versus time does not exceed the FCC limit of 1.6 W/kg for 1gSAR:

SAR
Tech: NR5G SUB6, Band n77

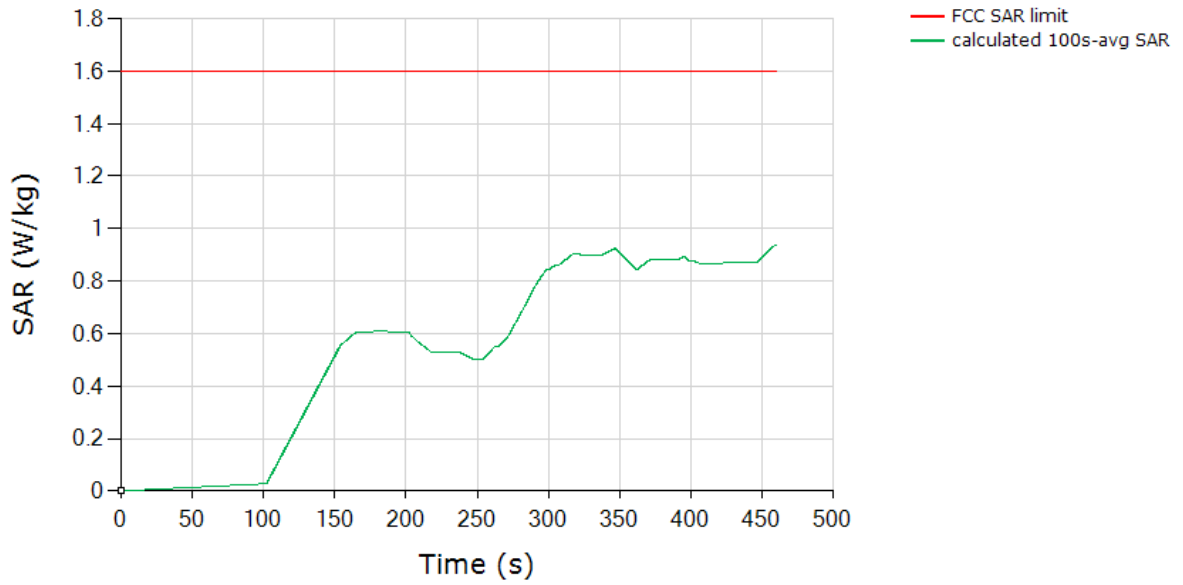

	(W/kg)
FCC 1gSAR limit	1.6
Max 100s-time averaged 1gSAR (green curve)	0.934
Validated: Max time averaged SAR (green curve) is within device uncertainty of measured SAR at Plimit	

6.3.8 SUB6G N77 (Test case 8)

Test result for test sequence 1:

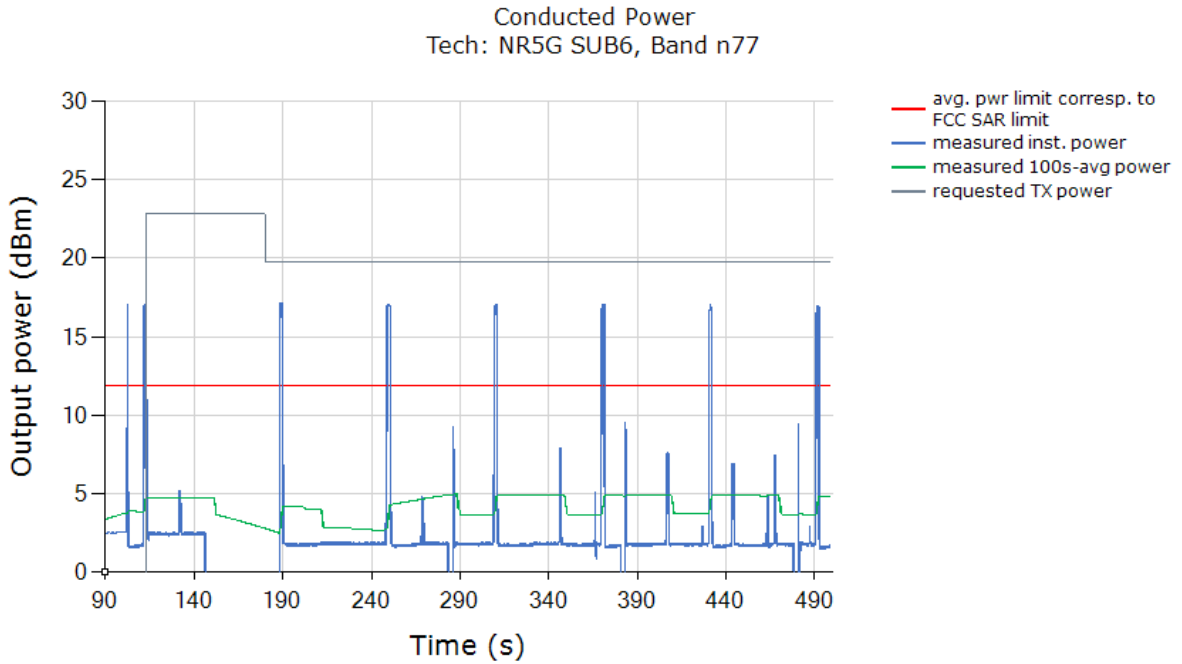

Above time-averaged conducted Tx power is converted/calculated into time-averaged 1g SAR using Equation (1a) and plotted below to demonstrate that the time-averaged 1g SAR versus time does not exceed the FCC limit of 1.6 W/kg for 1gSAR:

SAR
Tech: NR5G SUB6, Band n77

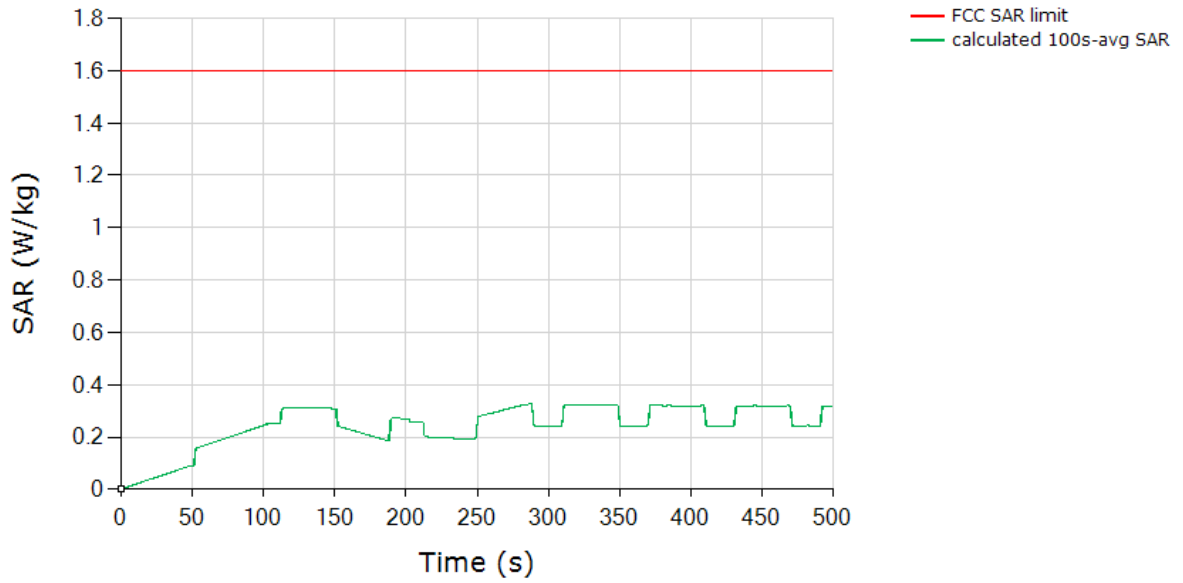

	(W/kg)
FCC 1gSAR limit	1.6
Max 60s-time averaged 1gSAR (green curve)	0.330
Validated: Max time averaged SAR (green curve) is within device uncertainty of measured SAR at Plimit	

Test result for test sequence 2:

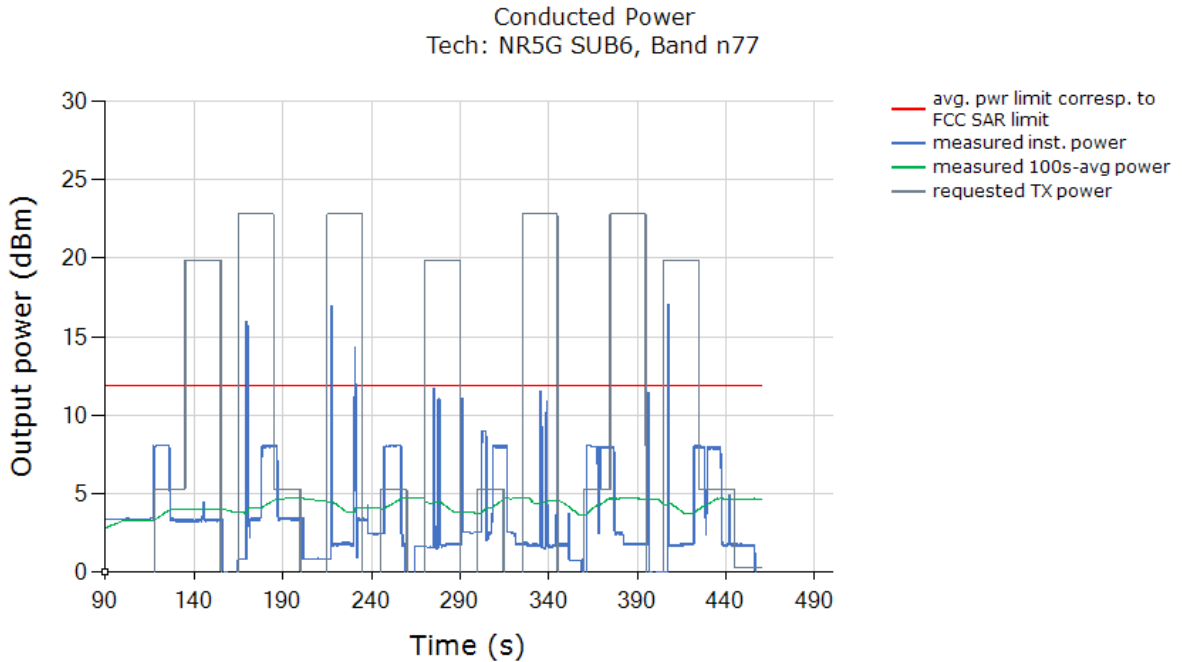

Above time-averaged conducted Tx power is converted/calculated into time-averaged 1g SAR using Equation (1a) and plotted below to demonstrate that the time-averaged 1g SAR versus time does not exceed the FCC limit of 1.6 W/kg for 1gSAR:

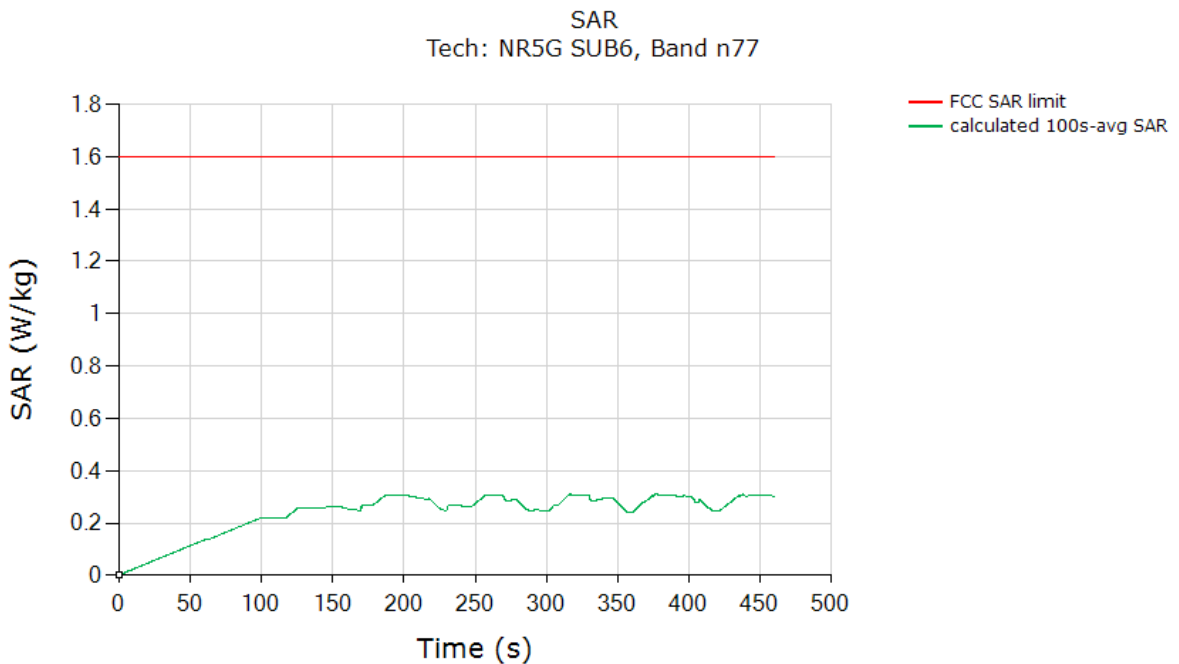



\	(W/kg)
FCC 1gSAR limit	1.6
Max 60s-time averaged 1gSAR (green curve)	0.311
Validated: Max time averaged SAR (green curve) is within device uncertainty of measured SAR at Plimit	

6.4 Change in Call Test Results (Test case 9)

This test was measured with WCDMA1700, and with callbox requesting maximum power. The call drop was manually performed when the EUT is transmitting at $P_{reserve}$ level as shown in the plot below (dotted black region). The measurement setup is shown in Figure 6-1(a) and (c). The detailed test procedure is described in Section 4.3.2.

Call drop test result:

Plot 1: Measured Tx power (dBm) versus time shows that the transmitting power kept the same $P_{reserve}$

level of WCDMA1700 after the call was re-established:

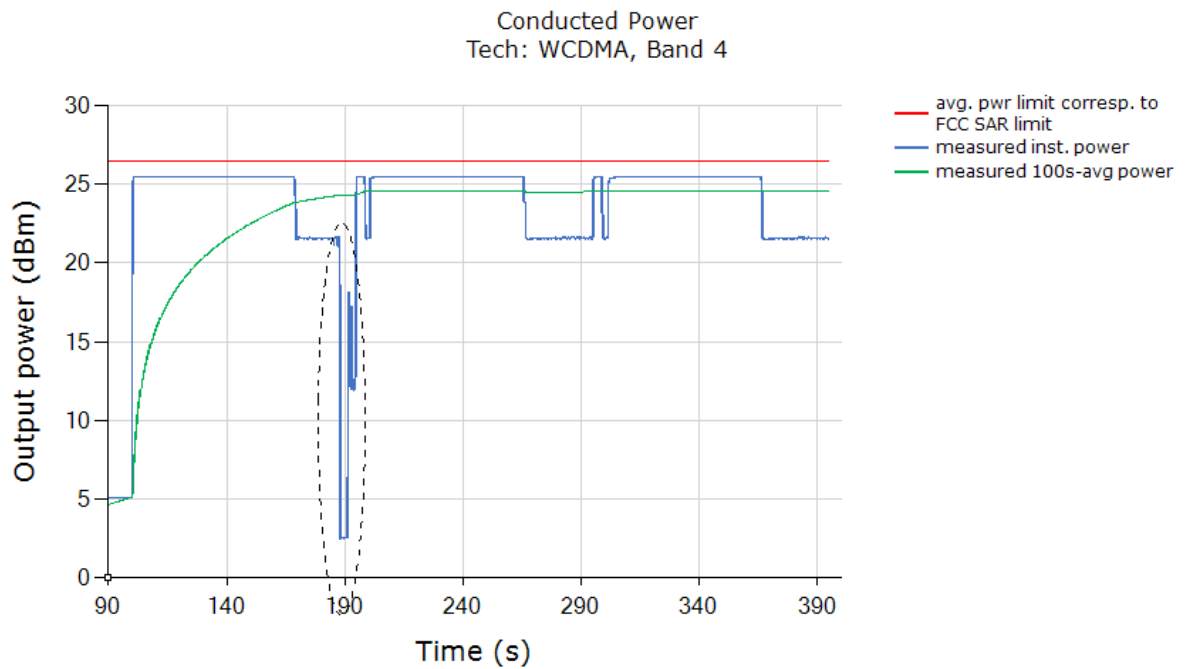

Above time-averaged conducted Tx power is converted/calculated into time-averaged 1g SAR using Equation (1a) and plotted below to demonstrate that the time-averaged 1g SAR versus time does not exceed the FCC limit of 1.6 W/kg for 1gSAR:

SAR Call Drop
Tech: WCDMA, Band 4

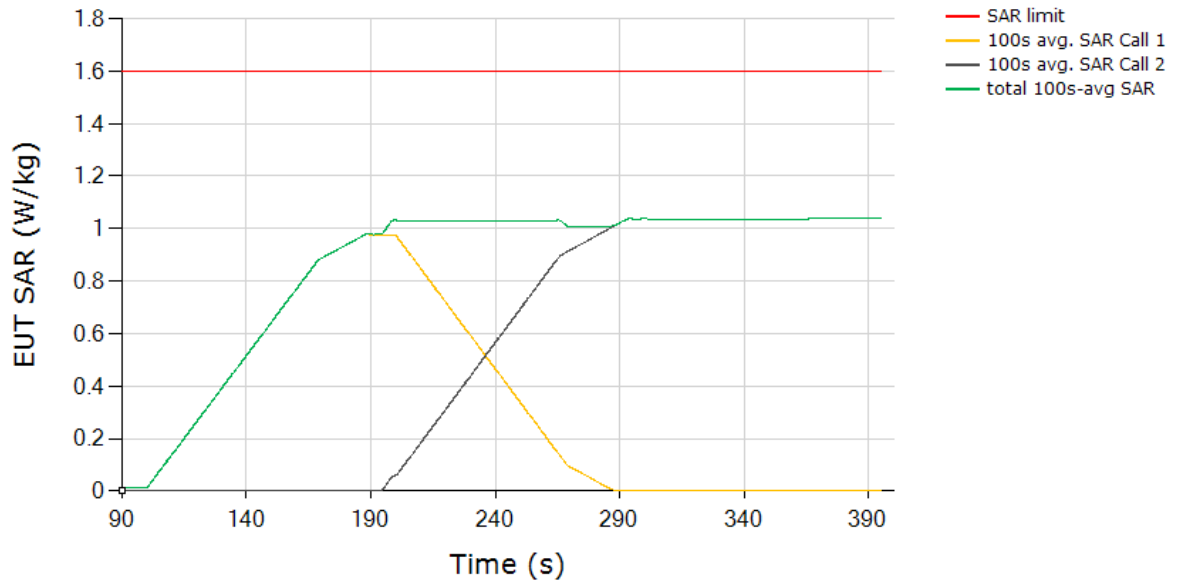

	(W/kg)
FCC 1gSAR limit	1.6
Max 100s-time averaged 1gSAR (green curve)	1.04
Validated: Max time averaged SAR (green curve) is within device uncertainty of measured SAR at P _{limit}	

The test result validated the continuity of power limiting in call change scenario.

6.5 Change in technology/band test results (Test case 10)

This test was conducted with callbox requesting maximum power, and with antenna & technology switch from WCDMA1700 to LTE Band7. Following procedure detailed in Section 4.3.3, and using the measurement setup shown in Figure 6-1(a) and (c), the technology/band switch was performed when the EUT is transmitting at Preserve level as shown in the plot below (dotted black region).

Test result for change in technology/band:

Plot 1: Measured Tx power (dBm) versus time shows that the transmitting power changed from WCDMA1700 $P_{reserve}$ level to LTE Band7 $P_{reserve}$ level (within device uncertainty):

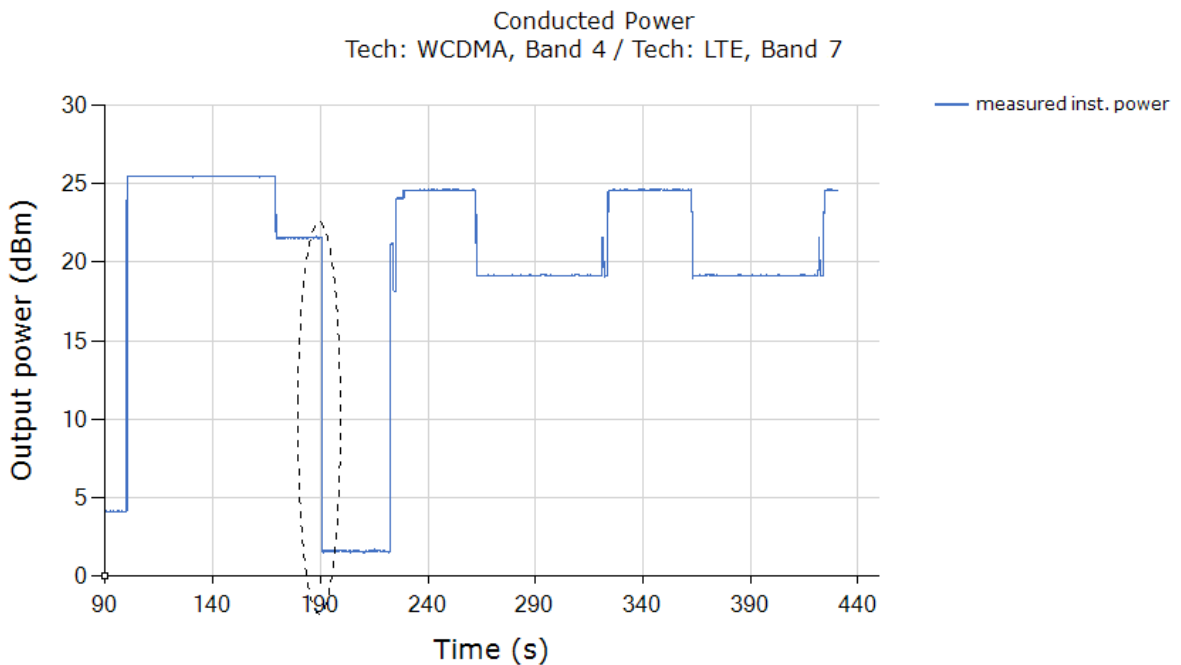

Plot 2: All the time-averaged conducted Tx power measurement results were converted into time-averaged normalized SAR values using Equation (6a), (6b) and (6c), and plotted below to demonstrate that the time- averaged normalized SAR versus time does not exceed the normalized FCC limit of 1.0:

Total Normalized Time-averaged RF Exposure
 Tech: WCDMA, Band 4 / Tech: LTE, Band 7

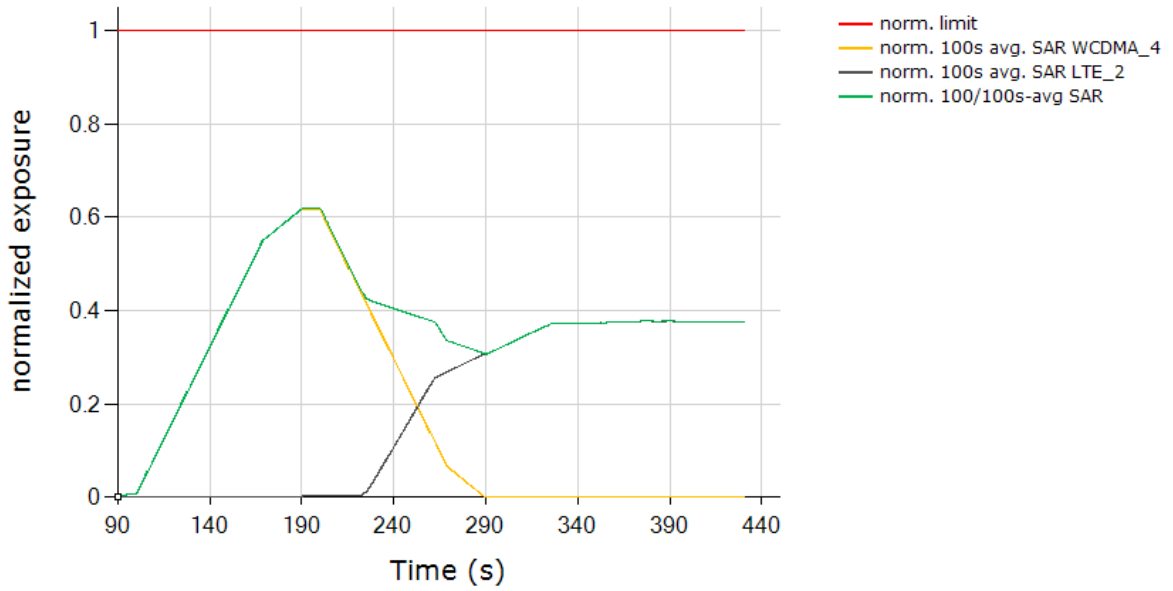

	(W/kg)
FCC 1gSAR limit	1.6
Max 100s-time averaged 1gSAR (green curve)	0.62
Validated: Max time averaged SAR (green curve) is within device uncertainty of measured SAR at Plimit	

The test result validated the continuity of power limiting in technology/band switch scenario.

6.6 Change in antenna test results (Test case 13)

This test was conducted with callbox requesting maximum power, and with antenna switch from WCDMA1700 ANT2 to WCDMA1700 ANT3. Following procedure detailed in Section 4.3.4, and using the measurement setup shown in Figure 6-1(a) and (c), the antenna switch was performed when the EUT is transmitting at Preserve level as shown in the plot below (dotted black region).

Test result for change in technology/band:

Plot 1: Measured Tx power (dBm) versus time shows that the transmitting power changed from WCDMA1700 ANT2 $P_{reserve}$ level to WCDMA1700 ANT3 $P_{reserve}$ level (within device uncertainty):

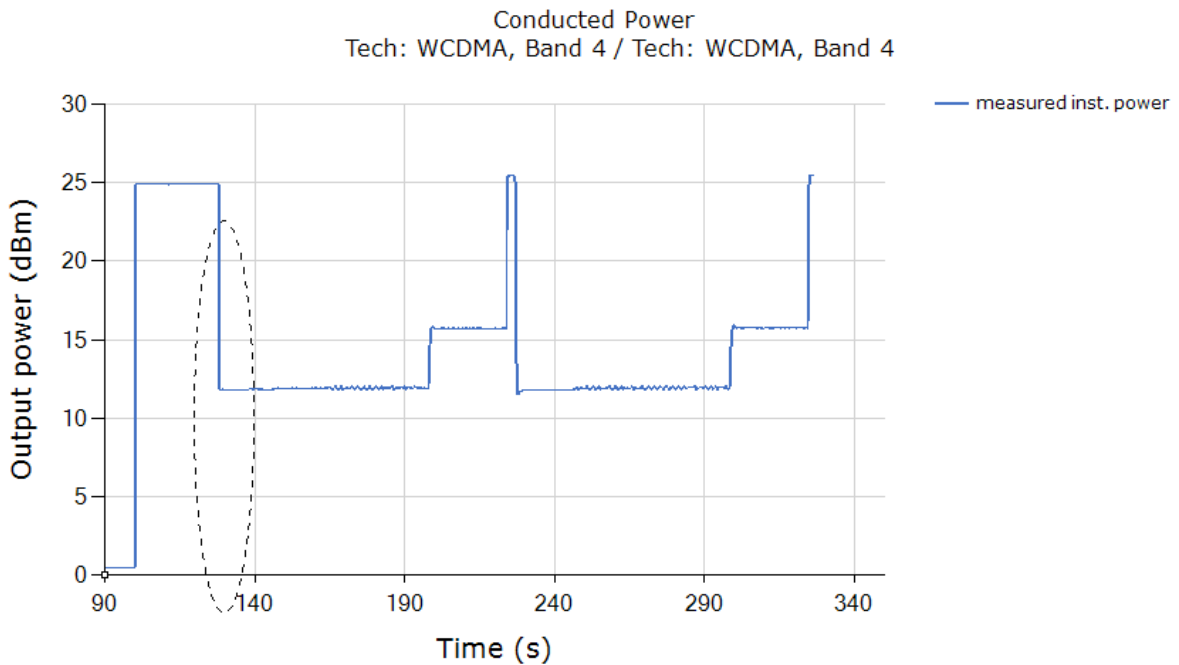

Plot 2: All the time-averaged conducted Tx power measurement results were converted into time-averaged normalized SAR values using Equation (6a), (6b) and (6c), and plotted below to demonstrate that the time- averaged normalized SAR versus time does not exceed the normalized FCC limit of 1.0:

Total Normalized Time-averaged RF Exposure
 Tech: WCDMA, Band 4 / Tech: WCDMA, Band 4

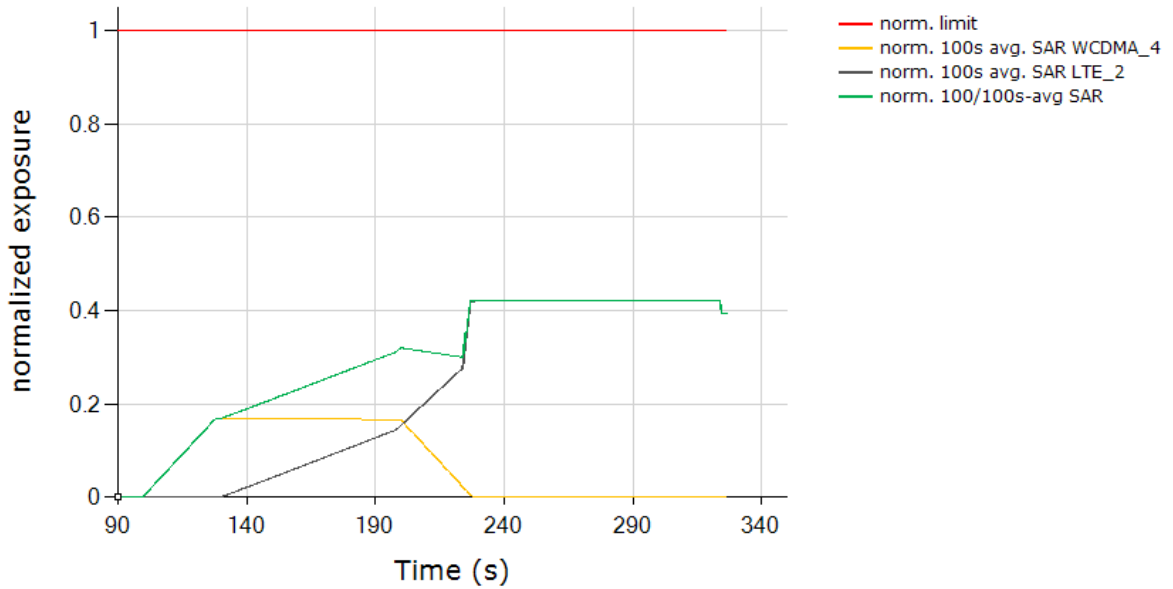

	(W/kg)
FCC 1gSAR limit	1.6
Max 100s-time averaged 1gSAR (green curve)	0.423
Validated: Max time averaged SAR (green curve) is within device uncertainty of measured SAR at Plimit	

The test result validated the continuity of power limiting in technology/band switch scenario.

6.7 Change in DSI test results (Test case 11)

This test was conducted with callbox requesting maximum power, and with DSI switch from WCDMA1700 DSI = 1 to DSI = 14. Following procedure detailed in Section 4.3.5 using the measurement setup shown in Figure 6-1(a) and (c), the DSI switch was performed when the EUT is transmitting at $P_{reserve}$ level as shown in the plot below (dotted black circle).

Test result for change in DSI:

Plot 1: Measured Tx power (dBm) versus time shows that the transmitting power changed when DSI = 1 switches to DSI = 14:

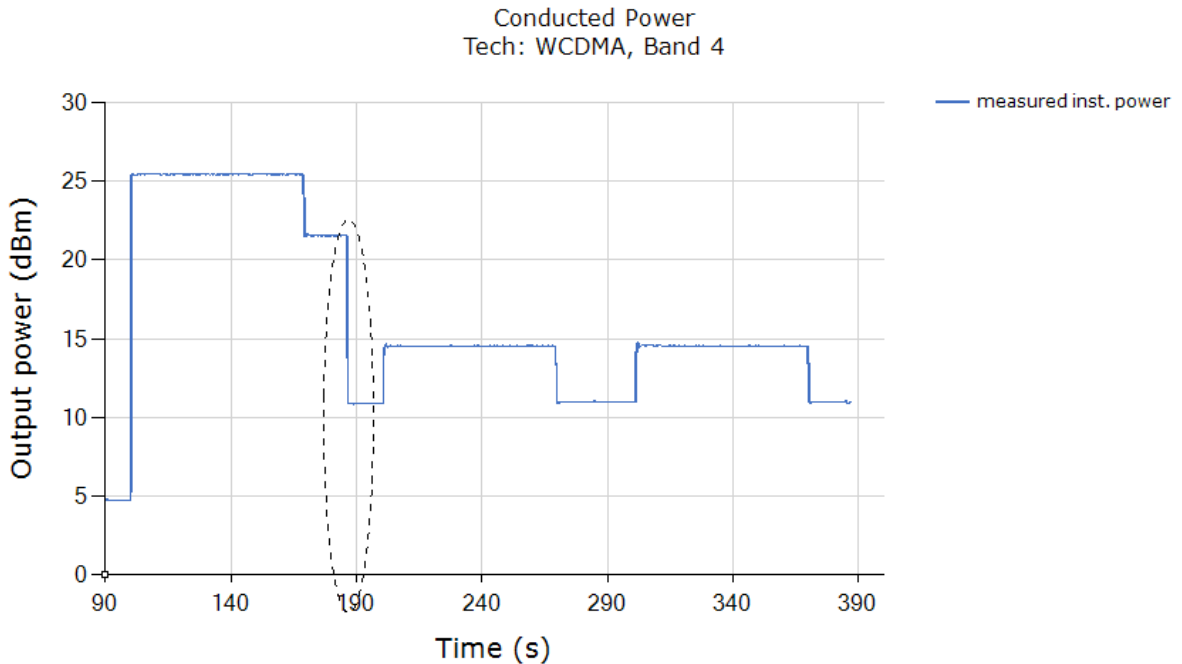

Plot 2: All the time-averaged conducted Tx power measurement results were converted into time-averaged normalized SAR values using Equation (6a), (6b) and (6c), and plotted below to demonstrate that the time- averaged normalized SAR versus time does not exceed the normalized FCC limit of 1.0:

Total Normalized Time-averaged RF Exposure
Tech: WCDMA, Band 4

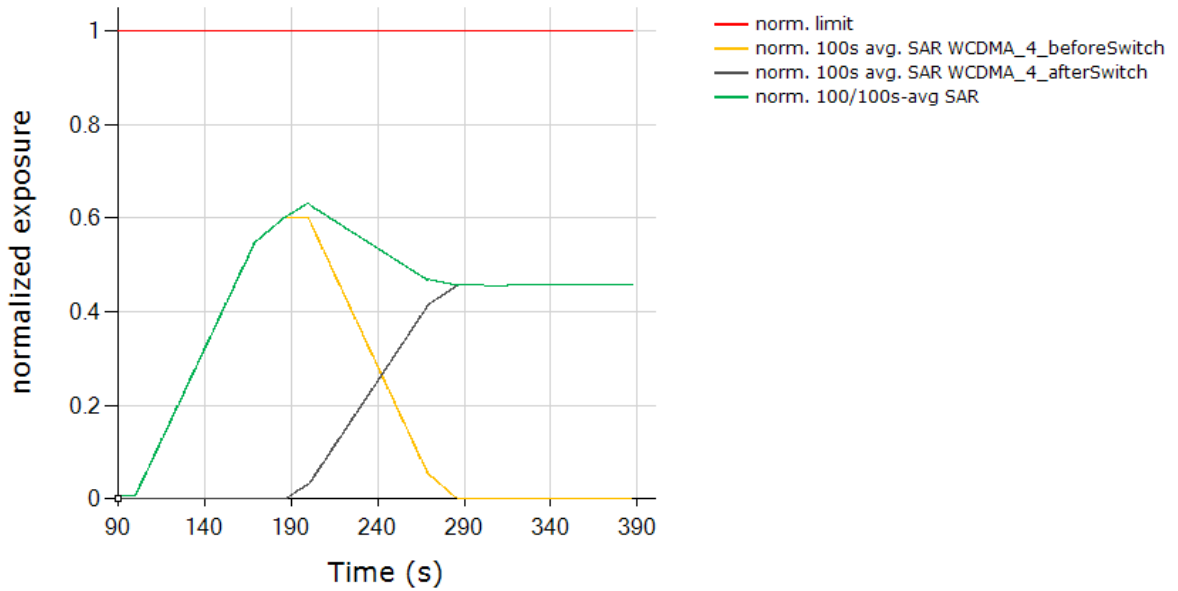

	(W/kg)
FCC 1gSAR limit	1.6
Max 100s-time averaged 1gSAR (green curve)	0.633
Validated: Max time averaged SAR (green curve) is within device uncertainty of measured SAR at Plimit	

The above test result validated the continuity of power limiting in DSI switch scenario.

6.8 Switch in SAR exposure test results LTE B2 NR n77 (Test case 12)

This test was conducted with callbox requesting maximum power, and with the EUT in LTE Band 2 + Sub6 NR N77 call. Following procedure detailed in Section 4.3.7 and Appendix B.2, and using the measurement setup shown in Figure 6-1(a) and (c) since LTE and Sub6 NR are sharing the same antenna port (otherwise, it should be Figure 6-1(b) and (d) for different antenna ports), the SAR exposure switch measurement is performed with the EUT in various SAR exposure scenarios, i.e., in SARsub6NR only scenario (t =10s ~125s), SARsu6NR + SARLTE scenario (t =125s ~ 235s) and SARLTE only scenario (t > 235s).

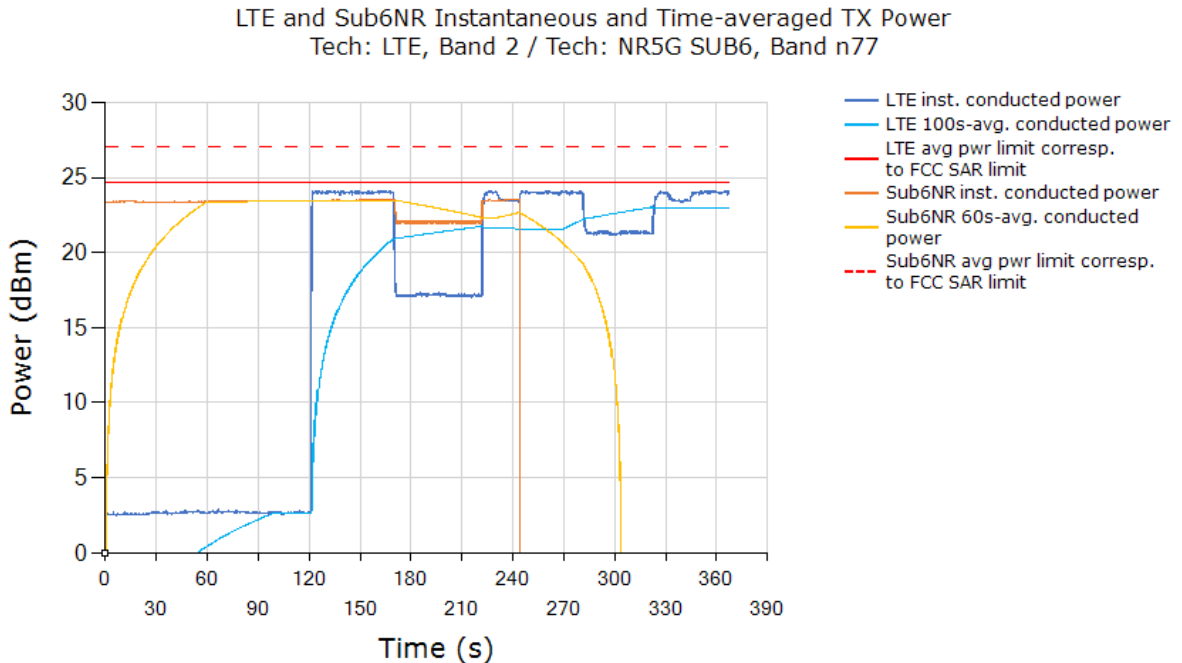

Plot 2: All the conducted Tx power measurement results were converted into time-averaged normalized SAR values using Equation (7a), (7b) and (7c), and plotted below to demonstrate that the time-averaged normalized SAR versus time does not exceed the FCC limit of 1 unit. Equation (7a) is used to convert the LTE Tx power of device to obtain 100s-averaged normalized SAR in LTE 2 as shown in black curve. Similarly, equation (7b) is used to obtain 60s-averaged normalized SAR in Sub6 NR n77 as shown in orange curve. Equation (7c) is used to obtain total time-averaged normalized SAR as shown in green curve (i.e., sum of black and orange curves).

Total Normalized Time-averaged RF Exposure
 Tech: LTE, Band 2 / Tech: NR5G SUB6, Band n77

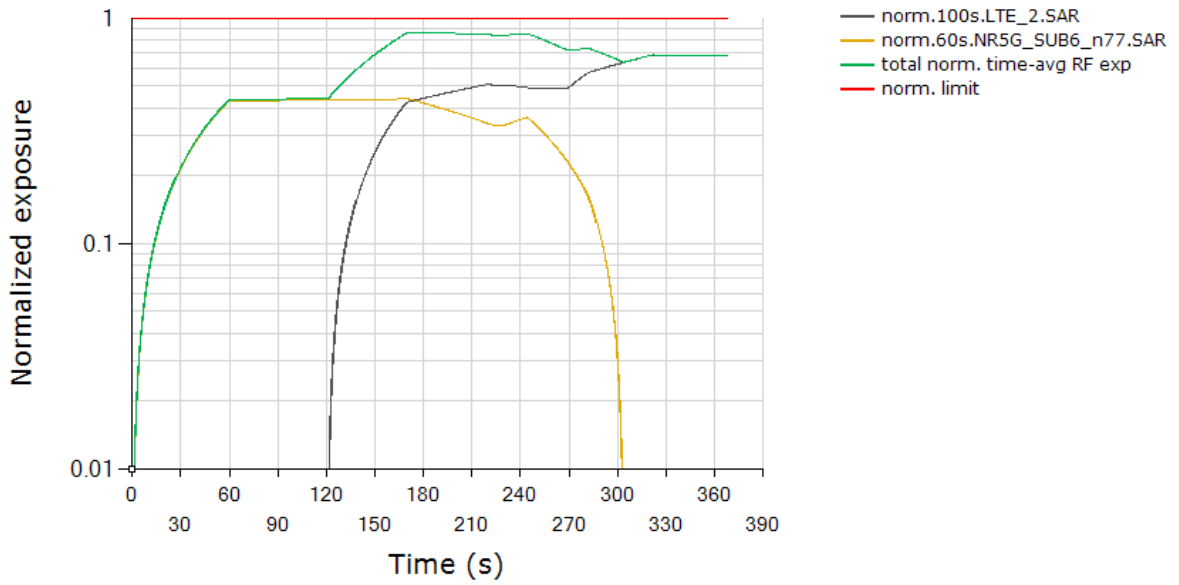

	(W/kg)
FCC 1gSAR limit	1.6
Max total time- averaged 1gSAR (green curve)	0.864
Validated: Max time averaged SAR (green curve) is within device uncertainty of measured SAR at Plimit	

The above test result validated the continuity of power limiting in SAR exposure switch scenario.

6.9 Change in Time Window test results (Test case 14)

This test was conducted with callbox requesting maximum power, and with time-window switch between NR Band n41 (100s window) and NR Band n77 (60s window). Following procedure detailed in Section 4.3.6 using the measurement setup shown in Figure 6-1(a) and (c), the time-window switch was performed when the EUT is transmitting at $P_{reserve}$ level.

Test result for change in time-window (from 100s to 60s to 100s):

All the conducted Tx power measurement results were converted into time-averaged normalized SAR values using Equation (7a), (7b) and (7c), and plotted below to demonstrate that the time-averaged normalized SAR versus time does not exceed the FCC limit of 1 unit. Equation (7a) is used to convert the Tx power of device to obtain 100s-averaged normalized SAR in NR Band n41 as shown in black curve. Similarly, equation (7b) is used to obtain 60s-averaged normalized SAR in NR Band n77 as shown in orange curve. Equation (7c) is used to obtain total time-averaged normalized SAR as shown in green curve (i.e., sum of black and orange curves).

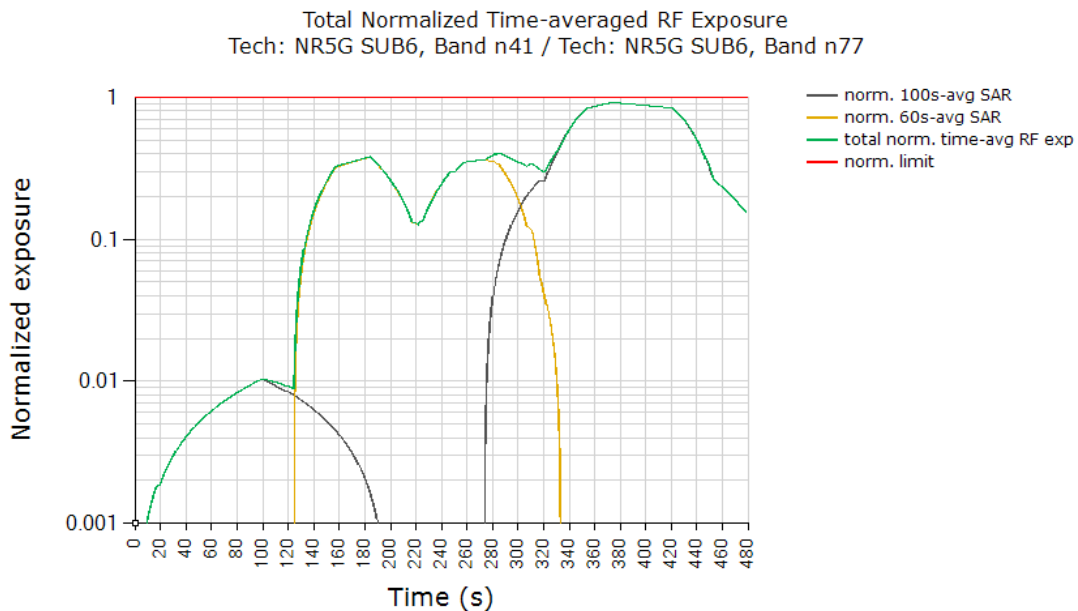

	(W/kg)
FCC 1gSAR limit	1.6
Max 100s-time averaged 1gSAR (green curve)	0.920
Validated: Max time averaged SAR (green curve) is within device uncertainty of measured SAR at Plimit	

Plot Notes: Maximum power is requested by callbox for the entire duration of the test, with tech/band switches from 100s-to-60s window at ~245s time stamp, and from 60s-to-100s window at ~310s time stamp. Smart Transmit controls the Tx power during these time-window switches to ensure total time-averaged RF exposure, i.e., sum of black and orange curves given by equation (7c), is always compliant. In time-window switch test, at all times the total time-averaged normalized RF exposure (green curve) should not exceed normalized SAR_{design_target}+1.2 dB device uncertainty), the above test result validated the continuity of power limiting in time = window switch scenario.

Test result for change in time-window (from 60s to 100s to 60s):

All the conducted Tx power measurement results were converted into time-averaged normalized SAR values using Equation (7a), (7b) and (7c), and plotted below to demonstrate that the time-averaged normalized SAR versus time does not exceed the FCC limit of 1 unit. Equation (7a) is used to convert the Tx power of device to obtain 60s-averaged normalized SAR in NR Band n77 as shown in black curve. Similarly, equation (7b) is used to obtain 100s-averaged normalized SAR in S NR Band n41 as shown in orange curve. Equation (7c) is used to obtain total time-averaged normalized SAR as shown in green curve (i.e., sum of black and orange curves).

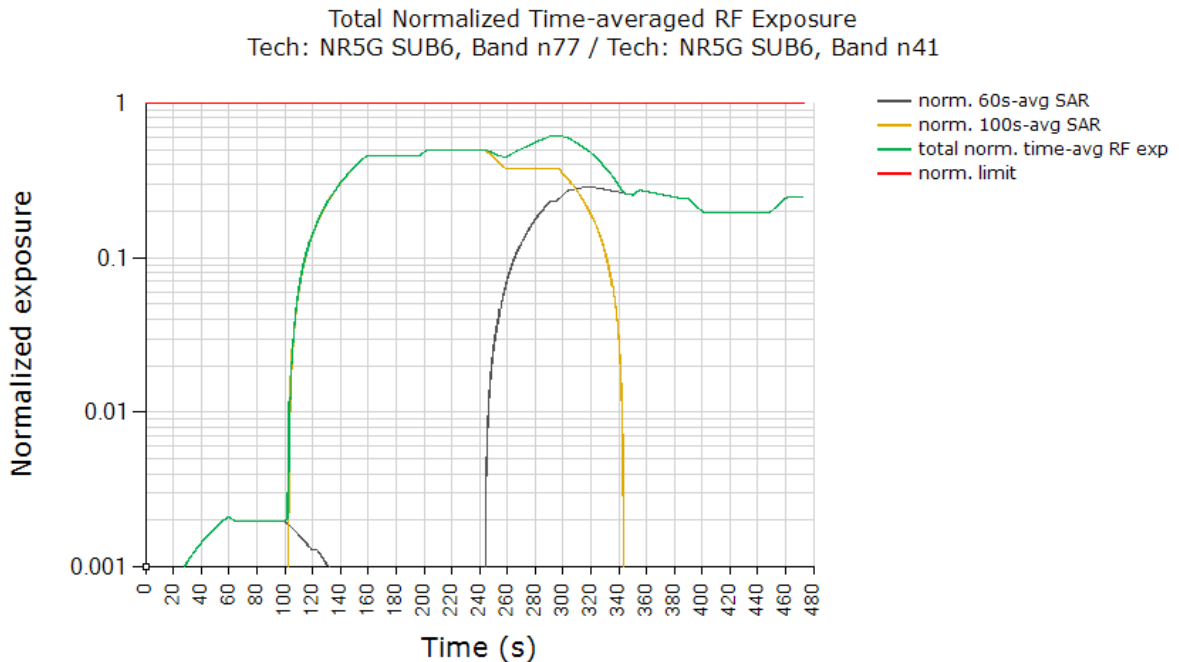

	(W/kg)
FCC 1gSAR limit	1.6
Max 100s-time averaged 1gSAR (green curve)	0.616
Validated: Max time averaged SAR (green curve) is within device uncertainty of measured SAR at Plimit	

Plot Notes: Maximum power is requested by callbox for the entire duration of the test, with tech/band switches from 60s-to-100s window at ~245s time stamp, and from 60s-to-100s window at ~310s time stamp. Smart Transmit controls the Tx power during these time-window switches to ensure total time-averaged RF exposure, i.e.,sum of black and orange curves given by equation (7c), is always compliant. In time-window switch test, at all times the total time-averaged normalized RF exposure (green curve) should not exceed normalized SAR_{design_target}+1.2 dB device uncertainty),the above test result validated the continuity of power limiting in time = window switch scenario.

7 SAR Test Results for Sub-6 Smart Transmit Feature

7.1 Measurement setup

The measurement setup is similar to normal SAR measurements. The difference in SAR measurement setup for time averaging feature validation is that the callbox is signaling in close loop power control mode (instead of requesting maximum power in open loop control mode) and callbox is connected to the PC using GPIB so that the test script executed on PC can send GPIB commands to control the callbox's requested power over time (test sequence). The same test script used in conducted setup for time-varying Tx power measurements is also used in this section for running the test sequences during SAR measurements, and the recorded values from the disconnected power meter by the test script were discarded.

As mentioned in Section 4.4, for EUT to follow TPC command sent from the callbox wirelessly, the "path loss" between callbox antenna and the EUT needs to be very well calibrated. Since the SAR chamber is in uncontrolled environment, precautions must be taken to minimize the environmental influences on "path loss". Similarly, in the case of time-varying SAR measurements in Sub6 NR (with LTE as anchor), "path loss" between callbox antenna and the EUT needs to be carefully calibrated for both LTE link as well as for Sub6 NR link.

The EUT is placed in worst-case position according to Table 5-2.

7.2 SAR measurement results for time-varying Tx power transmission scenario

Following Section 4.4 procedure, time-averaged SAR measurements are conducted using EX3DV4 probe at peak location of area scan over 500 seconds. cDASY6 system verification for SAR measurement is provided in Appendix C, and the associated SPEAG certificates are attached in Appendix D.

SAR probe integration times depend on the communication signal being tested. Integration times used by SPEAG for their probe calibrations can be downloaded from here (integration time is listed on the bottom of the first page for each tech):

<https://www.speag.com/assets/downloads/services/cs/UIDSummary171205.pdf>

Since the sampling rate used by cDASY6 for pointSAR measurements is not in user control, the number of points in 100s or 60s interval is determined from the scan duration setting in cDASY6 time-average pointSAR measurement by (100s or 60s / cDASY6_scan_duration * total number of pointSAR values recorded). Running average is performed over these number of points in excel spreadsheet to obtain 100s-/60s-averaged pointSAR.

Following Section 4.4, for each of selected technology/band (listed in Table 5-2):

1 With Reserve_power_margin set to 0 dB, area scan is performed at P_{limit}, and time-averaged pointSAR measurements are conducted to determine the pointSAR at P_{limit} at peak location, denoted as pointSAR_{P_{limit}}.

2 With Reserve_power_margin set to actual (intended) value, two more time-averaged pointSAR measurements are performed at the same peak location for test sequences 1 and 2.

To demonstrate compliance, all the pointSAR measurement results were converted into 1gSAR or 10gSAR values by using Equation (3a), rewritten below:

$$1g_or_10gSAR(t) = \frac{pointSAR(t)}{pointSAR_{P_{limit}}} * 1g_or_10gSAR_{P_{limit}} \quad (3a)$$

where, $pointSAR(t)$, $pointSAR_{P_{limit}}$, and $1g_or_10gSAR_{P_{limit}}$ correspond to the measured instantaneous point SAR, measured point SAR at P_{limit} from above step 1 and 2, and measured 1gSAR or 10gSAR values at P_{limit} obtained from Part 1 report and listed in Table 5-2 in Section 5.1 of this report.

7.2.1 GSM1900 SAR test results (Test case 1)

SAR test result for test sequence 1:

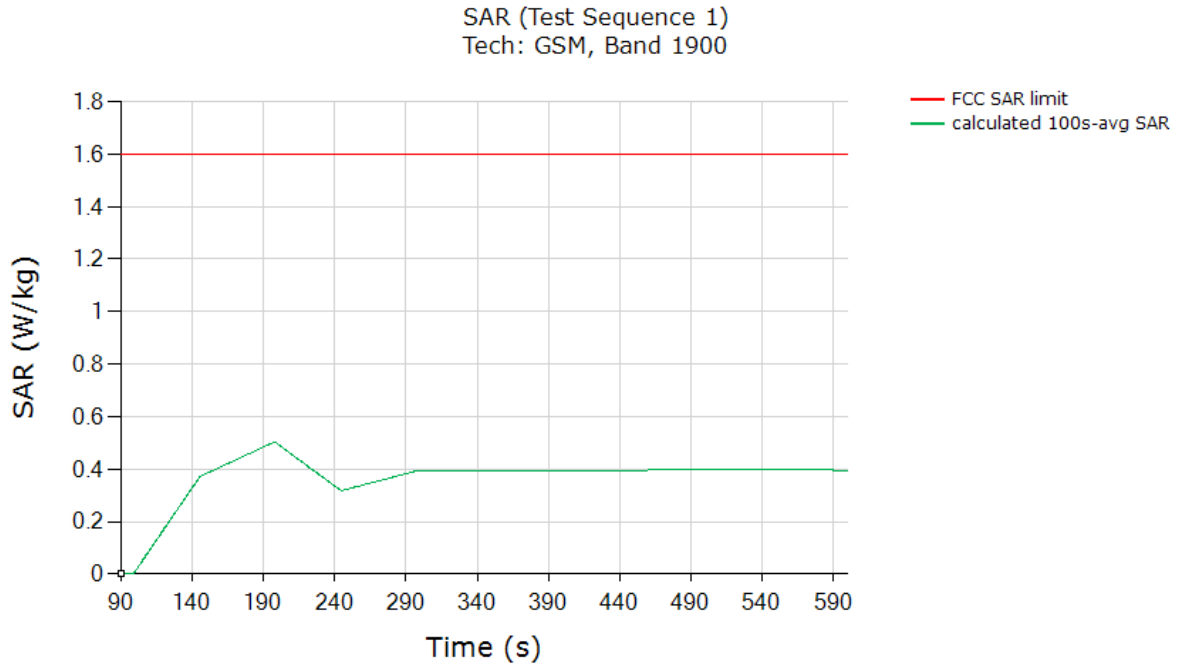

Above time-averaged conducted Tx power is converted/calculated into time-averaged 1g SAR using Equation (1a) and plotted below to demonstrate that the time-averaged 1g SAR versus time does not exceed the FCC limit of 1.6 W/kg for 1gSAR:

	(W/kg)
FCC 1gSAR limit	1.6
Max 100s-time averaged 1gSAR (green curve)	0.503
Validated: Max time averaged SAR (green curve) is within device uncertainty of measured SAR at Plimit	

Test result for test sequence 2:

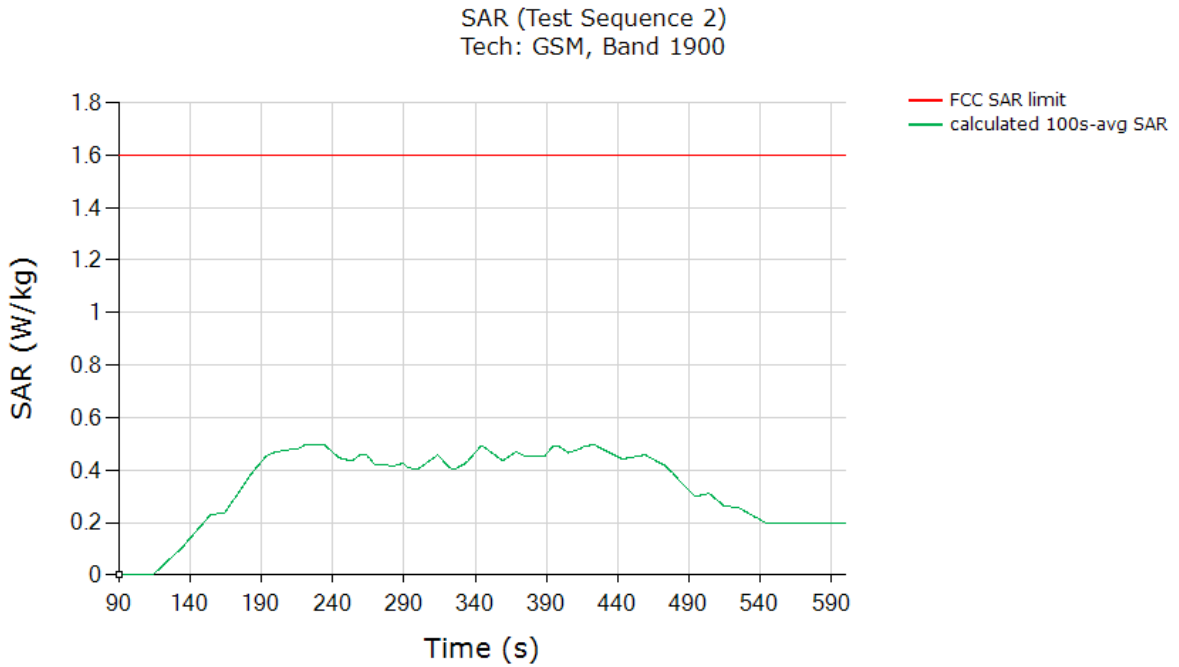

Above time-averaged conducted Tx power is converted/calculated into time-averaged 1g SAR using Equation (1a) and plotted below to demonstrate that the time-averaged 1g SAR versus time does not exceed the FCC limit of 1.6 W/kg for 1gSAR:

	(W/kg)
FCC 1gSAR limit	1.6
Max 100s-time averaged 1gSAR (green curve)	0.497
Validated: Max time averaged SAR (green curve) is within device uncertainty of measured SAR at Plimit	

7.2.2 GSM1900 SAR test results (Test case 2)

SAR test result for test sequence 1:

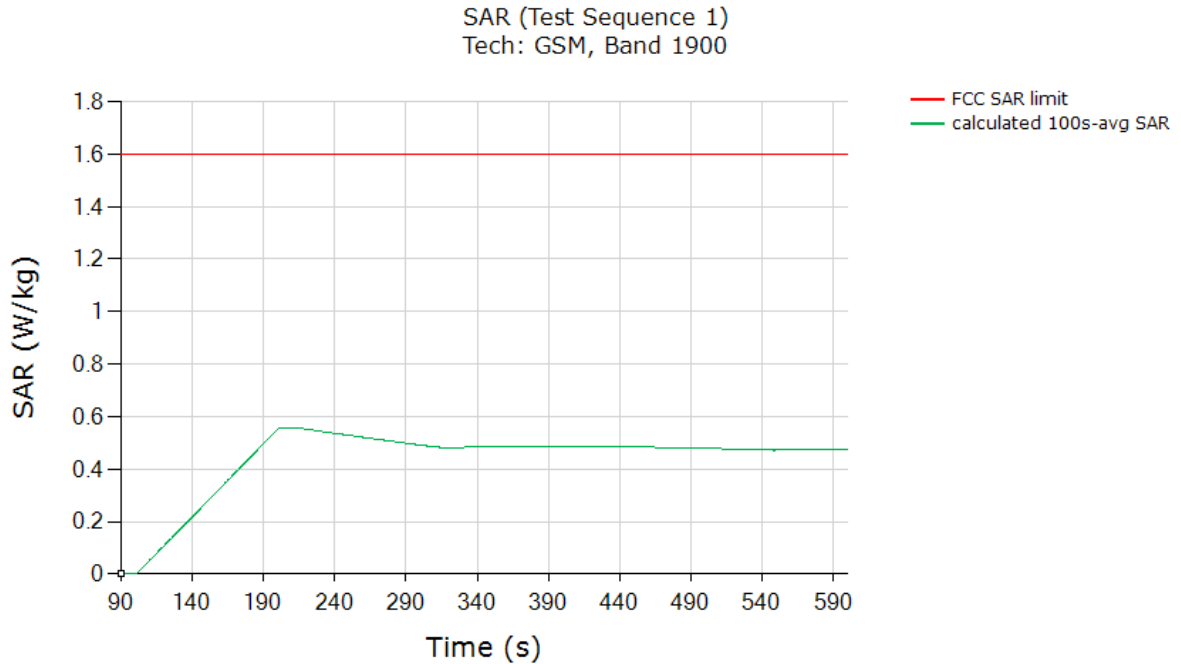

Above time-averaged conducted Tx power is converted/calculated into time-averaged 1g SAR using Equation (1a) and plotted below to demonstrate that the time-averaged 1g SAR versus time does not exceed the FCC limit of 1.6 W/kg for 1gSAR:

	(W/kg)
FCC 1gSAR limit	1.6
Max 100s-time averaged 1gSAR (green curve)	0.554
Validated: Max time averaged SAR (green curve) is within device uncertainty of measured SAR at Plimit	

Test result for test sequence 2:

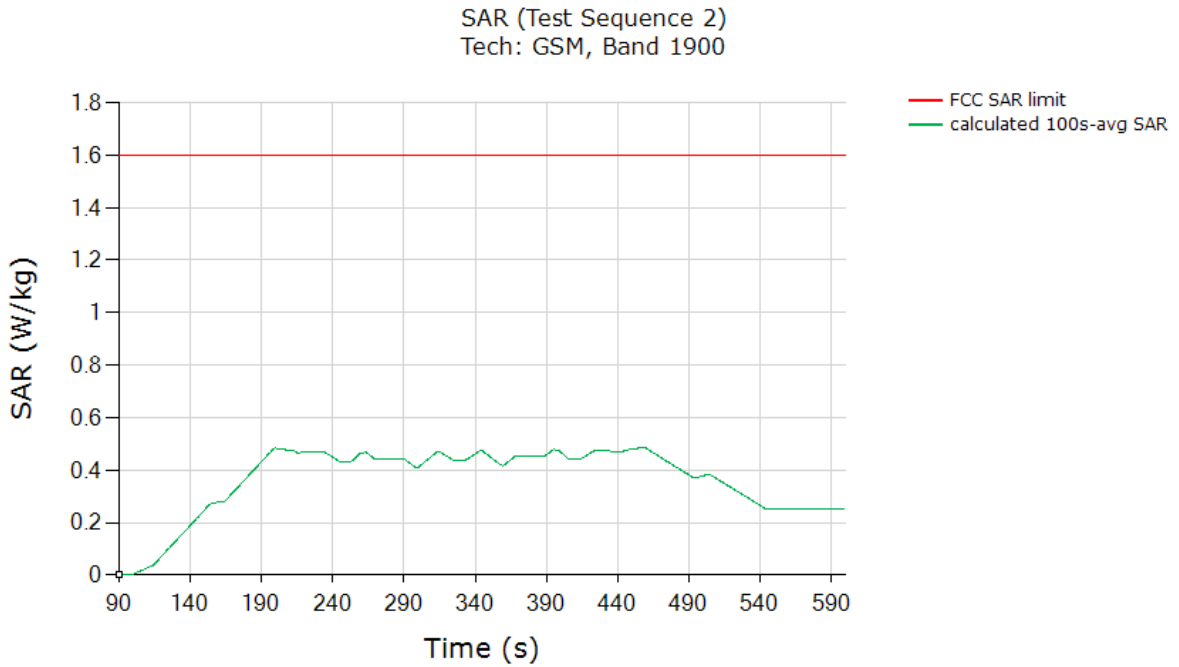

Above time-averaged conducted Tx power is converted/calculated into time-averaged 1g SAR using Equation (1a) and plotted below to demonstrate that the time-averaged 1g SAR versus time does not exceed the FCC limit of 1.6 W/kg for 1gSAR:

	(W/kg)
FCC 1gSAR limit	1.6
Max 100s-time averaged 1gSAR (green curve)	0.486
Validated: Max time averaged SAR (green curve) is within device uncertainty of measured SAR at Plimit	

7.2.3 WCDMA1700 SAR test results (Test case 3)

SAR test result for test sequence 1:

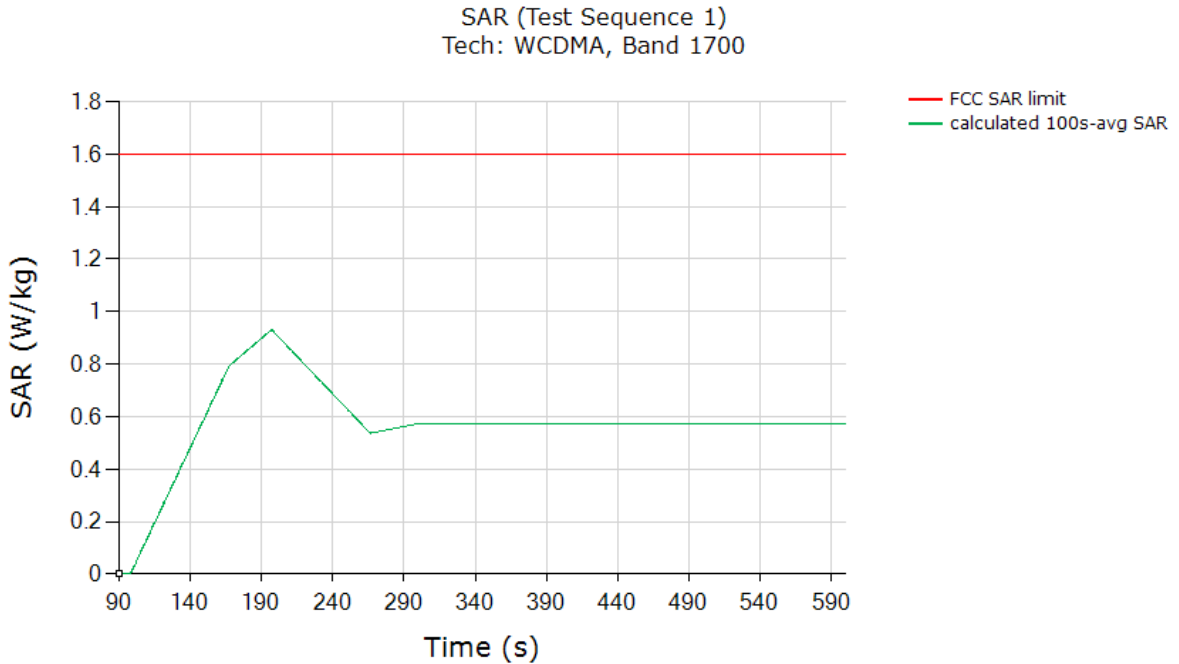

Above time-averaged conducted Tx power is converted/calculated into time-averaged 1g SAR using Equation (1a) and plotted below to demonstrate that the time-averaged 1g SAR versus time does not exceed the FCC limit of 1.6 W/kg for 1gSAR:

	(W/kg)
FCC 1gSAR limit	1.6
Max 100s-time averaged 1gSAR (green curve)	0.93
Validated: Max time averaged SAR (green curve) is within device uncertainty of measured SAR at Plimit	

Test result for test sequence 2:

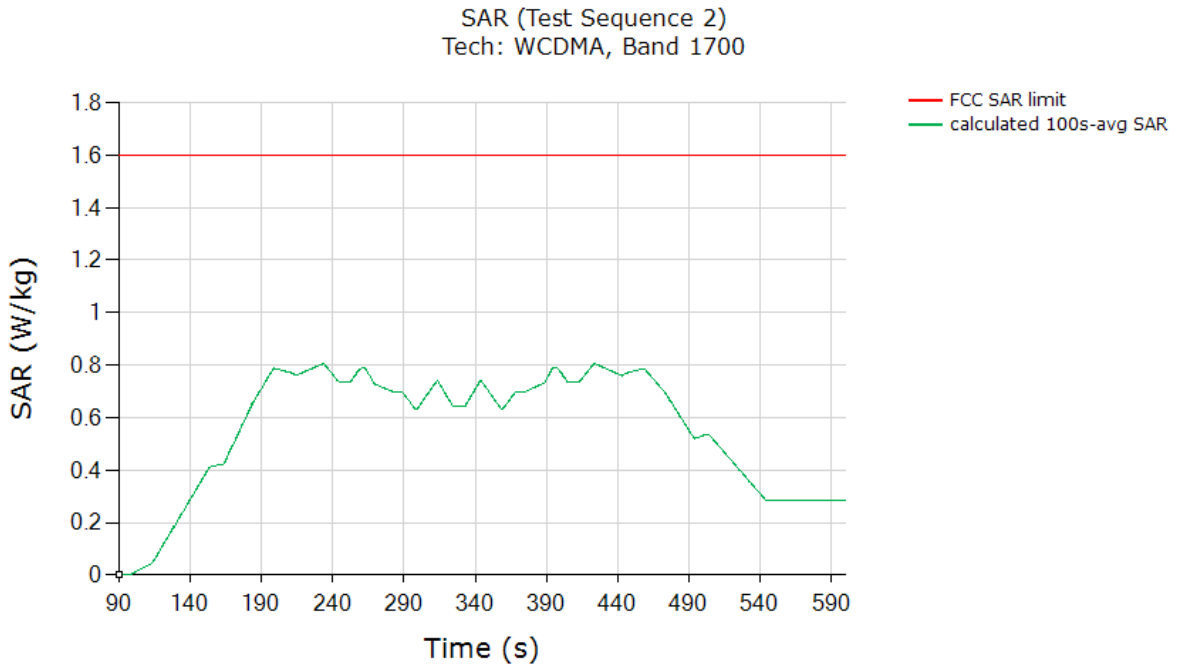

Above time-averaged conducted Tx power is converted/calculated into time-averaged 1g SAR using Equation (1a) and plotted below to demonstrate that the time-averaged 1g SAR versus time does not exceed the FCC limit of 1.6 W/kg for 1gSAR:

	(W/kg)
FCC 1gSAR limit	1.6
Max 100s-time averaged 1gSAR (green curve)	0.805
Validated: Max time averaged SAR (green curve) is within device uncertainty of measured SAR at Plimit	

7.2.4 WCDMA1700 SAR test results (Test case 4)

SAR test result for test sequence 1:

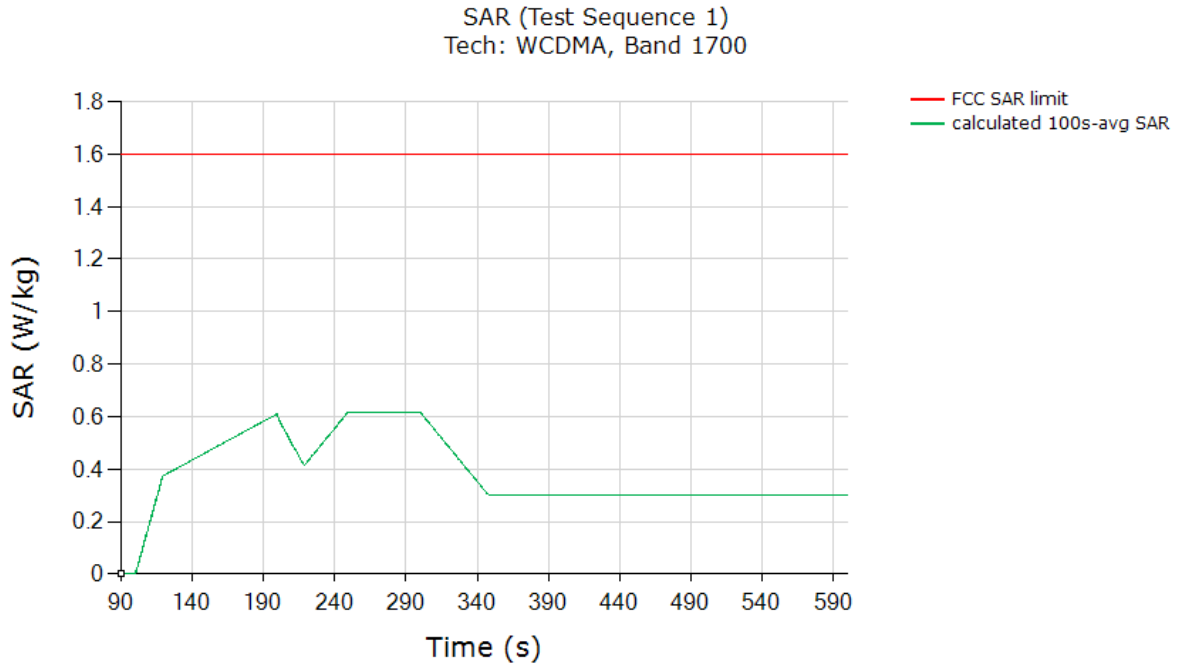

Above time-averaged conducted Tx power is converted/calculated into time-averaged 1g SAR using Equation (1a) and plotted below to demonstrate that the time-averaged 1g SAR versus time does not exceed the FCC limit of 1.6 W/kg for 1gSAR:

	(W/kg)
FCC 1gSAR limit	1.6
Max 100s-time averaged 1gSAR (green curve)	0.6150
Validated: Max time averaged SAR (green curve) is within device uncertainty of measured SAR at Plimit	

Test result for test sequence 2:

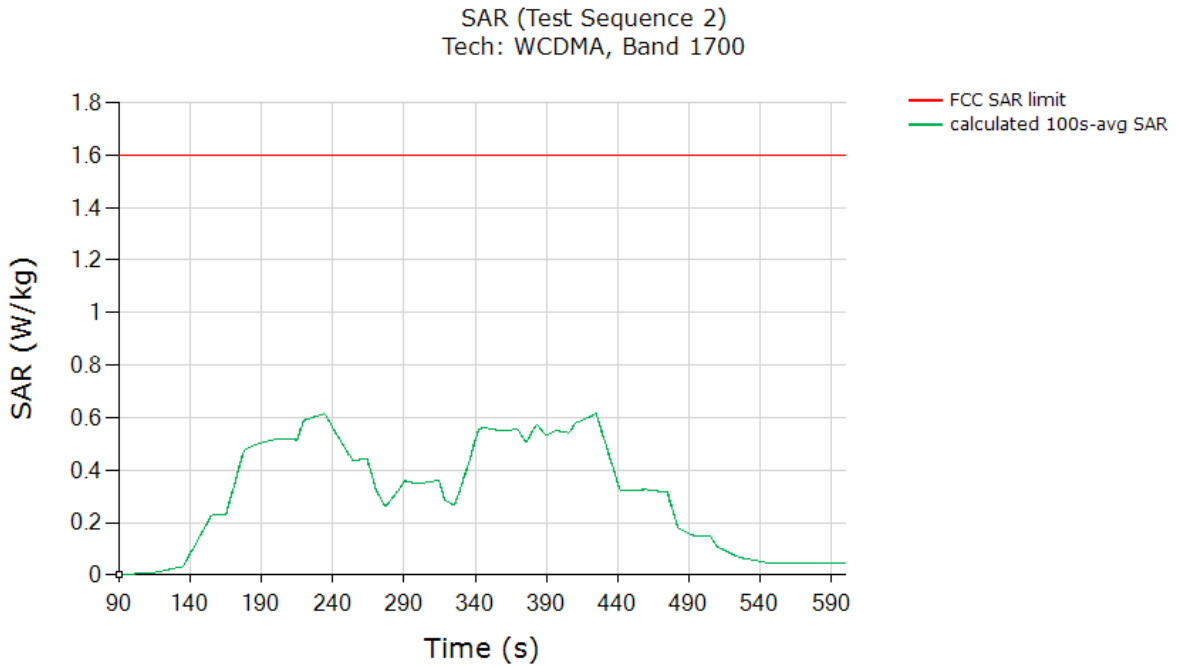

Above time-averaged conducted Tx power is converted/calculated into time-averaged 1g SAR using Equation (1a) and plotted below to demonstrate that the time-averaged 1g SAR versus time does not exceed the FCC limit of 1.6 W/kg for 1gSAR:

	(W/kg)
FCC 1gSAR limit	1.6
Max 100s-time averaged 1gSAR (green curve)	0.615
Validated: Max time averaged SAR (green curve) is within device uncertainty of measured SAR at Plimit	

7.2.5 LTE B41 PC2 SAR test results (Test case 5)

SAR test result for test sequence 1:

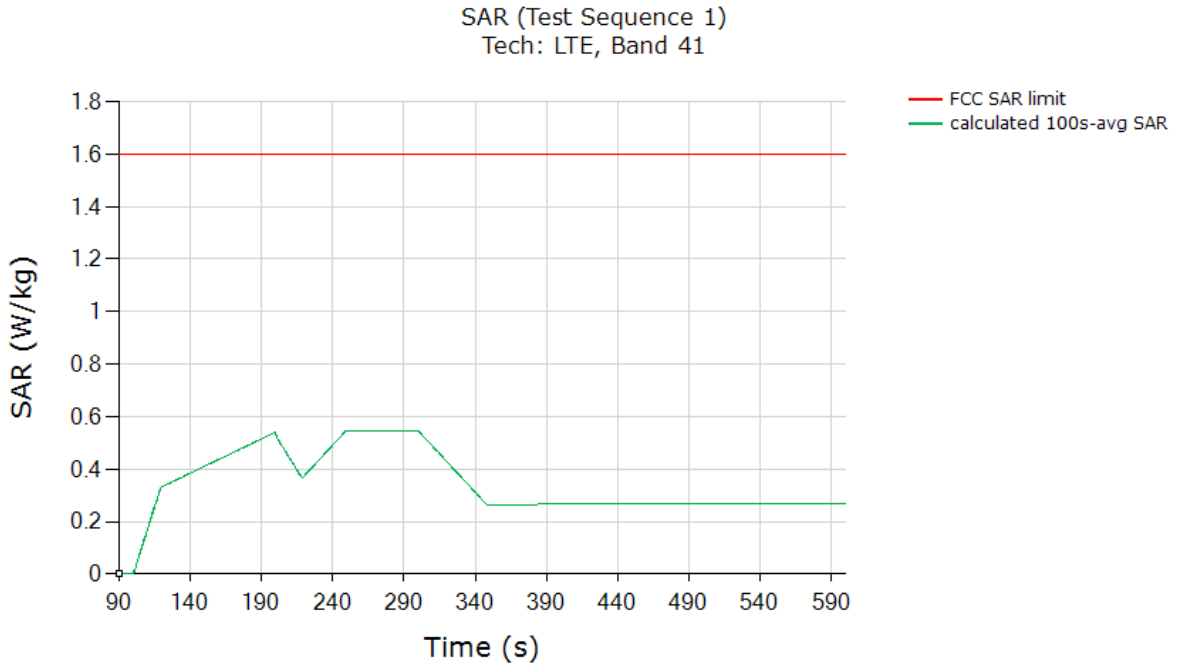

Above time-averaged conducted Tx power is converted/calculated into time-averaged 1g SAR using Equation (1a) and plotted below to demonstrate that the time-averaged 1g SAR versus time does not exceed the FCC limit of 1.6 W/kg for 1gSAR:

	(W/kg)
FCC 1gSAR limit	1.6
Max 100s-time averaged 1gSAR (green curve)	0.544
Validated: Max time averaged SAR (green curve) is within device uncertainty of measured SAR at Plimit	

Test result for test sequence 2:

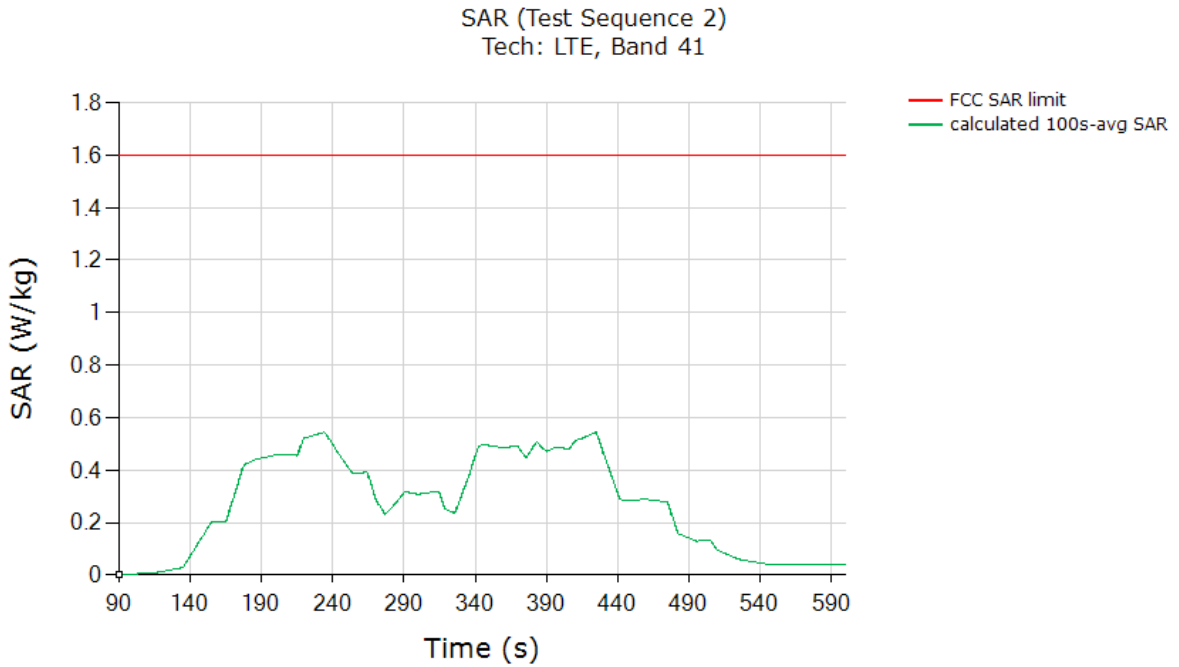

Above time-averaged conducted Tx power is converted/calculated into time-averaged 1g SAR using Equation (1a) and plotted below to demonstrate that the time-averaged 1g SAR versus time does not exceed the FCC limit of 1.6 W/kg for 1gSAR:

	(W/kg)
FCC 1gSAR limit	1.6
Max 100s-time averaged 1gSAR (green curve)	0.544
Validated: Max time averaged SAR (green curve) is within device uncertainty of measured SAR at Plimit	

7.2.6 LTE B7 SAR test results (Test case 6)

SAR test result for test sequence 1:

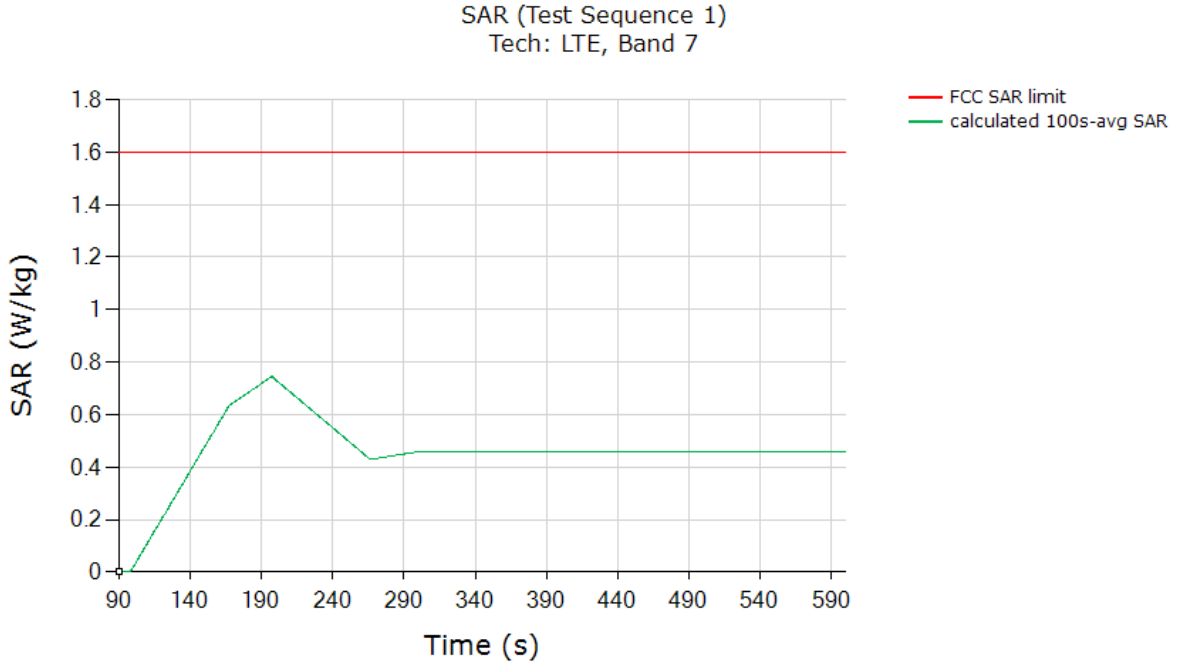

Above time-averaged conducted Tx power is converted/calculated into time-averaged 1g SAR using Equation (1a) and plotted below to demonstrate that the time-averaged 1g SAR versus time does not exceed the FCC limit of 1.6 W/kg for 1gSAR:

	(W/kg)
FCC 1gSAR limit	1.6
Max 100s-time averaged 1gSAR (green curve)	0.744
Validated: Max time averaged SAR (green curve) is within device uncertainty of measured SAR at Plimit	

Test result for test sequence 2:

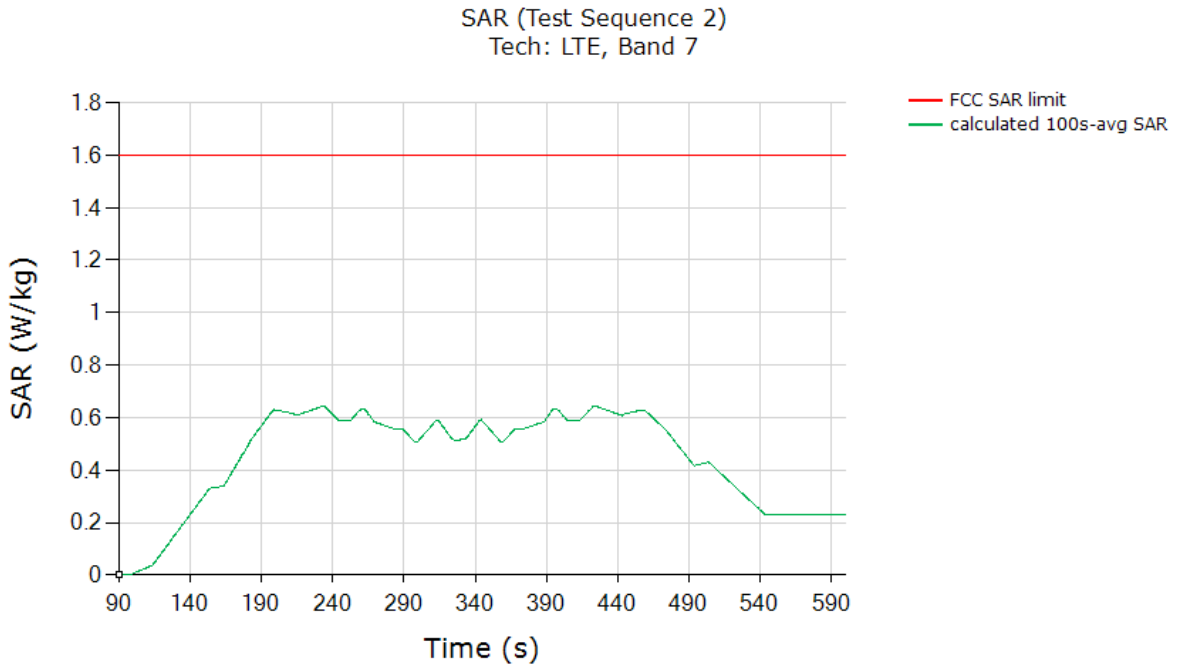

Above time-averaged conducted Tx power is converted/calculated into time-averaged 1g SAR using Equation (1a) and plotted below to demonstrate that the time-averaged 1g SAR versus time does not exceed the FCC limit of 1.6 W/kg for 1gSAR:

	(W/kg)
FCC 1gSAR limit	1.6
Max 100s-time averaged 1gSAR (green curve)	0.644
Validated: Max time averaged SAR (green curve) is within device uncertainty of measured SAR at Plimit	

7.2.7 SUB6G N77 SAR test results (Test case 7)

SAR test result for test sequence 1:

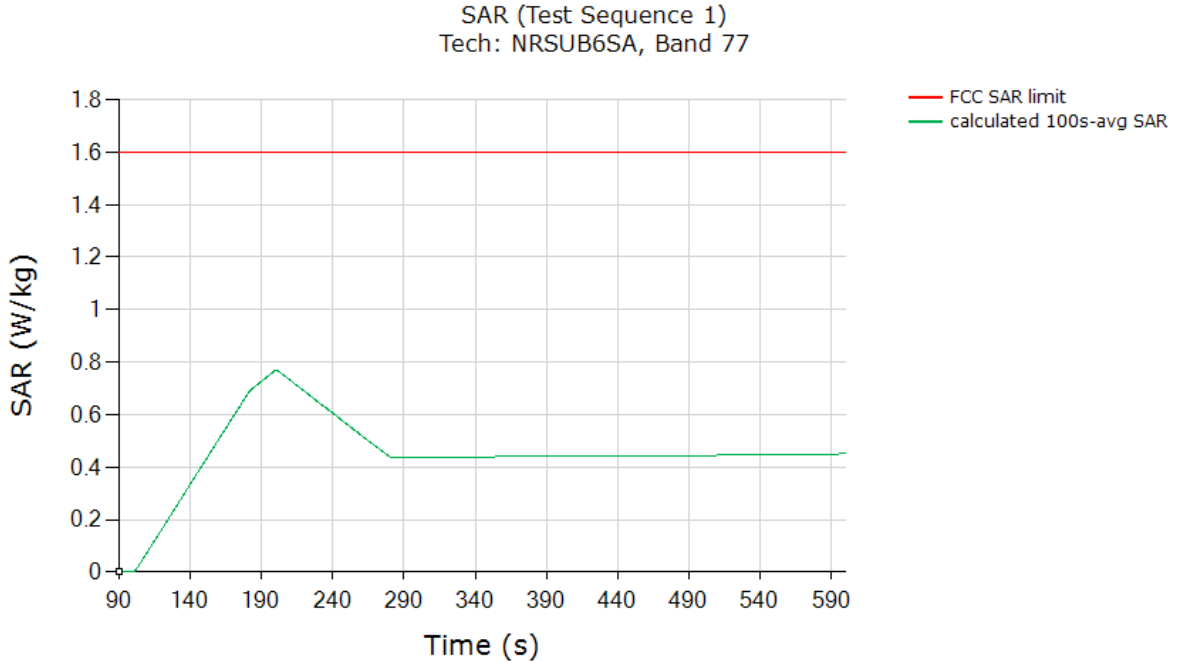

Above time-averaged conducted Tx power is converted/calculated into time-averaged 1g SAR using Equation (1a) and plotted below to demonstrate that the time-averaged 1g SAR versus time does not exceed the FCC limit of 1.6 W/kg for 1gSAR:

	(W/kg)
FCC 1gSAR limit	1.6
Max 100s-time averaged 1gSAR (green curve)	0.77
Validated: Max time averaged SAR (green curve) is within device uncertainty of measured SAR at Plimit	

Test result for test sequence 2:

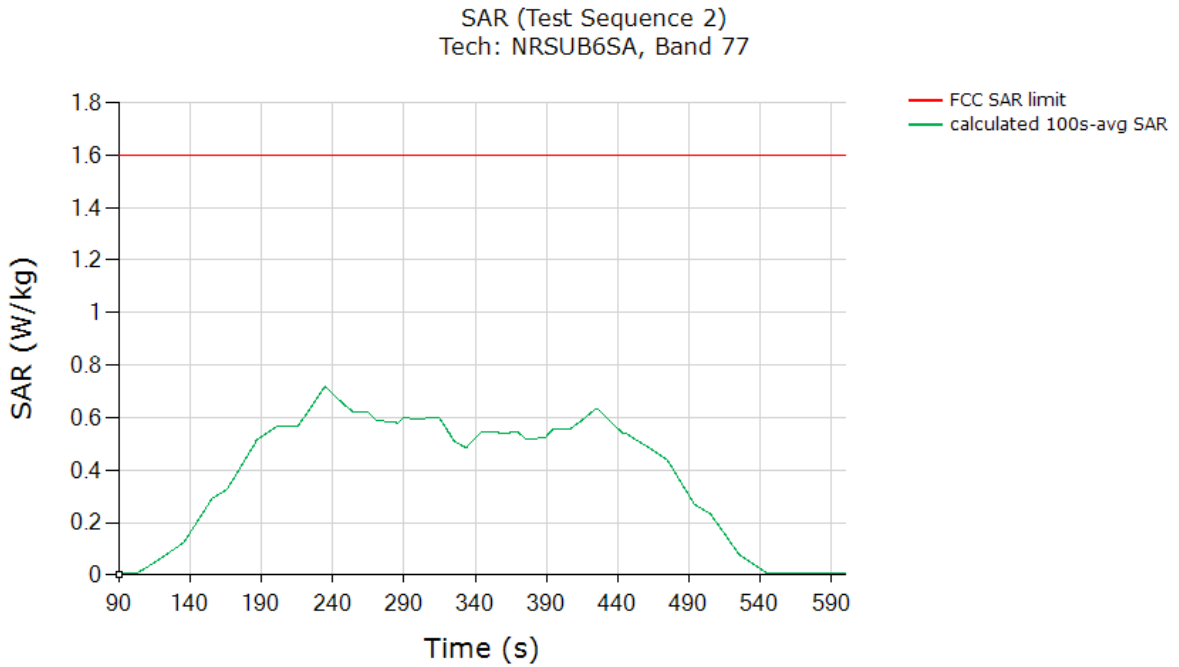

Above time-averaged conducted Tx power is converted/calculated into time-averaged 1g SAR using Equation (1a) and plotted below to demonstrate that the time-averaged 1g SAR versus time does not exceed the FCC limit of 1.6 W/kg for 1gSAR:

	(W/kg)
FCC 1gSAR limit	1.6
Max 100s-time averaged 1gSAR (green curve)	0.719
Validated: Max time averaged SAR (green curve) is within device uncertainty of measured SAR at Plimit	

7.2.8 SUB6G N77 SAR test results (Test case 8)

SAR test result for test sequence 1:

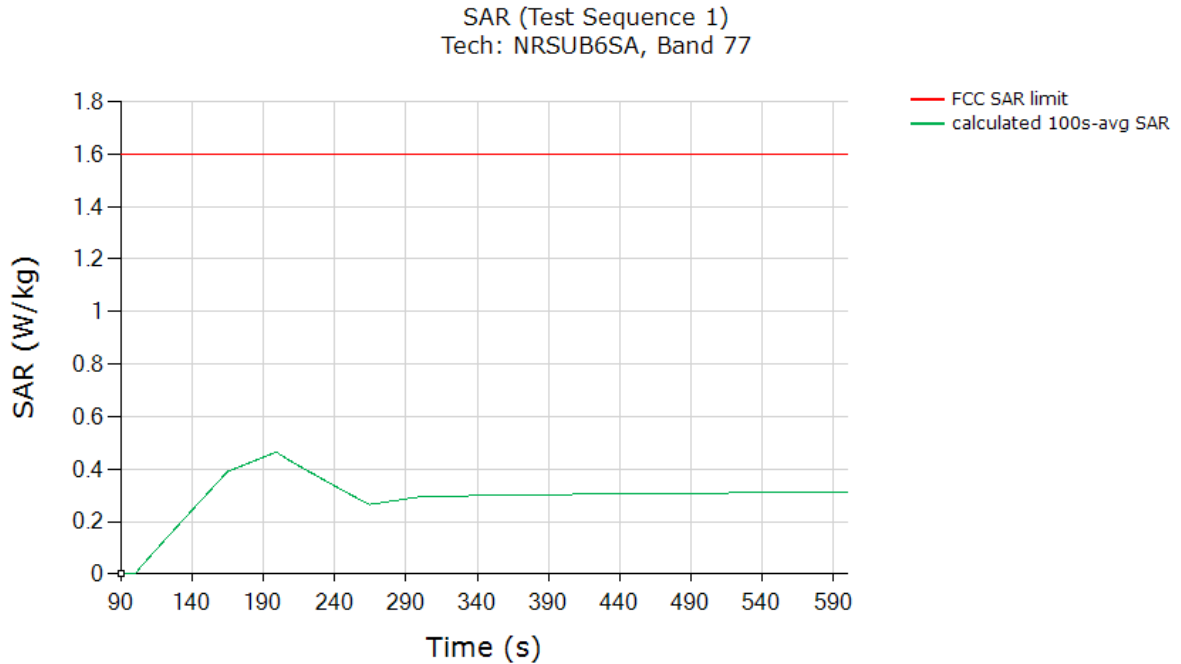

Above time-averaged conducted Tx power is converted/calculated into time-averaged 1g SAR using Equation (1a) and plotted below to demonstrate that the time-averaged 1g SAR versus time does not exceed the FCC limit of 1.6 W/kg for 1gSAR:

	(W/kg)
FCC 1gSAR limit	1.6
Max 60s-time averaged 1gSAR (green curve)	0.464
Validated: Max time averaged SAR (green curve) is within device uncertainty of measured SAR at Plimit	

Test result for test sequence 2:

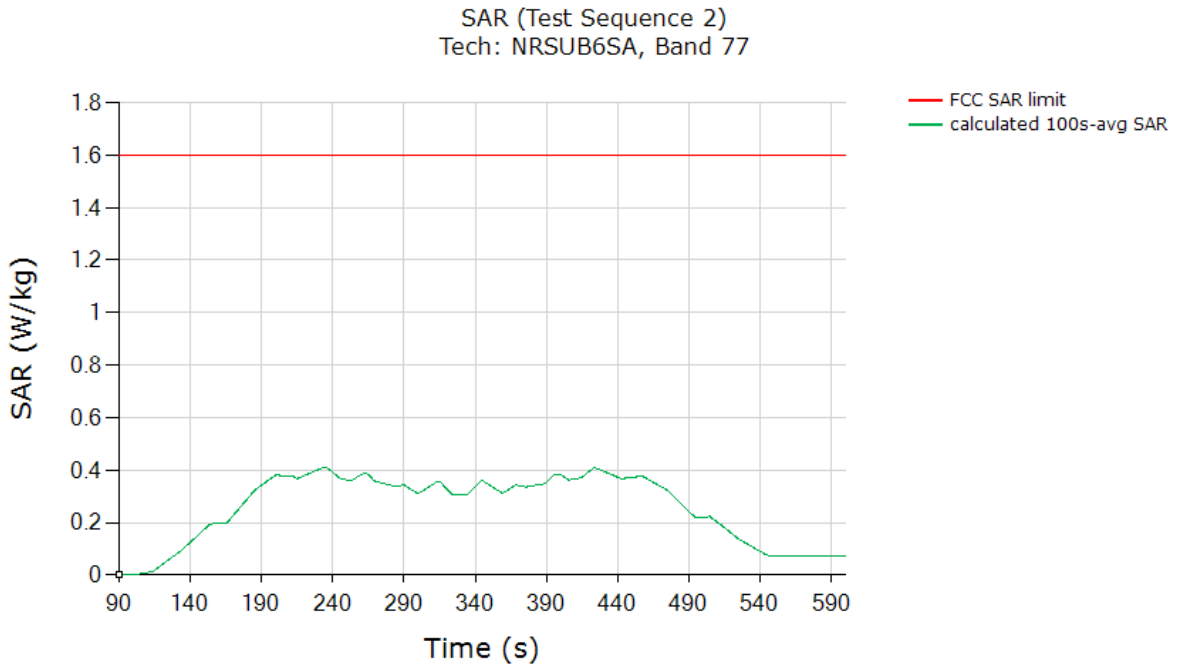

Above time-averaged conducted Tx power is converted/calculated into time-averaged 1g SAR using Equation (1a) and plotted below to demonstrate that the time-averaged 1g SAR versus time does not exceed the FCC limit of 1.6 W/kg for 1gSAR:

	(W/kg)
FCC 1gSAR limit	1.6
Max 60s-time averaged 1gSAR (green curve)	0.411
Validated: Max time averaged SAR (green curve) is within device uncertainty of measured SAR at Plimit	



8 Conclusions

Qualcomm Smart Transmit feature employed has been validated through the conducted/radiated power measurement, as well as SAR measurement

As demonstrated in this report, the power limiting enforcement is effective and the total normalized time-averaged RF exposure does not exceed 1.0 for all the transmission scenarios described in Section 2. Therefore, the EUT complies with FCC RF exposure requirement

Appendix A. Test Sequences

1. Test sequence is generated based on below parameters of the EUT:

a Measured maximum power (P_{max})

b Measured Tx_power_at_SAR_design_target (P_{limit})

c Reserve_power_margin (dB)

- $P_{reserve}$ (dBm) = measured P_{limit} (dBm) – Reserve_power_margin (dB)

d SAR_time_window (100s for FCC)

2. Test Sequence 1 Waveform:

Based on the parameters above, the Test Sequence 1 is generated with one transition between high and low Tx powers. Here, high power = P_{max} ; low power = $P_{max}/2$, and the transition occurs after 80 seconds at high power P_{max} . As long as the power enforcement is taking into effective during one 100s/60s time window, the validation test with this defined test sequence 1 is valid, otherwise, select other radio configuration (band/DSI within the same technology group) having lower P_{limit} for this test. The Test sequence 1 waveform is shown below:

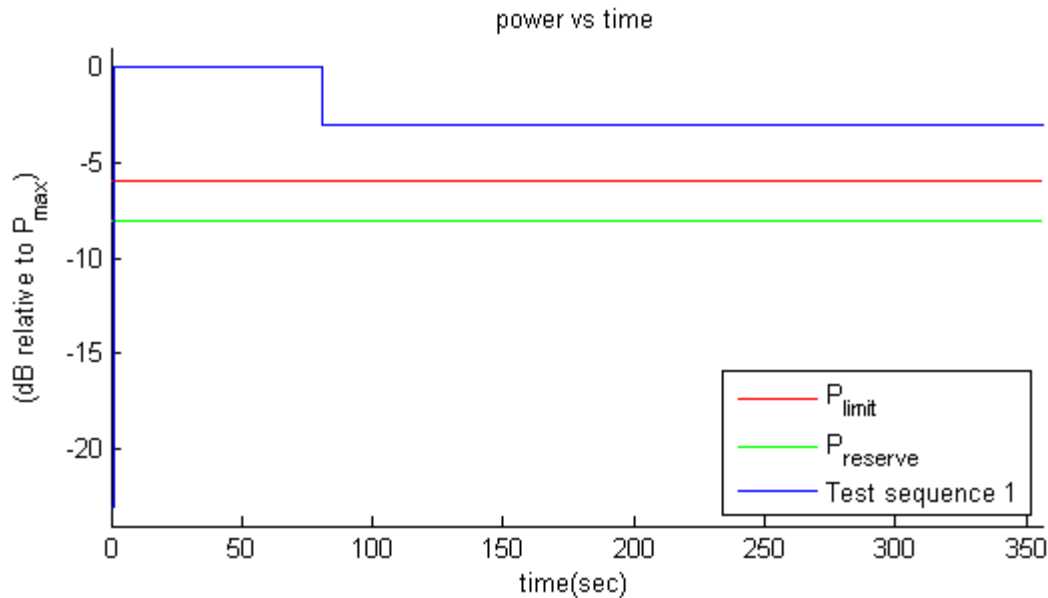

Figure A-1 Test sequence 1 waveform

3. Test Sequence 2 Waveform:

Based on the parameters in A-1, the Test Sequence 2 is generated as described in Table 10-1, which contains two 170 second-long sequences (yellow and green highlighted rows) that are mirrored around the center row of 20s, resulting in a total duration of 360 seconds:

Table A-1 Test Sequence 2

Time duration (seconds)	dB relative to P_{limit} or $P_{reserve}$
15	$P_{reserve}$
20	P_{limit}
20	$(P_{limit} + P_{max})/2$ averaged in mW and rounded to nearest 0.1 dB step
10	$P_{reserve}$
20	P_{max}
15	P_{limit}
15	$P_{reserve}$
20	P_{max}
10	$P_{reserve}$
15	P_{limit}
10	$P_{reserve}$
20	$(P_{limit} + P_{max})/2$ averaged in mW and rounded to nearest 0.1 dB step
10	$P_{reserve}$
15	P_{limit}
10	$P_{reserve}$
20	P_{max}
15	$P_{reserve}$
15	P_{limit}
20	P_{max}
10	$P_{reserve}$
20	$(P_{limit} + P_{max})/2$ averaged in mW and rounded to nearest 0.1 dB step
20	P_{limit}
15	$P_{reserve}$

The Test Sequence 2 waveform is shown in Figure A-2.

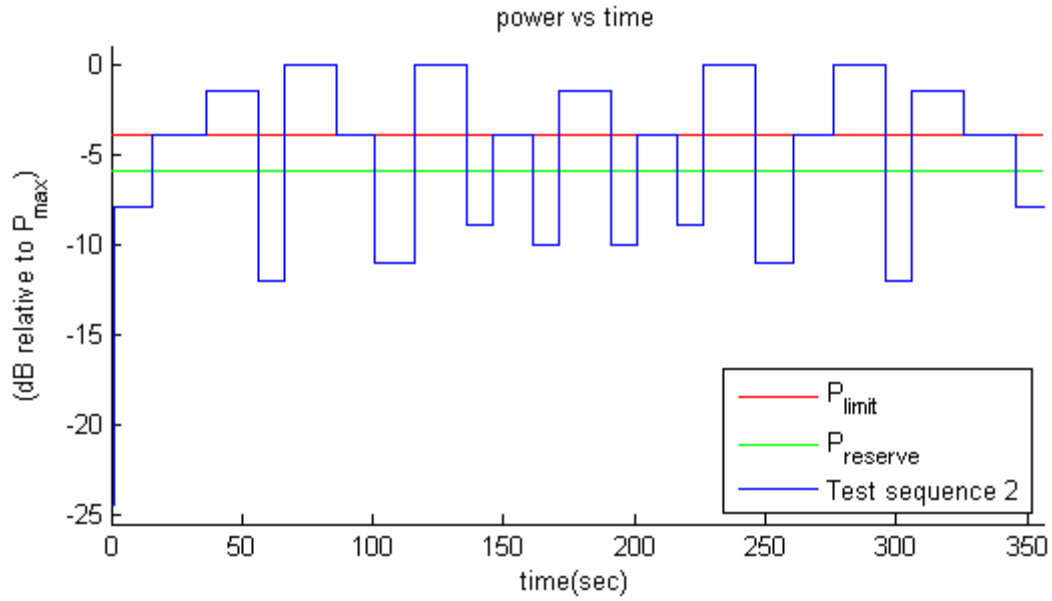

Appendix B Test Procedures for sub6 NR + LTE Radio

Appendix B provides the test procedures for validating Qualcomm Smart Transmit feature for LTE + Sub6 NR non-standalone (NSA) mode transmission scenario, where sub-6GHz LTE link acts as an anchor.

B.1 Time-varying Tx power test for sub6 NR in NSA mode

Follows Section 3.2.1 to select test configurations for time-varying test. This test is performed with two pre-defined test sequences (described in Section 3.1) applied to Sub6 NR (with LTE on all-down bits or low power for the entire test after establishing the LTE+Sub6 NR call with the callbox). Follow the test procedures described in Section 3.3.1 to demonstrate the effectiveness of power limiting enforcement and that the time averaged Tx power of Sub6 NR when converted into 1gSAR values does not exceed the regulatory limit at all times (see Eq. (1a) and (1b)). Sub6 NR response to test sequence1 and test sequence2 will be similar to other technologies (say, LTE), and are shown in Sections 5

B.2 Switch in SAR exposure between LTE vs. Sub6 NR during transmission

This test is to demonstrate that Smart Transmit feature accurately accounts for switching in exposures among SAR for LTE radio only, SAR from both LTE radio and sub6 NR, and SAR from sub6 NR only scenarios, and ensures total time-averaged RF exposure compliance with FCC limit.

Test procedure:

1. Measure conducted Tx power corresponding to P_{limit} for LTE and sub6 NR in selected band. Test condition to measure conducted P_{limit} is:

Establish device in call with the callbox for LTE in desired band. Measure conducted Tx power corresponding to LTE P_{limit} with Smart Transmit enabled and *Reserve_power_margin* set to 0 dB, callbox set to request maximum power.

Repeat above step to measure conducted Tx power corresponding to Sub6 NR P_{limit} . If testing LTE+Sub6 NR in non-standalone mode, then establish LTE+Sub6 NR call with callbox and request all down bits for radio1 LTE. In this scenario, with callbox requesting maximum power from Sub6

NR, measured conducted Tx power corresponds to radio2 P_{limit} (as radio1 LTE is at all-down bits)

2. Set *Reserve_power_margin* to actual (intended) value with EUT setup for LTE + Sub6 NR call. First, establish LTE connection in all-up bits with the callbox, and then Sub6 NR connection is added with callbox requesting UE to transmit at maximum power in Sub6 NR. As soon as the Sub6 NR connection is established, request all-down bits on LTE link (otherwise, Sub6 NR will not have sufficient RF exposure margin to sustain the call with LTE in all-up bits). Continue LTE (all-down bits)+Sub6 NR transmission for more than one time-window duration to test predominantly Sub6 NR SAR exposure scenario (as SAR exposure is negligible from all-down bits in LTE). After at least one time-window, request LTE to go all-up bits to test LTE SAR and Sub6 NR SAR exposure scenario. After at least one more time-window, drop (or request all-down bits) Sub6 NR transmission to test predominantly LTE SAR exposure scenario. Continue the test for at least one more time-window. Record the conducted Tx powers for both LTE and Sub6 NR for the entire duration of this test.

3. Once the measurement is done, extract instantaneous Tx power versus time for both LTE and Sub6 NR links. Similar to technology/band switch test in Section 3.3.3, convert the conducted Tx power for both these radios into 1gSAR value (see Eq. (6a) and (6b)) using corresponding technology/band P_{limit} measured in Step 1, and then perform 100s running average to determine time-averaged 1gSAR versus time as illustrated in Figure 3-1. Note that here it is assumed both radios have Tx frequencies < 3GHz, otherwise, 60s running average should be performed for radios having Tx frequency between 3GHz and 6GHz.

4. Make one plot containing: (a) instantaneous Tx power versus time measured in Step2.

5. Make another plot containing: (a) instantaneous 1gSAR versus time determined in Step 3, (b) computed time-averaged 1gSAR versus time determined in Step 3, and (c) corresponding regulatory $1gSAR_{limit}$ of 1.6W/kg.

The validation criteria is, at all times, the time-averaged 1gSAR versus time shall not exceed the regulatory $1gSAR_{limit}$ of 1.6W/kg.

Appendix C DASY6 System Validation

C.1 SAR system verification and validation

Table C-1 provides the list of calibrated equipment for SAR measurement system verification.

Table C-1 List of calibrated equipment

	Name	Type	Serial Number	Calibration Date	Valid Period
01	Network analyzer	N5239A	MY55491241	June 5, 2023	One year
02	Power sensor	NRP8S	104291	September 22, 2022	One year
03	Power sensor	NRP8S	104292		
05	Signal Generator	E4438C	MY49071430	January 19, 2023	One Year
06	Amplifier	60S1G4	0331848	No Calibration Requested	
07	Dual directional coupler	778D	MY48220216	No Calibration Requested	
08	Dual directional coupler	772D	MY46151265	No Calibration Requested	
09	BTS	CMW500	170672	April 18, 2023	One year
10	5G Wireless Test Platform	E7515B	MY60192696	July 15,2022	One year
11	E-field Probe	SPEAG EX3DV4	7600	December 10, 2022	One year
12	DAE	SPEAG DAE4	1331	September 15,2022	One year
13	Dipole Validation Kit	SPEAG D1750V2	1003	July 18,2022	One year
14	Dipole Validation Kit	SPEAG D1900V2	5d101	July 26,,2022	One year
15	Dipole Validation Kit	SPEAG D2600V2	1012	July 20,2022	One year
16	Dipole Validation Kit	SPEAG D3500V2	1016	July 01,2022	One year

Note: According to KDB 865664 D01, longer calibration intervals of up to three years may be considered when it is demonstrated that the SAR target, impedance and return loss of a dipole have remain stable according to the KDB requirements, refer to the appendix I for details in Part1 report.

The system verification was performed using a dipole antenna against the flat section of the SAM phantom. Table C-2 shows the verification test results. The measured SAR values for the frequency bands of interest were within $\pm 10\%$ of the corresponding target SAR levels.

Table C-1 System validation results

Calibration Date	Frequency	Target value (W/kg)		Measured value (W/kg)		Deviation	
		10 g Average	1 g Average	10 g Average	1 g Average	10 g Average	1 g Average
2023/6/17	1750 MHz	19.3	36.8	19.4	36.0	0.52%	-2.07%
2023/6/18	1900 MHz	20.7	39.7	20.3	39.3	-2.03%	-1.06%
2023/6/19	2600 MHz	25.2	55.8	24.1	54.8	-4.44%	-1.79%
2023/6/20	3500 MHz	25.3	6.79	24.7	65.6	-2.37%	866.13%

Table C-2 Tissue dielectric properties at the time of testing

Measurement Date yyyy/mm/dd	Frequency	Type	Permittivity ϵ	Drift (%)	Conductivity σ (S/m)	Drift (%)
2023/6/17	1750 MHz	Head	41.44	3.39	1.367	-0.22
2023/6/18	1900 MHz	Head	41.27	3.18	1.439	2.79
2023/6/19	2600 MHz	Head	40.07	2.72	1.990	1.53
2023/6/20	3500 MHz	Head	38.22	0.76	2.841	-2.37

1750 MHz

Date: 6/17/2023

Electronics: DAE4 Sn1331

Medium: H700-6000M

Medium parameters used: $f = 1750$ MHz; $\sigma = 1.367$ S/m; $\epsilon_r = 41.44$; $\rho = 1000$ kg/m³

Ambient Temperature: 23.3°C Liquid Temperature: 22.5°C

Communication System: UID 0, CW (0) Frequency: 1750 MHz Duty Cycle: 1:1

Probe: EX3DV4 – SN7600 ConvF(9, 9, 9)

Area Scan (81x191x1): Interpolated grid: $dx=1.000$ mm, $dy=1.000$ mm

Maximum value of SAR (interpolated) = 14.31 W/kg

Zoom Scan (7x7x7)/Cube 0: Measurement grid: $dx=5$ mm, $dy=5$ mm, $dz=5$ mm

Reference Value = 104.5 V/m; Power Drift = 0.06 dB

Peak SAR (extrapolated) = 16.53 W/kg

SAR(1 g) = 9.01 W/kg; SAR(10 g) = 4.85 W/kg

Maximum value of SAR (measured) = 13.9 W/kg

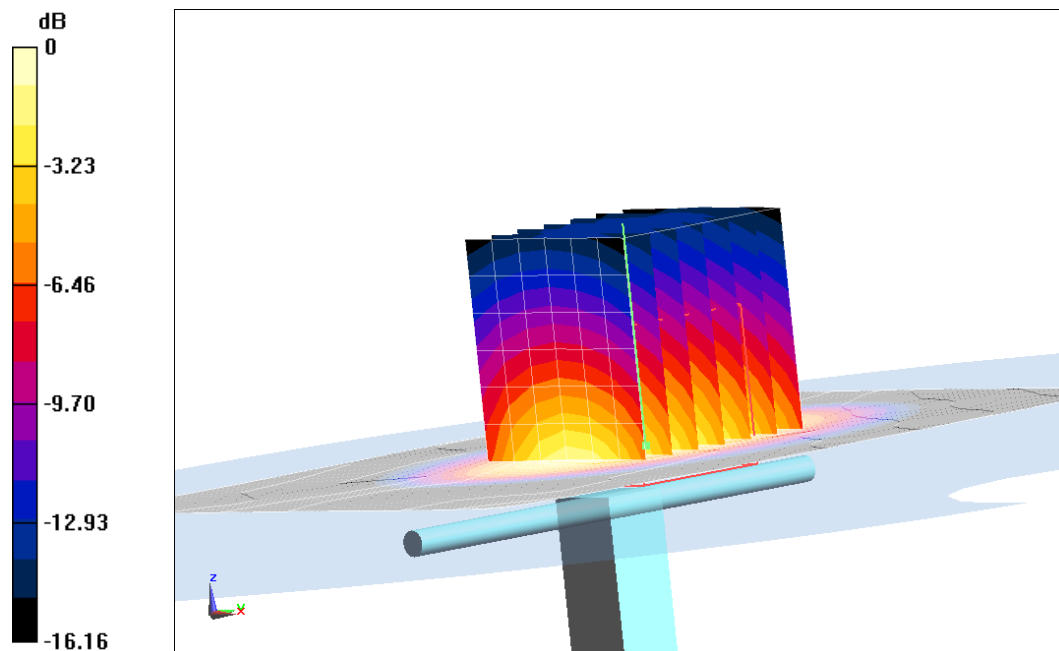

0 dB = 13.9 W/kg = 11.43 dB W/kg

1900 MHz

Date: 6/18/2023

Electronics: DAE4 Sn1331

Medium: H700-6000M

Medium parameters used: $f = 1900$ MHz; $\sigma = 1.439$ S/m; $\epsilon_r = 41.27$; $\rho = 1000$ kg/m³

Ambient Temperature: 23.3°C Liquid Temperature: 22.5°C

Communication System: UID 0, CW (0) Frequency: 1900 MHz Duty Cycle: 1:1

Probe: EX3DV4 – SN7600 ConvF(8.7, 8.7, 8.7)

Area Scan (81x191x1): Interpolated grid: $dx=1.000$ mm, $dy=1.000$ mm

Maximum value of SAR (interpolated) = 15.05 W/kg

Zoom Scan (7x7x7)/Cube 0: Measurement grid: $dx=5$ mm, $dy=5$ mm, $dz=5$ mm

Reference Value = 107.08 V/m; Power Drift = -0.04dB

Peak SAR (extrapolated) = 17.63 W/kg

SAR(1 g) = 9.82 W/kg; SAR(10 g) = 5.07 W/kg

Maximum value of SAR (measured) = 14.66 W/kg

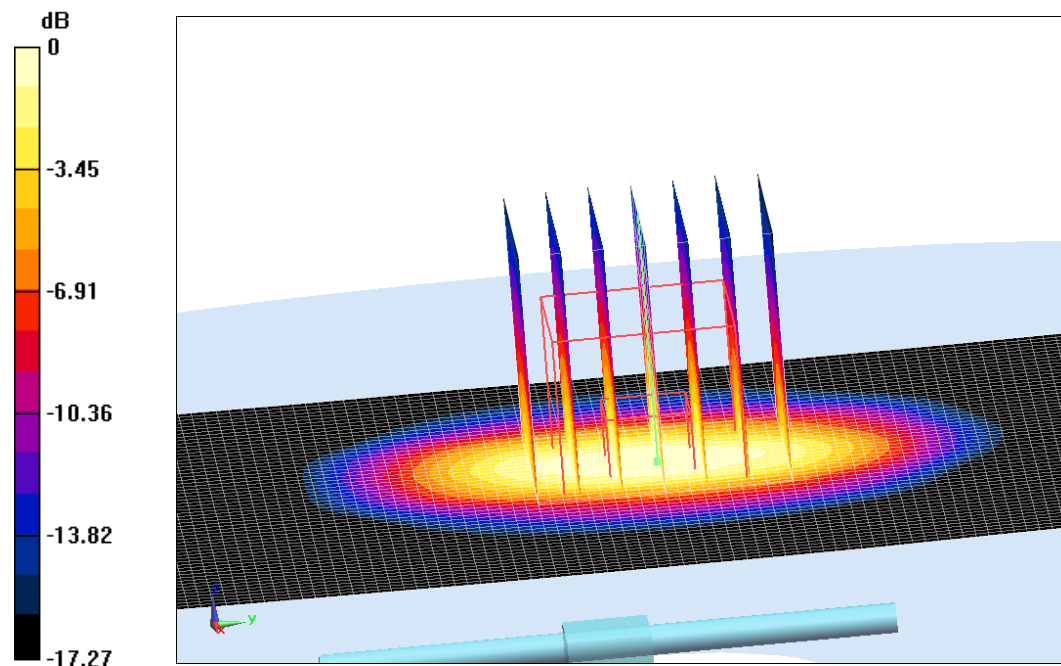

0 dB = 14.66 W/kg = 11.66 dB W/kg

2600MHz

Date: 6/19/2023

Electronics: DAE4 Sn1331

Medium: H700-6000M

Medium parameters used: $f = 2600$ MHz; $\sigma = 1.99$ S/m; $\epsilon_r = 40.07$; $\rho = 1000$ kg/m³

Ambient Temperature: 23.3°C Liquid Temperature: 22.5°C

Communication System: UID 0, CW (0) Frequency: 2600 MHz Duty Cycle: 1:1

Probe: EX3DV4 – SN7600 ConvF(7.78, 7.78, 7.78)

Area Scan (61x61x1): Interpolated grid: $dx=1.200$ mm, $dy=1.200$ mm

Maximum value of SAR (interpolated) = 23.8 W/kg

Zoom Scan (7x7x7) (7x7x7)/Cube 0: Measurement grid: $dx=5$ mm, $dy=5$ mm, $dz=5$ mm

Reference Value = 107.0 V/m; Power Drift = -0.02 dB

Peak SAR (extrapolated) = 30.2 W/kg

SAR(1 g) = 13.7 W/kg; SAR(10 g) = 6.02 W/kg

Maximum value of SAR (measured) = 24.0 W/kg

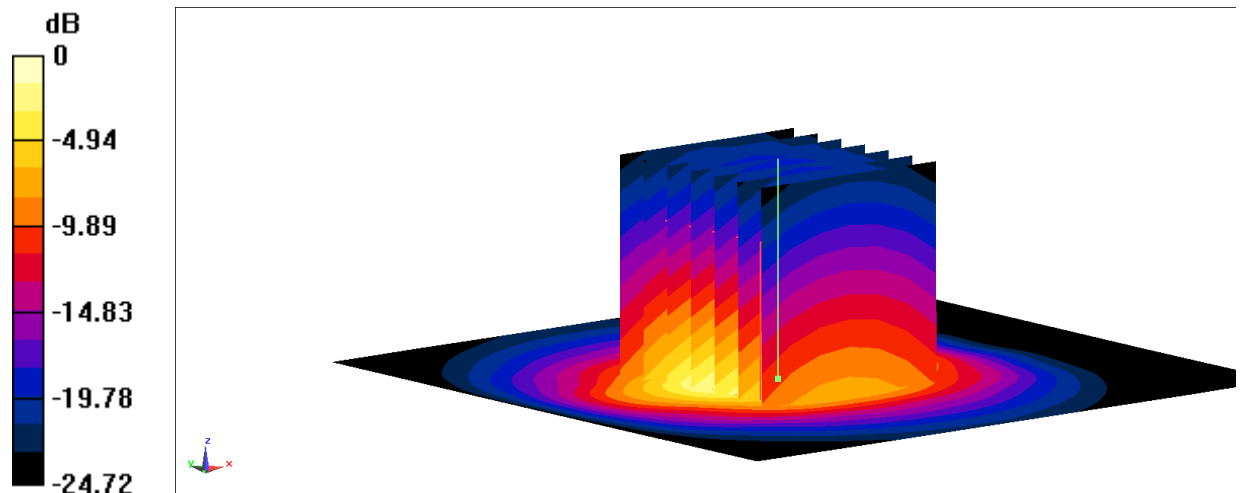

0 dB = 24.0 W/kg = 13.80 dBW/kg

3500MHz

Date: 6/20/2023

Electronics: DAE4 Sn1331

Medium: H700-6000M

Medium parameters used: $f = 3500 \text{ MHz}$; $\sigma = 2.841 \text{ S/m}$; $\epsilon_r = 38.22$; $\rho = 1000 \text{ kg/m}^3$

Ambient Temperature: 23.3°C Liquid Temperature: 22.5°C

Communication System: UID 0, CW (0) Frequency: 3500 MHz Duty Cycle: 1:1

Probe: EX3DV4 – SN7600 ConvF(7.3, 7.3, 7.3)

Area Scan (91x91x1): Interpolated grid: $dx=1.000 \text{ mm}$, $dy=1.000 \text{ mm}$

Maximum value of SAR (interpolated) = 12.4 W/kg

Zoom Scan (4x4x1.4mm, graded), $dist=1.4\text{mm}$ (8x8x8)/Cube 0: Measurement grid: $dx=4\text{mm}$, $dy=4\text{mm}$, $dz=1.4\text{mm}$

Reference Value = 69.66 V/m ; Power Drift = -0.05 dB

Peak SAR (extrapolated) = 16.9 W/kg

SAR(1 g) = 6.56 W/kg ; SAR(10 g) = 2.47 W/kg

Maximum value of SAR (measured) = 12.2 W/kg

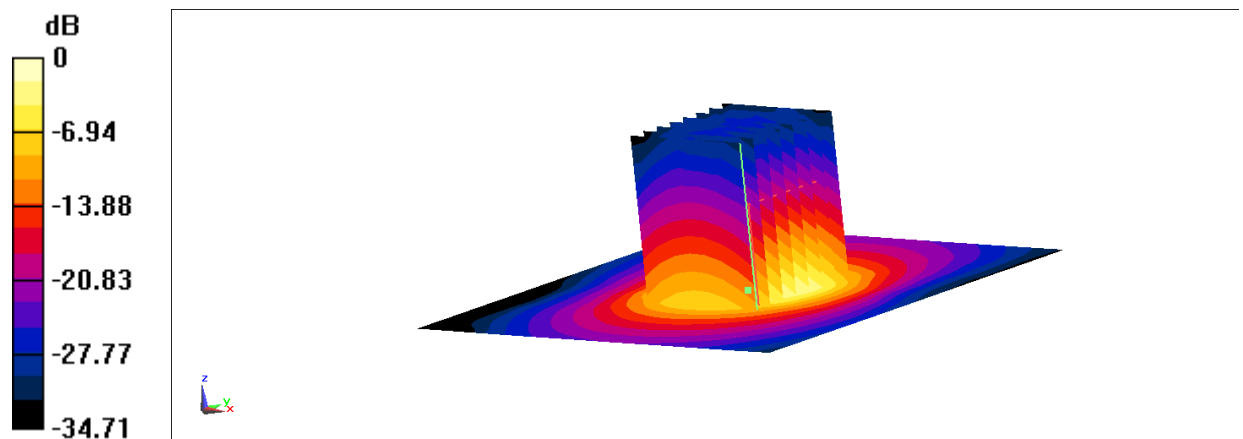

0 dB = 12.2 W/kg = 10.86 dBW/kg





Appendix D Calibration Certificate of Probe and Dipole

Probe 7600 Calibration Certificate



In Collaboration with
TTL *s p e a g*
CALIBRATION LABORATORY

Add: No.52 HuaYuanBei Road, Haidian District, Beijing, 100191, China
Tel: +86-10-62304633-2117
E-mail: emf@caict.ac.cn http://www.caict.ac.cn

中国认可
国际互认
校准
CALIBRATION
CNAS L0570



Client **CTTL**
Certificate No: **Z22-60492**

CALIBRATION CERTIFICATE

Object	EX3DV4 - SN : 7600
Calibration Procedure(s)	FF-Z11-004-02 Calibration Procedures for Dosimetric E-field Probes
Calibration date:	December 10, 2022



This calibration Certificate documents the traceability to national standards, which realize the physical units of measurements(SI). The measurements and the uncertainties with confidence probability are given on the following pages and are part of the certificate.

All calibrations have been conducted in the closed laboratory facility: environment temperature(22±3)°C and humidity<70%.

Calibration Equipment used (M&TE critical for calibration)

Primary Standards	ID #	Cal Date(Calibrated by, Certificate No.)	Scheduled Calibration
Power Meter NRP2	101919	14-Jun-22(CTTL, No.J22X04181)	Jun-23
Power sensor NRP-Z91	101547	14-Jun-22(CTTL, No.J22X04181)	Jun-23
Power sensor NRP-Z91	101548	14-Jun-22(CTTL, No.J22X04181)	Jun-23
Reference 10dBAttenuator	18N50W-10dB	20-Jan-21(CTTL, No.J21X00486)	Jan-23
Reference 20dBAttenuator	18N50W-20dB	20-Jan-21(CTTL, No.J21X00485)	Jan-23
Reference Probe EX3DV4	SN 3846	20-May-22(SPEAG, No.EX3-3846_May22)	May-23
DAE4	SN 771	20-Jan-22(SPEAG, No.DAE4-771_Jan22)	Jan-23

Secondary Standards	ID #	Cal Date(Calibrated by, Certificate No.)	Scheduled Calibration
SignalGenerator MG3700A	6201052605	14-Jun-22(CTTL, No.J22X04182)	Jun-23
Network Analyzer E5071C	MY46110673	14-Jan-22(CTTL, No.J22X00406)	Jan-23

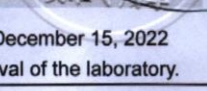
	Name	Function	Signature
Calibrated by:	Yu Zongying	SAR Test Engineer	
Reviewed by:	Lin Hao	SAR Test Engineer	
Approved by:	Qi Dianyuan	SAR Project Leader	

Issued: December 15, 2022

This calibration certificate shall not be reproduced except in full without written approval of the laboratory.

Certificate No: Z22-60492
Page 1 of 22

Glossary:

TSL	tissue simulating liquid
NORM _{x,y,z}	sensitivity in free space
ConvF	sensitivity in TSL / NORM _{x,y,z}
DCP	diode compression point
CF	crest factor (1/duty_cycle) of the RF signal
A,B,C,D	modulation dependent linearization parameters
Polarization Φ	Φ rotation around probe axis
Polarization θ	θ rotation around an axis that is in the plane normal to probe axis (at measurement center), i $\theta=0$ is normal to probe axis

Connector Angle information used in DASY system to align probe sensor X to the robot coordinate system

Calibration is Performed According to the Following Standards:

- IEEE Std 1528-2013, "IEEE Recommended Practice for Determining the Peak Spatial-Averaged Specific Absorption Rate (SAR) in the Human Head from Wireless Communications Devices: Measurement Techniques", June 2013
- IEC 62209-1, "Measurement procedure for the assessment of Specific Absorption Rate (SAR) from hand-held and body-mounted devices used next to the ear (frequency range of 300 MHz to 6 GHz)", July 2016
- IEC 62209-2, "Procedure to determine the Specific Absorption Rate (SAR) for wireless communication devices used in close proximity to the human body (frequency range of 30 MHz to 6 GHz)", March 2010
- KDB 865664, "SAR Measurement Requirements for 100 MHz to 6 GHz"

Methods Applied and Interpretation of Parameters:

- NORM_{x,y,z}**: Assessed for E-field polarization $\theta=0$ ($f \leq 900\text{MHz}$ in TEM-cell; $f > 1800\text{MHz}$: waveguide). NORM_{x,y,z} are only intermediate values, i.e., the uncertainties of NORM_{x,y,z} does not effect the E^2 -field uncertainty inside TSL (see below ConvF).
- NORM(f)_{x,y,z} = NORM_{x,y,z} * frequency_response** (see Frequency Response Chart). This linearization is implemented in DASY4 software versions later than 4.2. The uncertainty of the frequency response is included in the stated uncertainty of ConvF.
- DCP_{x,y,z}**: DCP are numerical linearization parameters assessed based on the data of power sweep (no uncertainty required). DCP does not depend on frequency nor media.
- PAR**: PAR is the Peak to Average Ratio that is not calibrated but determined based on the signal characteristics.
- A_{x,y,z}; B_{x,y,z}; C_{x,y,z}; VR_{x,y,z}; A,B,C** are numerical linearization parameters assessed based on the data of power sweep for specific modulation signal. The parameters do not depend on frequency nor media. VR is the maximum calibration range expressed in RMS voltage across the diode.
- ConvF and Boundary Effect Parameters**: Assessed in flat phantom using E-field (or Temperature Transfer Standard for $f \leq 800\text{MHz}$) and inside waveguide using analytical field distributions based on power measurements for $f > 800\text{MHz}$. The same setups are used for assessment of the parameters applied for boundary compensation (alpha, depth) of which typical uncertainty valued are given. These parameters are used in DASY4 software to improve probe accuracy close to the boundary. The sensitivity in TSL corresponds to NORM_{x,y,z} * ConvF whereby the uncertainty corresponds to that given for ConvF. A frequency dependent ConvF is used in DASY version 4.4 and higher which allows extending the validity from $\pm 50\text{MHz}$ to $\pm 100\text{MHz}$.
- Spherical isotropy (3D deviation from isotropy)**: in a field of low gradients realized using a flat phantom exposed by a patch antenna.
- Sensor Offset**: The sensor offset corresponds to the offset of virtual measurement center from the probe tip (on probe axis). No tolerance required.
- Connector Angle**: The angle is assessed using the information gained by determining the NORM_x (no uncertainty required).

Add: No.52 HuaYuanBei Road, Haidian District, Beijing, 100191, China
Tel: +86-10-62304633-2117
E-mail: emf@caict.ac.cn http://www.caict.ac.cn

DASY/EASY – Parameters of Probe: EX3DV4 – SN: 7600

Basic Calibration Parameters

	Sensor X	Sensor Y	Sensor Z	Unc (k=2)
Norm($\mu\text{V}/(\text{V}/\text{m})^2$) ^A	0.68	0.65	0.67	±10.0%
DCP(mV) ^B	108.3	108.6	106.4	

Calibration Results for Modulation Response

UID	Communication System Name		A dB	B dB $\sqrt{\mu\text{V}}$	C	D dB	VR mV	Max Dev.	Max Unc ^E (k=2)
0	CW	X	0.0	0.0	1.0	0.00	222.0	±2.3%	±4.7%
		Y	0.0	0.0	1.0		205.6		
		Z	0.0	0.0	1.0		214.3		
10352-AAA	Pulse Waveform (200Hz, 10%)	X	1.72	61.18	6.53	10.00	60	±2.5%	±9.6%
		Y	2.00	62.00	7.00		60		
		Z	1.56	60.54	6.13		60		
10353-AAA	Pulse Waveform (200Hz, 20%)	X	0.89	60.00	4.54	6.99	80	±2.5%	±9.6%
		Y	8.00	72.00	9.00		80		
		Z	0.80	60.00	4.67		80		
10354-AAA	Pulse Waveform (200Hz, 40%)	X	0.01	126.75	1.31	3.98	95	±2.5%	±9.6%
		Y	0.06	131.27	0.93		95		
		Z	0.42	151.44	0.20		95		
10355-AAA	Pulse Waveform (200Hz, 60%)	X	0.00	156.99	37.01	2.22	120	±1.4%	±9.6%
		Y	17.38	130.82	12.32		120		
		Z	0.38	157.40	17.73		120		
10387-AAA	QPSK Waveform, 1 MHz	X	0.47	60.32	9.42	1.00	150	±4.1%	±9.6%
		Y	0.42	61.55	10.68		150		
		Z	0.55	63.14	11.19		150		
10388-AAA	QPSK Waveform, 10 MHz	X	1.18	63.27	12.03	0.00	150	±1.4%	±9.6%
		Y	1.14	64.75	12.47		150		
		Z	1.34	65.50	13.32		150		
10396-AAA	64-QAM Waveform, 100 kHz	X	1.75	64.72	16.38	3.01	150	±1.0%	±9.6%
		Y	1.79	65.61	16.95		150		
		Z	1.76	65.10	16.84		150		
10414-AAA	WLAN CCDF, 64-QAM, 40MHz	X	3.93	66.14	15.11	0.00	150	±4.3%	±9.6%
		Y	3.67	66.34	15.09		150		
		Z	3.87	66.06	15.15		150		

Note: For details on UID parameters see Appendix

The reported uncertainty of measurement is stated as the standard uncertainty of Measurement multiplied by the coverage factor $k=2$, which for a normal distribution Corresponds to a coverage probability of approximately 95%.

^A The uncertainties of Norm X, Y, Z do not affect the E^2 -field uncertainty inside TSL (see Page 5).

^B Numerical linearization parameter: uncertainty not required.

^E Uncertainty is determined using the max. deviation from linear response applying rectangular distribution and is expressed for the square of the field value.



Add: No.52 HuaYuanBei Road, Haidian District, Beijing, 100191, China
 Tel: +86-10-62304633-2117
 E-mail: emf@caict.ac.cn http://www.caict.ac.cn

DASY/EASY – Parameters of Probe: EX3DV4 – SN: 7600

Sensor Model Parameters

	C1 fF	C2 fF	α V ⁻¹	T1 ms.V ⁻²	T2 ms.V ⁻¹	T3 ms	T4 V ⁻²	T5 V ⁻¹	T6
X	10.42	74.86	32.79	1.01	0.00	4.90	0.32	0.00	1.01
Y	7.54	54.24	32.96	0.97	0.00	4.90	0.34	0.00	1.01
Z	10.07	72.74	33.22	2.19	0.00	4.90	0.00	0.04	1.01

Other Probe Parameters

Sensor Arrangement	Triangular
Connector Angle (°)	43.4
Mechanical Surface Detection Mode	enabled
Optical Surface Detection Mode	disable
Probe Overall Length	337mm
Probe Body Diameter	10mm
Tip Length	9mm
Tip Diameter	2.5mm
Probe Tip to Sensor X Calibration Point	1mm
Probe Tip to Sensor Y Calibration Point	1mm
Probe Tip to Sensor Z Calibration Point	1mm
Recommended Measurement Distance from Surface	1.4mm

DASY/EASY – Parameters of Probe: EX3DV4 – SN:7600

Calibration Parameter Determined in Head Tissue Simulating Media

f [MHz] ^C	Relative Permittivity ^F	Conductivity (S/m) ^F	ConvF X	ConvF Y	ConvF Z	Alpha ^G	Depth ^G (mm)	Unct. (k=2)
750	41.9	0.89	10.99	10.99	10.99	0.16	1.17	±12.7%
900	41.5	0.97	10.45	10.45	10.45	0.16	1.30	±12.7%
1450	40.5	1.20	9.30	9.30	9.30	0.12	1.12	±12.7%
1750	40.1	1.37	9.00	9.00	9.00	0.24	1.05	±12.7%
1900	40.0	1.40	8.70	8.70	8.70	0.21	1.09	±12.7%
2000	40.0	1.40	8.58	8.58	8.58	0.20	1.14	±12.7%
2300	39.5	1.67	8.23	8.23	8.23	0.34	0.90	±12.7%
2450	39.2	1.80	7.96	7.96	7.96	0.48	0.72	±12.7%
2600	39.0	1.96	7.78	7.78	7.78	0.42	0.89	±12.7%
3300	38.2	2.71	7.52	7.52	7.52	0.39	0.89	±13.9%
3500	37.9	2.91	7.30	7.30	7.30	0.35	1.01	±13.9%
3700	37.7	3.12	7.09	7.09	7.09	0.33	1.05	±13.9%
3900	37.5	3.32	6.90	6.90	6.90	0.30	1.50	±13.9%
4100	37.2	3.53	6.84	6.84	6.84	0.30	1.40	±13.9%
4200	37.1	3.63	6.76	6.76	6.76	0.30	1.50	±13.9%
4400	36.9	3.84	6.65	6.65	6.65	0.30	1.50	±13.9%
4600	36.7	4.04	6.55	6.55	6.55	0.40	1.30	±13.9%
4800	36.4	4.25	6.50	6.50	6.50	0.40	1.33	±13.9%
4950	36.3	4.40	6.25	6.25	6.25	0.40	1.35	±13.9%
5250	35.9	4.71	5.66	5.66	5.66	0.40	1.50	±13.9%
5600	35.5	5.07	4.96	4.96	4.96	0.40	1.65	±13.9%
5750	35.4	5.22	5.13	5.13	5.13	0.40	1.60	±13.9%

^C Frequency validity above 300 MHz of ±100MHz only applies for DASY v4.4 and higher (Page 2), else it is restricted to ±50MHz. The uncertainty is the RSS of ConvF uncertainty at calibration frequency and the uncertainty for the indicated frequency band. Frequency validity below 300 MHz is ± 10, 25, 40, 50 and 70 MHz for ConvF assessments at 30, 64, 128, 150 and 220 MHz respectively. Above 5 GHz frequency validity can be extended to ± 110 MHz.

^F At frequency up to 6 GHz, the validity of tissue parameters (ϵ and σ) can be relaxed to ±10% if liquid compensation formula is applied to measured SAR values. The uncertainty is the RSS of the ConvF uncertainty for indicated target tissue parameters.

^G Alpha/Depth are determined during calibration. SPEAG warrants that the remaining deviation due to the boundary effect after compensation is always less than ± 1% for frequencies below 3 GHz and below ± 2% for the frequencies between 3-6 GHz at any distance larger than half the probe tip diameter from the boundary.



Add: No.52 HuaYuanBei Road, Haidian District, Beijing, 100191, China
Tel: +86-10-62304633-2117
E-mail: emf@caict.ac.cn http://www.caict.ac.cn

Frequency Response of E-Field (TEM-Cell: ifi110 EXX, Waveguide: R22)

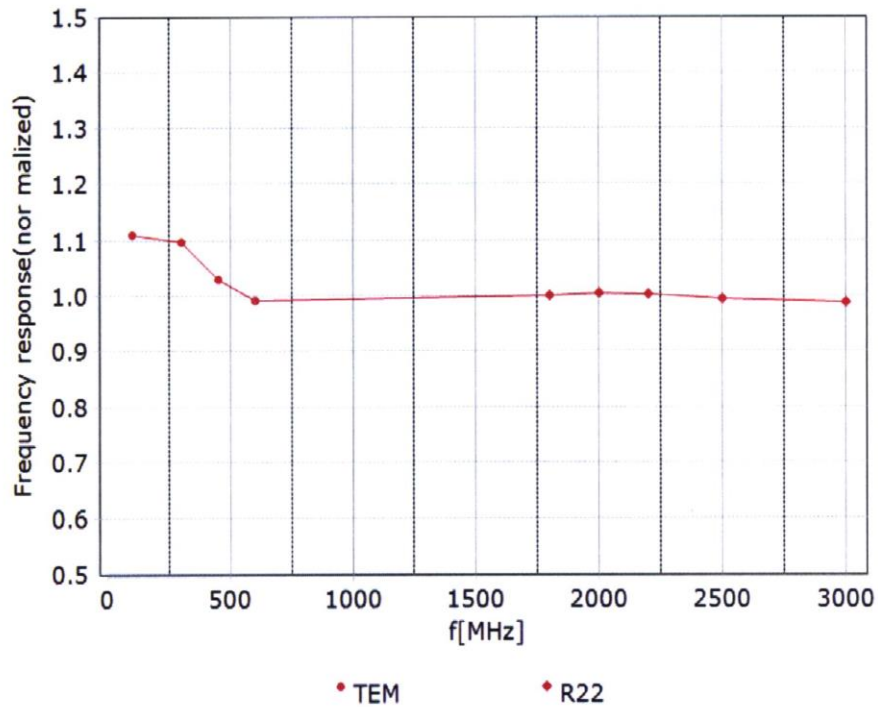

Uncertainty of Frequency Response of E-field: $\pm 7.4\%$ ($k=2$)



Add: No.52 HuaYuanBei Road, Haidian District, Beijing, 100191, China
 Tel: +86-10-62304633-2117
 E-mail: emf@caict.ac.cn http://www.caict.ac.cn

Receiving Pattern (Φ), $\theta=0^\circ$

f=600 MHz, TEM

f=1800 MHz, R22

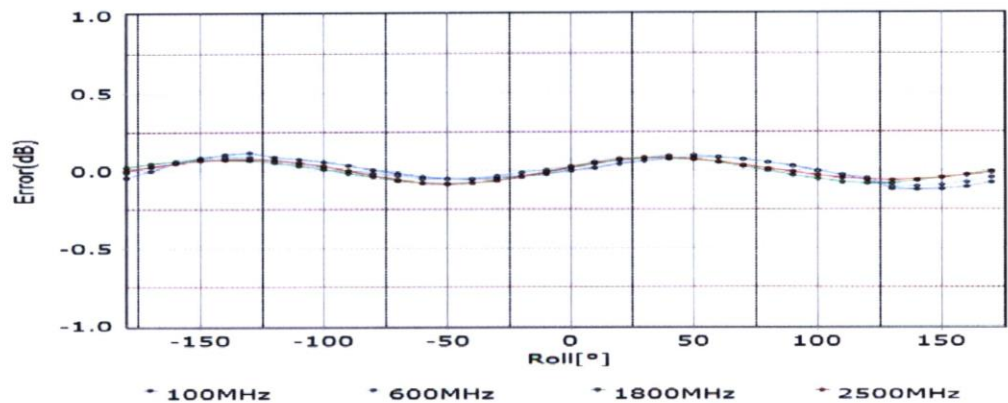
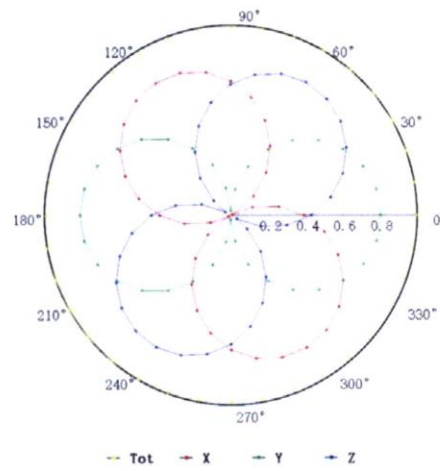
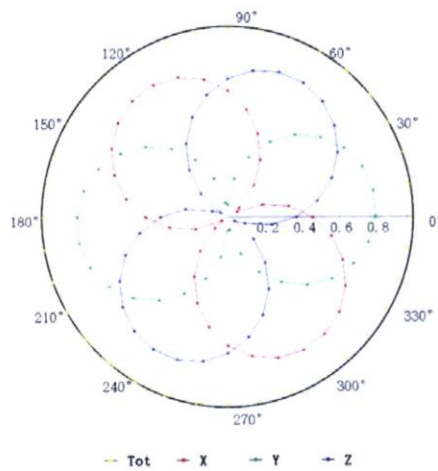

Uncertainty of Axial Isotropy Assessment: $\pm 1.2\%$ ($k=2$)

Add: No.52 HuaYuanBei Road, Haidian District, Beijing, 100191, China
 Tel: +86-10-62304633-2117
 E-mail: emf@caict.ac.cn <http://www.caict.ac.cn>

Dynamic Range f(SAR_{head}) (TEM cell, f = 900 MHz)

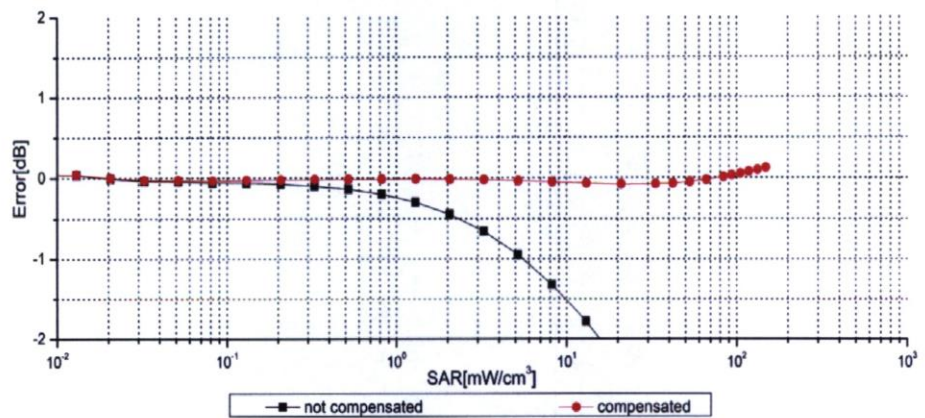
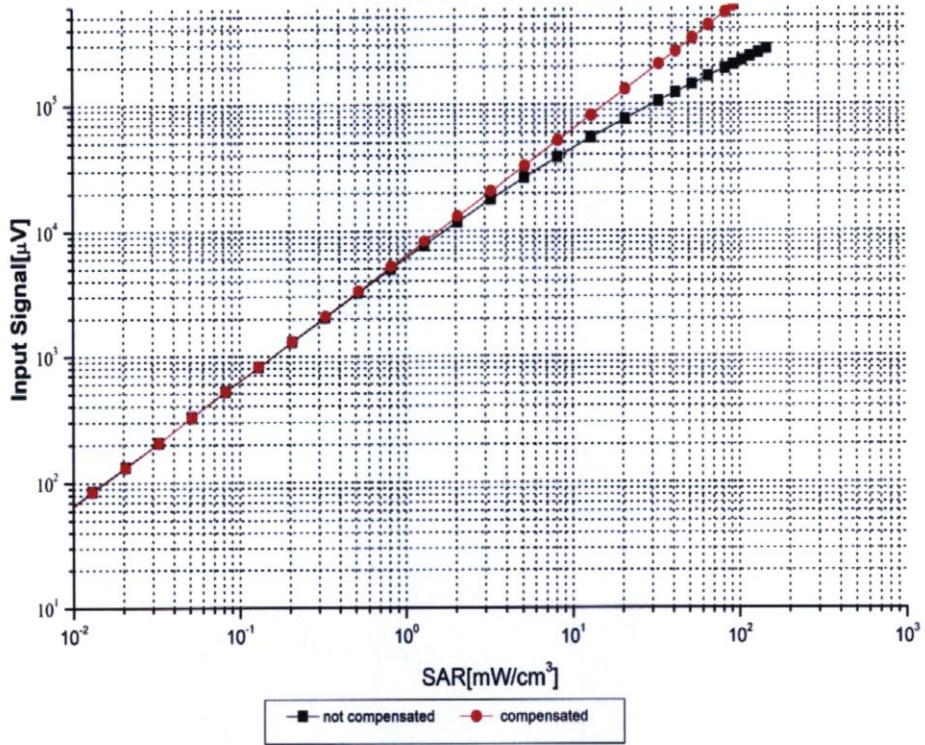

Uncertainty of Linearity Assessment: ±0.9% (k=2)

Add: No.52 HuaYuanBei Road, Haidian District, Beijing, 100191, China
Tel: +86-10-62304633-2117
E-mail: emf@caict.ac.cn http://www.caict.ac.cn

Conversion Factor Assessment

f=750 MHz,WGLS R9(H_convF)

f=1750 MHz,WGLS R22(H_convF)

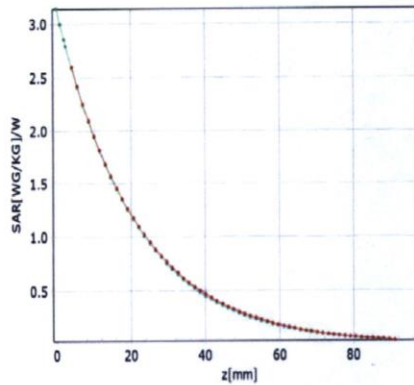

* analytical * measured

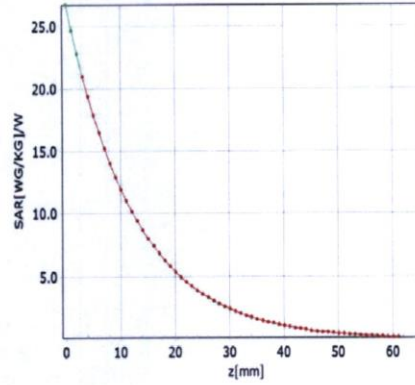

* analytical * measured

Deviation from Isotropy in Liquid

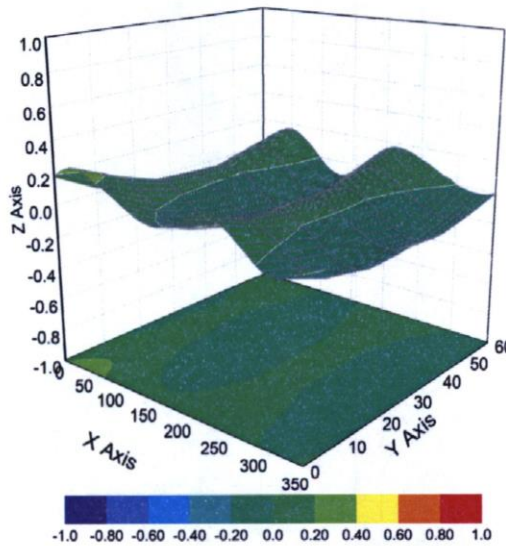

Uncertainty of Spherical Isotropy Assessment: $\pm 3.2\%$ ($k=2$)