



# NFC TEST REPORT

No.I21Z62312-IOT03

for

**OnePlus Technology (Shenzhen)Co., Ltd.**

**Smart Phone**

**GN2200**

**FCC ID : 2ABZ2-AA455**

with

**Hardware Version: 11**

**Software Version: GN2200\_11\_A.02**

**Issued Date: 2021-12-29**

**Note:**

The test results in this test report relate only to the devices specified in this report. This report shall not be reproduced except in full without the written approval of CTTL.

The report must not be used by the client to claim product certification, approval, or endorsement by NVLAP, NIST, or any agency of the U.S.Government.

**Test Laboratory:**

**CTTL-Telecommunication Technology Labs, CAICT**

No. 52, Huayuan North Road, Haidian District, Beijing, P. R. China 100191.

Tel:+86(0)10-62304633-2512, Fax:+86(0)10-62304633-2504

Email: [cttl\\_terminals@caict.ac.cn](mailto:cttl_terminals@caict.ac.cn), website: [www.caict.ac.cn](http://www.caict.ac.cn)



## **REPORT HISTORY**

<b>Report Number</b>	<b>Revision</b>	<b>Description</b>	<b>Issue Date</b>
I21Z62312-IOT03	Rev.0	1st edition	2021-12-29

## **CONTENTS**

<b>1. TEST LABORATORY .....</b>	<b>4</b>
<b>1.1. INTRODUCTION &amp; ACCREDITATION.....</b>	<b>4</b>
<b>1.2. TESTING LOCATION .....</b>	<b>4</b>
<b>1.3. TESTING ENVIRONMENT .....</b>	<b>5</b>
<b>1.4. PROJECT DATA .....</b>	<b>5</b>
<b>1.5. SIGNATURE.....</b>	<b>5</b>
<b>2. CLIENT INFORMATION.....</b>	<b>5</b>
<b>2.1. APPLICANT INFORMATION.....</b>	<b>6</b>
<b>2.2. MANUFACTURER INFORMATION.....</b>	<b>6</b>
<b>3. EQUIPMENT UNDER TEST (EUT) AND ANCILLARY EQUIPMENT (AE) .....</b>	<b>5</b>
<b>3.1. ABOUT EUT .....</b>	<b>7</b>
<b>3.2. INTERNAL IDENTIFICATION OF EUT .....</b>	<b>7</b>
<b>3.3. INTERNAL IDENTIFICATION OF AE .....</b>	<b>7</b>
<b>3.4. EUT SET-UPS.....</b>	<b>8</b>
<b>4. REFERENCE DOCUMENTS.....</b>	<b>9</b>
<b>4.1. DOCUMENTS SUPPLIED BY APPLICANT .....</b>	<b>9</b>
<b>4.2. REFERENCE DOCUMENTS FOR TESTING .....</b>	<b>9</b>
<b>5. TEST RESULTS .....</b>	<b>9</b>
<b>5.1. SUMMARY OF TEST RESULTS .....</b>	<b>10</b>
<b>5.2. STATEMENTS.....</b>	<b>11</b>
<b>6. TEST FACILITIES UTILIZED .....</b>	<b>12</b>
<b>7. MEASUREMENT UNCERTAINTY .....</b>	<b>13</b>
<b>ANNEX A: EUT PARAMETERS.....</b>	<b>14</b>
<b>ANNEX B: DETAILED TEST RESULTS.....</b>	<b>15</b>
<b>ANNEX C: PERSONS INVOLVED IN THIS TESTING .....</b>	<b>30</b>
<b>ANNEX D: ACCREDITATION CERTIFICATE .....</b>	<b>32</b>



## **1. Test Laboratory**

### **1.1. Introduction & Accreditation**

**Telecommunication Technology Labs, CAICT** is an ISO/IEC 17025:2017 accredited test laboratory under NATIONAL VOLUNTARY LABORATORY ACCREDITATION PROGRAM (NVLAP) with lab code 600118-0, and is also an FCC accredited test laboratory (CN5017), and ISED accredited test laboratory (ISED#: 24849). The detail accreditation scope can be found on NVLAP website.

### **1.2. Testing Location**

Location 1: CTTL(huayuan North Road)

Address: No. 52, Huayuan North Road, Haidian District, Beijing,  
P. R. China 100191

### 1.3. Testing Environment

Normal Temperature: 15-35°C  
Extreme Temperature: -20/+50°C  
Normal Relative Humidity: 20-75%  
Normal Air Pressure: 86Kpa-106Kpa

### 1.4. Project data

Testing Start Date: 2021-11-30  
Testing End Date: 2021-12-15

### 1.5. Signature



---

Zhou Bin  
(Prepared this test report)

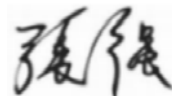

---

Zhang Qiang  
(Reviewed this test report)



---

Zhu Liang  
(Approved this test report)



## **2. Client Information**

### **2.1. Applicant Information**

Company Name: OnePlus Technology (Shenzhen) Co.,Ltd.  
Address: 18C02, 18C03, 18C04 and 18C05, Shum Yip Terra Building, Binhe Avenue North, Futian District, Shenzhen  
Contact: Jathan.Liu  
Email: jathan.liu@oneplus.com  
Telephone: 0086-755-61898696-7023

### **2.2. Manufacturer Information**

Company Name: OnePlus Technology (Shenzhen) Co.,Ltd.  
Address: 18C02, 18C03, 18C04 and 18C05, Shum Yip Terra Building, Binhe Avenue North, Futian District, Shenzhen  
Contact: jathan.Liu  
Email: Jathan.liu@oneplus.com  
Telephone: 0086-755-61898696-7023

### 3. Equipment Under Test (EUT) and Ancillary Equipment (AE)

#### 3.1. About EUT

Description	Smart Phone
Model name/HVIN	GN2200
Brand name	ONEPLUS
FCC ID	2ABZ2-AA455
GSM Frequency Bands	850/900/1800/1900
UMTS Frequency Bands	FDD I/ II/IV/V/VIII
E-UTRA Frequency Bands	FDD 1/2/3/4/5/7/8/12/13/17/20/25/26/28/66/71 TDD 38/39/41
5G NR FR1 Frequency Bands	N2/25/41/66/71
Operating Temperature	0/+35°C
Nominal Voltage	3.87V
Extreme High Voltage	4.45 V
Extreme Low Voltage	3.4 V

#### 3.2. Internal Identification of EUT

EUT ID*	SN	HW Version	SW Version	Date of receipt
UT06a	866966050025571	11	GN2200_11_A.02	2021-11-24
UT12a	866966050025092/1e 8476cd	11	GN2200_11_A.02	2021-11-16

\*EUT ID: is used to identify the test sample in the lab internally. The HW and SW versions were provided by the applicant.

#### 3.3. Internal Identification of AE

AE ID*	Description	Note
AE1-1	H121415BA1500104	CH001
AE1-1		
Model		VCB3HDUH
Manufacturer		Huangjiachiyuan
Length		/

\*AE ID: is used to identify the ancillary equipment in the lab internally.

### 3.4. EUT Set-ups

**Table 1: Eut Set-ups**

<b>EUT Set-up No.</b>	<b>Combination of EUT and AE</b>	<b>Remarks</b>
Set.NFC01	UT12a + AE1-1+NFC Card	Charging
Set.NFC02	UT12a + NFC Card	--
Set.NFC03	UT06a	--

The Transmit State of NFC: the NFC function is on. The EUT will transmit the NFC data and command continuously during the test.

The Transmit state without modulation: The EUT will transmit the CW signal at the operating frequency.



## **4. Reference Documents**

### **4.1. Documents supplied by applicant**

EUT parameters, referring to Annex A for detailed information, are supplied by the client or manufacturer, which are the bases of testing.

### **4.2. Reference Documents for testing**

The following documents listed in this section are referred for testing.

<b>Reference</b>	<b>Title</b>	<b>Version</b>
CFR 47 Part 2	Part 2 — Frequency Allocations and Radio Treaty Matters; General Rules and Regulations.	2019
CFR 47 Part 15	Part 15 — Radio Frequency Devices.  Subpart C — Intentional Radiators.  § 15.35 Measurement detector functions and bandwidths.  § 15.207 Conducted limits.  § 15.209 Radiated emission limits, general requirements.  § 15.215 Additional provisions to the general radiated emission limitations.  § 15.225 Operation within the band 13.110–14.010 MHz.	2019
ANSI C63.10	American National Standard of Procedures for Compliance  Testing of Unlicensed Wireless Devices	2013

## 5. Test Results

### 5.1. Summary of Test Results

**Table 2: Summary of Test Results**

No	Test Cases	Clause in Regulation	Section in This Report	Verdict
1	Electric Field Strength of Fundamental Emissions	CFR 47 § 15.225(a)	B.1	P(Set. NFC02)
2	Electric Field Strength of Outside the Allocated Bands	CFR 47 § 15.225(b) CFR 47 § 15.225(c)		P(Set. NFC02)
3	Electric Field Radiated Emissions	CFR 47 § 15.209	B.2	P(Set. NFC01)
		CFR 47 § 15.225(d)	B.3	P(Set. NFC01)
4	Frequency Tolerance	CFR 47 § 15.225(e)	B.4	P(Set. NFC03)
5	20dB Bandwidth	CFR 47 § 15.215(c)	B.5	P(Set. NFC03)
6	Conducted Emissions	CFR 47 § 15.207	B.6	P(Set. NFC01)
The measurement is carried out according to ANSI C63.10. See <b>ANNEX B</b> for details.				

#### Test Conditions:

For this report, all the test cases listed above were tested under normal Temperature, Voltage, humidity and Air Pressure except the Frequency Tolerance test case. The specific conditions of Frequency Tolerance test case are listed in section B.4.3

**See Table 3 for terms for result verdict:**

**Table 3 Terms for result verdict**

P	Pass, The EUT complies with the essential requirements in the standard.
NP	Not Perform, The test was not performed by CTTL
NA	Not Applicable, The test was not applicable
F	Fail, The EUT does not comply with the essential requirements in the standard



## **5.2. Statements**

The test cases listed in Section 5.1 of this report for the EUT specified in Section 3 were performed by CTTL according to the reference documents in Section 4.

The EUT meets all applicable requirements of the regulations and standards in Section 4.2.

## 6. Test Facilities Utilized

Table 4: Test Facilities Utilized

NO.	NAME	TYPE	SERIES NUMBER	PRODUCER	CAL. DUE DATE	CAL. INTERVAL
1.	Spectrum Analyzer	FSL6	100869	Rohde & Schwarz	2022-09-23	1 Year
2.	Climatic chamber	SH242	93008658	ESPEC	2023-02-21	2 Year
3.	H-field Antenna	HFH2-Z2	829324/007	R&S	2022-1-10	1 year
4.	LISN	ENV216	101200	Rohde & Schwarz	2022-05-30	1 year
5.	Test Receiver	ESCI 7	100344	Rohde & Schwarz	2022-02-23	1 year
6.	Test Receiver	ESW44	103023	Rohde & Schwarz	2022-10-28	1 year
7.	BiLog Antenna	VULB9163	829324/007	Schwarzbeck	2022-01-10	1 year

## 7. Measurement Uncertainty

Table 5: Measurement Uncertainty

Item	Uncertainty
Frequency Tolerance	$U = 73 \text{ Hz, } k=2$
20dB Bandwidth	$U = 73 \text{ Hz, } k=2$
Radiated Emissions (<300MHz)	$U = 4.86 \text{ dB, } k=2$
Radiated Emissions ( $\geq 300\text{MHz}$ )	$U = 5.16 \text{ dB, } k=2$
Conducted emission	$U = 3.10 \text{ dB, } k=2$



## **ANNEX A: EUT parameters**

/

## **ANNEX B: Detailed Test Results**

### **B.1. Electric Field Strength of Fundamental and Outside the Allocated bands**

#### **B.1.1. Reference**

See Clause 4, Clause 5 of ANSI C63.10-2013 generally.

#### **B.1.2. Measurement Methods**

The transmitter carrier output levels (E-Field) from the EUT are measured in a semi-anechoic chamber. The EUT is placed on a non-conductive stand of 80cm high, and at a measurement distance of 3m from the receiving antenna. The center of the receiving loop antenna is 1.0 meter above the ground. The E-field is measured with a shielded loop antenna connected to a measurement receiver. Detected E-field was maximized by rotating the EUT through 360° and adjusting the receiving antenna polarizations. The maximization processes were repeated with the EUT positioned respectively in its three orthogonal axes. The measurements were performed with the peak detector and if required, the quasi-peak detector.

The measurement bandwidth is:

**Table B-1: Measurement bandwidth**

Frequency of Emission (MHz)	RBW/VBW
12.56-14.56	10/30 kHz

The E-field measured at 3m is calculated as:

$$\text{E-field (dB}\mu\text{V/m)} = \text{Rx (dB}\mu\text{V)} + \text{Cable Loss (dB)} + \text{AF@3m (dB/m)}$$

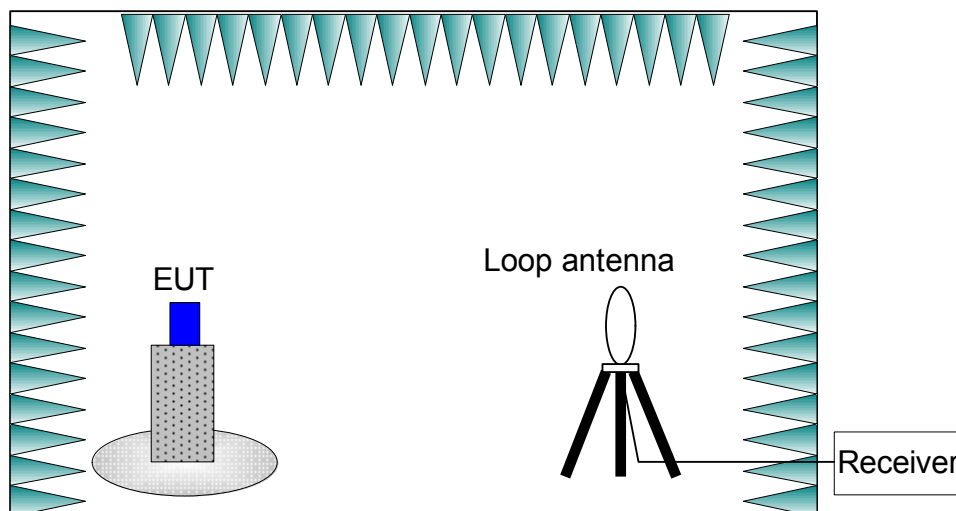

**Figure B-1: Measurement Setup**

### B.1.3. EUT Operating Mode and Test Conditions

The measurement of EUT is carried out under the transmit state of NFC(See 3.4).

The EUT is powered by a travel adapter.

All possible configurations were investigated and only the worst case is reported.

During the measurements, the ambient temperature of the electromagnetic anechoic chamber is in the range of 15 ~ 25 °C.

### B.1.4. Limits

**Table B-2: Limits**

Frequency Range (MHz)	E-field Strength Limit @ 30 m ( $\mu\text{V/m}$ )	E-field Strength Limit @ 3 m ( $\text{dB}\mu\text{V/m}$ )
13.560 ± 0.007	+15,848	124
13.410 to 13.553 13.567 to 13.710	+334	90
13.110 to 13.410 13.710 to 14.010	+106	81
Note: Where the limits have been defined at one distance, and a signal level measured at another, the limits have been extrapolated using the following formula: $\text{Extrapolation(dB)} = 40\log_{10}(\text{Measurement Distance}/\text{Specification Distance})$		



### B.1.5. Measurement Results

Measurement results of normal conditions see Figure B-2 for different set-ups of EUT. The results displayed take into account applicable antenna factors and cable losses.

**Conclusions:** Set.NFC02,**PASS**.

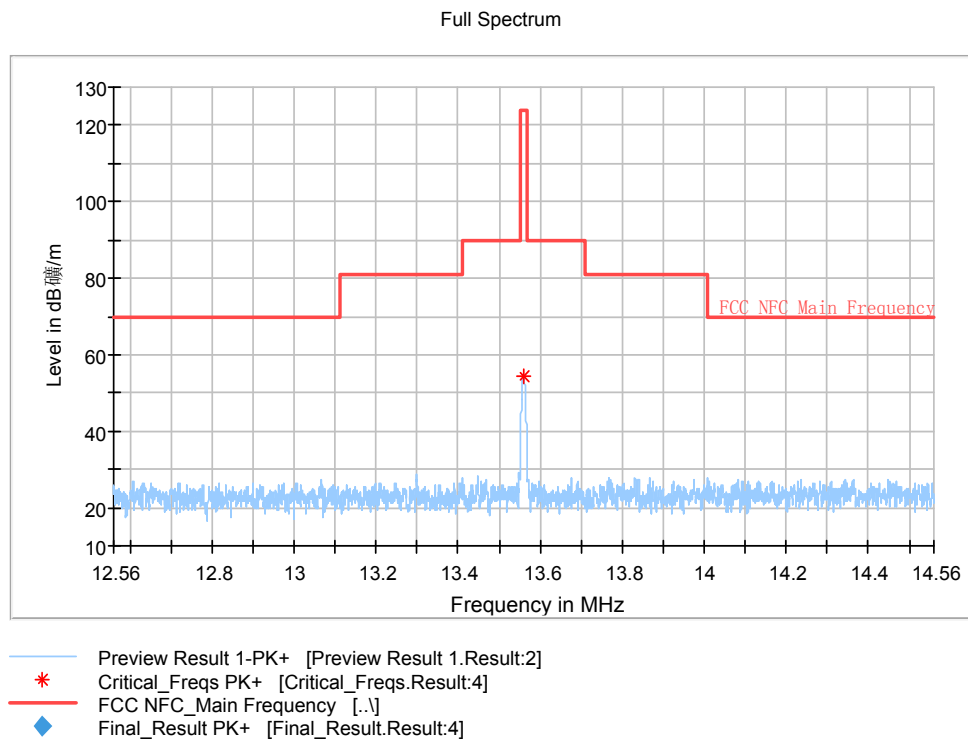

The field strength at 13.559250MHz is 54.22 dBµV/m

**Figure B-2: Measurement results for Electric Field Strength of Fundamental and Outside the Allocated bands**

## B.2. Electric Field Radiated Emissions (< 30MHz)

### B.2.1. Reference

See Clause 6.4 of ANSI C63.10-2013 specifically.

See Clause 4 and Clause 5 of ANSI C63.10-2013 generally.

### B.2.2. Measurement Methods

The transmitter carrier output levels (E-Field) from the EUT are measured in a semi-anechoic chamber. The EUT is placed on a non-conductive stand of 80cm high, and at a measurement distance of 3m from the receiving antenna. The center of the receiving loop antenna is 1.0 meter above the ground. The E-field is measured with a shielded loop antenna connected to a

©Copyright. All rights reserved by CTTL. Page 17 of 32

measurement receiver. Detected E-field was maximized by rotating the EUT through 360° and adjusting the receiving antenna polarizations. The maximization processes were repeated with the EUT positioned respectively in its three orthogonal axes. The measurements were performed with the peak detector and if required, the quasi-peak detector.

The measurement bandwidth is:

**Table B-3: Measurement bandwidth**

Frequency of Emission (MHz)	RBW/VBW
0.009-0.15	100/300 Hz
0.15-30	10/30 kHz

The E-field measured at 3m is calculated as:

$$\text{E-field (dB}\mu\text{V/m)} = \text{Rx (dB}\mu\text{V)} + \text{Cable Loss (dB)} + \text{AF@3m (dB/m)}$$

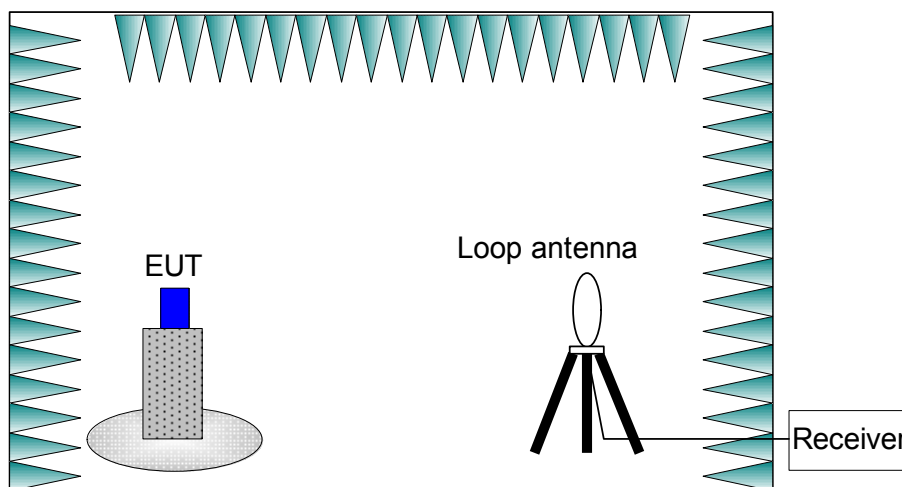

**Figure B-3: Measurement Setup**

### B.2.3. EUT Operating Mode and Test Conditions

The measurement of EUT is carried out under the transmit state of NFC(See 3.4).

The EUT is powered by a travel adapter.

All possible configurations were investigated and only the worst case is reported.

During the measurements, the ambient temperature of the electromagnetic anechoic chamber is in the range of 15 ~ 25 °C.

### B.2.4. Limits

Table B-4: Limits

Frequency Range (MHz)	E-field Strength Limit @ 30m (mV/m)	E-field Strength Limit @ 3m (dB $\mu$ V/m)
0.009-0.490	2400/F(kHz)	129-94
0.490-1.705	24000/F(kHz)	74-63
1.705-30	30	70

Note: Where the limits have been defined at one distance, and a signal level measured at another, the limits have been extrapolated using the following formula:

$$\text{Extrapolation(dB)} = 40\log_{10}(\text{Measurement Distance}/\text{Specification Distance})$$

### B.2.5. Measurement Results

Measurement results of normal conditions see Figure B-4 for different set-ups of EUT. The results displayed take into account applicable antenna factors and cable losses.

**Conclusions:**Set.NFC01, **PASS.**

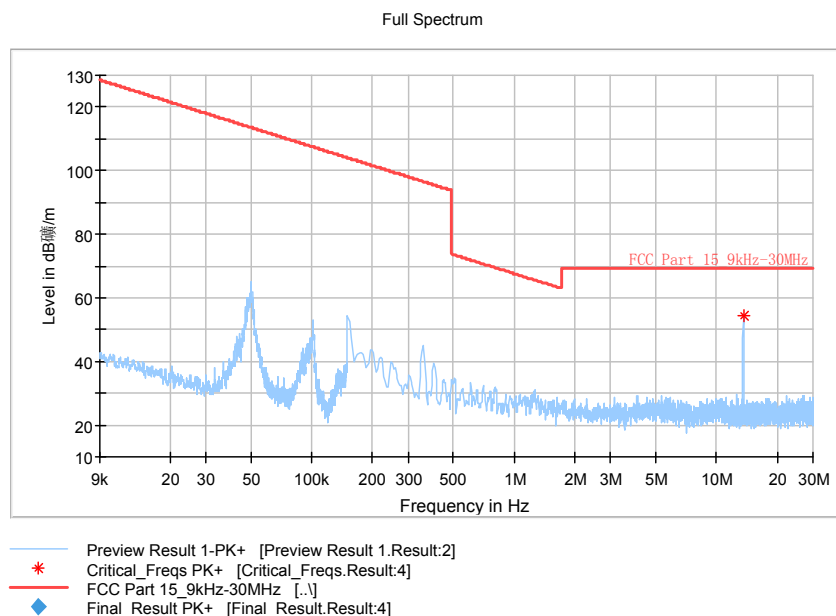

Figure B-4: Measurement results for Electric Field Radiated Emissions (< 30MHz)

### **B.3. Electric Field Radiated Emissions ( $\geq 30\text{MHz}$ )**

#### **B.3.1. Reference**

See Clause 6.5 of ANSI C63.10-2013 specifically.

See Clause 4 and Clause 5 of ANSI C63.10-2013 generally.

#### **B.3.2. Measurement Methods**

The electric field radiated emissions from the EUT are measured in a semi-anechoic chamber. The EUT is placed on a non-conductive stand of 80cm high, and at a measurement distance of 3m from the receiving antenna. The receiving antennas connected to a measurement receiver. In order to search for maximum field strength emitted from the EUT, the receiving antenna can be moved between the height of 1.0 m to 4.0 m. Detected E-field was maximized at each frequency by rotating the EUT through 360° and adjusting the receiving antenna positions for both vertical and horizontal antenna polarizations. The maximization processes were repeated with the EUT positioned respectively in its three orthogonal axes. The measurements were performed with the peak detector and if required, the quasi-peak detector.

The measurement bandwidth is:

**Table B-5: Measurement bandwidth**

Frequency of Emission (MHz)	RBW/VBW
30-1000	120kHz

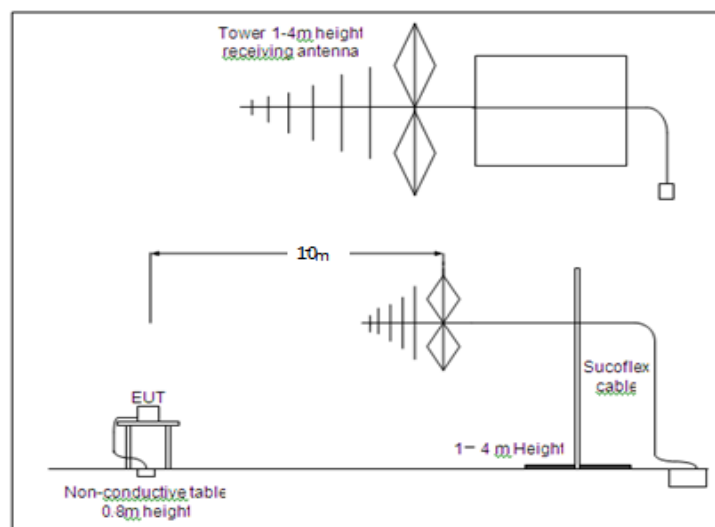

**Figure B-5: Measurement Setup**

### B.3.3. EUT Operating Mode and Test Conditions

The measurement of EUT is carried out under the transmit state of NFC(See 3.4).

The EUT had been connected to a travel adapter.

All possible configurations were investigated and only the worst case is reported.

During the measurements, the ambient temperature of the electromagnetic anechoic chamber is in the range of 15 ~ 25 °C.

### B.3.4. Limits

Table B-6: Limits

Frequency Range (MHz)	E-field Strength Limit @ 3m (mV/m)	E-field Strength Limit @ 3m (dB $\mu$ V/m)	E-field Strength Limit @ 10m (dB $\mu$ V/m)
30-88	100	40	30
88-216	150	43.5	33.5
216-960	200	46	36
960-1000	500	54	44

### B.3.5. Measurement Results

Measurement results of normal conditions see Figure B-6 for different set-ups of EUT. The results displayed take into account applicable antenna factors and cable losses.

**Conclusions:** Set.NFC01 , **PASS**.

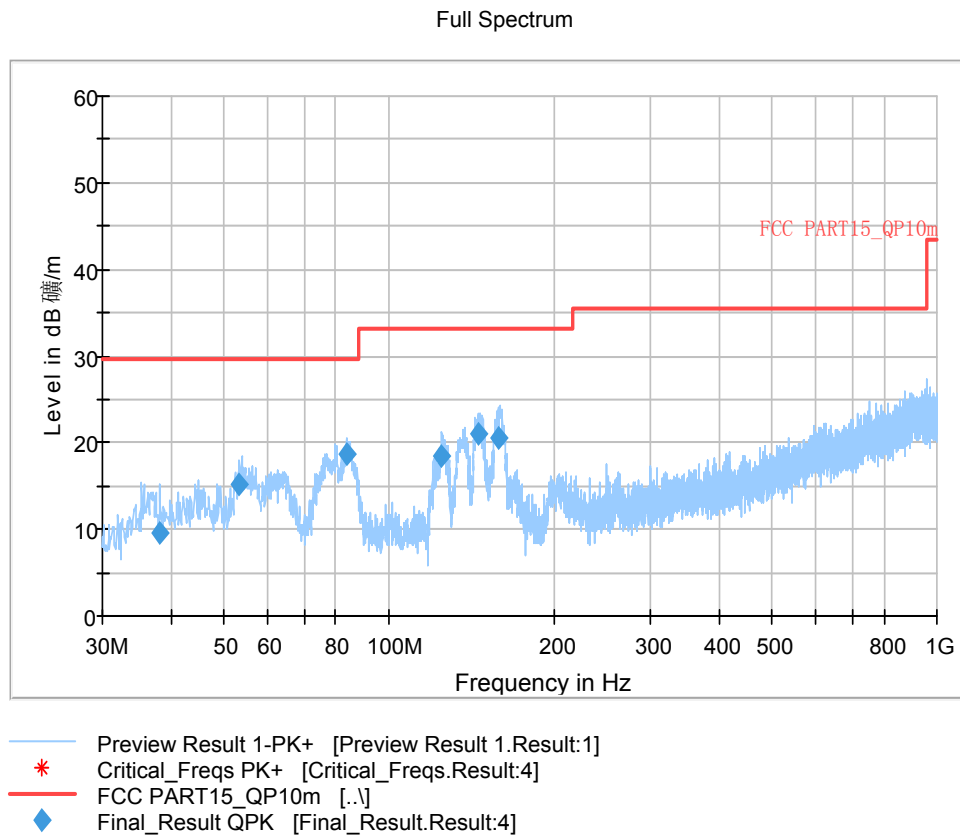

**Figure B-6: Measurement results for Electric Field Radiated Emissions ( $\geq 30\text{MHz}$ )**

Final\_Result

Frequency (MHz)	QuasiPeak (dB $\mu$ V/m)	Limit (dB $\mu$ V/m)	Margin (dB)	Meas. Time (ms)	Bandwidth (kHz)	Height (cm)	Pol	Azimuth (deg)	Corr. (dB/m)
38.148000	9.59	29.54	19.95	2000.0	120.000	183.0	V	259.0	-12.3
53.377000	15.14	29.54	14.40	2000.0	120.000	230.0	V	210.0	-11.3
83.544000	18.70	29.54	10.84	2000.0	120.000	180.0	V	300.0	-16.4
124.963000	18.37	33.06	14.69	2000.0	120.000	125.0	V	-11.0	-14.9
145.915000	20.99	33.06	12.07	2000.0	120.000	225.0	V	-10.0	-15.8
158.719000	20.57	33.06	12.49	2000.0	120.000	125.0	V	151.0	-15.0

## **B.4. Frequency Tolerance**

### **B.4.1. Reference**

See Clause 6.8 of ANSI C63.10-2013 specifically.

See Clause 4 and Clause 5 of ANSI C63.10-2013 generally.

### **B.4.2. Measurement Methods**

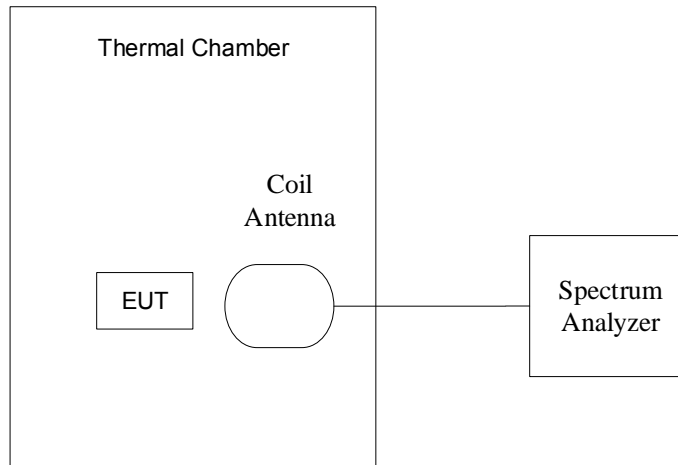

**Figure B-7: Measurement Setup**

The transmitter output signal was picked up by coil antenna connected to the spectrum analyzer. The center frequency was measured with 30Hz RBW and 1kHz span.

During the test, the EUT was placed in a thermal chamber until thermal balance and lasting appropriate time.

#### **B.4.3. EUT Operating Mode and Test Conditions**

The measurement of EUT was carried out under the transmit state of without modulation(See 3.4).

EUT had not been connected to a travel adapter. The frequency stability was measured with the different voltage and temperature combinations:

- a) The nominal voltage 3.87V(See 3.1)was used and the temperature was varied from -20°C to +50°C in 10°C increments using an environmental chamber.
- b) The 20°C was used and the voltages were 3.4V, 3.87V and 4.45V (The extreme low voltage , the nominal voltage and the extreme high voltage).

Note: The extreme low voltage , the nominal voltage and the extreme high voltage were defined in section 3.1

The details were as following:

**Table B-7: Combinations of Voltage and Temperature**

Test items	Voltage	Temperature
Frequency stability with respect to ambient temperature	3.87V	-20°C
		-10°C
		0°C

		10°C
		20°C
		30°C
		40°C
		50°C
Frequency stability when varying supply voltage	3.4V	20°C
	3.87V	
	4.45V	

#### B.4.4. Test Layouts

See B.4.2.

#### B.4.5. Limits

The frequency tolerance of the carrier signal shall be maintained within +/- 0.01% of the operating frequency.

#### B.4.6. Measurement Results

Measurement results see Table B-8 for different test conditions.

**Conclusions:** Set.NFC03, **PASS**.

**Table B-8: Measurement results for Frequency Tolerance**

Temperature	Voltage	Frequency (MHz)			
		Startup	2 Min Later	5 Min Later	10 Min Later
-20°C	3.87V	13.559878200	13.559876200	13.559978200	13.559878200
-10°C	3.87V	13.559864300	13.559872300	13.559874300	13.559872300
0°C	3.87V	13.559864300	13.559858300	13.559854300	13.559852300
10°C	3.87V	13.559778400	13.559794400	13.559802400	13.559808400
20°C	3.87V	13.559796400	13.559784400	13.559774500	13.559770500
30°C	3.87V	13.559752500	13.559740500	13.559728500	13.559724600
40°C	3.87V	13.559710600	13.559696600	13.559692600	13.559690600



50°C	3.87V	13.559678600	13.559672700	13.559666700	13.559668700
20°C	3.4V	13.559796400	13.559784400	13.559778400	13.559770500
20°C	4.45V	13.559770500	13.559766500	13.559764500	13.559762500

Temperature	Voltage	Frequency Error (%)			
		Startup	2 Min Later	5 Min Later	10 Min Later
-20°C	3.87V	-0.001	-0.001	0.000	-0.001
-10°C	3.87V	-0.001	-0.001	-0.001	-0.001
0°C	3.87V	-0.001	-0.001	-0.001	-0.001
10°C	3.87V	-0.002	-0.002	-0.001	-0.001
20°C	3.87V	-0.002	-0.002	-0.002	-0.002
30°C	3.87V	-0.002	-0.002	-0.002	-0.002
40°C	3.87V	-0.002	-0.002	-0.002	-0.002
50°C	3.87V	-0.002	-0.002	-0.002	-0.002
20°C	3.4V	-0.002	-0.002	-0.002	-0.002
20°C	4.45V	-0.002	-0.002	-0.002	-0.002

#### B.4.7. Measurement Uncertainty

Measurement uncertainty:  $U = 73 \text{ Hz}$ ,  $k=2$

### **B.5. 20dB Bandwidth**

#### **B.5.1. Reference**

See Clause 6.9 of ANSI C63.10-2013 specifically.

See Clause 4 and Clause 5 of ANSI C63.10-2013 generally.

#### **B.5.2. Measurement Methods**

The transmitter output signal was picked up by coil antenna connected to the spectrum analyzer. The bandwidth of the center frequency was measured with 150Hz RBW, 470Hz VBW and 15kHz span.

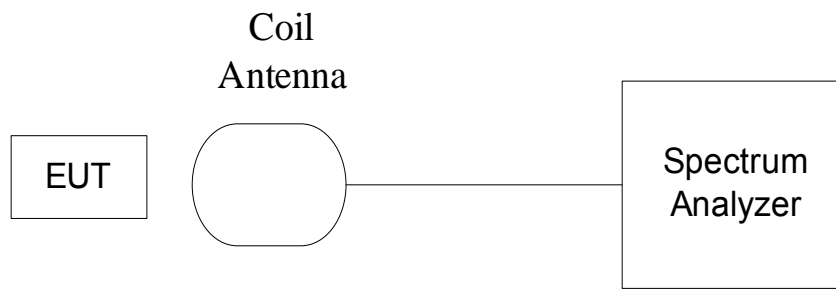

**Figure B-8: Measurement Setup**

### **B.5.3. EUT Operating Mode and Test Conditions**

The measurement of EUT was carried out under the transmit state of NFC (See 3.4).

EUT had not been connected to a travel adapter.

During the measurements, the ambient temperature was in the range of 15 ~ 25 °C.

### **B.5.4. Test Layouts**

See B.5.2.

### **B.5.5. Limits**

The 20dB bandwidth shall be less than 80% of the permitted frequency band. For 13.56 MHz NFC, the permitted frequency band is 14kHz, so the limit is 11.2 kHz.

### **B.5.6. Measurement Results**

Measurement results see Figure B-9.

**Conclusions:** Set.NFC03, **PASS**.

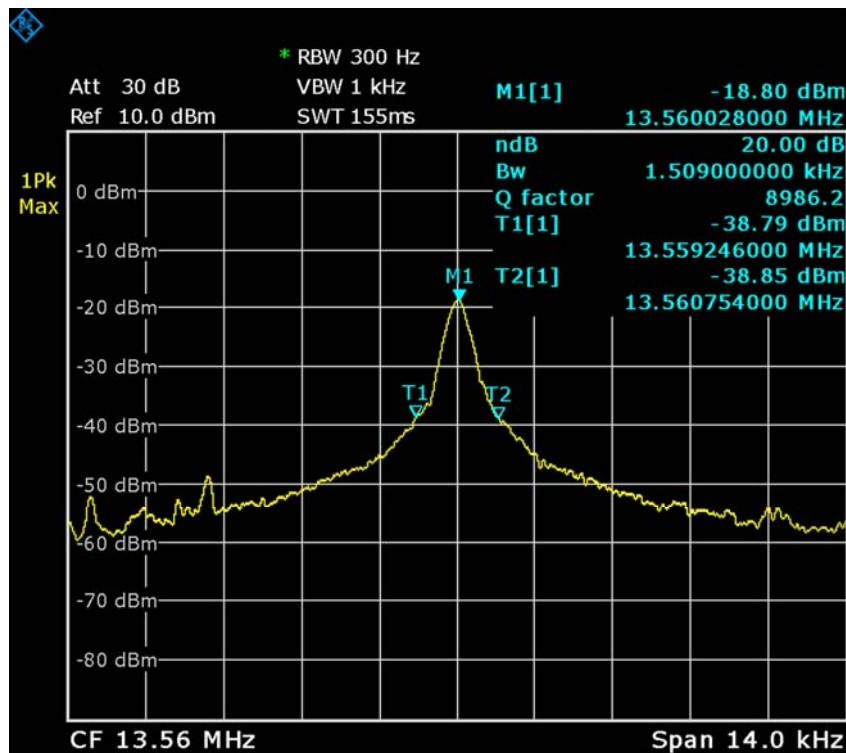

Figure B-9: Measurement results for 20dB Bandwidth

### B.5.7. Measurement Uncertainty

Measurement uncertainty:  $U = 73$  Hz,  $k=2$

## B.6. Conducted emission

### B.6.1. Reference

See Clause 6.2 of ANSI C63.10-2013 specifically.

See Clause 4 and Clause 5 of ANSI C63.10-2013 generally.

### B.6.2. Measurement Methods

The conducted emissions from the AC port of the EUT are measured in a shielding room. The EUT is connected to a Line Impedance Stabilization Network (LISN). An overview sweep with peak detection was performed. The measurements were performed with a quasi-peak detector and if required, an average detector.

The conducted emission measurements were made with the following detector of the test receiver:

Quasi-Peak / Average Detector.

The measurement bandwidth is:

**Table B-9: Measurement Bandwidth**

Frequency of Emission (MHz)	RBW/VBW
0.15-30	9kHz

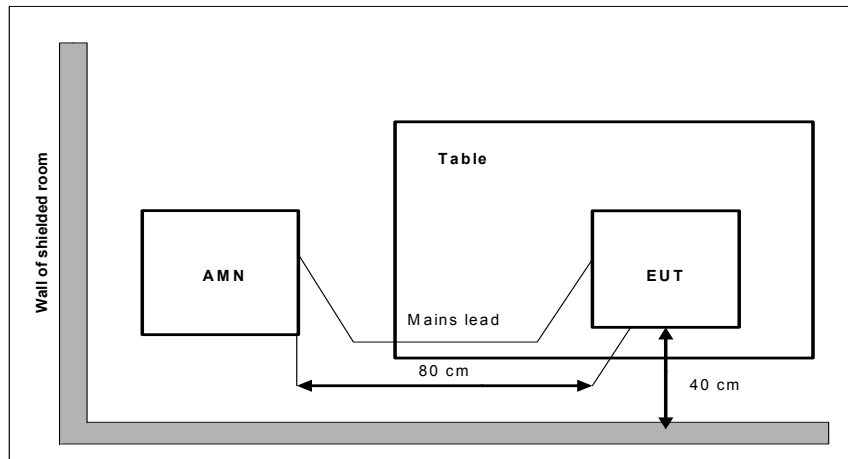

**Figure B-10: Measurement Setup**

### B.6.3. EUT Operating Mode and Test Conditions

The measurement of EUT is carried out under the transmit state of NFC(See 3.4).

The EUT is powered by a travel adapter.

All possible configurations were investigated and only the worst case is reported.

During the measurements, the ambient temperature is in the range of 15 ~ 25 °C.

### B.6.4. Limits

**Table B-10: Limits**

Frequency range (MHz)	Quasi-peak Limit (dB $\mu$ V)	Average Limit (dB $\mu$ V)
0.15 to 0.5	66 to 56	56 to 46
0.5 to 5	56	46
5 to 30	60	50

### B.6.5. Measurement Results

Measurement Result = Receiver Reading + Voltage division factor + Cable loss

Measurement results see Figure B-11.

**Conclusions: Set.NFC01, PASS.**

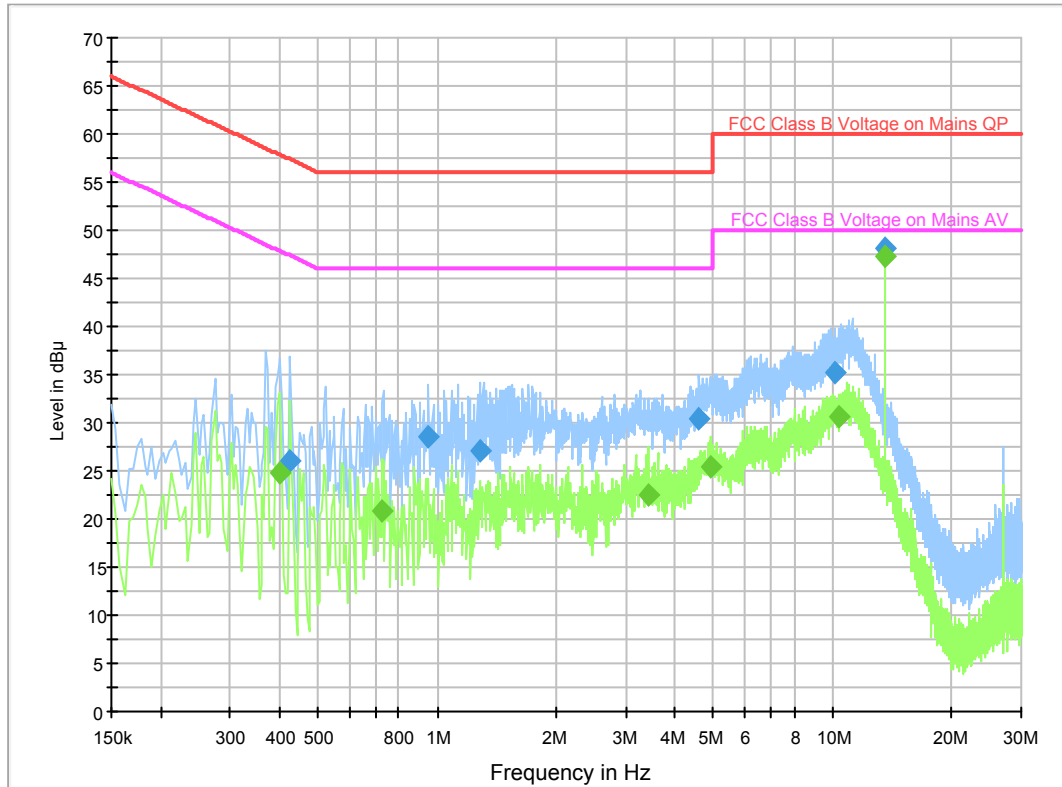

**Figure B-11: Measurement results for Conducted Emission**

**Final Result 1**

Frequency (MHz)	QuasiPeak (dBμV)	Meas. Time (ms)	Bandwidth (kHz)	Filter	Line	Corr. (dB)	Margin (dB)	Limit (dBμV)
0.426000	26.1	2000.0	9.000	On	L1	19.9	31.3	57.3
0.950000	28.6	2000.0	9.000	On	L1	19.6	27.4	56.0
1.278000	27.1	2000.0	9.000	On	L1	19.5	28.9	56.0
4.606000	30.5	2000.0	9.000	On	N	19.7	25.5	56.0
10.090000	35.1	2000.0	9.000	On	N	19.8	24.9	60.0
13.558000	48.2	2000.0	9.000	On	L1	19.7	11.8	60.0

## Final Result 2

Frequency (MHz)	CAverage (dB $\mu$ V)	Meas. Time (ms)	Bandwidth (kHz)	Filter	Line	Corr. (dB)	Margin (dB)	Limit (dB $\mu$ V)
0.398000	24.9	2000.0	9.000	On	L1	19.9	23.0	47.9
0.726000	20.8	2000.0	9.000	On	L1	19.7	25.2	46.0
3.410000	22.6	2000.0	9.000	On	N	19.7	23.4	46.0
4.938000	25.4	2000.0	9.000	On	N	19.7	20.6	46.0
10.338000	30.6	2000.0	9.000	On	N	19.8	19.4	50.0
13.558000	47.2	2000.0	9.000	On	L1	19.7	2.8	50.0

## **ANNEX C: Persons involved in this testing**

Table C-1: Persons involved

<b>Test Item</b>	<b>Tester</b>
20dB Bandwidth	Zhou Bin
Frequency Tolerance	Zhou Bin
Electric Field Strength of Fundamental and Outside the Allocated bands	Zhang Tianli
Electric Field Radiated Emissions (< 30MHz)	Zhang Tianli
Electric Field Radiated Emissions ( $\geq 30$ MHz)	Zhang Tianli
Conducted Emissions	Meng Qingbo, Zhang Xia

## ANNEX D: Accreditation Certificate

<p>United States Department of Commerce National Institute of Standards and Technology</p> <p><b>NVLAP</b>® </p> <hr/> <p><b>Certificate of Accreditation to ISO/IEC 17025:2017</b></p> <hr/> <p>NVLAP LAB CODE: 600118-0</p> <p><b>Telecommunication Technology Labs, CAICT</b> Beijing China</p> <p><i>is accredited by the National Voluntary Laboratory Accreditation Program for specific services, listed on the Scope of Accreditation, for:</i></p> <p><b>Electromagnetic Compatibility &amp; Telecommunications</b></p> <p><i>This laboratory is accredited in accordance with the recognized International Standard ISO/IEC 17025:2017. This accreditation demonstrates technical competence for a defined scope and the operation of a laboratory quality management system (refer to joint ISO-ILAC-IAF Communique dated January 2009).</i></p> <hr/> <p>2021-09-29 through 2022-09-30 <i>Effective Dates</i></p> <p style="text-align: center;"></p> <p style="text-align: right;"> For the National Voluntary Laboratory Accreditation Program</p>	
---	--

\*\*\*END OF REPORT\*\*\*