



FCC Test Report

APPLICANT : OnePlus Technology (shenzhen) Co., Ltd
EQUIPMENT : Smart Phone
BRAND NAME : ONEPLUS
MODEL NAME : ONEPLUS A5010
MARKETING NAME : ONEPLUS 5T
FCC ID : 2ABZ2-A5010
STANDARD : FCC 47 CFR FCC Part 15 Subpart B
CLASSIFICATION : Certification

The product was received on Aug. 25, 2017 and testing was completed on Oct. 10, 2017. We, Sporton International (Shenzhen) Inc., would like to declare that the tested sample has been evaluated in accordance with the test procedures given in ANSI C63.4-2014 and has been in compliance with the applicable technical standards.

The test results in this report apply exclusively to the tested model / sample. Without written approval of Sporton International (Shenzhen) Inc., the test report shall not be reproduced except in full.



Approved by: Eric Shih / Manager

Sporton International (Shenzhen) Inc.

**1/F, 2/F, Bldg 5, Shiling Industrial Zone, Xinwei Village, Xili, Nanshan Shenzhen City
Guangdong Province 518055 China**



TABLE OF CONTENTS

REVISION HISTORY.....3

SUMMARY OF TEST RESULT4

1. GENERAL DESCRIPTION5

 1.1. Applicant.....5

 1.2. Manufacturer5

 1.3. Product Feature of Equipment Under Test5

 1.4. Product Specification of Equipment Under Test6

 1.5. Modification of EUT7

 1.6. Test Location8

 1.7. Applicable Standards8

2. TEST CONFIGURATION OF EQUIPMENT UNDER TEST.....9

 2.1. Test Mode9

 2.2. Connection Diagram of Test System 11

 2.3. Support Unit used in test configuration and system..... 13

 2.4. EUT Operation Test Setup 13

3. TEST RESULT14

 3.1. Test of AC Conducted Emission Measurement14

 3.2. Test of Radiated Emission Measurement 18

4. LIST OF MEASURING EQUIPMENT24

5. UNCERTAINTY OF EVALUATION25

APPENDIX A. SETUP PHOTOGRAPHS



REVISION HISTORY

REPORT NO.	VERSION	DESCRIPTION	ISSUED DATE
FC782510-01	Rev. 01	Initial issue of report	Oct. 19, 2017



SUMMARY OF TEST RESULT

Report Section	FCC Rule	Description	Limit	Result	Remark
3.1	15.107	AC Conducted Emission	< 15.107 limits	PASS	Under limit 9.71 dB at 0.420 MHz
3.2	15.109	Radiated Emission	< 15.109 limits	PASS	Under limit 3.18 dB at 34.850 MHz for Quasi-Peak



1. General Description

1.1. Applicant

OnePlus Technology (shenzhen) Co., Ltd

18C02, 18C03, 18C04 and 18C05, Shum Yip Terra Building, Binhe Avenue North, Futian District, Shenzhen

1.2. Manufacturer

OnePlus Technology (shenzhen) Co., Ltd

18C02, 18C03, 18C04 and 18C05, Shum Yip Terra Building, Binhe Avenue North, Futian District, Shenzhen

1.3. Product Feature of Equipment Under Test

Product Feature	
Equipment	Smart Phone
Brand Name	ONEPLUS
Model Name	ONEPLUS A5010
Marketing Name	ONEPLUS 5T
FCC ID	2ABZ2-A5010
EUT supports Radios application	CDMA/EVDO/GSM/GPRS/EGPRS/WCDMA/HSPA/DC-HSDPA/HSPA+/LTE/NFC WLAN 2.4GHz 802.11b/g/n HT20/HT40 WLAN 2.4GHz 802.11ac VHT20/VHT40 WLAN 5GHz 802.11a/n HT20/HT40 WLAN 5GHz 802.11ac VHT20/VHT40/VHT80 Bluetooth v3.0 + EDR/ Bluetooth v 4.0 LE/ Bluetooth v4.1 LE/ Bluetooth v4.2 LE/ Bluetooth v5.0 LE
IMEI Code	Conduction: 866817030000988/866817030000988 Radiation: 866817030000939/866817030000939
HW Version	EC017
SW Version	oxygen version 4.7
EUT Stage	Production Unit

Remark: The above EUT's information was declared by manufacturer. Please refer to the specifications or user's manual for more detailed description.



1.4. Product Specification of Equipment Under Test

Standards-related Product Specification	
Tx Frequency	GSM850: 824.2 MHz ~ 848.8 MHz GSM1900: 1850.2 MHz ~ 1909.8MHz WCDMA Band V: 826.4 MHz ~ 846.6 MHz WCDMA Band IV : 1712.4 MHz ~ 1752.6 MHz WCDMA Band II: 1852.4 MHz ~ 1907.6 MHz LTE Band 2 : 1850.7 MHz ~ 1909.3 MHz LTE Band 4 : 1710.7 MHz ~ 1754.3 MHz LTE Band 5 : 824.7 MHz ~ 848.3 MHz LTE Band 7 : 2502.5 MHz ~ 2567.5 MHz LTE Band 12 : 699.7 MHz ~ 715.3 MHz LTE Band 17 : 706.5 MHz ~ 713.5 MHz LTE Band 25 : 1850.7 MHz ~ 1914.3 MHz LTE Band 26 : 814.7 MHz ~ 848.3 MHz LTE Band 30 : 2307.5 MHz ~ 2312.5 MHz LTE Band 38 : 2572.5 MHz ~ 2617.5 MHz LTE Band 41 : 2498.5 MHz ~ 2687.5 MHz LTE Band 66 : 1710.7 MHz ~ 1779.3 MHz CDMA2000 BC0: 824.70 MHz ~ 848.31 MHz 802.11b/g/n: 2412 MHz ~ 2462 MHz 802.11a/n/ac: 5180 MHz ~ 5240 MHz; 5260 MHz ~ 5320 MHz; 5500 MHz ~ 5700 MHz 5745 MHz ~ 5825 MHz Bluetooth: 2402 MHz ~ 2480 MHz NFC : 13.56 MHz
Rx Frequency	GSM850: 869.2 MHz ~ 893.8 MHz GSM1900: 1930.2 MHz ~ 1989.8 MHz WCDMA Band V: 871.4 MHz ~ 891.6 MHz WCDMA Band IV : 2112.4 MHz ~ 2152.6 MHz WCDMA Band II: 1932.4 MHz ~ 1987.6 MHz LTE Band 2 : 1930.7 MHz ~ 1989.3 MHz LTE Band 4 : 2110.7 MHz ~ 2154.3 MHz LTE Band 5 : 869.7 MHz ~ 893.3 MHz LTE Band 7 : 2622.5 MHz ~ 2687.5 MHz LTE Band 12 : 729.7 MHz ~ 745.3 MHz LTE Band 17 : 736.5 MHz ~ 743.5 MHz LTE Band 25 : 1930.7 MHz ~ 1994.3 MHz LTE Band 26 : 859.7 MHz ~ 893.3 MHz LTE Band 29 : 718.5 MHz ~ 726.5 MHz LTE Band 30 : 2352.5 MHz ~ 2357.5 MHz LTE Band 38: 2572.5 MHz ~ 2617.5 MHz LTE Band 41 : 2498.5 MHz ~ 2687.5 MHz LTE Band 66 : 2110.7 MHz~ 2199.3 MHz CDMA2000 BC0: 869.70 MHz ~ 893.31 MHz 802.11b/g/n: 2412 MHz ~ 2462 MHz 802.11a/n/ac: 5180 MHz ~ 5240 MHz; 5260 MHz ~ 5320 MHz; 5500 MHz ~ 5700 MHz 5745 MHz ~ 5825 MHz Bluetooth: 2402 MHz ~ 2480 MHz GNSS : 1559 MHz ~ 1610 MHz



	NFC : 13.56 MHz
Antenna Type	WWAN : PIFA Antenna WLAN : PIFA Antenna Bluetooth : PIFA Antenna GNSS: PIFA Antenna NFC : Loop Antenna
Type of Modulation	GSM: GMSK GPRS: GMSK EDGE(MCS 0-4): GMSK / (MCS 5-9): 8PSK WCDMA : BPSK (Uplink) HSDPA/DC-HSDPA : QPSK (Uplink) HSUPA : QPSK (Uplink) HSPA+ : 16QAM DC-HSDPA : 64QAM LTE: QPSK / 16QAM / 64QAM CDMA2000 1xRTT: QPSK CDMA2000 1xEV-DO: QPSK/8PSK 802.11b : DSSS (DBPSK / DQPSK / CCK) 802.11a/g/n/ac : OFDM (BPSK / QPSK / 16QAM / 64QAM / 256QAM) Bluetooth LE : GFSK Bluetooth (1Mbps) : GFSK Bluetooth (2Mbps) : $\pi/4$ -DQPSK Bluetooth (3Mbps) : 8-DPSK GNSS : BPSK NFC: ASK

1.5. Modification of EUT

No modifications are made to the EUT during all test items.



1.6. Test Location

Sporton Lab is accredited to ISO 17025 by National Voluntary Laboratory Accreditation Program (NVLAP code: 600156-0) and the FCC designation No. are CN5018 and CN5019.

Test Site	Sporton International (Shenzhen) Inc.	
Test Site Location	1/F, 2/F, Bldg 5, Shiling Industrial Zone, Xinwei Village, Xili, Nanshan Shenzhen City Guangdong Province 518055 China TEL: +86-755-8637-9589 FAX: +86-755-8637-9595	
Test Site No.	Sporton Site No.	FCC Test Firm Registration No.
	CO01-SZ	251365

Test Site	Sporton International (Shenzhen) Inc.	
Test Site Location	No. 3 Bldg the third floor of south, Shahe River west, Fengzeyuan Warehouse, Nanshan District Shenzhen City Guangdong Province 518055 China TEL: +86-755-3320-2398	
Test Site No.	Sporton Site No.	FCC Test Firm Registration No.
	03CH01-SZ	577730

Note: The test site complies with ANSI C63.4 2014 requirement.

1.7. Applicable Standards

According to the specifications of the manufacturer, the EUT must comply with the requirements of the following standards:

- FCC 47 CFR FCC Part 15 Subpart B
- ANSI C63.4-2014

Remark: All test items were verified and recorded according to the standards and without any deviation during the test.



2. Test Configuration of Equipment Under Test

2.1. Test Mode

The EUT has been associated with peripherals pursuant to ANSI C63.4-2014 and configuration operated in a manner tended to maximize its emission characteristics in a typical application.

Frequency range investigated: conduction (150 kHz to 30 MHz), radiation (30MHz to the 5th harmonic of the highest fundamental frequency or to 40 GHz, whichever is lower).

Test Items	Function Type
AC Conducted Emission	Mode 1: GSM850 Idle + Bluetooth Idle + WLAN Idle(2.4G) + USB Cable (Charging from Adapter) + Earphone + Camera (Rear) + SIM 1<Fig.1>
	Mode 2: GSM1900 Idle + Bluetooth Idle + WLAN Idle(5G) + USB Cable (Charging from Adapter) + Earphone + Camera(Front) + SIM 2<Fig.1>
	Mode 3: WCDMA Band V Idle + Bluetooth Idle + WLAN Idle(2.4G) + USB Cable (Charging from Adapter) + Earphone + Colour bar + SIM 1<Fig.1>
	Mode 4: LTE Band 4 Idle + Bluetooth Idle + WLAN Idle(5G) + USB Cable (Charging from Adapter) + Earphone + NFC On + SIM 2<Fig.1>
	Mode 5: LTE Band 2 Idle + Bluetooth Idle + WLAN Idle(2.4G) + USB Cable (Charging from Adapter) + Earphone + Glonass On + SIM 1<Fig.2>
	Mode 6: LTE Band 5 Idle + Bluetooth Idle + WLAN Idle(5G) + USB Cable (Charging from Adapter) + Earphone + BDS On + SIM 2<Fig.2>
	Mode 7: LTE Band 7 Idle + Bluetooth Idle + WLAN(5G) Idle + Earphone + USB Cable (Data Link with Notebook) + GPS On + SIM 1<Fig.3>



Radiated Emissions < 1GHz	<p>Mode 1: GSM850 Idle + Bluetooth Idle + WLAN Idle(2.4G) + USB Cable (Charging from Adapter) + Earphone + Camera (Rear) + SIM 1<Fig.1></p> <p>Mode 2: GSM1900 Idle + Bluetooth Idle + WLAN Idle(5G) + USB Cable (Charging from Adapter) + Earphone + Camera(Front) + SIM 2<Fig.1></p> <p>Mode 3: WCDMA Band V Idle + Bluetooth Idle + WLAN Idle(2.4G) + USB Cable (Charging from Adapter) + Earphone + Colur bar + SIM 1<Fig.1></p> <p>Mode 4: LTE Band 4 Idle + Bluetooth Idle + WLAN Idle(5G) + USB Cable (Charging from Adapter) + Earphone + NFC On + SIM 2<Fig.1></p> <p>Mode 5: LTE Band 2 Idle + Bluetooth Idle + WLAN Idle(2.4G) + USB Cable (Charging from Adapter) + Earphone + Glonass On + SIM 1<Fig.2></p> <p>Mode 6: LTE Band 5 Idle + Bluetooth Idle + WLAN Idle(5G) + USB Cable (Charging from Adapter) + Earphone + BDS On + SIM 2<Fig.2></p> <p>Mode 7: LTE Band 7 Idle + Bluetooth Idle + WLAN(5G) Idle + Earphone + USB Cable (Data Link with Notebook) + GPS On + SIM 1<Fig.3></p>
Radiated Emissions ≥ 1GHz	<p>Mode 1: LTE Band 5 Idle + Bluetooth Idle + WLAN Idle(5G) + USB Cable (Charging from Adapter) + Earphone + BDS On + SIM 2<Fig.2></p> <p>Mode 2: LTE Band 7 Idle + Bluetooth Idle + WLAN(5G) Idle + Earphone + USB Cable (Data Link with Notebook) + GPS On + SIM 1<Fig.3></p>
<p>Remark:</p> <ol style="list-style-type: none"> 1. The worst case of AC is mode 7; only the test data of this mode was reported. 2. The worst case of RE < 1G is mode 6; and the USB link mode of RE is mode 7, the test data of these modes are reported. 3. Data Link with Notebook means data application transferred mode between EUT and Notebook. 	

2.2. Connection Diagram of Test System

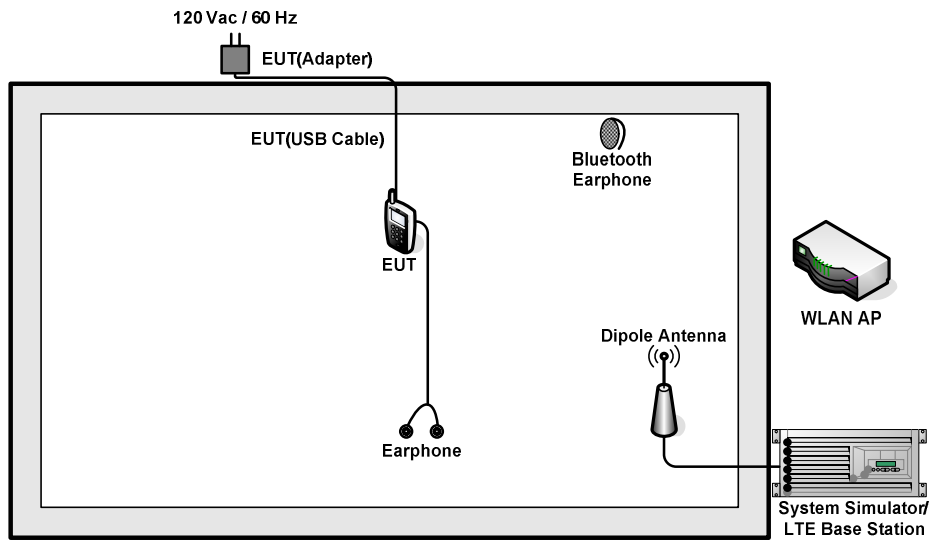

<Fig.1>

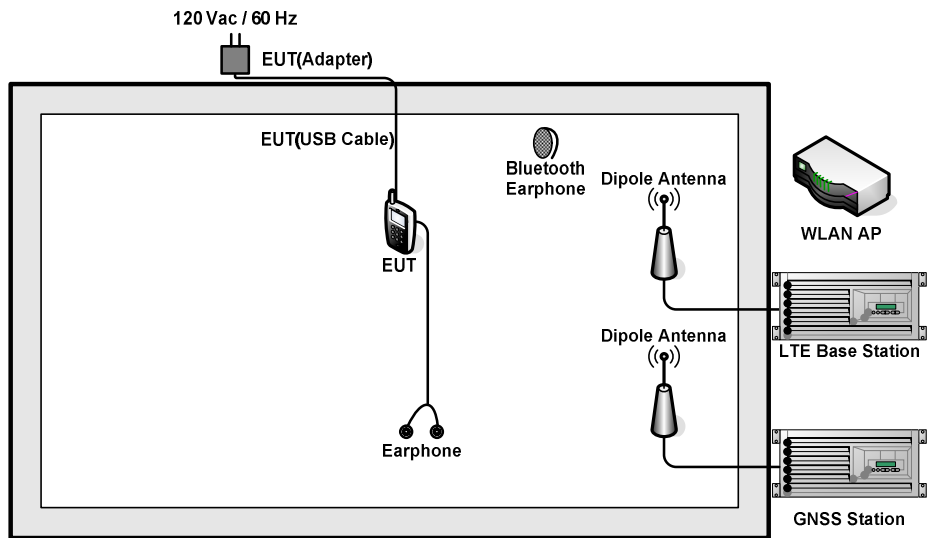

<Fig.2>

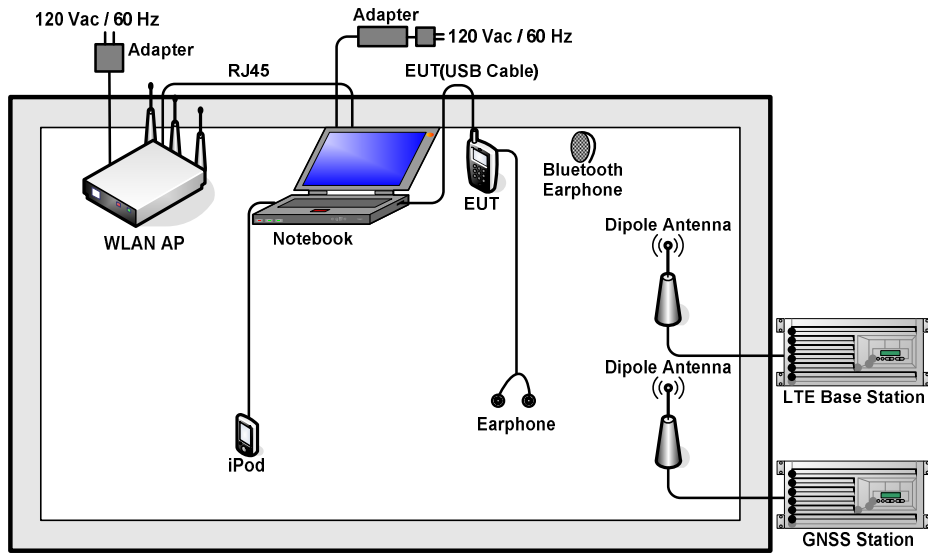

<Fig.3>

2.3. Support Unit used in test configuration and system

Item	Equipment	Trade Name	Model Name	FCC ID	Data Cable	Power Cord
1.	System Simulator	R&S	CMU 200	N/A	N/A	Unshielded, 1.8 m
2.	LTE Base Station	Anritsu	MT8820C	N/A	N/A	Unshielded, 1.8 m
3.	GNSS Station	ADIVIC	MP9000	N/A	N/A	Unshielded, 1.8 m
4.	GNSS Station	RACELOGIC	RLLS03-2RP	N/A	N/A	Unshielded, 1.8 m
5.	GNSS Station	RACELOGIC	18645	N/A	N/A	Unshielded, 1.8m
6.	WLAN AP	D-Link	DIR-820L	KA2IR820LA1	N/A	Unshielded, 1.8m
7.	WLAN AP	ASUS	RT-AC66U	MSQ-RTAC66U	N/A	Unshielded, 1.8m
8.	Notebook	Lenovo	E540	FCC DoC	N/A	AC I/P: Unshielded, 1.2 m DC O/P: Shielded, 1.8 m
9.	Bluetooth Earphone	Samsung	EO-MG900	PYAHS-107W	N/A	N/A
10.	Bluetooth Earphone	Samsung	HS3000	A3LHS3000	N/A	N/A
11.	iPod nano 8GB	Apple	MC690ZP/A	FCC DoC	Shielded, 1.2m	N/A
12.	iPod	Apple	MC525 ZP/A	DoC	Shielded, 1.0m	N/A
13.	SD Card	Kingston	SDC4/16GB 122	Fcc DoC	N/A	N/A
14.	SD Card	N/A	MicroSD HC	FCC DoC	N/A	N/A
15.	Earphone	Apple	MC690ZP/A	N/A	Unshielded, 1.6m	N/A

2.4. EUT Operation Test Setup

The EUT was in GSM or WCDMA or LTE idle mode during the testing. The EUT was synchronized to the BCCH, and is in continuous receiving mode by setting system simulator's paging reorganization.

At the same time, the EUT was attached to the Bluetooth earphone or WLAN AP, and the following programs installed in the EUT were programmed during the test.

1. Data application is transferred between Notebook and EUT via USB cable.
2. Turn on GNSS function to make the EUT receive continuous signals from GNSS station.
3. Execute "Video Player" to play MPEG4 files.
4. Turn on camera to capture images.
5. Turn on NFC function.

3. Test Result

3.1. Test of AC Conducted Emission Measurement

3.1.1 Limits of AC Conducted Emission

For equipment that is designed to be connected to the public utility (AC) power line, the radio frequency voltage that is conducted back onto the AC power line on any frequency or frequencies within the band 150 kHz to 30 MHz shall not exceed the limits in the following table.

Frequency of emission (MHz)	Conducted limit (dBuV)	
	Quasi-peak	Average
0.15-0.5	66 to 56*	56 to 46*
0.5-5	56	46
5-30	60	50

*Decreases with the logarithm of the frequency.

3.1.2 Measuring Instruments

The measuring equipment is listed in the section 4 of this test report.

3.1.3 Test Procedure

1. The EUT was placed 0.4 meter from the conducting wall of the shielding room was kept at least 80 centimeters from any other grounded conducting surface.
2. Connect EUT to the power mains through a line impedance stabilization network (LISN).
3. All the support units are connecting to the other LISN.
4. The LISN provides 50 ohm coupling impedance for the measuring instrument.
5. The FCC states that a 50 ohm, 50 microhenry LISN should be used.
6. Both sides of AC line were checked for maximum conducted interference.
7. The frequency range from 150 kHz to 30 MHz was searched.
8. Set the test-receiver system to Peak Detect Function and specified bandwidth (IF Bandwidth = 9kHz) with Maximum Hold Mode. Then measurement is also conducted by Average Detector and Quasi-Peak Detector Function respectively.

3.1.4 Test Setup





3.1.5 Test Result of AC Conducted Emission

Test Mode :	Mode 7	Temperature :	22~25°C
Test Engineer :	Peng wang	Relative Humidity :	50~55%
Test Voltage :	120Vac / 60Hz	Phase :	Line
Function Type :	LTE Band 7 Idle + Bluetooth Idle + WLAN(5G) Idle + Earphone + USB Cable (Data Link with Notebook) + GPS On + SIM 1		

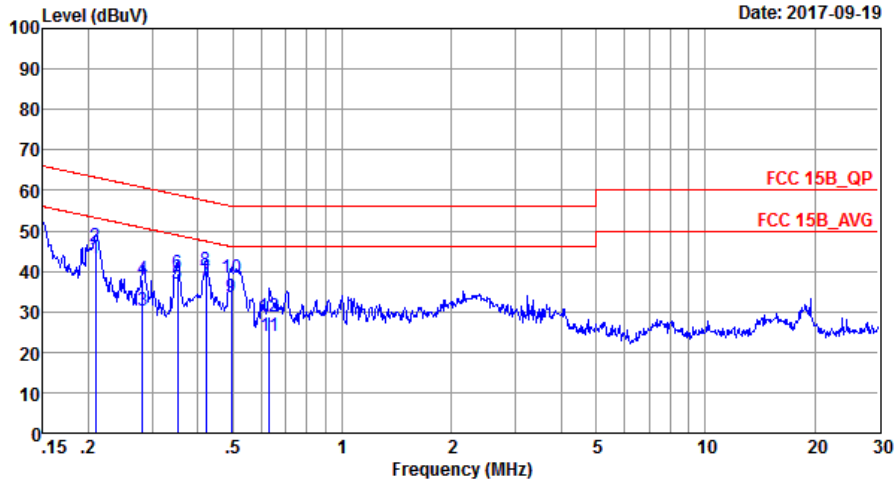

Site : CO01-SZ
 Condition: FCC 15B_QP LISN_20170907_L LINE
 Project : (FC)782510-01
 Mode : Mode 7
 IMEI : 866817030000988/866817030000988

	Freq	Level	Over Limit	Limit Line	Read Level	LISN Factor	Cable Loss	Remark
	MHz	dBuV	dB	dBuV	dBuV	dB	dB	
1 *	0.21	43.25	-9.98	53.23	33.00	0.03	10.22	Average
2	0.21	46.05	-17.18	63.23	35.80	0.03	10.22	QP
3	0.28	30.35	-20.41	50.76	20.10	0.03	10.22	Average
4	0.28	37.95	-22.81	60.76	27.70	0.03	10.22	QP
5	0.35	37.03	-11.88	48.91	26.80	0.03	10.20	Average
6	0.35	39.43	-19.48	58.91	29.20	0.03	10.20	QP
7	0.42	37.42	-10.00	47.42	27.20	0.03	10.19	Average
8	0.42	40.12	-17.30	57.42	29.90	0.03	10.19	QP
9	0.49	33.40	-12.70	46.10	23.20	0.02	10.18	Average
10	0.49	38.50	-17.60	56.10	28.30	0.02	10.18	QP
11	0.63	24.09	-21.91	46.00	13.90	0.02	10.17	Average
12	0.63	28.69	-27.31	56.00	18.50	0.02	10.17	QP



Test Mode :	Mode 7	Temperature :	22~25°C
Test Engineer :	Peng wang	Relative Humidity :	50~55%
Test Voltage :	120Vac / 60Hz	Phase :	Neutral
Function Type :	LTE Band 7 Idle + Bluetooth Idle + WLAN(5G) Idle + Earphone + USB Cable (Data Link with Notebook) + GPS On + SIM 1		

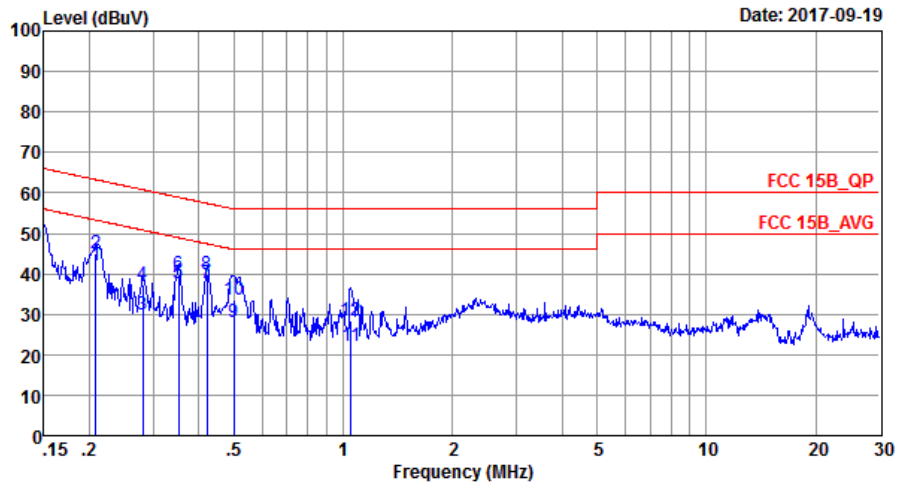

Site : CO01-SZ
 Condition: FCC 15B_QP LISN_20170907_N NEUTRAL
 Project : (FC)782510-01
 Mode : Mode 7
 IMEI : 866817030000988/866817030000988

	Freq	Level	Over Limit	Limit Line	Read Level	LISN Factor	Cable Loss	Remark
	MHz	dBuV	dB	dBuV	dBuV	dB	dB	
1	0.21	42.05	-11.22	53.27	31.80	0.03	10.22	Average
2	0.21	44.95	-18.32	63.27	34.70	0.03	10.22	QP
3	0.28	29.85	-20.96	50.81	19.60	0.03	10.22	Average
4	0.28	37.45	-23.36	60.81	27.20	0.03	10.22	QP
5	0.35	37.63	-11.28	48.91	27.41	0.02	10.20	Average
6	0.35	39.73	-19.18	58.91	29.51	0.02	10.20	QP
7	0.42	37.71	-9.71	47.42	27.50	0.02	10.19	Average
8	0.42	39.81	-17.61	57.42	29.60	0.02	10.19	QP
9	0.50	27.90	-18.11	46.01	17.70	0.02	10.18	Average
10	0.50	33.70	-22.31	56.01	23.50	0.02	10.18	QP
11	1.05	22.10	-23.90	46.00	11.90	0.05	10.15	Average
12	1.05	28.30	-27.70	56.00	18.10	0.05	10.15	QP



3.2. Test of Radiated Emission Measurement

3.2.1. Limit of Radiated Emission

The emissions from an unintentional radiator shall not exceed the field strength levels specified in the following table:

Frequency (MHz)	Field Strength (microvolts/meter)	Measurement Distance (meters)
30 – 88	100	3
88 – 216	150	3
216 - 960	200	3
Above 960	500	3

3.2.2. Measuring Instruments

The measuring equipment is listed in the section 4 of this test report.

3.2.3. Test Procedures

1. The EUT was placed on a turntable with 0.8 meter above ground.
2. The EUT was set 3 meters from the interference receiving antenna, which was mounted on the top of a variable height antenna tower.
3. The table was rotated 360 degrees to determine the position of the highest radiation.
4. The antenna is a Bi-Log antenna and its height is adjusted between one to four meters above ground to find the maximum value of the field strength for both horizontal polarization and vertical polarization of the antenna.
5. For each suspected emission, the EUT was arranged to its worst case and then tune the antenna tower (from 1 m to 4 m) and turntable (from 0 degree to 360 degrees) to find the maximum reading.
6. Set the test-receiver system to Peak Detect Function and specified bandwidth with Maximum Hold Mode (RBW=120kHz/VBW=300kHz for frequency below 1GHz; RBW=1MHz VBW=3MHz (Peak), RBW=1MHz/VBW=10Hz (Average) for frequency above 1GHz).
7. If the emission level of the EUT in peak mode was 3 dB lower than the limit specified, peak values of EUT will be reported. Otherwise, the emission will be repeated by using the quasi-peak method and reported.
8. Emission level (dBµV/m) = 20 log Emission level (µV/m)
9. Corrected Reading: Antenna Factor + Cable Loss + Read Level - Preamp Factor = Level

3.2.4. Test Setup of Radiated Emission

For radiated emissions from 30MHz to 1GHz



For radiated emissions above 1GHz

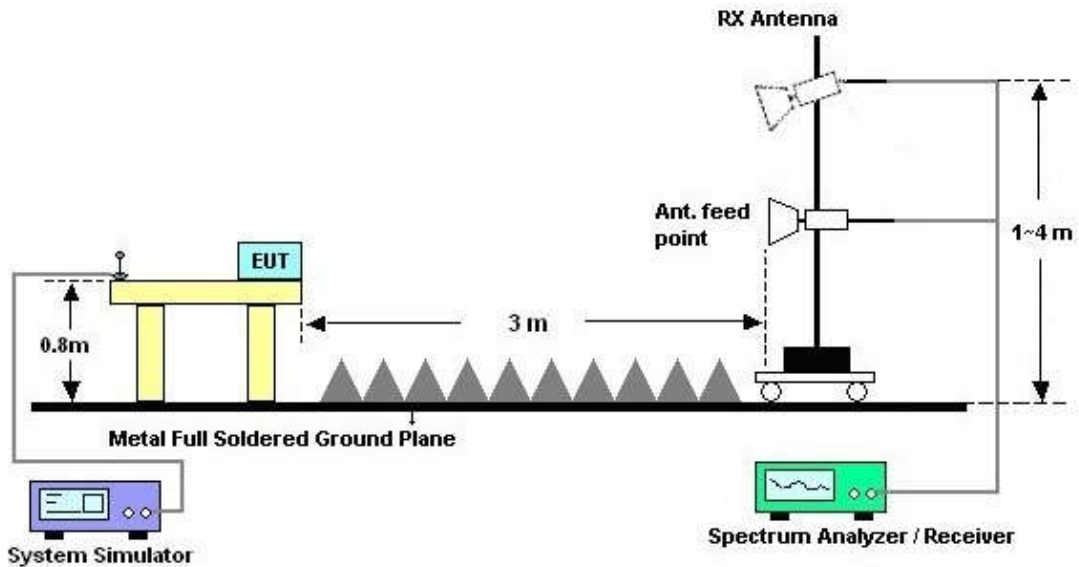



3.2.5. Test Result of Radiated Emission

Test Mode :	Mode 6	Temperature :	24~25°C
Test Engineer :	Liu lun	Relative Humidity :	48~49%
Test Distance :	3m	Polarization :	Horizontal
Function Type :	LTE Band 5 Idle + Bluetooth Idle + WLAN Idle(5G) + USB Cable (Charging from Adapter) + Earphone + BDS On + SIM 2		
Remark :	#6 is system simulator signal which can be ignored.		

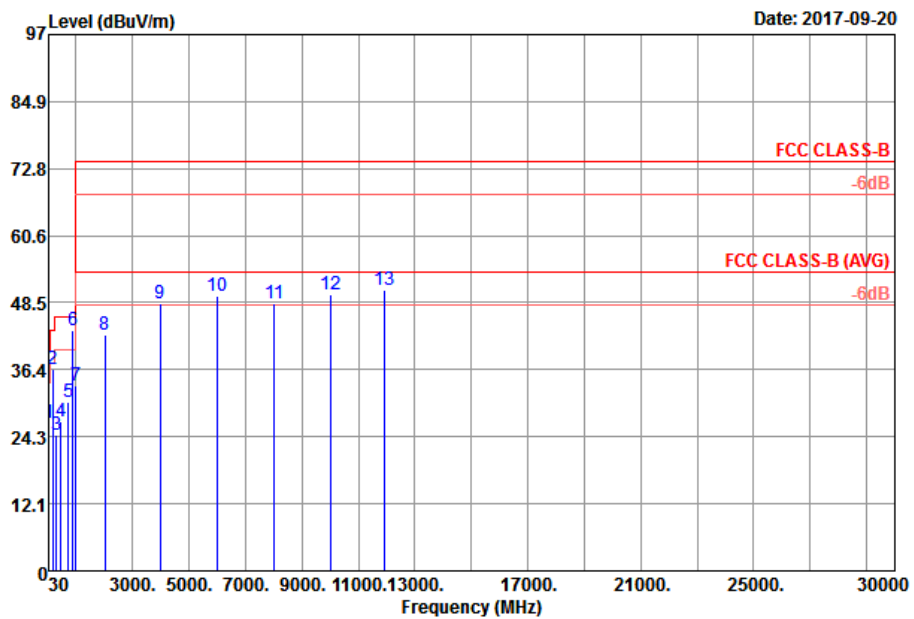

Site : 03CH01-SZ
 Condition : FCC CLASS-B 3m HF_ANT(3117)_119436 HORIZONTAL
 Mode : Mode 6
 IMEI : 866817030000939/866817030000939

	Freq	Level	Over Limit	Limit Line	ReadAntenna Level	Antenna Factor	Cable Loss	Preamp Factor	A/Pos	T/Pos	Remark
	MHz	dBuV/m	dB	dBuV/m	dBuV	dB/m	dB	dB	cm	deg	
1	30.97	26.64	-13.36	40.00	31.79	26.30	0.25	31.70	---	---	Peak
2	169.68	36.38	-7.12	43.50	48.95	17.32	1.43	31.32	100	255	Peak
3	297.72	24.65	-21.35	46.00	35.45	18.46	2.03	31.29	---	---	Peak
4	453.89	26.90	-19.10	46.00	31.24	24.39	2.58	31.31	---	---	Peak
5	719.67	30.63	-15.37	46.00	31.52	27.27	3.34	31.50	---	---	Peak
6	881.66	43.37			42.77	28.33	3.77	31.50	---	---	Peak
7	994.18	33.52	-20.48	54.00	30.79	30.05	4.18	31.50	---	---	Peak
8	2018.00	42.64	-31.36	74.00	62.70	31.06	6.12	57.24	---	---	Peak
9	3978.00	48.42	-25.58	74.00	62.41	33.45	10.08	57.52	---	---	Peak
10	6016.00	49.66	-24.34	74.00	58.24	34.51	13.37	56.46	---	---	Peak
11	8016.00	48.35	-25.65	74.00	55.71	35.70	12.56	55.62	---	---	Peak
12	10026.00	49.99	-24.01	74.00	54.81	36.82	14.53	56.17	---	---	Peak
13	11904.00	50.83	-23.17	74.00	54.00	38.33	14.98	56.48	100	250	Peak



Test Mode :	Mode 6	Temperature :	24~25°C
Test Engineer :	Liu lun	Relative Humidity :	48~49%
Test Distance :	3m	Polarization :	Vertical
Function Type :	LTE Band 5 Idle + Bluetooth Idle + WLAN Idle(5G) + USB Cable (Charging from Adapter) + Earphone + BDS On + SIM 2		
Remark :	#6 is system simulator signal which can be ignored.		

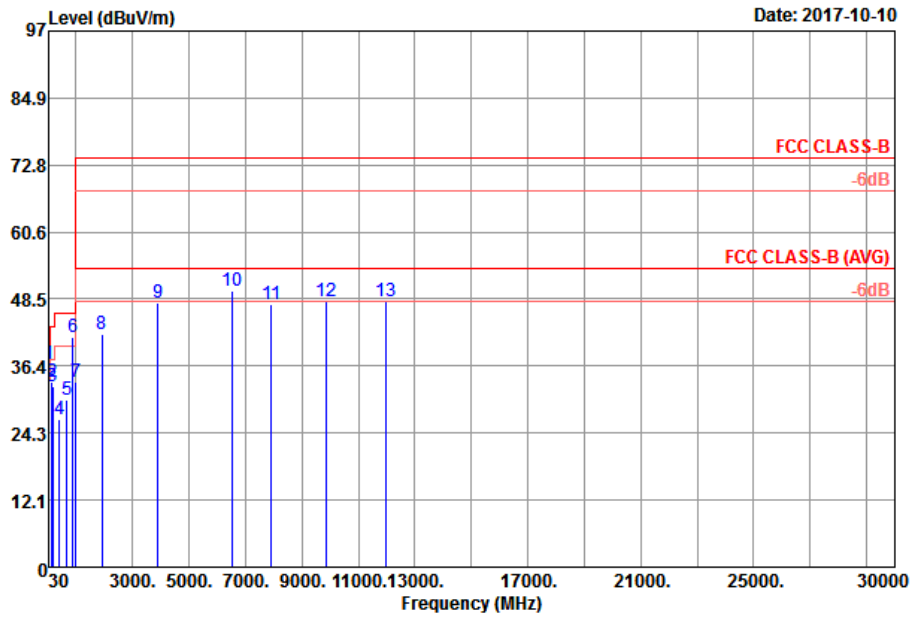

Site : 03CH01-SZ
 Condition : FCC CLASS-B 3m LF_ANT(35407)_6 VERTICAL
 Mode : Mode 6
 IMEI : 866817030000939/866817030000939

	Freq	Level	Over Limit	Limit Line	ReadAntenna Level	Antenna Factor	Cable Loss	Preamp Factor	A/Pos	T/Pos	Remark
	MHz	dBuV/m	dB	dBuV/m	dBuV	dB/m	dB	dB	cm	deg	
1 !	34.85	36.82	-3.18	40.00	43.00	25.10	0.32	31.60	100	156	QP
2	152.22	33.57	-9.93	43.50	45.62	18.02	1.32	31.39	---	---	Peak
3	186.17	32.72	-10.78	43.50	45.80	16.65	1.52	31.25	---	---	Peak
4	421.88	26.75	-19.25	46.00	31.41	24.17	2.47	31.30	---	---	Peak
5	675.05	30.36	-15.64	46.00	32.45	26.20	3.21	31.50	---	---	Peak
6 !	880.69	41.64			41.05	28.32	3.77	31.50	---	---	Peak
7	991.27	33.53	-20.47	54.00	30.84	30.03	4.16	31.50	---	---	Peak
8	1922.00	42.24	-31.76	74.00	62.82	30.79	5.94	57.31	---	---	Peak
9	3896.00	47.72	-26.28	74.00	61.74	33.43	10.03	57.48	---	---	Peak
10	6554.00	49.94	-24.06	74.00	57.03	34.90	15.35	57.34	100	155	Peak
11	7912.00	47.57	-26.43	74.00	55.23	35.72	12.59	55.97	---	---	Peak
12	9864.00	47.97	-26.03	74.00	53.58	36.69	13.93	56.23	---	---	Peak
13	11990.00	48.15	-25.85	74.00	51.26	38.47	15.00	56.58	---	---	Peak



Test Mode :	Mode 7	Temperature :	24~25°C
Test Engineer :	Liu lun	Relative Humidity :	48~49%
Test Distance :	3m	Polarization :	Horizontal
Function Type :	LTE Band 7 Idle + Bluetooth Idle + WLAN(5G) Idle + Earphone + USB Cable (Data Link with Notebook) + GPS On + SIM 1		
Remark :	#8 is system simulator signal which can be ignored.		

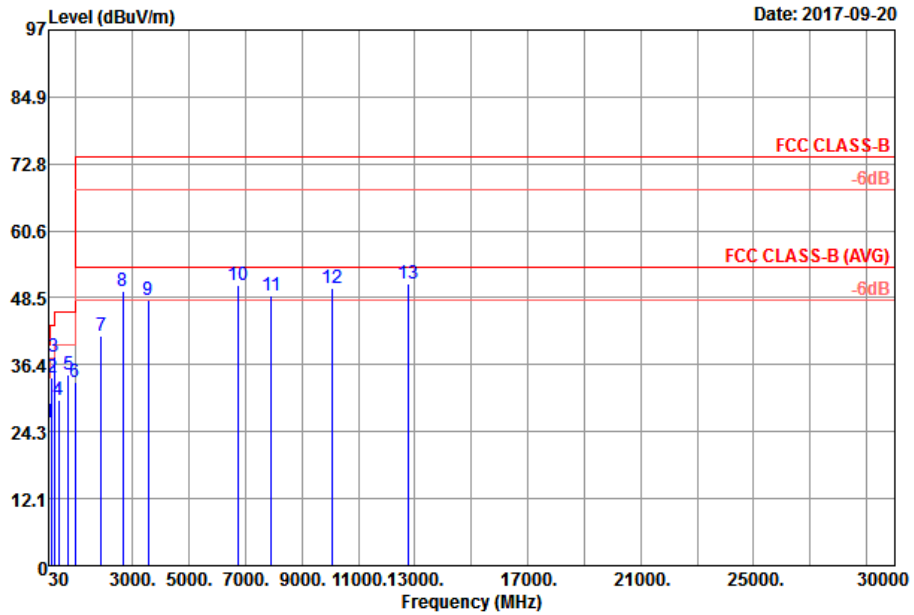

Site : 03CH01-SZ
 Condition : FCC CLASS-B 3m HF_ANT(3117)_119436 HORIZONTAL
 Mode : Mode 7
 IMEI : 866817030000939/866817030000939

	Freq	Level	Over	Limit	Limit	ReadAntenna	Cable	Preamp	A/Pos	T/Pos	Remark
	MHz	dBuV/m	dB	dBuV/m	dBuV	dB/m	Loss	Factor	cm	deg	
1	30.97	25.84	-14.16	40.00	30.99	26.30	0.25	31.70	---	---	Peak
2	149.31	34.13	-9.37	43.50	46.11	18.12	1.30	31.40	---	---	Peak
3	238.55	37.86	-8.14	46.00	50.00	17.18	1.80	31.12	100	155	Peak
4	398.60	30.06	-15.94	46.00	35.14	23.83	2.39	31.30	---	---	Peak
5	719.67	34.63	-11.37	46.00	35.52	27.27	3.34	31.50	---	---	Peak
6	966.05	33.21	-20.79	54.00	30.85	29.83	4.03	31.50	---	---	Peak
7	1884.00	41.56	-32.44	74.00	62.33	30.70	5.86	57.33	---	---	Peak
8	2656.00	49.60			67.17	32.00	7.15	56.72	---	---	Peak
9	3564.00	48.04	-25.96	74.00	61.69	34.05	9.61	57.31	---	---	Peak
10	6748.00	50.72	-23.28	74.00	57.64	34.98	15.74	57.64	---	---	Peak
11	7922.00	48.91	-25.09	74.00	56.57	35.72	12.59	55.97	---	---	Peak
12	10092.00	50.35	-23.65	74.00	55.16	36.86	14.55	56.22	---	---	Peak
13	12750.00	50.97	-23.03	74.00	54.58	38.65	15.10	57.36	100	152	Peak



Test Mode :	Mode 7	Temperature :	24~25°C
Test Engineer :	Liu lun	Relative Humidity :	48~49%
Test Distance :	3m	Polarization :	Vertical
Function Type :	LTE Band 7 Idle + Bluetooth Idle + WLAN(5G) Idle + Earphone + USB Cable (Data Link with Notebook) + GPS On + SIM 1		
Remark :	#8 is system simulator signal which can be ignored.		

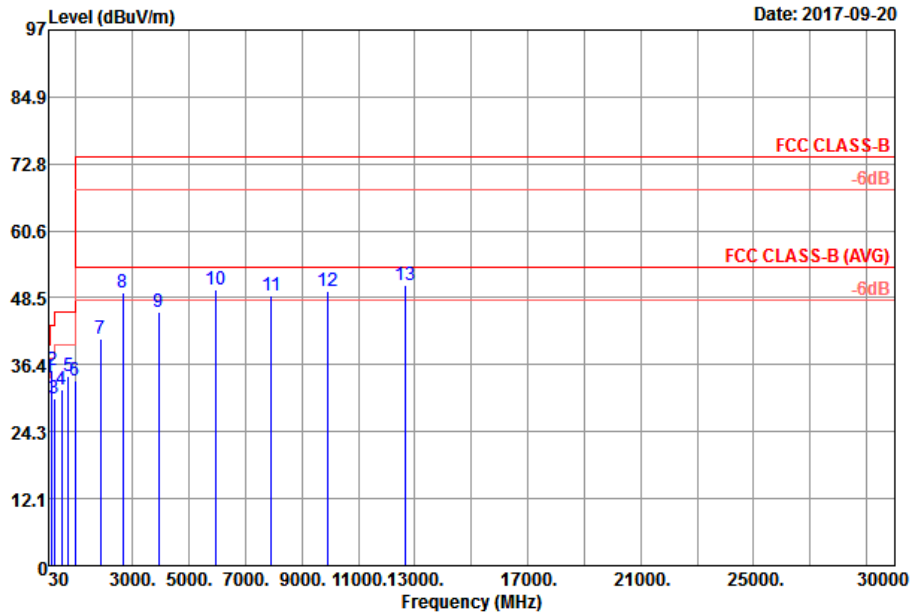

Site : 03CH01-SZ
 Condition : FCC CLASS-B 3m HF_ANT(3117)_119436 VERTICAL
 Mode : Mode 7
 IMEI : 866817030000939/866817030000939

	Freq	Level	Over	Limit	ReadAntenna	Cable	Preamp	A/Pos	T/Pos	Remark	
	MHz	dBuV/m	dB	dBuV/m	dBuV	dB/m	dB	dB	cm	deg	
1	43.58	33.95	-6.05	40.00	44.85	19.98	0.42	31.30	100	152 Peak	
2	148.34	35.31	-8.19	43.50	47.27	18.15	1.29	31.40	---	---	Peak
3	239.52	30.36	-15.64	46.00	42.47	17.20	1.81	31.12	---	---	Peak
4	499.48	31.76	-14.24	46.00	37.32	23.13	2.71	31.40	---	---	Peak
5	732.28	34.28	-11.72	46.00	34.81	27.58	3.39	31.50	---	---	Peak
6	979.63	33.58	-20.42	54.00	31.04	29.94	4.10	31.50	---	---	Peak
7	1856.00	41.09	-32.91	74.00	62.29	30.38	5.77	57.35	---	---	Peak
8	2654.00	49.57			67.14	32.00	7.15	56.72	---	---	Peak
9	3916.00	45.84	-28.16	74.00	59.84	33.44	10.06	57.50	---	---	Peak
10	5934.00	49.95	-24.05	74.00	58.59	34.45	13.14	56.23	---	---	Peak
11	7908.00	48.96	-25.04	74.00	56.68	35.72	12.59	56.03	---	---	Peak
12	9914.00	49.79	-24.21	74.00	55.03	36.73	14.23	56.20	---	---	Peak
13	12652.00	50.92	-23.08	74.00	54.68	38.63	15.09	57.48	100	203 Peak	



4. List of Measuring Equipment

Instrument	Manufacturer	Model No.	Serial No.	Characteristics	Calibration Date	Test Date	Due Date	Remark
EMI Receiver	R&S	ESR7	101630	9kHz~7GHz;	Jan. 06, 2017	Sep. 19, 2017	Jan. 05, 2018	Conduction (CO01-SZ)
AC LISN	EMCO	3816/2SH	00103912	9kHz~30MHz	Jan. 05, 2017	Sep. 19, 2017	Jan. 04, 2018	Conduction (CO01-SZ)
AC LISN (for auxiliary equipment)	MessTec	3816/2SH	00103892	9kHz~30MHz	Jan. 05, 2017	Sep. 19, 2017	Jan. 04, 2018	Conduction (CO01-SZ)
AC Power Source	Chroma	61602	61602000089 1	100Vac~250Vac	Jul. 19, 2017	Sep. 19, 2017	Jul. 18, 2018	Conduction (CO01-SZ)
EMI Test Receiver&SA	Agilent	N9038A	MY52260185	20Hz~26.5GHz	Apr. 20, 2017	Sep. 20, 2017~ Oct. 10, 2017	Apr. 19, 2018	Radiation (03CH01-SZ)
Bilog Antenna	TeseQ	CBL6112D	23188	30MHz~2GHz	Apr. 25, 2017	Sep. 20, 2017~ Oct. 10, 2017	Apr. 24, 2018	Radiation (03CH01-SZ)
Double Ridge Horn Antenna	ETS Lindgren	3117	00119436	1GHz~18GHz	Nov. 19, 2016	Sep. 20, 2017~ Oct. 10, 2017	Nov. 18, 2017	Radiation (03CH01-SZ)
LF Amplifier	Burgeon	BPA-530	102209	0.01~3000Mhz	Apr. 20, 2017	Sep. 20, 2017~ Oct. 10, 2017	Apr. 19, 2018	Radiation (03CH01-SZ)
HF Amplifier	MITEQ	AMF-7D-0010 1800-30-10P-R	1707137	1GHz~18GHz	Oct. 12, 2016	Sep. 20, 2017~ Oct. 10, 2017	Oct. 11, 2017	Radiation (03CH01-SZ)
HF Amplifier	MITEQ	TTA1840-35-H G	1871923	18GHz~40GHz	Jul. 21, 2017	Sep. 20, 2017~ Oct. 10, 2017	Jul. 20, 2018	Radiation (03CH01-SZ)
SHF-EHF Horn	com-power	AH-840	101071	18GHz~40GHz	Jun. 16, 2017	Sep. 20, 2017~ Oct. 10, 2017	Jun. 15, 2018	Radiation (03CH01-SZ)
AC Power Source	Chroma	61601	61601000198 5	N/A	NCR	Sep. 20, 2017~ Oct. 10, 2017	NCR	Radiation (03CH01-SZ)
Turn Table	EM	EM1000	N/A	0~360 degree	NCR	Sep. 20, 2017~ Oct. 10, 2017	NCR	Radiation (03CH01-SZ)
Antenna Mast	EM	EM1000	N/A	1 m~4 m	NCR	Sep. 20, 2017~ Oct. 10, 2017	NCR	Radiation (03CH01-SZ)

NCR: No Calibration Required



5. Uncertainty of Evaluation

Uncertainty of Conducted Emission Measurement (150 kHz ~ 30 MHz)

Measuring Uncertainty for a Level of Confidence of 95% ($U = 2Uc(y)$)	2.5dB
---	-------

Uncertainty of Radiated Emission Measurement (30 MHz ~ 1000 MHz)

Measuring Uncertainty for a Level of Confidence of 95% ($U = 2Uc(y)$)	5.1dB
---	-------

Uncertainty of Radiated Emission Measurement (1GHz ~ 18GHz)

Measuring Uncertainty for a Level of Confidence of 95% ($U = 2Uc(y)$)	5.2dB
---	-------

Uncertainty of Radiated Emission Measurement (18GHz ~ 40GHz)

Measuring Uncertainty for a Level of Confidence of 95% ($U = 2Uc(y)$)	5.1dB
---	-------