



FCC RF Test Report

APPLICANT : OnePlus Technology (shenzhen) Co., Ltd
EQUIPMENT : Smart Phone
BRAND NAME : ONEPLUS
MODEL NAME : ONEPLUS A5010
MARKETING NAME : ONEPLUS 5T
FCC ID : 2ABZ2-A5010
STANDARD : FCC Part 15 Subpart C §15.225
CLASSIFICATION : (DXX) Low Power Communication Device Transmitter

The testing was completed on Sep. 28, 2017. We, Sporton International (Shenzhen) Inc., would like to declare that the tested sample has been evaluated in accordance with the test procedures and has been in compliance with the applicable technical standards.

The test results in this report apply exclusively to the tested model / sample. Without written approval of Sporton International (Shenzhen) Inc., the test report shall not be reproduced except in full.



Approved by: Eric Shih / Manager

Sporton International (Shenzhen) Inc.

1/F, 2/F, Bldg 5, Shiling Industrial Zone, Xinwei Village, Xili, Nanshan Shenzhen City

Guangdong Province 518055 China



TABLE OF CONTENTS

SUMMARY OF THE TEST RESULT4

1. GENERAL INFORMATION.....5

1.1 Applicant..... 5

1.2 Manufacturer 5

1.3 Product Feature of Equipment Under Test 5

1.4 Product Specification of Equipment Under Test 6

1.5 Modification of EUT 7

1.6 Testing Location 7

1.7 Applicable Standards..... 8

2. TEST CONFIGURATION OF EQUIPMENT UNDER TEST9

2.1 Descriptions of Test Mode 9

2.2 Connection Diagram of Test System 9

2.3 Table for Supporting Units 10

2.4 EUT Operation Test Setup 10

3. TEST RESULTS.....11

3.1 AC Power Line Conducted Emissions Measurement 11

3.2 20dB and 99% OBW Spectrum Bandwidth Measurement..... 13

3.3 Frequency Stability Measurement 14

3.4 Field Strength of Fundamental Emissions and Mask Measurement..... 15

3.5 Radiated Emissions Measurement 17

3.6 Antenna Requirements..... 20

4. LIST OF MEASURING EQUIPMENT21

APPENDIX A. TEST RESULTS OF CONDUCTED EMISSION TEST

APPENDIX B. TEST RESULTS OF CONDUCTED TEST ITEMS

B1. Test Result of 20dB Spectrum Bandwidth

B2. Test Result of Frequency Stability

APPENDIX C. TEST RESULTS OF RADIATED TEST ITEMS

C1. Test Result of Field Strength of Fundamental Emissions

C2. Results of Radiated Emissions (9 kHz~30MHz)

C3. Results of Radiated Emissions (30MHz~1GHz)

APPENDIX D. SETUP PHOTOGRAPHS



REVISION HISTORY

REPORT NO.	VERSION	DESCRIPTION	ISSUED DATE
FR782510-01D	Rev. 01	Initial issue of report	Oct. 19, 2017



SUMMARY OF THE TEST RESULT

Applied Standard: 47 CFR FCC Part 15 Subpart C				
Part	FCC Rule	Description of Test	Result	Remark
3.1	15.207	AC Power Line Conducted Emissions	Complies	Under limit 6.80 dB at 13.560MHz
3.2	15.215(c)	20dB Spectrum Bandwidth	Complies	-
	-	99% OBW Spectrum Bandwidth	Complies	-
3.3	15.225(e)	Frequency Stability	Complies	-
3.4	15.225(a)(b)(c)	Field Strength of Fundamental Emissions	Complies	Max level 60.16 dBμV/m at 13.560 MHz
3.5	15.225(d) 15.209	Radiated Emissions	Complies	Under limit 14.09 dB at 30.000 MHz
3.6	15.203	Antenna Requirements	Complies	-

Test Items	Uncertainty	Remark
AC Power Line Conducted Emissions	±2.5dB	Confidence levels of 95%
Radiated Emissions (30MHz~1000MHz)	±5.1dB	Confidence levels of 95%



1. GENERAL INFORMATION

1.1 Applicant

OnePlus Technology (shenzhen) Co., Ltd

18C02, 18C03, 18C04 and 18C05, Shum Yip Terra Building, Binhe Avenue North, Futian District, Shenzhen

1.2 Manufacturer

OnePlus Technology (shenzhen) Co., Ltd

18C02, 18C03, 18C04 and 18C05, Shum Yip Terra Building, Binhe Avenue North, Futian District, Shenzhen

1.3 Product Feature of Equipment Under Test

Product Feature	
Equipment	Smart Phone
Brand Name	ONEPLUS
Model Name	ONEPLUS A5010
Marketing Name	ONEPLUS 5T
FCC ID	2ABZ2-A5010
EUT supports Radios application	CDMA/EV-DO/GSM/GPRS/EGPRS/WCDMA/HSPA/HSPA+/DC-HSDPA/LTE/NFC WLAN2.4GHz 802.11b/g/n HT20/HT40 WLAN2.4GHz 802.11ac VHT20/VHT40 WLAN5GHz 802.11a/n HT20/HT40 WLAN5GHz 802.11ac VHT20/VHT40/VHT80 Bluetooth v3.0+EDR/ Bluetooth v4.0 LE/ Bluetooth v4.1 LE/ Bluetooth v4.2 LE/ Bluetooth v5.0 LE
IMEI Code	Conducted: 866817030000889/866817030000889 Radiation: 866817030000947/866817030000947 Conduction: 866817030000988/866817030000988
HW Version	EC017
SW Version	oxygen version 4.7
EUT Stage	Production Unit

Remark: The above EUT's information was declared by manufacturer. Please refer to the specifications or user's manual for more detailed description.



1.4 Product Specification of Equipment Under Test

Standards-related Product Specification	
Tx/Rx Frequency Range	13.553 ~ 13.567MHz
Channel Number	1
20dBW	2.46 KHz
99%OBW	2.09 KHz
Antenna Type	Loop Antenna
Type of Modulation	ASK

Remark: The above EUT's information was declared by manufacturer. Please refer to the specifications or user's manual for more detailed description.



1.5 Modification of EUT

No modifications are made to the EUT during all test items.

1.6 Testing Location

Sporton Lab is accredited to ISO 17025 by National Voluntary Laboratory Accreditation Program (NVLAP code: 600156-0) and the FCC designation No. are CN5018 and CN5019.

Test Site	Sporton International (Shenzhen) Inc.		
Test Site Location	1/F, 2/F, Bldg 5, Shiling Industrial Zone, Xinwei Village, Xili, Nanshan Shenzhen City Guangdong Province 518055 China TEL: +86-755-8637-9589 FAX: +86-755-8637-9595		
Test Site No.	Sporton Site No.		FCC Test Firm Registration No.
	TH01-SZ	CO01-SZ	
Test Engineer	Sam Zheng	Peng Wang	251365
Temperature	24~26°C	22~25°C	
Relative Humidity	50~53%	50~55%	

Test Site	SPORTON International (ShenZhen) INC.		
Test Site Location	No. 3 Bldg the third floor of south, Shahe River west, Fengzeyuan Warehouse, Nanshan District Shenzhen City Guangdong Province 518055 China TEL: +86-755-3320-2398		
Test Site No.	Sporton Site No.		FCC Test Firm Registration No.
	03CH03-SZ		
Test Engineer	Liangliang Lu		577730
Temperature	23~25°C		
Relative Humidity	48~52%		

Note: The test site complies with ANSI C63.4 2014 requirement.



1.7 Applicable Standards

According to the specifications of the manufacturer, the EUT must comply with the requirements of the following standards:

- ♦ FCC Part 15 Subpart C §15.225
- ♦ ANSI C63.10-2013

2. TEST CONFIGURATION OF EQUIPMENT UNDER TEST

2.1 Descriptions of Test Mode

Investigation has been done on all the possible configurations for searching the worst cases.

The following table is a list of the test modes shown in this test report.

Test Items	
AC Power Line Conducted Emissions	Field Strength of Fundamental Emissions
20dB Spectrum Bandwidth	Frequency Stability
Radiated Emissions 9kHz~30MHz	Radiated Emissions 30MHz~1GHz

The EUT pre-scanned in three NFC type, A, B, F. The worst type (type F) was recorded in this report. Pre-scanned tests, X, Y, Z in three orthogonal panels to determine the final configuration (Z plane as worst plane) from all possible combinations.

2.2 Connection Diagram of Test System

<AC Conducted Emissions>

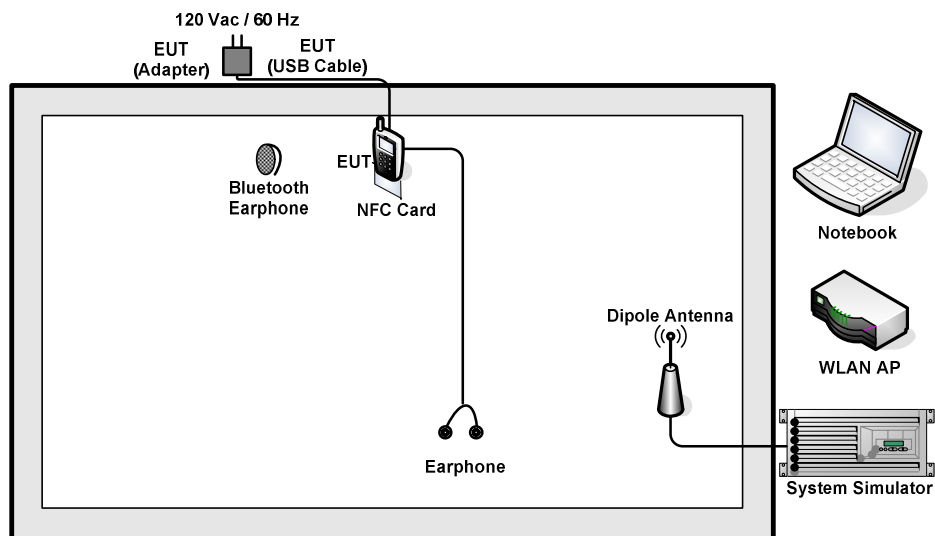

< For Fundamental Emissions and Mask and Radiated Emissions Measurement >

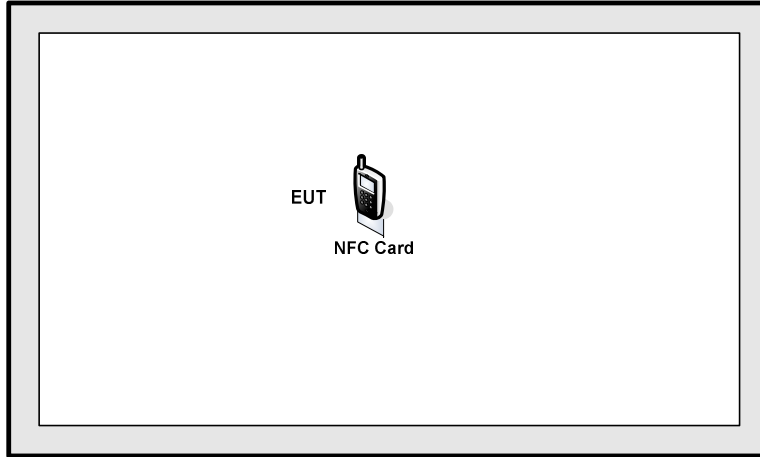

2.3 Table for Supporting Units

Support Unit	Manufacturer	Model	FCC ID
System Simulator	R&S	CMU 200	N/A
WLAN AP	D-Link	DIR-820L	KA2IR820LA1
Notebook	Lenovo	E540	FCC DoC
Bluetooth Earphone	Samsung	EO-MG900	PYAHS-107W
Earphone	Apple	MC690ZP/A	N/A
NFC Card	N/A	N/A	N/A

2.4 EUT Operation Test Setup

The EUT was programmed to be in continuously transmitting mode.

The ancillary equipment, NFC card, is used to make the EUT (NFC) continuously transmit at 13.56MHz and is placed around 3 cm gap to the EUT.

3. TEST RESULTS

3.1 AC Power Line Conducted Emissions Measurement

3.1.1 Limit of AC Conducted Emission

For equipment that is designed to be connected to the public utility (AC) power line, the radio frequency voltage that is conducted back onto the AC power line on any frequency or frequencies within the band 150 kHz to 30 MHz shall not exceed the limits in the following table.

Frequency of Emission (MHz)	Conducted Limit (dB μ V)	
	Quasi-Peak	Average
0.15-0.5	66 to 56*	56 to 46*
0.5-5	56	46
5-30	60	50

*Decreases with the logarithm of the frequency.

3.1.2 Measuring Instruments

See list of measuring instruments of this test report.

3.1.3 Test Procedures

1. The EUT was placed 0.4 meter from the conducting wall of the shielding room, and it was kept at least 80 centimeters from any other grounded conducting surface.
2. Connect EUT to the power mains through a line impedance stabilization network (LISN).
3. All the support units are connecting to the other LISN.
4. The LISN provides 50 ohm coupling impedance for the measuring instrument.
5. The FCC states that a 50 ohm, 50 microhenry LISN should be used.
6. Both sides of AC line were checked for maximum conducted interference.
7. The frequency range from 150 kHz to 30 MHz was searched.
8. Set the test-receiver system to Peak Detect Function and specified bandwidth (IF Bandwidth = 9kHz) with Maximum Hold Mode. Then measurement is also conducted by Average Detector and Quasi-Peak Detector Function respectively.

3.1.4 Test setup

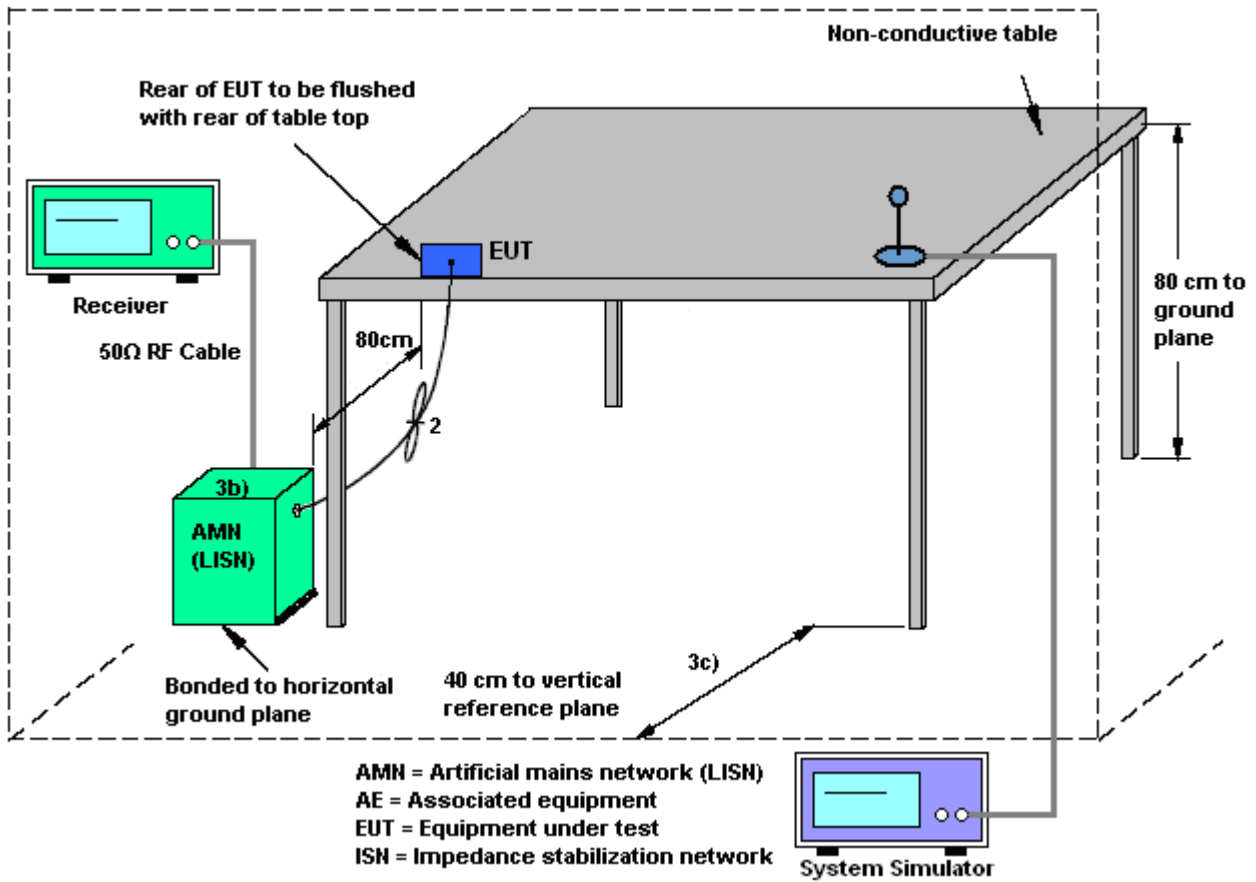

3.1.5 Test Result of AC Conducted Emission

Please refer to Appendix A.

3.2 20dB and 99% OBW Spectrum Bandwidth Measurement

3.2.1 Limit

Intentional radiators must be designed to ensure that the 20dB and 99% emission bandwidth in the specific band 13.553~13.567MHz.

3.2.2 Measuring Instruments

See list of measuring instruments of this test report.

3.2.3 Test Procedures

1. The spectrum analyzer connected via a receive antenna placed near the EUT in peak Max hold mode.
2. The resolution bandwidth of 1 kHz and the video bandwidth of 3 kHz were used.
3. Measured the spectrum width with power higher than 20dB below carrier.
4. Measured the 99% OBW.

3.2.4 Test Setup

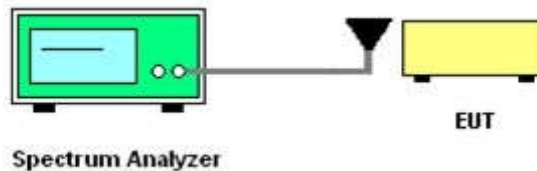

3.2.5 Test Result of Conducted Test Items

Please refer to Appendix B.

3.3 Frequency Stability Measurement

3.3.1 Limit

The frequency tolerance of the carrier signal shall be maintained within +/- 0.01% (100ppm) of the operating frequency over a temperature variation of -20 degrees to +50 degrees C at normal supply voltage, and for a variation in the primary supply voltage from 85% to 115% of the rated supply voltage at a temperature of 20 degrees C. For battery operated equipment, the equipment tests shall be performed using a new battery.

3.3.2 Measuring Instruments

See list of measuring instruments of this test report.

3.3.3 Test Procedures

1. The spectrum analyzer connected via a receive antenna placed near the EUT.
2. EUT have transmitted signal and fixed channelize.
3. Set the spectrum analyzer span to view the entire emissions bandwidth.
4. Set RBW = 1 kHz, VBW = 3 kHz with peak detector and maxhold settings.
5. The f_c is declaring of channel frequency. Then the frequency error formula is $(f_c - f) / f_c \times 10^6$ ppm and the limit is less than ± 100 ppm.
6. Extreme temperature rule is -20°C~50°C.

3.3.4 Test Setup

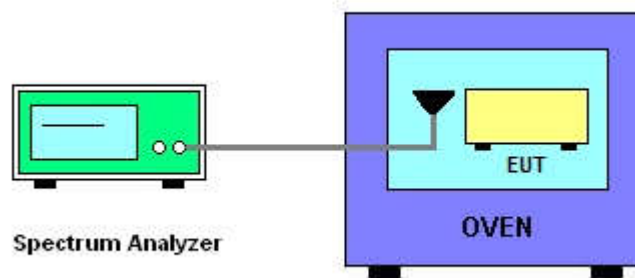

3.3.5 Test Result of Conducted Test Items

Please refer to Appendix B.

3.4 Field Strength of Fundamental Emissions and Mask Measurement

3.4.1 Limit

Rules and specifications	FCC CFR 47 Part 15 section 15.225 IC RSS-210 B.6			
	Description			
Description	Compliance with the spectrum mask is tested with RBW set to 9kHz.			
Freq. of Emission (MHz)	Field Strength (μ V/m) at 30m	Field Strength (dB μ V/m) at 30m	Field Strength (dB μ V/m) at 10m	Field Strength (dB μ V/m) at 3m
1.705~13.110	30	29.5	48.58	69.5
13.110~13.410	106	40.5	59.58	80.5
13.410~13.553	334	50.5	69.58	90.5
13.553~13.567	15848	84.0	103.08	124.0
13.567~13.710	334	50.5	69.58	90.5
13.710~14.010	106	40.5	59.58	80.5
14.010~30.000	30	29.5	48.58	69.5

3.4.2 Measuring Instruments

See list of measuring instruments of this test report.

3.4.3 Test Procedures

1. Configure the EUT according to ANSI C63.10. The EUT was placed on the top of the turntable 0.8 meter above ground. The phase center of the loop receiving antenna mounted antenna tower was placed 3 meters far away from the turntable.
2. Power on the EUT and all the supporting units. The turntable was rotated by 360 degrees to determine the position of the highest radiation.
3. The height of the receiving antenna was fixed at one meter above ground to find the maximum emissions field strength.
4. For Fundamental emissions, use the receiver to measure QP reading.

5. When the radiated emissions limits are expressed in terms of the average value of the emissions, and pulsed operation is employed, the measurement field strength shall be determined by averaging over one complete pulse train, including blanking intervals, as long as the pulse train does not exceed 0.1 seconds. As an alternative (provided the transmitter operates for longer than 0.1 seconds) or in cases where the pulse train exceeds 0.1 seconds, the measured field strength shall be determined from the average absolute voltage during a 0.1 second interval during which the field strength is at its maximum value.
6. Compliance with the spectrum mask is tested with RBW set to 9kHz.
Note: Emission level (dB μ V/m) = 20 log Emission level (μ V/m).

3.4.4 Test Setup

For radiated emissions below 30MHz

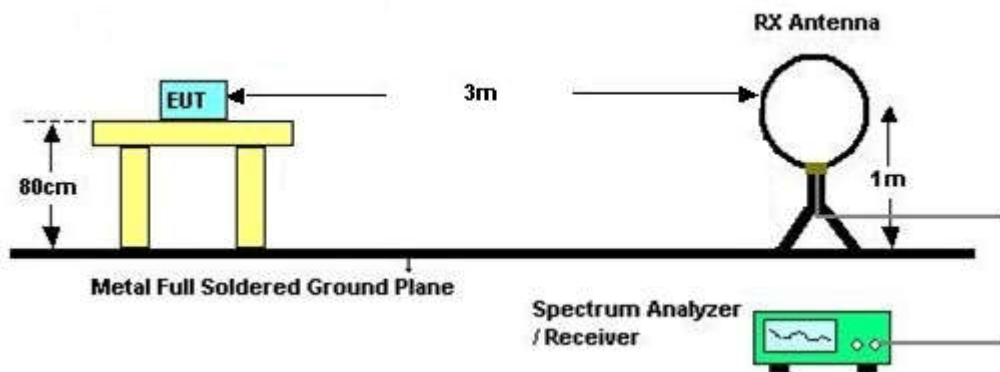

3.4.5 Test Result of Field Strength of Fundamental Emissions and Mask

Please refer to Appendix C.

3.5 Radiated Emissions Measurement

3.5.1 Limit

The field strength of any emissions which appear outside of 13.110 ~14.010MHz band shall not exceed the general radiated emissions limits.

Frequencies (MHz)	Field Strength ($\mu\text{V/m}$)	Measurement Distance (meters)
0.009~0.490	2400/F(kHz)	300
0.490~1.705	24000/F(kHz)	30
1.705~30.0	30	30
30~88	100	3
88~216	150	3
216~960	200	3
Above 960	500	3

3.5.2 Measuring Instruments

See list of measuring instruments of this test report.

3.5.3 Measuring Instrument Setting

The following table is the setting of receiver.

Receiver Parameter	Setting
Attenuation	Auto
Frequency Range: 9kHz~150kHz	RBW 200Hz for QP
Frequency Range: 150kHz~30MHz	RBW 9kHz for QP
Frequency Range: 30MHz~1000MHz	RBW 120kHz for Peak

Note: The emission limits shown in the above table are based on measurements employing a CISPR quasi-peak detector except for the frequency bands 9-90 kHz, 110-490 kHz. Radiated emission limits in these two bands are based on measurements employing an average detector.



3.5.4 Test Procedures

1. Configure the EUT according to ANSI C63.10. The EUT was placed on the top of the turntable 0.8 meter above ground. The phase center of the receiving antenna mounted on the top of a height-variable antenna tower was placed 3 meters far away from the turntable.
2. Power on the EUT and all the supporting units. The turntable was rotated by 360 degrees to determine the position of the highest radiation.
3. The height of the broadband receiving antenna was varied between one meter and four meters above ground to find the maximum emissions field strength of both horizontal and vertical polarization.
4. For each suspected emissions, the antenna tower was scan (from 1 M to 4 M) and then the turntable was rotated (from 0 degree to 360 degrees) to find the maximum reading.
5. Set the test-receiver system to Peak or CISPR quasi-peak Detect Function with specified bandwidth under Maximum Hold Mode.
6. When the radiated emissions limits are expressed in terms of the average value of the emissions, and pulsed operation is employed, the measurement field strength shall be determined by averaging over one complete pulse train, including blanking intervals, as long as the pulse train does not exceed 0.1 seconds. As an alternative (provided the transmitter operates for longer than 0.1 seconds) or in cases where the pulse train exceeds 0.1 seconds, the measured field strength shall be determined from the average absolute voltage during a 0.1 second interval during which the field strength is at its maximum value.
7. In case the emission is lower than 30MHz, loop antenna has to be used for measurement and the recorded data should be QP measured by receiver. Antenna Requirements

3.5.5 Test Setup

For radiated emissions above 30MHz

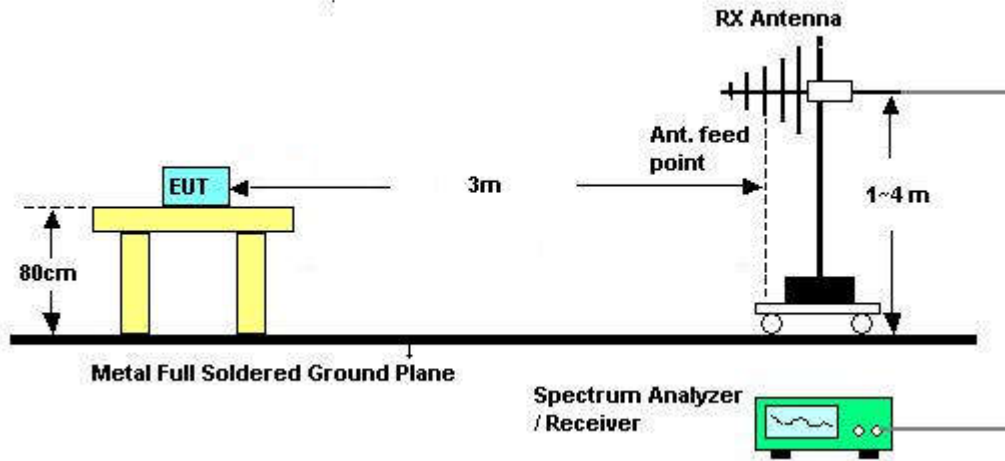

3.5.6 Test Result of Radiated Emissions Measurement

Please refer to Appendix C.



3.6 Antenna Requirements

3.6.1 Standard Applicable

Except for special regulations, the Low-power Radio-frequency Devices must not be equipped with any jacket for installing an antenna with extension cable. An intentional radiator shall be designed to ensure that no antenna other than that furnished by the responsible party shall be used with the device. The use of a permanently attached antenna or of an antenna that uses a unique coupling to the intentional radiator shall be considered sufficient to comply with the provisions of this Section. The manufacturer may design the unit so that the user can replace a broken antenna, but the use of a standard antenna jack or electrical connector is prohibited.

The use of a permanently attached antenna or of an antenna that uses a unique coupling to the intentional radiator shall be considered sufficient to comply with the FCC rule.

3.6.2 Antenna Anti-Replacement Construction

An embedded-in antenna design is used.



4. LIST OF MEASURING EQUIPMENT

Instrument	Manufacturer	Model No.	Serial No.	Characteristics	Calibration Date	Test Date	Due Date	Remark
Spectrum Analyzer	R&S	FSV40	101078	9kHz~40GHz	Apr. 20, 2017	Sep. 28, 2017	Apr. 19, 2018	Conducted (TH01-SZ)
Thermal Chamber	Ten Billion Hongzhangroup	LP-150U	H201408180 3	-40~+150°C	Jul. 20, 2017	Sep. 28, 2017	Jul. 19, 2018	Conducted (TH01-SZ)
AC Power Source	Chroma	61602	6160200008 91	100Vac~250Vac	Jul. 19, 2017	Sep. 28, 2017	Jul. 18, 2018	Conducted (TH01-SZ)
EMI Test Receiver&SA	KEYSIGHT	N9038A	MY5445008 3	20Hz~8.4GHz	Apr. 20, 2017	Sep. 24, 2017	Apr. 19, 2018	Radiation (03CH03-SZ)
EXA Spectrum Analyzer	KEYSIGHT	N9010A	MY5515024 6	10Hz~44GHz;	Apr. 20, 2017	Sep. 24, 2017	Apr. 19, 2018	Radiation (03CH03-SZ)
Loop Antenna	R&S	HFH2-Z2	100354	9kHz~30MHz	May 14, 2017	Sep. 24, 2017	May 13, 2018	Radiation (03CH03-SZ)
Bilog Antenna	TeseQ	CBL6112D	35408	30MHz-2GHz	May 14, 2017	Sep. 24, 2017	May 13, 2018	Radiation (03CH03-SZ)
Amplifier	Burgeon	BPA-530	102210	0.01Hz ~3000MHz	Apr. 20, 2017	Sep. 24, 2017	Apr. 19, 2018	Radiation (03CH03-SZ)
AC Power Source	Chroma	61601	6160100019 85	N/A	NCR	Sep. 24, 2017	NCR	Radiation (03CH03-SZ)
Turn Table	EM	EM1000	N/A	0~360 degree	NCR	Sep. 24, 2017	NCR	Radiation (03CH03-SZ)
Antenna Mast	EM	EM1000	N/A	1 m~4 m	NCR	Sep. 24, 2017	NCR	Radiation (03CH03-SZ)
EMI Receiver	R&S	ESR7	101630	9kHz~7GHz;	Jan. 06, 2017	Sep. 22, 2017	Jan. 05, 2018	Conduction (CO01-SZ)
AC LISN	EMCO	3816/2SH	00103912	9kHz~30MHz	Jan. 05, 2017	Sep. 22, 2017	Jan. 04, 2018	Conduction (CO01-SZ)
AC LISN (for auxiliary equipment)	MessTec	3816/2SH	00103892	9kHz~30MHz	Jan. 05, 2017	Sep. 22, 2017	Jan. 04, 2018	Conduction (CO01-SZ)
AC Power Source	Chroma	61602	6160200008 91	100Vac~250Vac	Jul. 19, 2017	Sep. 22, 2017	Jul. 18, 2018	Conduction (CO01-SZ)

NCR: No Calibration Required



Appendix A. Test Results of Conducted Emission Test

Test Mode :	NFC Tx	Test Voltage :	120Vac / 60Hz
Function Type :	GSM1900 Idle + Bluetooth Link + WLAN Link + USB Cable (Charging from Adapter) + Earphone + NFC Tx + SIM 1		

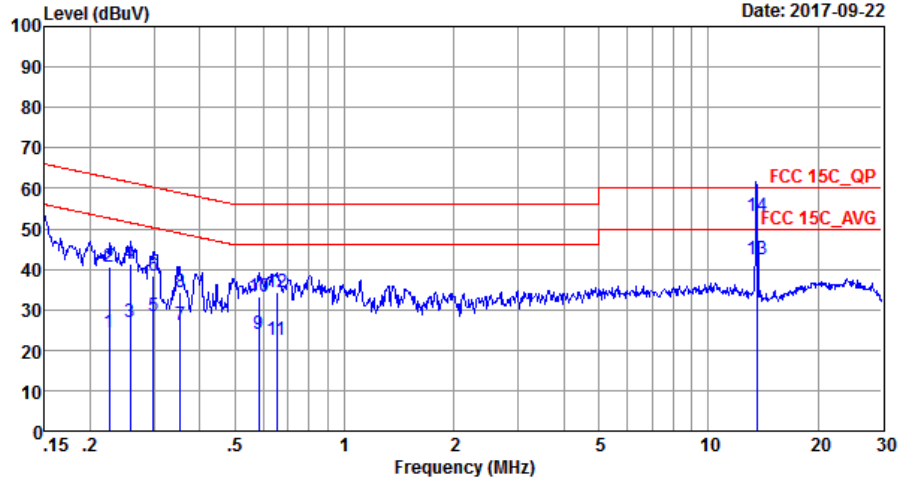

Site : CO01-SZ
 Condition: FCC 15C_QP LISN_20170907_L LINE

IMEI : 866817030000988/866817030000988

	Freq	Level	Over Limit	Limit Line	Read Level	LISN Factor	Cable Loss	Remark
	MHz	dBuV	dB	dBuV	dBuV	dB	dB	
1	0.23	24.45	-28.16	52.61	14.20	0.03	10.22	Average
2	0.23	40.75	-21.86	62.61	30.50	0.03	10.22	QP
3	0.26	26.95	-24.56	51.51	16.70	0.03	10.22	Average
4	0.26	41.45	-20.06	61.51	31.20	0.03	10.22	QP
5	0.30	28.55	-21.73	50.28	18.30	0.03	10.22	Average
6	0.30	38.45	-21.83	60.28	28.20	0.03	10.22	QP
7	0.35	26.13	-22.74	48.87	15.90	0.03	10.20	Average
8	0.35	34.43	-24.44	58.87	24.20	0.03	10.20	QP
9	0.58	23.99	-22.01	46.00	13.80	0.02	10.17	Average
10	0.58	33.29	-22.71	56.00	23.10	0.02	10.17	QP
11	0.65	22.39	-23.61	46.00	12.20	0.02	10.17	Average
12	0.65	34.29	-21.71	56.00	24.10	0.02	10.17	QP
13	13.56	42.40	-7.60	50.00	31.60	0.47	10.33	Average
14 *	13.56	53.20	-6.80	60.00	42.40	0.47	10.33	QP



Test Mode :	NFC Tx	Test Voltage :	120Vac / 60Hz
Function Type :	GSM1900 Idle + Bluetooth Link + WLAN Link + USB Cable (Charging from Adapter) + Earphone + NFC Tx + SIM 1		

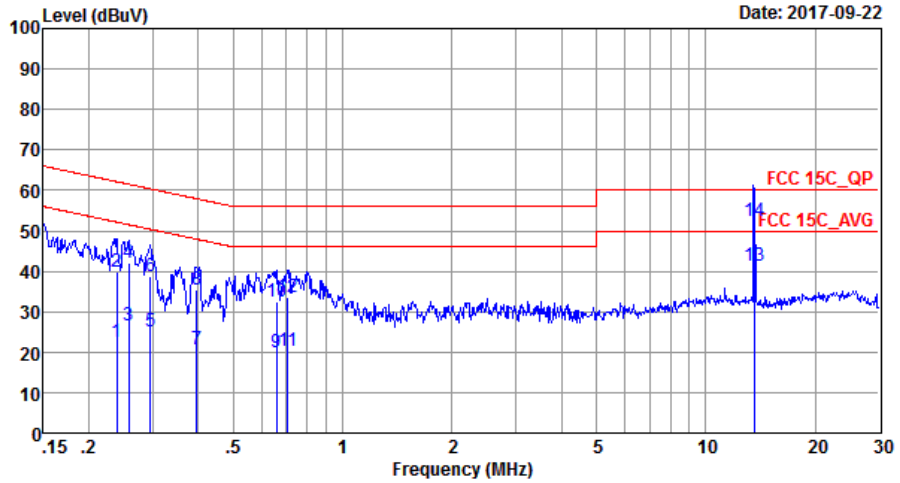

Site : C001-SZ
 Condition: FCC 15C_QP LISN_20170907_N NEUTRAL

IMEI : 866817030000988/866817030000988

	Freq	Level	Over Limit	Limit	Read	LISN	Cable	Remark
	MHz	dBuV	dB	dBuV	dBuV	dB	dB	
1	0.24	22.65	-29.48	52.13	12.40	0.03	10.22	Average
2	0.24	39.85	-22.28	62.13	29.60	0.03	10.22	QP
3	0.26	26.55	-24.96	51.51	16.30	0.03	10.22	Average
4	0.26	42.05	-19.46	61.51	31.80	0.03	10.22	QP
5	0.30	24.95	-25.42	50.37	14.70	0.03	10.22	Average
6	0.30	38.85	-21.52	60.37	28.60	0.03	10.22	QP
7	0.40	20.51	-27.44	47.95	10.30	0.02	10.19	Average
8	0.40	35.31	-22.64	57.95	25.10	0.02	10.19	QP
9	0.66	19.89	-26.11	46.00	9.70	0.02	10.17	Average
10	0.66	32.59	-23.41	56.00	22.40	0.02	10.17	QP
11	0.70	20.29	-25.71	46.00	10.10	0.02	10.17	Average
12	0.70	33.69	-22.31	56.00	23.50	0.02	10.17	QP
13	13.56	41.21	-8.79	50.00	30.59	0.29	10.33	Average
14 *	13.56	52.51	-7.49	60.00	41.89	0.29	10.33	QP



Appendix B. Test Results of Conducted Test Items

B1. Test Result of 20dB Spectrum Bandwidth

Test mode	NFC Tx	Test Frequency (MHz)	13.56																																																								
<table border="1"> <thead> <tr> <th>Type</th> <th>Ref</th> <th>Trc</th> <th>X-value</th> <th>Y-value</th> <th>Function</th> <th>Function Result</th> </tr> </thead> <tbody> <tr> <td>M1</td> <td>1</td> <td></td> <td>13.55972 MHz</td> <td>-6.46 dBm</td> <td>ndB down</td> <td>2.458 kHz</td> </tr> <tr> <td>T1</td> <td>1</td> <td></td> <td>13.558492 MHz</td> <td>-26.31 dBm</td> <td>ndB</td> <td>20.00 dB</td> </tr> <tr> <td>T2</td> <td>1</td> <td></td> <td>13.560949 MHz</td> <td>-26.51 dBm</td> <td>Q factor</td> <td>5517.6</td> </tr> </tbody> </table>		Type	Ref	Trc	X-value	Y-value	Function	Function Result	M1	1		13.55972 MHz	-6.46 dBm	ndB down	2.458 kHz	T1	1		13.558492 MHz	-26.31 dBm	ndB	20.00 dB	T2	1		13.560949 MHz	-26.51 dBm	Q factor	5517.6	<table border="1"> <thead> <tr> <th>Type</th> <th>Ref</th> <th>Trc</th> <th>X-value</th> <th>Y-value</th> <th>Function</th> <th>Function Result</th> </tr> </thead> <tbody> <tr> <td>M1</td> <td>1</td> <td></td> <td>13.55972 MHz</td> <td>-6.00 dBm</td> <td></td> <td></td> </tr> <tr> <td>T1</td> <td>1</td> <td></td> <td>13.5586713 MHz</td> <td>-20.01 dBm</td> <td>Occ Bw</td> <td>2.087912088 kHz</td> </tr> <tr> <td>T2</td> <td>1</td> <td></td> <td>13.5607592 MHz</td> <td>-19.90 dBm</td> <td></td> <td></td> </tr> </tbody> </table>		Type	Ref	Trc	X-value	Y-value	Function	Function Result	M1	1		13.55972 MHz	-6.00 dBm			T1	1		13.5586713 MHz	-20.01 dBm	Occ Bw	2.087912088 kHz	T2	1		13.5607592 MHz	-19.90 dBm		
Type	Ref	Trc	X-value	Y-value	Function	Function Result																																																					
M1	1		13.55972 MHz	-6.46 dBm	ndB down	2.458 kHz																																																					
T1	1		13.558492 MHz	-26.31 dBm	ndB	20.00 dB																																																					
T2	1		13.560949 MHz	-26.51 dBm	Q factor	5517.6																																																					
Type	Ref	Trc	X-value	Y-value	Function	Function Result																																																					
M1	1		13.55972 MHz	-6.00 dBm																																																							
T1	1		13.5586713 MHz	-20.01 dBm	Occ Bw	2.087912088 kHz																																																					
T2	1		13.5607592 MHz	-19.90 dBm																																																							
20dB Bandwidth (kHz)	2.46	99% OccupiedBW(kHz)	2.09																																																								
Frequency range (MHz)	$f_L > 13.553$		13.558492																																																								
	$f_H < 13.567$		13.560949																																																								
			Test Result																																																								
			Complies																																																								

Remark: Because the measured signal is CW/CW-like adjusting the RBW per C63.10 would not be practical since measured bandwidth will always follow the RBW and the result will be approximately twice the RBW



B2. Test Result of Frequency Stability

Voltage vs. Frequency Stability		Temperature vs. Frequency Stability	
Voltage (Vac)	Measurement Frequency (MHz)	Temperature (°C)	Measurement Frequency (MHz)
120	13.559721	-20	13.559721
102	13.559716	-10	13.559716
138	13.559716	0	13.559716
		10	13.559716
		20	13.559716
		30	13.559721
		40	13.559716
		50	13.559721
Max.Deviation (MHz)	-0.000284	Max.Deviation (MHz)	-0.000284
Max.Deviation (ppm)	-20.9440	Max.Deviation (ppm)	-20.9440
Limit	FS < ±100 ppm	Limit	FS < ±100 ppm
Test Result	PASS	Test Result	PASS



Appendix C. Test Results of Radiated Test Items

C1. Test Result of Field Strength of Fundamental Emissions

Test Mode :	NFC Tx	Test Frequency (MHz)	13.56				
Site	: 03CH03-SZ						
Condition	: 15.225 LIMIT 3m LOOP ANT_170514 HORIZONTAL						
IMEI	: 866817030000947/866817030000947						
	Over Level	Limit	ReadAntenna	Cable	A/Pos	T/Pos	Remark
	Freq	Level	Line	Level	Loss		
	MHz	dBuV/m	dB	dBuV/m	dB	cm	deg
1	13.56	60.16	-63.84	124.00	40.24	19.47	0.45 --- --- QP
Site	: 03CH03-SZ						
Condition	: 15.225 LIMIT 3m LOOP ANT_170514 VERTICAL						
IMEI	: 866817030000947/866817030000947						
	Over Level	Limit	ReadAntenna	Cable	A/Pos	T/Pos	Remark
	Freq	Level	Line	Level	Loss		
	MHz	dBuV/m	dB	dBuV/m	dB	cm	deg
1	13.56	55.63	-68.37	124.00	35.71	19.47	0.45 --- --- QP



C2. Results of Radiated Spurious Emissions (9 kHz~30MHz)

Test Mode :	NFC Tx	Polarization :	Horizontal
-------------	--------	----------------	------------

Frequency (MHz)	Level (dBμV/m)	Over Limit (dB)	Limit Line (dBμV/m)	Read Level (dBμV)	Antenna Factor (dB)	Cable Loss (dB)	Ant Pos (cm)	Table Pos (deg)	Remark
0.01	50.28	-77.13	127.41	29.23	21.00	0.05	-	-	Average
0.07	39.37	-71.94	111.31	18.81	20.50	0.06	-	-	Average
0.10	33.80	-74.19	107.99	13.03	20.70	0.07	-	-	QP
0.14	36.90	-67.70	104.60	16.22	20.60	0.08	-	-	Average
0.25	46.16	-53.36	99.52	25.73	20.33	0.10	-	-	Average
2.12	35.58	-34.42	70.00	14.86	20.54	0.18	-	-	QP
10.10	35.00	-35.00	70.00	14.26	20.35	0.39	-	-	QP
24.58	34.08	-35.92	70.00	13.91	19.59	0.58	-	-	QP
28.83	34.41	-35.59	70.00	14.43	19.32	0.66	-	-	QP

Test Mode :	NFC Tx	Polarization :	Vertical
-------------	--------	----------------	----------

Frequency (MHz)	Level (dBμV/m)	Over Limit (dB)	Limit Line (dBμV/m)	Read Level (dBμV)	Antenna Factor (dB)	Cable Loss (dB)	Ant Pos (cm)	Table Pos (deg)	Remark
0.01	50.45	-76.92	127.37	29.40	21.00	0.05	-	-	Average
0.07	41.06	-70.25	111.31	20.50	20.50	0.06	-	-	Average
0.10	33.98	-73.59	107.57	13.21	20.70	0.07	-	-	QP
0.14	36.09	-68.51	104.60	15.41	20.60	0.08	-	-	Average
0.25	46.31	-53.27	99.58	25.88	20.33	0.1	-	-	Average
2.01	36.15	-33.85	70.00	15.42	20.55	0.18	-	-	QP
9.37	34.50	-35.50	70.00	13.74	20.38	0.38	-	-	QP
24.85	33.10	-36.90	70.00	12.85	19.66	0.59	-	-	QP
29.52	34.89	-35.11	70.00	14.71	19.51	0.67	-	-	QP

Note:

1. The amplitude of spurious emissions which are attenuated by more than 20dB below the permissible value has no need to be reported.
2. Distance extrapolation factor = 40 log (specific distance / test distance) (dB);
3. Limit line = specific limits (dBμV) + distance extrapolation factor.



C3. Results of Radiated Spurious Emissions (30MHz~1GHz)

Test Mode :	NFC Tx	Polarization :	Horizontal
-------------	--------	----------------	------------

Frequency (MHz)	Level (dBμV/m)	Over Limit (dB)	Limit Line (dBμV/m)	Read Level (dBμV)	Antenna Factor (dB)	Cable Loss (dB)	Preamp Factor (dB)	Ant Pos (cm)	Table Pos (deg)	Remark
30	25.31	-14.69	40	30.05	26.7	0.56	32	120	50	Peak
113.42	18.34	-25.16	43.5	30.39	18.53	1.1	31.68	-	-	Peak
256.98	19.98	-26.02	46	31.54	18.15	1.68	31.39	-	-	Peak
403.45	26.81	-19.19	46	30	25.92	2.13	31.24	-	-	Peak
567.38	27.64	-18.36	46	31.23	25.03	2.59	31.21	-	-	Peak
982.54	31.83	-22.17	54	29.56	30.05	3.45	31.23	-	-	Peak

Test Mode :	NFC Tx	Polarization :	Vertical
-------------	--------	----------------	----------

Frequency (MHz)	Level (dBμV/m)	Over Limit (dB)	Limit Line (dBμV/m)	Read Level (dBμV)	Antenna Factor (dB)	Cable Loss (dB)	Preamp Factor (dB)	Ant Pos (cm)	Table Pos (deg)	Remark
30	25.91	-14.09	40	30.65	26.7	0.56	32	110	45	Peak
40.67	25.3	-14.7	40	34.69	21.94	0.66	31.99	-	-	Peak
232.73	18.86	-27.14	46	31.47	17.17	1.59	31.37	-	-	Peak
407.33	27	-19	46	30.27	25.83	2.14	31.24	-	-	Peak
765.26	30.94	-15.06	46	31.81	27.33	3.02	31.22	-	-	Peak
988.36	32.32	-21.68	54	29.92	30.17	3.46	31.23	-	-	Peak

Note:

1. The amplitude of spurious emissions which are attenuated by more than 20dB below the permissible value has no need to be reported.
2. Emission level (dBμV/m) = 20 log Emission level (μV/m).
3. Corrected Reading: Antenna Factor + Cable Loss + Read Level - Preamp Factor= Level.