



FCC RF Test Report

APPLICANT : OnePlus Technology (shenzhen) Co., Ltd
EQUIPMENT : Smart Phone
BRAND NAME : ONEPLUS
MODEL NAME : ONEPLUS A5000
FCC ID : 2ABZ2-A5000
STANDARD : FCC Part 15 Subpart C §15.247
CLASSIFICATION : (DTS) Digital Transmission System

The product was received on Jan. 22, 2017 and testing was completed on May 04, 2017. We, Sporton International (ShenZhen) INC., would like to declare that the tested sample has been evaluated in accordance with the test procedures and has been in compliance with the applicable technical standards.

The test results in this report apply exclusively to the tested model / sample. Without written approval of Sporton International (ShenZhen) INC., the test report shall not be reproduced except in full.

Prepared by: Eric Shih / Manager

Approved by: Jones Tsai / Manager



SPORTON International (ShenZhen) INC.

1/F, 2/F, Bldg 5, Shiling Industrial Zone, Xinwei Village, Xili, Nanshan District, Shenzhen City, Guangdong Province, China



TABLE OF CONTENTS

REVISION HISTORY..... 3

SUMMARY OF TEST RESULT 4

1 GENERAL DESCRIPTION 5

 1.1 Applicant 5

 1.2 Manufacturer 5

 1.3 Product Feature of Equipment Under Test..... 5

 1.4 Product Specification of Equipment Under Test..... 6

 1.5 Modification of EUT 6

 1.6 Testing Location 7

 1.7 Applicable Standards..... 7

2 TEST CONFIGURATION OF EQUIPMENT UNDER TEST 8

 2.1 Carrier Frequency and Channel 8

 2.2 Test Mode..... 9

 2.3 Connection Diagram of Test System..... 10

 2.4 Support Unit used in test configuration and system 11

 2.5 EUT Operation Test Setup 11

 2.6 Measurement Results Explanation Example..... 11

3 TEST RESULT 12

 3.1 6dB and 99% Bandwidth Measurement 12

 3.2 Peak and Average Output Power Measurement..... 14

 3.3 Power Spectral Density Measurement 16

 3.4 Conducted Band Edges and Spurious Emission Measurement 18

 3.5 Radiated Band Edges and Spurious Emission Measurement 67

 3.6 AC Conducted Emission Measurement..... 71

 3.7 Antenna Requirements 75

4 LIST OF MEASURING EQUIPMENT 76

5 UNCERTAINTY OF EVALUATION 77

APPENDIX A. CONDUCTED TEST RESULTS

APPENDIX B. RADIATED SPURIOUS EMISSION

APPENDIX C. DUTY CYCLE PLOTS

APPENDIX D. SETUP PHOTOGRAPHS



REVISION HISTORY

REPORT NO.	VERSION	DESCRIPTION	ISSUED DATE
FR712206C	Rev. 01	Initial issue of report	May 26, 2017



SUMMARY OF TEST RESULT

Report Section	FCC Rule	Description	Limit	Result	Remark
3.1	15.247(a)(2)	6dB Bandwidth	$\geq 0.5\text{MHz}$	Pass	-
3.1	-	99% Bandwidth	-	Pass	-
3.2	15.247(b)	Power Output Measurement	$\leq 30\text{dBm}$	Pass	-
3.3	15.247(e)	Power Spectral Density	$\leq 8\text{dBm}/3\text{kHz}$	Pass	-
3.4	15.247(d)	Conducted Band Edges	$\leq 20\text{dBc}$	Pass	-
		Conducted Spurious Emission		Pass	-
3.5	15.247(d)	Radiated Band Edges and Radiated Spurious Emission	15.209(a) & 15.247(d)	Pass	Under limit 3.18 dB at 7311.000 MHz
3.6	15.207	AC Conducted Emission	15.207(a)	Pass	Under limit 13.96 dB at 0.150 MHz
3.7	15.203 & 15.247(b)	Antenna Requirement	N/A	Pass	-



1 General Description

1.1 Applicant

OnePlus Technology (shenzhen) Co., Ltd

18C02, 18C03, 18C04 and 18C05, Shum Yip Terra Building, Binhe Avenue North, Futian District, Shenzhen

1.2 Manufacturer

OnePlus Technology (shenzhen) Co., Ltd

18C02, 18C03, 18C04 and 18C05, Shum Yip Terra Building, Binhe Avenue North, Futian District, Shenzhen

1.3 Product Feature of Equipment Under Test

Product Feature	
Equipment	Smart Phone
Brand Name	ONEPLUS
Model Name	ONEPLUS A5000
FCC ID	2ABZ2-A5000
EUT supports Radios application	CDMA/EVDO/GSM/GPRS/EGPRS/WCDMA/HSPA/DC-HSDPA/ HSPA+/LTE/NFC WLAN 2.4GHz 802.11b/g/n HT20/HT40 WLAN2.4GHz 802.11ac VHT20/VHT40 WLAN 5GHz 802.11a/n HT20/HT40 WLAN5GHz 802.11ac VHT20/VHT40/VHT80/ Bluetooth v3.0 + EDR/ Bluetooth v 4.0 LE/ Bluetooth v4.1 LE/ Bluetooth v4.2 LE/ Bluetooth v5.0 LE
IMEI Code	Conducted: 001001228348725/001001228348725 Conduction: 001001228285661/001001228285661 Radiation: 001001228230279/001001228230279
HW Version	EB101
SW Version	H2OS V3.5
EUT Stage	Production Unit

Remark: The above EUT's information was declared by manufacturer. Please refer to the specifications or user's manual for more detailed description.



1.4 Product Specification of Equipment Under Test

Standards-related Product Specification										
Tx/Rx Channel Frequency Range	2412 MHz ~ 2462 MHz									
Maximum (Peak) Output Power to antenna	<p><Ant. 1> 802.11b : 21.17 dBm (0.1309 W) 802.11g : 21.85 dBm (0.1531 W) 802.11n HT20 : 22.96 dBm (0.1977 W) 802.11n HT40 : 23.51 dBm (0.2244 W) 802.11ac VHT20 : 22.91 dBm (0.1954 W) 802.11ac VHT40 : 23.48 dBm (0.2228 W)</p> <p><Ant. 2> 802.11b : 18.35 dBm (0.0684 W) 802.11g : 19.96 dBm (0.0991 W) 802.11n HT20 : 19.07 dBm (0.0807 W) 802.11n HT40 : 20.75 dBm (0.1189 W) 802.11ac VHT20 : 19.03 dBm (0.0800 W) 802.11ac VHT40 : 20.63 dBm (0.1156 W)</p> <p>MIMO <Ant. 1 + 2> 802.11b : 21.02 dBm (0.1265 W) 802.11g : 22.53 dBm (0.1791 W) 802.11n HT20 : 22.49 dBm (0.1774 W) 802.11n HT40 : 22.44 dBm (0.1754 W) 802.11ac VHT20 : 22.43 dBm (0.1750 W) 802.11ac VHT40 : 22.39 dBm (0.1734 W)</p>									
99% Occupied Bandwidth	802.11b : 13.94MHz 802.11g : 17.68MHz 802.11n HT20 : 18.83MHz 802.11n HT40 : 36.76MHz									
Antenna Type / Gain	Ant. 1: PIFA Antenna with gain -2.80 dBi Ant. 2: PIFA Antenna with gain -3.00 dBi									
Type of Modulation	802.11b : DSSS (DBPSK / DQPSK / CCK) 802.11g/n : OFDM (BPSK / QPSK / 16QAM / 64QAM) 802.11ac : OFDM (BPSK / QPSK / 16QAM / 64QAM / 256QAM)									
Antenna Function for Transmitter	<table border="1"> <thead> <tr> <th></th> <th>Ant. 1</th> <th>Ant. 2</th> </tr> </thead> <tbody> <tr> <td>802.11 b/g/n/ac SISO</td> <td>V</td> <td>V</td> </tr> <tr> <td>802.11 b/g/n/ac MIMO</td> <td>V</td> <td>V</td> </tr> </tbody> </table>		Ant. 1	Ant. 2	802.11 b/g/n/ac SISO	V	V	802.11 b/g/n/ac MIMO	V	V
	Ant. 1	Ant. 2								
802.11 b/g/n/ac SISO	V	V								
802.11 b/g/n/ac MIMO	V	V								

Note:

1. MIMO Ant. 1+2 is a calculated result from sum of the power MIMO Ant. 1 and MIMO Ant. 2.
2. For 802.11n HT20 / ac VHT20 and 802.11n HT40 / ac VHT40 mode, the whole testing have assessed only 802.11n HT20/ HT40 by referring to their maximum conducted power.

1.5 Modification of EUT

No modifications are made to the EUT during all test items.



1.6 Testing Location

Test Site	SPORTON International (ShenZhen) INC.	
Test Site Location	1/F, 2/F, Bldg 5, Shiling Industrial Zone, Xinwei Village, Xili, Nanshan District, Shenzhen City, Guangdong Province, China TEL: +86-755-8637-9589 FAX: +86-755-8637-9595	
Test Site No.	Sporton Site No.	
	TH01-SZ	CO01-SZ

Test Site	SPORTON International (ShenZhen) INC.	
Test Site Location	No. 3 Building, the third floor of south, Shahe River west, Fengzeyuan warehouse, Nanshan District, Shenzhen, Guangdong, P. R. China TEL: +86-755- 3320-2398	
Test Site No.	Sporton Site No.	FCC Registration No.
	03CH03-SZ	565805

Note: The test site complies with ANSI C63.4 2014 requirement.

1.7 Applicable Standards

According to the specifications of the manufacturer, the EUT must comply with the requirements of the following standards:

- ♦ FCC Part 15 Subpart C §15.247
- ♦ FCC KDB Publication No. 558074 D01 DTS Meas. Guidance v04
- ♦ FCC KDB 662911 D01 Multiple Transmitter Output v02r01
- ♦ ANSI C63.10-2013

Remark:

1. All test items were verified and recorded according to the standards and without any deviation during the test.
2. This EUT has also been tested and complied with the requirements of FCC Part 15, Subpart B, recorded in a separate test report.



2 Test Configuration of Equipment Under Test

The EUT has been associated with peripherals and configuration operated in a manner tended to maximize its emission characteristics in a typical application. Frequency range investigated: conducted emission (150 kHz to 30 MHz) and radiated emission (9 kHz to the 10th harmonic of the highest fundamental frequency or to 40 GHz, whichever is lower). For radiated measurement, pre-scanned in three orthogonal panels, X, Y, Z. The worst cases were recorded in this report.

2.1 Carrier Frequency and Channel

Frequency Band	Channel	Freq. (MHz)	Channel	Freq. (MHz)
2400-2483.5 MHz	1	2412	7	2442
	2	2417	8	2447
	3	2422	9	2452
	4	2427	10	2457
	5	2432	11	2462
	6	2437	-	-



2.2 Test Mode

Final test mode of radiated spurious emissions is considering the modulation as below table.

Single Antenna

Modulation	Data Rate
802.11b	1 Mbps
802.11g	6 Mbps
802.11n HT20	MCS0
802.11n HT40	MCS0
802.11ac VHT20	MCS0
802.11ac VHT40	MCS0

MIMO Antenna

Modulation	Data Rate
802.11b	1 Mbps
802.11g	6 Mbps
802.11n HT20	MCS0
802.11n HT40	MCS0
802.11ac VHT20	MCS0
802.11ac VHT40	MCS0

Test Cases	
AC Conducted Emission	Mode 1: GSM1900 Idle + Bluetooth Link + WLAN Link + USB Cable (Charging from Adapter) + Earphone + SIM 2

2.3 Connection Diagram of Test System

<WLAN Tx Mode>

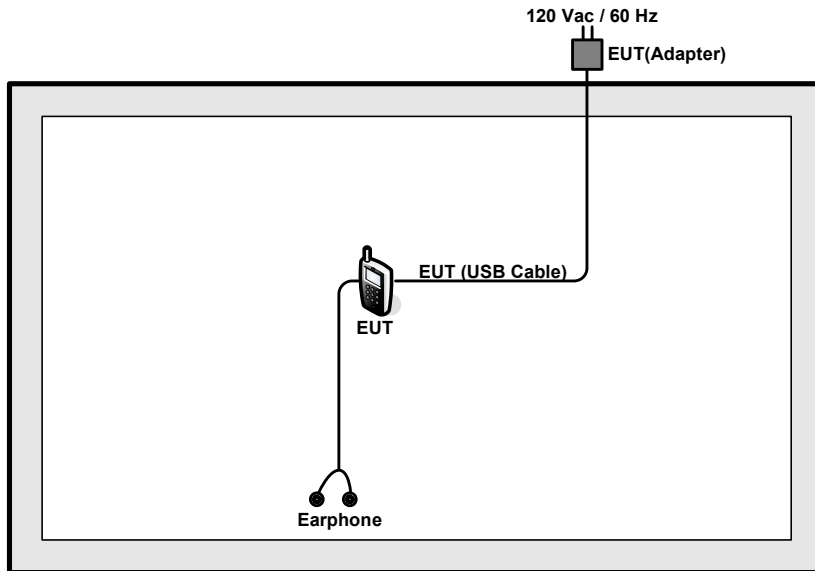

<AC Conducted Emission Mode>

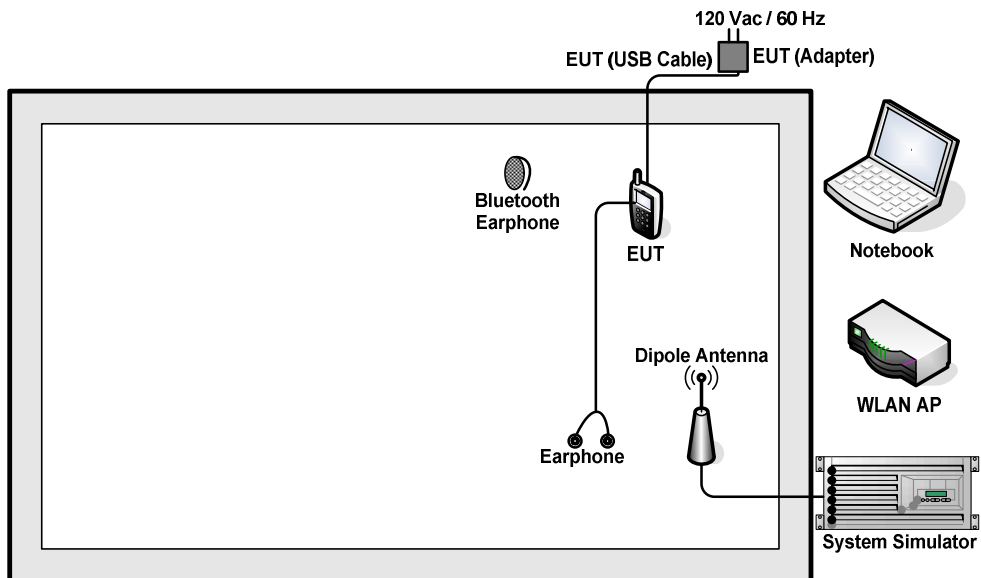



2.4 Support Unit used in test configuration and system

Item	Equipment	Trade Name	Model Name	FCC ID	Data Cable	Power Cord
1.	WLAN AP	D-Link	DIR-820L	KA2IR820LA1	N/A	Unshielded, 1.8 m
2.	System Simulator	R&S	CMU 200	N/A	N/A	Unshielded, 1.8 m
3.	Notebook	Lenovo	E450	FCC DoC	N/A	AC I/P: Unshielded, 1.2 m DC O/P: Shielded, 1.8 m
4.	Bluetooth Earphone	Nokia	BH-108	PYAHS-107W	N/A	N/A
5.	iPod Earphone	Apple	MC690ZP/A	N/A	Unshielded, 1.6m	N/A
6.	Earphone	Apple	MC690ZP/A	N/A	Shielded, 1.0m	N/A

2.5 EUT Operation Test Setup

For WLAN function, the engineering test program was provided and enabled to make EUT continuous transmit/receive.

For AC power line conducted emissions, the EUT was set to connect with the Notebook under large package sizes transmission.

2.6 Measurement Results Explanation Example

For all conducted test items:

The offset level is set in the spectrum analyzer to compensate the RF cable loss and attenuator factor between EUT conducted output port and spectrum analyzer. With the offset compensation, the spectrum analyzer reading level is exactly the EUT RF output level.

Example:

The spectrum analyzer offset is derived from RF cable loss and attenuator factor.

Offset = RF cable loss + attenuator factor.

Following shows an offset computation example with cable loss 5.0 dB and 10dB attenuator.

$$\begin{aligned} \text{Offset(dB)} &= \text{RF cable loss(dB)} + \text{attenuator factor(dB)}. \\ &= 5.0 + 10 = 15.0 \text{ (dB)} \end{aligned}$$

3 Test Result

3.1 6dB and 99% Bandwidth Measurement

3.1.1 Limit of 6dB and 99% Bandwidth

The minimum 6 dB bandwidth shall be at least 500 kHz.

3.1.2 Measuring Instruments

The measuring equipment is listed in the section 4 of this test report.

3.1.3 Test Procedures

1. The testing follows FCC KDB Publication No. 558074 DTS D01 Meas. Guidance v04.
2. The RF output of EUT was connected to the spectrum analyzer by RF cable and attenuator. The path loss was compensated to the results for each measurement.
3. Set to the maximum power setting and enable the EUT transmit continuously.
4. Make the measurement with the spectrum analyzer's resolution bandwidth (RBW) = 100 kHz. Set the Video bandwidth (VBW) = 300 kHz. In order to make an accurate measurement. The 6 dB bandwidth must be greater than 500 kHz.
5. For 99% Bandwidth Measurement, the spectrum analyzer's resolution bandwidth (RBW) = 1MHz and set the Video bandwidth (VBW) = 3MHz.
6. Measure and record the results in the test report.

3.1.4 Test Setup

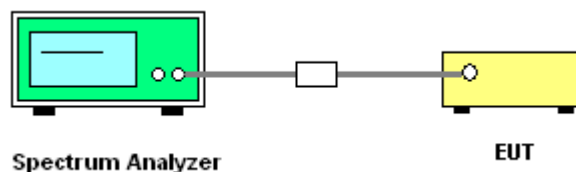



3.1.5 Test Result of 6dB and 99% Occupied Bandwidth

Please refer to Appendix A.

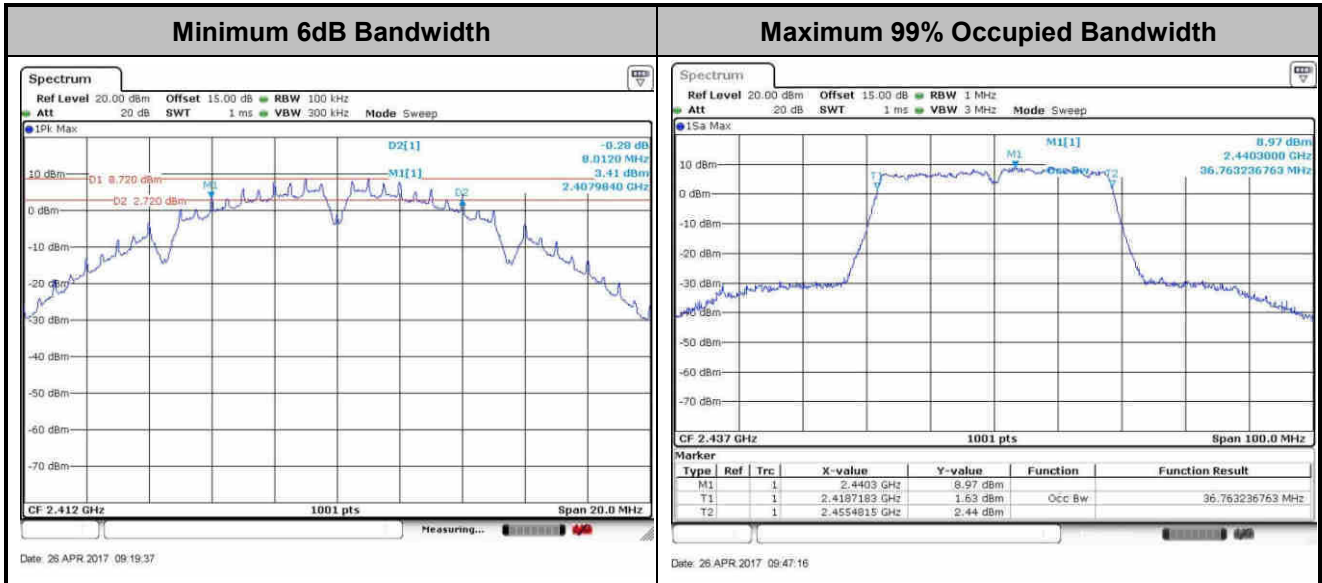

Note : The occupied channel bandwidth is maintained within the band of operation for all of the modulations.

3.2 Peak and Average Output Power Measurement

3.2.1 Limit of Peak and Average Output Power

For systems using digital modulation in the 2400-2483.5MHz, the limit for peak output power is 30dBm. If transmitting antenna of directional gain greater than 6dBi are used the peak output power from the intentional radiator shall be reduced below the above stated value by the amount in dB that the directional gain of the antenna exceeds 6 dBi. In case of point-to-point operation, the limit has to be reduced by 1dB for every 3dB that the directional gain of the antenna exceeds 6dBi.

3.2.2 Measuring Instruments

The measuring equipment is listed in the section 4 of this test report.

3.2.3 Test Procedures

1. The testing follows the Measurement Procedure of FCC KDB No. 558074 DTS D01 Meas. Guidance v04 section 9.1.2 PKPM1 Peak power meter method.
2. The RF output of EUT was connected to the power meter by RF cable and attenuator. The path loss was compensated to the results for each measurement.
3. Set to the maximum power setting and enable the EUT transmit continuously.
4. Measure the conducted output power and record the results in the test report.
5. For MIMO mode, calculation method follows FCC KDB 662911 D01 Multiple Transmitter Output v02r01.

3.2.4 Test Setup

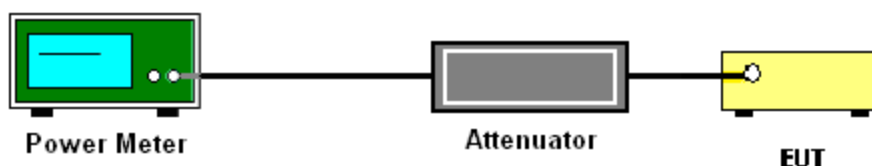



3.2.5 Test Result of Peak Output Power

Please refer to Appendix A.

3.2.6 Test Result of Average output Power (Reporting Only)

Please refer to Appendix A.



3.3 Power Spectral Density Measurement

3.3.1 Limit of Power Spectral Density

The peak power spectral density shall not be greater than 8dBm in any 3kHz band at any time interval of continuous transmission.

3.3.2 Measuring Instruments

The measuring equipment is listed in the section 4 of this test report.

3.3.3 Test Procedures

1. The testing follows Measurement Procedure 10.2 Method PKPSD of FCC KDB Publication No. 558074 D01 DTS Meas. Guidance v04
2. The RF output of EUT was connected to the spectrum analyzer by RF cable and attenuator. The path loss was compensated to the results for each measurement.
3. Set to the maximum power setting and enable the EUT transmit continuously.
4. Make the measurement with the spectrum analyzer's resolution bandwidth (RBW) = 3 kHz. Video bandwidth VBW = 10 kHz In order to make an accurate measurement, set the span to 1.5 times DTS Channel Bandwidth. (6dB BW)
5. Detector = peak, Sweep time = auto couple, Trace mode = max hold, Allow trace to fully stabilize. Use the peak marker function to determine the maximum power level.
6. Measure and record the results in the test report.
7. For MIMO mode, calculation method follows FCC KDB 662911 D01 Multiple Transmitter Output v02r01.

If measurements performed using method (2) plus $10 \log(N)$ exceeds the emission limit, the test should choose method (1) before declaring that the device fails the emission limit.

Method (1): Measure and sum the spectra across the outputs.

The total final Power Spectral Density is from a device with 2 transmitter outputs. The spectrum measurements of the individual outputs are all performed with the same span and number of points, the spectrum value in the first spectral bin of output 1 is summed with that in the first spectral bin of output 2 to obtain the value for the first frequency bin of the summed spectrum.

Method (2): Measure and add $10 \log(N)$ dB, where N is the number of outputs. (N=2)

3.3.4 Test Setup

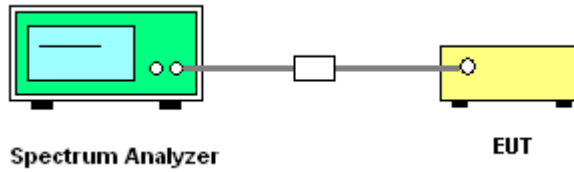

3.3.5 Test Result of Power Spectral Density

Please refer to Appendix A.

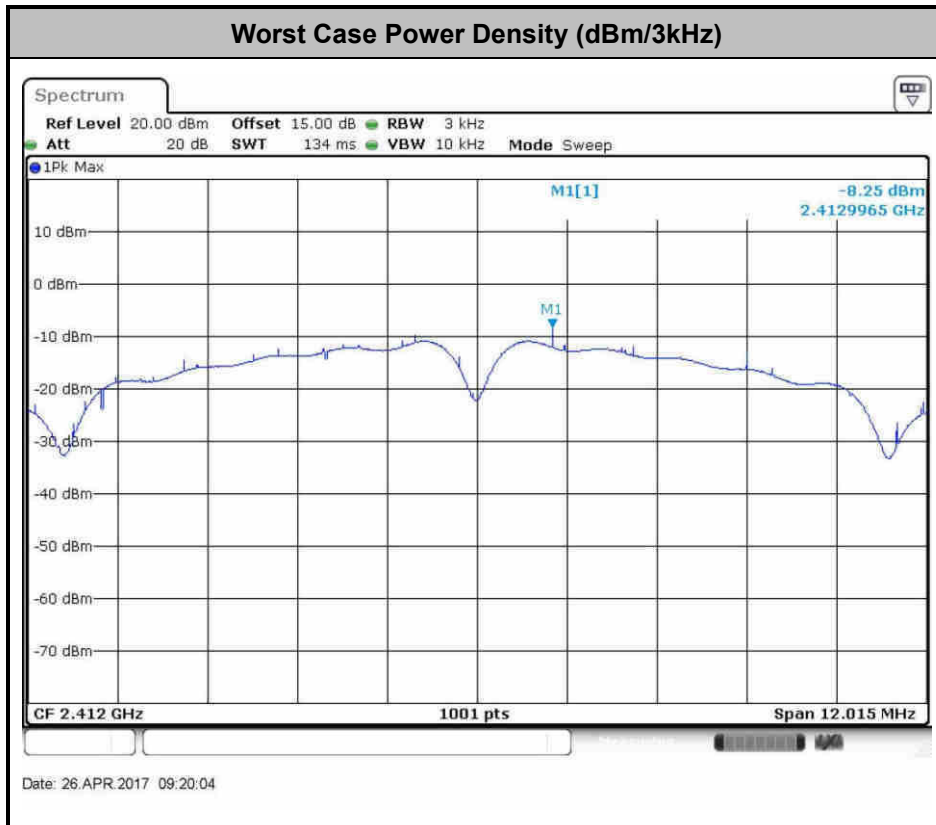

3.4 Conducted Band Edges and Spurious Emission Measurement

3.4.1 Limit of Conducted Band Edges and Spurious Emission Measurement

In any 100 kHz bandwidth outside of the authorized frequency band, the emissions which fall in the non-restricted bands shall be attenuated at least 20 dB / 30dB relative to the maximum PSD level in 100 kHz by RF conducted measurement.

3.4.2 Measuring Instruments

The measuring equipment is listed in the section 4 of this test report.

3.4.3 Test Procedures

1. The testing follows FCC KDB Publication No. 558074 D01 DTS Meas. Guidance v04.
2. The RF output of EUT was connected to the spectrum analyzer by RF cable and attenuator. The path loss was compensated to the results for each measurement.
3. Set to the maximum power setting and enable the EUT transmit continuously.
4. Set RBW = 100 kHz, VBW=300 kHz, Peak Detector. Unwanted Emissions measured in any 100 kHz bandwidth outside of the authorized frequency band shall be attenuated by at least 20 dB relative to the maximum in-band peak PSD level in 100 kHz when maximum peak conducted output power procedure is used. If the transmitter complies with the conducted power limits based on the use of RMS averaging over a time interval, the attenuation required under this paragraph shall be 30 dB instead of 20 dB.
5. Measure and record the results in the test report.
6. The RF fundamental frequency should be excluded against the limit line in the operating frequency band.

3.4.4 Test Setup

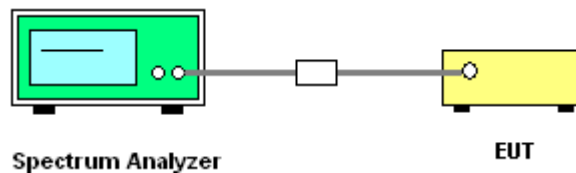



3.4.5 Test Result of Conducted Band Edges and Spurious Emission

Number of TX = 1, Ant. 1 (Measured)

Number of TX	1	Ant. :	1
Test Mode :	802.11b	Temperature :	24~26°C
Test Band :	2.4GHz Low	Relative Humidity :	50~53%
Test Channel :	01	Test Engineer :	Sam Zheng

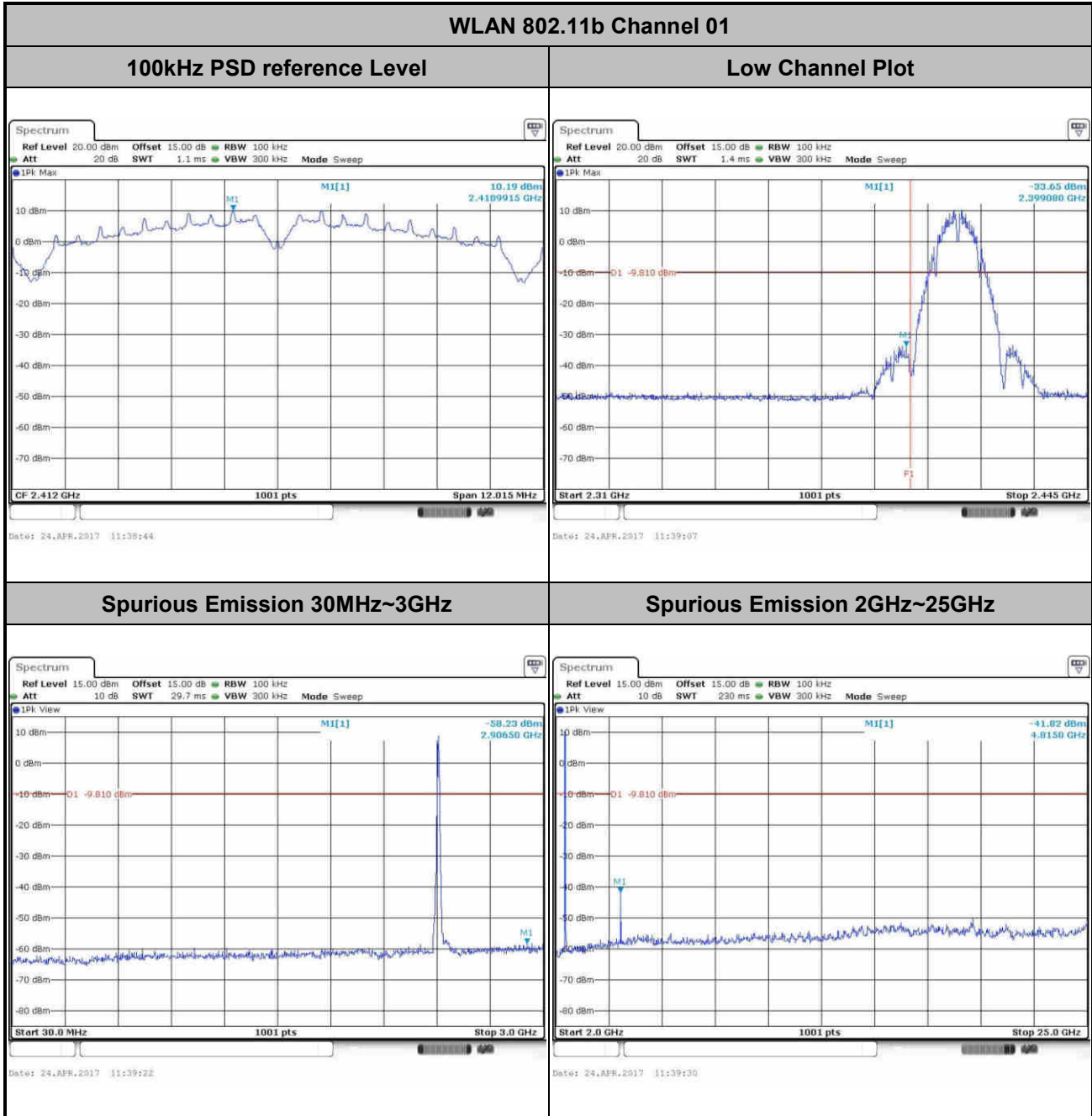



Number of TX :	1	Ant. :	1
Test Mode :	802.11b	Temperature :	24~26°C
Test Band :	2.4GHz Mid	Relative Humidity :	50~53%
Test Channel :	06	Test Engineer :	Sam Zheng

WLAN 802.11b Channel 06

100kHz PSD reference Level

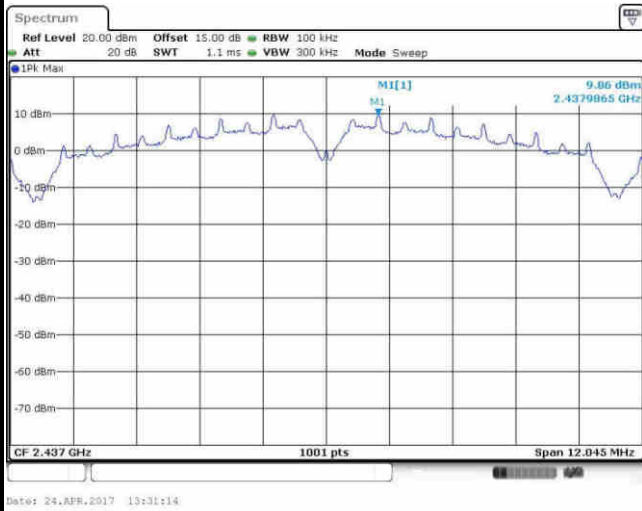

Spurious Emission 30MHz~3GHz

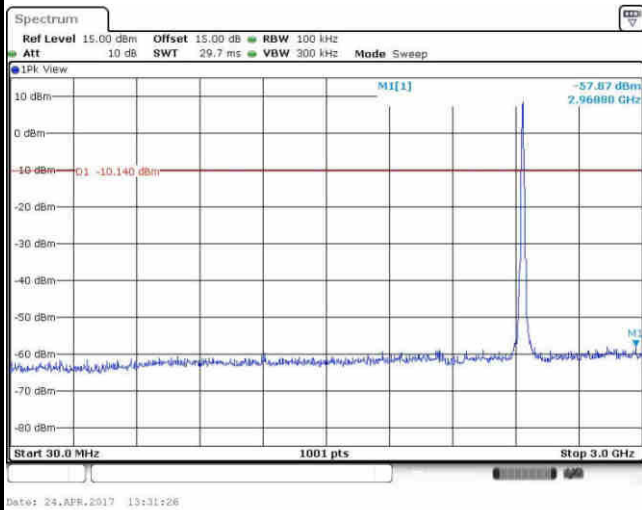

Spurious Emission 2GHz~25GHz

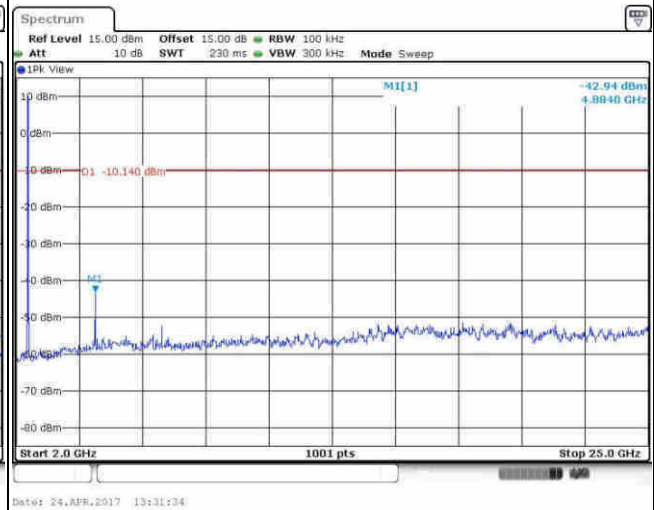



Number of TX :	1	Ant. :	1
Test Mode :	802.11b	Temperature :	24~26°C
Test Band :	2.4GHz High	Relative Humidity :	50~53%
Test Channel :	11	Test Engineer :	Sam Zheng

WLAN 802.11b Channel 11

100kHz PSD reference Level

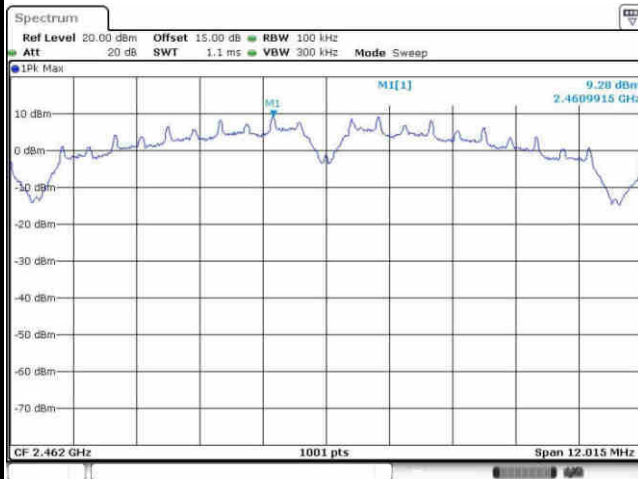

High Channel Plot

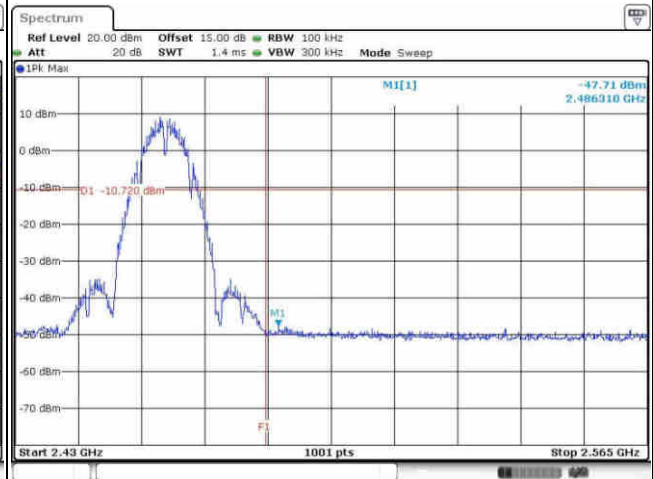

Spurious Emission 30MHz~3GHz

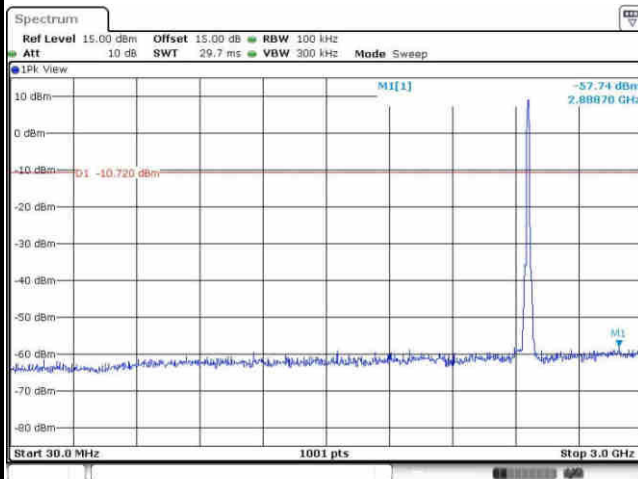

Spurious Emission 2GHz~25GHz

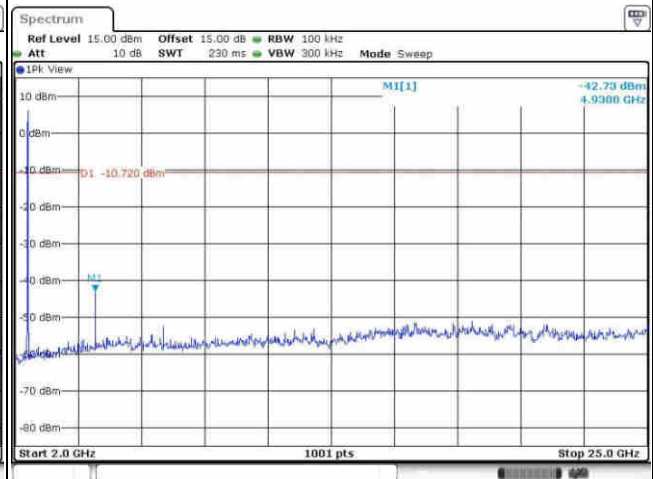



Number of TX :	1	Ant. :	1
Test Mode :	802.11g	Temperature :	24~26°C
Test Band :	2.4GHz Low	Relative Humidity :	50~53%
Test Channel :	01	Test Engineer :	Sam Zheng

WLAN 802.11g Channel 01

100kHz PSD reference Level

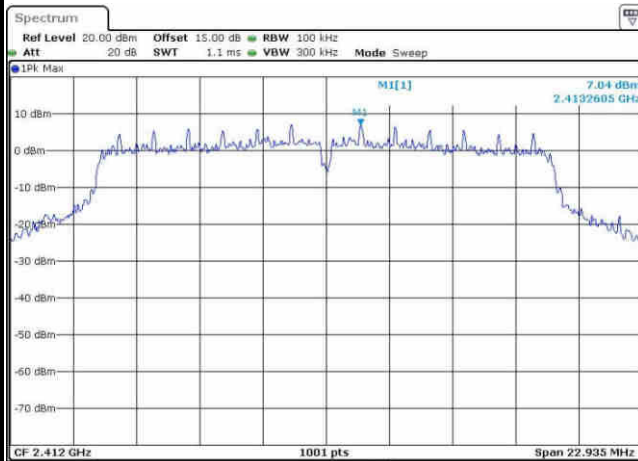

Date: 24.APR.2017 14:04:22

Low Channel Plot

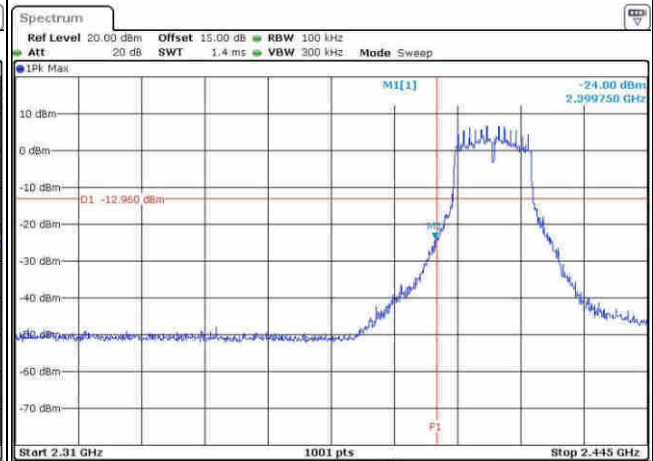

Date: 24.APR.2017 14:05:16

Spurious Emission 30MHz~3GHz

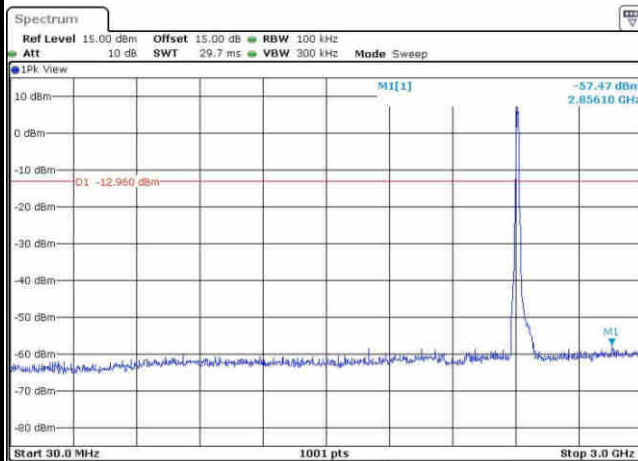

Date: 24.APR.2017 14:06:36

Spurious Emission 2GHz~25GHz

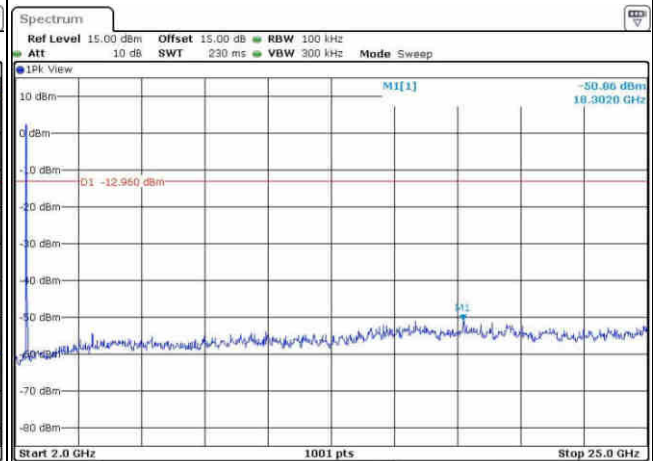

Date: 24.APR.2017 14:06:45



Number of TX :	1	Ant. :	1
Test Mode :	802.11g	Temperature :	24~26°C
Test Band :	2.4GHz Mid	Relative Humidity :	50~53%
Test Channel :	06	Test Engineer :	Sam Zheng

WLAN 802.11g Channel 06

100kHz PSD reference Level

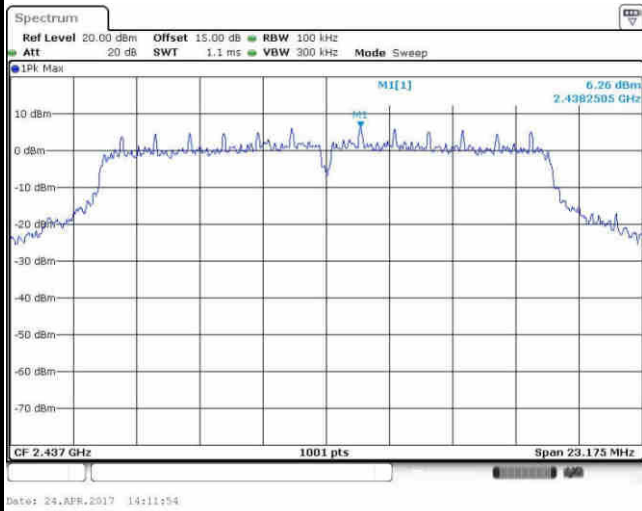

Spurious Emission 30MHz~3GHz

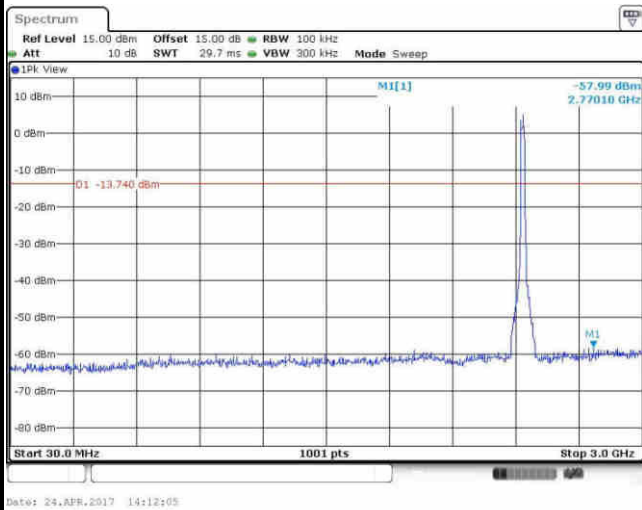

Spurious Emission 2GHz~25GHz

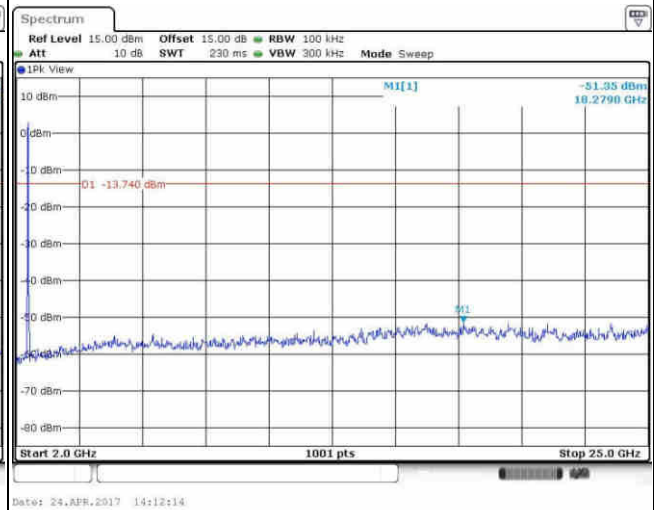



Number of TX :	1	Ant. :	1
Test Mode :	802.11g	Temperature :	24~26°C
Test Band :	2.4GHz High	Relative Humidity :	50~53%
Test Channel :	11	Test Engineer :	Sam Zheng

WLAN 802.11g Channel 11

100kHz PSD reference Level

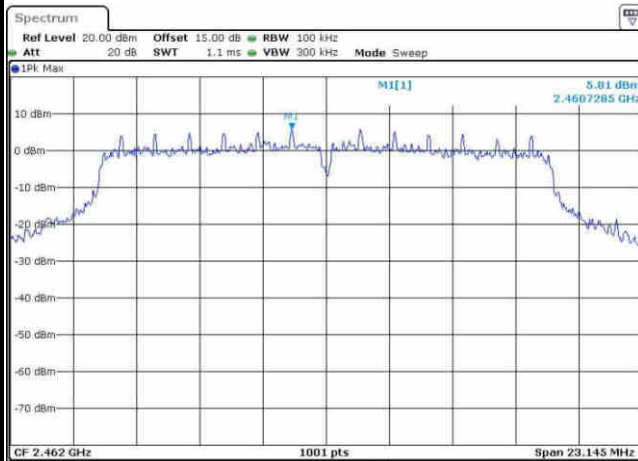

Date: 24.APR.2017 14:20:15

High Channel Plot

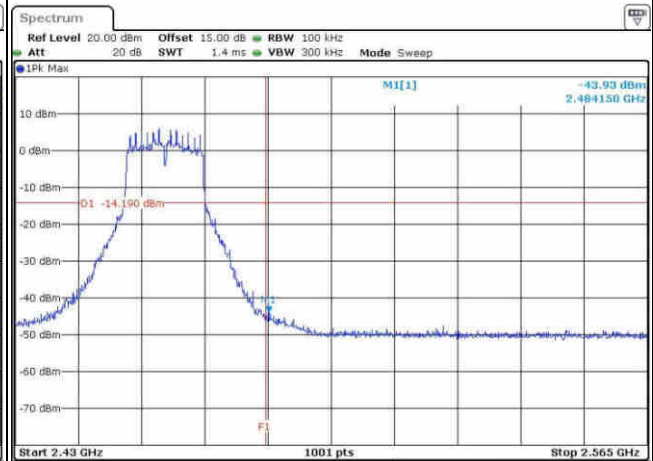

Date: 24.APR.2017 14:21:01

Spurious Emission 30MHz~3GHz

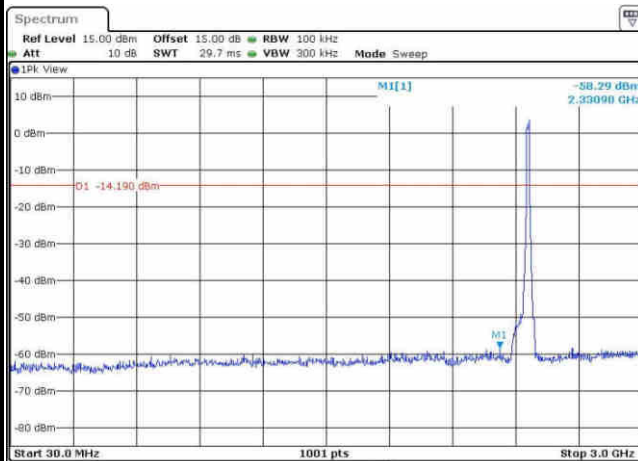

Date: 24.APR.2017 14:21:18

Spurious Emission 2GHz~25GHz

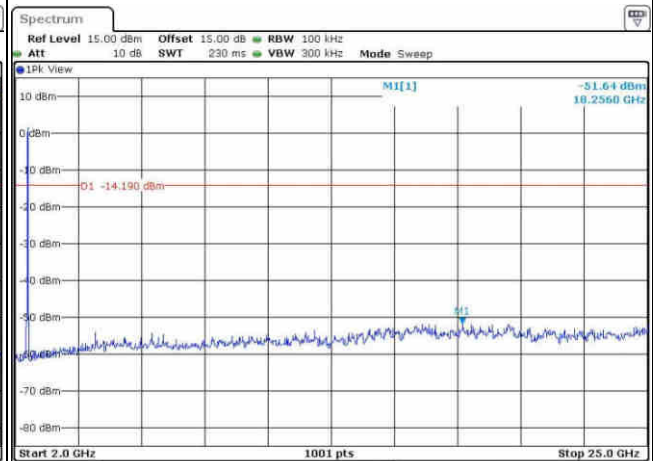

Date: 24.APR.2017 14:21:28



Number of TX :	1	Ant. :	1
Test Mode :	802.11n HT20	Temperature :	24~26°C
Test Band :	2.4GHz Low	Relative Humidity :	50~53%
Test Channel :	01	Test Engineer :	Sam Zheng

WLAN 802.11n HT20 Channel 01

100kHz PSD reference Level

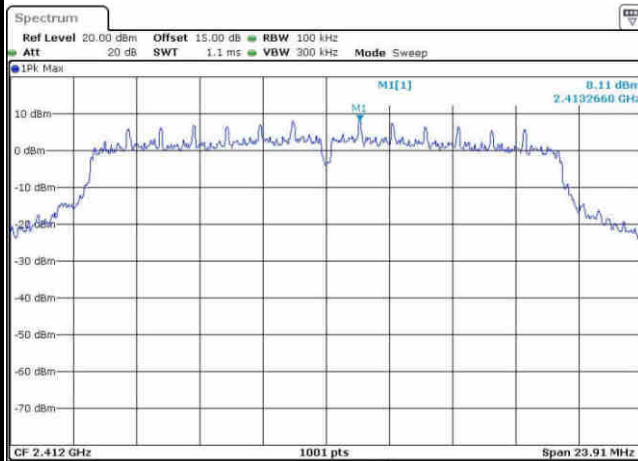

Date: 24.APR.2017 15:27:53

Low Channel Plot

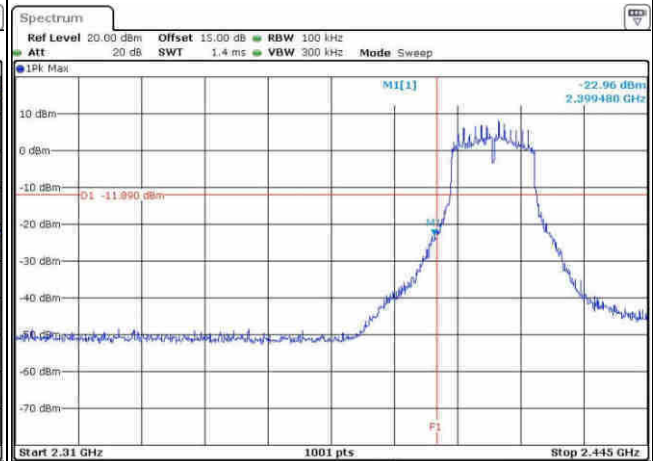

Date: 24.APR.2017 15:29:02

Spurious Emission 30MHz~3GHz

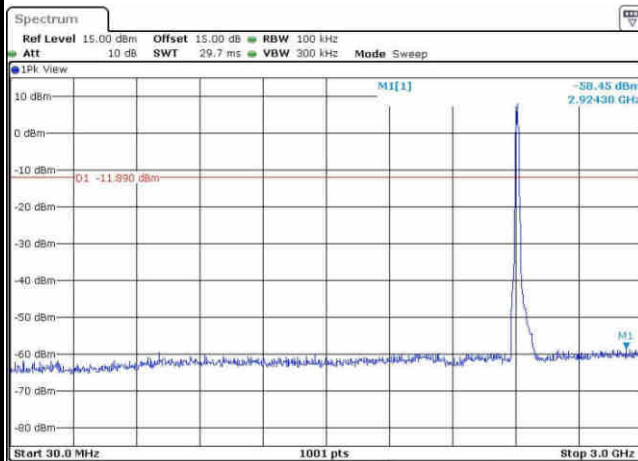

Date: 24.APR.2017 15:29:13

Spurious Emission 2GHz~25GHz

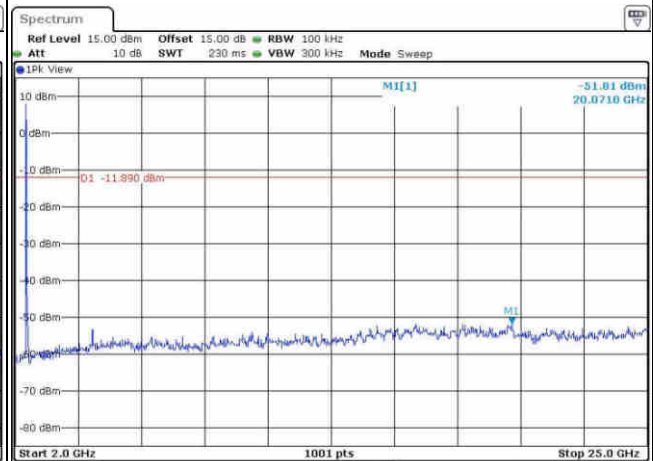

Date: 24.APR.2017 15:29:22



Number of TX :	1	Ant. :	1
Test Mode :	802.11n HT20	Temperature :	24~26°C
Test Band :	2.4GHz Mid	Relative Humidity :	50~53%
Test Channel :	06	Test Engineer :	Sam Zheng

WLAN 802.11n HT20 Channel 06

100kHz PSD reference Level

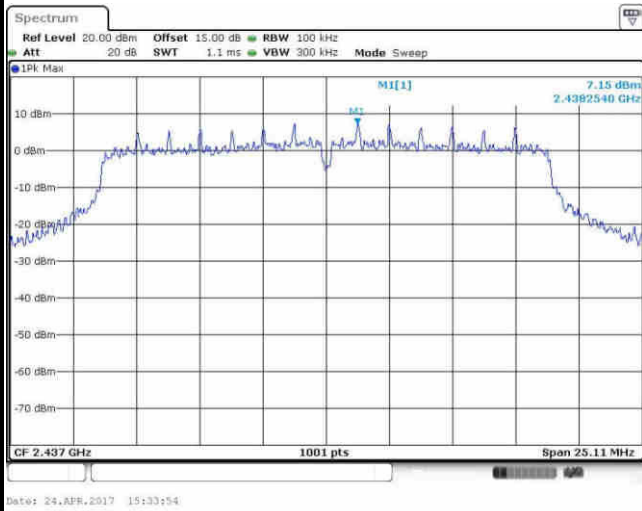

Spurious Emission 30MHz~3GHz

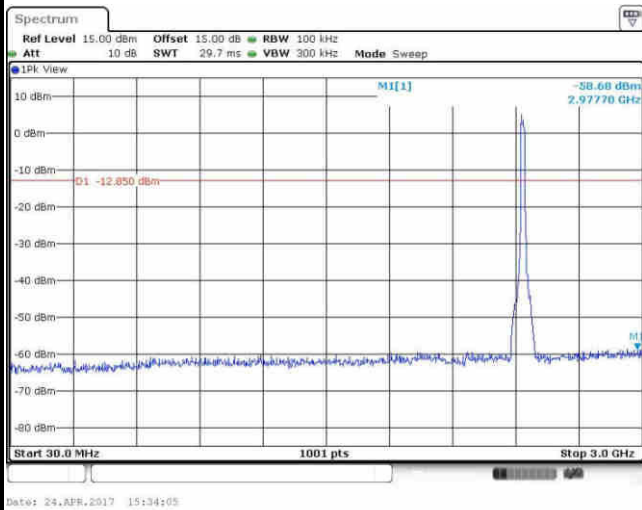

Spurious Emission 2GHz~25GHz

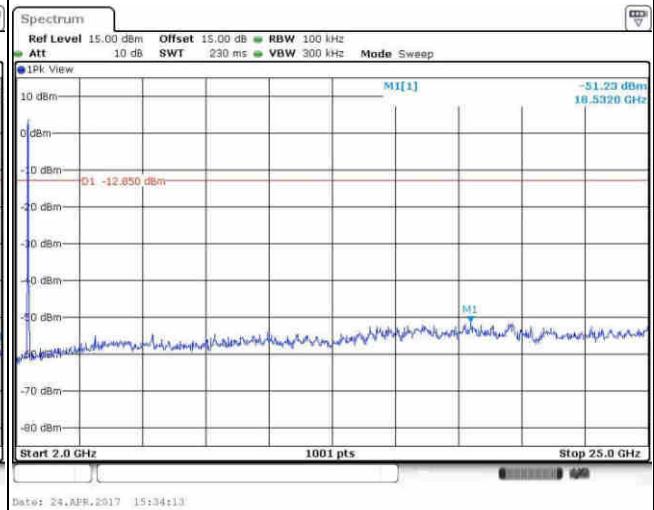



Number of TX :	1	Ant. :	1
Test Mode :	802.11n HT20	Temperature :	24~26°C
Test Band :	2.4GHz High	Relative Humidity :	50~53%
Test Channel :	11	Test Engineer :	Sam Zheng

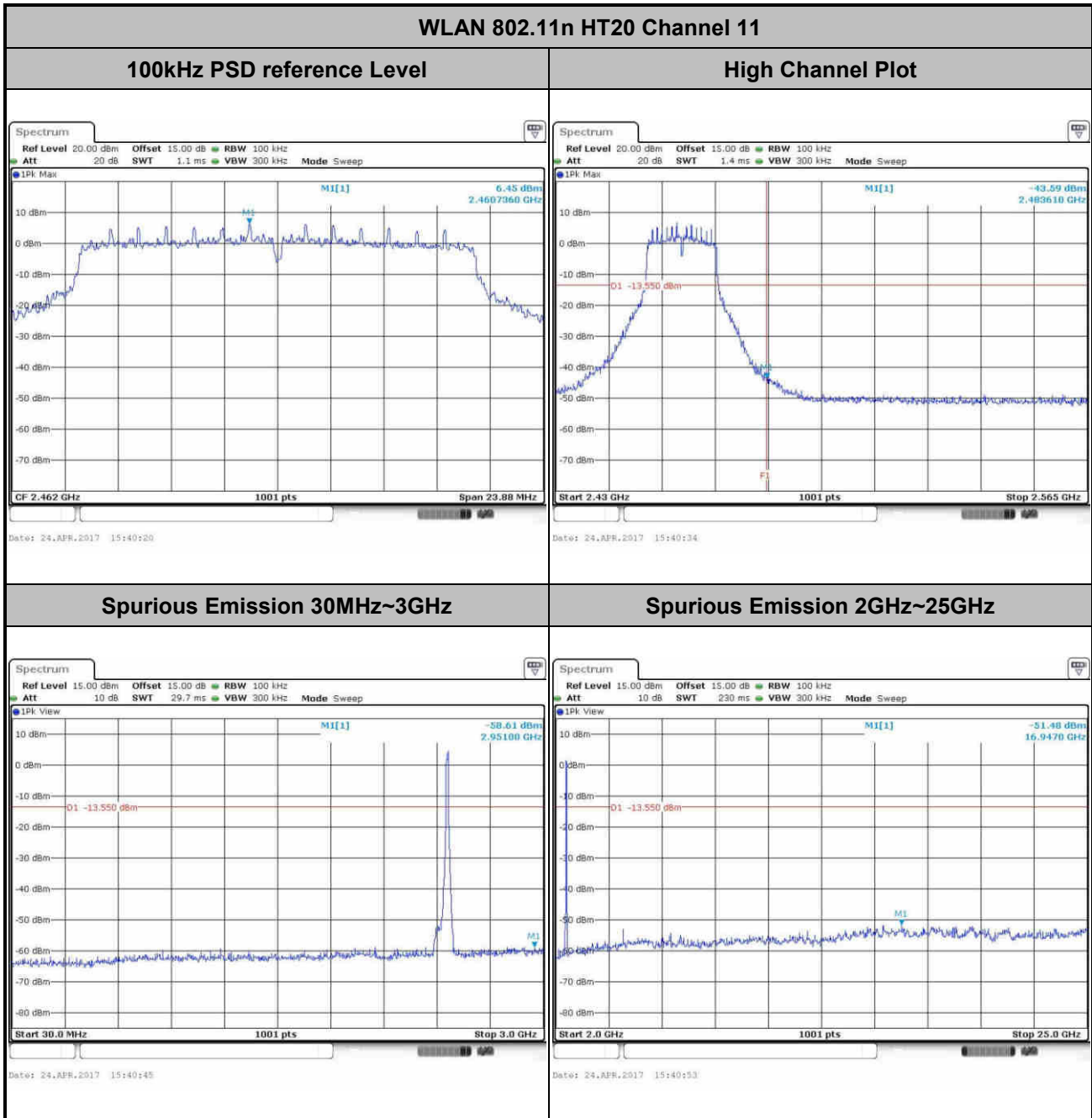



Number of TX :	1	Ant. :	1
Test Mode :	802.11n HT40	Temperature :	24~26°C
Test Band :	2.4GHz Low	Relative Humidity :	50~53%
Test Channel :	03	Test Engineer :	Sam Zheng

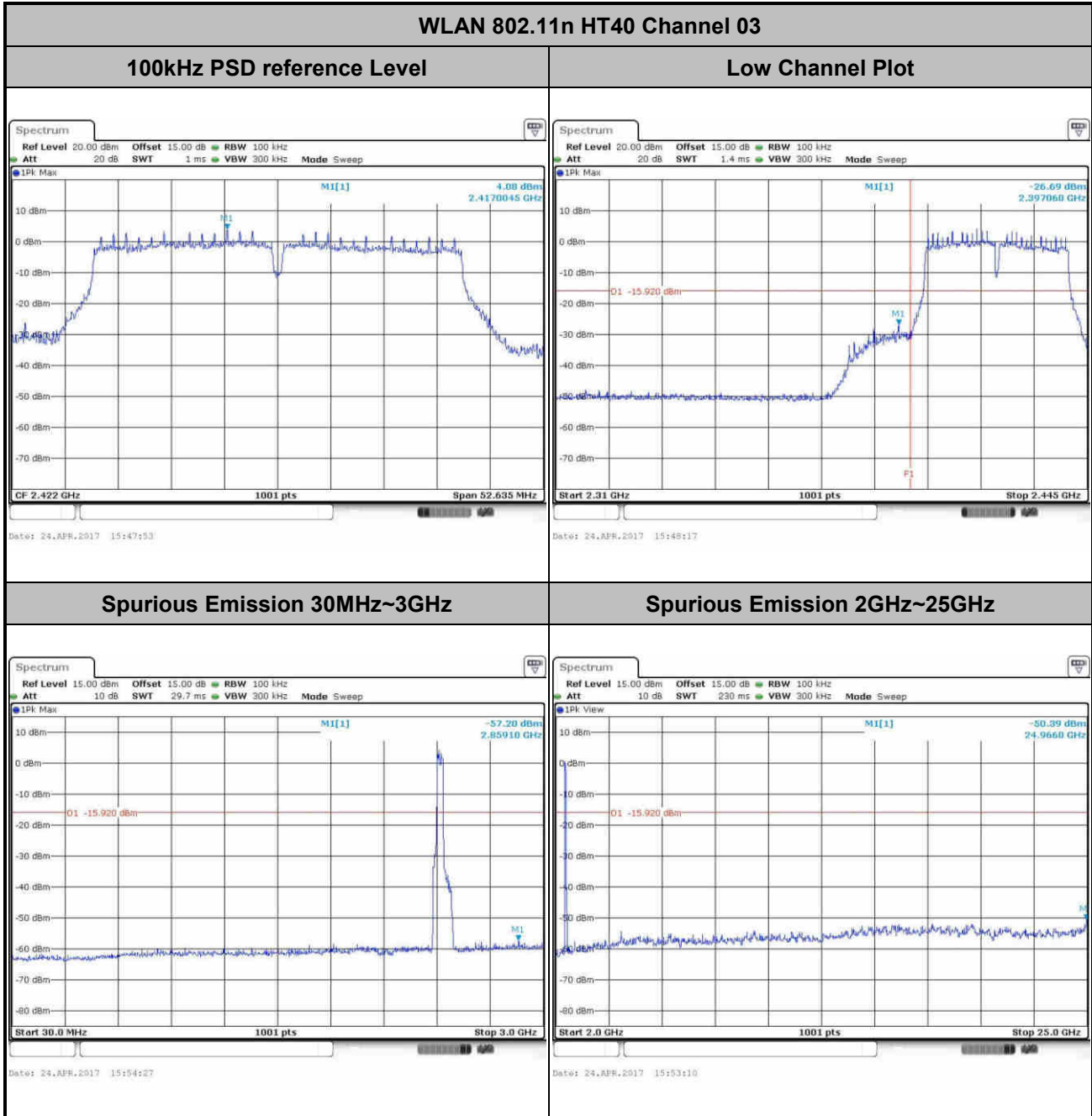



Number of TX :	1	Ant. :	1
Test Mode :	802.11n HT40	Temperature :	24~26°C
Test Band :	2.4GHz Mid	Relative Humidity :	50~53%
Test Channel :	06	Test Engineer :	Sam Zheng

WLAN 802.11n HT40 Channel 06

100kHz PSD reference Level

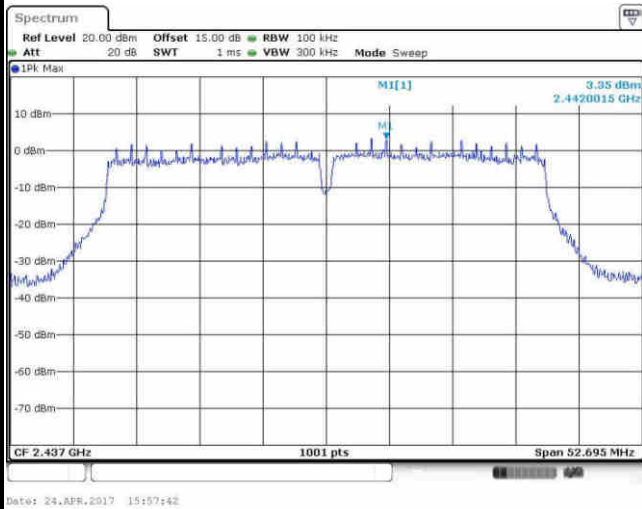

Spurious Emission 30MHz~3GHz

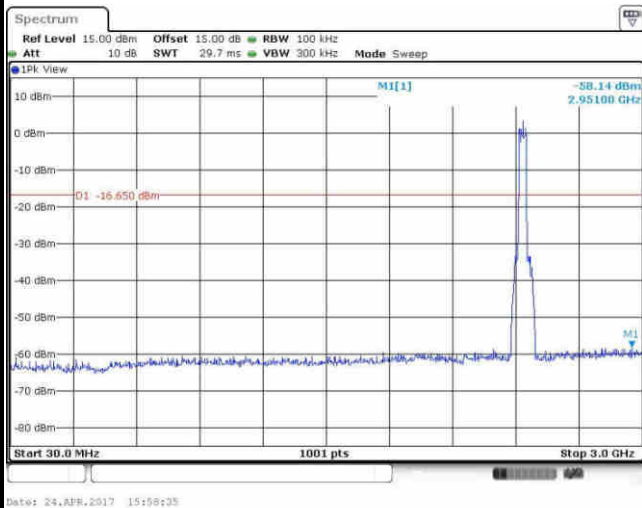

Spurious Emission 2GHz~25GHz

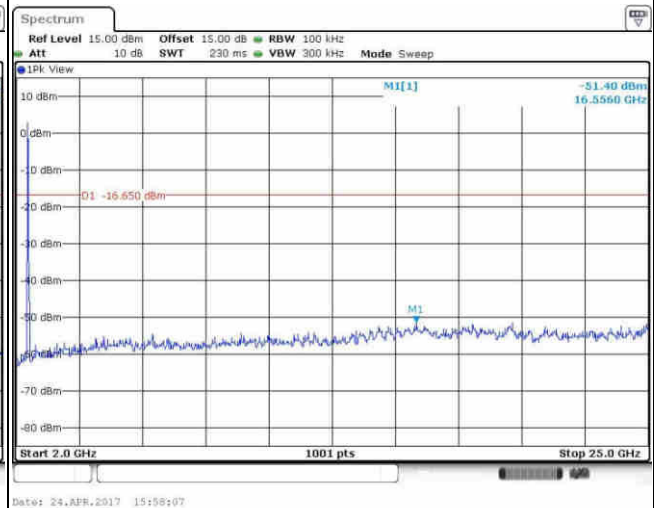



Number of TX :	1	Ant. :	1
Test Mode :	802.11n HT40	Temperature :	24~26°C
Test Band :	2.4GHz High	Relative Humidity :	50~53%
Test Channel :	09	Test Engineer :	Sam Zheng

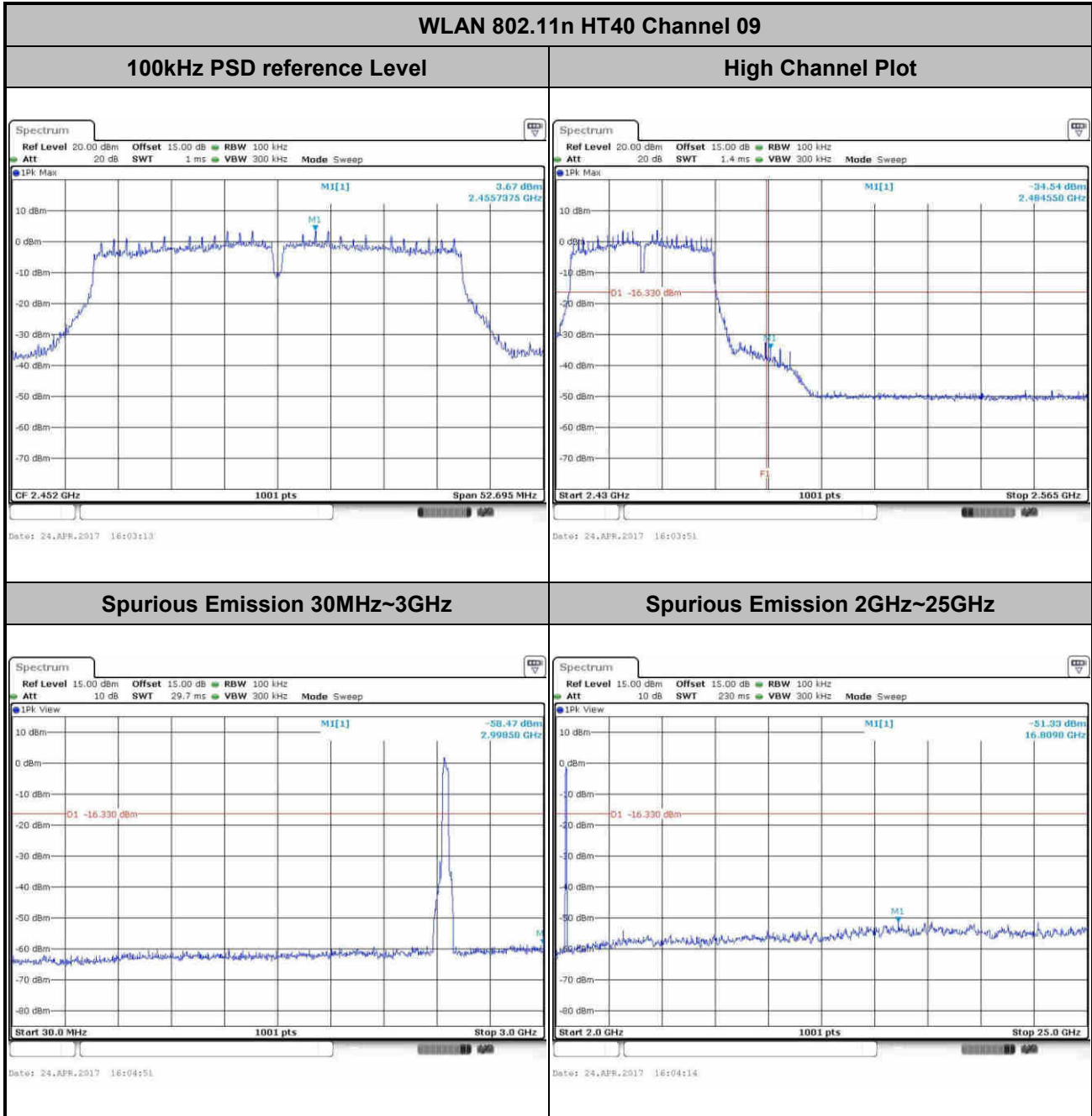



Number of TX = 1, Ant. 2 (Measured)

Number of TX	1	Ant. :	2
Test Mode :	802.11b	Temperature :	24~26°C
Test Band :	2.4GHz Low	Relative Humidity :	50~53%
Test Channel :	01	Test Engineer :	Sam Zheng

WLAN 802.11b Channel 01

100kHz PSD reference Level

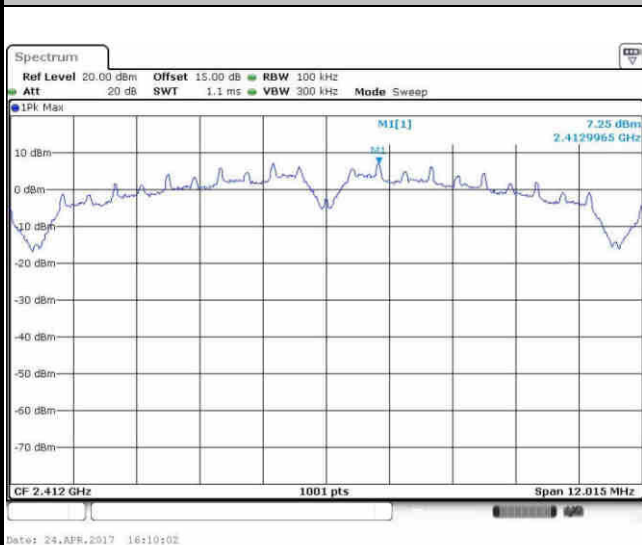

Low Channel Plot

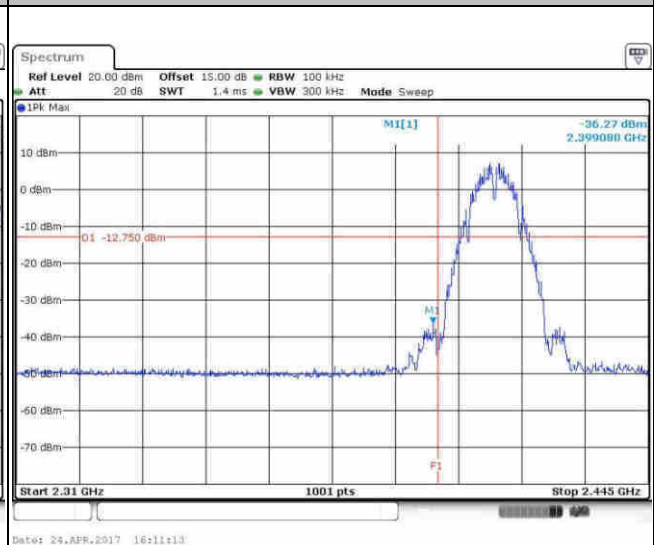

Spurious Emission 30MHz~3GHz

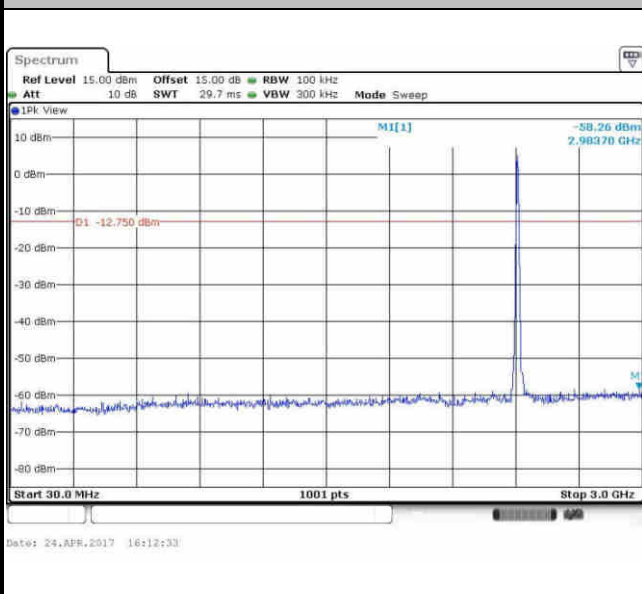

Spurious Emission 2GHz~25GHz

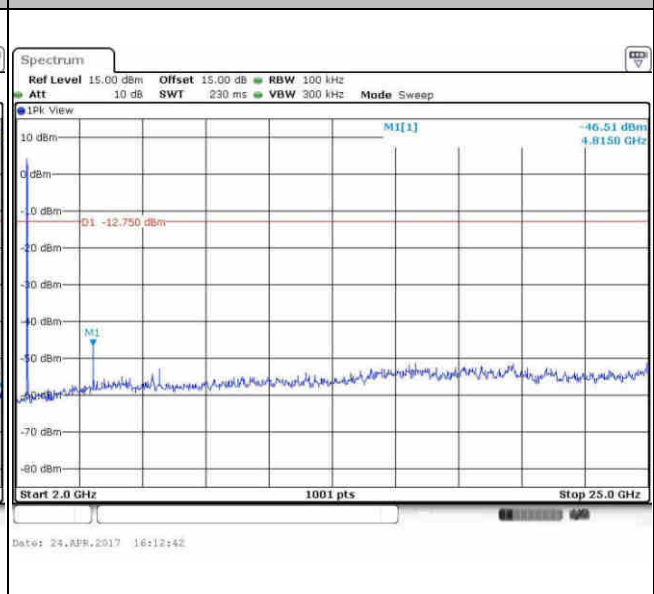



Number of TX :	1	Ant. :	2
Test Mode :	802.11b	Temperature :	24~26°C
Test Band :	2.4GHz Mid	Relative Humidity :	50~53%
Test Channel :	06	Test Engineer :	Sam Zheng

WLAN 802.11b Channel 06

100kHz PSD reference Level

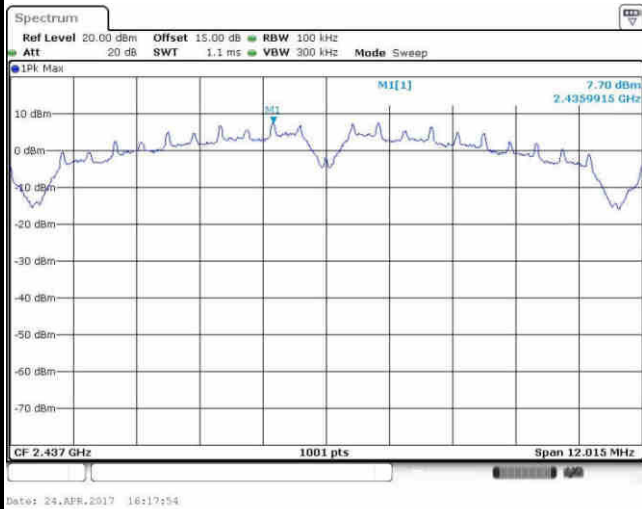

Spurious Emission 30MHz~3GHz

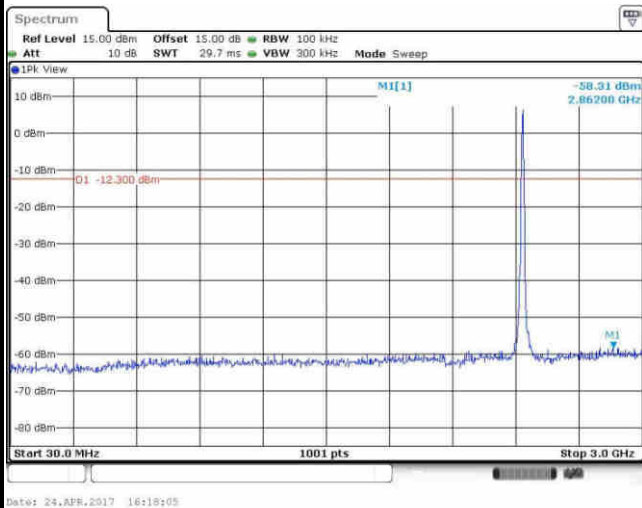

Spurious Emission 2GHz~25GHz

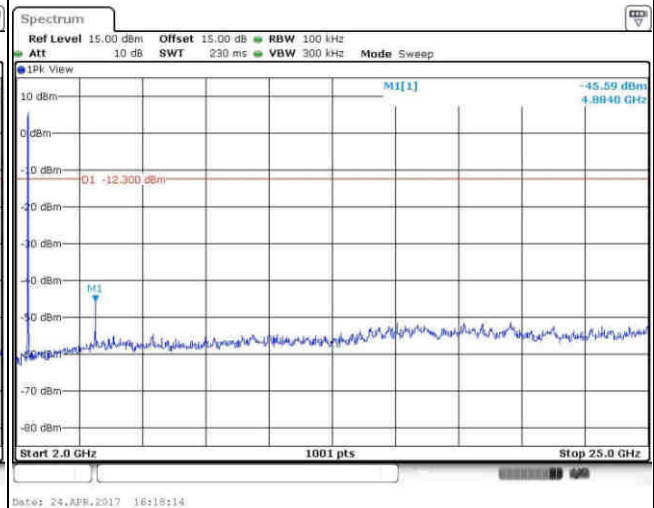



Number of TX :	1	Ant. :	2
Test Mode :	802.11b	Temperature :	24~26°C
Test Band :	2.4GHz High	Relative Humidity :	50~53%
Test Channel :	11	Test Engineer :	Sam Zheng

WLAN 802.11b Channel 11

100kHz PSD reference Level

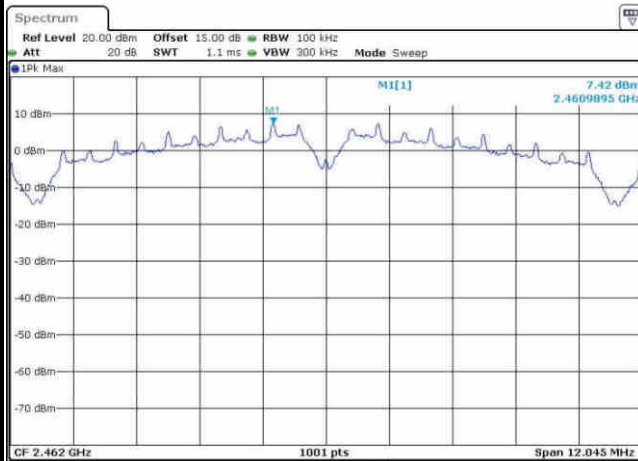

Date: 24.APR.2017 16:24:18

High Channel Plot

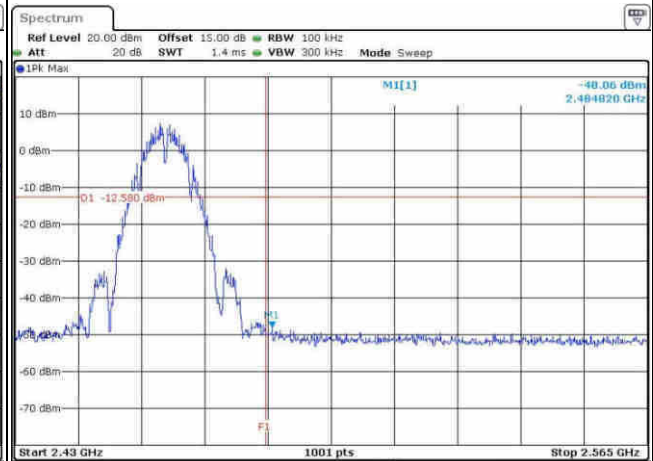

Date: 24.APR.2017 16:25:28

Spurious Emission 30MHz~3GHz

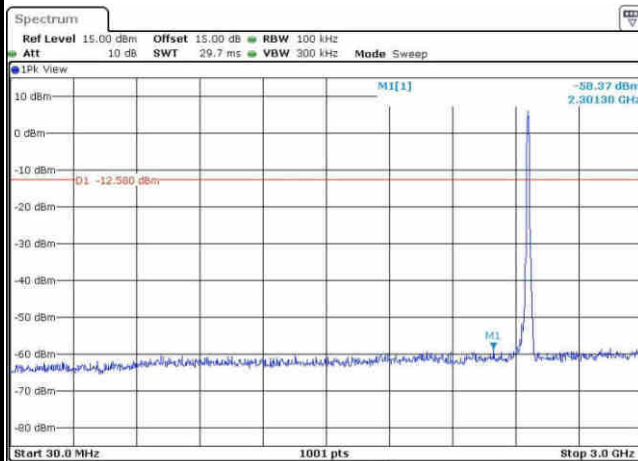

Date: 24.APR.2017 16:25:40

Spurious Emission 2GHz~25GHz

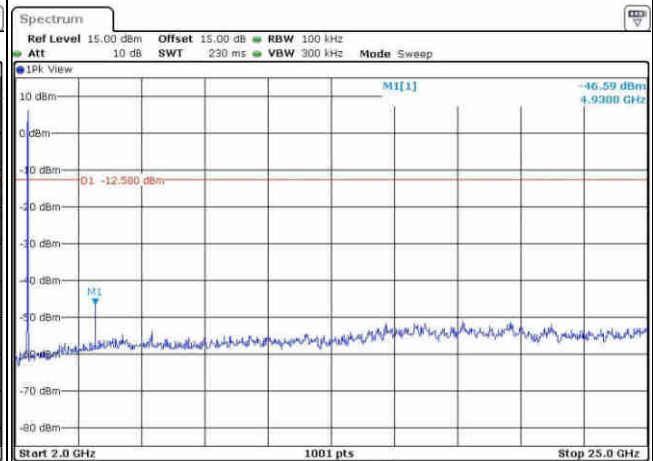

Date: 24.APR.2017 16:25:48



Number of TX :	1	Ant. :	2
Test Mode :	802.11g	Temperature :	24~26°C
Test Band :	2.4GHz Low	Relative Humidity :	50~53%
Test Channel :	01	Test Engineer :	Sam Zheng

WLAN 802.11g Channel 01

100kHz PSD reference Level

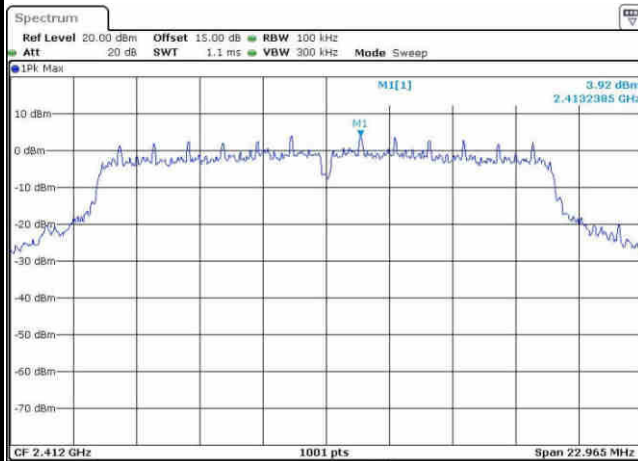

Date: 24.APR.2017 16:32:15

Low Channel Plot

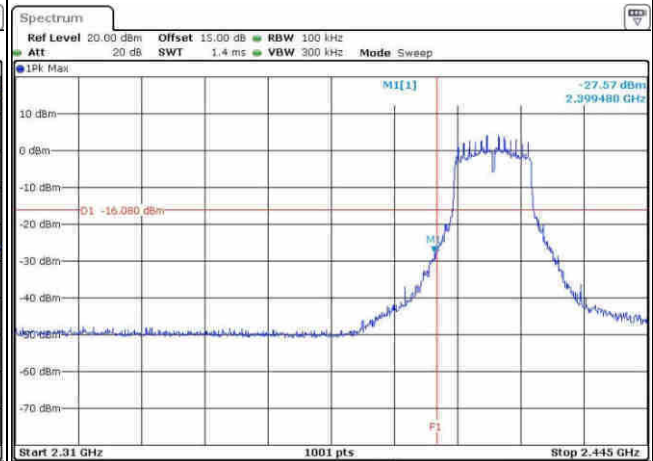

Date: 24.APR.2017 16:34:03

Spurious Emission 30MHz~3GHz

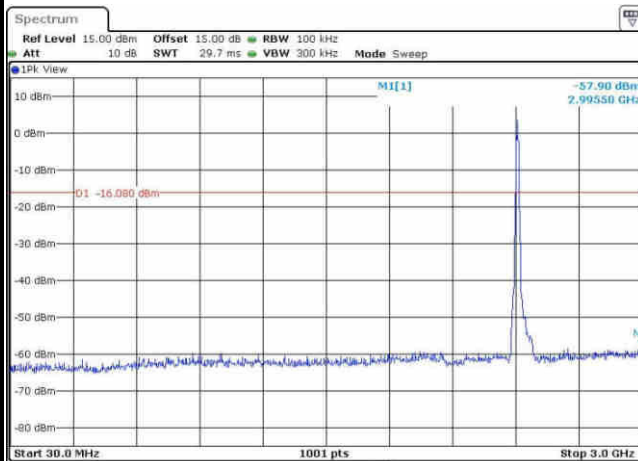

Date: 24.APR.2017 16:34:14

Spurious Emission 2GHz~25GHz

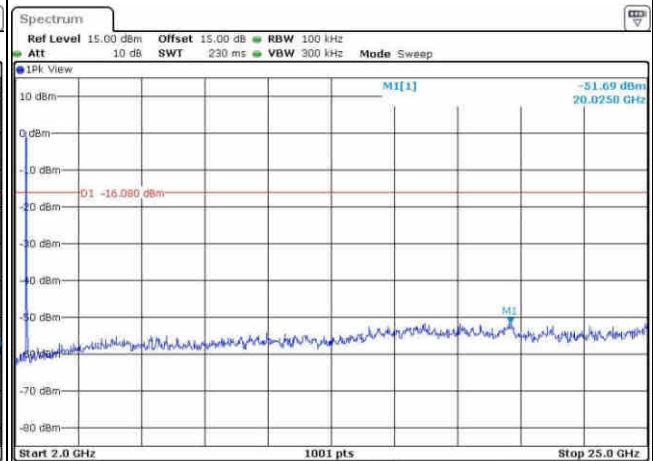

Date: 24.APR.2017 16:34:22



Number of TX :	1	Ant. :	2
Test Mode :	802.11g	Temperature :	24~26°C
Test Band :	2.4GHz Mid	Relative Humidity :	50~53%
Test Channel :	06	Test Engineer :	Sam Zheng

WLAN 802.11g Channel 06

100kHz PSD reference Level

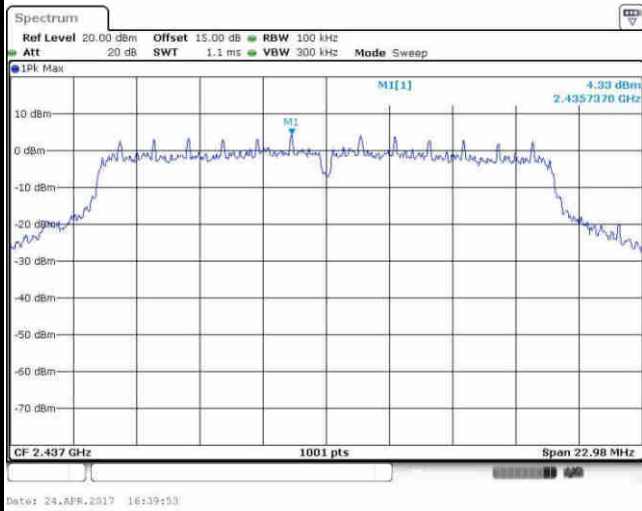

Spurious Emission 30MHz~3GHz

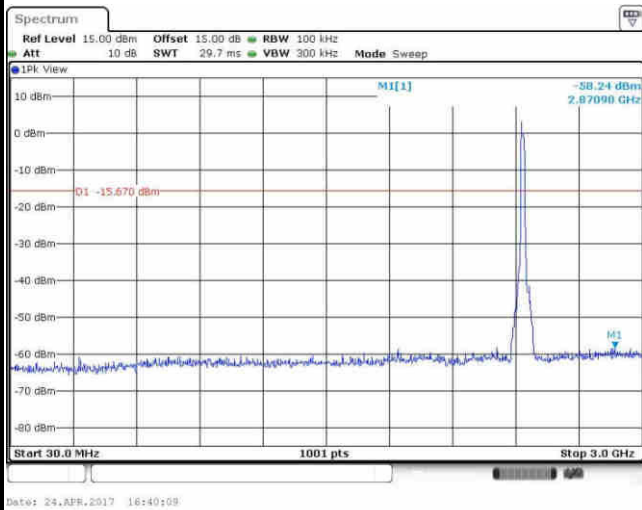

Spurious Emission 2GHz~25GHz

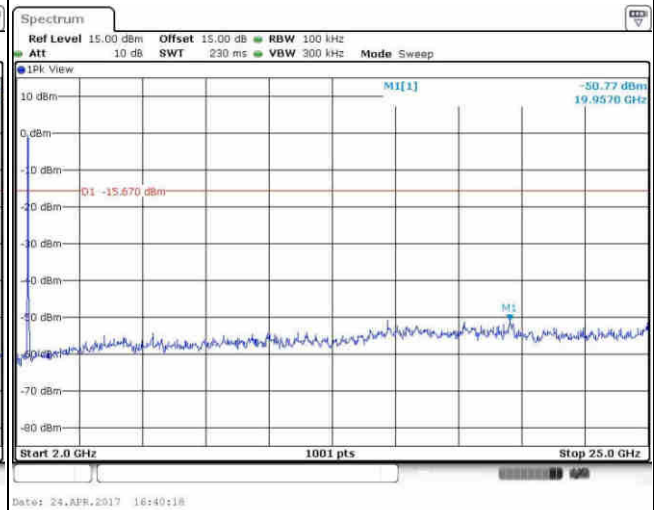



Number of TX :	1	Ant. :	2
Test Mode :	802.11g	Temperature :	24~26°C
Test Band :	2.4GHz High	Relative Humidity :	50~53%
Test Channel :	11	Test Engineer :	Sam Zheng

WLAN 802.11g Channel 11

100kHz PSD reference Level

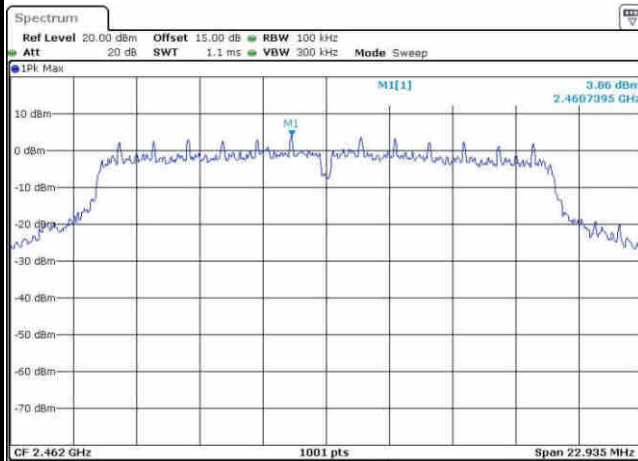

Date: 24.APR.2017 16:46:21

High Channel Plot

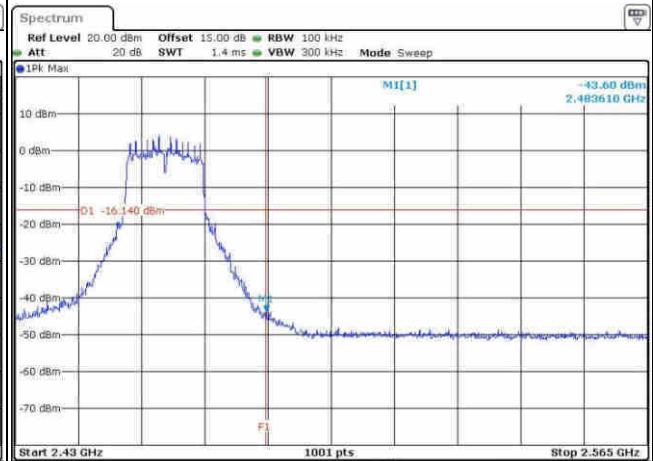

Date: 24.APR.2017 16:47:01

Spurious Emission 30MHz~3GHz

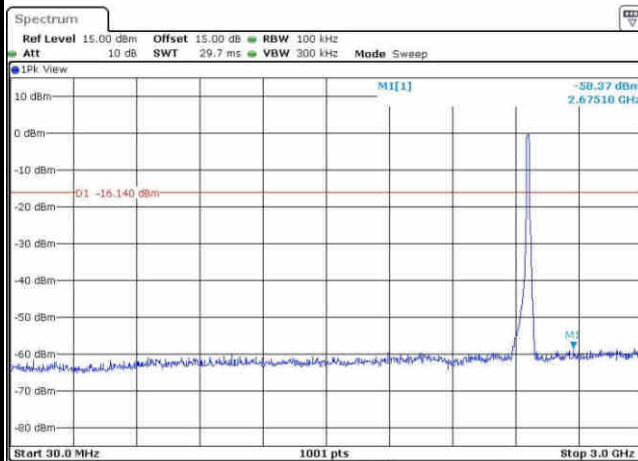

Date: 24.APR.2017 16:47:19

Spurious Emission 2GHz~25GHz

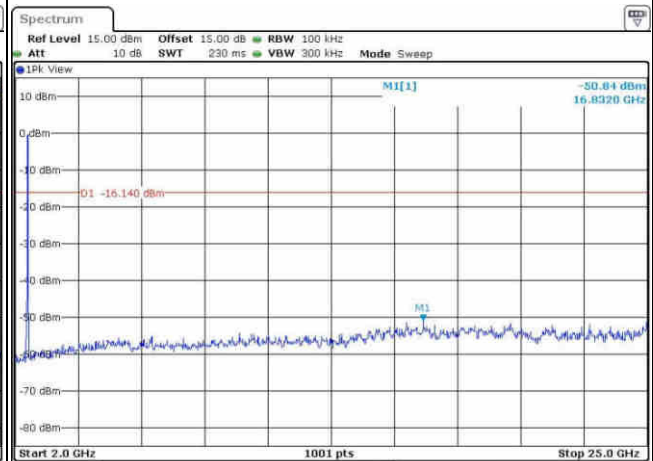

Date: 24.APR.2017 16:47:28



Number of TX :	1	Ant. :	2
Test Mode :	802.11n HT20	Temperature :	24~26°C
Test Band :	2.4GHz Low	Relative Humidity :	50~53%
Test Channel :	01	Test Engineer :	Sam Zheng

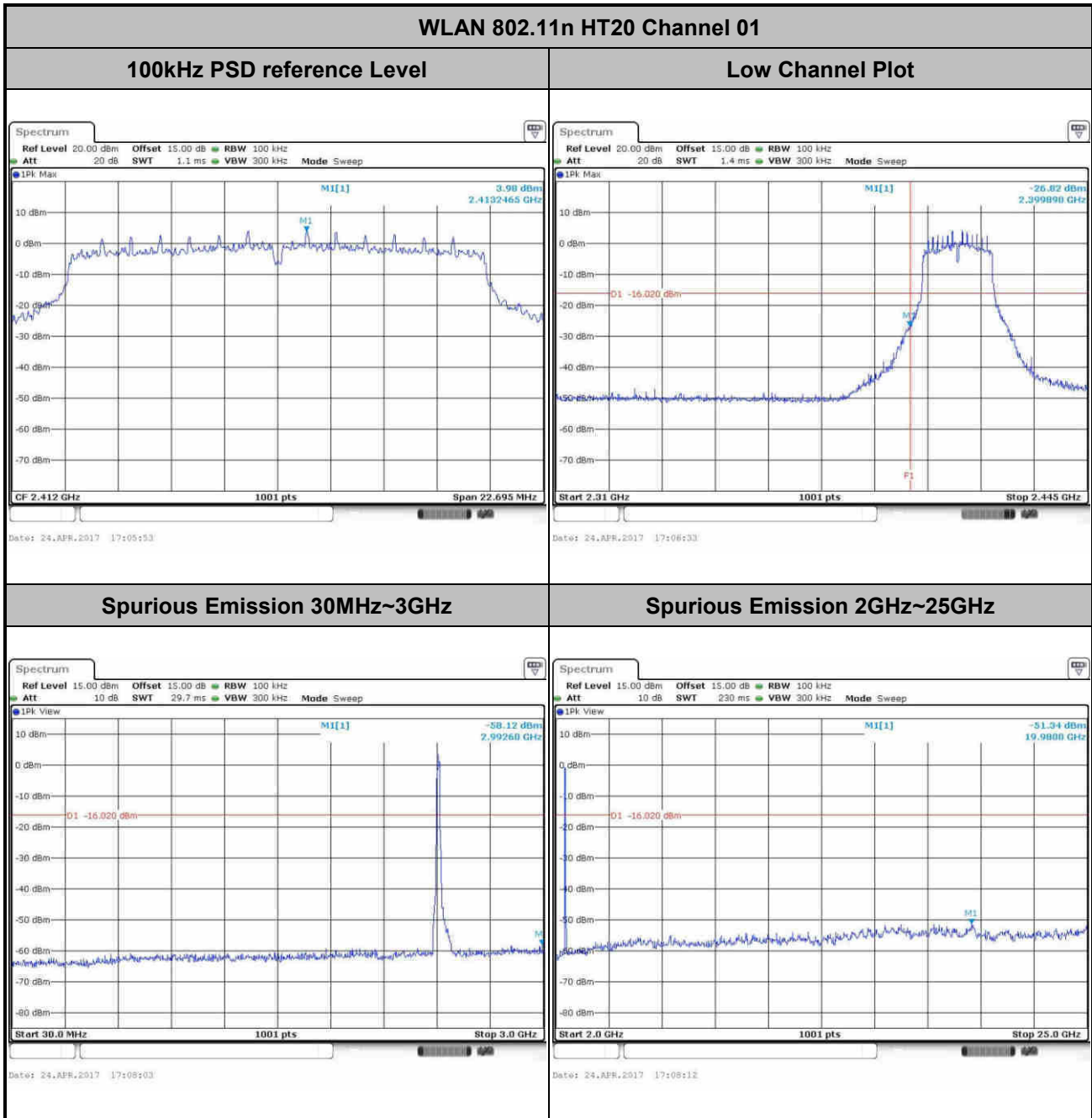



Number of TX :	1	Ant. :	2
Test Mode :	802.11n HT20	Temperature :	24~26°C
Test Band :	2.4GHz Mid	Relative Humidity :	50~53%
Test Channel :	06	Test Engineer :	Sam Zheng

WLAN 802.11n HT20 Channel 06

100kHz PSD reference Level

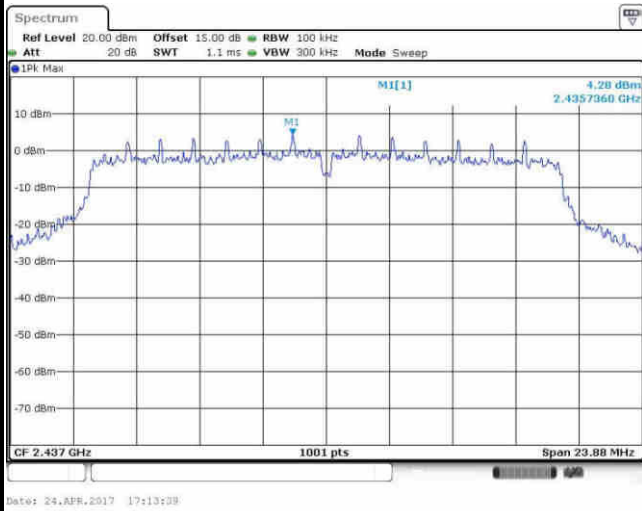

Spurious Emission 30MHz~3GHz

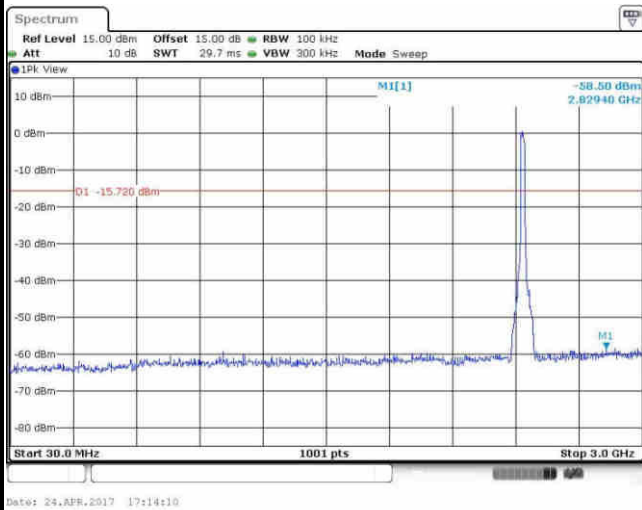

Spurious Emission 2GHz~25GHz

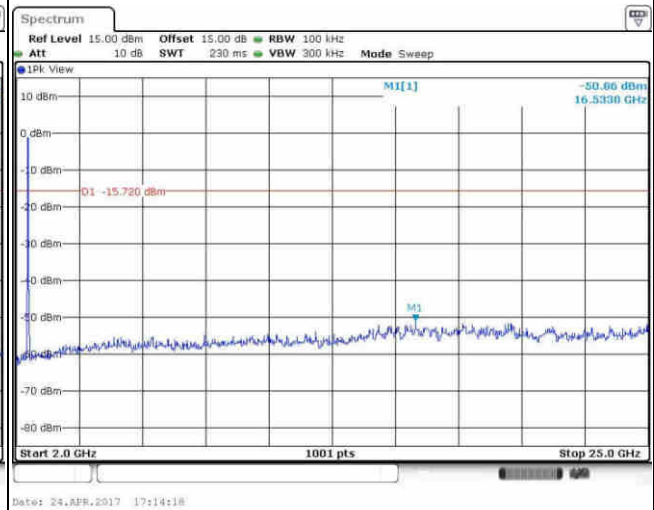



Number of TX :	1	Ant. :	2
Test Mode :	802.11n HT20	Temperature :	24~26°C
Test Band :	2.4GHz High	Relative Humidity :	50~53%
Test Channel :	11	Test Engineer :	Sam Zheng

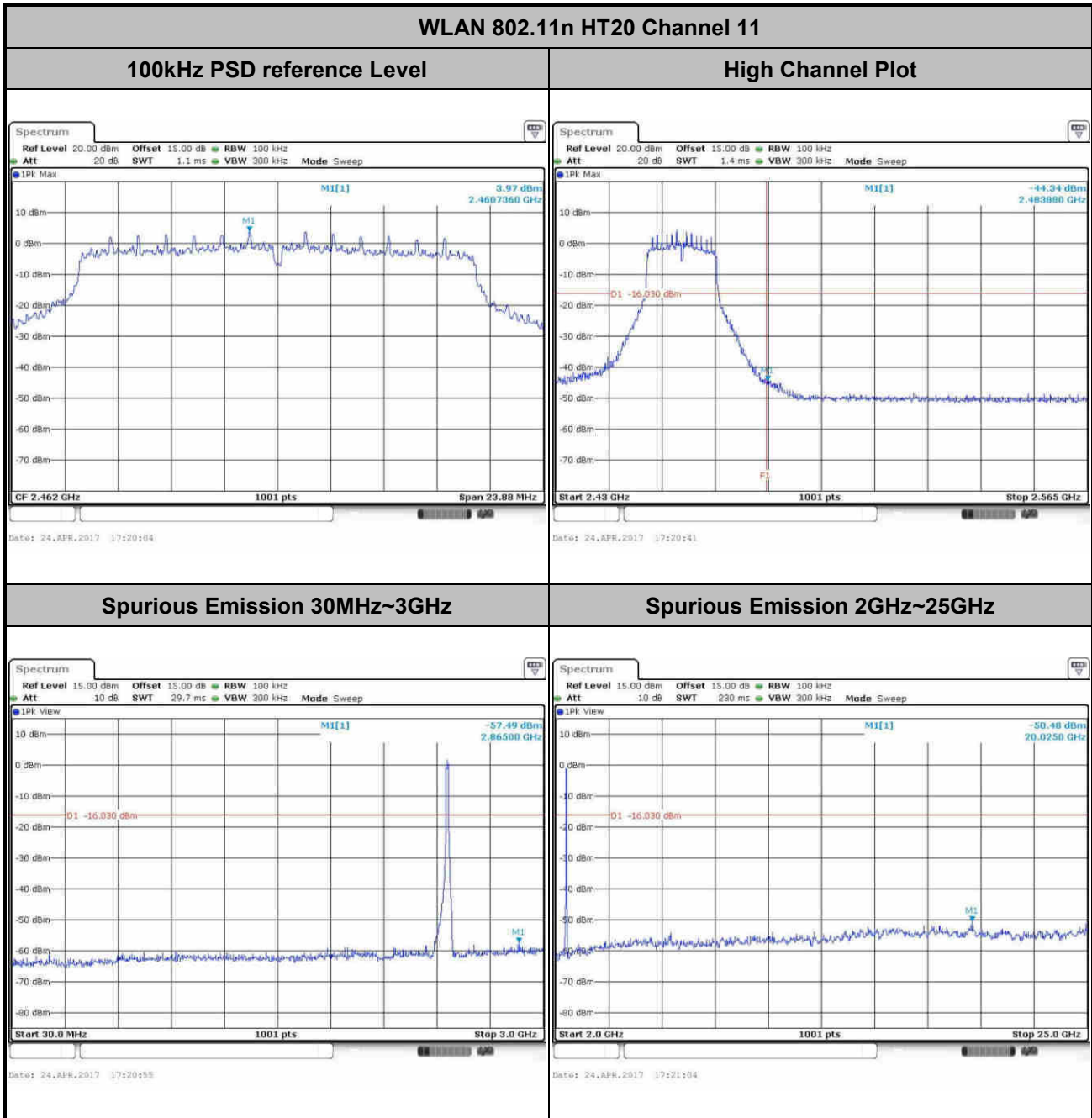



Number of TX :	1	Ant. :	2
Test Mode :	802.11n HT40	Temperature :	24~26°C
Test Band :	2.4GHz Low	Relative Humidity :	50~53%
Test Channel :	03	Test Engineer :	Sam Zheng

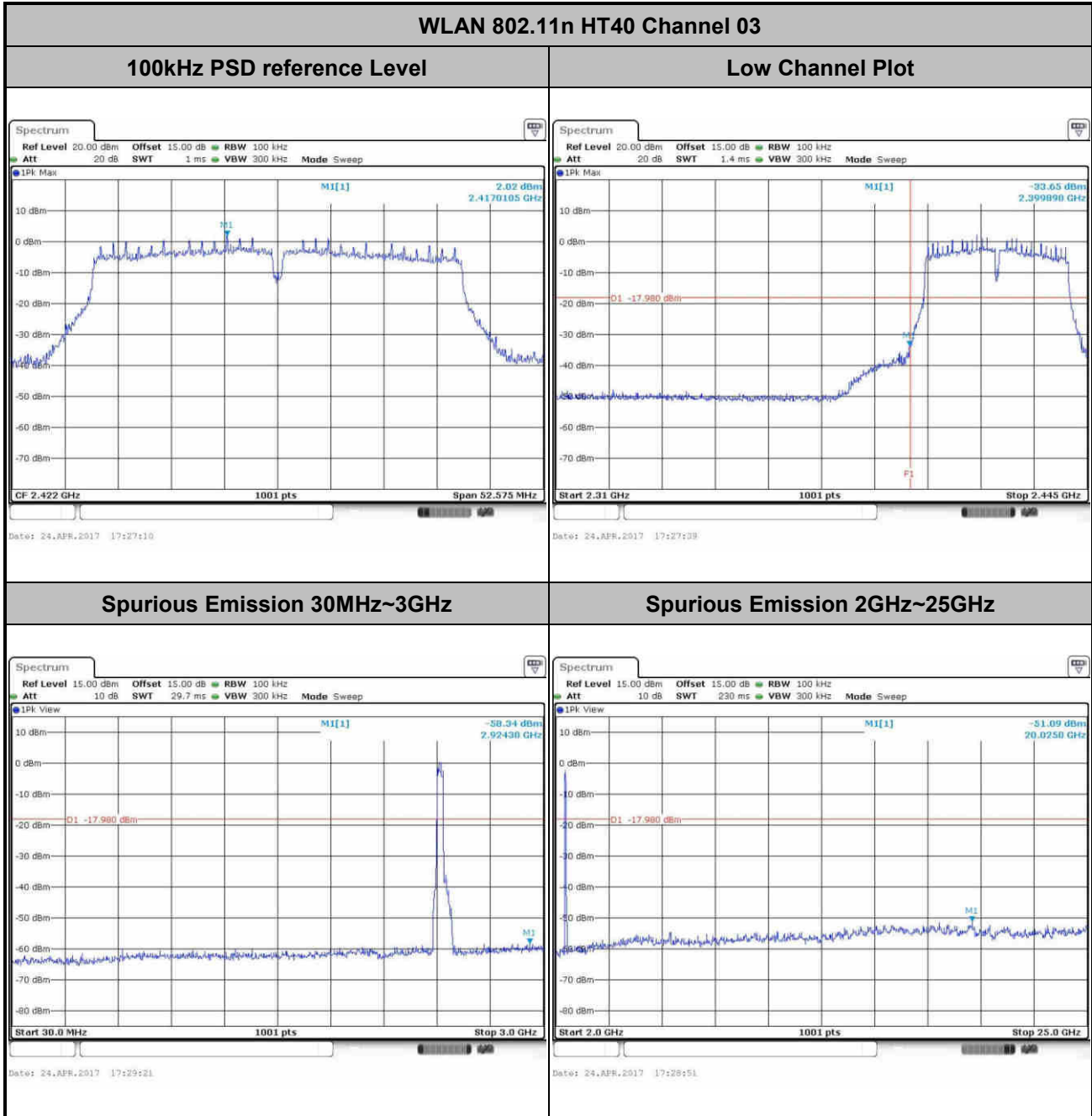



Number of TX :	1	Ant. :	2
Test Mode :	802.11n HT40	Temperature :	24~26°C
Test Band :	2.4GHz Mid	Relative Humidity :	50~53%
Test Channel :	06	Test Engineer :	Sam Zheng

WLAN 802.11n HT40 Channel 06

100kHz PSD reference Level

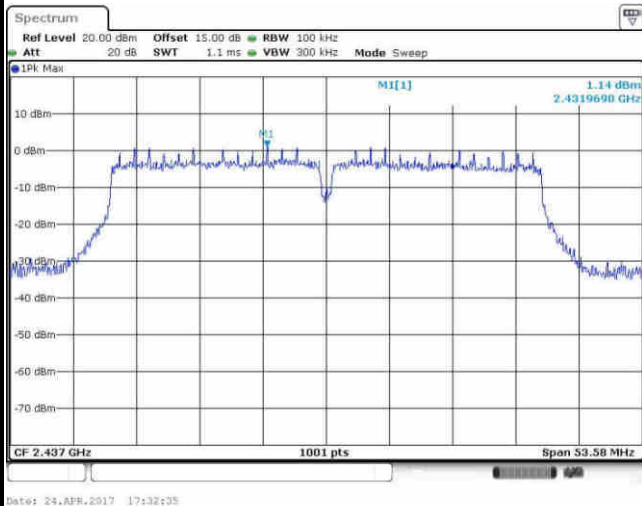

Spurious Emission 30MHz~3GHz

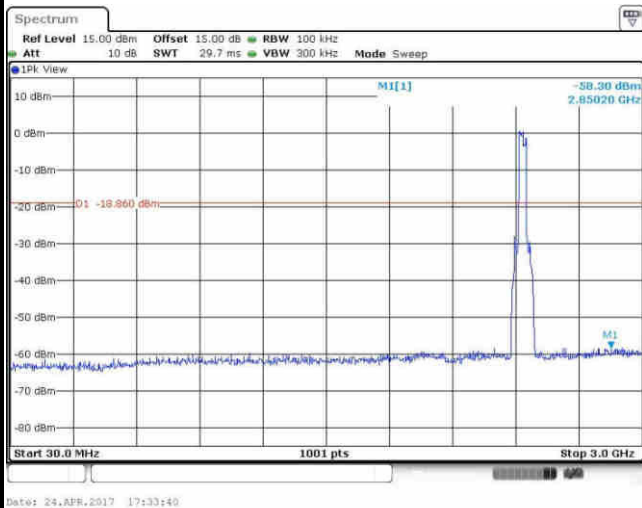

Spurious Emission 2GHz~25GHz

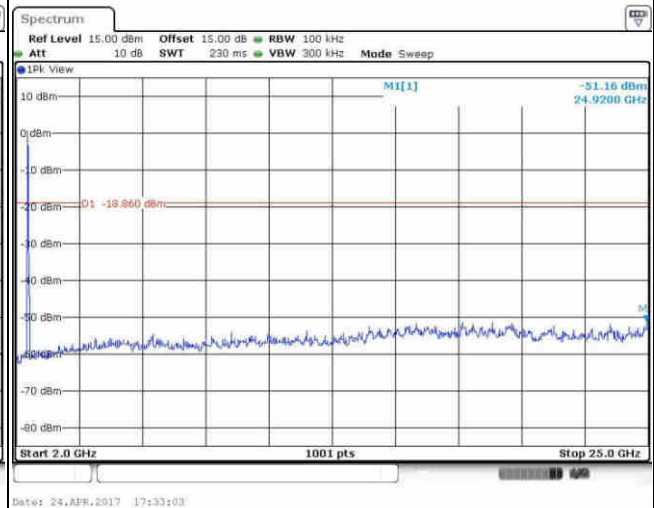



Number of TX :	1	Ant. :	2
Test Mode :	802.11n HT40	Temperature :	24~26°C
Test Band :	2.4GHz High	Relative Humidity :	50~53%
Test Channel :	09	Test Engineer :	Sam Zheng

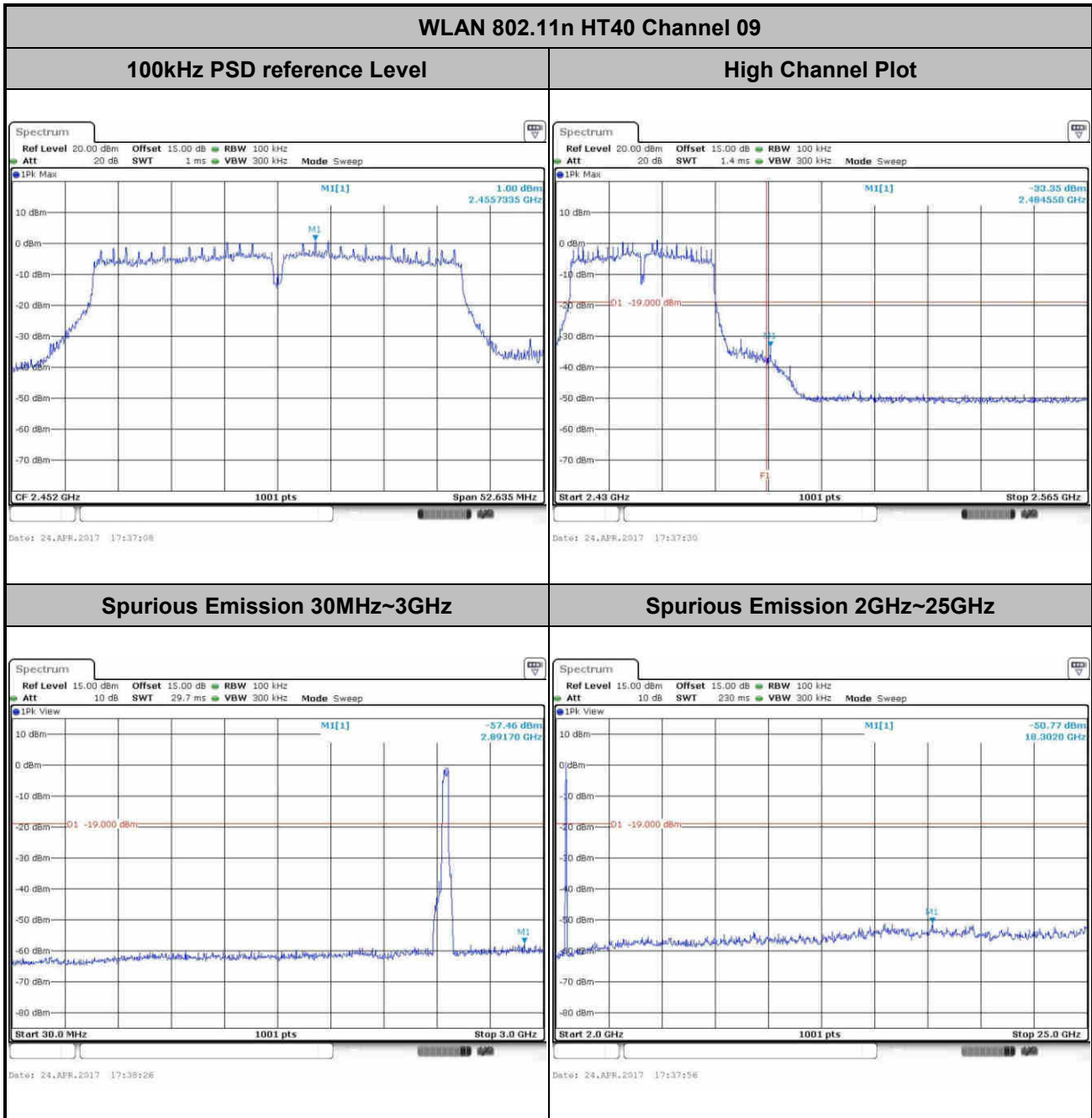



Number of TX = 2, Ant. 1 (Measured)

Number of TX	2	Ant. :	1
Test Mode :	802.11b	Temperature :	24~26°C
Test Band :	2.4GHz Low	Relative Humidity :	50~53%
Test Channel :	01	Test Engineer :	Sam Zheng

WLAN 802.11b Channel 01

100kHz PSD reference Level

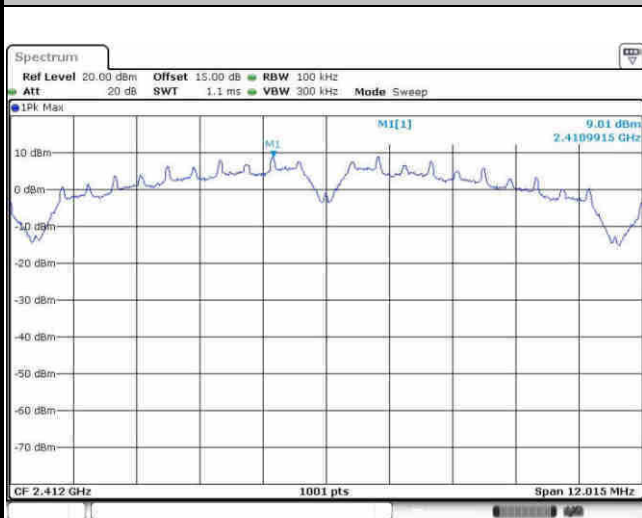

Date: 26 APR 2017 09:20:50

Low Channel Plot

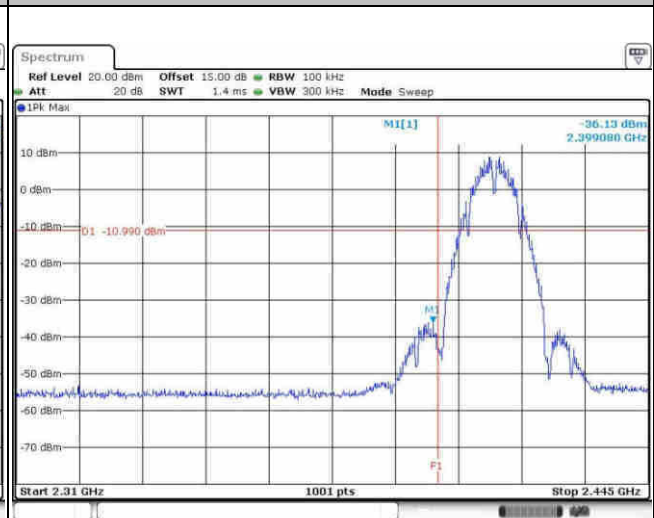

Date: 26 APR 2017 09:21:20

Spurious Emission 30MHz~3GHz

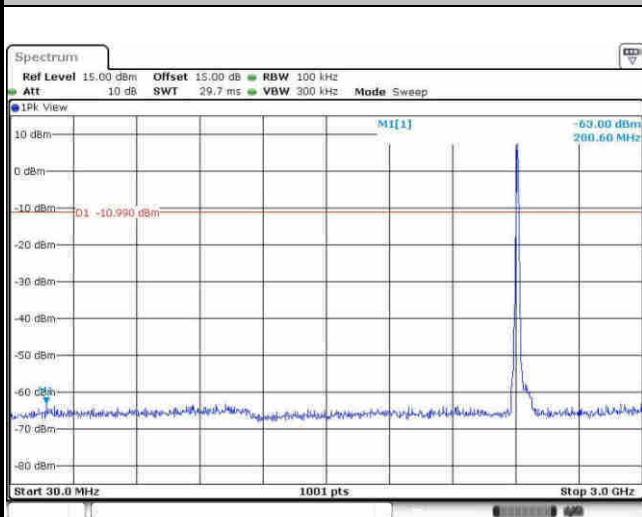

Date: 26 APR 2017 09:21:30

Spurious Emission 2GHz~25GHz

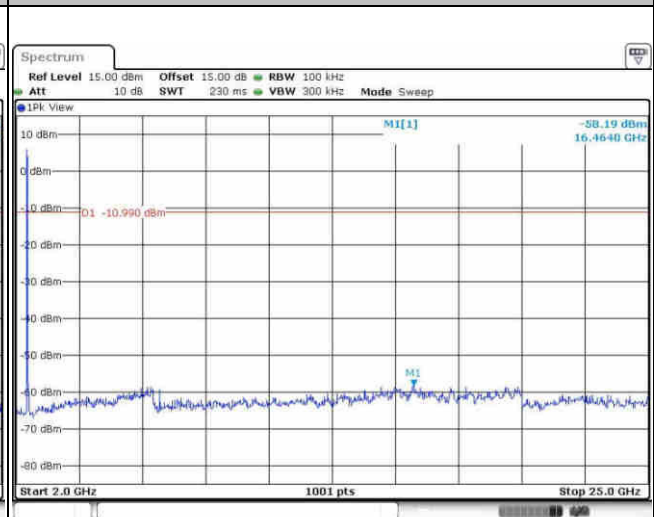

Date: 26 APR 2017 09:21:39



Number of TX :	2	Ant. :	1
Test Mode :	802.11b	Temperature :	24~26°C
Test Band :	2.4GHz Mid	Relative Humidity :	50~53%
Test Channel :	06	Test Engineer :	Sam Zheng

WLAN 802.11b Channel 06

100kHz PSD reference Level

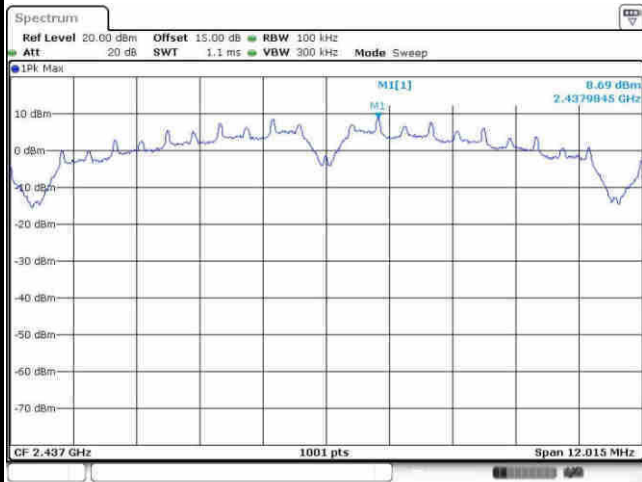

Spurious Emission 30MHz~3GHz

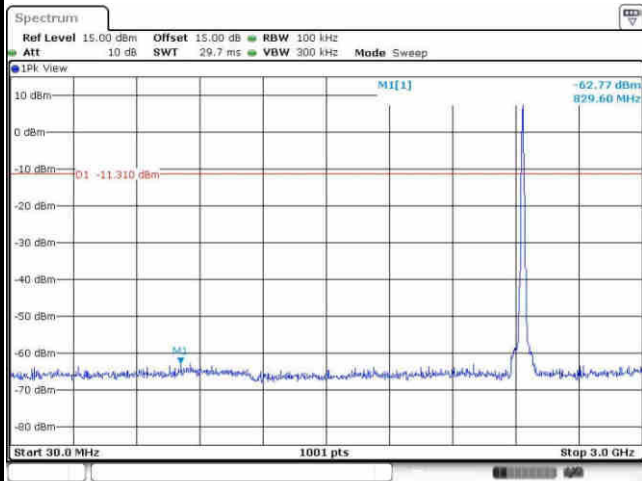

Spurious Emission 2GHz~25GHz

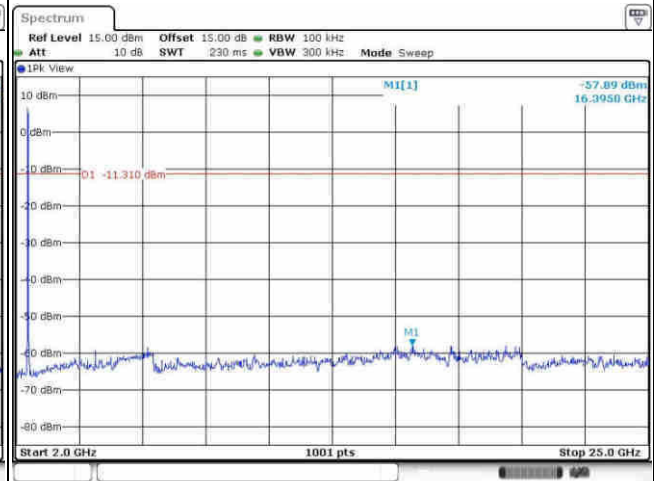



Number of TX :	2	Ant. :	1
Test Mode :	802.11b	Temperature :	24~26°C
Test Band :	2.4GHz High	Relative Humidity :	50~53%
Test Channel :	11	Test Engineer :	Sam Zheng

WLAN 802.11b Channel 11

100kHz PSD reference Level

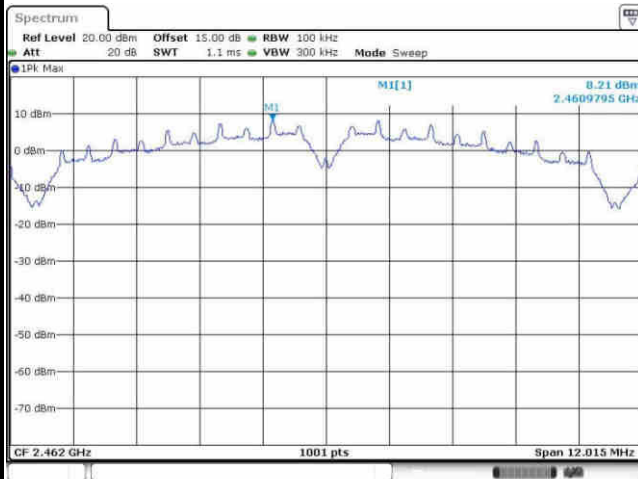

Date: 26 APR 2017 09:26:24

High Channel Plot

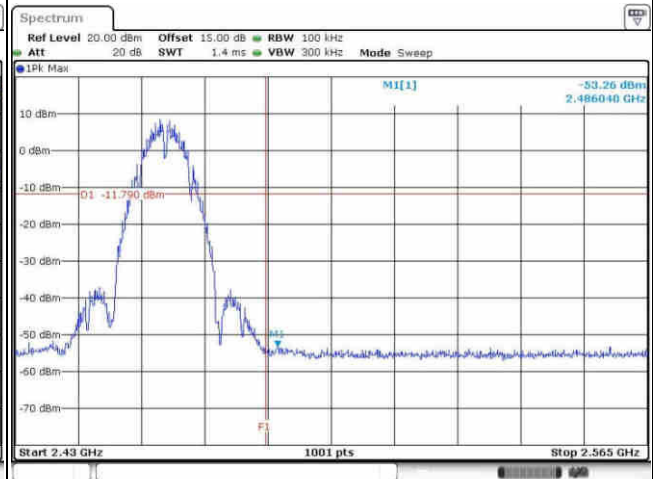

Date: 26 APR 2017 09:26:38

Spurious Emission 30MHz~3GHz

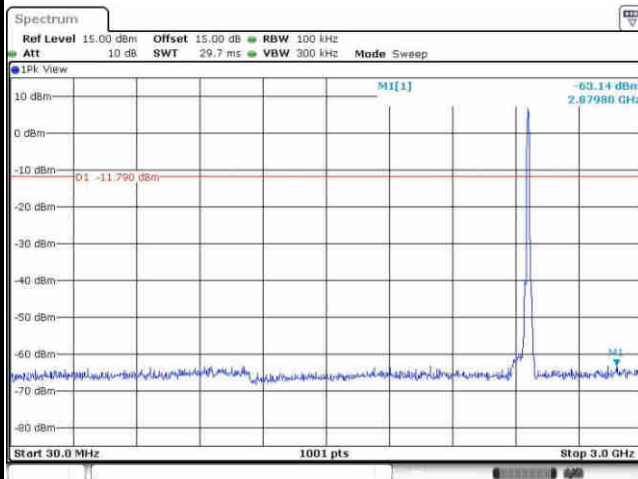

Date: 26 APR 2017 09:26:51

Spurious Emission 2GHz~25GHz

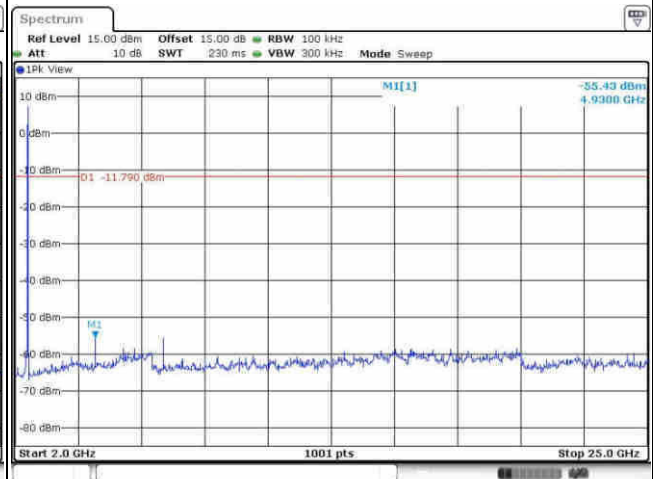

Date: 26 APR 2017 09:26:59



Number of TX :	2	Ant. :	1
Test Mode :	802.11g	Temperature :	24~26°C
Test Band :	2.4GHz Low	Relative Humidity :	50~53%
Test Channel :	01	Test Engineer :	Sam Zheng

WLAN 802.11g Channel 01

100kHz PSD reference Level

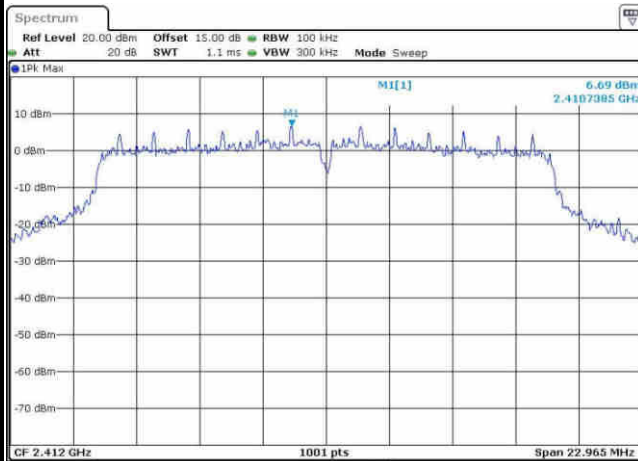

Date: 26 APR 2017 09:09:57

Low Channel Plot

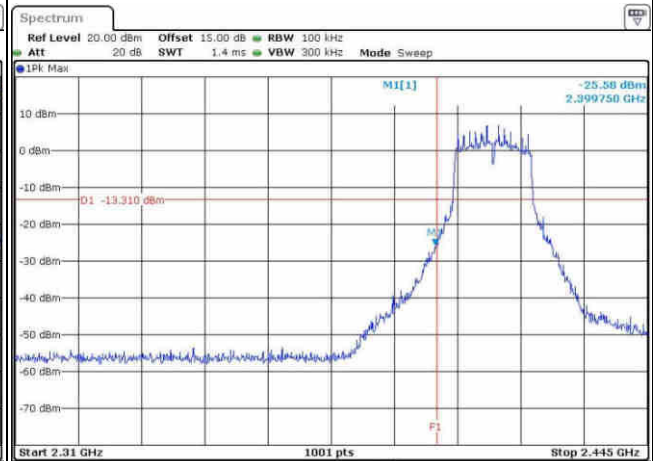

Date: 26 APR 2017 09:11:51

Spurious Emission 30MHz~3GHz

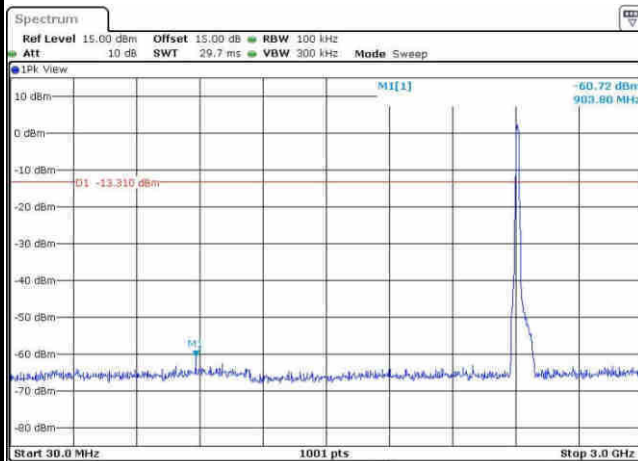

Date: 26 APR 2017 09:11:24

Spurious Emission 2GHz~25GHz

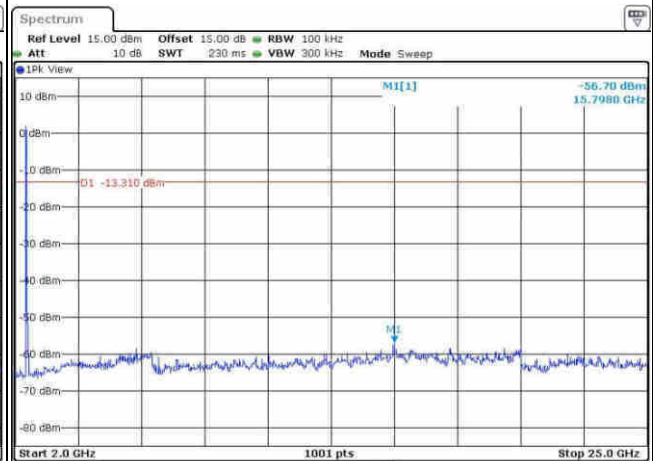

Date: 26 APR 2017 09:11:32



Number of TX :	2	Ant. :	1
Test Mode :	802.11g	Temperature :	24~26°C
Test Band :	2.4GHz Mid	Relative Humidity :	50~53%
Test Channel :	06	Test Engineer :	Sam Zheng

WLAN 802.11g Channel 06

100kHz PSD reference Level

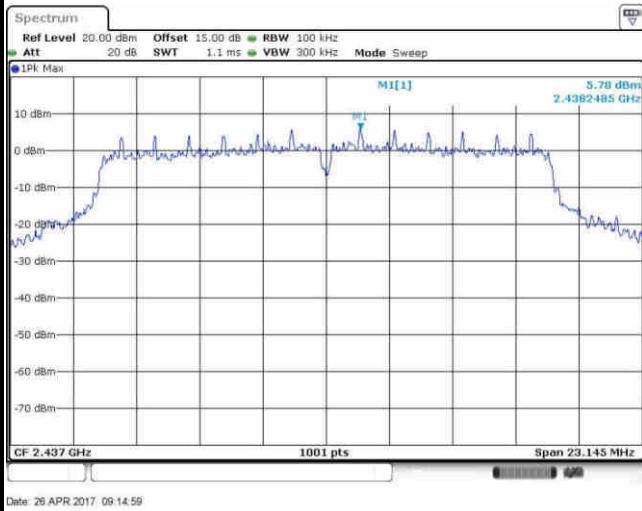

Spurious Emission 30MHz~3GHz

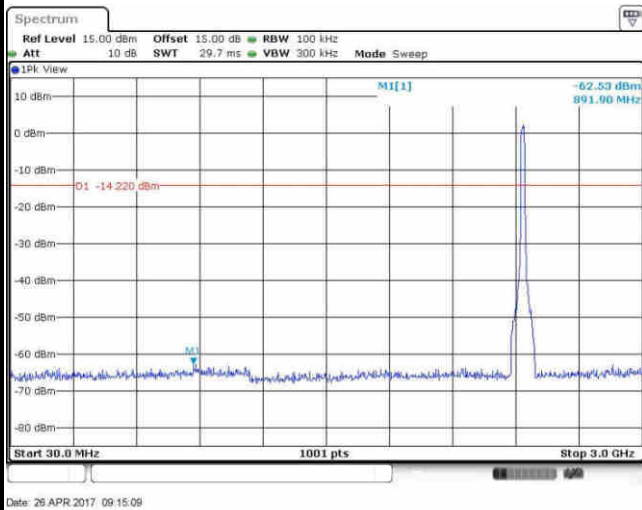

Spurious Emission 2GHz~25GHz

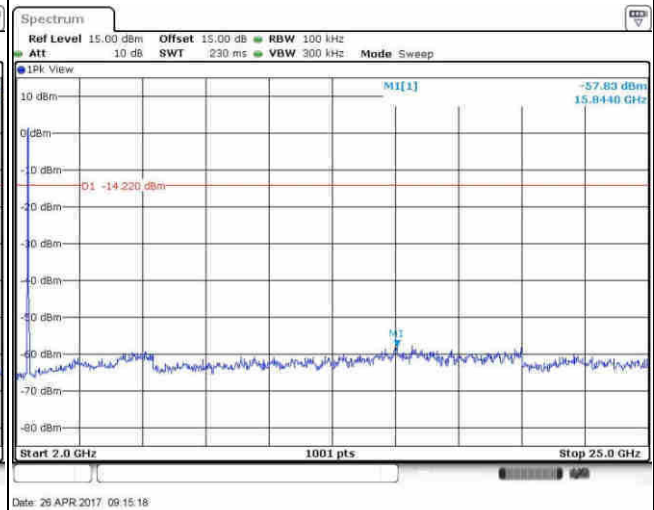



Number of TX :	2	Ant. :	1
Test Mode :	802.11g	Temperature :	24~26°C
Test Band :	2.4GHz High	Relative Humidity :	50~53%
Test Channel :	11	Test Engineer :	Sam Zheng

WLAN 802.11g Channel 11

100kHz PSD reference Level

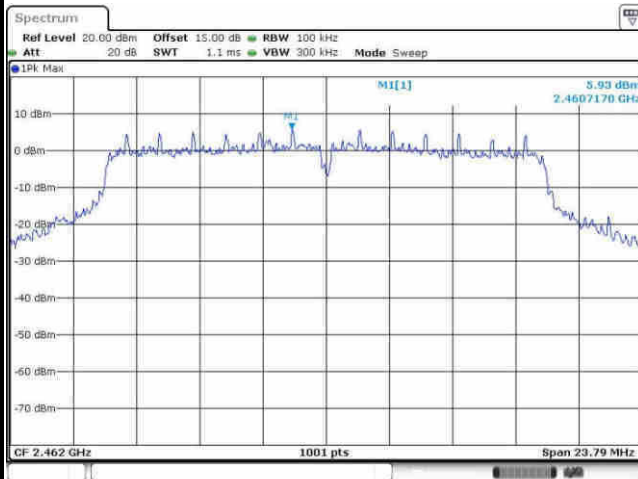

Date: 26 APR 2017 09:17:23

High Channel Plot

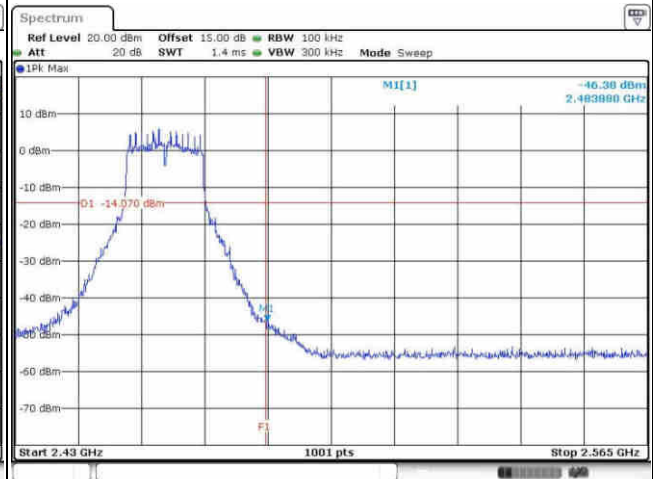

Date: 26 APR 2017 09:17:37

Spurious Emission 30MHz~3GHz

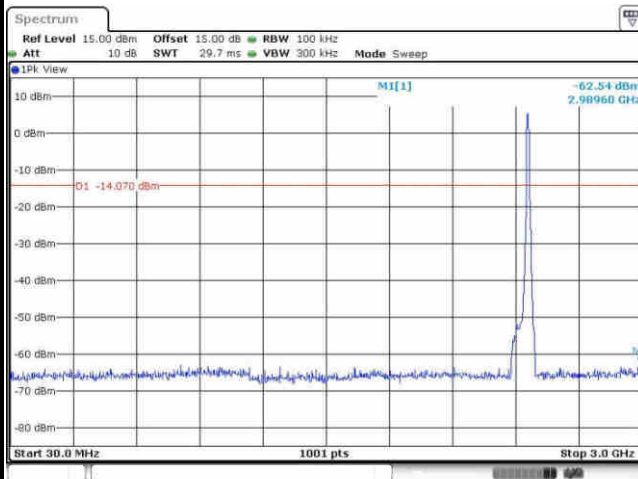

Date: 26 APR 2017 09:17:49

Spurious Emission 2GHz~25GHz

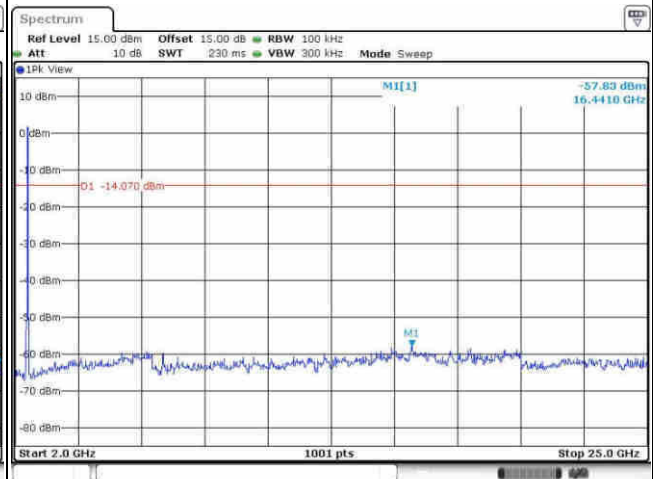

Date: 26 APR 2017 09:17:58



Number of TX :	2	Ant. :	1
Test Mode :	802.11n HT20	Temperature :	24~26°C
Test Band :	2.4GHz Low	Relative Humidity :	50~53%
Test Channel :	01	Test Engineer :	Sam Zheng

