



# FCC RF Test Report

**APPLICANT** : OnePlus Technology (shenzhen) Co., Ltd  
**EQUIPMENT** : Smart Phone  
**BRAND NAME** : ONEPLUS  
**MODEL NAME** : ONEPLUS A5000  
**FCC ID** : 2ABZ2-A5000  
**STANDARD** : FCC 47 CFR Part 2, and 90(S)  
**CLASSIFICATION** : PCS Licensed Transmitter Held to Ear (PCE)

The product was received on Jan. 22, 2017 and testing was completed on May 30, 2017. We, SPORTON International (ShenZhen) INC., would like to declare that the tested sample has been evaluated in accordance with the procedures given in ANSI / TIA / EIA-603-D-2010 and shown compliance with the applicable technical standards.

The test results in this report apply exclusively to the tested model / sample. Without written approval of SPORTON International (ShenZhen) INC., the test report shall not be reproduced except in full.

Prepared by: Eric Shih / Manager

Approved by: Jones Tsai / Manager



**SPORTON International (ShenZhen) INC.**

**1/F, 2/F, Bldg 5, Shiling Industrial Zone, Xinwei Village, Xili, Nanshan District, Shenzhen City,  
Guangdong Province, China**



# TABLE OF CONTENTS

**REVISION HISTORY..... 3**

**SUMMARY OF TEST RESULT ..... 4**

**1 GENERAL DESCRIPTION ..... 5**

1.1. Applicant..... 5

1.2. Manufacturer ..... 5

1.3. Feature of Equipment Under Test..... 5

1.4. Product Specification of Equipment Under Test ..... 6

1.5. Modification of EUT ..... 6

1.6. Maximum Frequency Tolerance, Emission Designator and Conducted Power..... 6

1.7. Testing Site..... 7

1.8. Applied Standards ..... 7

**2 TEST CONFIGURATION OF EQUIPMENT UNDER TEST..... 8**

2.1 Test Mode..... 8

2.2 Connection Diagram of Test System ..... 9

2.3 Support Unit used in test configuration and system..... 9

2.4 Measurement Results Explanation Example ..... 9

2.5 Frequency List of Low/Middle/High Channels..... 10

**3 TEST RESULT..... 11**

3.1 Conducted Output Power Measurement..... 11

3.2 99% Occupied Bandwidth and 26dB Bandwidth Measurement..... 12

3.3 Emissions Mask Measurement ..... 13

3.4 Emissions Mask – Out Of Band Emissions Measurement..... 15

3.5 Field Strength of Spurious Radiation Measurement ..... 17

3.6 Frequency Stability Measurement..... 19

**4 LIST OF MEASURING EQUIPMENT ..... 21**

**5 UNCERTAINTY OF EVALUATION ..... 22**

**APPENDIX A. TEST RESULTS OF CONDUCTED TEST**

**APPENDIX B. TEST RESULTS OF RADIATED TEST**

**APPENDIX C. SETUP PHOTOGRAPHS**



### REVISION HISTORY

REPORT NO.	VERSION	DESCRIPTION	ISSUED DATE
FW712206	Rev. 01	Initial issue of report	May 27, 2017
FW712206	Rev. 02	Update report for adding the test results of 64QAM.	Jun. 03, 2017



### SUMMARY OF TEST RESULT

Report Section	FCC Rule	Description	Limit	Result	Remark
3.1	§2.1046	Conducted Output Power	Reporting only	PASS	-
3.2	§2.1049 §90.209	Occupied Bandwidth and 26dB Bandwidth	Reporting only	PASS	-
3.3	§2.1051 §90.691	Emission masks – In-band emissions	$< 50+10\log_{10}(P[\text{Watts}])$	PASS	-
3.4	§2.1051 §90.691	Emission masks – Out of band emissions	$< 43+10\log_{10}(P[\text{Watts}])$	PASS	-
3.5	§2.1053 §90.691	Field Strength of Spurious Radiation	$< 43+10\log_{10}(P[\text{Watts}])$	PASS	Under limit 42.67 dB at 2442.720 MHz
3.6	§2.1055 §90.213	Frequency Stability for Temperature & Voltage	$< 2.5 \text{ ppm}$	PASS	-





# 1 General Description

## 1.1. Applicant

**OnePlus Technology (shenzhen) Co., Ltd**

18C02, 18C03, 18C04 and 18C05, Shum Yip Terra Building, Binhe Avenue North, Futian District, Shenzhen

## 1.2. Manufacturer

**OnePlus Technology (shenzhen) Co., Ltd.**

18C02, 18C03, 18C04 and 18C05, Shum Yip Terra Building, Binhe Avenue North, Futian District, Shenzhen

## 1.3. Feature of Equipment Under Test

Product Feature & Specification	
Equipment	Smart Phone
Brand Name	ONEPLUS
Model Name	ONEPLUS A5000
FCC ID	2ABZ2-A5000
EUT supports Radios application	CDMA/EVDO/GSM/GPRS/EGPRS/WCDMA/HSPA/ DC-HSDPA/HSPA+/LTE/NFC WLAN 2.4GHz 802.11b/g/n HT20/HT40 WLAN 2.4GHz 802.11ac VHT20/VHT40 WLAN 5GHz 802.11a/n HT20/HT40 WLAN 5GHz 802.11ac VHT20/VHT40/VHT80 Bluetooth v3.0 + EDR/Bluetooth v4.0 LE/ Bluetooth v4.1 LE/Bluetooth v4.2 LE/ Bluetooth v5.0 LE
IMEI Code	Conducted: 001001228352610&001001228352610 Radiation: 001001227811087/001001227811087
HW Version	EB101
SW Version	H2OS V3.5
EUT Stage	Production Unit

**Remark:** The above EUT's information was declared by manufacturer. Please refer to the specifications or user's manual for more detailed description.



### 1.4. Product Specification of Equipment Under Test

Product Specification subjective to this standard	
<b>Tx Frequency</b>	LTE Band 26 : 814.7 ~ 823.3 MHz
<b>Rx Frequency</b>	LTE Band 26 : 859.7 ~ 868.3 MHz
<b>Bandwidth</b>	1.4MHz / 3MHz / 5MHz / 10MHz / 15MHz
<b>Maximum Output Power to Antenna</b>	23.17 dBm
<b>Antenna Type</b>	PIFA Antenna
<b>Type of Modulation</b>	QPSK / 16QAM / 64QAM

**Remark:** This test report recorded only product characteristics and test results of PCS Licensed Transmitter Held to Ear (PCE).

### 1.5. Modification of EUT

No modifications are made to the EUT during all test items.

### 1.6. Maximum Frequency Tolerance, Emission Designator and Conducted Power

FCC Rule	System	Type of Modulation	BW	Frequency Tolerance (ppm)	Emission Designator	Maximum Conducted power(W)
Part 90S	LTE Band 26	QPSK	1.4 MHz	-	1M10G7D	0.2061
Part 90S	LTE Band 26	16QAM	1.4 MHz	-	1M10W7D	0.1828
Part 90S	LTE Band 26	64QAM	1.4 MHz	-	1M09W7D	0.1300
Part 90S	LTE Band 26	QPSK	3 MHz	-	2M75G7D	0.2061
Part 90S	LTE Band 26	16QAM	3 MHz	-	2M72W7D	0.1837
Part 90S	LTE Band 26	64QAM	3 MHz	-	2M75W7D	0.1380
Part 90S	LTE Band 26	QPSK	5 MHz	-	4M48G7D	0.2061
Part 90S	LTE Band 26	16QAM	5 MHz	-	4M48W7D	0.1828
Part 90S	LTE Band 26	64QAM	5 MHz	-	4M49W7D	0.1330
Part 90S	LTE Band 26	QPSK	10 MHz	0.0457 ppm	9M13G7D	0.2065
Part 90S	LTE Band 26	16QAM	10 MHz	-	9M03W7D	0.1824
Part 90S	LTE Band 26	64QAM	10 MHz	-	8M95W7D	0.1327
Part 90S	LTE Band 26	QPSK	15 MHz	-	13M5G7D	0.2075
Part 90S	LTE Band 26	16QAM	15 MHz	-	13M4W7D	0.1879
Part 90S	LTE Band 26	64QAM	15 MHz	-	13M4W7D	0.1343

### 1.7. Testing Site

<b>Test Site</b>	SPORTON International (ShenZhen) INC.	
<b>Test Site Location</b>	1/F, 2/F, Bldg 5, Shiling Industrial Zone, Xinwei Village, Xili, Nanshan District, Shenzhen City, Guangdong Province, China TEL: +86-755-8637-9589 FAX: +86-755-8637-9595	
<b>Test Site No.</b>	<b>Sporton Site No.</b>	
	TH01-SZ	

<b>Test Site</b>	SPORTON International (ShenZhen) INC.	
<b>Test Site Location</b>	No. 3 Building, the third floor of south, Shahe River west, Fengzeyuan warehouse, Nanshan District, Shenzhen, Guangdong, P. R. China TEL: +86-755- 3320-2398	
<b>Test Site No.</b>	<b>Sporton Site No.</b>	<b>FCC/IC Registration No.</b>
	03CH03-SZ	565805/4086F

**Note:** The test site complies with ANSI C63.4 2014 requirement.

### 1.8. Applied Standards

According to the specifications of the manufacturer, the EUT must comply with the requirements of the following standards:

- ♦ FCC 47 CFR Part 2, 90
- ♦ ANSI / TIA / EIA-603-D-2010
- ♦ FCC KDB 971168 D01 Power Meas. License Digital Systems v02r02
- ♦ Interim Guidance for Equipment Authorization of Devices with Channel Bandwidths Combined Across Two Contiguous Service Rule Allocations OET/Lab/EACB, June 6, 2013

**Remark:**

1. All test items were verified and recorded according to the standards and without any deviation during the test.
2. This EUT has also been tested and complied with the requirements of FCC Part 15, Subpart B, recorded in a separate test report.



## 2 Test Configuration of Equipment Under Test

### 2.1 Test Mode

During all testing, EUT is in link mode with base station emulator at maximum power level. The spurious emission measurements were carried out in semi-anechoic chamber with 3-meter test range, and EUT is rotated on three test planes to find out the worst emission.

Frequency range investigated for radiated emission is 30 MHz to 10th harmonic.

Test Items	Band	Bandwidth (MHz)						Modulation			RB #			Test Channel		
		1.4	3	5	10	15	20	QPSK	16QAM	64QAM	1	Half	Full	L	M	H
Max. Output Power	26	v	v	v	v	v	-	v	v	v	v	v	v	v	v	v
26dB and 99% Bandwidth	26	v	v	v	v	v	-	v	v	v			v	v	v	v
Emission masks In-band emissions	26	v	v	v	v	v	-	v	v	v	v		v	v		v
Emission masks - Out of band emissions	26	v	v	v	v	v	-	v	v	v	v			v	v	v
Frequency Stability	26				v		-	v					v		v	
Radiated Spurious Emission	26	v	v	v			-	v			v			v	v	v
	26				v			v			v				v	
Note	<ol style="list-style-type: none"> <li>The mark "v" means that this configuration is chosen for testing</li> <li>The mark "-" means that this bandwidth is not supported.</li> <li>LTE Band26 transmit frequency for part22 rule is 824MHz-849MHz, for part90 rule is 814MHz-824MHz. ERP over 15MHz bandwidth complies the ERP limit line of part22 rule, therefore ERP of the partial frequency spectrum which falls within part 22 also complies.</li> </ol>															

## 2.2 Connection Diagram of Test System

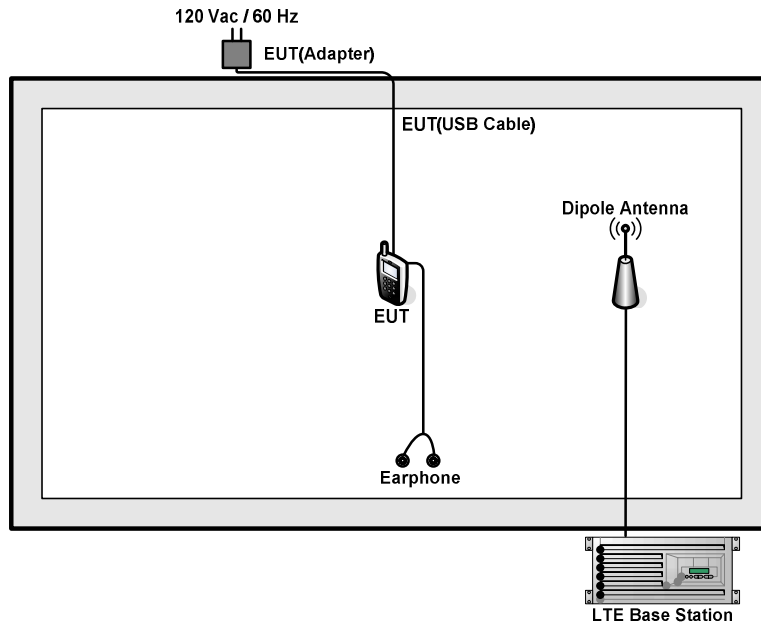

## 2.3 Support Unit used in test configuration and system

Item	Equipment	Trade Name	Model No.	FCC ID	Data Cable	Power Cord
1.	LTE Base Station	Anritsu	MT8820C	N/A	N/A	Unshielded, 1.8 m
2.	DC Power Supply	GW INSTRON	GPS-3030D	N/A	N/A	Unshielded, 1.8 m
3.	Earphone	Apple	MC690ZP/A	N/A	Shielded, 1.0m	N/A

## 2.4 Measurement Results Explanation Example

### For all conducted test items:

The offset level is set in the spectrum analyzer to compensate the RF cable loss and attenuator factor between EUT conducted output port and spectrum analyzer. With the offset compensation, the spectrum analyzer reading level is exactly the EUT RF output level.

Example:

The spectrum analyzer offset is derived from RF cable loss and attenuator factor.

$$\text{Offset} = \text{RF cable loss} + \text{attenuator factor}.$$

The following shows an offset computation example with RF cable loss 4.0 dB and a 10dB attenuator.

Example :

$$\begin{aligned} \text{Offset(dB)} &= \text{RF cable loss(dB)} + \text{attenuator factor(dB)}. \\ &= 4.0 + 10 = 14.0 \text{ (dB)} \end{aligned}$$



## 2.5 Frequency List of Low/Middle/High Channels

LTE Band 26 Channel and Frequency List				
BW [MHz]	Channel/Frequency(MHz)	Lowest	Middle	Highest
15	Channel	26765	-	-
	Frequency	821.5	-	-
10	Channel	-	26740	-
	Frequency	-	819	-
5	Channel	26715	26740	26765
	Frequency	816.5	819	821.5
3	Channel	26705	26740	26775
	Frequency	815.5	819	822.5
1.4	Channel	26697	26740	26783
	Frequency	814.7	819	823.3

### 3 Test Result

#### 3.1 Conducted Output Power Measurement

##### 3.1.1 Description of the Conducted Output Power Measurement

A system simulator was used to establish communication with the EUT. Its parameters were set to enforce EUT transmitting at the maximum power. The measured power in the radio frequency on the transmitter output terminals shall be reported.

##### 3.1.2 Measuring Instruments

The measuring equipment is listed in the section 4 of this test report.

##### 3.1.3 Test Procedures

1. The transmitter output port was connected to the system simulator.
2. Set EUT at maximum power through system simulator.
3. Select lowest, middle, and highest channels for each band and different modulation.
4. Measure and record the power level from the system simulator.

##### 3.1.4 Test Setup

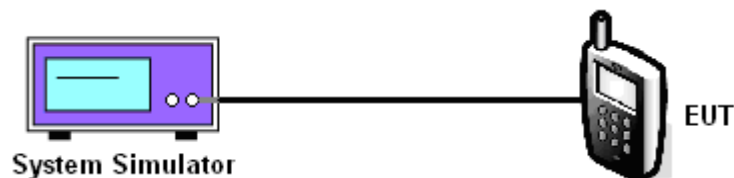

##### 3.1.5 Test Result of Conducted Output Power

Please refer to Appendix A.

## 3.2 99% Occupied Bandwidth and 26dB Bandwidth Measurement

### 3.2.1 Description of (Occupied) Bandwidth Limitations Measurement

The 99% occupied bandwidth is the width of a frequency band such that, below the lower and above the upper frequency limits, the mean powers emitted are each equal to a specified percentage 0.5% of the total mean transmitted power.

The emission bandwidth is defined as the width of the signal between two points, located at the 2 sides of the carrier frequency, outside of which all emissions are attenuated at least 26 dB below the transmitter power.

### 3.2.2 Measuring Instruments

The measuring equipment is listed in the section 4 of this test report.

### 3.2.3 Test Procedures

1. The EUT was connected to spectrum analyzer and system simulator via a power divider.
2. The 26dB and 99% occupied bandwidth (BW) of the middle channel for the highest RF power with full RB sizes were measured.

### 3.2.4 Test Setup

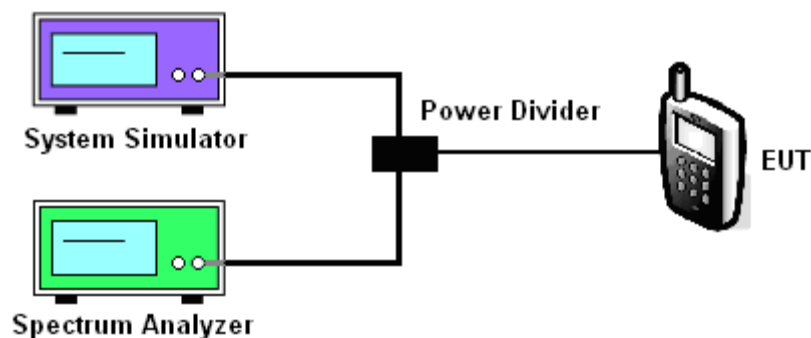

### 3.2.5 Test Result of 99% Occupied Bandwidth and 26dB Bandwidth

Please refer to Appendix A.





### 3.3 Emissions Mask Measurement

#### 3.3.1 Description of Emissions Mask Measurement

Equipment used in this licensed to EA or non-EA systems shall comply with the emission mask provisions of FCC Part 90.691.(a)

(a) Out-of-band emission requirement shall apply only to the "outer" channels included in an EA license and to spectrum adjacent to interior channels used by incumbent licensees. The emission limits are as follows:

(1) For any frequency removed from the EA licensee's frequency block by up to and including 37.5 kHz, the power of any emission shall be attenuated below the transmitter power (P) in watts by at least  $116 \text{ Log}_{10}(f/6.1)$  decibels or  $50 + 10 \text{ Log}_{10}(P)$  decibels or 80 decibels, whichever is the lesser attenuation, where f is the frequency removed from the center of the outer channel in the block in kilohertz and where f is greater than 12.5 kHz.

(2) For any frequency removed from the EA licensee's frequency block greater than 37.5 kHz, the power of any emission shall be attenuated below the transmitter power (P) in watts by at least  $43 + 10\text{Log}_{10}(P)$  decibels or 80 decibels, whichever is the lesser attenuation, where f is the frequency removed from the center of the outer channel in the block in kilohertz and where f is greater than 37.5 kHz.

#### 3.3.2 Measuring Instruments

The measuring equipment is listed in the section 4 of this test report.

#### 3.3.3 Test Procedures

1. The EUT was connected to spectrum analyzer and base station via power divider.
2. The emissions mask of low and high channels for the highest RF powers were measured.
3. The measured RBW and the VBW set 3 times of RBW are then set in spectrum analyzer, and the RBW correction factor  $10\log(1\% \text{ of OBW/measured RBW})$ (dB) was compensated, if required.
4. The test results were shown below plots with a correction offset factor including cable loss, insertion loss of power divider.

### 3.3.4 Test Setup

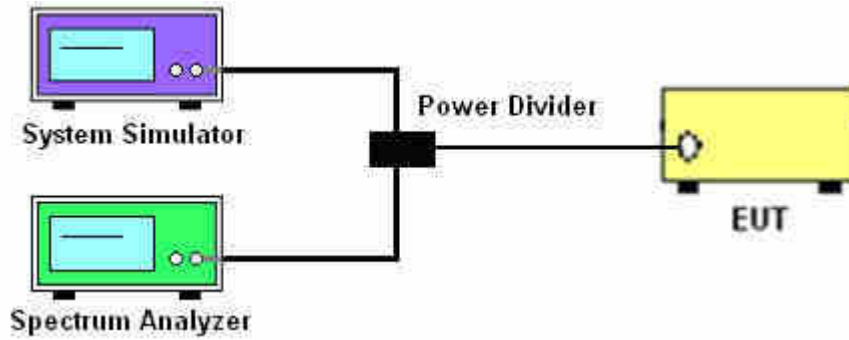

### 3.3.5 Test Result (Plots) of Conducted Emissions Mask

Please refer to Appendix A.



### 3.4 Emissions Mask – Out Of Band Emissions Measurement

#### 3.4.1 Description of Conducted Emissions Out of band emissions measurement

The power of any emission FCC Part 90.691 (a)(2) on any frequency removed from the assigned frequency by out of the authorized bandwidth at least  $43 + 10 \log (P)$  dB. It is measured by means of a calibrated spectrum analyzer and scanned from 30MHz up to a frequency including its 10<sup>th</sup> harmonic.

#### 3.4.2 Measuring Instruments

The measuring equipment is listed in the section 4 of this test report.

#### 3.4.3 Test Procedures

1. The EUT was connected to spectrum analyzer and system simulator via a power divider.
2. The RF output of EUT was connected to the spectrum analyzer by RF cable and attenuator. The path loss was compensated to the results for each measurement.
3. The middle channel for the highest RF power within the transmitting frequency was measured.
4. The conducted spurious emission for the whole frequency range was taken.
5. Make the measurement with the spectrum analyzer's RBW = 1MHz, VBW = 3MHz, taking the record of maximum spurious emission.
6. The RF fundamental frequency should be excluded against the limit line in the operating frequency band.
7. The limit line is derived from  $43 + 10\log(P)$ dB below the transmitter power P(Watts)  
= P(W)- [43 + 10log(P)] (dB)  
= [30 + 10log(P)] (dBm) - [43 + 10log(P)] (dB)  
= -13dBm.

### 3.4.4 Test Setup

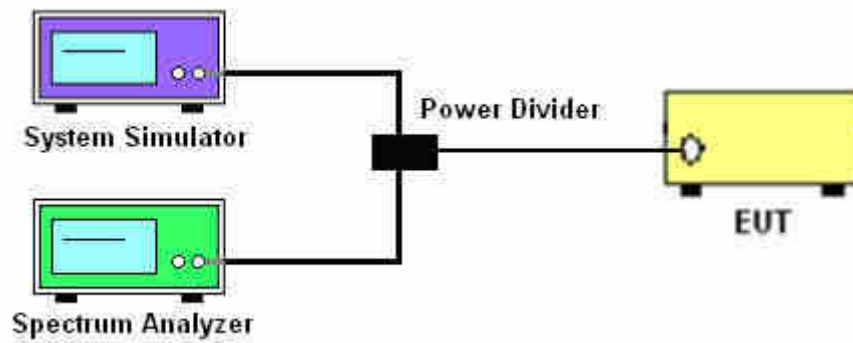

### 3.4.5 Test Result (Plots) of Conducted Emission

Please refer to Appendix A.



### 3.5 Field Strength of Spurious Radiation Measurement

#### 3.5.1 Description of Field Strength of Spurious Radiated Measurement

The radiated spurious emission was measured by substitution method according to ANSI / TIA / EIA-603-D-2010. The power of any emission FCC Part 90.691 on any frequency removed from the assigned frequency by more than 250 percent of the authorized bandwidth at least  $43 + 10 \log (P)$  dB. The spectrum is scanned from 30 MHz up to a frequency including its 10th harmonic.

The power of any emission outside of the authorized operating frequency ranges must be attenuated below the transmitter power (P) by a factor of at least  $43 + 10 \log_{10}(P[\text{Watts}])$  dB. The spectrum is scanned from 30 MHz up to a frequency including its 10th harmonic.

#### 3.5.2 Measuring Instruments

The measuring equipment is listed in the section 4 of this test report.

#### 3.5.3 Test Procedures

1. The EUT was placed on a turntable with 0.8 meter for frequency below 1GHz and 1.5 meter for frequency above 1GHz respectively above ground.
2. The EUT was set 3 meters from the receiving antenna, which was mounted on the antenna tower.
3. The table was rotated 360 degrees to determine the position of the highest spurious emission.
4. The height of the receiving antenna is varied between one meter and four meters to search the maximum spurious emission for both horizontal and vertical polarizations.
5. Make the measurement with the spectrum analyzer's RBW = 1MHz, VBW = 3MHz, Sweep = 500ms, Taking the record of maximum spurious emission.
6. A horn antenna was substituted in place of the EUT and was driven by a signal generator.
7. Tune the output power of signal generator to the same emission level with EUT maximum spurious emission.
8. Taking the record of output power at antenna port.
9. Repeat step 7 to step 8 for another polarization.
10.  $\text{EIRP (dBm)} = \text{S.G. Power} - \text{Tx Cable Loss} + \text{Tx Antenna Gain}$
11.  $\text{ERP (dBm)} = \text{EIRP} - 2.15$
12. The RF fundamental frequency should be excluded against the limit line in the operating frequency band.
13. The limit line is derived from  $43 + 10 \log(P)$  dB below the transmitter power P(Watts)  
 $= P(\text{W}) - [43 + 10 \log(P)] (\text{dB})$   
 $= [30 + 10 \log(P)] (\text{dBm}) - [43 + 10 \log(P)] (\text{dB})$   
 $= -13 \text{dBm}.$

### 3.5.4 Test Setup

For radiated test from 30MHz to 1GHz

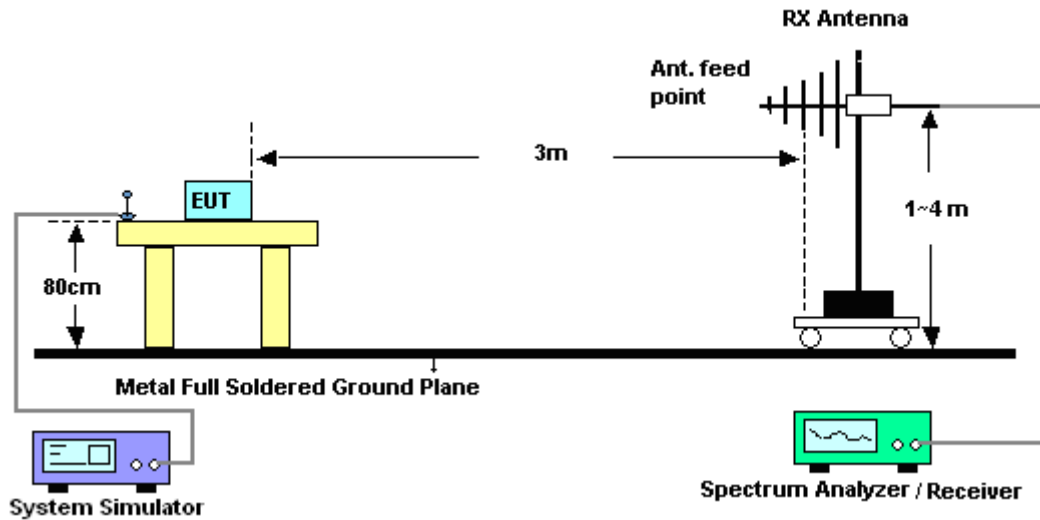

For radiated test above 1GHz

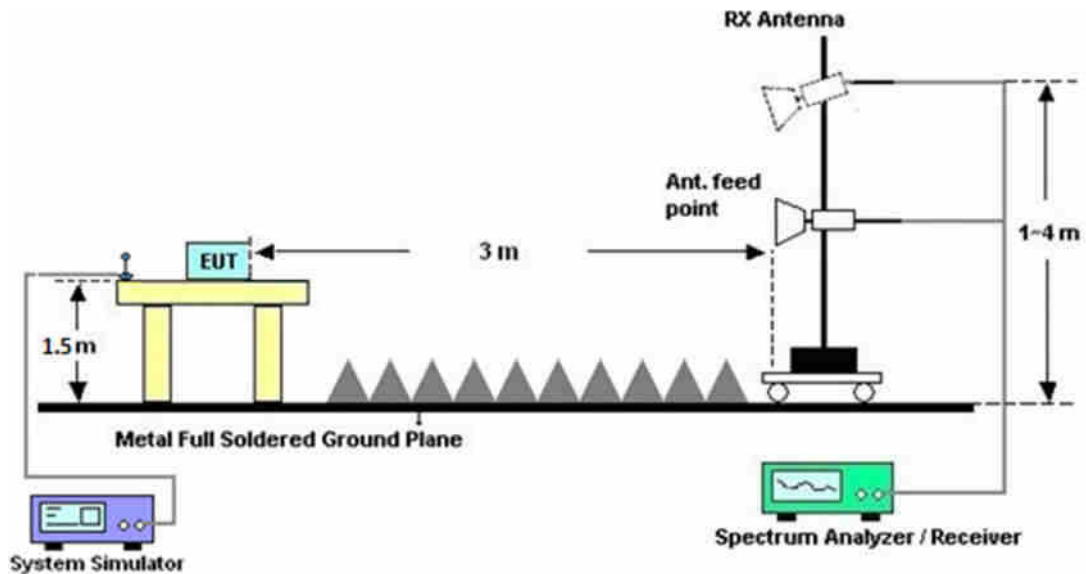

### 3.5.5 Test Result of Field Strength of Spurious Radiated

Please refer to Appendix B.

## 3.6 Frequency Stability Measurement

### 3.6.1 Description of Frequency Stability Measurement

The frequency stability shall be measured by variation of ambient temperature and variation of primary supply voltage to ensure that the fundamental emission stays within the authorized frequency block. The frequency stability of the transmitter shall be maintained within  $\pm 0.00025\%$  ( $\pm 2.5\text{ppm}$ ) of the center frequency according to FCC Part 90.213.

### 3.6.2 Measuring Instruments

The measuring equipment is listed in the section 4 of this test report.

### 3.6.3 Test Procedures for Temperature Variation

1. The EUT was set up in the thermal chamber and connected with the base station.
2. With power OFF, the temperature was decreased to  $-30^{\circ}\text{C}$  and the EUT was stabilized for three hours. Power was applied and the maximum change in frequency was recorded within one minute.
3. With power OFF, the temperature was raised in  $10^{\circ}\text{C}$  step up to  $50^{\circ}\text{C}$ . The EUT was stabilized at each step for at least half an hour. Power was applied and the maximum frequency change was recorded within one minute.

### 3.6.4 Test Procedures for Voltage Variation

1. The EUT was placed in a temperature chamber at  $20\pm 5^{\circ}\text{C}$  and connected with the base station.
2. The power supply voltage to the EUT was varied from BEP to 115% of the nominal value measured at the input to the EUT.
3. The variation in frequency was measured for the worst case.

### 3.6.5 Test Setup

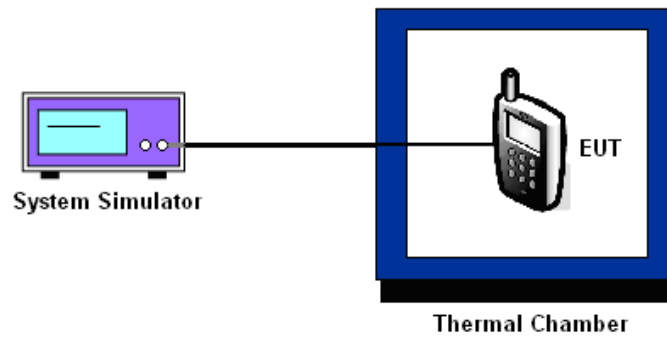

### 3.6.6 Test Result of Temperature Variation

Please refer to Appendix A.





## 4 List of Measuring Equipment

Instrument	Manufacturer	Model No.	Serial No.	Characteristics	Calibration Date	Test Date	Due Date	Remark
Spectrum Analyzer	R&S	FSV40	101078	9kHz~40GHz	May 07, 2016	Apr. 08, 2017	May 06, 2017	Conducted (TH01-SZ)
Spectrum Analyzer	R&S	FSV40	101078	9kHz~40GHz	Apr. 20, 2017	May 15, 2017~ May 30, 2017	Apr. 19, 2018	Conducted (TH01-SZ)
Radio Communicatio	Anritsu	MT8820C	6201563777	2G/3G/4G (CDMA)	Jan. 03, 2017	Apr. 08, 2017~ May 30, 2017	Jan. 02, 2018	Conducted (TH01-SZ)
Thermal Chamber	Ten Billion Hongzhangroup	LP-150U	H2014081803	-40~+150°C	Jul. 16, 2016	Apr. 08, 2017~ May 30, 2017	Jul. 15, 2017	Conducted (TH01-SZ)
EXA Spectrum Anaiyzer	KEYSIGHT	N9010A	MY55150246	10Hz~44GHz	Jul. 07, 2016	May 13, 2017	Jul. 06, 2017	Radiation (03CH03-SZ)
Bilog Antenna	TeseQ	CBL6112D	35408	30MHz~2GHz	May 21, 2016	May 13, 2017	May 20, 2017	Radiation (03CH03-SZ)
Double Ridge Horn Antenna	SCHWARZBECK	BBHA9120D	9120D-1355	1GHz~18GHz	Jul. 07, 2016	May 13, 2017	Jul. 06, 2017	Radiation (03CH03-SZ)
SHF-EHF Horn	com-power	AH-840	101071	18GHz~40GHz	Aug. 10, 2016	May 13, 2017	Aug. 09, 2017	Radiation (03CH03-SZ)
Amplifier	Burgeon	BPA-530	102210	0.01Hz ~3000MHz	Oct. 11, 2016	May 13, 2017	Oct. 10, 2017	Radiation (03CH03-SZ)
Amplifier	Agilent Technologies	83017A	MY39501302	500MHz~26.5GHz	Jan. 06, 2017	May 13, 2017	Jan. 05, 2018	Radiation (03CH03-SZ)
AC Power Source	Chroma	61601	616010001985	N/A	NCR	May 13, 2017	NCR	Radiation (03CH03-SZ)
Turn Table	EM	EM1000	N/A	0~360 degree	NCR	May 13, 2017	NCR	Radiation (03CH03-SZ)
Antenna Mast	EM	EM1000	N/A	1 m~4 m	NCR	May 13, 2017	NCR	Radiation (03CH03-SZ)

NCR: No Calibration Required



## 5 Uncertainty of Evaluation

### Uncertainty of Radiated Emission Measurement (30 MHz ~ 1000 MHz)

Measuring Uncertainty for a Level of Confidence of 95% ( $U = 2Uc(y)$ )	3.0dB
---	-------

### Uncertainty of Radiated Emission Measurement (1 GHz ~ 18 GHz)

Measuring Uncertainty for a Level of Confidence of 95% ( $U = 2Uc(y)$ )	3.6dB
---	-------



### Appendix A. Test Results of Conducted Test

#### Conducted Output Power (Average power)

LTE Band 26 Maximum Average Power [dBm]						
BW [MHz]	RB Size	RB Offset	Mod	Lowest	Middle	Highest
15	1	0	QPSK	23.08		
15	1	37		23.17		
15	1	74		23.16		
15	36	0		22.09		
15	36	20		22.10		
15	36	39		22.08		
15	75	0		22.06		
15	1	0	16-QAM	22.63		
15	1	37		22.68		
15	1	74		22.74		
15	36	0		21.23		
15	36	20		21.10		
15	36	39		21.12		
15	75	0		21.14		
15	1	0	64-QAM	21.28		
15	1	37		21.13		
15	1	74		21.02		
15	36	0		20.06		
15	36	20		20.04		
15	36	39		19.92		
15	75	0		19.95		



LTE Band 26 Maximum Average Power [dBm]						
BW [MHz]	RB Size	RB Offset	Mod	Lowest	Middle	Highest
10	1	0	QPSK		23.07	
10	1	25			23.15	
10	1	49			23.09	
10	25	0			22.03	
10	25	12			22.07	
10	25	25			22.01	
10	50	0			22.14	
10	1	0	16-QAM	-	22.60	-
10	1	25			22.53	
10	1	49			22.61	
10	25	0			21.07	
10	25	12			21.21	
10	25	25			20.93	
10	50	0			21.09	
10	1	0	64-QAM		21.23	
10	1	25			21.11	
10	1	49			21.02	
10	25	0			20.04	
10	25	12			20.03	
10	25	25			19.93	
10	50	0			19.99	



LTE Band 26 Maximum Average Power [dBm]						
BW [MHz]	RB Size	RB Offset	Mod	Lowest	Middle	Highest
5	1	0	QPSK	23.00	23.10	23.14
5	1	12		23.06	22.98	23.12
5	1	24		22.97	23.07	23.03
5	12	0		22.11	22.16	22.18
5	12	7		22.11	22.25	22.16
5	12	13		22.02	22.20	22.16
5	25	0		22.10	22.22	22.15
5	1	0	16-QAM	22.53	22.20	22.52
5	1	12		22.57	22.28	22.50
5	1	24		22.62	22.18	22.48
5	12	0		21.10	21.15	21.16
5	12	7		21.11	21.25	21.12
5	12	13		20.99	21.20	21.08
5	25	0		21.09	21.18	21.15
5	1	0	64-QAM	21.17	21.20	21.16
5	1	12		21.12	21.24	21.19
5	1	24		21.10	21.19	21.15
5	12	0		20.03	20.12	20.09
5	12	7		20.03	20.11	20.07
5	12	13		20.01	20.01	20.01
5	25	0		19.99	20.04	20.01



LTE Band 26 Maximum Average Power [dBm]						
BW [MHz]	RB Size	RB Offset	Mod	Lowest	Middle	Highest
3	1	0	QPSK	23.00	23.06	23.12
3	1	8		23.10	23.09	23.14
3	1	14		23.00	23.04	23.10
3	8	0		22.01	22.21	22.11
3	8	4		22.05	22.16	22.14
3	8	7		22.03	22.13	22.12
3	15	0		22.06	22.20	22.17
3	1	0	16-QAM	22.57	22.64	22.31
3	1	8		22.49	22.63	22.30
3	1	14		22.56	22.57	22.33
3	8	0		21.15	21.34	21.10
3	8	4		21.20	21.33	21.18
3	8	7		21.16	21.22	21.05
3	15	0		21.07	21.25	21.20
3	1	0	64-QAM	21.17	21.22	21.40
3	1	8		21.15	21.16	21.26
3	1	14		21.12	21.14	21.25
3	8	0		20.00	20.03	20.10
3	8	4		20.02	20.04	20.14
3	8	7		19.98	20.01	20.11
3	15	0		19.97	19.99	20.10



LTE Band 26 Maximum Average Power [dBm]						
BW [MHz]	RB Size	RB Offset	Mod	Lowest	Middle	Highest
1.4	1	0	QPSK	23.08	23.06	23.03
1.4	1	3		23.01	23.13	23.14
1.4	1	5		22.99	23.01	23.04
1.4	3	0		23.04	23.06	23.10
1.4	3	1		23.08	23.12	23.06
1.4	3	3		23.03	23.06	23.06
1.4	6	0		21.96	22.07	22.07
1.4	1	0	16-QAM	22.22	22.18	22.42
1.4	1	3		22.62	22.31	22.45
1.4	1	5		22.15	22.03	21.99
1.4	3	0		22.10	22.02	21.97
1.4	3	1		22.15	22.21	22.02
1.4	3	3		22.08	22.11	21.97
1.4	6	0		21.23	21.07	21.13
1.4	1	0	64-QAM	21.09	21.02	21.01
1.4	1	3		21.14	21.10	21.07
1.4	1	5		21.08	21.05	21.03
1.4	3	0		20.95	20.90	20.88
1.4	3	1		20.98	20.92	20.89
1.4	3	3		20.96	20.94	20.86
1.4	6	0		19.98	19.97	19.92



**26dB Bandwidth**

Mode	LTE Band 26 : 26dB BW(MHz)											
	1.4MHz		3MHz		5MHz		10MHz		15MHz		20MHz	
BW	1.4MHz		3MHz		5MHz		10MHz		15MHz		20MHz	
Mod.	QPSK	16QAM	QPSK	16QAM	QPSK	16QAM	QPSK	16QAM	QPSK	16QAM	QPSK	16QAM
Lowest CH	1.225	1.225	3.027	3.039	4.825	4.825	-	-	14.236	14.176	-	-
Middle CH	1.228	1.214	3.015	3.015	4.895	4.905	9.67	9.81	-	-	-	-
Highest CH	1.234	1.245	2.997	3.003	4.935	4.865	-	-	-	-	-	-
BW	1.4MHz	3MHz	5MHz	10MHz	15MHz	20MHz						
Mod.	64QAM	64QAM	64QAM	64QAM	64QAM	64QAM						
Lowest CH	1.234	3.027	4.895	-	14.715	-						
Middle CH	1.220	3.045	4.835	9.770	-	-						
Highest CH	1.245	2.985	4.945	-	-	-						





LTE Band 26

Lowest Channel / 1.4MHz / QPSK

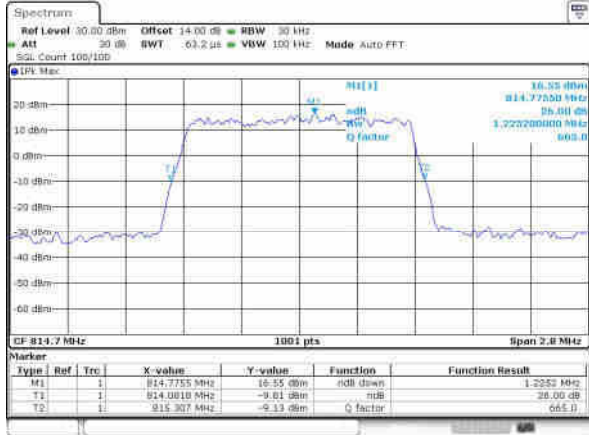

Lowest Channel / 1.4MHz / 16QAM

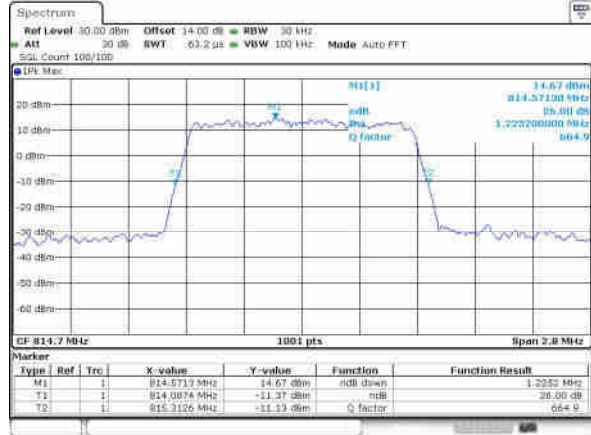

Middle Channel / 1.4MHz / QPSK

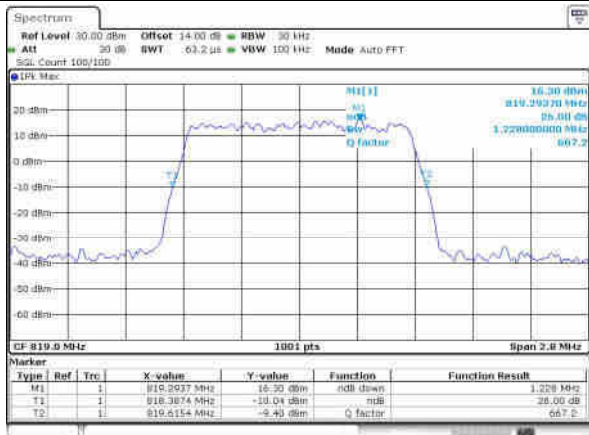

Middle Channel / 1.4MHz / 16QAM

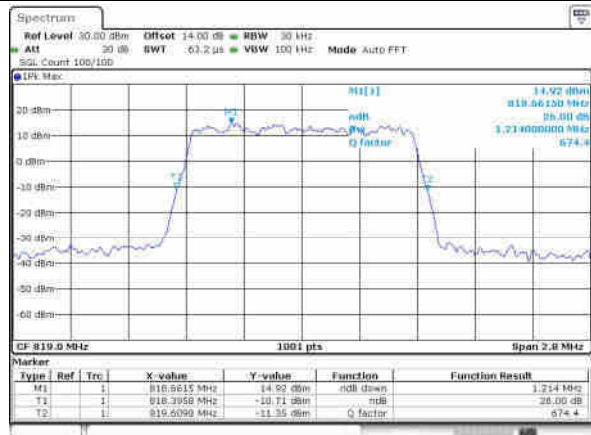

Highest Channel / 1.4MHz / QPSK

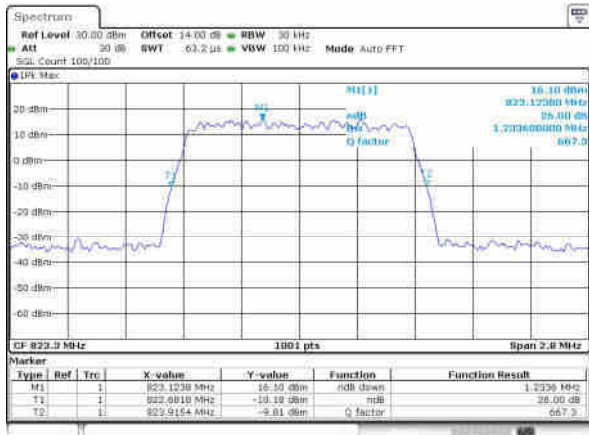

Highest Channel / 1.4MHz / 16QAM

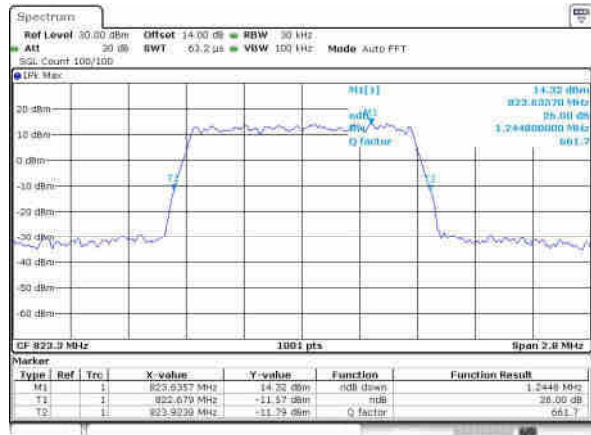



LTE Band 26

Lowest Channel / 3MHz / QPSK

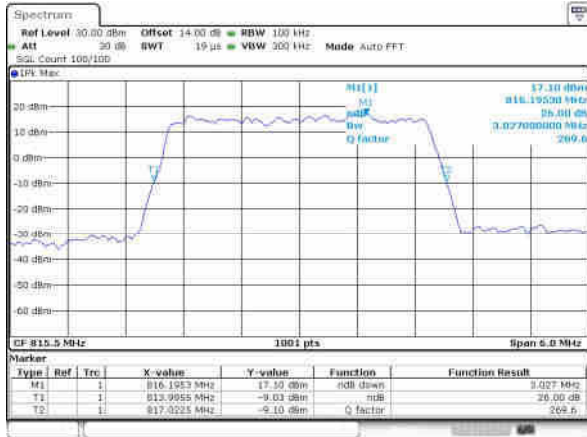

Lowest Channel / 3MHz / 16QAM

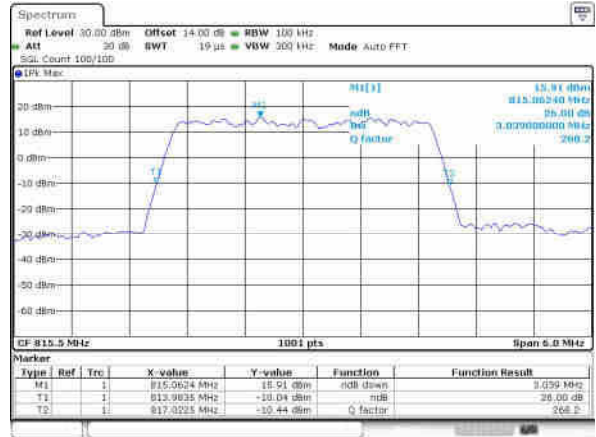

Middle Channel / 3MHz / QPSK

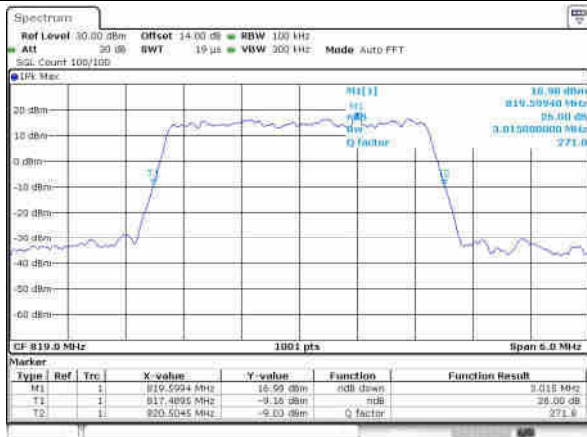

Middle Channel / 3MHz / 16QAM

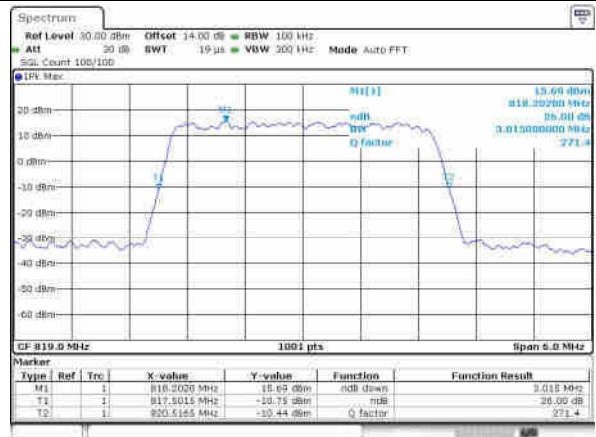

Highest Channel / 3MHz / QPSK

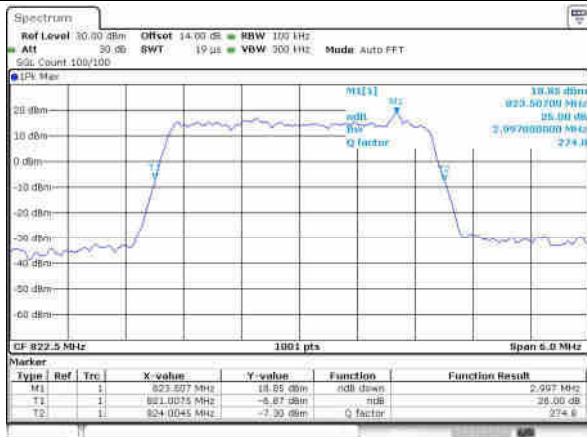

Highest Channel / 3MHz / 16QAM

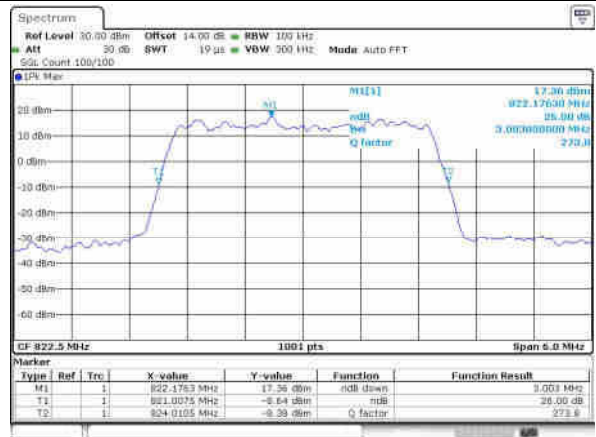



LTE Band 26

Lowest Channel / 5MHz / QPSK

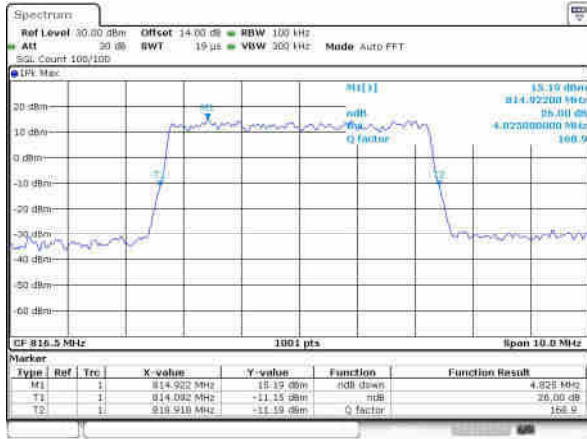

Lowest Channel / 5MHz / 16QAM

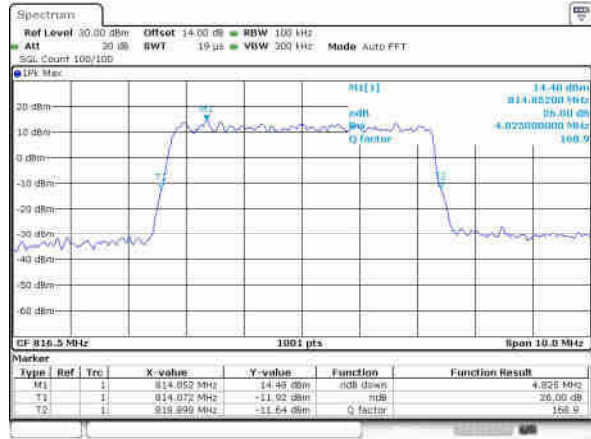

Middle Channel / 5MHz / QPSK

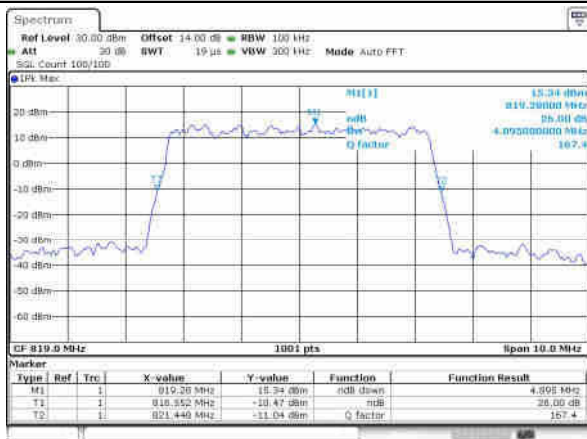

Middle Channel / 5MHz / 16QAM

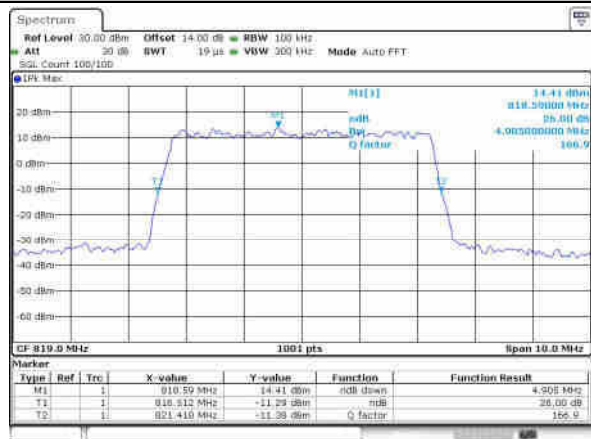

Highest Channel / 5MHz / QPSK

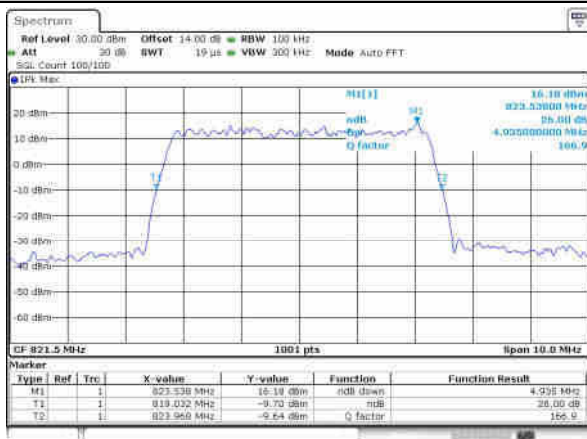

Highest Channel / 5MHz / 16QAM

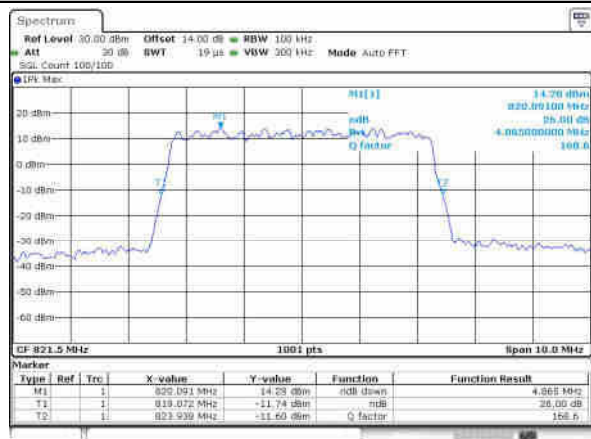



LTE Band 26

Middle Channel / 10MHz / QPSK

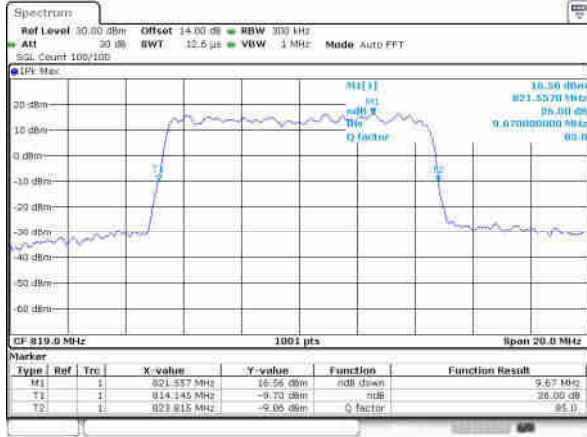

Date: 8\_APR\_2017 16:16:23

Middle Channel / 10MHz / 16QAM

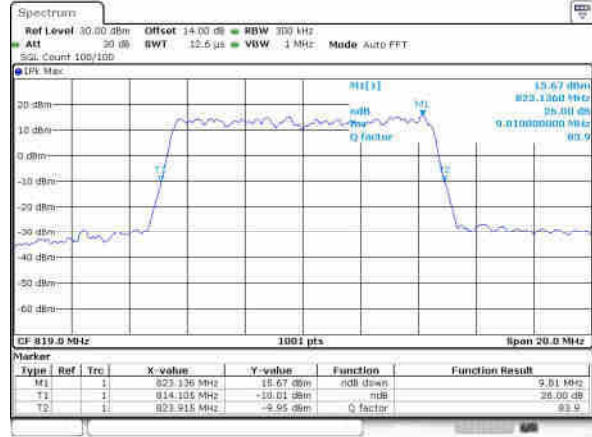

Date: 8\_APR\_2017 16:16:33

Lowest Channel / 15MHz / QPSK

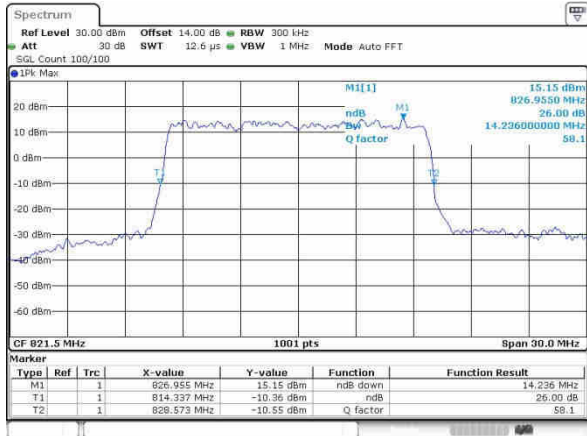

Date: 15\_MAY\_2017 10:53:08

Lowest Channel / 15MHz / 16QAM

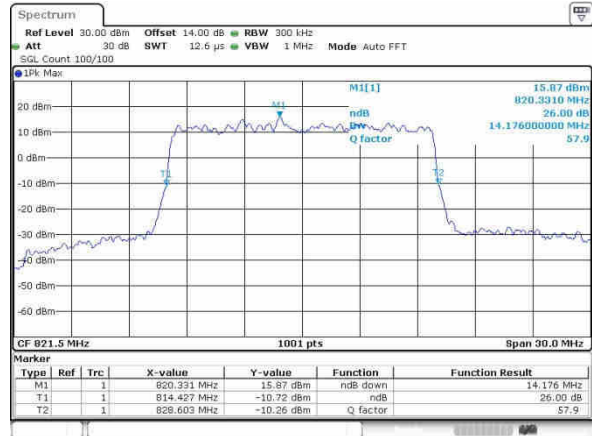

Date: 15\_MAY\_2017 10:52:58





LTE Band 26

Lowest Channel / 1.4MHz / 64QAM

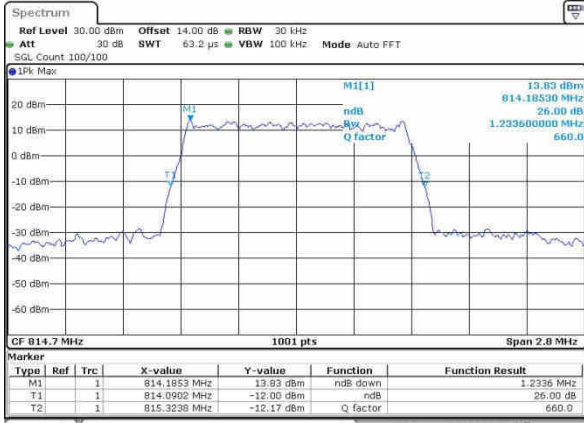

Date: 30.MAY.2017 16:04:33

Lowest Channel / 3MHz / 64QAM

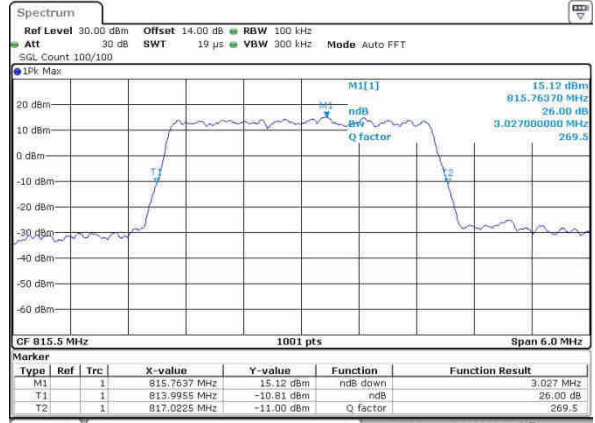

Date: 30.MAY.2017 16:16:11

Middle Channel / 1.4MHz / 64QAM

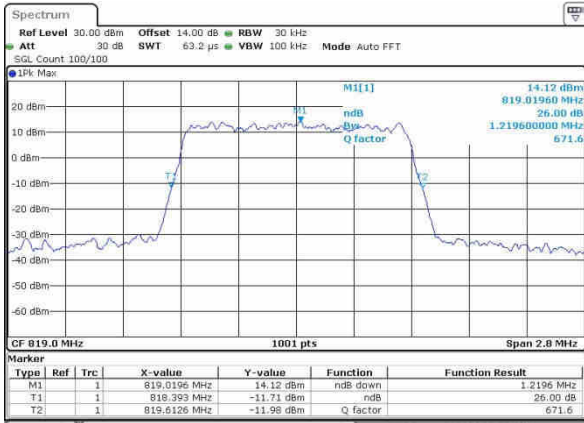

Date: 30.MAY.2017 16:13:24

Middle Channel / 3MHz / 64QAM

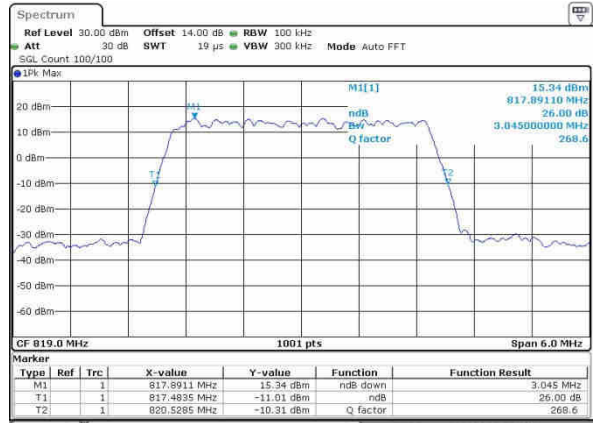

Date: 30.MAY.2017 16:18:55

Highest Channel / 1.4MHz / 64QAM

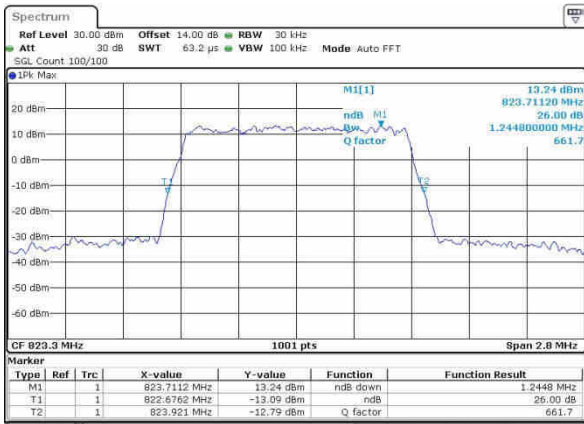

Date: 30.MAY.2017 16:13:55

Highest Channel / 3MHz / 64QAM

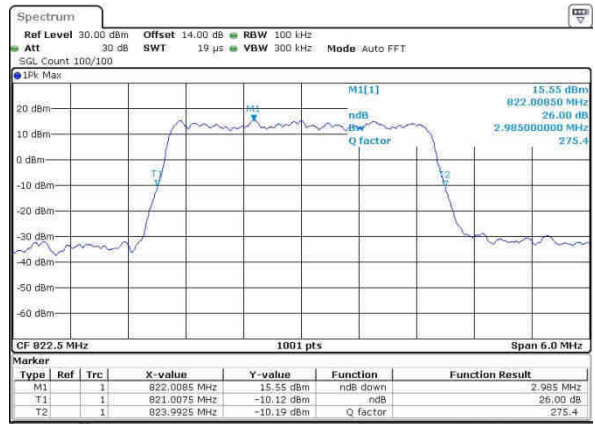

Date: 30.MAY.2017 16:19:16



LTE Band 26

Lowest Channel / 5MHz / 64QAM

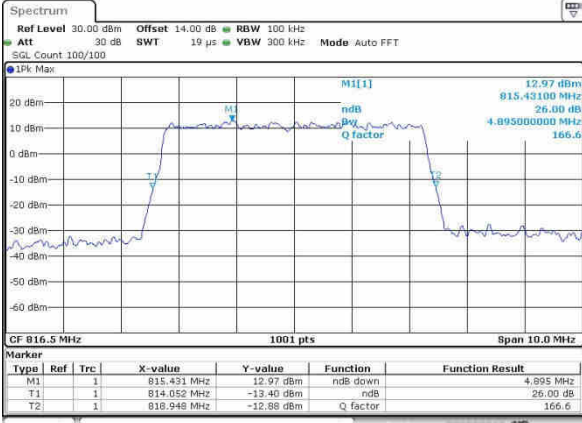

Date: 30.MAY.2017 16:21:26

Middle Channel / 10MHz / 64QAM

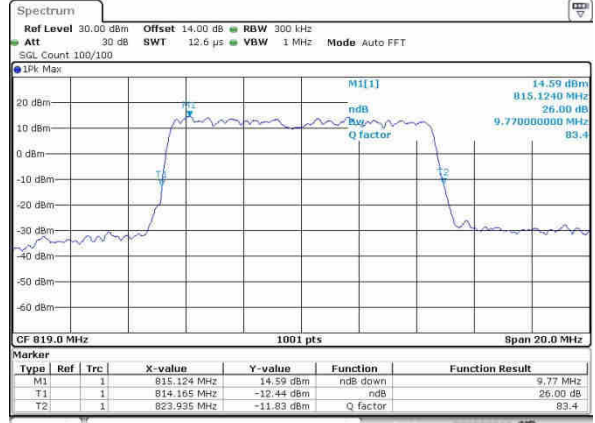

Date: 30.MAY.2017 16:31:18

Middle Channel / 5MHz / 64QAM

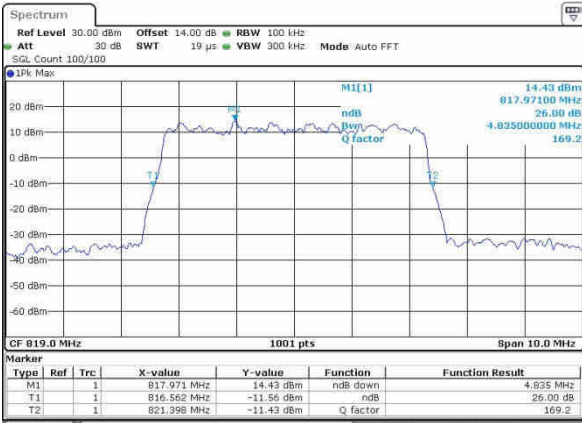

Date: 30.MAY.2017 16:28:15

Lowest Channel / 15MHz / 64QAM

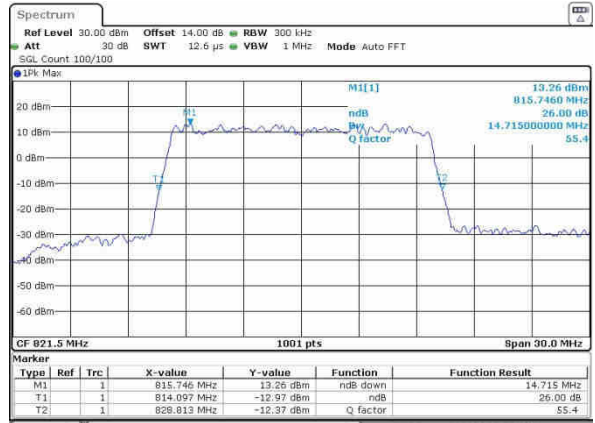

Date: 30.MAY.2017 16:45:44

Highest Channel / 5MHz / 64QAM

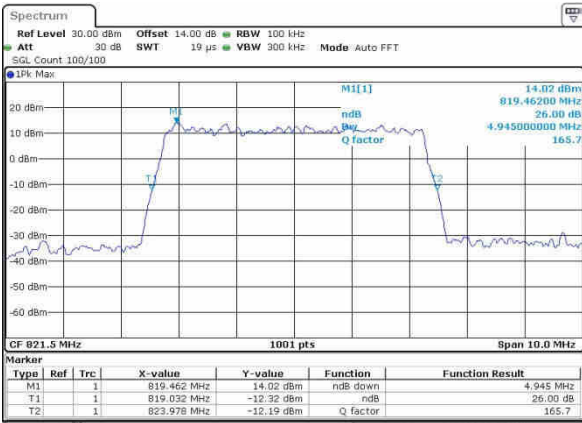

Date: 30.MAY.2017 16:28:50



### Occupied Bandwidth

Mode	LTE Band 26 : 99%OBW(MHz)											
BW	1.4MHz		3MHz		5MHz		10MHz		15MHz		20MHz	
Mod.	QPSK	16QAM	QPSK	16QAM	QPSK	16QAM	QPSK	16QAM	QPSK	16QAM	QPSK	16QAM
Lowest CH	1.1	1.1	2.72	2.7	4.48	4.48	-	-	13.457	13.427	-	-
Middle CH	1.09	1.1	2.75	2.72	4.48	4.48	9.13	9.03	-	-	-	-
Highest CH	1.09	1.08	2.71	2.72	4.47	4.48	-	-	-	-	-	-
BW	1.4MHz	3MHz	5MHz	10MHz	15MHz	20MHz						
Mod.	64QAM	64QAM	64QAM	64QAM	64QAM	64QAM						
Lowest CH	1.09	2.75	4.47	-	13.43							
Middle CH	1.09	2.72	4.49	8.95	-	-						
Highest CH	1.08	2.73	4.48	-	-	-						



LTE Band 26

Lowest Channel / 1.4MHz / QPSK

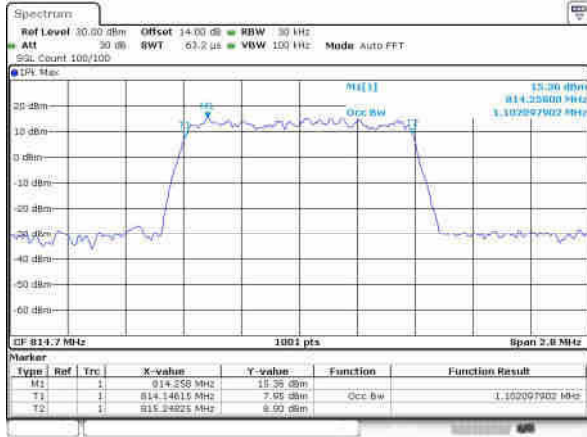

Date: 6-APR-2017 15:23:18

Lowest Channel / 1.4MHz / 16QAM

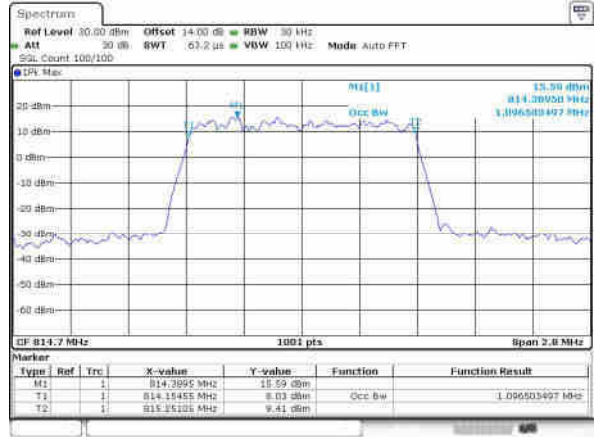

Date: 6-APR-2017 15:23:22

Middle Channel / 1.4MHz / QPSK

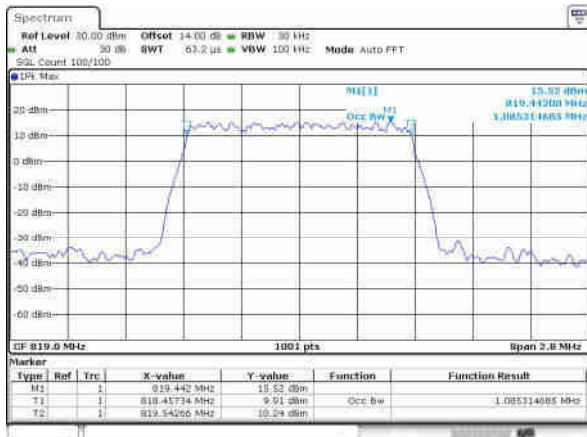

Date: 6-APR-2017 15:23:17

Middle Channel / 1.4MHz / 16QAM

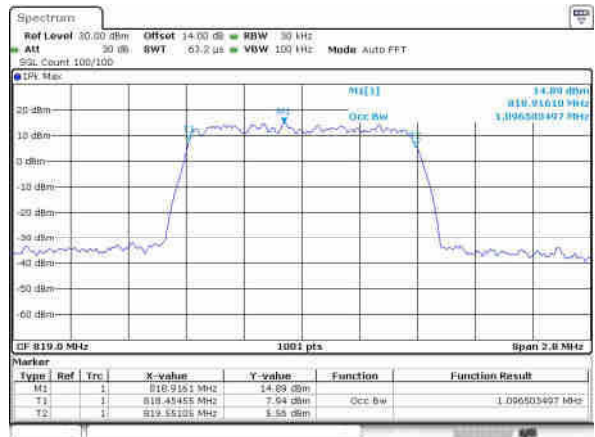

Date: 6-APR-2017 15:23:18

Highest Channel / 1.4MHz / QPSK

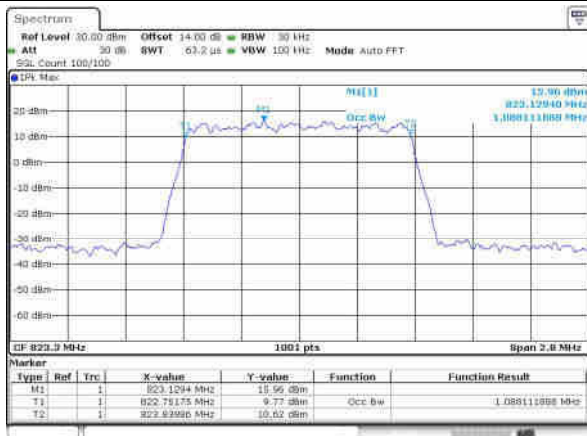

Date: 6-APR-2017 15:23:16

Highest Channel / 1.4MHz / 16QAM

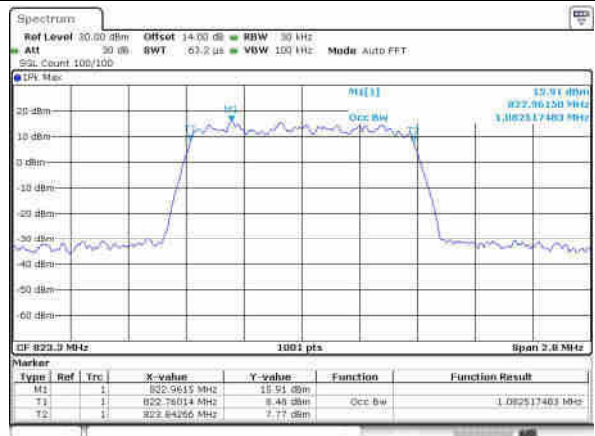

Date: 6-APR-2017 15:23:17





LTE Band 26

Lowest Channel / 3MHz / QPSK

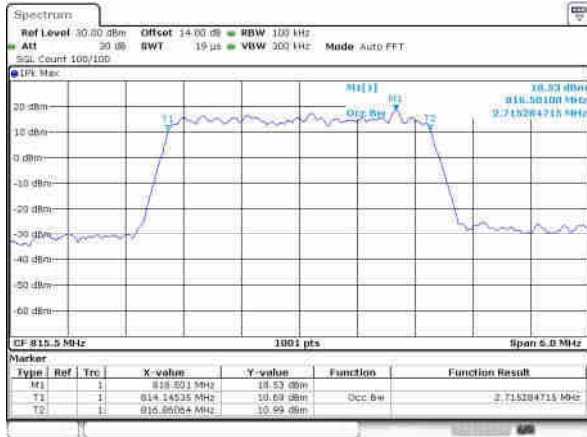

DATE: 6\_APR\_2017 15:34:14

Lowest Channel / 3MHz / 16QAM

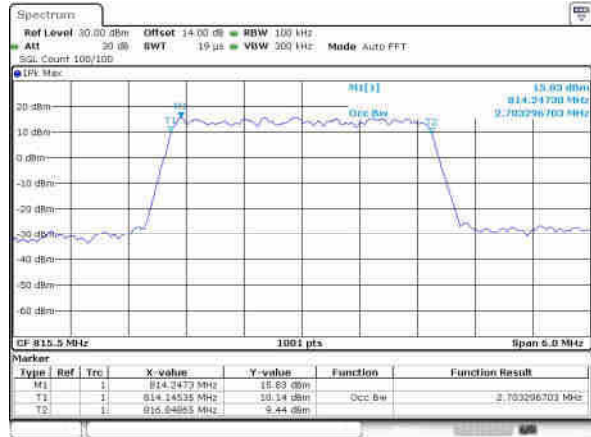

DATE: 6\_APR\_2017 15:34:15

Middle Channel / 3MHz / QPSK

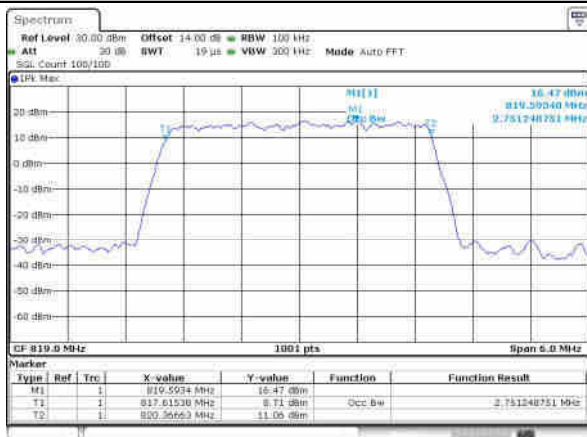

DATE: 6\_APR\_2017 15:34:16

Middle Channel / 3MHz / 16QAM

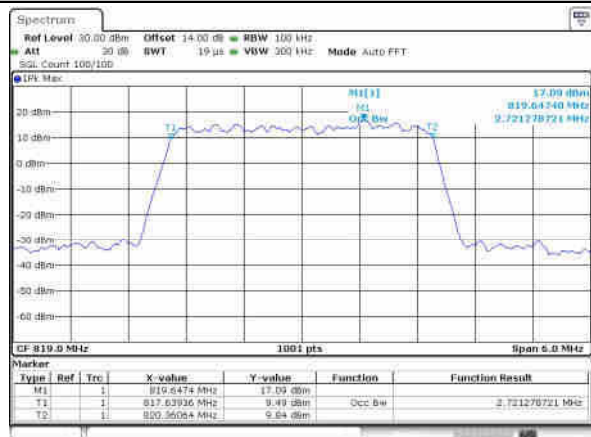

DATE: 6\_APR\_2017 15:34:16

Highest Channel / 3MHz / QPSK

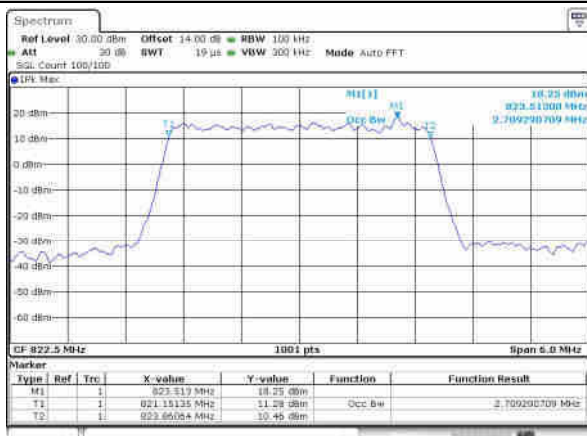

DATE: 6\_APR\_2017 15:35:19

Highest Channel / 3MHz / 16QAM

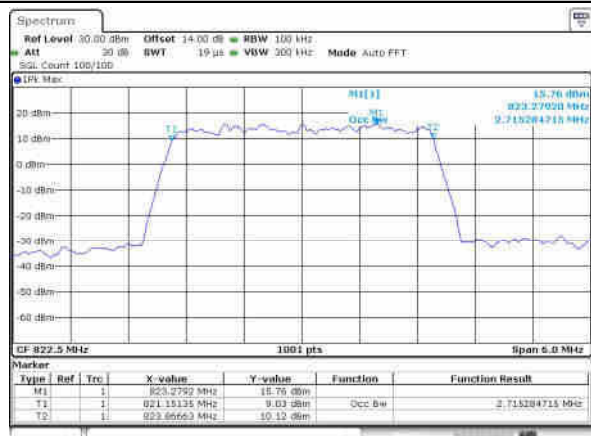

DATE: 6\_APR\_2017 15:35:19



LTE Band 26

Lowest Channel / 5MHz / QPSK

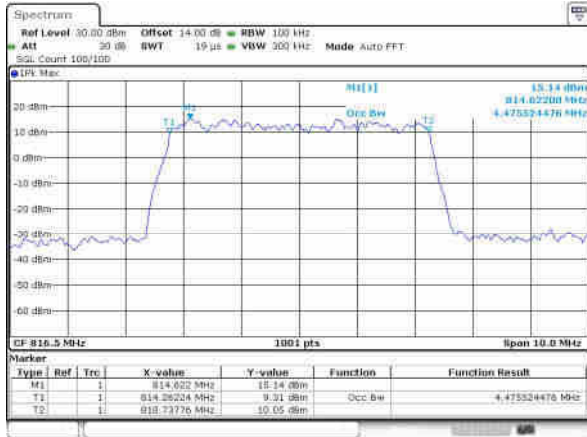

DATE: 6\_APR\_2017 15:54:29

Lowest Channel / 5MHz / 16QAM

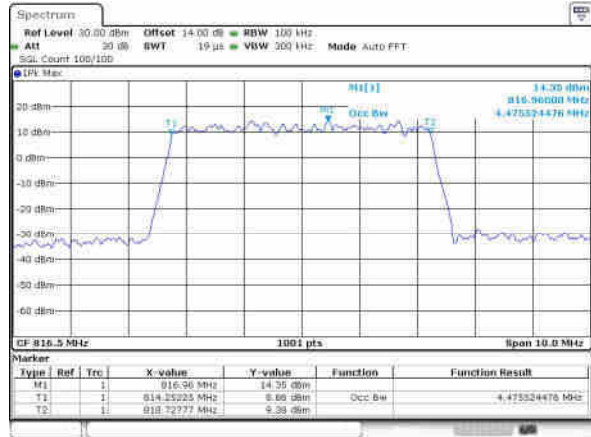

DATE: 6\_APR\_2017 15:54:29

Middle Channel / 5MHz / QPSK

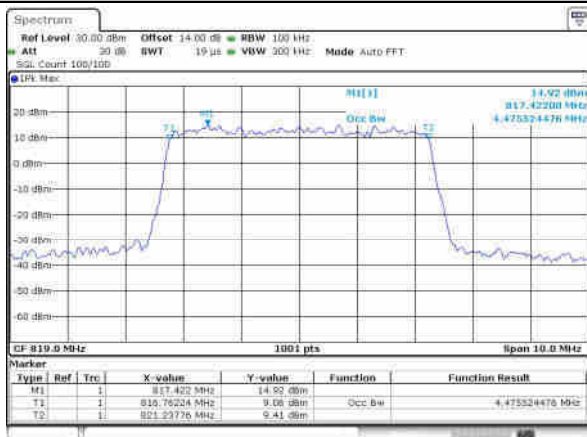

DATE: 6\_APR\_2017 16:05:14

Middle Channel / 5MHz / 16QAM

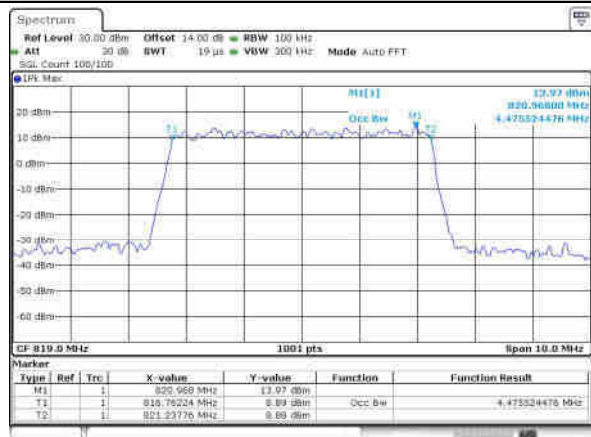

DATE: 6\_APR\_2017 16:05:14

Highest Channel / 5MHz / QPSK

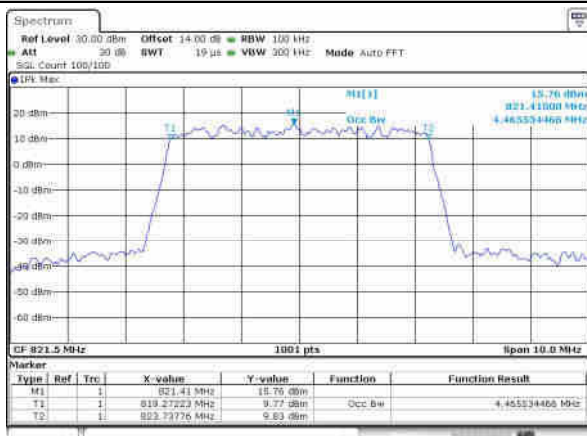

DATE: 6\_APR\_2017 16:06:33

Highest Channel / 5MHz / 16QAM

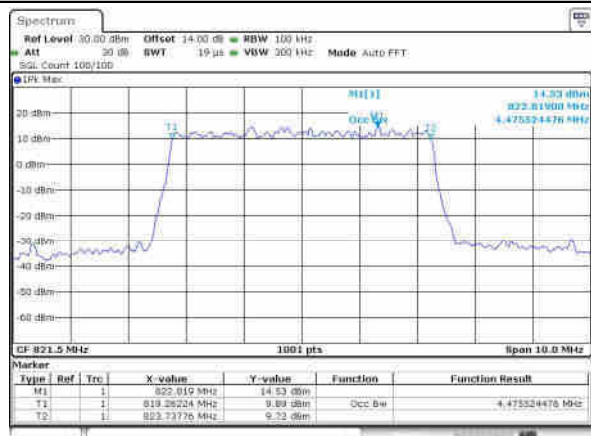

DATE: 6\_APR\_2017 16:06:34



LTE Band 26

Middle Channel / 10MHz / QPSK

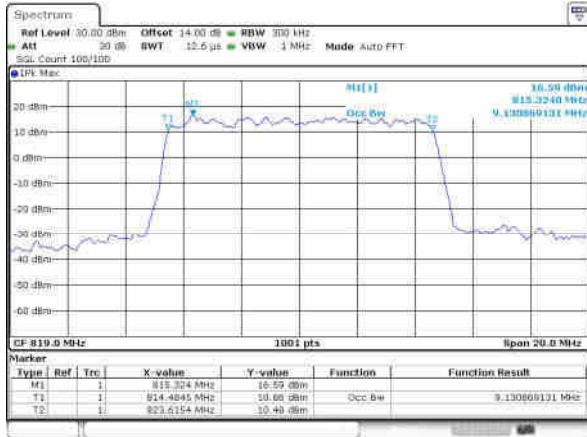

Date: 8\_APR\_2017 16:18:00

Middle Channel / 10MHz / 16QAM

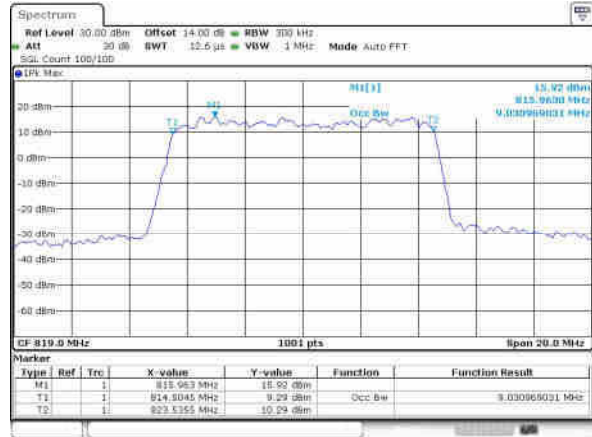

Date: 8\_APR\_2017 16:18:01

LTE Band 26

Lowest Channel / 15MHz / QPSK

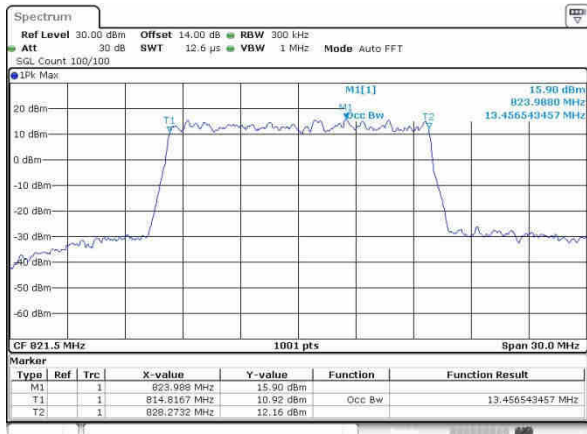

Date: 15\_MAY\_2017 10:52:37

Lowest Channel / 15MHz / 16QAM

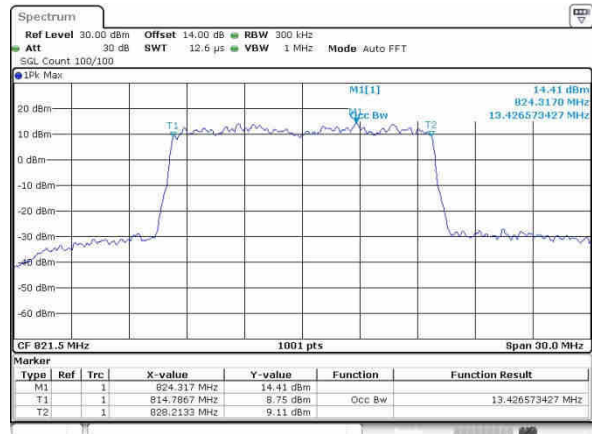

Date: 15\_MAY\_2017 10:52:47



LTE Band 26

Lowest Channel / 1.4MHz / 64QAM

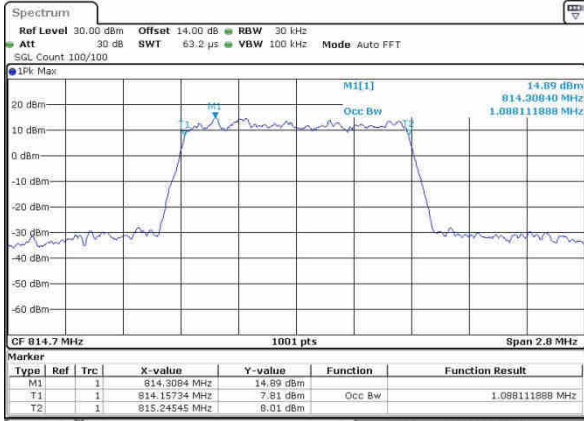

Date: 30.MAY.2017 16:04:12

Lowest Channel / 3MHz / 64QAM

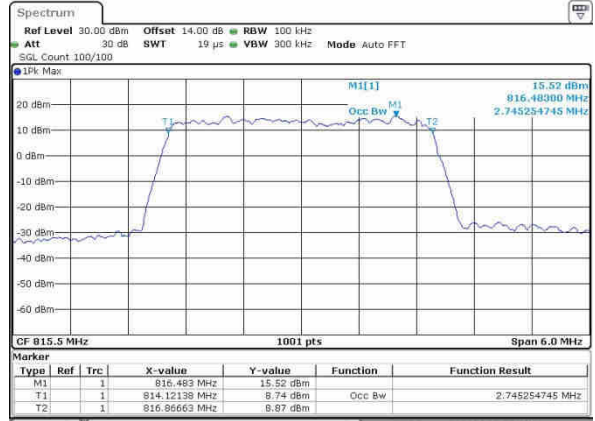

Date: 30.MAY.2017 16:16:04

Middle Channel / 1.4MHz / 64QAM

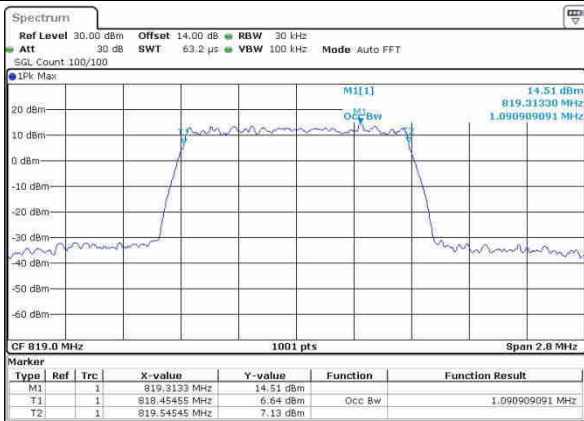

Date: 30.MAY.2017 16:13:17

Middle Channel / 3MHz / 64QAM

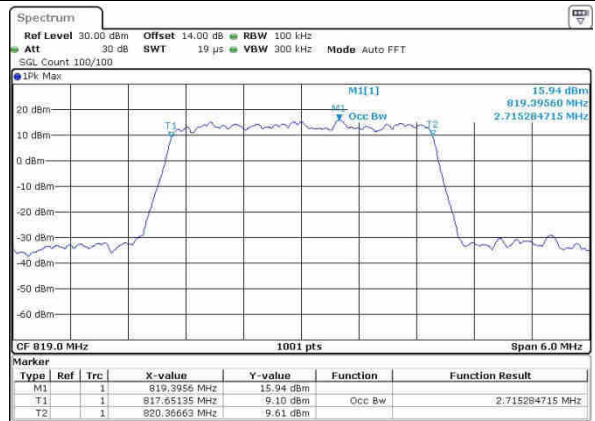

Date: 30.MAY.2017 16:18:42

Highest Channel / 1.4MHz / 64QAM

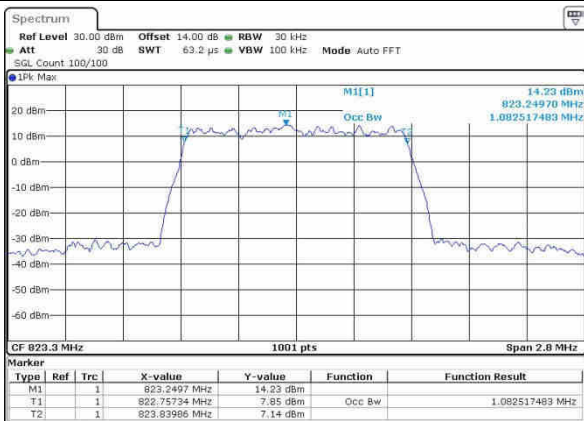

Date: 30.MAY.2017 16:13:46

Highest Channel / 3MHz / 64QAM

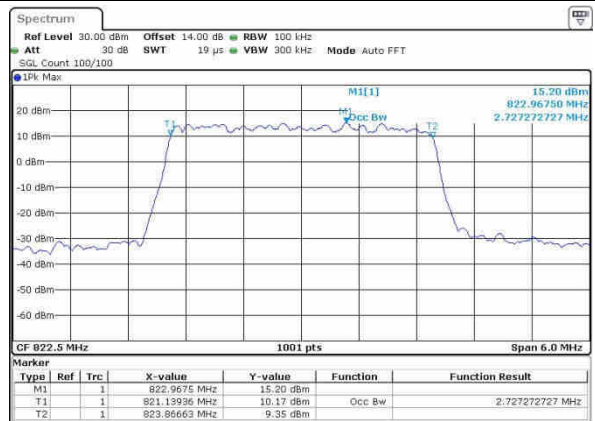

Date: 30.MAY.2017 16:19:06



LTE Band 26

Lowest Channel / 5MHz / 64QAM

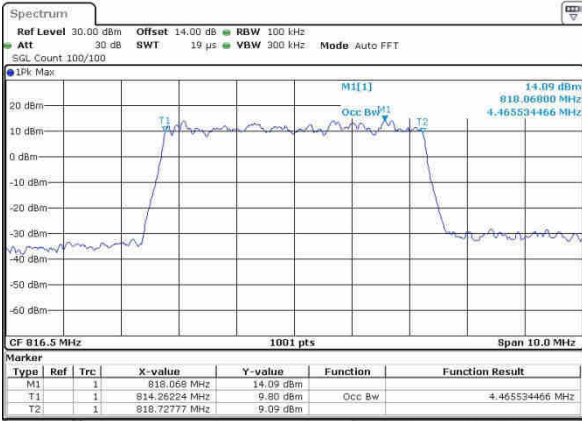

Date: 30.MAY.2017 16:21:20

Middle Channel / 10MHz / 64QAM

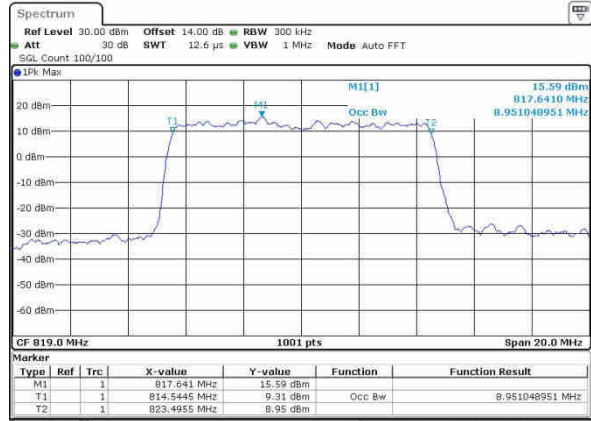

Date: 30.MAY.2017 16:31:50

Middle Channel / 5MHz / 64QAM

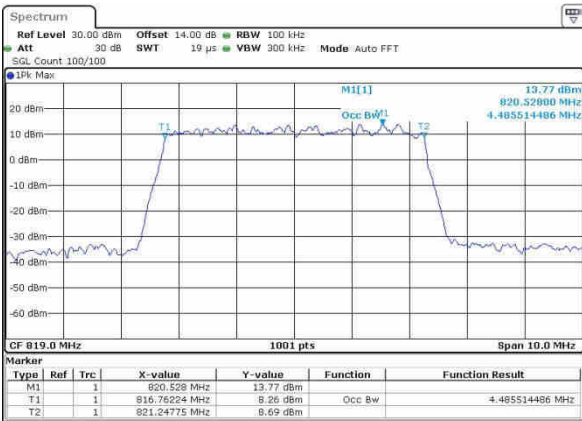

Date: 30.MAY.2017 16:28:08

Lowest Channel / 15MHz / 64QAM

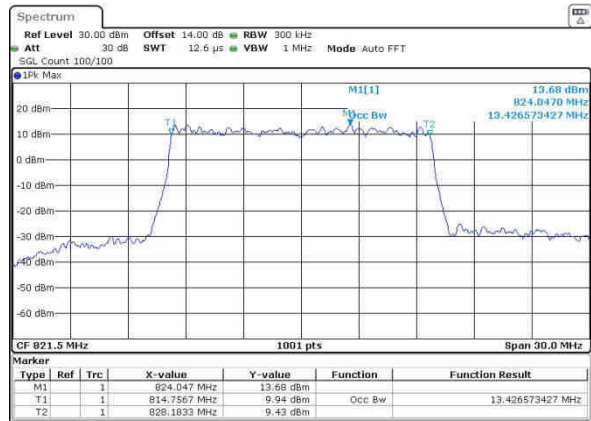

Date: 30.MAY.2017 16:45:30

Highest Channel / 5MHz / 64QAM

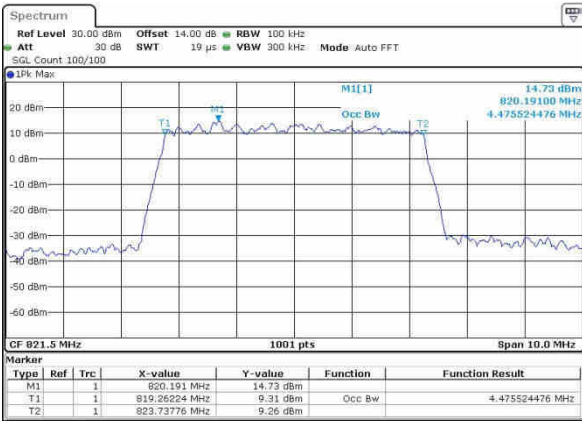

Date: 30.MAY.2017 16:28:48





# Conducted Band Edge

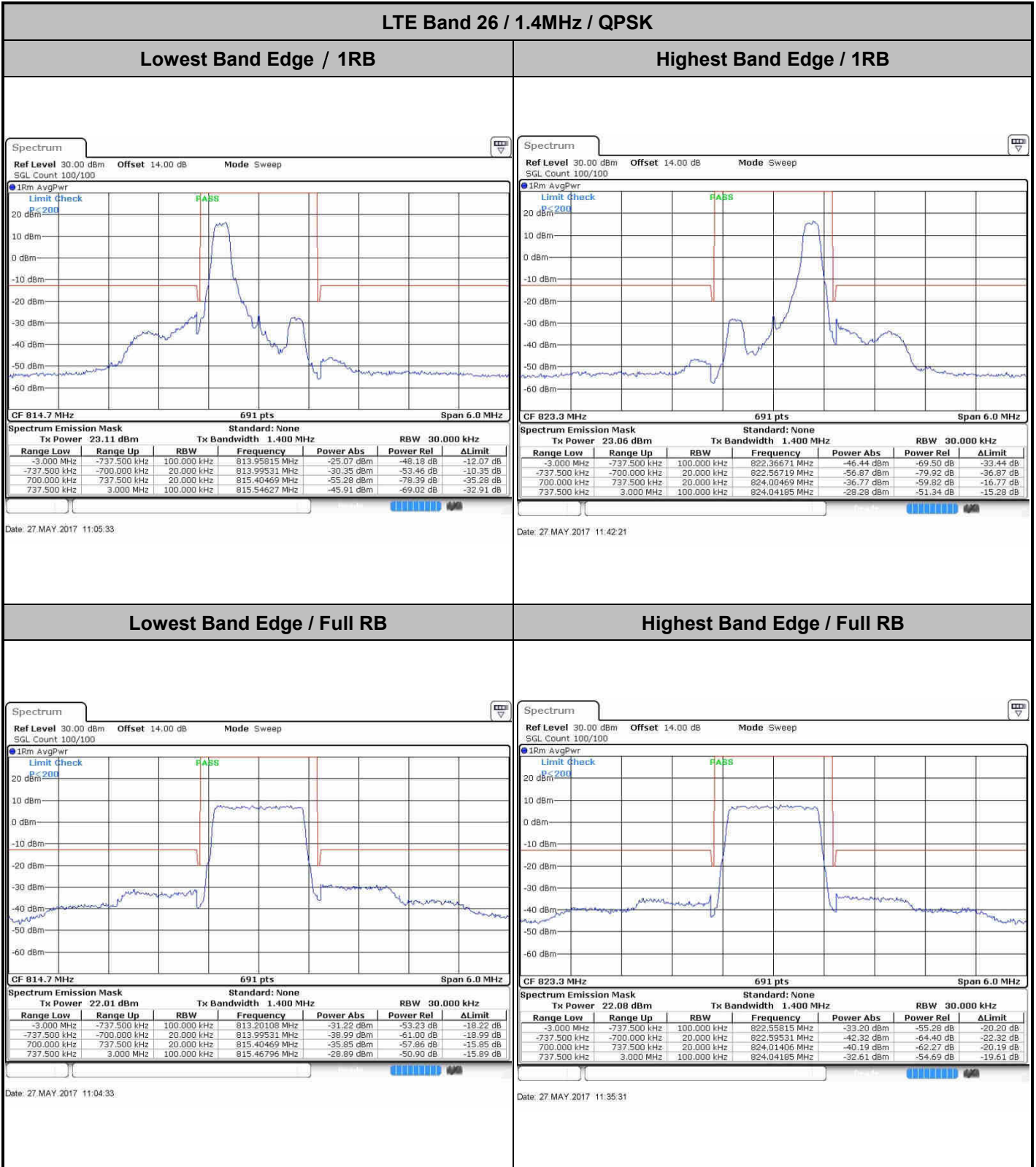



LTE Band 26 / 1.4MHz / 16QAM

Lowest Band Edge / 1 RB

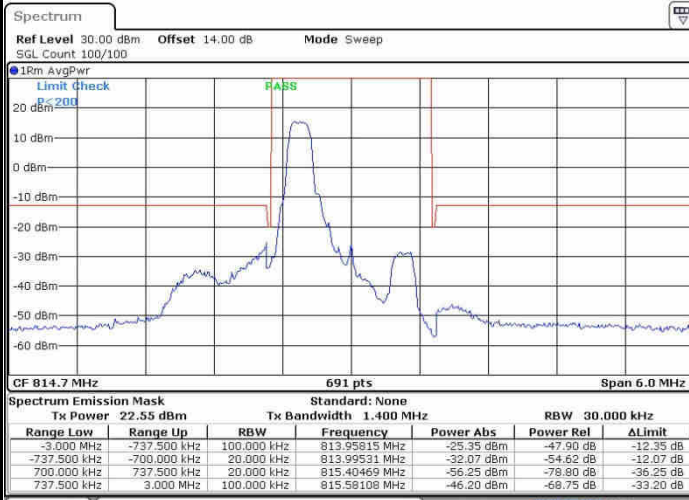

Date: 27 MAY 2017 11:05:13

Highest Band Edge / 1 RB

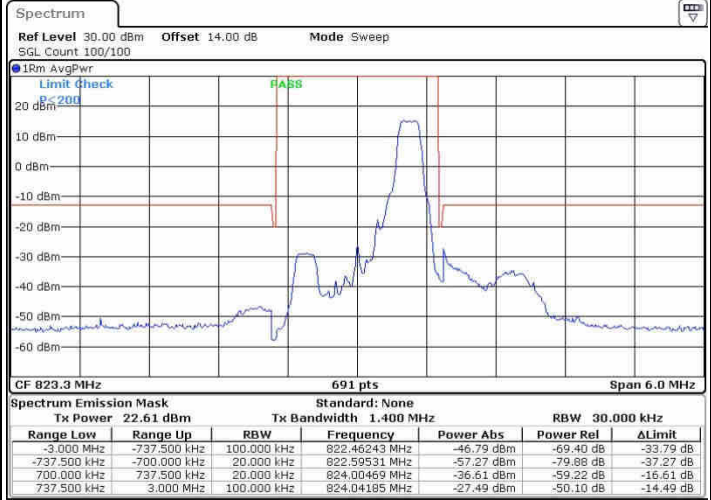

Date: 27 MAY 2017 11:42:40

Lowest Band Edge / Full RB

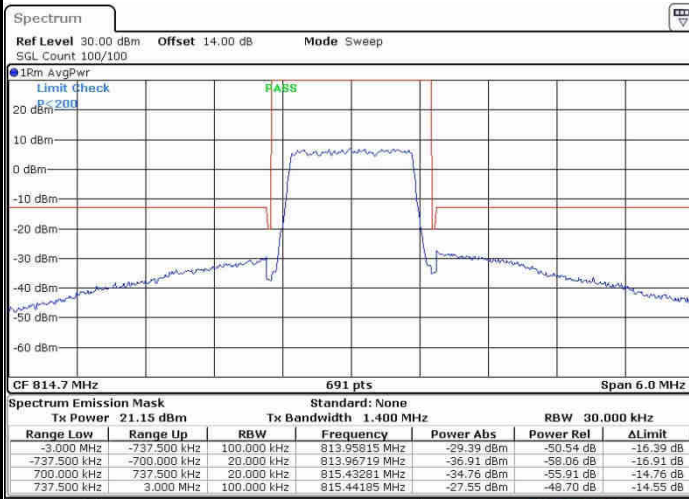

Date: 27 MAY 2017 11:04:57

Highest Band Edge / Full RB

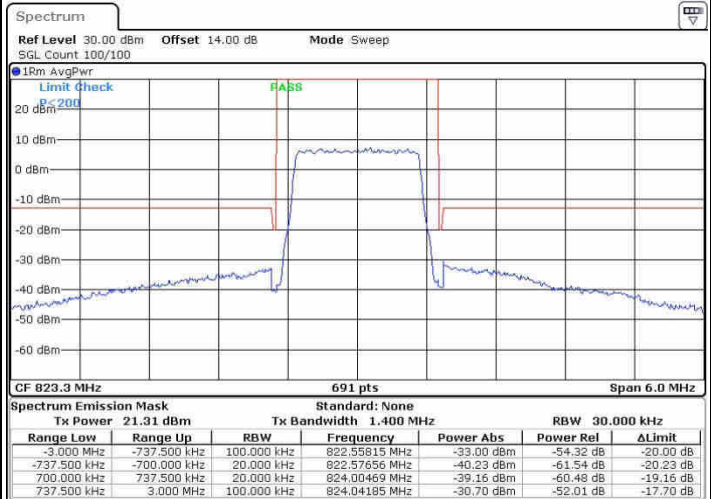

Date: 27 MAY 2017 11:36:34



LTE Band 26 / 3MHz / QPSK

Lowest Band Edge / 1RB

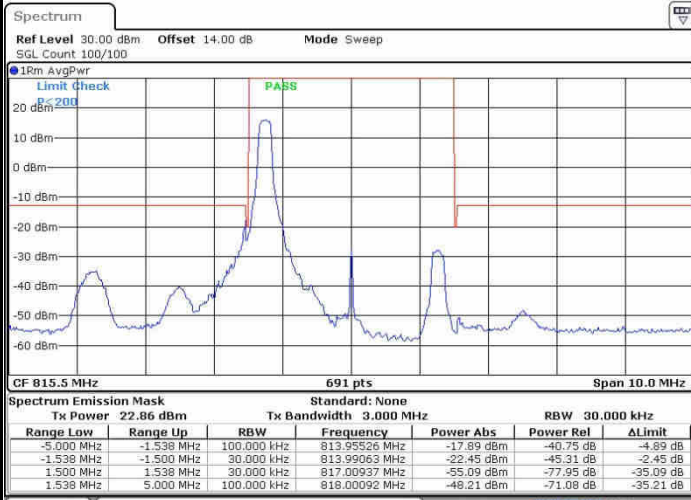

Date: 27 MAY 2017 11:18:15

Highest Band Edge / 1 RB

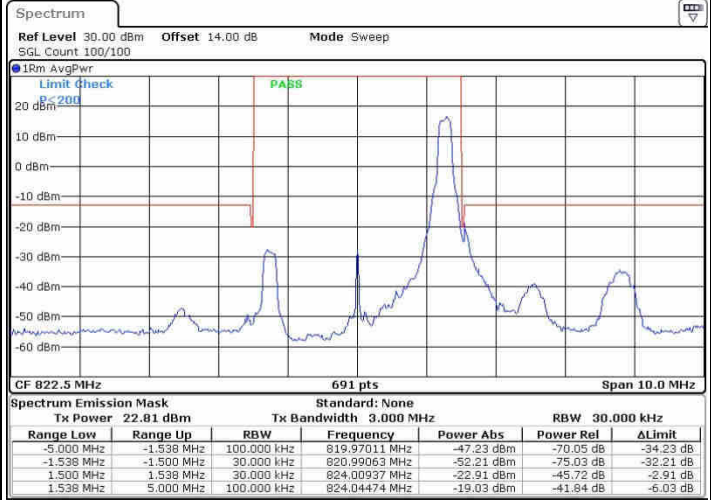

Date: 27 MAY 2017 11:45:41

Lowest Band Edge / Full RB



Date: 27 MAY 2017 11:17:52

Highest Band Edge / Full RB

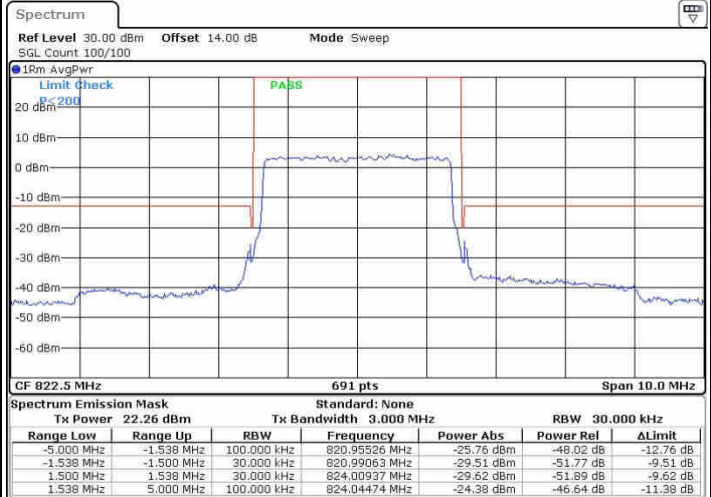

Date: 27 MAY 2017 11:46:00





LTE Band 26 / 3MHz / 16QAM

Lowest Band Edge / 1 RB

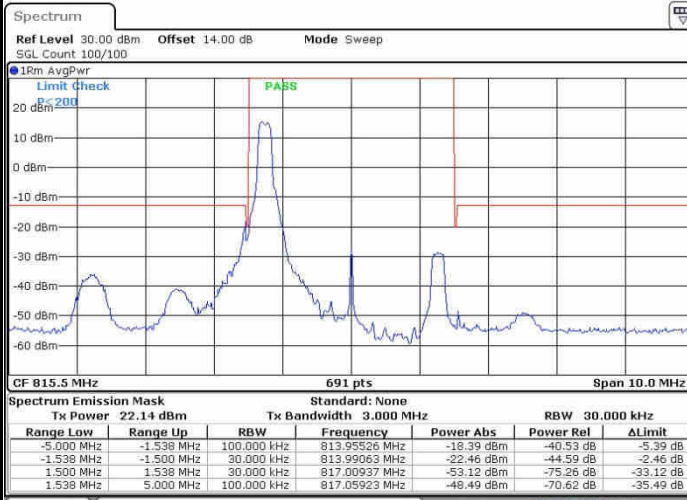

Date: 27 MAY 2017 11:18:35

Highest Band Edge / 1 RB

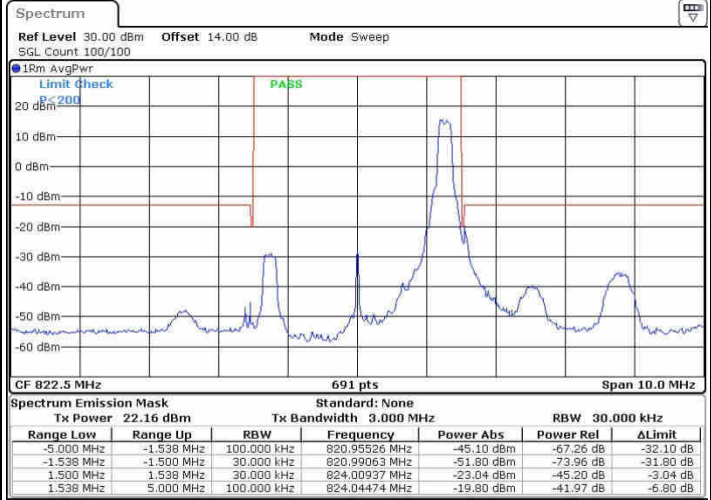

Date: 27 MAY 2017 11:44:45

Lowest Band Edge / Full RB

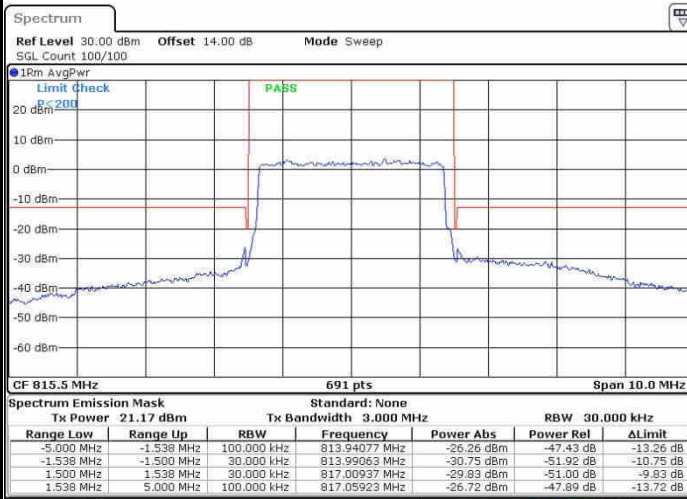

Date: 27 MAY 2017 11:17:02

Highest Band Edge / Full RB

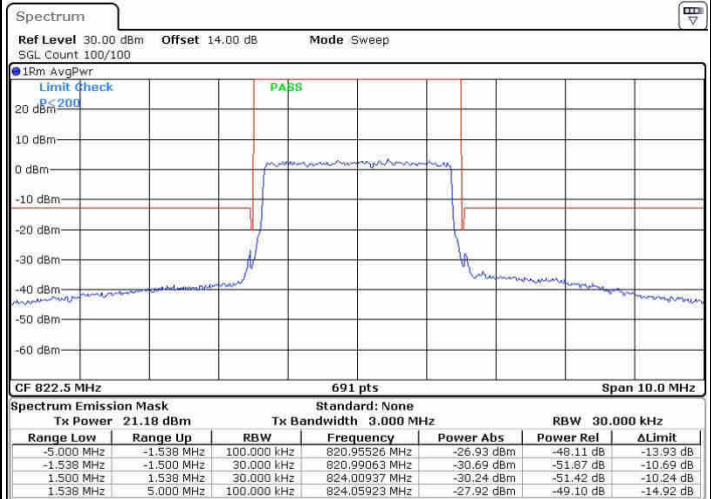

Date: 27 MAY 2017 11:46:25



LTE Band 26 / 5MHz / QPSK

Lowest Band Edge / 1 RB

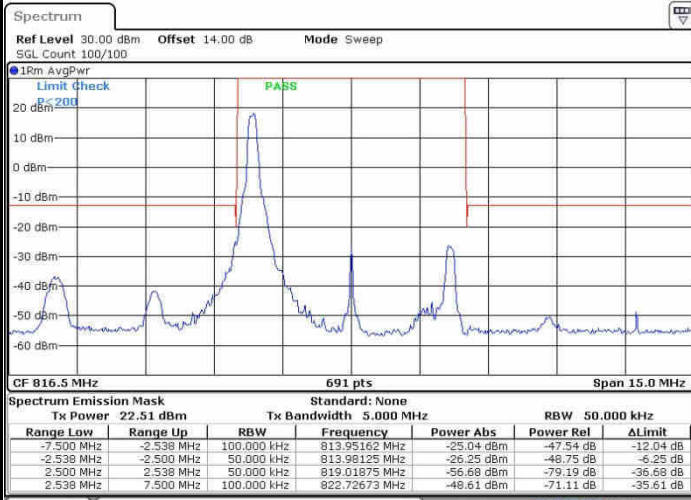

Date: 27 MAY 2017 11:22:02

Highest Band Edge / 1 RB

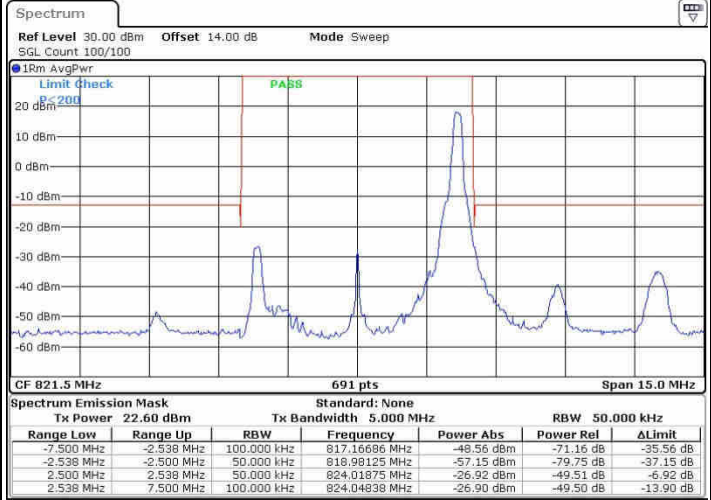

Date: 27 MAY 2017 11:47:27

Lowest Band Edge / Full RB

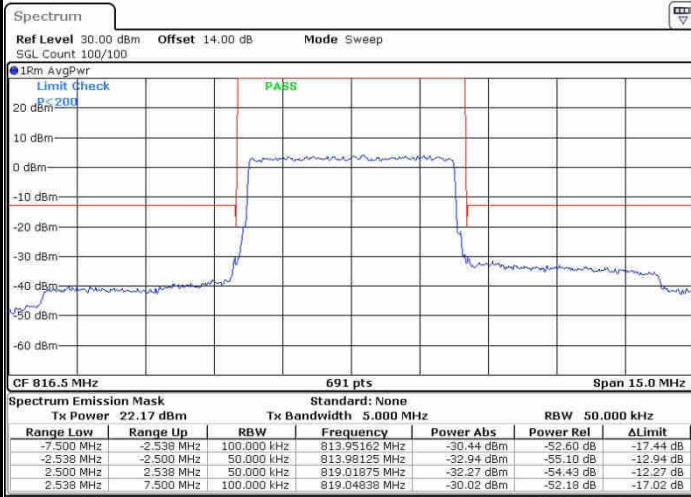

Date: 27 MAY 2017 11:21:32

Highest Band Edge / Full RB

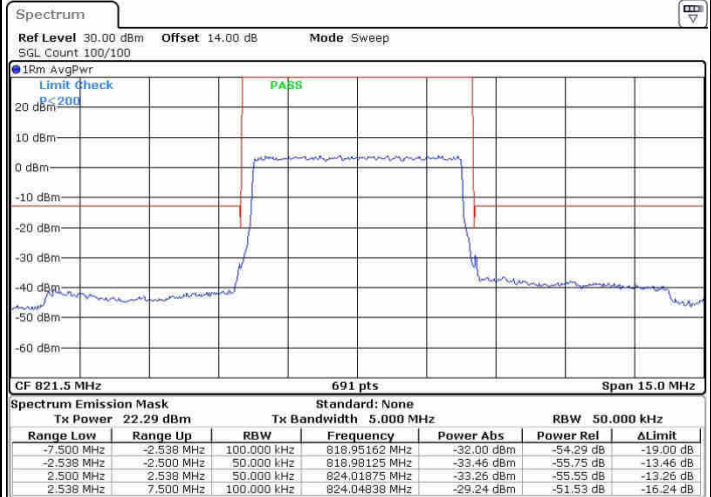

Date: 27 MAY 2017 11:47:04



LTE Band 26 / 5MHz / 16QAM

Lowest Band Edge / 1RB

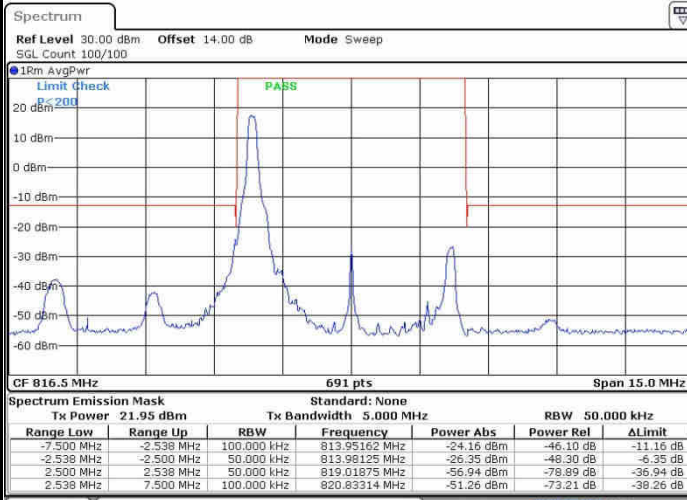

Date: 27 MAY 2017 11:23:15

Highest Band Edge / 1 RB

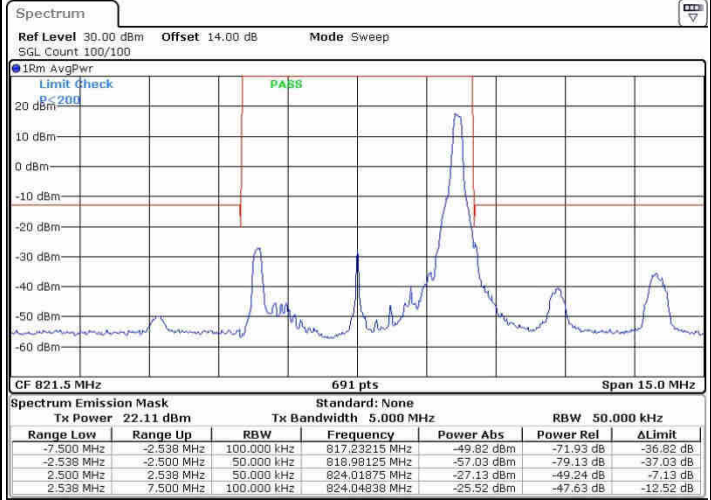

Date: 27 MAY 2017 11:47:45

Lowest Band Edge / Full RB

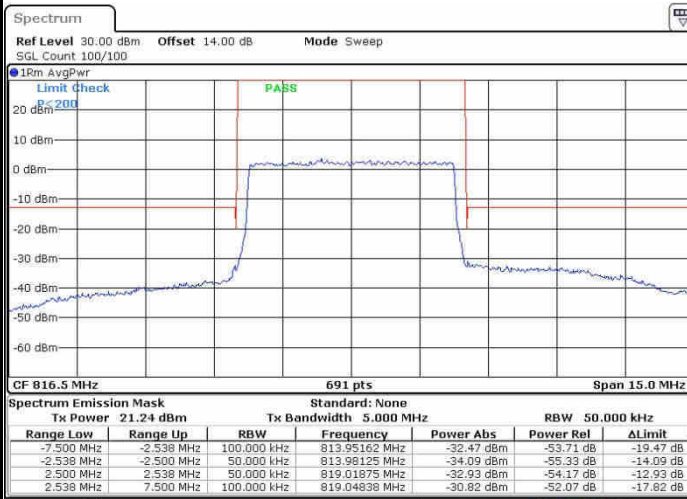

Date: 27 MAY 2017 11:21:14

Highest Band Edge / Full RB

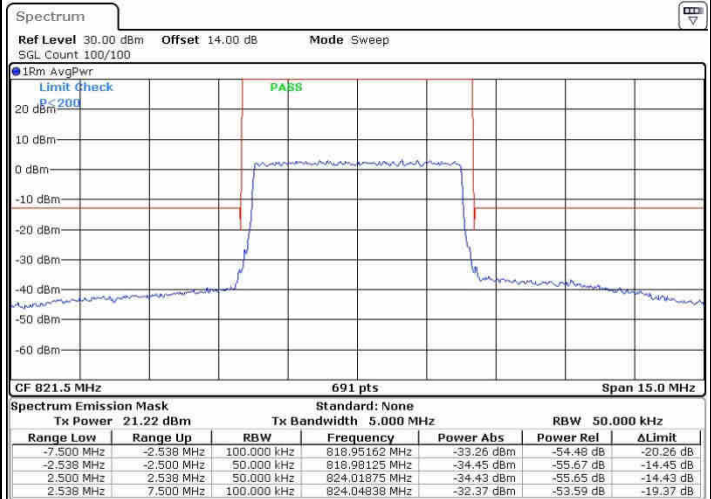

Date: 27 MAY 2017 11:46:47



**LTE Band 26 / 10MHz / QPSK**

**Lowest Band Edge / 1 RB**

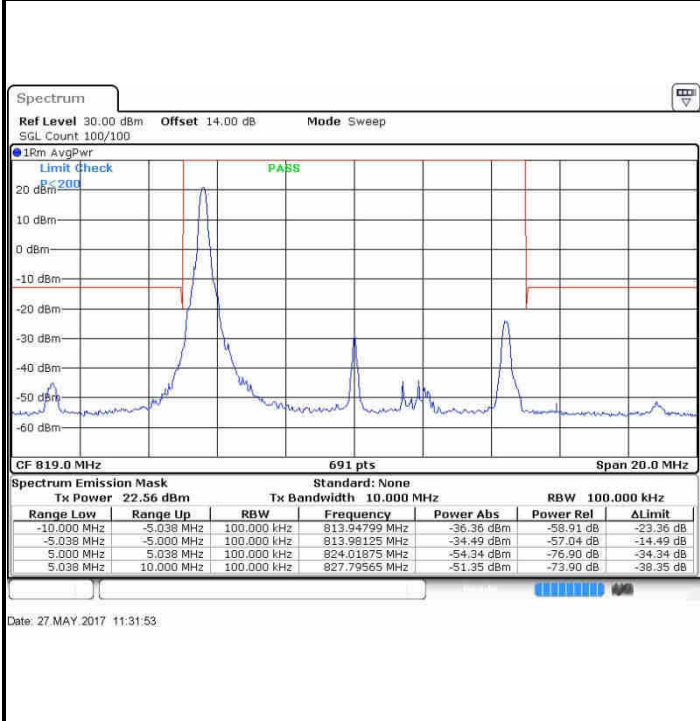

**Highest Band Edge / 1 RB**

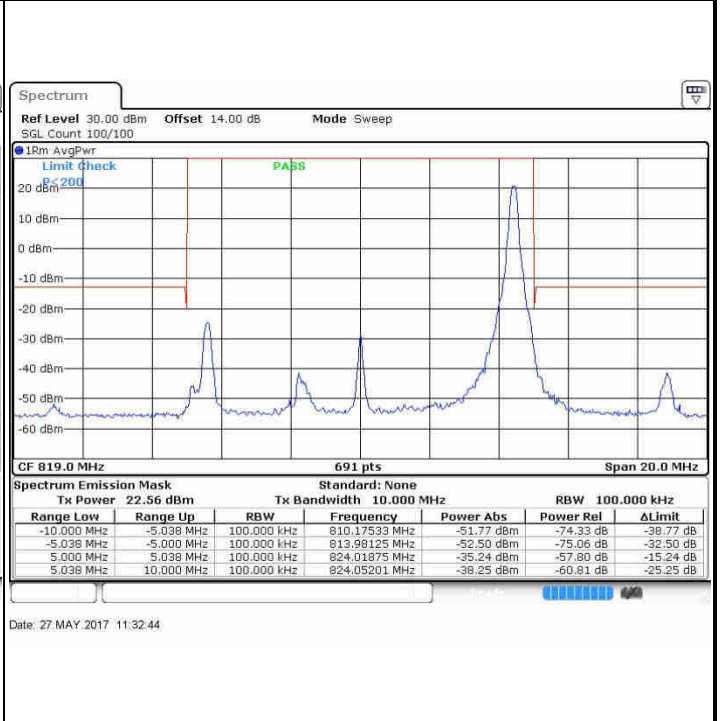

**Band Edge / Full RB**

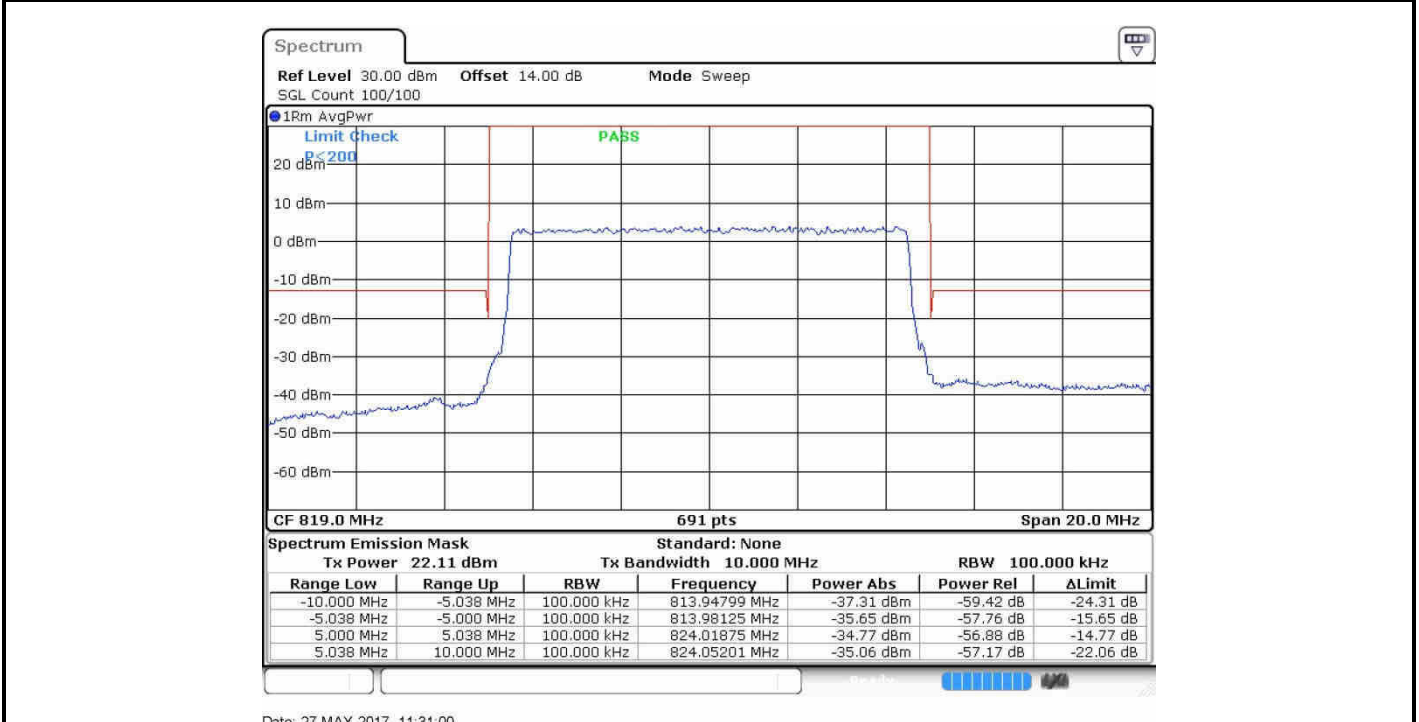





LTE Band 26 / 10MHz / 16QAM

Lowest Band Edge / 1 RB

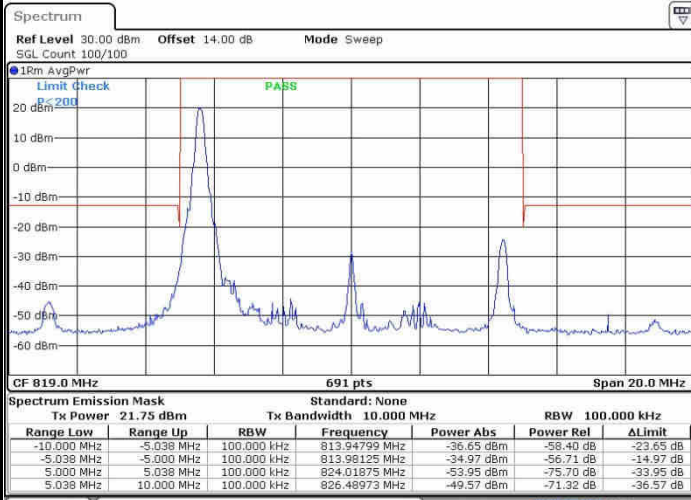

Date: 27 MAY 2017 11:32:09

Highest Band Edge / 1 RB

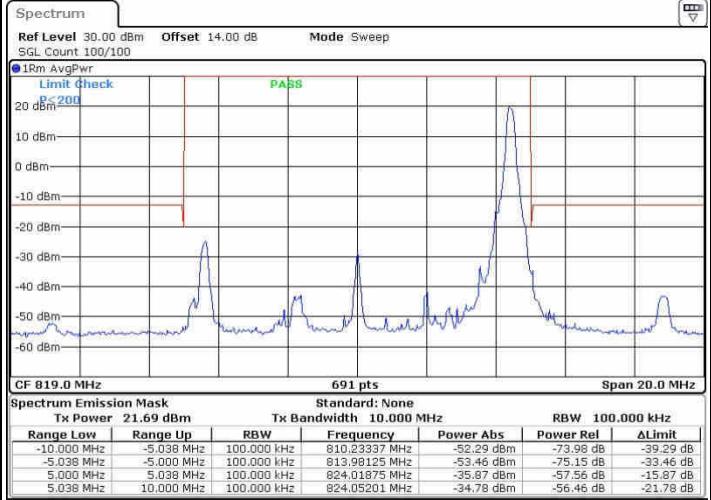

Date: 27 MAY 2017 11:32:26

Band Edge / Full RB

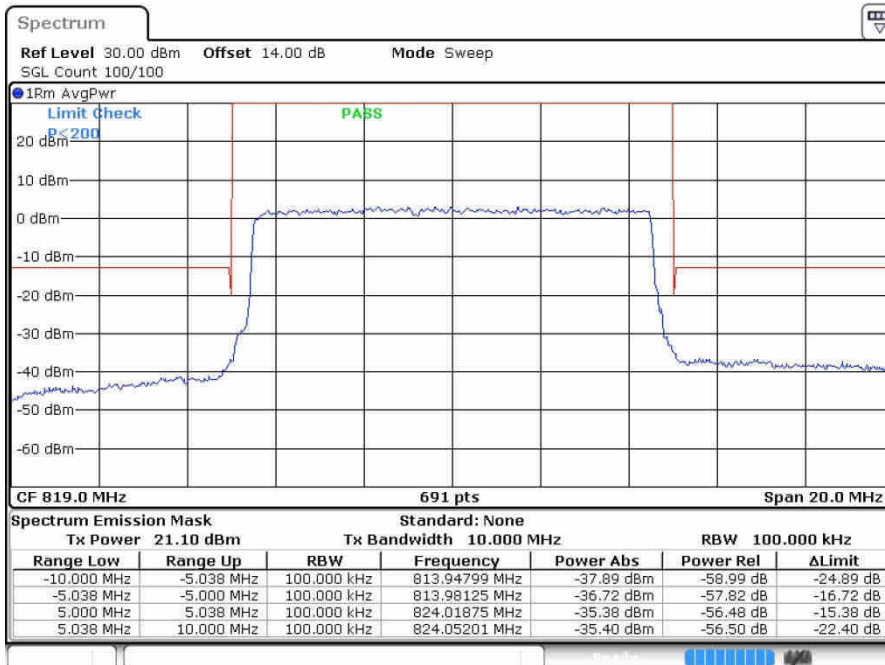

Date: 27 MAY 2017 11:30:43



LTE Band 26 / 15MHz QPSK

Lowest Band Edge / 1 RB

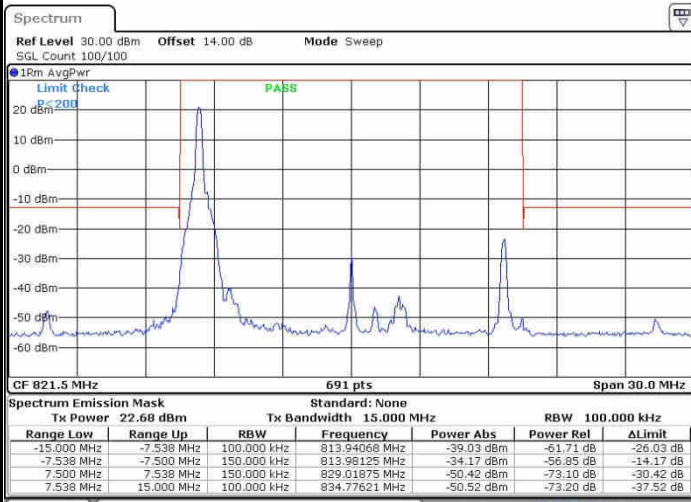

Date: 27.MAY.2017 11:33:38

Lowest Band Edge / Full RB

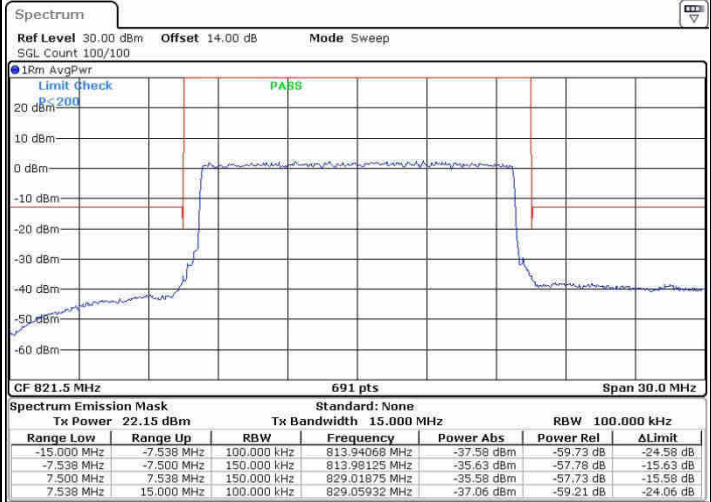

Date: 27.MAY.2017 11:35:09

LTE Band 26 / 15MHz 16QAM

Lowest Band Edge / 1 RB

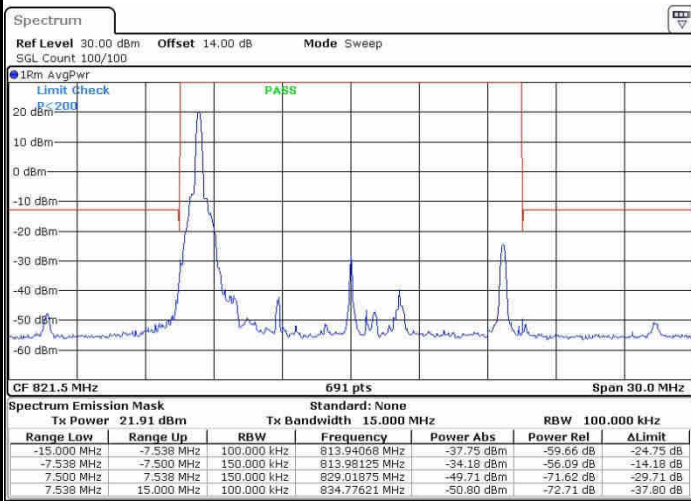

Date: 27.MAY.2017 11:33:58

Lowest Band Edge / Full RB

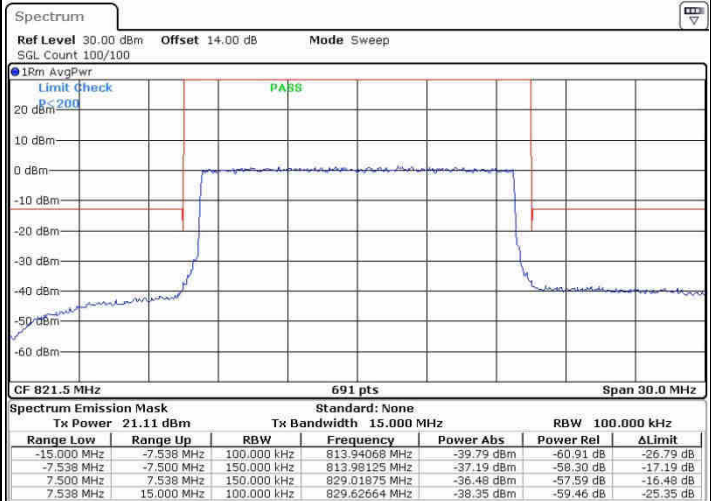

Date: 27.MAY.2017 11:34:27



LTE Band 26 / 1.4MHz / 64QAM

Lowest Band Edge / 1RB

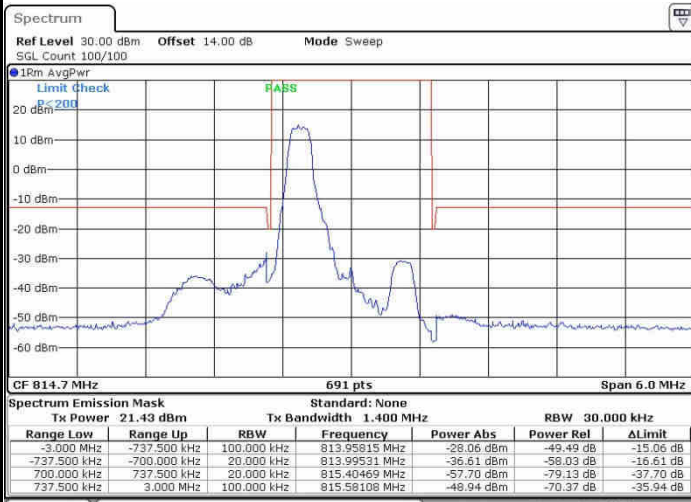

Date: 30.MAY.2017 16:10:12

Highest Band Edge / 1RB

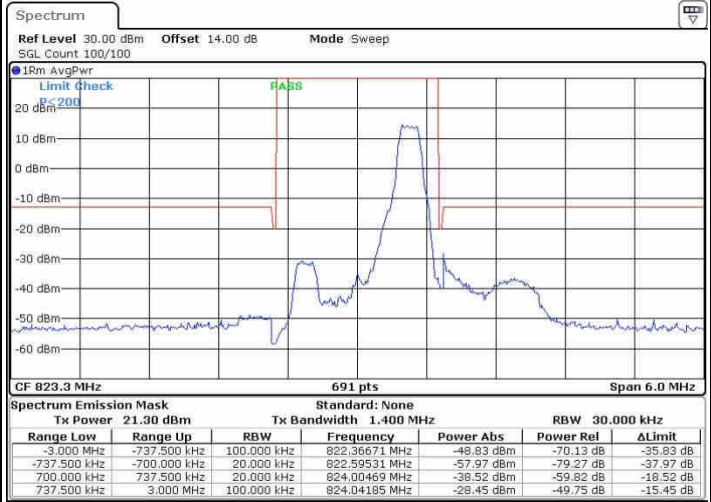

Date: 30.MAY.2017 16:14:36

Lowest Band Edge / Full RB

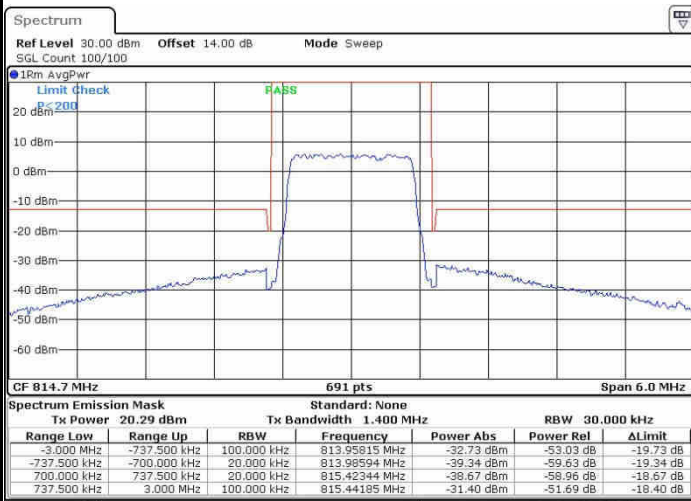

Date: 30.MAY.2017 16:09:42

Highest Band Edge / Full RB

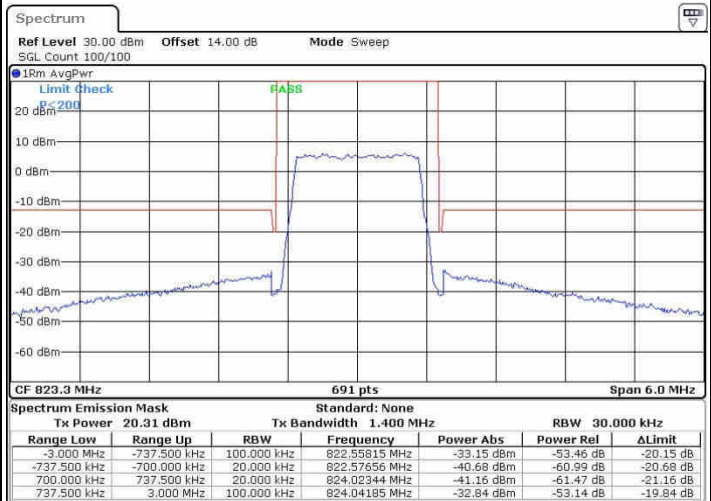

Date: 30.MAY.2017 16:14:07



LTE Band 26 / 3MHz / 64QAM

Lowest Band Edge / 1RB

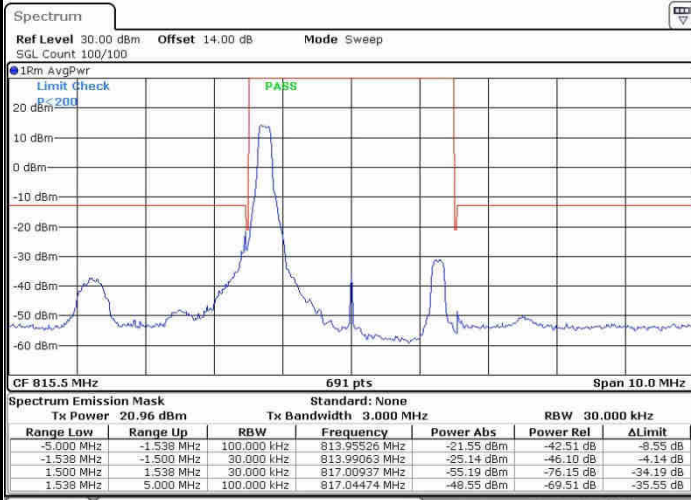

Date: 30.MAY.2017 16:17:22

Highest Band Edge / 1 RB

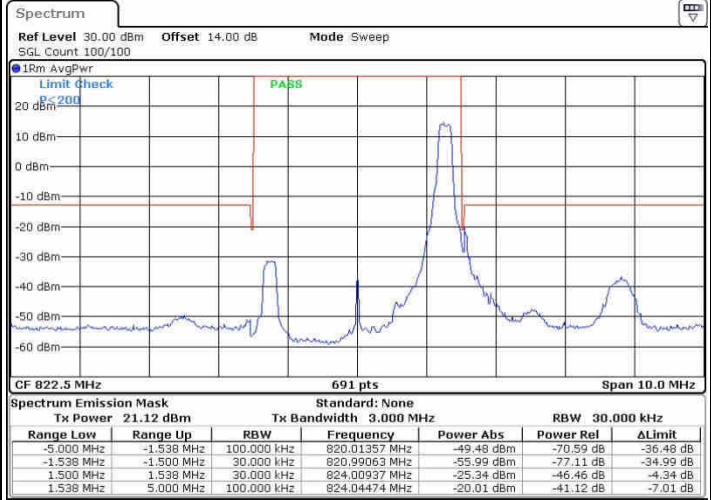

Date: 30.MAY.2017 16:18:59

Lowest Band Edge / Full RB

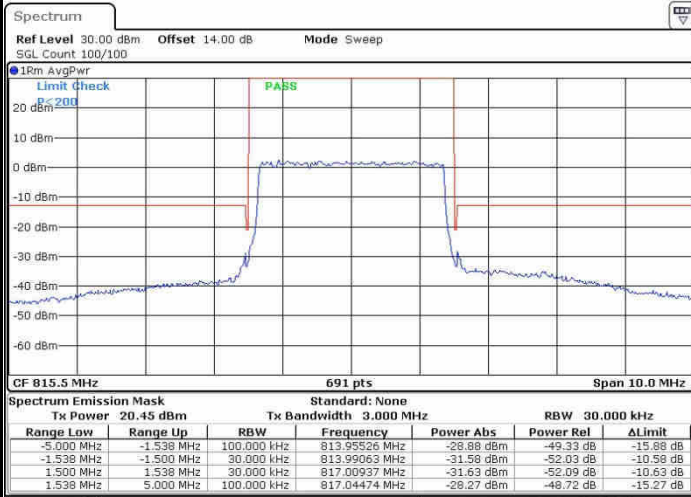

Date: 30.MAY.2017 16:16:27

Highest Band Edge / Full RB

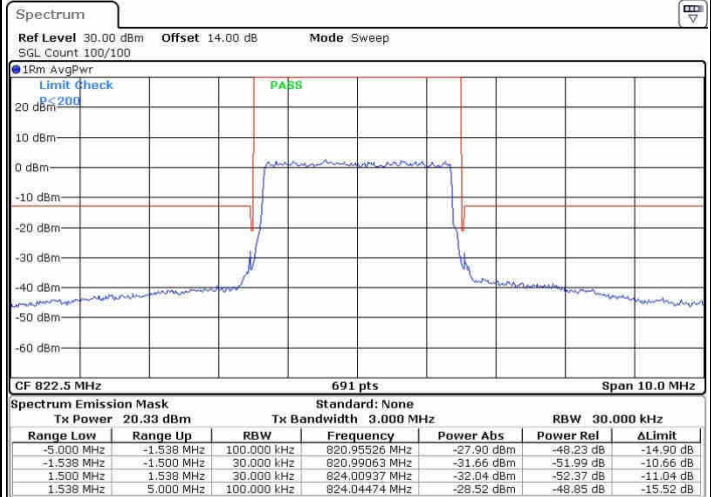

Date: 30.MAY.2017 16:18:34





LTE Band 26 / 5MHz / 64QAM

Lowest Band Edge / 1 RB

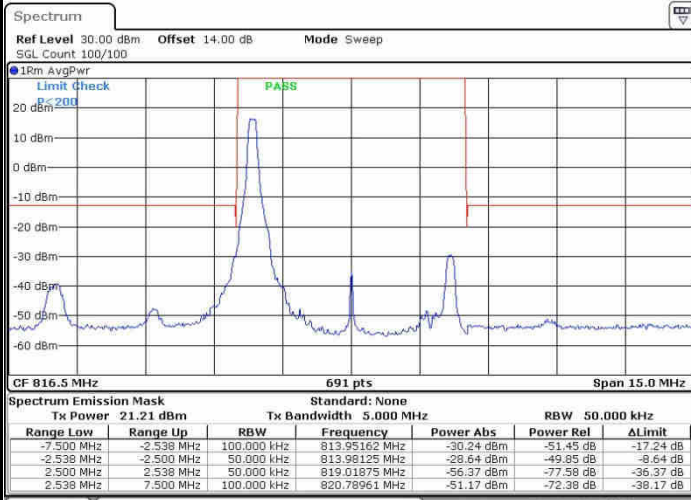

Date: 30.MAY.2017 16:26:12

Highest Band Edge / 1 RB

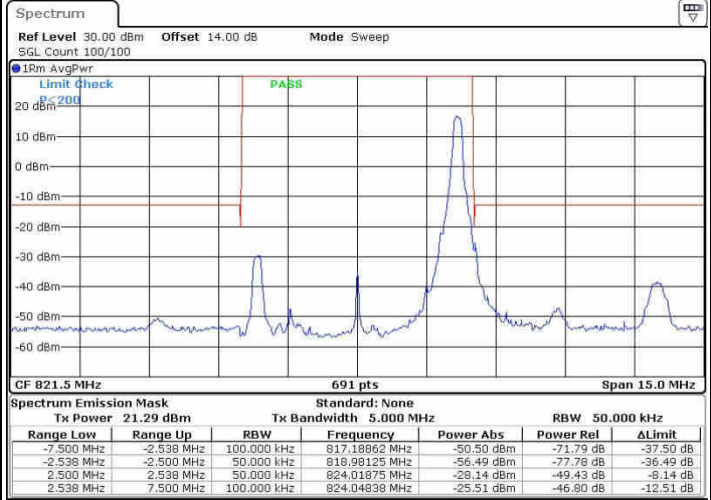

Date: 30.MAY.2017 16:28:31

Lowest Band Edge / Full RB

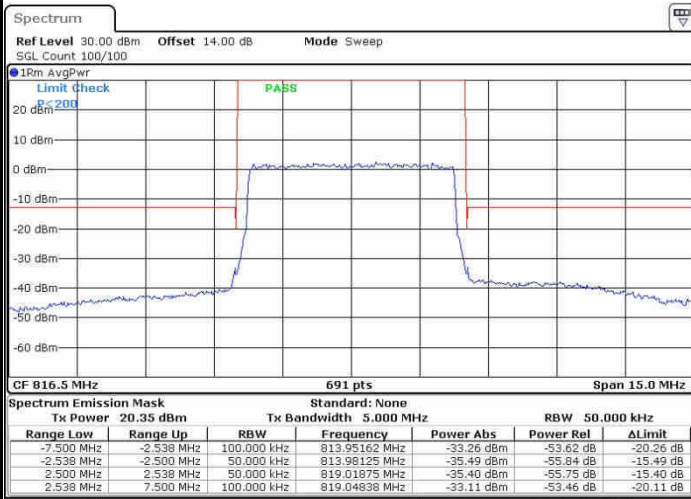

Date: 30.MAY.2017 16:25:54

Highest Band Edge / Full RB

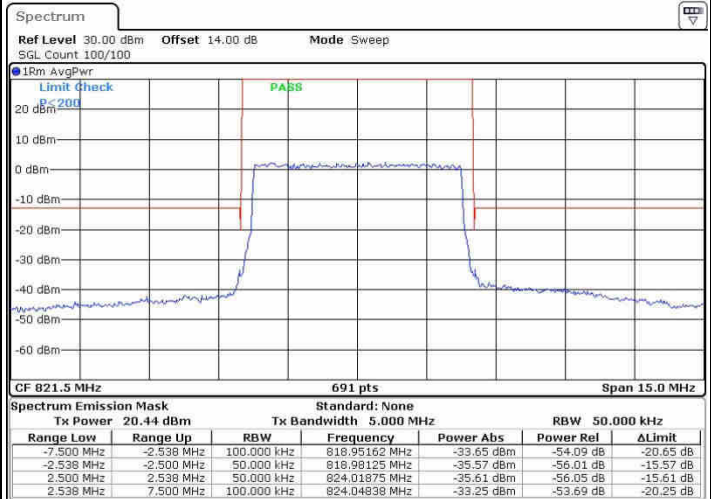

Date: 30.MAY.2017 16:28:09



LTE Band 26 / 10MHz / 64QAM

Middle Band Edge / 1 RB0

Middle Band Edge / 1 RB max

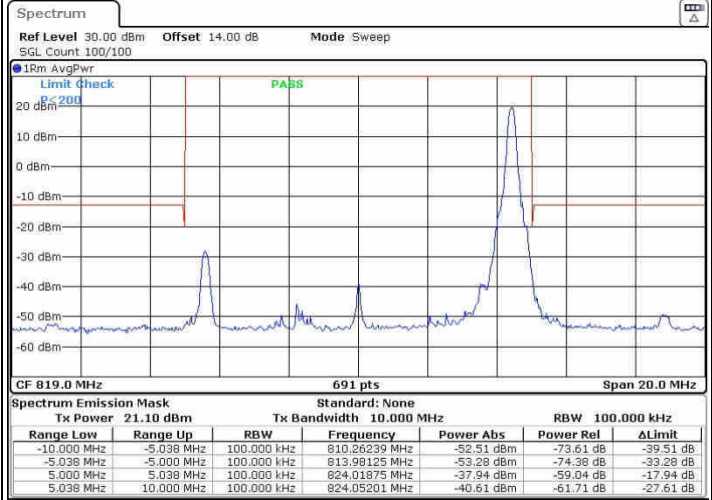
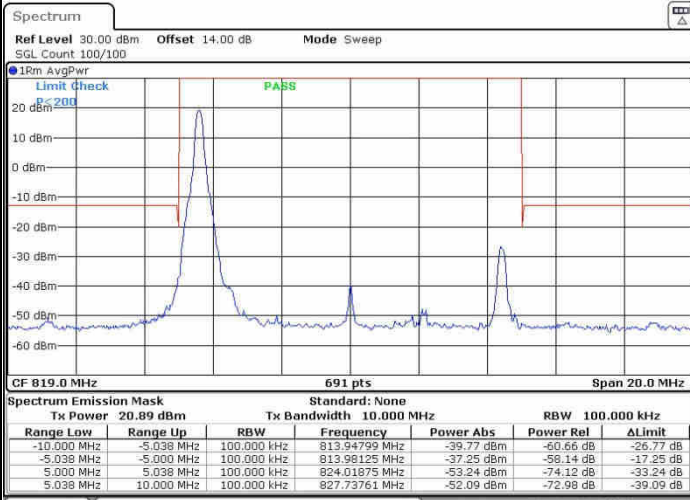

Date: 30.MAY.2017 16:39:35

Date: 30.MAY.2017 16:44:38

Middle Band Edge / Full RB

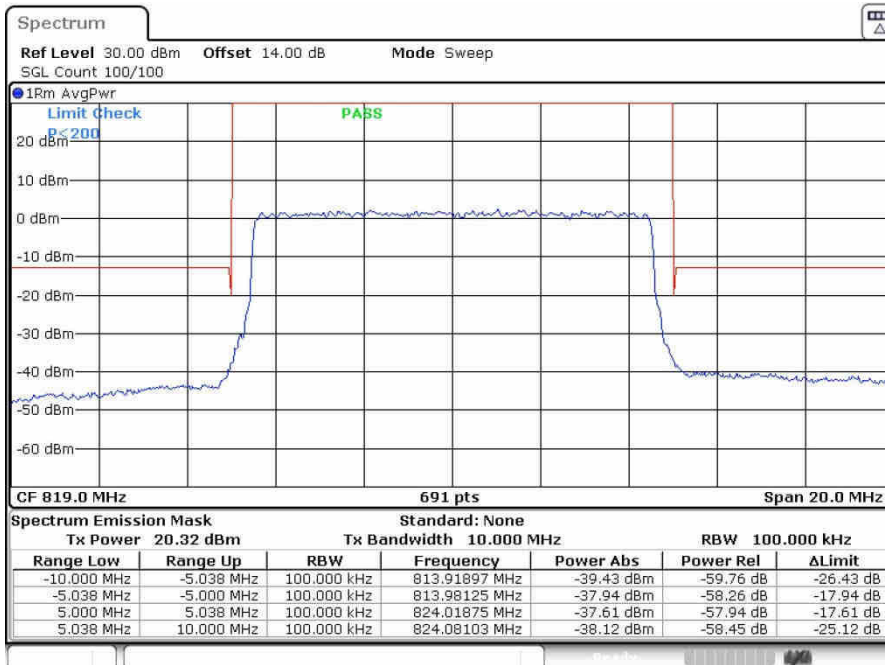

Date: 30.MAY.2017 16:34:57



LTE Band 26 / 15MHz / 64QAM

Lowest Band Edge / 1 RB0

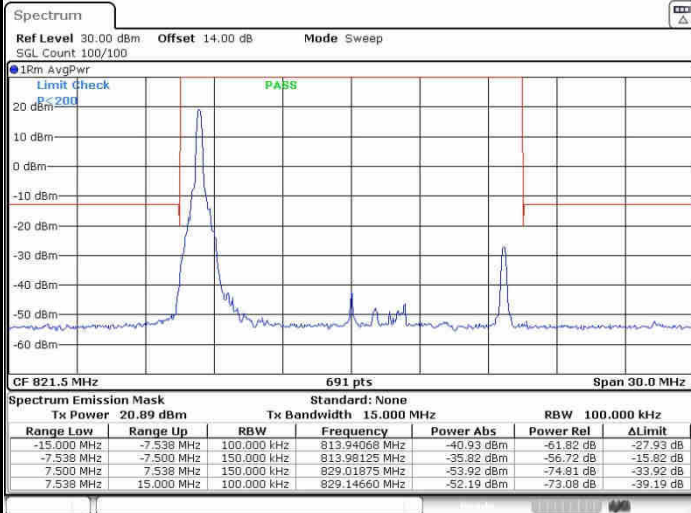

Date: 30.MAY.2017 16:46:18

Lowest Band Edge / Full RB

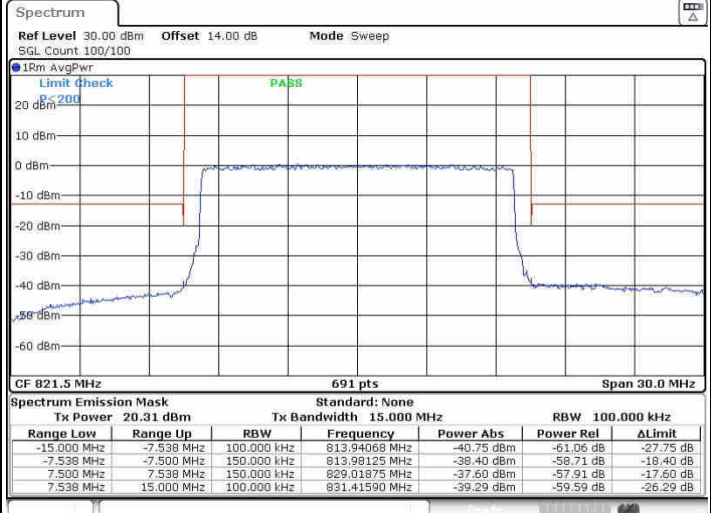

Date: 30.MAY.2017 16:46:58



# Conducted Spurious Emission

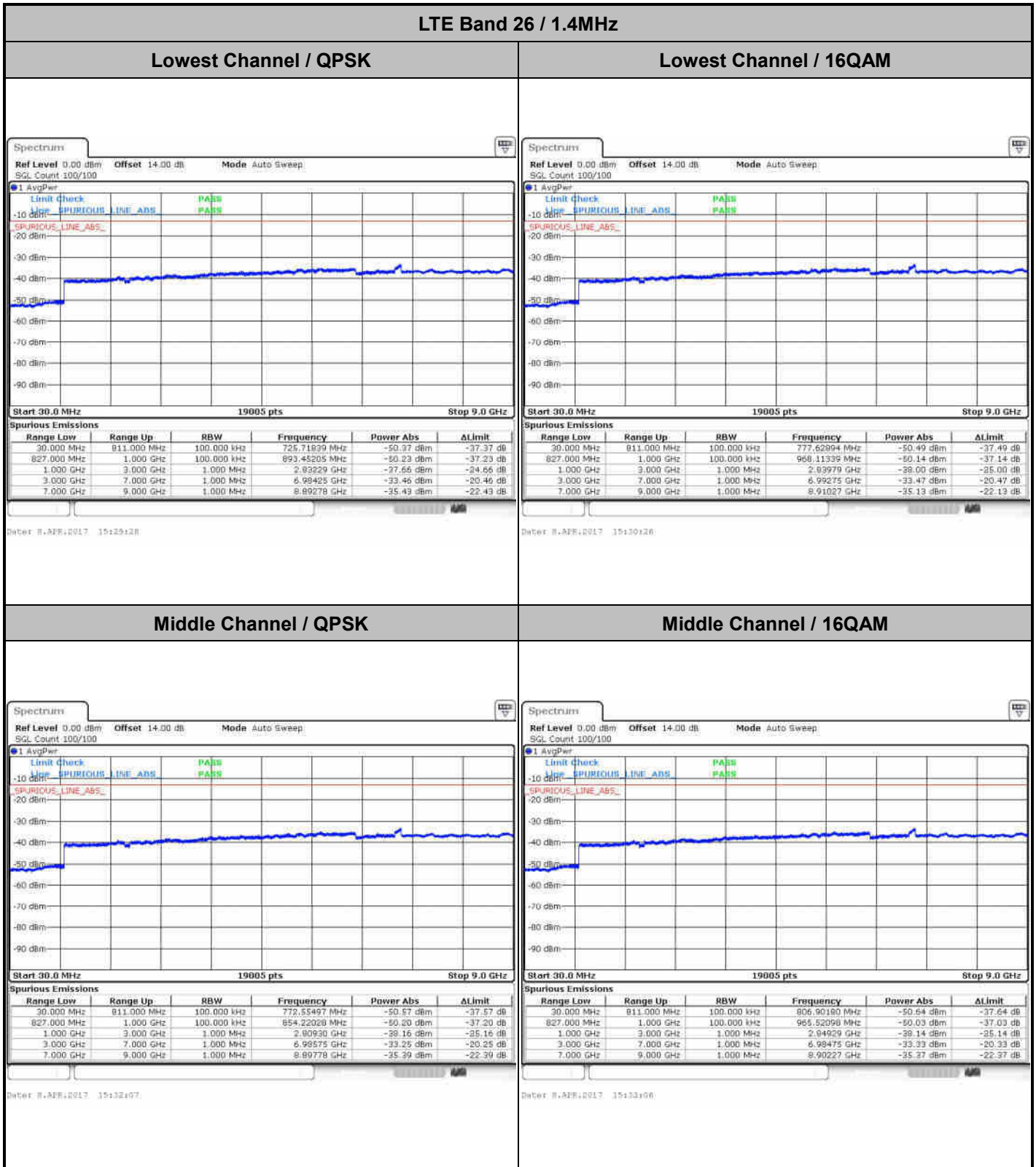





LTE Band 26 / 1.4MHz

Highest Channel / QPSK

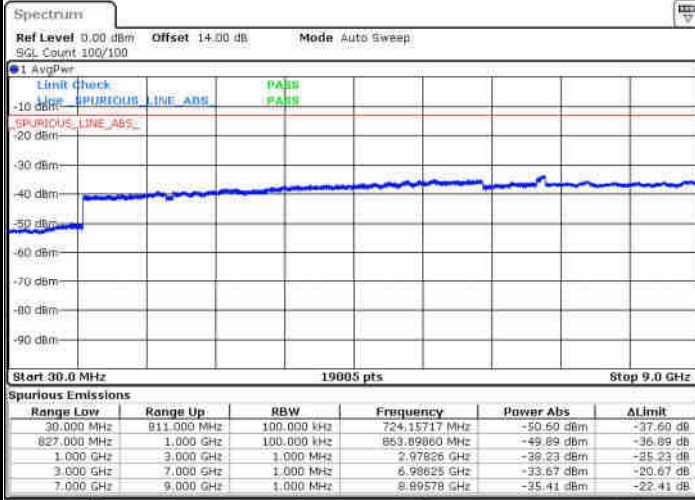

Date: 8.APR.2017 15:35:33

Highest Channel / 16QAM

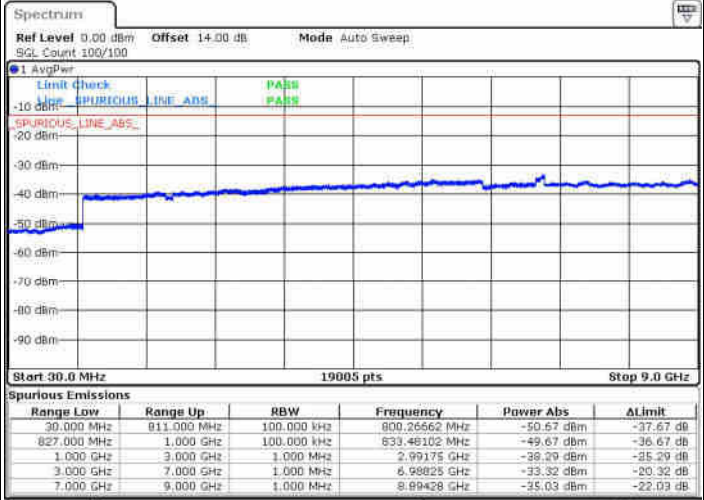

Date: 8.APR.2017 15:40:38

LTE Band 26 / 3MHz

Lowest Channel / QPSK

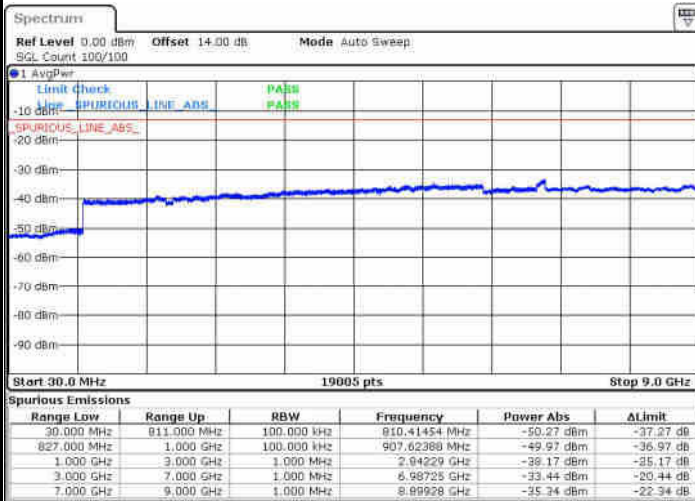

Date: 8.APR.2017 15:47:08

Lowest Channel / 16QAM

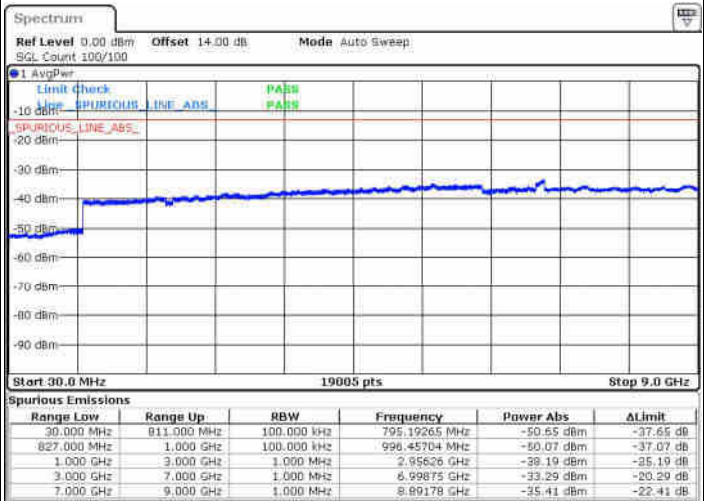

Date: 8.APR.2017 15:48:05



LTE Band 26 / 3MHz

Middle Channel / QPSK

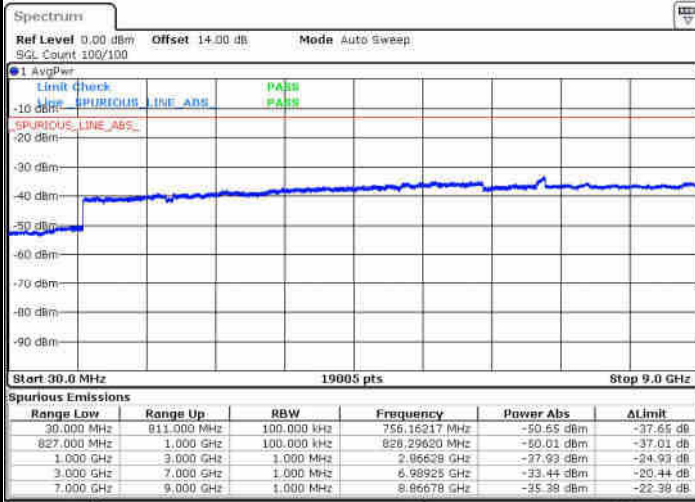

Date: 8.APR.2017 15:45:46

Middle Channel / 16QAM

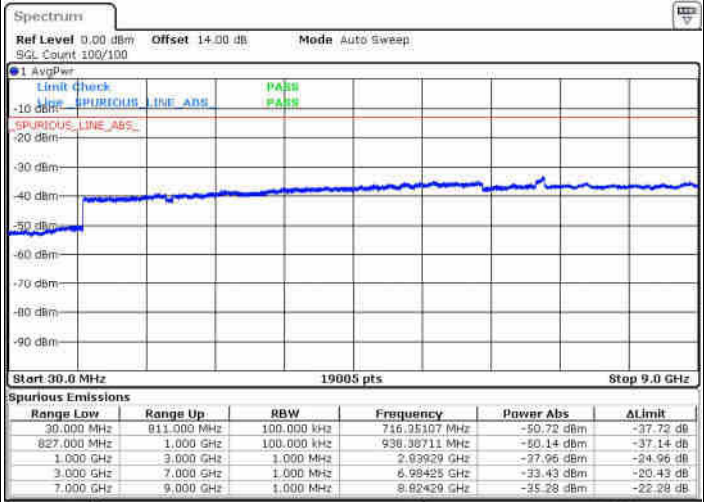

Date: 8.APR.2017 15:50:45

Highest Channel / QPSK

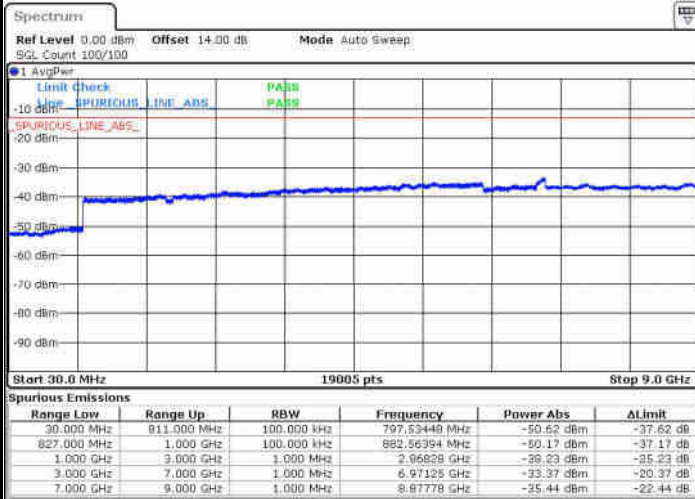

Date: 8.APR.2017 15:47:19

Highest Channel / 16QAM

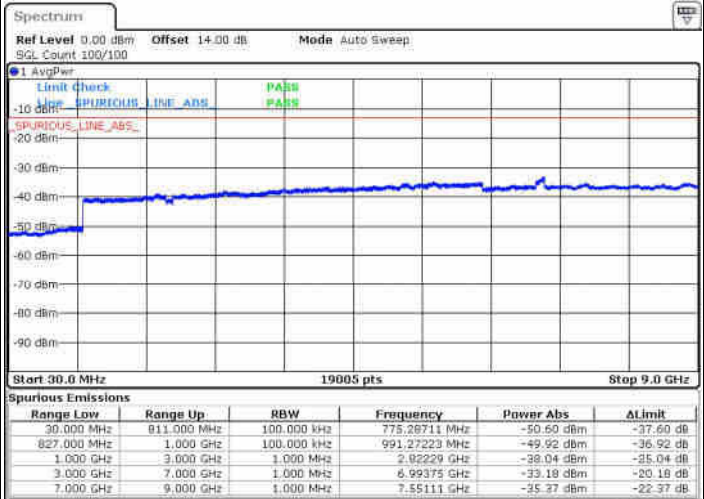

Date: 8.APR.2017 15:18:17



LTE Band 26 / 5MHz

Lowest Channel / QPSK

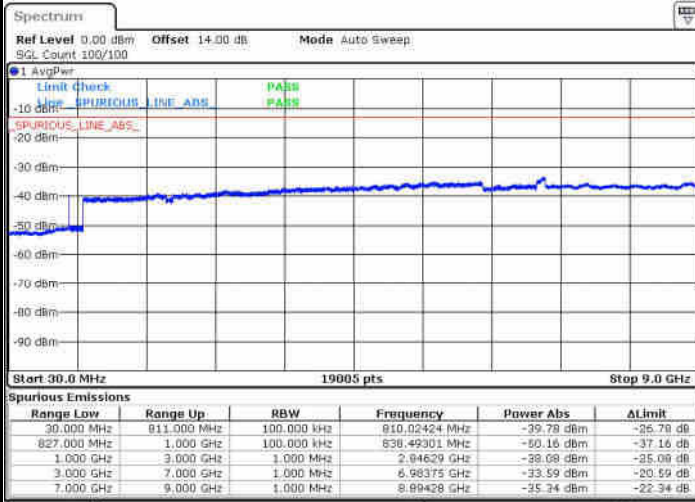

Date: 8.APR.2017 16:08:14

Lowest Channel / 16QAM

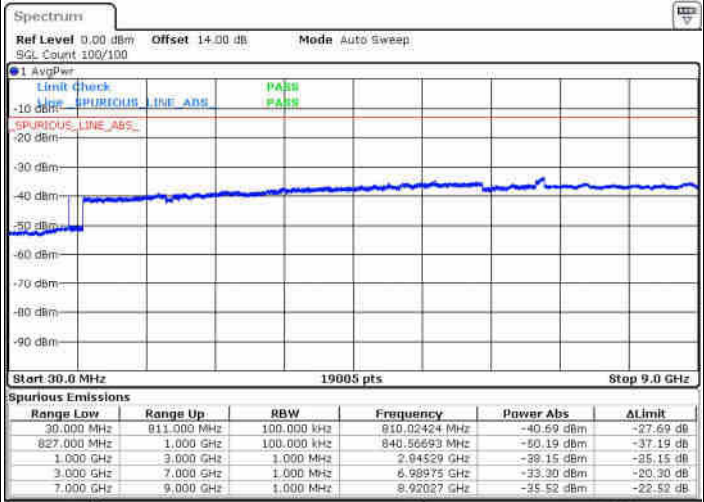

Date: 8.APR.2017 16:05:43

Middle Channel / QPSK

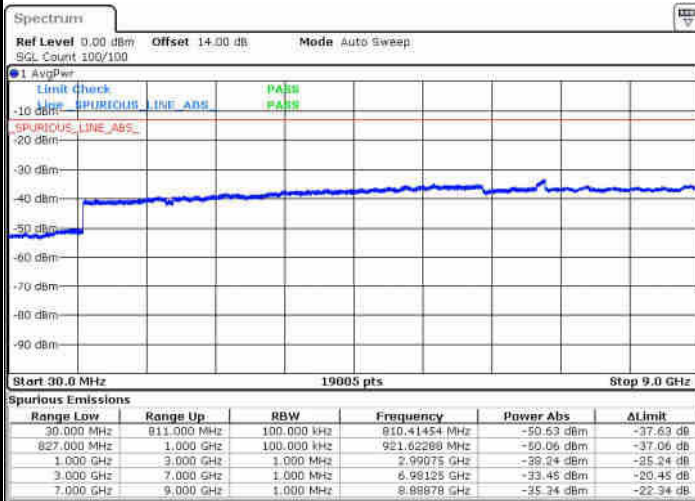

Date: 8.APR.2017 16:07:24

Middle Channel / 16QAM

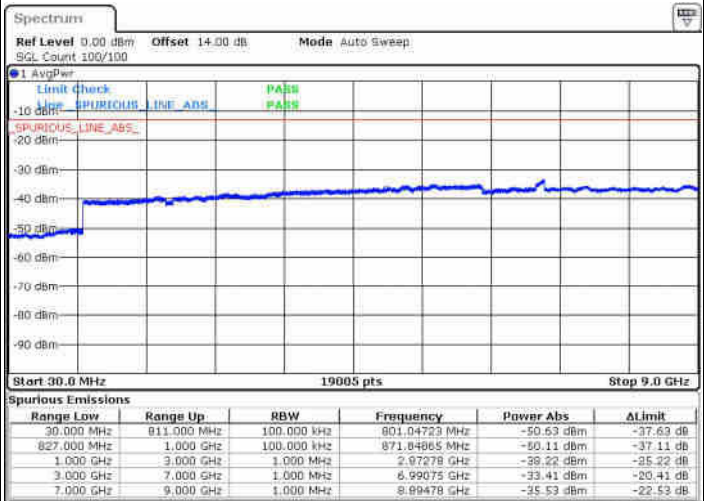

Date: 8.APR.2017 16:08:22