



**FCC PART 15  
TEST REPORT  
No. I16Z40476-SRD015**

**for**

**OnePlus Technology(Shenzhen) Co., Ltd.**

**Mobile Phone**

**Model Name: ONEPLUS A3000**

**FCC ID: 2ABZ2-A3000**

**with**

**Hardware Version: 16**

**Software Version: Qxygen OS 3.1.0**

**Issued Date: 2016-05-26**



**Note:**

The test results in this test report relate only to the devices specified in this report. This report shall not be reproduced except in full without the written approval of CTTL.

**Test Laboratory:**

CTTL, Telecommunication Technology Labs, Academy of Telecommunication Research, MIIT

No.52, HuayuanNorth Road, Haidian District, Beijing, P. R. China 100191.

Tel:+86(0)10-62304633-2512,Fax:+86(0)10-62304633-2504

Email:[ctl\\_terminals@catr.cn](mailto:ctl_terminals@catr.cn), website:[www.chinattl.com](http://www.chinattl.com)



## **REPORT HISTORY**

<b>Report Number</b>	<b>Revision</b>	<b>Description</b>	<b>Issue Date</b>
I16Z40476-SRD015	Rev.0	1st edition	2016-05-17
I16Z40476-SRD015	Rev.1	2ed edition	2016-05-23
I16Z40476-SRD015	Rev.2	3rd edition	2016-05-26



## **CONTENTS**

<b>CONTENTS</b> .....	<b>3</b>
<b>1. TEST LATORATORY</b> .....	<b>4</b>
<b>1.1. TESTING LOCATION</b> .....	<b>4</b>
<b>1.2. TESTING ENVIRONMENT</b> .....	<b>4</b>
<b>1.3. PROJECT DATA</b> .....	<b>4</b>
<b>1.4. SIGNATURE</b> .....	<b>4</b>
<b>2. CLIENT INFORMATION</b> .....	<b>5</b>
<b>2.1. APPLICANT INFORMATION</b> .....	<b>5</b>
<b>2.2. MANUFACTURER INFORMATION</b> .....	<b>5</b>
<b>3. EQUIPMENT UNDER TEST (EUT) AND ANCILLARY EQUIPMENT(AE)</b> .....	<b>6</b>
<b>3.1. ABOUT EUT</b> .....	<b>6</b>
<b>3.2. INTERNAL IDENTIFICATION OF EUT USED DURING THE TEST</b> .....	<b>6</b>
<b>3.3. GENERAL DESCRIPTION</b> .....	<b>6</b>
<b>4. REFERENCE DOCUMENTS</b> .....	<b>7</b>
<b>4.1. DOCUMENTS SUPPLIED BY APPLICANT</b> .....	<b>7</b>
<b>4.2. REFERENCE DOCUMENTS FOR TESTING</b> .....	<b>7</b>
<b>5. LABORATORY ENVIRONMENT</b> .....	<b>7</b>
<b>6. SUMMARY OF TEST RESULTS</b> .....	<b>7</b>
<b>6.1. SUMMARY OF TEST RESULTS</b> .....	<b>7</b>
<b>6.2. STATEMENTS</b> .....	<b>7</b>
<b>7. TEST EQUIPMENTS UTILIZED</b> .....	<b>8</b>
<b>ANNEX A: MEASUREMENT RESULTS</b> .....	<b>9</b>
<b>A.1. MEASUREMENT METHOD</b> .....	<b>9</b>
<b>A.2. CHANNEL MOVE TIME AND CHANNEL CLOSING TRANSMISSION TIME</b> .....	<b>11</b>
<b>A.3. NON-OCCUPANCY PERIOD</b> .....	<b>16</b>
<b>A3.1 ASSOCIATED TEST</b> .....	<b>16</b>
<b>ANNEX B: PHOTOGRAPHS OF THE TEST SET-UP</b> .....	<b>17</b>
<b>ANNEX C: ACCREDITATION CERTIFICATE</b> .....	<b>18</b>

## 1. TEST LATORATORY

### 1.1. Testing Location

Location 1:CTTL(huayuan North Road)

Address: No. 52, Huayuan North Road, Haidian District, Beijing,  
P. R. China100191

Location 2:CTTL(Shouxiang)

Address: No. 51 Shouxiang Science Building, Xueyuan Road,  
Haidian District, Beijing, P. R. China100191

### 1.2. Testing Environment

Normal Temperature: 15-35°C  
Extreme Temperature: 0/+35°C  
Relative Humidity: 20-75%

### 1.3. Project data

Testing Start Date: 2016-04-06  
Testing End Date: 2016-05-16

### 1.4. Signature



---

Jiang Xue  
(Approved this test report)

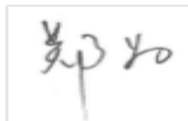

---

Zheng Wei  
(Reviewed this test report)



---

Lv Songdong  
(Approved this test report)



## **2. CLIENT INFORMATION**

### **2.1. Applicant Information**

Company Name: OnePlus Technology(Shenzhen) Co., Ltd.  
Address /Post: 18/F, Tower C, Tai Ran Building, No.8 Tai Ran Road, Shenzhen, China  
Contact: Kevin Ke  
Email: keyoujiang@oneplus.cn  
Telephone: 0755 61898696 EXT 7023  
Fax: /

### **2.2. Manufacturer Information**

Company Name: OnePlus Technology(Shenzhen) Co., Ltd.  
Address /Post: 18/F, Tower C, Tai Ran Building, No.8 Tai Ran Road, Shenzhen, China  
Contact: Kevin Ke  
Email: keyoujiang@oneplus.cn  
Telephone: 0755 61898696 EXT 7023  
Fax: /



### **3. EQUIPMENT UNDER TEST (EUT) AND ANCILLARY**

#### **EQUIPMENT(AE)**

##### **3.1. About EUT**

Description	Mobile Phone
Model name	ONEPLUS A3000
FCC ID	2ABZ2-A3000
WLAN Frequency Range	ISM Band: -5250MHz~5350MHz -5470MHz~5725MHz
Type of modulation	OFDM
Antenna	Integral Antenna
Extreme vol. Limits	3.8V DC by Battery
Device Type (DFS)	Client without radar detection(only support client mode)
TPC mechanism	Not support

##### **3.2. Internal Identification of EUT used during the test**

<b>EUT ID*</b>	<b>S/N</b>	<b>HW Version</b>	<b>SW Version</b>
EUT1	860046030181863	16	Qxygen OS 3.1.0

\*EUT ID: is used to identify the test sample in the lab internally.

##### **3.3. General Description**

The Equipment Under Test (EUT) is a model of Mobile Phone with integrated antenna. It consists of normal options: lithium battery, charger. Manual and specifications of the EUT were provided to fulfil the test.

#### **4. REFERENCE DOCUMENTS**

##### **4.1. Documents supplied by applicant**

EUT feature information is supplied by the applicant or manufacturer, which is the basis of testing.

##### **4.2. Reference Documents for testing**

The following documents listed in this section are referred for testing.

FCC Part15	Title 47 of the Code of Federal Regulations; Chapter I Part 15 - Radio frequency devices Subpart E – UNII Devices	2015
FCC 06-96	Revision of Parts 2 and 15 of the Commission’s Rules to Permit Unlicensed National Information Infrastructure (U-NII) devices in the 5 GHz band	2006
KDB 905462 D03	U-NII CLIENT DEVICES WITHOUT RADAR DETECTION CAPABILITY	2014

#### **5. LABORATORY ENVIRONMENT**

Measurement is performed in shielding room.

#### **6. SUMMARY OF TEST RESULTS**

##### **6.1. Summary of Test Results**

<b>SUMMARY OF MEASUREMENT RESULTS</b>	<b>Sub-clause of Part15C</b>	<b>Verdict</b>
Channel move time and channel closing transmission time	4.7.2	<b>P</b>
Non-Occupancy Period	4.7.2	<b>P</b>

Please refer to **ANNEX A** for detail.

Terms used in Verdict column

P	Pass, The EUT complies with the essential requirements in the standard.
NM	Not measured, The test was not measured by CTTL
NA	Not Applicable, The test was not applicable
F	Fail, The EUT does not comply with the essential requirements in the standard

##### **6.2. Statements**

CTTL has evaluated the test cases requested by the client/manufacturer as listed in section 6.1 of this report for the EUT specified in section 3 according to the standards or reference documents listed in section 4.1.

This report only deal with the UNII DFS functions among the features described in section 3, and The EUT met all requirements of the reference documents.

The end user is not available to get and modify the parameters of the detected Radar Waveforms in this product.



### Test Conditions

T nom	Normal Temperature
T min	Low Temperature
T max	High Temperature
V nom	Normal Voltage
V min	Low Voltage
V max	High Voltage
H nom	Norm Humidity
A nom	Norm Air Pressure

For this report, all the test case listed above is tested under Normal Temperature and Normal Voltage, and also under norm humidity, the specific conditions as following:

Temperature	T nom	26°C
Voltage	V nom	3.8V(By battery)
Humidity	H nom	44%
Air Pressure	A nom	1010hPa

## **7. TEST EQUIPMENTS UTILIZED**

### **Conducted test system**

No.	Equipment	Model	Serial Number	Manufacturer	Calibration Date	Calibration Due Date
1	Vector Signal Analyzer	FSQ40	200089	Rohde & Schwarz	2015-07-01	2016-06-30
2	Vector Signal General	SMU200A	103752	Rohde & Schwarz	2015-07-01	2016-06-30
3	Shielding Room	S81	/	ETS-Lindgren	/	/



## ANNEX A: MEASUREMENT RESULTS

### A.1. Measurement Method

#### A.1.1. Conducted Measurements

The below figure shows the DFS setup, where the EUT is a WLAN device operating in slave mode, without Radar Interference Detection function. This setup also contains a device operating in master mode. The radar test signals are injected into the master device. The EUT (slave device) is associated with the master device. WLAN traffic is generated by streaming the mpeg file from the master to the slave in full monitor video mode using the media player.

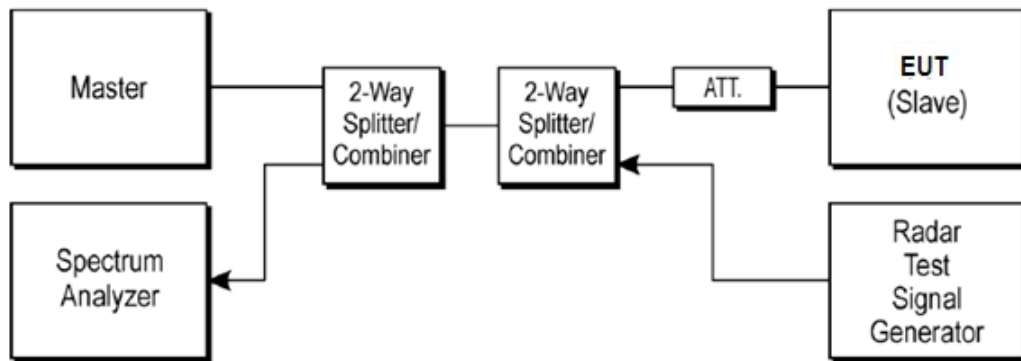

Note:

- 1) All Measurements are performed with the EUT's narrowest channel bandwidth.
- 2) The master device information is as follows  
Vendor: Cisco  
Model: AIR-AP1252AG-A-K9  
FCC ID: LDK102061, 1DK102062
- 3) The software of radar signal generator (R&S SMU200A) is completely designed based on FCC-06-96A1/NTIA requirement.

#### A.1.2. Parameters of DFS test signal

1). Interference threshold values, master or client incorporation in service monitoring. For device power less than 23dBm (E.I.R.P.), the threshold level is -62 dBm at the antenna port after correction for antenna gain and procedural adjustments.

Because of conducted measurement performed, the calibration power from radar signal generator to antenna port of DFS test equipment is -62 dBm.

Maximum Transmit Power	Value
> 200 mW	-64 dBm
< 200 mW	-62 dBm

## 2). DFS requirement values

The required values are as the following table.

Parameter	Value
Non-occupancy	> 1800 s
Channel Availability Check Time	60 s
Channel Move Time	10 s
Channel Closing Transmission Time	200 ms + 60 ms
U-NII Detection Bandwidth	Minimum 80% of the 99% transmission power bandwidth

As the EUT is IP based system, the MPEG video file from NTIA website is used to steam to EUT via the Master device.

**A.1.3. Measurement Uncertainty**

Item	Measurement Uncertainty
Time	0.70 ms
Power	0.75 dBm

## A.2. Channel move time and channel closing transmission time

### Measurement Limit:

Test Items	Limit
channel closing transmission time	< 200 ms + 60 ms
Channel move time	< 10 s

### Measurement Results:

HT20 Frequency Band: 5250MHz ~ 5350MHz

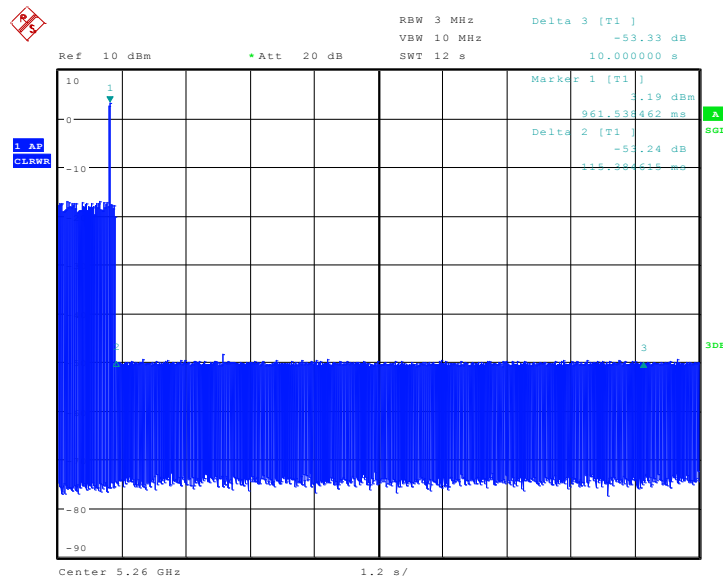

Date: 9.MAY.2016 15:54:27

The channel move time is as the figure. It shows the time of the radar and the client pulses. The figure shows that the client stops transmission within 10 seconds, and no transmissions occur after 10 seconds later of the radar burst signal.

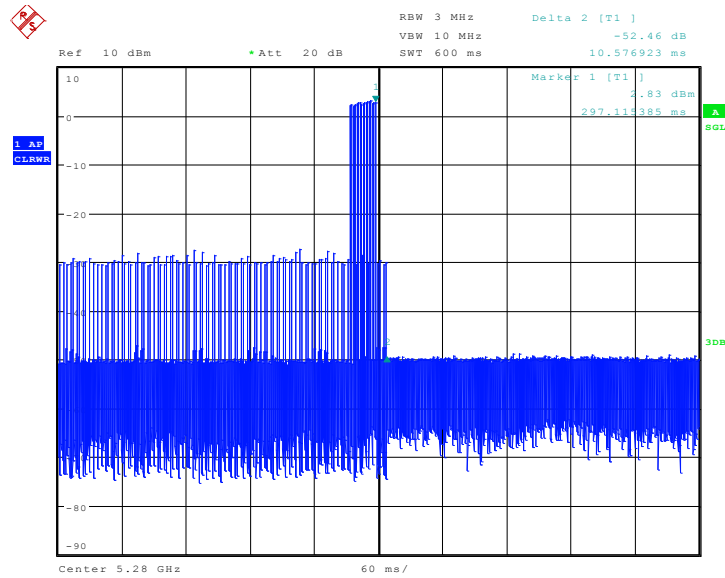

Date: 9.MAY.2016 15:57:34

The closing transmission time is as the figure, and the result is 10.58ms.

**Conclusion: PASS**

### HT80 Frequency Band: 5250MHz ~ 5350MHz

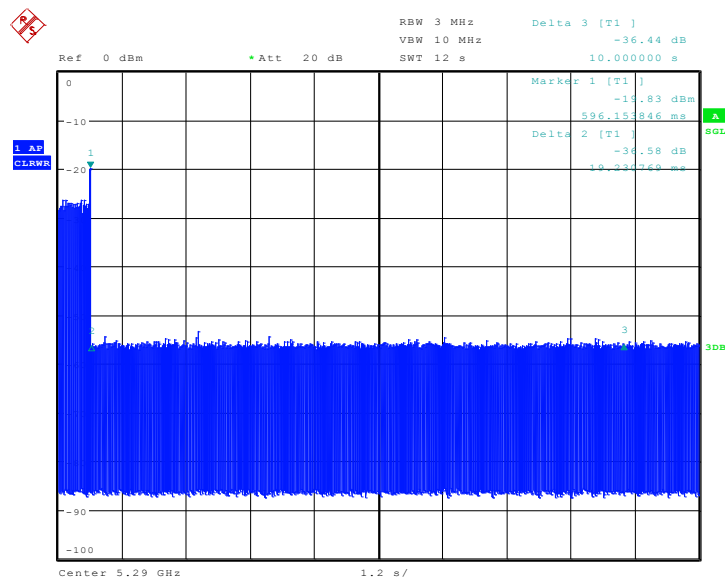

Date: 9.MAY.2016 16:45:43

The channel move time is as the figure. It shows the time of the radar and the client pulses. The figure shows that the client stops transmission within 10 seconds, and no transmissions occur after 10 seconds later of the radar burst signal.

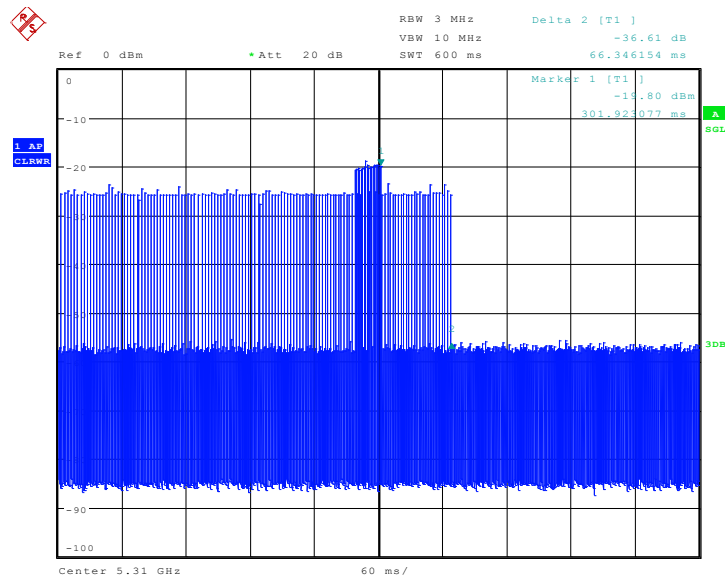

Date: 9.MAY.2016 16:48:48

The closing transmission time is as the figure, and the result is 66.35ms

**Conclusion: PASS**

### HT20 Frequency Band 5470MHz ~ 5725MHz

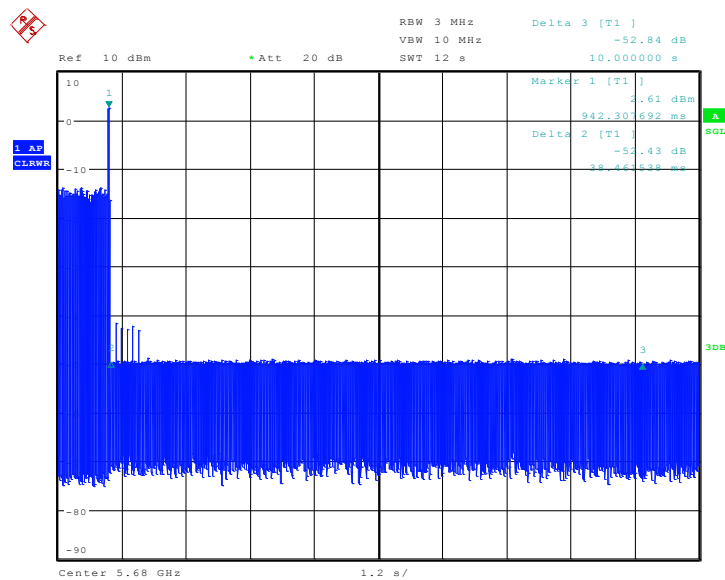

Date: 17.MAY.2016 16:12:15

The channel move time is as the figure. It shows the time of the radar and the client pulses. The figure shows that the client stops transmission within 10 seconds, and no transmissions occur after 10 seconds later of the radar burst signal.

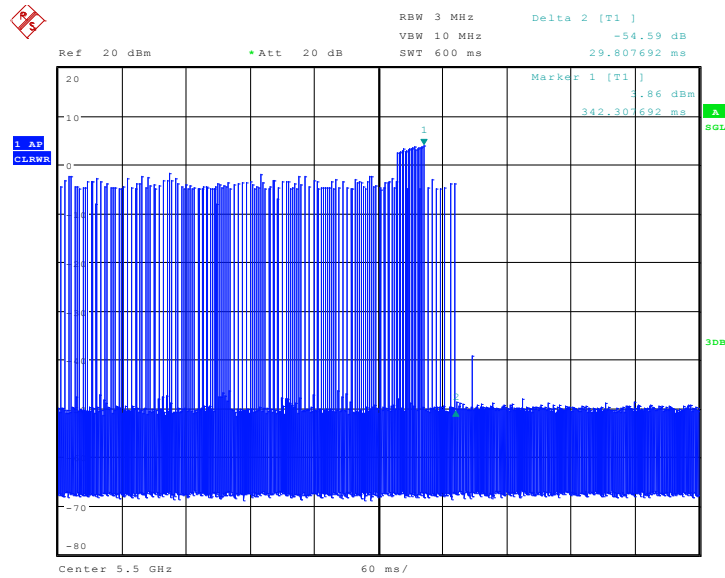

Date: 10.MAY.2016 16:17:00

The closing transmission time is as the figure, and the result is 29.81ms

**Conclusion: PASS**

### HT80 Frequency Band 5470MHz ~ 5725MHz

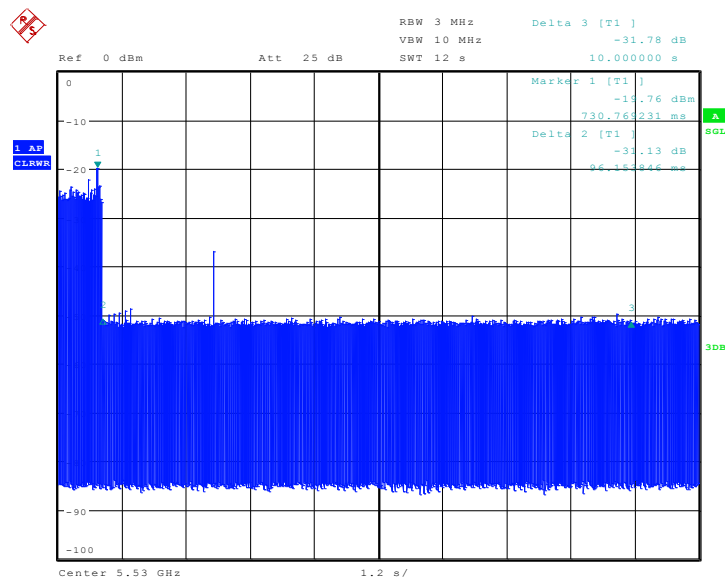

Date: 12.MAY.2016 19:35:20

The channel move time is as the figure. It shows the time of the radar and the client pulses. The figure shows that the client stops transmission within 10 seconds, and no transmissions occur after 10 seconds later of the radar burst signal.

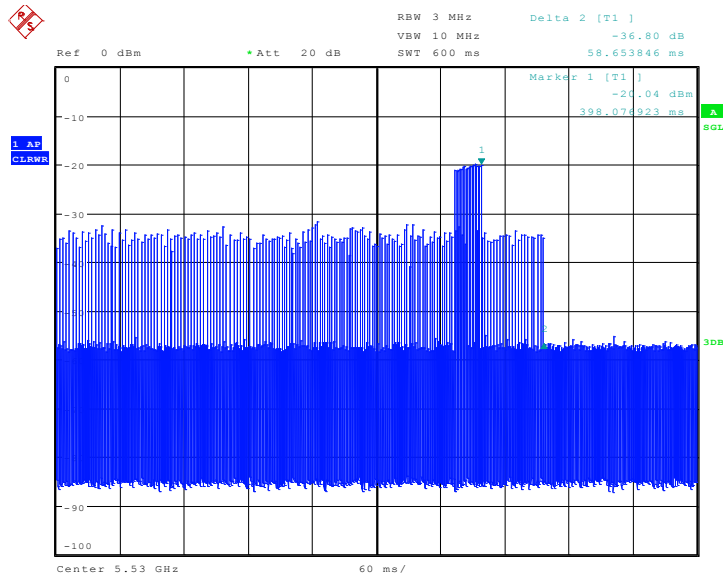

Date: 16.MAY.2016 11:53:35

The closing transmission time is as the figure, and the result is 58.65ms

**Conclusion: PASS**

### A.3. Non-Occupancy Period

#### Measurement Limit:

Test Items	Limit
Non-Occupancy Period	> 1800 s

#### A3.1 Associated test

Associate the master and client, transmit specified stream between the master and client; monitor the analyzer on the operating frequency to make sure no beacons have been transmitted for 1800 seconds.

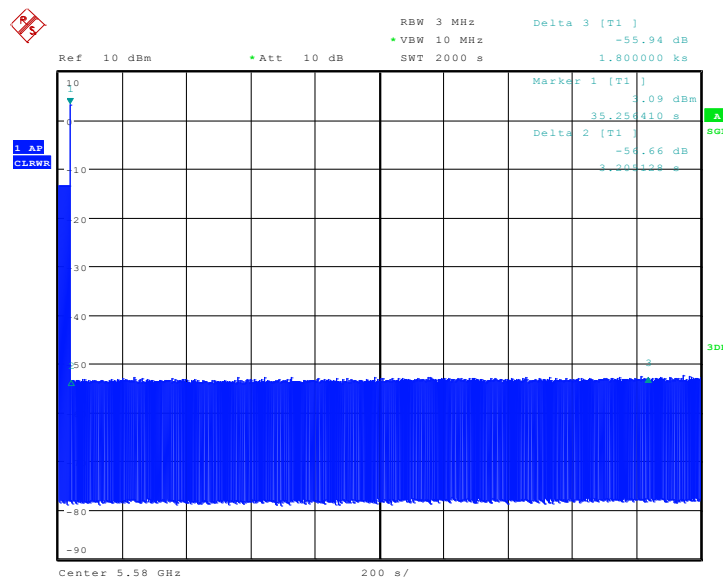

Date: 26.MAY.2016 16:12:52

The figure above shows that the client does not transmit any emission within 1800 seconds after getting the order of “stop transmits” from the DFS master (access point).

**Conclusion: PASS**



## ANNEX B: PHOTOGRAPHS OF THE TEST SET-UP

### Layout of Conducted Test



**ANNEX C: Accreditation Certificate**



**China National Accreditation Service for Conformity Assessment**

**LABORATORY ACCREDITATION CERTIFICATE**

**(No. CNAS L0570 )**

**Telecommunication Technology Labs,**

**Academy of Telecommunication Research, MIIT**

No.52, Huayuan North Road, Haidian District, Beijing, China

No.51, Xueyuan Road, Haidian District, Beijing, China

*to ISO/IEC 17025:2005 General Requirements for the Competence of Testing and Calibration Laboratories(CNAS-CL01 Accreditation Criteria for the Competence of Testing and Calibration Laboratories) for the competence in the field of testing and calibration.*

*The scope of accreditation is detailed in the attached schedule bearing the same accreditation number as above. The schedule forms an integral part of this certificate.*

Date of Issue: 2014-10-29

Date of Expiry: 2017-06-19

Date of Initial Accreditation: 1998-07-03



Signed on behalf of China National Accreditation Service  
for Conformity Assessment

China National Accreditation Service for Conformity Assessment (CNAS) is authorized by Certification and Accreditation Administration of the People's Republic of China (CNCA) to operate the national accreditation schemes for conformity assessment. CNAS is the signatory to International Laboratory Accreditation Cooperation Multilateral Recognition Arrangement (ILAC MRA) and Asia Pacific Laboratory Accreditation Cooperation Multilateral Recognition Arrangement (APLAC MRA).

No.CNAS AL 2

0011149

\*\*\* END OF REPORT BODY \*\*\*