

FCC&IC Radio Test Report

FCC ID: 2ABZ2-A2005

IC:12739A-A2005

This report concerns (check one): Original Grant Class II Change

Project No. : 1506C242
Equipment : Mobile Phone
Model Name : ONE A2005
Applicant : OnePlus Technology (Shenzhen) Co., Ltd.
Address : 18/F, Tower C, Tai Ran Building, No.8 Tai Ran Road,
Shenzhen, China

Date of Receipt : Jun. 13, 2015
Date of Test : Jun. 13, 2015 ~ Jul. 03, 2015
Issued Date : Jul. 06, 2015
Tested by : BTL Inc.

Testing Engineer : David Mao
(David Mao)

Technical Manager : Leo Hung
(Leo Hung)

Authorized Signatory : Steven Lu
(Steven Lu)

B T L I N C .

No.3, Jinshagang 1st Road, Shixia, Dalang Town, Dongguan,
Guangdong, China.

TEL: +86-769-8318-3000 FAX: +86-769-8319-6000

Declaration

BTL represents to the client that testing is done in accordance with standard procedures as applicable and that test instruments used has been calibrated with the standards traceable to National Measurement Laboratory (**NML**) of **R.O.C.**, or National Institute of Standards and Technology (**NIST**) of **U.S.A.**

BTL's reports apply only to the specific samples tested under conditions. It is manufacture's responsibility to ensure that additional production units of this model are manufactured with the identical electrical and mechanical components. **BTL** shall have no liability for any declarations, inferences or generalizations drawn by the client or others from **BTL** issued reports.

BTL's report must not be used by the client to claim product certification, approval, or endorsement by NVLAP, NIST, or any agency of the Federal Government.

This report is the confidential property of the client. As a mutual protection to the clients, the public and **BTL-self**, extracts from the test report shall not be reproduced except in full with **BTL's** authorized written approval.

BTL's laboratory quality assurance procedures are in compliance with the **ISO Guide 17025** requirements, and accredited by the conformity assessment authorities listed in this test report.

Limitation

For the use of the authority's logo is limited unless the Test Standard(s)/Scope(s)/Item(s) mentioned in this test report is (are) included in the conformity assessment authorities acceptance respective.

Table of Contents	Page
REPORT ISSUED HISTORY	6
1 . CERTIFICATION	7
2 . SUMMARY OF TEST RESULTS	8
2.1 TEST FACILITY	9
2.2 MEASUREMENT UNCERTAINTY	9
3 . GENERAL INFORMATION	10
3.1 GENERAL DESCRIPTION OF EUT	10
3.2 DESCRIPTION OF TEST MODES	11
3.3 BLOCK DIGRAM SHOWING THE CONFIGURATION OF SYSTEM TESTED	12
3.4 DESCRIPTION OF SUPPORT UNITS	12
4 . TEST RESULT	13
4.1 RADIATED RF OUTPUT POWER MEASUREMENT	13
4.1.1 LIMIT	13
4.1.2 MEASURING INSTRUMENTS AND SETTING	13
4.1.3 TEST PROCEDURE	13
EIRP/ERP:	13
4.1.4 TEST SETUP LAYOUT	14
4.1.5 TEST DEVIATION	14
4.1.6 EUT OPERATION DURING TEST	14
4.1.7 EUT TEST CONDITIONS	14
4.1.8 TEST RESULTS	14
4.2 99% OCCUPIED BANDWIDTH MEASUREMENT	15
4.2.1 LIMIT	15
4.2.2 MEASURING INSTRUMENTS AND SETTING	15
4.2.3 TEST PROCEDURE	15
4.2.4 TEST SETUP LAYOUT	15
4.2.5 TEST DEVIATION	15
4.2.6 EUT OPERATION DURING TEST	15
4.2.7 EUT TEST CONDITIONS	15
4.2.8 TEST RESULTS	16
4.3 SPURIOUS EMISSIONS AT ANTENNA TERMINALS MEASUREMENT	17
4.3.1 LIMIT	17
4.3.2 MEASURING INSTRUMENTS AND SETTING	17
4.3.3 TEST PROCEDURES	17
4.3.4 TEST SETUP LAYOUT	17
4.3.5 TEST DEVIATION	17
4.3.6 EUT OPERATION DURING TEST	17

Table of Contents	Page
4.3.7 EUT TEST CONDITIONS	18
4.3.8 TEST RESULTS	18
4.4 SPURIOUS RADIATED EMISSIONS MEASUREMENT	19
4.4.1 LIMIT	19
4.4.2 MEASURING INSTRUMENTS AND SETTING	19
4.4.3 TEST PROCEDURES	19
4.4.4 TEST SETUP LAYOUT	20
4.4.5 TEST DEVIATION	20
4.4.6 EUT OPERATION DURING TEST	20
4.4.7 EUT TEST CONDITIONS	20
4.4.8 TEST RESULTS	20
4.5 BAND EDGE MEASUREMENT	21
4.5.1 LIMIT	21
4.5.2 MEASURING INSTRUMENTS AND SETTING	21
4.5.3 TEST PROCEDURES	21
4.5.4 TEST SETUP LAYOUT	21
4.5.5 TEST DEVIATION	21
4.5.6 EUT OPERATION DURING TEST	21
4.5.7 EUT TEST CONDITIONS	21
4.5.8 TEST RESULTS	22
4.6 FREQUENCY STABILITY MEASUREMENT	23
4.6.1 LIMIT	23
4.6.2 MEASURING INSTRUMENTS AND SETTING	23
4.6.3 TEST PROCEDURES	23
4.6.4 TEST SETUP LAYOUT	23
4.6.5 TEST DEVIATION	23
4.6.6 EUT OPERATION DURING TEST	23
4.6.7 EUT TEST CONDITIONS	24
4.6.8 TEST RESULTS	24
4.7 PEAK TO AVERAGE RATIO	25
4.7.1 LIMIT	25
4.7.2 TEST PROCEDURES	25
4.7.3 TEST SETUP LAYOUT	25
4.7.4 TEST DEVIATION	25
4.7.5 EUT OPERATION DURING TEST	25
4.7.6 EUT TEST CONDITIONS	25
4.7.7 TEST RESULTS	25
5. LIST OF MEASUREMENT EQUIPMENTS	26
6. EUT TEST PHOTO	29
ATTACHMENT A - RADIATED RF OUTPUT POWER	32
ATTACHMENT B - 99% OCCUPIED BANDWIDTH	34

Table of Contents	Page
ATTACHMENT C - SPURIOUS EMISSIONS AT ANTENNA TERMINALS	37
ATTACHMENT D - SPURIOUS RADIATED EMISSION	39
ATTACHMENT E - BAND EDGE	44
ATTACHMENT F - FREQUENCY STABILITY	46
ATTACHMENT G - PEAK TO AVERAGE RATIO	48

REPORT ISSUED HISTORY

Issued No.	Description	Issued Date
BTL-FICP-9-1506C242	Original Issue.	Jul. 06, 2015

1. CERTIFICATION

Equipment : Mobile Phone
Brand Name : 
Model Name : ONE A2005
Applicant : OnePlus Technology (Shenzhen) Co., Ltd.
Manufacturer : OnePlus Technology (Shenzhen) Co., Ltd.
Address : 18/F, Tower C, Tai Ran Building, No.8 Tai Ran Road, Shenzhen, China
Factory : OnePlus Technology (Shenzhen) Co., Ltd.
Address : 18/F, Tower C, Tai Ran Building, No.8 Tai Ran Road, Shenzhen, China
Date of Test : Jun. 13, 2015 ~ Jul. 03, 2015
Test Sample : ENGINEERING SAMPLE
Standard(s) : 47 CFR FCC Part 27
47 CFR FCC Part 2 & ANSI/TIA-603-C-2004
RSS-139 Issue 2 February 2009

The above equipment has been tested and found compliance with the requirement of the relative standards by BTL Inc.

The test data, data evaluation, and equipment configuration contained in our test report (Ref No. BTL-FICP-9-1506C242) were obtained utilizing the test procedures, test instruments, test sites that has been accredited by the Authority of TAF according to the ISO-17025 quality assessment standard and technical standard(s).

Test result included in this report is only for the WCDMA BAND IV approval part of the product.

2. SUMMARY OF TEST RESULTS

Test procedures according to the technical standard(s):

FCC Part 27 & Part 2/ RSS-139 Issue 2				
Standard(s) Section		Test Item	Judgment	Remark
FCC	IC			
2.1047(d)	6.2	Modulation Characteristics	PASS	
2.1046(a) 27.50(d)(4)	6.4	Radiated RF Output	PASS	
2.1049(h) 27.53(h)	-	99% Occupied Bandwidth	PASS	
2.1051 27.53(h)	6.5	Spurious Emissions at Antenna Terminal	PASS	
2.1053 27.53(h)	6.5	Spurious Radiated Emissions	PASS	
27.53(h)	6.5	Band Edge Emissions	PASS	
2.1055 27.54	6.3	Frequency Stability	PASS	
2.1046(d) 27.50(d)(5)	6.4	Peak to Average Ratio	PASS	

NOTE:

(1) "N/A" denotes test is not applicable in this test report

2.1 TEST FACILITY

The test facilities used to collect the test data in this report is at the location of No.3, Jinshagang 1st Road, Shixia, Dalang Town, Dongguan, Guangdong, China.

BTL's test firm number for FCC: 319330

BTL's test firm number for IC: 4428B-1

2.2 MEASUREMENT UNCERTAINTY

Where relevant, the following measurement uncertainty levels have been estimated for tests performed on the EUT as specified in CISPR 16-4-2. The BTL measurement uncertainty is less than the CISPR 16-4-2 U_{CISPR} requirement.

The reported uncertainty of measurement $y \pm U$, where expanded uncertainty U is based on a standard uncertainty multiplied by a coverage factor of $k=2$, providing a level of confidence of approximately **95 %** ◦



A. Radiated Measurement :

Test Site	Method	Measurement Frequency Range	Ant. H / V	U_1 (dB)	Note
DG-CB03 (3m)	CISPR	9KHz~30MHz	V	3.79	
		9KHz~30MHz	H	3.57	
		30MHz ~ 200MHz	V	3.82	
		30MHz ~ 200MHz	H	3.78	
		200MHz ~ 1,000MHz	V	4.10	
		200MHz ~ 1,000MHz	H	4.06	
		1GHz~18GHz	V	3.12	
		1GHz~18GHz	H	3.68	
		18GHz~40GHz	V	4.15	
		18GHz~40GHz	H	4.14	

Note: Unless specifically mentioned, the uncertainty of measurement has not been taken into account to declare the compliance or non-compliance to the specification.

3. GENERAL INFORMATION

3.1 GENERAL DESCRIPTION OF EUT

Equipment	Mobile Phone		
Brand Name			
Model Name	ONE A2005		
Model Difference	N/A		
Product Description	Operation Frequency	WCDMA Band IV: TX:1712.4MHz~1752.6MHz RX:2112.4MHz~2152.6MHz	
	Modulation Type	QPSK;16QAM;BPSK	
	EIRP Output Power	20.74dBm	
Power Source	#1 DC Voltage supplied from AC/DC adapter. 1) Brand / Model:  / YJ1100 2) Brand / Model:  / AY0520 #2 Supplied from battery. Model: BLP597		
Power Rating	#1 1) I/P: 100-240V~ 50-60Hz 0.4A O/P: DC 5V 2A 2) I/P: 100-240V~ 50-60Hz 0.3A O/P: DC 5V 2A #2 DC 3.8V 3200mAh/3300mAh (min/typ)		

Note:

- For a more detailed features description, please refer to the manufacturer's specifications or the user's manual.
- Channel List

Band	Channel	Frequency	
		(MHz)	
WCDMA Band IV	1312	Low	1712.40
	1413	Mid	1732.60
	1513	High	1752.60

3.

Table for Filed Antenna @WCDMA Band IV

Ant.	Manufacture	Model Name	Antenna Type	Connector	Gain (dBi)
1	N/A	N/A	Internal	N/A	-1.75

3.2 DESCRIPTION OF TEST MODES

To investigate the maximum EMI emission characteristics generated from EUT, the test system was pre-scanning tested based on the consideration of following EUT operation mode or test configuration mode which possibly have effect on EMI emission level. Each of these EUT operation mode(s) or test configuration mode(s) mentioned above was evaluated respectively.

Test Items	Worst TX Mode	Channel
Radiated RF Output	WCDMA	1312/1413/1513
Spurious Radiated Emissions	WCDMA	1413
Band Edge Emissions	WCDMA	1312/1513
Frequency Stability	WCDMA	1312
99% Occupied Bandwidth	WCDMA	1312/1413/1513
Spurious Emissions at Antenna Terminal	WCDMA	1413
Peak to Average Ratio	WCDMA	1413

Note:

- (1) The measurements are performed at the highest, middle, lowest available channels.
- (2) The EUT is considered a portable unit; it was pre-tested on the positioning of each 3 axis. The worst case was found positioned on X-plane. Therefore only the test data of this X-plane was used for radiated emission measurement test.
- (3) Both adapter and battery are evaluated, operated the battery is the worst and recorded as below test data

3.3 BLOCK DIGRAM SHOWING THE CONFIGURATION OF SYSTEM TESTED

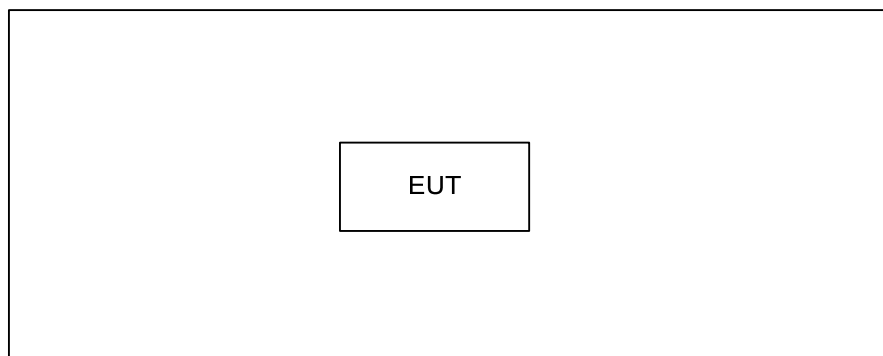

3.4 DESCRIPTION OF SUPPORT UNITS

The EUT has been tested as an independent unit together with other necessary accessories or support units. The following support units or accessories were used to form a representative test configuration during the tests.

Item	Equipment	Mfr/Brand	Model/Type No.	FCC ID	Series No.	Note
-	-	-	-	-	-	

Item	Shielded Type	Ferrite Core	Length	Note
-	-	-	-	

4. TEST RESULT

4.1 RADIATED RF OUTPUT POWER MEASUREMENT

4.1.1 LIMIT

The Radiated Peak Output Power shall be according to the specific rule Part 27.50(c)(9)& 27.50(d)(4)&27.50(h)(2)& RSS-139 section 6.4 that “Mobile/Portable station are limited to 1 watts e.i.r.p.” and 27.50(c)(9)&27.50(d)(4)&27.50(h)(2) RSS-139 section 6.4 specified that “Peak transmit power must be measure over any interval of continuous transmission using instrumentation calibration in terms of rms-equivalent voltage.

4.1.2 MEASURING INSTRUMENTS AND SETTING

Please refer to section 5 in this report. The following table is the setting of the Spectrum Analyzer.

Spectrum Parameters	Setting
Attenuation	Auto
Center Frequency	Low / middle / high channels
Span Frequency	10MHz
RB / VB	3MHz / 3MHz for Peak

4.1.3 TEST PROCEDURE

EIRP/ERP:

- All measurements were done at low, middle and high operational frequency range. RBW and VBW is 1MHz for GSM, GPRS & EDGE, 5MHz for WCDMA & CDMA, and 10MHz for LTE mode.
- Substitution method is used for E.I.R.P measurement. In the semi-anechoic chamber, EUT placed on the 0.8m height of Turn Table, rotated the table around 360 degrees to search the maximum radiation power and receiver antenna shall be rotated vertical and horizontal polarization and moved height from 1m to 4m to find the maximum polar radiated power. The “Read Value” is the spectrum reading the maximum power value.
- The substitution horn antenna is substituted for EUT at the same position and signals generator export the CW signal to the substitution antenna via a tx cable. Rotated the Turn Table and moved receiving antenna to find the maximum radiation power. Adjust output power level of S.G to get a Value of spectrum reading equal to “Read Value“ of step b. Record the power level of S.G
- E.R.P power can be calculated form E.I.R.P power by subtracting the gain of Integral, E.R.P power=E.I.P.R power-2.15dBi.

4.1.4 TEST SETUP LAYOUT EIRP Power Measurement

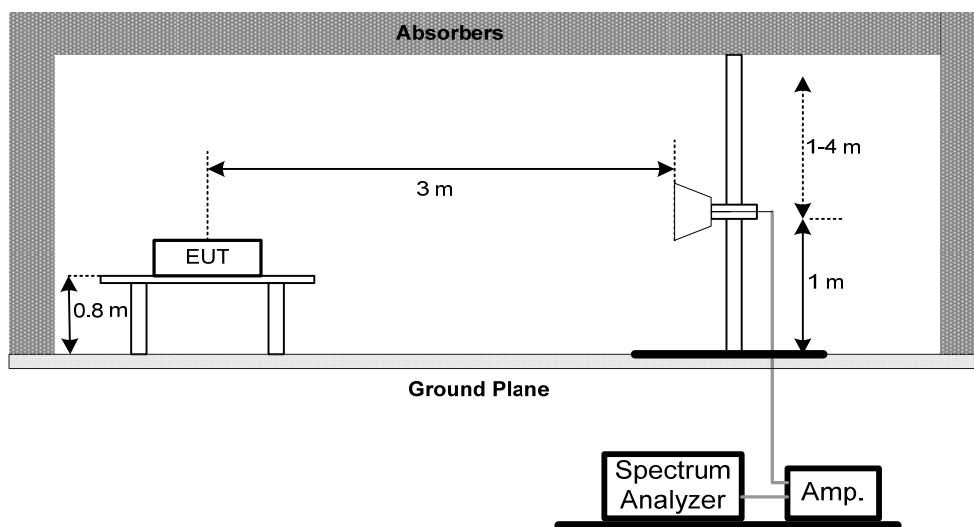

4.1.5 TEST DEVIATION

There is no deviation with the original standard.

4.1.6 EUT OPERATION DURING TEST

The BS simulator was used to set the TX channel and power level and modulate the TX signal.

4.1.7 EUT TEST CONDITIONS

Temperature: 25°C
 Relative Humidity: 55%
 Test Voltage: DC 3.8V

4.1.8 TEST RESULTS

Please refer to the Attachment A.

4.2 99% OCCUPIED BANDWIDTH MEASUREMENT

4.2.1 LIMIT

According to FCC 27.53(h) specified that emission bandwidth is defined as the width of the signal between two points, one below the carrier center frequency and one above the carrier center frequency, outside of which all emissions are attenuated at least 26 dB below the transmitter power.

4.2.2 MEASURING INSTRUMENTS AND SETTING

Please refer to section 5 in this report. The following table is the setting of the Spectrum Analyzer.

Spectrum Parameters	Setting
Attenuation	Auto
Span Frequency	Encompass the entire emissions bandwidth (EBW) of the signal
RB	30 kHz
VB	100 kHz
Trace	Max Hold

4.2.3 TEST PROCEDURE

1. The transmitter output (antenna port) was connected to the spectrum analyzer.
2. Used measurement function of spectrum to measure the 99% occupied bandwidth..

4.2.4 TEST SETUP LAYOUT

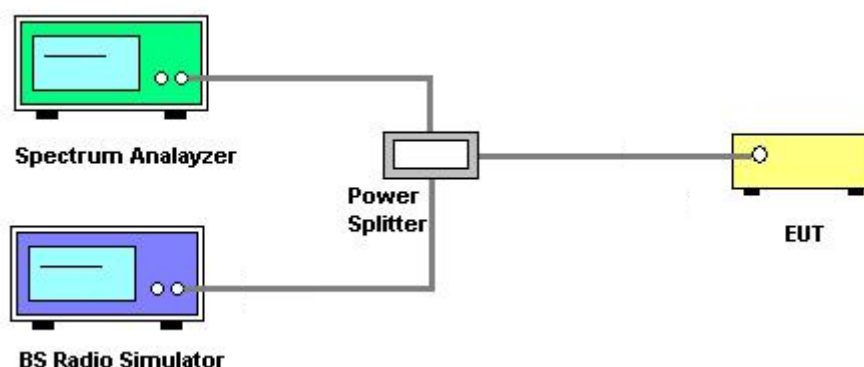

4.2.5 TEST DEVIATION

There is no deviation with the original standard.

4.2.6 EUT OPERATION DURING TEST

The BS simulator was used to set the TX channel and power level and modulate the TX signal.

4.2.7 EUT TEST CONDITIONS

Temperature: 25°C
 Relative Humidity: 55%
 Test Voltage: DC 3.8V

4.2.8 TEST RESULTS

Please refer to the Attachment B.

4.3 SPURIOUS EMISSIONS AT ANTENNA TERMINALS MEASUREMENT

4.3.1 LIMIT

In the FCC 27.53(h) & RSS-139 section 6.5, on any frequency outside a licensee's frequency block within GSM spectrum, the power of any emission shall be attenuated below the transmitter power (P) by at least $43 + 10 \log (P)$ dB. The limit translates in the relevant power range (1 to 0.001W). At 1W (Power Control Level 0) the specified minimum attenuation becomes 43dB and the limit of emission equal to -13dBm .

4.3.2 MEASURING INSTRUMENTS AND SETTING

Please refer to section 5 in this report. The following table is the setting of the Spectrum Analyzer.

Spectrum Parameters	Setting
Attenuation	Auto
Start Frequency	30MHz
Stop Frequency	10th carrier harmonic
RB / VB	1 MHz / 1MHz for Peak

4.3.3 TEST PROCEDURES

1. The EUT was set up for the maximum peak power with WCDMA link data modulation. The power was measured with R&S Spectrum Analyzer. All measurements were done at 3 channels, 1312, 1413, 1513 (low, middle and high operational frequency range.)
2. The conducted spurious emission used the power splitter via EUT RF power connector between simulation base station and spectrum analyzer. This splitter loss and cable loss are the worst loss 4.5dB in the transmitted path track.
3. When the spectrum scanned from 9kHz to 3GHz, it shall be connected to the band reject filter attenuated the carried frequency. The spectrum set RB/VB 1MHz.
4. When the spectrum scanned from 3GHz to 10GHz, it shall be connected to the high pass filter attenuated the carried frequency. The spectrum set RB/VB 1MHz.

4.3.4 TEST SETUP LAYOUT

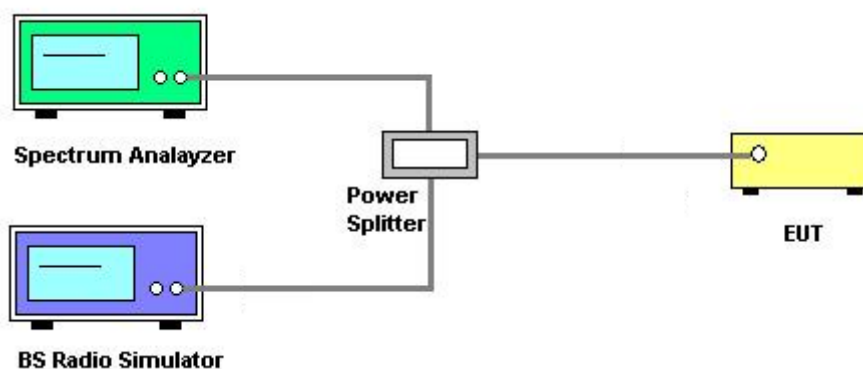

4.3.5 TEST DEVIATION

There is no deviation with the original standard.

4.3.6 EUT OPERATION DURING TEST

The BS simulator was used to set the TX channel and power level and modulate the TX signal.

4.3.7 EUT TEST CONDITIONS

Temperature: 25°C
Relative Humidity: 55%
Test Voltage:DC 3.8V

4.3.8 TEST RESULTS

Please refer to the Attachment C.

4.4 SPURIOUS RADIATED EMISSIONS MEASUREMENT

4.4.1 LIMIT

In the FCC 27.53(h) & RSS-139 section 6.5, On any frequency outside a licensee's frequency block within GSM spectrum, the power of any emission shall be attenuated below the transmitter power (P) by at least $43 + 10 \log (P)$ dB. The limit translates in the relevant power range (1 to 0.001W). At 1W(Power Control Level 0) the specified minimum attenuation becomes 43dB and the limit of emission equal to -13dBm . At 0.001W(Power Control Level 15) the specified minimum attenuation becomes 13dB and the emission of limit equal to -13dBm . So the limit of emission is the same absolute specified line.

4.4.2 MEASURING INSTRUMENTS AND SETTING

Please refer to section 5 in this report. The following table is the setting of the Spectrum Analyzer.

Spectrum Parameters	Setting
Attenuation	Auto
Start Frequency	30 MHz
Stop Frequency	10th carrier harmonic
Detector	Positive Peak
Span	100 MHz
Sweep Time	1s
RB / VB	1 MHz / 1MHz
Attenuation	Positive Peak

4.4.3 TEST PROCEDURES

1. Substitution method is used for E.I.R.P measurement. In the semi-anechoic chamber, EUT placed on the 0.8m height of Turn Table, rotated the table around 360 degrees to search the maximum radiation power and receiver antenna shall be rotated vertical and horizontal polarization and moved height from 1m to 4m to find the maximum polar radiated power. The "Read Value" is the spectrum reading the maximum power value.
2. The substitution horn antenna is substituted for EUT at the same position and signals generator export the CW signal to the substitution antenna via a TX cable. Rotated the Turn Table and moved receiving antenna to find the maximum radiation power. Adjust output power level of S.G to get a Value of spectrum reading equal to "Read Value " of step a. Record the power level of S.G
3. EIRP = Output power level of S.G – TX cable loss + Antenna gain of substitution horn.
4. E.R.P power can be calculated form E.I.R.P power by subtracting the gain of dipole, E.R.P power = E.I.P.R power - 2.15dBi.
5. The resolution bandwidth and video bandwidth of test receiver/spectrum analyzer is 1MHz/3MHz.

4.4.4 TEST SETUP LAYOUT

This test setup layout is the same as that shown in **section 4.1.3**.

4.4.5 TEST DEVIATION

There is no deviation with the original standard.

4.4.6 EUT OPERATION DURING TEST

The BS simulator was used to set the TX channel and power level and modulate the TX signal.

4.4.7 EUT TEST CONDITIONS

Temperature: 25°C

Relative Humidity: 55%

Test Voltage: DC 3.8V

4.4.8 TEST RESULTS

Please refer to the Attachment D.

4.5 BAND EDGE MEASUREMENT

4.5.1 LIMIT

According to FCC 27.53(h) & RSS-139 section 6.5 specified that power of any emission outside of the authorized operating frequency ranges must be attenuated below the transmitting power (P) by a factor of at least $43 + 10 \log(P)$ dB . In the 1 MHz bands immediately outside and adjacent to the frequency block a resolution bandwidth of at least one percent of the emission bandwidth of the fundamental emission of the transmitter may be employed. Then we measure that the bandwidth is about 300kHz and the resolution bandwidth is 3kHz.

4.5.2 MEASURING INSTRUMENTS AND SETTING

Please refer to section 5 in this report. The following table is the setting of the Spectrum Analyzer.

Spectrum Parameters	Setting
Attenuation	Auto
Span Frequency	5 MHz
RB / VB	10 kHz /30 kHz
Trace	Sample
Sweep Time	Auto

4.5.3 TEST PROCEDURES

1. The EUT was set up for the maximum peak power with WCDMA link data modulation. The power was measured with R&S Spectrum Analyzer. All measurements were done at 2 channels, 1312 and 1513(low and high operational frequency range.)
2. The band edge measurement used the power splitter via EUT RF power connector between simulation base station and spectrum analyzer. The splitter loss and cable loss are the worst loss 4dB in the transmitted path track.
3. The center frequency of spectrum is the band edge frequency and span is 5 MHz. RB of the spectrum is 10kHz and VB of the spectrum is 30KHz.
4. Record the Sample trace plot into the test report.

4.5.4 TEST SETUP LAYOUT

This test setup layout is the same as that shown in section 4.2.4.

4.5.5 TEST DEVIATION

There is no deviation with the original standard.

4.5.6 EUT OPERATION DURING TEST

The BS simulator was used to set the TX channel and power level and modulate the TX signal.

4.5.7 EUT TEST CONDITIONS

Temperature: 25°C

Relative Humidity: 55%

Test Voltage: DC 3.8V

4.5.8 TEST RESULTS

Please refer to the Attachment E.

4.6 FREQUENCY STABILITY MEASUREMENT

4.6.1 LIMIT

According to the FCC part 27.54& RSS-139 section 6.3 shall be tested the frequency stability. The rule is defined that” The frequency stability shall be sufficient to ensure that the fundamental emission stays within the authorized frequency block.” The frequency error rate is according to the JTC standard that the frequency error rate shall be accurate to within 0.1 ppm of the received frequency from the base station. The test extreme voltage is according to the 2.1055(d)(1) Vary primary supply voltage from 85 to 115 percent of the nominal value for other than hand carried battery equipment and the extreme temperature rule is comply with the 2.1055(a)(1) $-30^{\circ}\text{C} \sim 50^{\circ}\text{C}$.

4.6.2 MEASURING INSTRUMENTS AND SETTING

Please refer to section 5 in this report. The following table is the setting of the BS Simulator.

Spectrum Parameters	Setting
Frequency Error	The maximum of transmit frequency error

4.6.3 TEST PROCEDURES

1. The transmitter output (antenna port) was connected to the BS Simulator.
2. The BS simulator was used to set the TX channel and power level and modulate the TX signal with different bit patterns.
3. BS simulator used the frequency error function and measured the peak frequency error.
Power must be removed when changing from one temperature to another or one voltage to another voltage. Power warm up is at least 15 min and power applied should perform before recording frequency error.
The each temperature step shall be at least 0.5 hours, consider the EUT could be test under the stability condition.
4. EUT is connected the external power supply to control the DC input power. The various Volts from the minimum 3.1 Volts to 4.3 Volts. Each step shall be record the frequency error rate.
5. The test extreme voltage is to change the primary supply voltage from 85 to 115 percent of the nominal value.
6. Reduced operating temperature range of $-10^{\circ} \sim +45^{\circ} \text{C}$ as defined in Operational description and declared in User Manual.

4.6.4 TEST SETUP LAYOUT

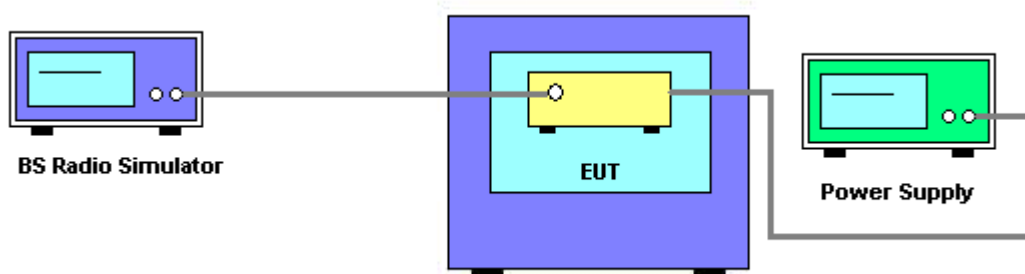

4.6.5 TEST DEVIATION

There is no deviation with the original standard.

4.6.6 EUT OPERATION DURING TEST

The EUT was programmed to be in continuously un-modulation transmitting mode.

4.6.7 EUT TEST CONDITIONS

Temperature: 25°C
Relative Humidity: 55%
Test Voltage: DC 3.8V

4.6.8 TEST RESULTS

Please refer to the Attachment F.

4.7 PEAK TO AVERAGE RATIO

4.7.1 LIMIT

In the FCC 27.50) & &RSS-139 section 6.4

Peak transmit power shall be measured over any interval of continuous transmission using instrumentation calibrated in terms of rms-equivalent voltage.

The measurement results shall be properly adjusted for any instrument limitations, such as detector re-sponse times, limited resolution bandwidth capability when compared to the emission bandwidth, etc., so as to obtain a true peak measurement for the emission in question over the full bandwidth of the channel.

To measure transmissions in this band using an average power technique, the peak to-average ratio (PAR) of the transmission shall not exceed 13 dB.

4.7.2 TEST PROCEDURES

1. Set resolution/measurement bandwidth \geq signal's occupied bandwidth;
2. Set the number of counts to a value that stabilizes the measured CCDF curve;

4.7.3 TEST SETUP LAYOUT

Please refer to section 3.4 in this report.

4.7.4 TEST DEVIATION

There is no deviation with the original standard.

4.7.5 EUT OPERATION DURING TEST

The BS simulator was used to set the TX channel and power level and modulate the TX signal.

4.7.6 EUT TEST CONDITIONS

Temperature: 25°C

Relative Humidity: 55%

Test Voltage:DC 3.8V

4.7.7 TEST RESULTS

Please refer to the Attachment G.

5. LIST OF MEASUREMENT EQUIPMENTS

Radiated Emission & ERP or EIRP Measurement					
Item	Kind of Equipment	Manufacturer	Type No.	Serial No.	Calibrated until
1	Antenna	Schwarbeck	VULB9160	9160-3232	Mar. 28, 2016
2	Amplifier	HP	8447D	2944A09673	Nov. 17, 2015
3	Receiver	AGILENT	N9038A	MY52130039	Sep. 30, 2015
4	Test Cable	emci	LMR-400(30MHz-1GHz)	C-01	Jun. 28, 2016
5	Controller	CT	SC100	N/A	N/A
6	Antenna	ETS	3115	00075789	Mar. 28, 2016
7	Amplifier	Agilent	8449B	3008A02274	Nov. 02, 2015
8	Receiver	AGILENT	N9038A	MY52130039	Sep. 30, 2015
9	Test Cable	emci	EMC104-SM-S M-10000(1GHz – 26.5GHz)	C-68	Jun. 28, 2016
10	Controller	CT	SC100	N/A	N/A
11	Broad-Band Horn Antenna	Schwarzbeck	BBHA 9170	9170319	Mar. 28, 2016
12	Microwave Preamplifier With Adaptor	EMC INSTRUMENT	EMC2654045	980039 & HA01	Mar. 28, 2016
13	Double Ridged Guide Antenna	ETS-LINDGREN	3115	00075846	Mar. 28, 2016
14	Antenna	SCHWARZBECK	VULB 9160	9160-3231	Mar. 28, 2016
15	MXG Analog Signal Generator	Agilent	N5181A	MY49060710	Nov. 02, 2015
16	Signal Generator	R&S	SMR40	100504	Mar. 28, 2016
17	Measurement Software	Farad	EZ-EMC Ver.NB-03A1-01	N/A	N/A

Antenna Conducted Spurious Emission Measurement

Item	Kind of Equipment	Manufacturer	Type No.	Serial No.	Calibrated until
1	EXA Spectrum Analyzer	Agilent	N9010A	MY50520044	Mar. 28, 2016
2	Wireless Communication Test SET	(8960 Series) Agilent	E5515C	MY48364183	Mar. 28, 2016
3	POWER SPLITTER	Mini-Circuits	ZFRSC-123-S+	331000910-1	Mar. 17, 2016
4	Test Cable	N/A	CL-CB12-00 1	N/A	Oct. 22, 2015
5	Test Cable	N/A	CL-CB12-00 4	N/A	Oct. 22, 2015

Band Edge Measurement

Item	Kind of Equipment	Manufacturer	Type No.	Serial No.	Calibrated until
1	EXA Spectrum Analyzer	Agilent	N9010A	MY50520044	Mar. 28, 2016
2	Wireless Communication Test SET	(8960 Series) Agilent	E5515C	MY48364183	Mar. 28, 2016
3	POWER SPLITTER	Mini-Circuits	ZFRSC-123-S+	331000910-1	Mar. 17, 2016
4	Test Cable	N/A	CL-CB12-00 1	N/A	Oct. 22, 2015
5	Test Cable	N/A	CL-CB12-00 4	N/A	Oct. 22, 2015

99% Occupied Bandwidth Measurement

Item	Kind of Equipment	Manufacturer	Type No.	Serial No.	Calibrated until
1	EXA Spectrum Analyzer	Agilent	N9010A	MY50520044	Mar. 28, 2016
2	Wireless Communication Test SET	(8960 Series) Agilent	E5515C	MY48364183	Mar. 28, 2016
3	POWER SPLITTER	Mini-Circuits	ZFRSC-123-S+	331000910-1	Mar. 17, 2016
4	Test Cable	N/A	CL-CB12-00 1	N/A	Oct. 22, 2015
5	Test Cable	N/A	CL-CB12-00 4	N/A	Oct. 22, 2015

Frequency Stability Measurement					
Item	Kind of Equipment	Manufacturer	Type No.	Serial No.	Calibrated until
1	Wireless Communication Test SET	(8960 Series) Agilent	E5515C	MY48364183	Mar. 28, 2016
2	POWER SPLITTER	Mini-Circuits	ZFRSC-123-S+	331000910-1	Mar. 17, 2016
3	Test Cable	N/A	CL-CB12-00 1	N/A	Oct. 22, 2015
4	Const Temp. & Humidity Chamber	GIANT FORCE	ITH-1200-40-CP-AR	IAA1210-003	Aug. 01, 2015
5	DC power supply	GW Instek	GPC-30300N	EK880675	Oct.12, 2015

Peakto Average Ratio					
Item	Kind of Equipment	Manufacturer	Type No.	Serial No.	Calibrated until
1	EXA Spectrum Analyzer	Agilent	N9010A	MY50520044	Mar. 28, 2016
2	Wireless Communication Test SET	(8960 Series) Agilent	E5515C	MY48364183	Mar. 28, 2016
3	POWER SPLITTER	Mini-Circuits	ZFRSC-123-S+	331000910-1	Mar. 17, 2016
4	Test Cable	N/A	CL-CB12-00 1	N/A	Oct. 22, 2015
5	Test Cable	N/A	CL-CB12-00 4	N/A	Oct. 22, 2015

Remark: "N/A" denotes no model name, serial no. or calibration specified.
All calibration period of equipment list is one year.

6. EUT TEST PHOTO

Radiated Measurement Photos

9KHz to 30MHz



Radiated Measurement Photos

30MHz to 1000MHz



Radiated Measurement Photos

Above 1000MHz



ATTACHMENT A - RADIATED RF OUTPUT POWER

Test Mode :	TX Mode
-------------	---------

WCDMA Band IV		Radiated Power (dBm)			Max. Limit (dBm)	Result
		Channel 1312	Channel 1413	Channel 1513		
RMC	H	20.19	20.61	20.74	30	Complies

WCDMA Band IV		Conducted Power(dBm)		
		Channel 1312	Channel 1413	Channel 1513
WCDMA	12.2kbps RMC	22.95	22.89	22.86
	64kbps RMC	22.95	22.90	22.86
	144kbps RMC	22.95	22.89	22.86
	384kbps RMC	22.95	22.90	22.86
HSDPA	Subtest 1	22.13	21.98	22.02
	Subtest 2	22.10	22.10	22.02
	Subtest 3	21.60	21.51	21.59
	Subtest 4	21.63	21.52	21.55
HSUPA	Subtest 1	22.11	22.01	22.05
	Subtest 2	21.53	21.49	21.52
	Subtest 3	22.12	22.02	22.06
	Subtest 4	22.04	22.05	22.02
	Subtest 5	22.02	21.97	21.95
HSPA+	Subtest 1	22.03	22.01	21.96
	Subtest 2	21.92	21.92	21.96
	Subtest 3	21.54	21.57	21.6
	Subtest 4	21.55	21.54	21.6
DC-HSD PA	Subtest 1	22.13	21.98	22.02
	Subtest 2	22.10	22.10	22.02
	Subtest 3	21.60	21.51	21.59
	Subtest 4	21.63	21.52	21.55

REMARKS:

1. Radiated Output Power(dBm)=Raw Value(dBm) + Correction Factor(dB) +Ant Gain(dBi)
2. Correction Factor(dB) = Power Splitter Loss(dB) + Cable Loss(dB)
3. The antenna gain is -1.75dBi
4. Tests have been conducted for both vertical and horizontal plane and the worst case was found in horizontal plane and the results were selected and recorded in the report

ATTACHMENT B - 99% OCCUPIED BANDWIDTH

Test Mode : TX Mode Configuration WCDMA-12.2K RMC				
Channel	Frequency	99% OBW (MHz)	-26dBc Bandwidth	Result
1312	1712.400MHz	4.14	4.73	Complies
1413	1732.600 MHz	4.13	4.70	Complies
1513	1752.600 MHz	4.13	4.73	Complies

99% Occupied Bandwidth channel 1312

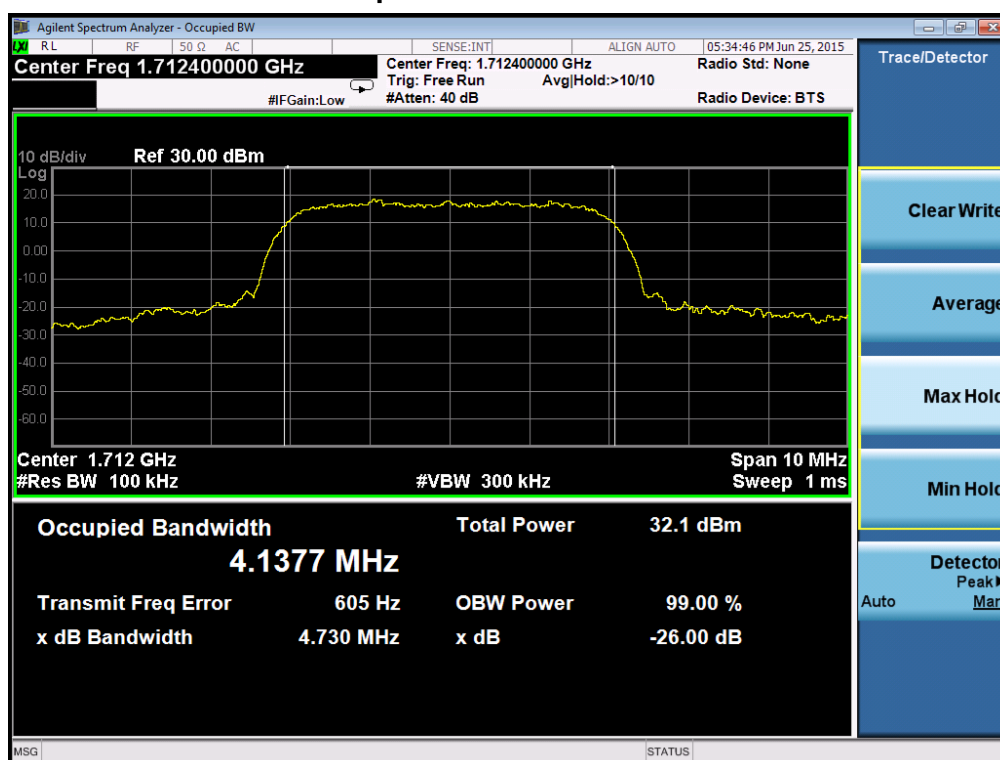

99% Occupied Bandwidth channel 1413

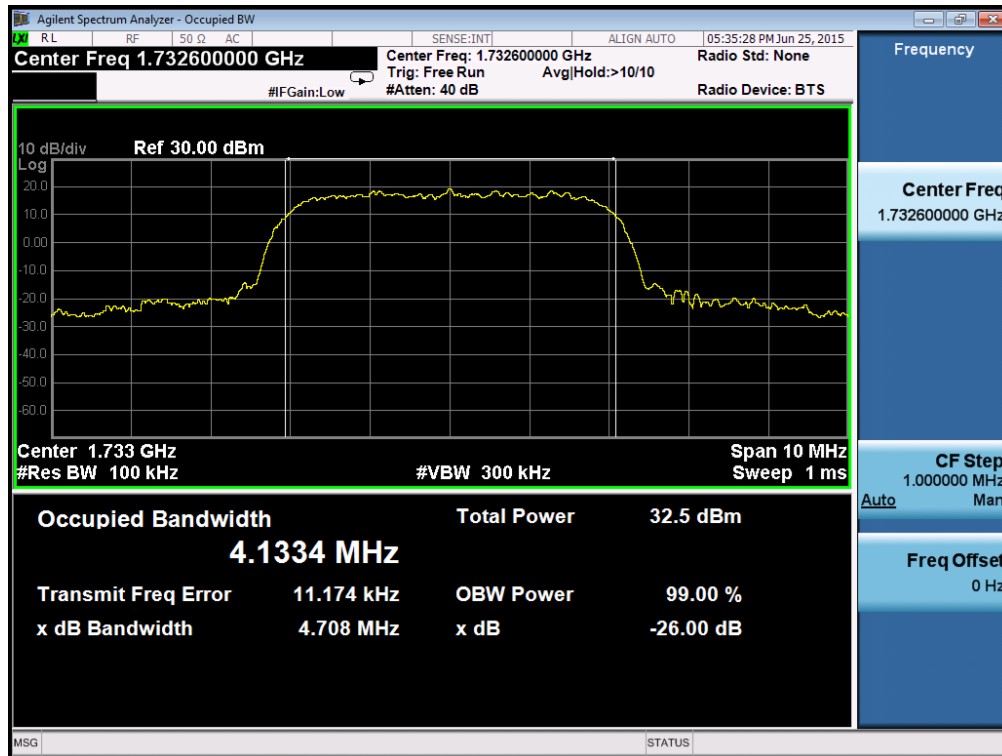

99% Occupied Bandwidth channel 1513

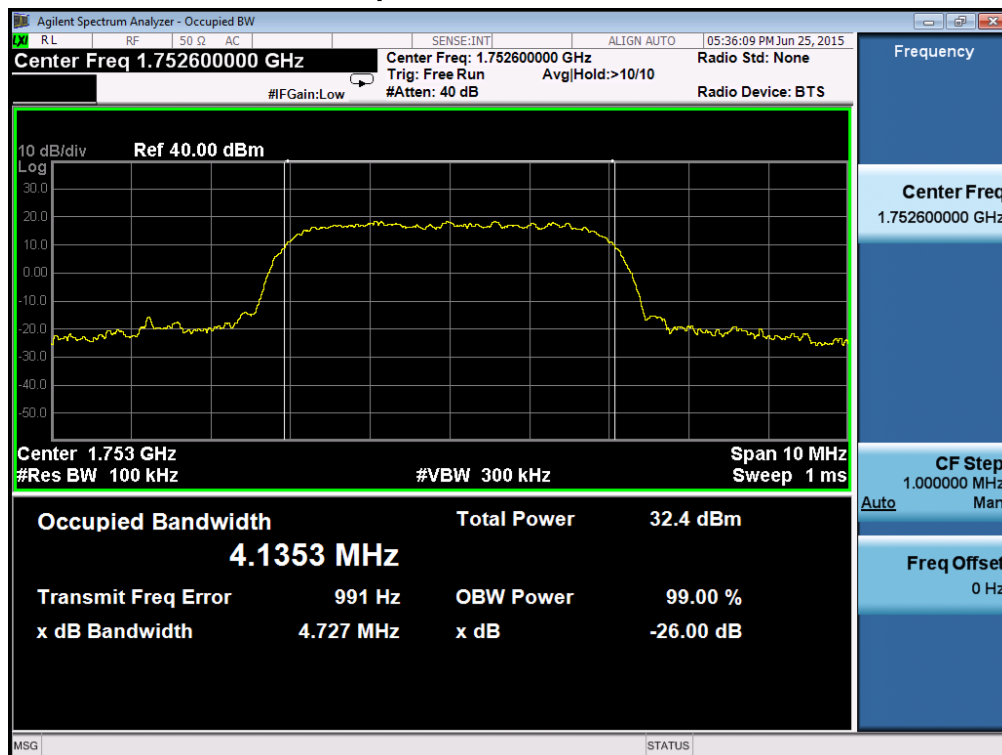

ATTACHMENT C - SPURIOUS EMISSIONS AT ANTENNA TERMINALS

Conducted Spurious of Configuration- 12.2K RMC channel 1413

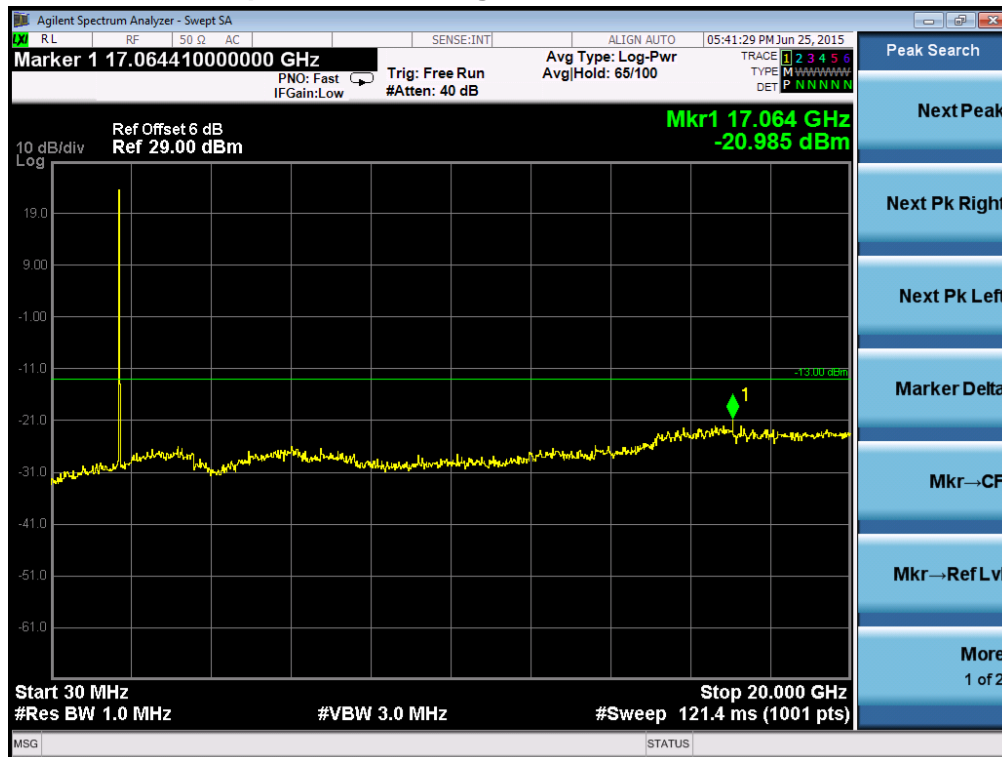

ATTACHMENT D - SPURIOUS RADIATED EMISSION

Test Mode : TX CH1413-12.2K RMC

Vertical

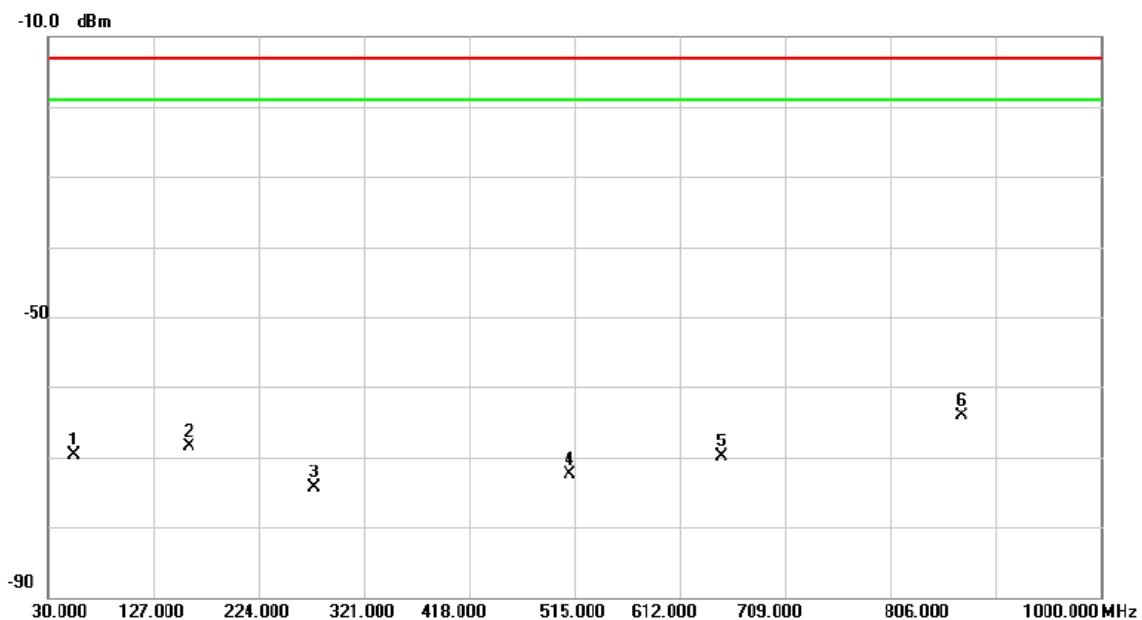

No.	Mk.	Freq. MHz	Reading Level dBm	Correct Factor dB	Measure- ment dBm	Limit dBm	Margin dB	Detector	Comment
1		54.2500	-72.15	2.40	-69.75	-13.00	-56.75	peak	
2		159.9800	-71.64	3.18	-68.46	-13.00	-55.46	peak	
3		274.4400	-76.72	2.39	-74.33	-13.00	-61.33	peak	
4		510.1500	-79.94	7.53	-72.41	-13.00	-59.41	peak	
5		649.8300	-80.07	10.12	-69.95	-13.00	-56.95	peak	
6	*	870.9900	-77.76	13.72	-64.04	-13.00	-51.04	peak	

Test Mode : TX CH1413-12.2K RMC

Horizontal

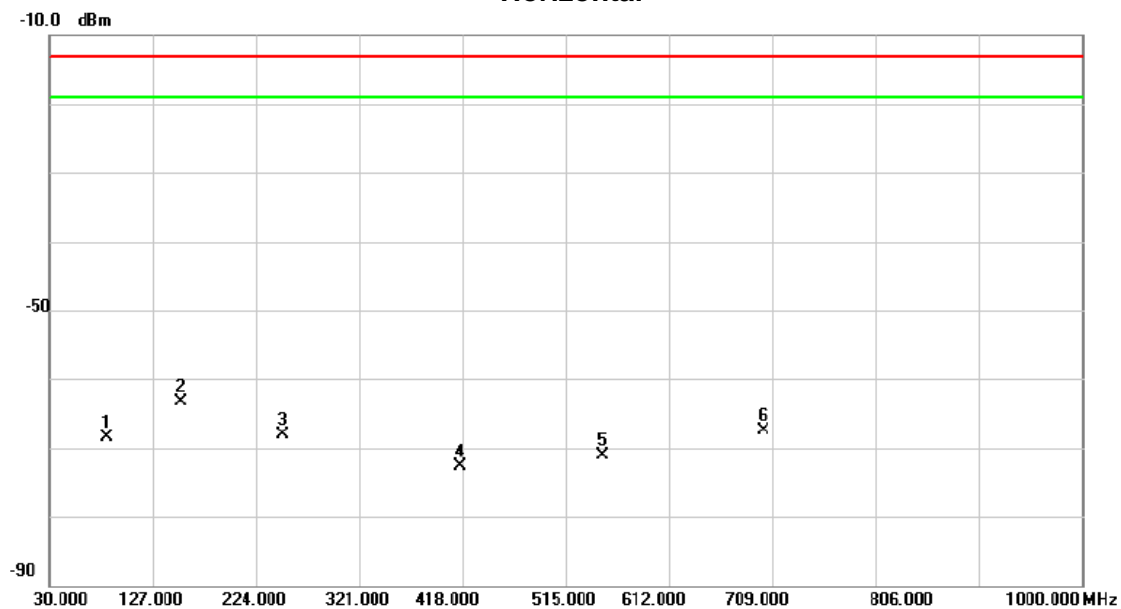

No.	Mk.	Freq. MHz	Reading Level dBm	Correct Factor dB	Measure- ment dBm	Limit dBm	Margin dB	Detector	Comment
1		83.3500	-60.72	-7.76	-68.48	-13.00	-55.48	peak	
2	*	153.1900	-67.06	3.76	-63.30	-13.00	-50.30	peak	
3		249.2200	-69.99	1.91	-68.08	-13.00	-55.08	peak	
4		416.0600	-79.45	6.68	-72.77	-13.00	-59.77	peak	
5		549.9200	-79.18	8.10	-71.08	-13.00	-58.08	peak	
6		700.2700	-81.51	13.97	-67.54	-13.00	-54.54	peak	

Test Mode : TX CH1413-12.2K RMC

Vertical

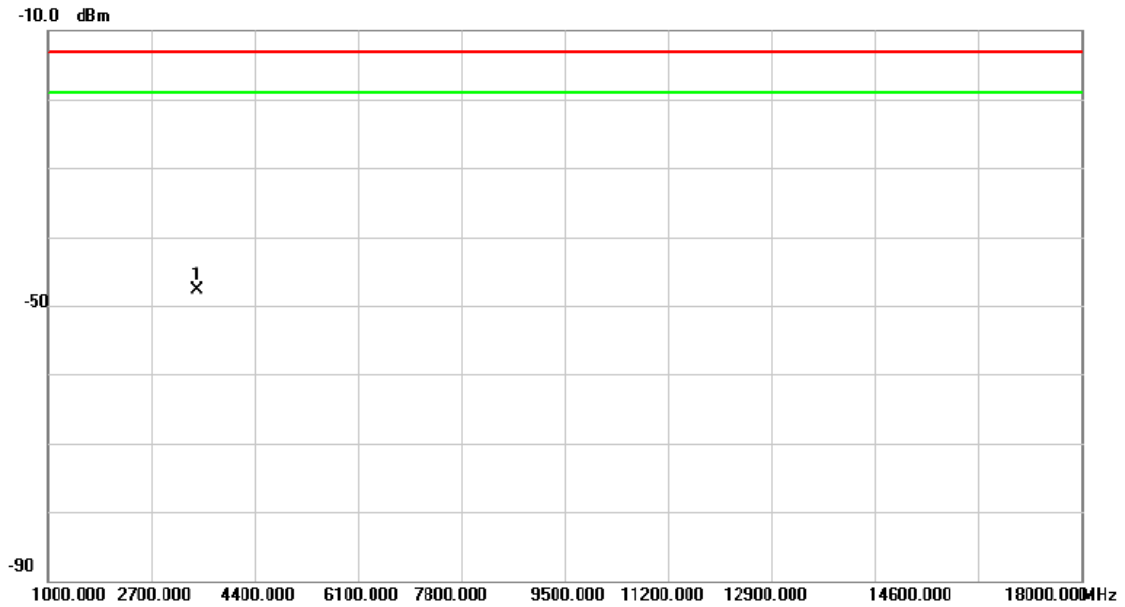

No.	Mk.	Freq. MHz	Reading Level dBm	Correct Factor dB	Measure- ment dBm	Limit dBm	Margin dB	Detector	Comment
1	*	3463.620	-55.90	8.16	-47.74	-13.00	-34.74	peak	

Test Mode : TX CH1413-12.2K RMC

Horizontal

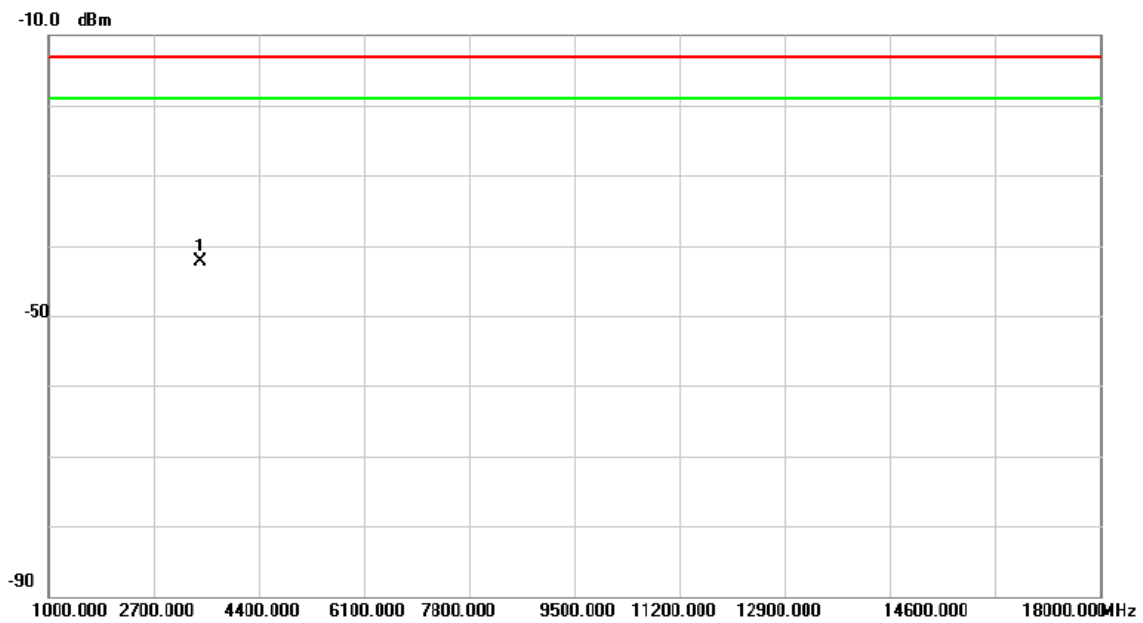

No.	Mk.	Freq. MHz	Reading Level dBm	Correct Factor dB	Measure- ment dBm	Limit dBm	Margin dB	Detector	Comment
1	*	3466.780	-53.33	10.94	-42.39	-13.00	-29.39	peak	

ATTACHMENT E - BAND EDGE

Band Edge on Configuration WCDMA- 12.2K RMC / Channel 1312-CONDUCTED MODE

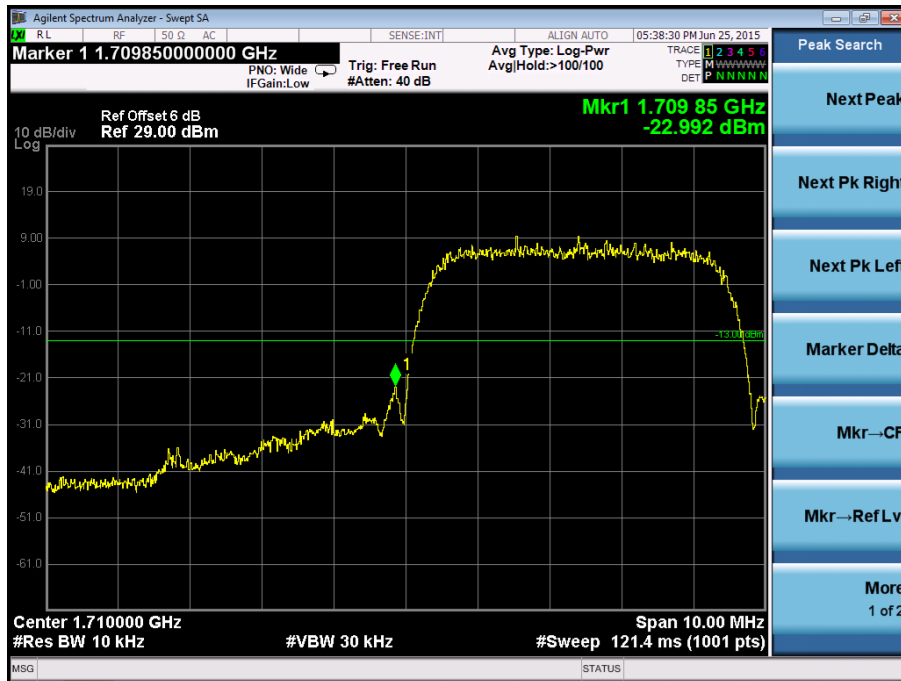

Band Edge on Configuration WCDMA- 12.2K RMC / Channel 1513-CONDUCTED MODE



ATTACHMENT F - FREQUENCY STABILITY

Test Mode :	WCDMA CH1312
-------------	--------------

Voltage vs. Frequency Stability

Voltage(Volts)	Frequency Error (Hz)	Frequency Error (ppm)	Limit(ppm)
-10	7.65	0.00441533	2.5
0	8.16	0.004709685	2.5
10	5.06	0.002920466	2.5
20	8.33	0.004807803	2.5
30	7.86	0.004536535	2.5
40	5.98	0.00345146	2.5
45	7.03	0.004057486	2.5
Max. Deviation (ppm)	9.35	0.005396514	2.5

Temperature vs. Frequency Stability

Temperature(°C)	Frequency Error (Hz)	Frequency Error (ppm)	Limit(ppm)
3.8	9.64	0.005563892	2.5
3.5	7.68	0.004432645	2.5
4.35	6.29	0.003630382	2.5
Max. Deviation (ppm)	9.64	0.005563892	2.5

ATTACHMENT G - PEAK TO AVERAGE RATIO

Peak to Average Ratio of Configuration- 12.2K RMC channel 1413

