

# FCC&IC Radio Test Report

**FCC ID: 2ABZ2-A2005**

**IC: 12739A-A2005**

This report concerns (check one):  Original Grant  Class II Change

**Project No.** : 1506C242  
**Equipment** : Mobile Phone  
**Model Name** : ONE A2005  
**Applicant** : OnePlus Technology (Shenzhen) Co., Ltd.  
**Address** : 18/F, Tower C, Tai Ran Building, No.8 Tai Ran Road,  
Shenzhen, China

**Date of Receipt** : Jun. 13, 2015  
**Date of Test** : Jun. 13, 2015 ~ Jul. 03, 2015  
**Issued Date** : Jul. 06, 2015  
**Tested by** : BTL Inc.

**Testing Engineer**

: David Mao  
(David Mao)

**Technical Manager**

: Leo Hung  
(Leo Hung)

**Authorized Signatory**

: Steven Lu  
(Steven Lu)

## **B T L I N C .**

No.3, Jinshagang 1st Road, Shixia, Dalang Town, Dongguan,  
Guangdong, China.

TEL: +86-769-8318-3000 FAX: +86-769-8319-6000

### **Declaration**

**BTL** represents to the client that testing is done in accordance with standard procedures as applicable and that test instruments used has been calibrated with the standards traceable to National Measurement Laboratory (**NML**) of **R.O.C.**, or National Institute of Standards and Technology (**NIST**) of **U.S.A.**

**BTL's** reports apply only to the specific samples tested under conditions. It is manufacture's responsibility to ensure that additional production units of this model are manufactured with the identical electrical and mechanical components. **BTL** shall have no liability for any declarations, inferences or generalizations drawn by the client or others from **BTL** issued reports.

**BTL's** report must not be used by the client to claim product certification, approval, or endorsement by NVLAP, NIST, or any agency of the Federal Government.

This report is the confidential property of the client. As a mutual protection to the clients, the public and **BTL-self**, extracts from the test report shall not be reproduced except in full with **BTL's** authorized written approval.

**BTL's** laboratory quality assurance procedures are in compliance with the **ISO Guide17025** requirements, and accredited by the conformity assessment authorities listed in this test report.

### **Limitation**

For the use of the authority's logo is limited unless the Test Standard(s)/Scope(s)/Item(s) mentioned in this test report is (are) included in the conformity assessment authorities acceptance respective.

<b>Table of Contents</b>	<b>Page</b>
<b>REPORT ISSUED HISTORY</b>	<b>6</b>
<b>1 . CERTIFICATION</b>	<b>7</b>
<b>2 . SUMMARY OF TEST RESULTS</b>	<b>8</b>
2.1 TEST FACILITY	9
2.2 MEASUREMENT UNCERTAINTY	9
<b>3 . GENERAL INFORMATION</b>	<b>10</b>
3.1 GENERAL DESCRIPTION OF EUT	10
3.2 DESCRIPTION OF TEST MODES	11
3.3 BLOCK DIGRAM SHOWING THE CONFIGURATION OF SYSTEM TESTED	12
3.4 DESCRIPTION OF SUPPORT UNITS	12
<b>4 . TEST RESULT</b>	<b>13</b>
4.1 RADIATEDRF OUTPUT POWER MEASUREMENT	13
4.1.1 LIMIT	13
4.1.2 MEASURING INSTRUMENTS AND SETTING	13
4.1.3 TEST PROCEDURE	13
EIRP/ERP:	13
4.1.4 TESTSETUP LAYOUT	14
4.1.5 TESTDEVIATION	14
4.1.6 EUT OPERATIONDURING TEST	14
4.1.7 EUT TEST CONDITIONS	14
4.1.8 TEST RESULTS	14
4.2 99% OCCUPIED BANDWIDTH MEASUREMENT	15
4.2.1 LIMIT	15
4.2.2 MEASURING INSTRUMENTS AND SETTING	15
4.2.3 TEST PROCEDURE	15
4.2.4 TESTSETUP LAYOUT	15
4.2.5 TESTDEVIATION	15
4.2.6 EUT OPERATIONDURING TEST	15
4.2.7 EUT TEST CONDITIONS	15
4.2.8 TEST RESULTS	16
4.3 SPURIOUS EMISSIONS AT ANTENNA TERMINALS MEASUREMENT	17
4.3.1 LIMIT	17
4.3.2 MEASURING INSTRUMENTS AND SETTING	17
4.3.3 TEST PROCEDURES	17
4.3.4 TESTSETUP LAYOUT	17
4.3.5 TESTDEVIATION	17
4.3.6 EUT OPERATIONDURING TEST	17

<b>Table of Contents</b>	<b>Page</b>
4.3.7 EUT TEST CONDITIONS	18
4.3.8 TEST RESULTS	18
4.4 SPURIOUS RADIATED EMISSIONS MEASUREMENT	19
4.4.1 LIMIT	19
4.4.2 MEASURING INSTRUMENTS AND SETTING	19
4.4.3 TEST PROCEDURES	19
4.4.4 TESTSETUP LAYOUT	20
4.4.5 TESTDEVIATION	20
4.4.6 EUT OPERATIONDURING TEST	20
4.4.7 EUT TEST CONDITIONS	20
4.4.8 TEST RESULTS	20
4.5 BAND EDGE MEASUREMENT	21
4.5.1 LIMIT	21
4.5.2 MEASURING INSTRUMENTS AND SETTING	21
4.5.3 TEST PROCEDURES	21
4.5.4 TESTSETUP LAYOUT	21
4.5.5 TESTDEVIATION	21
4.5.6 EUT OPERATIONDURING TEST	21
4.5.7 EUT TEST CONDITIONS	21
4.5.8 TEST RESULTS	22
4.6 FREQUENCY STABILITY MEASUREMENT	23
4.6.1 LIMIT	23
4.6.2 MEASURING INSTRUMENTS AND SETTING	23
4.6.3 TEST PROCEDURES	23
4.6.4 TESTSETUP LAYOUT	23
4.6.5 TESTDEVIATION	23
4.6.6 EUT OPERATIONDURING TEST	23
4.6.7 EUT TEST CONDITIONS	24
4.6.8 TEST RESULTS	24
4.7 PEAK TO AVERAGE RATIO	25
4.7.1 LIMIT	25
4.7.2 TEST PROCEDURES	25
4.7.3 TESTSETUP LAYOUT	25
4.7.4 TESTDEVIATION	25
4.7.5 EUT OPERATIONDURING TEST	25
4.7.6 EUT TEST CONDITIONS	25
4.7.7 TEST RESULTS	25
5. LIST OF MEASUREMENT EQUIPMENTS	26
6. EUT TEST PHOTO	29
ATTACHMENT A -RADIATED RF OUTPUT POWER	32
ATTACHMENT B - 99% OCCUPIED BANDWIDTH	36

<b>Table of Contents</b>	<b>Page</b>
<b>ATTACHMENT C - SPURIOUS EMISSIONS AT ANTENNA TERMINALS</b>	<b>53</b>
<b>ATTACHMENTD - SPURIOUS RADIATED EMISSION</b>	<b>56</b>
<b>ATTACHMENTE - BAND EDGE</b>	<b>73</b>
<b>ATTACHMENTF - FREQUENCY STABILITY</b>	<b>82</b>
<b>ATTACHMENTG - PEAK TO AVERAGE RATIO</b>	<b>87</b>

### REPORT ISSUED HISTORY

Issued No.	Description	Issued Date
BTL-FICP-15-1506C242	Original Issue.	Jul. 06, 2015

## 1. CERTIFICATION

Equipment : Mobile Phone  
Brand Name :  ONEPLUS  
Model Name : ONE A2005  
Applicant : OnePlus Technology (Shenzhen) Co., Ltd.  
Manufacturer : OnePlus Technology (Shenzhen) Co., Ltd.  
Address : 18/F, Tower C, Tai Ran Building, No.8 Tai Ran Road, Shenzhen, China  
Factory : OnePlus Technology (Shenzhen) Co., Ltd.  
Address : 18/F, Tower C, Tai Ran Building, No.8 Tai Ran Road, Shenzhen, China  
Date of Test : Jun. 13, 2015 ~ Jul. 03, 2015  
Test Sample : ENGINEERING SAMPLE  
Standard(s) : 47 CFR FCC Part 27  
47 CFR FCC Part 2 &ANSI/TIA-603-C-2004  
RSS-130 Issue 1 October 2013

The above equipment has been tested and found compliance with the requirement of the relative standards by BTL Inc.

The test data, data evaluation, and equipment configuration contained in our test report (Ref No. BTL-FICP-15-1506C242) were obtained utilizing the test procedures, test instruments, test sites that has been accredited by the Authority of TAF according to the ISO-17025 quality assessment standard and technical standard(s).

**Test result included in this report is only for theLTE BAND XII approval part of the product.**

## 2. SUMMARY OF TEST RESULTS

Test procedures according to the technical standard(s):

FCC Part 27(H) & Part 2/ RSS-130 Issue 1				
Standard(s) Section		Test Item	Judgment	Remark
FCC	IC			
2.1047(d)	4.1	Modulation Characteristics	PASS	
2.1046(a) 27.50(d)(4)	4.4	Radiated RF Output	PASS	
2.1049(h) 27.53(h)	4.3(b)	99% Occupied Bandwidth	PASS	
2.1051 27.53(h)	4.6	Spurious Emissions at Antenna Terminal	PASS	
2.1053 27.53(h)	4.6.2	Spurious Radiated Emissions	PASS	
27.53(h)	4.6.1	Band Edge Emissions	PASS	
2.1055 27.54	4.3	Frequency Stability	PASS	
2.1046(d) 27.50(d)(5)	4.4	Peak to Average Ratio	PASS	

**NOTE:**

(1) "N/A" denotes test is not applicable in this test report



## 2.1 TEST FACILITY

The test facilities used to collect the test data in this report is at the location of No.3,Jinshagang 1st Road, Shixia, Dalang Town, Dongguan, Guangdong, China.

BTL's test firm number for FCC: 319330

BTL's test firm number for IC: 4428B-1

## 2.2 MEASUREMENT UNCERTAINTY

Where relevant, the following measurement uncertainty levels have been estimated for tests performed on the EUT as specified in CISPR 16-4-2. The BTL measurement uncertainty is less than the CISPR 16-4-2  $U_{\text{CISPR}}$  requirement.

The reported uncertainty of measurement  $y \pm U$ , where expanded uncertainty  $U$  is based on a standard uncertainty multiplied by a coverage factor of  $k=2$ , providing a level of confidence of approximately **95%** ◦



### A. Radiated Measurement :

Test Site	Method	Measurement Frequency Range	Ant. H / V	$U_1$ (dB)	Note
DG-CB03 (3m)	CISPR	9KHz~30MHz	V	3.79	
		9KHz~30MHz	H	3.57	
		30MHz ~ 200MHz	V	3.82	
		30MHz ~ 200MHz	H	3.78	
		200MHz ~ 1,000MHz	V	4.10	
		200MHz ~ 1,000MHz	H	4.06	
		1GHz~18GHz	V	3.12	
		1GHz~18GHz	H	3.68	
		18GHz~40GHz	V	4.15	
		18GHz~40GHz	H	4.14	

Note: Unless specifically mentioned, the uncertainty of measurement has not been taken into account to declare the compliance or non-compliance to the specification.

### 3. GENERAL INFORMATION

#### 3.1 GENERAL DESCRIPTION OF EUT

Equipment	Mobile Phone	
Brand Name		
Model Name	ONE A2005	
Model Difference	N/A	
Product Description	Operation Frequency	<b>LTE Band XII:</b> TX:699MHz~716MHz RX:729MHz~746MHz
	Modulation Type	QPSK;16QAM
	Bandwidth	1.4M/3M/5M/10M
	EIRP Output Power	21.95dBm
PowerSource	#1 DC Voltage supplied from AC/DC adapter. 1) Brand / Model:  / YJ1100 2) Brand / Model:  / AY0520 #2 Supplied from battery. Model: BLP597	
Power Rating	#1 1) I/P: 100-240V~ 50-60Hz 0.4A O/P: DC 5V 2A 2) I/P: 100-240V~ 50-60Hz 0.3A O/P: DC 5V 2A #2 DC 3.8V 3200mAh/3300mAh (min/typ)	

Note:

- For a more detailed features description, please refer to the manufacturer's specifications or the user's manual.
- Table for Filed Antenna @LTE Band XII

Ant.	Manufacture	Model Name	Antenna Type	Connector	Gain (dBi)
1	N/A	N/A	Internal	N/A	-5.27

### 3.2 DESCRIPTION OF TEST MODES

To investigate the maximum EMI emission characteristics generates from EUT, the test system was pre-scanning tested base on the consideration of following EUT operation mode or test configuration mode which possible have effect on EMI emission level. Each of these EUT operation mode(s) or test configuration mode(s) mentioned above was evaluated respectively.

Test Items	Worst TX Mode	Channel
Radiated RF Output	QPSK/16QAM	Lowest/Middle/Highest
Spurious Radiated Emissions	QPSK	Middle
Band Edge Emissions	QPSK/16QAM	Lowest/Highest
Frequency Stability	QPSK	Middle
99% Occupied Bandwidth	QPSK/16QAM	Lowest/Middle/Highest
Spurious Emissions at Antenna Terminal	QPSK	Lowest/Middle/Highest
Peak to Average Ratio	QPSK/16QAM	Middle

Note:

- (1) The measurements are performed at the highest, middle, lowest available channels.
- (2) The EUT is considered a portable unit; it was pre-tested on the positioned of each 3 axis. The worst case was found positioned on X-plane. Therefore only the test data of this X-plane was used for radiated emission measurement test.
- (3) Both adapter and battery are evaluated, operated the battery is the worst and recorded as below test data

### 3.3 BLOCK DIGRAM SHOWING THE CONFIGURATION OF SYSTEM TESTED

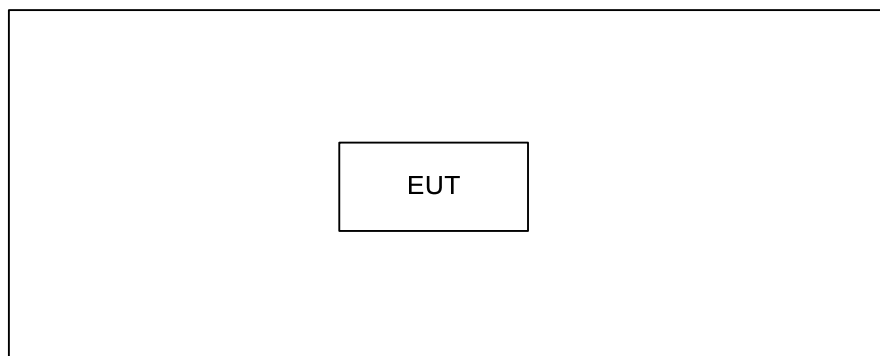

### 3.4 DESCRIPTION OF SUPPORT UNITS

The EUT has been tested as an independent unit together with other necessary accessories or support units. The following support units or accessories were used to form a representative test configuration during the tests.

Item	Equipment	Mfr/Brand	Model/Type No.	FCC ID	Series No.	Note
-	-	-	-	-	-	

Item	Shielded Type	Ferrite Core	Length	Note
-	-	-	-	-

## 4. TEST RESULT

### 4.1 RADIATEDRF OUTPUT POWER MEASUREMENT

#### 4.1.1 LIMIT

The Radiated Peak Output Power shall be according to the specific rule Part 27.50(c)(9)& 27.50(d)(4)&27.50(h)(2)& RSS-130 section 4.1 that “Mobile/Portable station are limited to 1 watts e.i.r.p.” and 27.50(c)(9)&27.50(d)(4)&27.50(h)(2) RSS-130 section 4.1 specified that “Peak transmit power must be measure over any interval of continuous transmission using instrumentation calibration in terms of rms-equivalent voltage.

#### 4.1.2 MEASURING INSTRUMENTS AND SETTING

Please refer to section 5 in this report. The following table is the setting of the Spectrum Analyzer.

Spectrum Parameters	Setting
Attenuation	Auto
Center Frequency	Low / middle / high channels
Span Frequency	10MHz
RB / VB	3MHz / 3MHz for Peak

#### 4.1.3 TEST PROCEDURE

##### EIRP/ERP:

- All measurements were done at low, middle and high operational frequency range. RBW and VBW is 1MHz for GSM, GPRS & EDGE, 5MHz for WCDMA & CDMA, and 10MHz for LTE mode.
- Substitution method is used for E.I.R.P measurement. In the semi-anechoic chamber, EUT placed on the 0.8m height of Turn Table, rotated the table around 360 degrees to search the maximum radiation power and receiver antenna shall be rotated vertical and horizontal polarization and moved height from 1m to 4m to find the maximum polar radiated power. The “Read Value” is the spectrum reading the maximum power value.
- The substitution horn antenna is substituted for EUT at the same position and signals generator export the CW signal to the substitution antenna via a tx cable. Rotated the Turn Table and moved receiving antenna to find the maximum radiation power. Adjust output power level of S.G to get a Value of spectrum reading equal to “Read Value“ of step b. Record the power level of S.G
- E.R.P power can be calculated form E.I.R.P power by subtracting the gain of Integral, E.R.P power=E.I.P.R power-2.15dBi.

#### 4.1.4 TESTSETUP LAYOUT EIRP Power Measurement

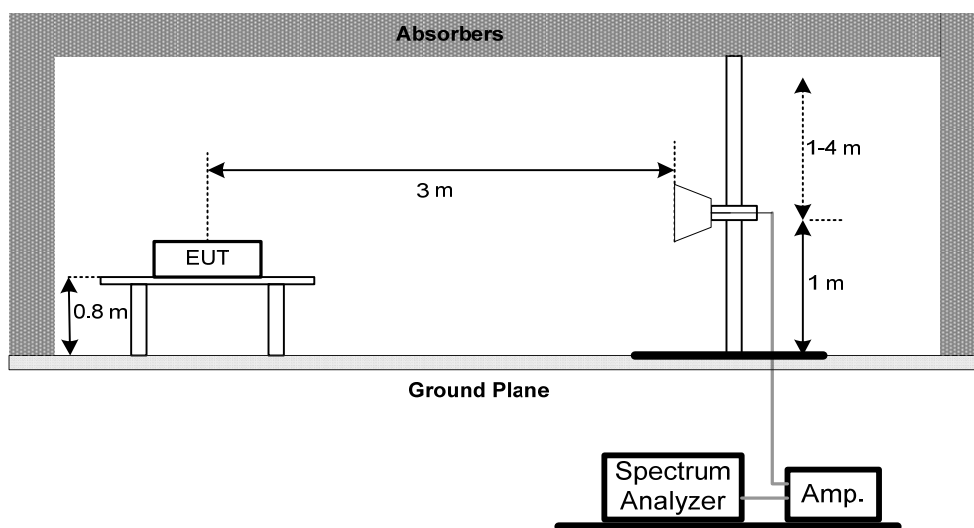

#### 4.1.5 TESTDEVIATION

There is no deviation with the original standard.

#### 4.1.6 EUT OPERATION DURING TEST

The BS simulator was used to set the TX channel and power level and modulate the TX signal.

#### 4.1.7 EUT TEST CONDITIONS

Temperature: 25°C  
Relative Humidity: 55%  
Test Voltage: DC 3.8V

#### 4.1.8 TEST RESULTS

Please refer to the Attachment A.

## 4.2 99% OCCUPIED BANDWIDTH MEASUREMENT

### 4.2.1 LIMIT

According to FCC 27.53(h) specified that emission bandwidth is defined as the width of the signal between two points, one below the carrier center frequency and one above the carrier center frequency, outside of which all emissions are attenuated at least 26 dB below the transmitter power.

### 4.2.2 MEASURING INSTRUMENTS AND SETTING

Please refer to section 5 in this report. The following table is the setting of the Spectrum Analyzer.

Spectrum Parameters	Setting
Attenuation	Auto
Span Frequency	Encompass the entire emissions bandwidth (EBW) of the signal
RB	30 kHz
VB	100 kHz
Trace	Max Hold

### 4.2.3 TEST PROCEDURE

1. The transmitter output (antenna port) was connected to the spectrum analyzer.
2. Used measurement function of spectrum to measure the 99% occupied bandwidth..

### 4.2.4 TEST SETUP LAYOUT

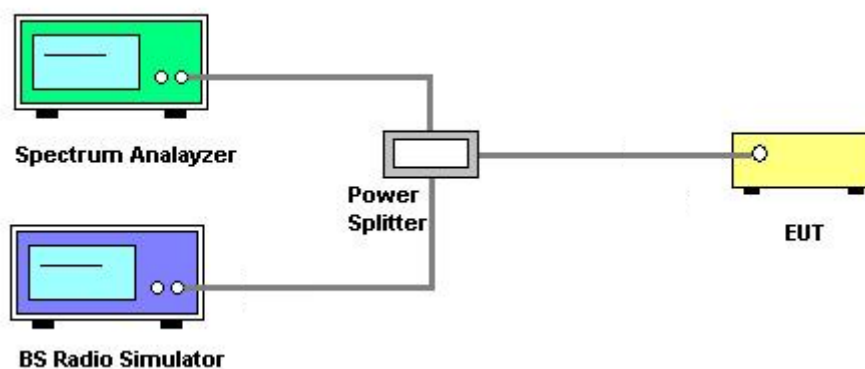

### 4.2.5 TEST DEVIATION

There is no deviation with the original standard.

### 4.2.6 EUT OPERATION DURING TEST

The BS simulator was used to set the TX channel and power level and modulate the TX signal.

### 4.2.7 EUT TEST CONDITIONS

Temperature: 25°C  
 Relative Humidity: 55%  
 Test Voltage: DC 3.8V

#### **4.2.8 TEST RESULTS**

Please refer to the Attachment B.



### 4.3 SPURIOUS EMISSIONS AT ANTENNA TERMINALS MEASUREMENT

#### 4.3.1 LIMIT

In the FCC 27.53(h)& RSS-130 section 4.6, on any frequency outside a licensee's frequency block within GSM spectrum, the power of any emission shall be attenuated below the transmitter power (P) by at least  $43 + 10 \log (P)$  dB. The limit translates in the relevant power range (1 to 0.001W). At 1W(Power Control Level 0) the specified minimum attenuation becomes 43dB and the limit of emission equal to  $-13\text{dBm}$ .

#### 4.3.2 MEASURING INSTRUMENTS AND SETTING

Please refer to section 5 in this report. The following table is the setting of the Spectrum Analyzer.

Spectrum Parameters	Setting
Attenuation	Auto
Start Frequency	30MHz
Stop Frequency	10th carrier harmonic
RB / VB	1 MHz / 1MHz for Peak

#### 4.3.3 TEST PROCEDURES

1. The EUT was set up for the maximum peak power with QPSK link data modulation. The power was measured with R&S Spectrum Analyzer. All measurements were done at 3 channels, Lowest,Middle,Highest(low, middle and high operational frequency range.)
2. The conducted spurious emission used the power splitter via EUT RF power connector between simulation base station and spectrum analyzer. This splitter loss and cable loss are the worst loss 4.5dB in the transmitted path track.
3. When the spectrum scanned from 9kHz to 3GHz, it shall be connected to the band reject filter attenuated the carried frequency. The spectrum set RB/VB 1MHz.
4. When the spectrum scanned from 3GHz to 10GHz, it shall be connected to the high pass filter attenuated the carried frequency. The spectrum set RB/VB 1MHz.

#### 4.3.4 TESTSETUP LAYOUT

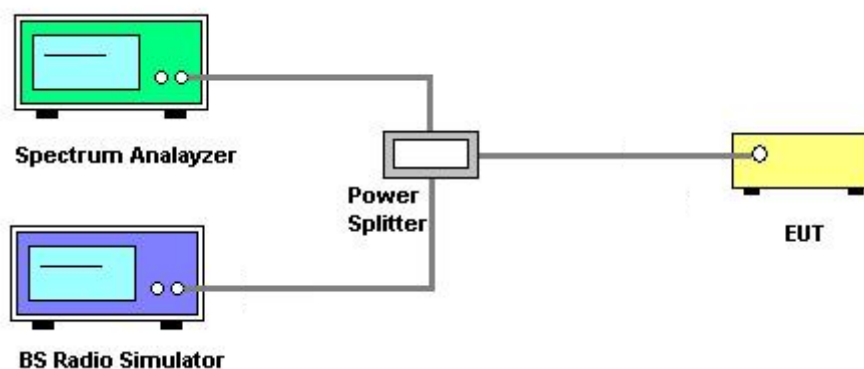

#### 4.3.5 TESTDEVIATION

There is no deviation with the original standard.

#### 4.3.6 EUT OPERATIONDURING TEST

The BS simulator was used to set the TX channel and power level and modulate the TX signal.

#### **4.3.7 EUT TEST CONDITIONS**

Temperature: 25°C  
Relative Humidity: 55%  
Test Voltage:DC 3.8V

#### **4.3.8 TEST RESULTS**

Please refer to the Attachment C.

## 4.4 SPURIOUS RADIATED EMISSIONS MEASUREMENT

### 4.4.1 LIMIT

In the FCC 27.53(h) & RSS-130 section 4.6.2, On any frequency outside a licensee's frequency block within GSM spectrum, the power of any emission shall be attenuated below the transmitter power (P) by at least  $43 + 10 \log (P)$  dB. The limit translates in the relevant power range (1 to 0.001W). At 1W(Power Control Level 0) the specified minimum attenuation becomes 43dB and the limit of emission equal to  $-13\text{dBm}$ . At 0.001W(Power Control Level 15) the specified minimum attenuation becomes 13dB and the emission of limit equal to  $-13\text{dBm}$ . So the limit of emission is the same absolute specified line.

### 4.4.2 MEASURING INSTRUMENTS AND SETTING

Please refer to section 5 in this report. The following table is the setting of the Spectrum Analyzer.

Spectrum Parameters	Setting
Attenuation	Auto
Start Frequency	30 MHz
Stop Frequency	10th carrier harmonic
Detector	Positive Peak
Span	100 MHz
Sweep Time	1s
RB / VB	1 MHz / 1MHz
Attenuation	Positive Peak

### 4.4.3 TEST PROCEDURES

1. Substitution method is used for E.I.R.P measurement. In the semi-anechoic chamber, EUT placed on the 0.8m height of Turn Table, rotated the table around 360 degrees to search the maximum radiation power and receiver antenna shall be rotated vertical and horizontal polarization and moved height from 1m to 4m to find the maximum polar radiated power. The "Read Value" is the spectrum reading the maximum power value.
2. The substitution horn antenna is substituted for EUT at the same position and signals generator export the CW signal to the substitution antenna via a TX cable. Rotated the Turn Table and moved receiving antenna to find the maximum radiation power. Adjust output power level of S.G to get a Value of spectrum reading equal to "Read Value " of step a. Record the power level of S.G
3. EIRP = Output power level of S.G – TX cable loss + Antenna gain of substitution horn.
4. E.R.P power can be calculated form E.I.R.P power by subtracting the gain of dipole, E.R.P power = E.I.P.R power - 2.15dBi.
5. The resolution bandwidth and video bandwidth of test receiver/spectrum analyzer is 1MHz/3MHz.

#### **4.4.4 TESTSETUP LAYOUT**

This test setup layout is the same as that shown in **section 4.1.3**.

#### **4.4.5 TESTDEVIATION**

There is no deviation with the original standard.

#### **4.4.6 EUT OPERATIONDURING TEST**

The BS simulator was used to set the TX channel and power level and modulate the TX signal.

#### **4.4.7 EUT TEST CONDITIONS**

Temperature: 25°C

Relative Humidity: 55%

Test Voltage: DC 3.8V

#### **4.4.8 TEST RESULTS**

Please refer to the Attachment D.

## 4.5 BAND EDGE MEASUREMENT

### 4.5.1 LIMIT

According to FCC 27.53(h) & RSS-130 section 4.6.1 specified that power of any emission outside of the authorized operating frequency ranges must be attenuated below the transmitting power (P) by a factor of at least  $43 + 10 \log(P)$  dB . In the 1 MHz bands immediately outside and adjacent to the frequency block a resolution bandwidth of at least one percent of the emission bandwidth of the fundamental emission of the transmitter may be employed. Then we measure that the bandwidth is about 300kHz and the resolution bandwidth is 3kHz.

### 4.5.2 MEASURING INSTRUMENTS AND SETTING

Please refer to section 5 in this report. The following table is the setting of the Spectrum Analyzer.

Spectrum Parameters	Setting
Attenuation	Auto
Span Frequency	5 MHz
RB / VB	10 kHz /30 kHz
Trace	Sample
Sweep Time	Auto

### 4.5.3 TEST PROCEDURES

1. The EUT was set up for the maximum peak power with QPSK link data modulation. The power was measured with R&S Spectrum Analyzer. All measurements were done at 2 channels, Lowest and Highest(low and high operational frequency range.)
2. The band edge measurement used the power splitter via EUT RF power connector between simulation base station and spectrum analyzer. The splitter loss and cable loss are the worst loss 4dB in the transmitted path track.
3. The center frequency of spectrum is the band edge frequency and span is 5 MHz. RB of the spectrum is 10kHz and VB of the spectrum is 30KHz.
4. Record the Sample trace plot into the test report.

### 4.5.4 TESTSETUP LAYOUT

This test setup layout is the same as that shown in section 4.2.4.

### 4.5.5 TESTDEVIATION

There is no deviation with the original standard.

### 4.5.6 EUT OPERATIONDURING TEST

The BS simulator was used to set the TX channel and power level and modulate the TX signal.

### 4.5.7 EUT TEST CONDITIONS

Temperature: 25°C

Relative Humidity: 55%

Test Voltage: DC 3.8V

#### **4.5.8 TEST RESULTS**

Please refer to the Attachment E.

## 4.6 FREQUENCY STABILITY MEASUREMENT

### 4.6.1 LIMIT

According to the FCC part 27.54& RSS-130 section 4.3 shall be tested the frequency stability. The rule is defined that” The frequency stability shall be sufficient to ensure that the fundamental emission stays within the authorized frequency block.” The frequency error rate is according to the JTC standard that the frequency error rate shall be accurate to within 0.1 ppm of the received frequency from the base station. The test extreme voltage is according to the 2.1055(d)(1) Vary primary supply voltage from 85 to 115 percent of the nominal value for other than hand carried battery equipment and the extreme temperature rule is comply with the 2.1055(a)(1)  $-30^{\circ}\text{C} \sim 50^{\circ}\text{C}$ .

### 4.6.2 MEASURING INSTRUMENTS AND SETTING

Please refer to section 5 in this report. The following table is the setting of the BS Simulator.

Spectrum Parameters	Setting
Frequency Error	The maximum of transmit frequency error

### 4.6.3 TEST PROCEDURES

1. The transmitter output (antenna port) was connected to the BS Simulator.
2. The BS simulator was used to set the TX channel and power level and modulate the TX signal with different bit patterns.
3. BS simulator used the frequency error function and measured the peak frequency error.  
Power must be removed when changing from one temperature to another or one voltage to another voltage. Power warm up is at least 15 min and power applied should perform before recording frequency error.  
The each temperature step shall be at least 0.5 hours, consider the EUT could be test under the stability condition.
4. EUT is connected the external power supply to control the DC input power. The various Volts from the minimum 3.1 Volts to 4.3 Volts. Each step shall be record the frequency error rate.
5. The test extreme voltage is to change the primary supply voltage from 85 to 115 percent of the nominal value.
6. Reduced operating temperature range of  $-10^{\circ} \sim +45^{\circ} \text{C}$  as defined in Operational description and declared in User Manual.

### 4.6.4 TESTSETUP LAYOUT

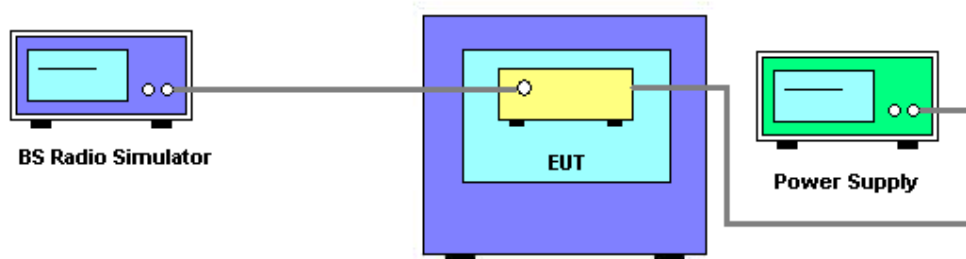

### 4.6.5 TESTDEVIATION

There is no deviation with the original standard.

### 4.6.6 EUT OPERATION DURING TEST

The EUT was programmed to be in continuously un-modulation transmitting mode.

#### **4.6.7 EUT TEST CONDITIONS**

Temperature: 25°C  
Relative Humidity: 55%  
Test Voltage: DC 3.8V

#### **4.6.8 TEST RESULTS**

Please refer to the Attachment F.



## **4.7 PEAK TO AVERAGE RATIO**

### **4.7.1 LIMIT**

In the FCC 27.50) & RSS-130 section 4.4

Peak transmit power shall be measured over any interval of continuous transmission using instrumentation calibrated in terms of rms-equivalent voltage.

The measurement results shall be properly adjusted for any instrument limitations, such as detector re-sponse times, limited resolution bandwidth capability when compared to the emission bandwidth, etc., so as to obtain a true peak measurement for the emission in question over the full bandwidth of the channel.

To measure transmissions in this band using an average power technique, the peak to-average ratio (PAR) of the transmission shall not exceed 13 dB.

### **4.7.2 TEST PROCEDURES**

1. Set resolution/measurement bandwidth  $\geq$  signal's occupied bandwidth;
2. Set the number of counts to a value that stabilizes the measured CCDF curve;

### **4.7.3 TESTSETUP LAYOUT**

Please refer to section 3.4 in this report.

### **4.7.4 TESTDEVIATION**

There is no deviation with the original standard.

### **4.7.5 EUT OPERATIONDURING TEST**

The BS simulator was used to set the TX channel and power level and modulate the TX signal.

### **4.7.6 EUT TEST CONDITIONS**

Temperature: 25°C

Relative Humidity: 55%

Test Voltage:DC 3.8V

### **4.7.7 TEST RESULTS**

Please refer to the Attachment G.

## 5. LIST OF MEASUREMENT EQUIPMENTS

Radiated Emission & ERP or EIRP Measurement					
Item	Kind of Equipment	Manufacturer	Type No.	Serial No.	Calibrated until
1	Antenna	Schwarzbeck	VULB9160	9160-3232	Mar. 28, 2016
2	Amplifier	HP	8447D	2944A09673	Nov. 17, 2015
3	Receiver	AGILENT	N9038A	MY52130039	Sep. 30, 2015
4	Test Cable	emci	LMR-400(30MHz-1GHz)	C-01	Jun. 28, 2016
5	Controller	CT	SC100	N/A	N/A
6	Antenna	ETS	3115	00075789	Mar. 28, 2016
7	Amplifier	Agilent	8449B	3008A02274	Nov. 02, 2015
8	Receiver	AGILENT	N9038A	MY52130039	Sep. 30, 2015
9	Test Cable	emci	EMC104-SM-S M-10000(1GHz-26.5GHz)	C-68	Jun. 28, 2016
10	Controller	CT	SC100	N/A	N/A
11	Broad-Band Horn Antenna	Schwarzbeck	BBHA 9170	9170319	Mar. 28, 2016
12	Microwave Preamplifier With Adaptor	EMC INSTRUMENT	EMC2654045	980039 & HA01	Mar. 28, 2016
13	Double Ridged Guide Antenna	ETS-LINDGREN	3115	00075846	Mar. 28, 2016
14	Antenna	SCHWARZBECK	VULB 9160	9160-3231	Mar. 28, 2016
15	MXG Analog Signal Generator	Agilent	N5181A	MY49060710	Nov. 02, 2015
16	Signal Generator	R&S	SMR40	100504	Mar. 28, 2016
17	Measurement Software	Farad	EZ-EMC Ver.NB-03A1-01	N/A	N/A

**Antenna Conducted Spurious Emission Measurement**

Item	Kind of Equipment	Manufacturer	Type No.	Serial No.	Calibrated until
1	EXA Spectrum Analyzer	Agilent	N9010A	MY50520044	Mar. 28, 2016
2	wideband radio communication tester	R&S	CMW500	152372	Jan. 30, 2016
3	POWER SPLITTER	Mini-Circuits	ZFRSC-123-S+	331000910-1	Mar. 17, 2016
4	Test Cable	N/A	CL-CB12-00 1	N/A	Oct. 22, 2015
5	Test Cable	N/A	CL-CB12-00 4	N/A	Oct. 22, 2015

**Band Edge Measurement**

Item	Kind of Equipment	Manufacturer	Type No.	Serial No.	Calibrated until
1	EXA Spectrum Analyzer	Agilent	N9010A	MY50520044	Mar. 28, 2016
2	wideband radio communication tester	R&S	CMW500	152372	Jan. 30, 2016
3	POWER SPLITTER	Mini-Circuits	ZFRSC-123-S+	331000910-1	Mar. 17, 2016
4	Test Cable	N/A	CL-CB12-00 1	N/A	Oct. 22, 2015
5	Test Cable	N/A	CL-CB12-00 4	N/A	Oct. 22, 2015

**99% Occupied Bandwidth Measurement**

Item	Kind of Equipment	Manufacturer	Type No.	Serial No.	Calibrated until
1	EXA Spectrum Analyzer	Agilent	N9010A	MY50520044	Mar. 28, 2016
2	wideband radio communication tester	R&S	CMW500	152372	Jan. 30, 2016
3	POWER SPLITTER	Mini-Circuits	ZFRSC-123-S+	331000910-1	Mar. 17, 2016
4	Test Cable	N/A	CL-CB12-00 1	N/A	Oct. 22, 2015
5	Test Cable	N/A	CL-CB12-00 4	N/A	Oct. 22, 2015

Frequency Stability Measurement					
Item	Kind of Equipment	Manufacturer	Type No.	Serial No.	Calibrated until
1	wideband radio communication tester	R&S	CMW500	152372	Jan.30,2016
2	POWER SPLITTER	Mini-Circuits	ZFRSC-123-S+	331000910-1	Mar. 17, 2016
3	Test Cable	N/A	CL-CB12-00 1	N/A	Oct. 22, 2015
4	Const Temp. & Humidity Chamber	GIANT FORCE	ITH-1200-40-CP-AR	IAA1210-003	Aug. 01, 2015
5	DC power supply	GW Instek	GPC-30300N	EK880675	Oct.12, 2015

Peak to Average Ratio					
Item	Kind of Equipment	Manufacturer	Type No.	Serial No.	Calibrated until
1	EXA Spectrum Analyzer	Agilent	N9010A	MY50520044	Mar. 28, 2016
2	wideband radio communication tester	R&S	CMW500	152372	Jan. 30, 2016
3	POWER SPLITTER	Mini-Circuits	ZFRSC-123-S+	331000910-1	Mar. 17, 2016
4	Test Cable	N/A	CL-CB12-00 1	N/A	Oct. 22, 2015
5	Test Cable	N/A	CL-CB12-00 4	N/A	Oct. 22, 2015

Remark: "N/A" denotes no model name, serial no. or calibration specified.  
All calibration period of equipment list is one year.

## 6. EUT TEST PHOTO

### Radiated Measurement Photos

9KHz to 30MHz



## Radiated Measurement Photos

30MHz to 1000MHz



## Radiated Measurement Photos

Above 1000MHz

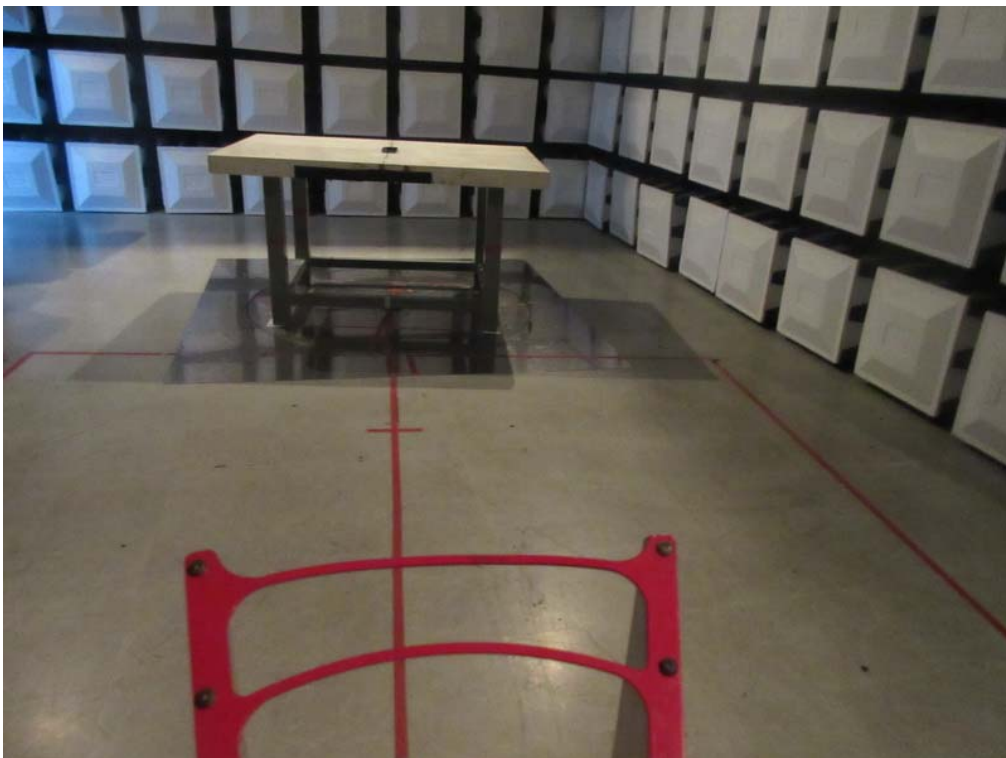

## ATTACHMENT A - RADIATED RF OUTPUT POWER



Test Mode:	TX Mode
------------	---------

LTE Band V				Radiated Power (dBm)			Max. Limit (dBm)	Result
BW	Modulation	RB Size	V/H	Lowest	Middle	Highest		
1.4M	QPSK	6RB	H	19.07	18.96	18.86	33	Complies
3M		15RB	H	20.04	20.08	20.27	33	Complies
5M		25RB	H	20.02	20.03	20.34	33	Complies
10M		50RB	H	21.43	21.56	21.60	33	Complies
1.4M	16-QAM	6RB	H	18.95	18.67	18.41	33	Complies
3M		15RB	H	20.32	20.21	20.23	33	Complies
5M		25RB	H	20.21	20.25	20.09	33	Complies
10M		50RB	H	21.95	21.83	21.60	33	Complies

Test Mode:	TX Mode
------------	---------

Bandwidth	Modulation	RB size	Conducted Power		
			Lowest	Middle	Highest
1.4MHz	QPSK	1	23.50	23.26	23.45
		1	23.27	23.23	23.36
		1	23.60	23.30	23.40
		3	22.10	22.05	22.08
		3	22.21	22.11	22.19
		3	22.10	22.40	22.16
	16-QAM	6	22.01	22.02	22.02
		1	22.58	22.33	22.55
		1	22.60	22.54	22.61
		1	22.54	22.56	22.60
		3	21.43	21.13	21.50
		3	21.49	21.20	21.49
		3	21.40	21.30	21.50
		6	21.05	21.15	21.01

Bandwidth	Modulation	RB size	Conducted Power		
			Lowest	Middle	Highest
3MHz	QPSK	1	23.31	23.22	23.01
		1	23.33	23.22	23.18
		1	23.46	23.35	23.01
		8	22.25	22.09	22.13
		8	22.10	22.22	22.20
		8	22.04	22.14	21.95
		15	22.10	22.15	22.19
	16-QAM	1	22.70	21.90	22.29
		1	22.60	22.00	22.29
		1	22.56	21.91	22.26
		8	21.22	21.20	21.35
		8	21.20	21.35	21.42
		8	21.12	21.27	21.31
		15	21.21	21.20	21.26

Bandwidth	Modulation	RB size	Conducted Power		
			Lowest	Middle	Highest
5MHz	QPSK	1	23.30	23.23	23.50
		1	23.50	23.37	23.59
		1	23.30	23.25	23.51
		12	22.01	22.00	22.12
		12	22.10	22.02	22.22
		12	22.08	22.03	22.23
		25	22.03	22.04	22.16
	16-QAM	1	22.24	22.23	22.65
		1	22.90	22.50	22.80
		1	22.91	22.30	22.80
		12	21.21	21.20	21.28
		12	21.30	21.24	21.39
		12	21.30	21.23	21.33
		25	21.19	21.20	21.20

Bandwidth	Modulation	RB size	Conducted Power		
			Lowest	Middle	Highest
10MHz	QPSK	1	23.35	23.10	23.00
		1	23.46	23.06	23.04
		1	23.53	23.07	22.98
		25	22.22	22.09	22.23
		25	22.23	22.12	22.24
		25	22.20	22.10	22.13
		50	22.14	22.02	22.18
	16-QAM	1	22.56	22.00	22.46
		1	22.69	21.68	22.18
		1	22.50	21.79	22.06
		25	21.15	21.14	21.23
		25	21.22	21.18	21.26
		25	21.20	21.09	21.20
		50	21.21	21.10	21.16

**REMARKS:**

1. Radiated Output Power(dBm)=Raw Value(dBm) + Correction Factor(dB) +Ant Gain(dBi)
2. Correction Factor(dB) = Power SplitterLoss(dB) + Cable Loss(dB)
3. The antenna gain is -5.27dBi
4. Tests have been conducted for both vertical and horizontal plane and the worst case was found in horizontal plane and the results were selected and recorded in the report

## **ATTACHMENT B - 99% OCCUPIED BANDWIDTH**

Test Mode : TX Mode Configuration QPSK-1.4M/6RB			
Channel	99% OBW (MHz)	-26dBc Bandwidth	Result
Lowest	1.086	1.229	Complies
Middle	1.091	1.226	Complies
Highest	1.097	1.230	Complies

### 99% Occupied Bandwidth channel Lowest



### 99% Occupied Bandwidth channel Middle

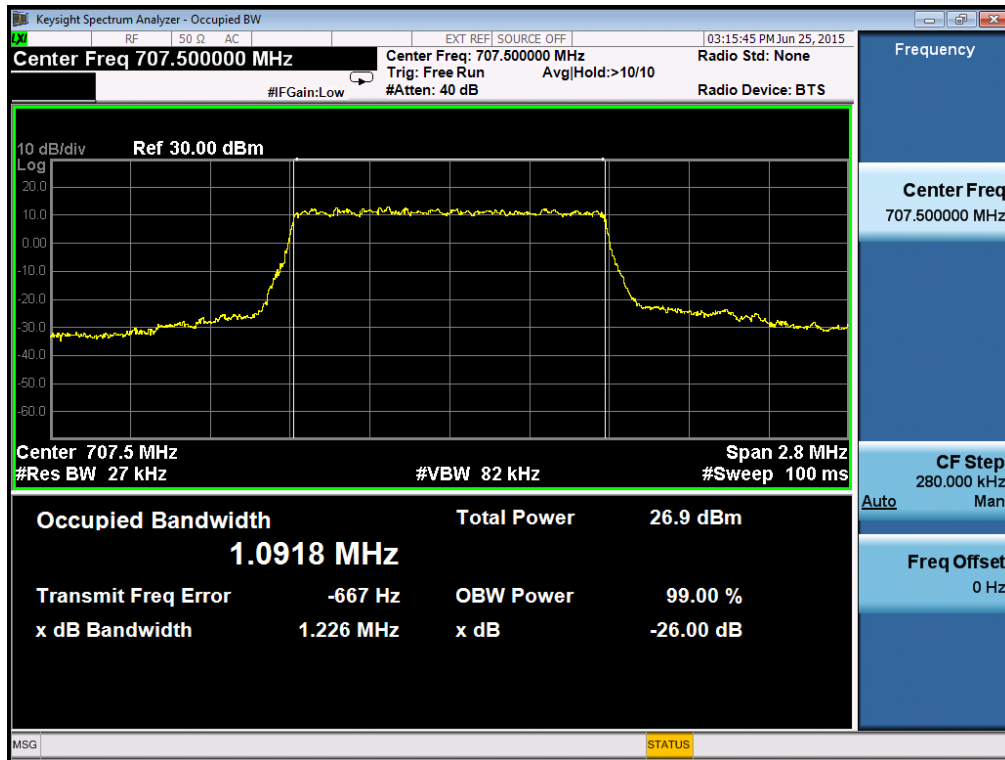

### 99% Occupied Bandwidth channel Highest

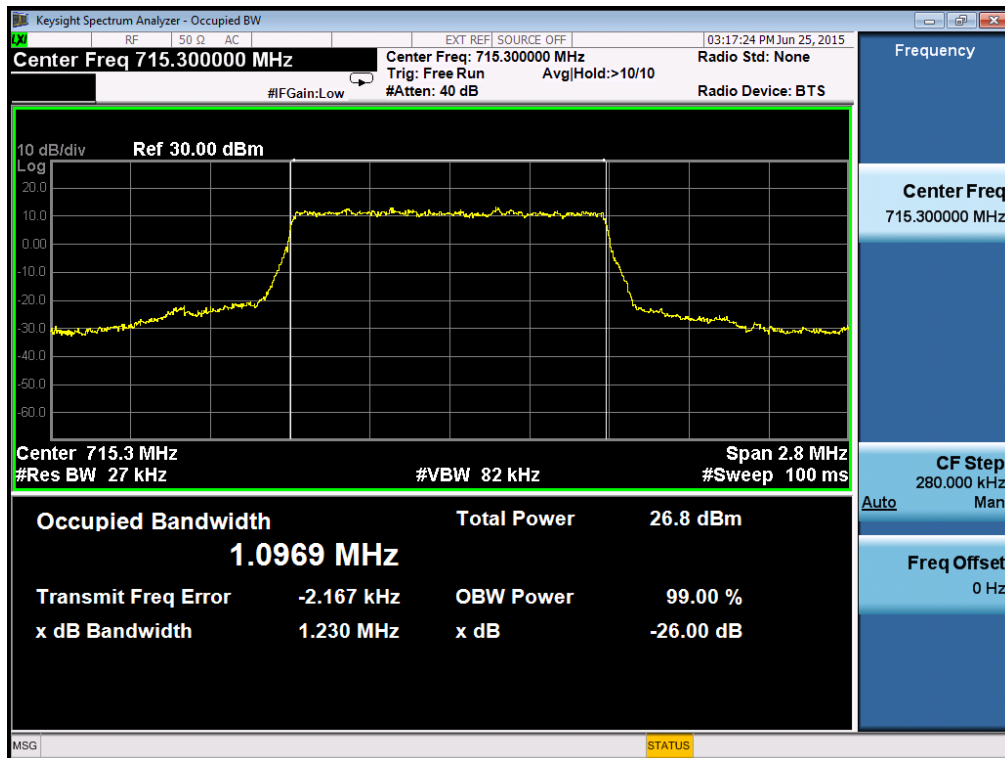

Test Mode : TX Mode Configuration QPSK-3M/15RB			
Channel	99% OBW (MHz)	-26dBc Bandwidth	Result
Lowest	2.711	2.952	Complies
Middle	2.702	2.961	Complies
Highest	2.704	2.983	Complies

### 99% Occupied Bandwidth channel Lowest

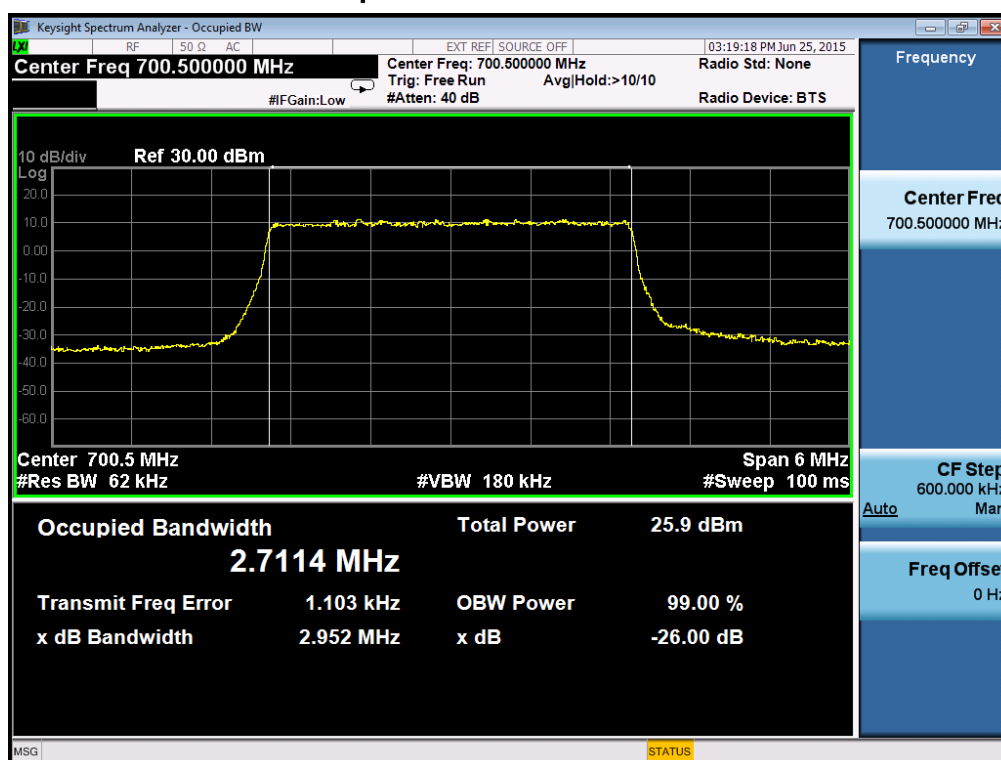

### 99% Occupied Bandwidth channel Middle

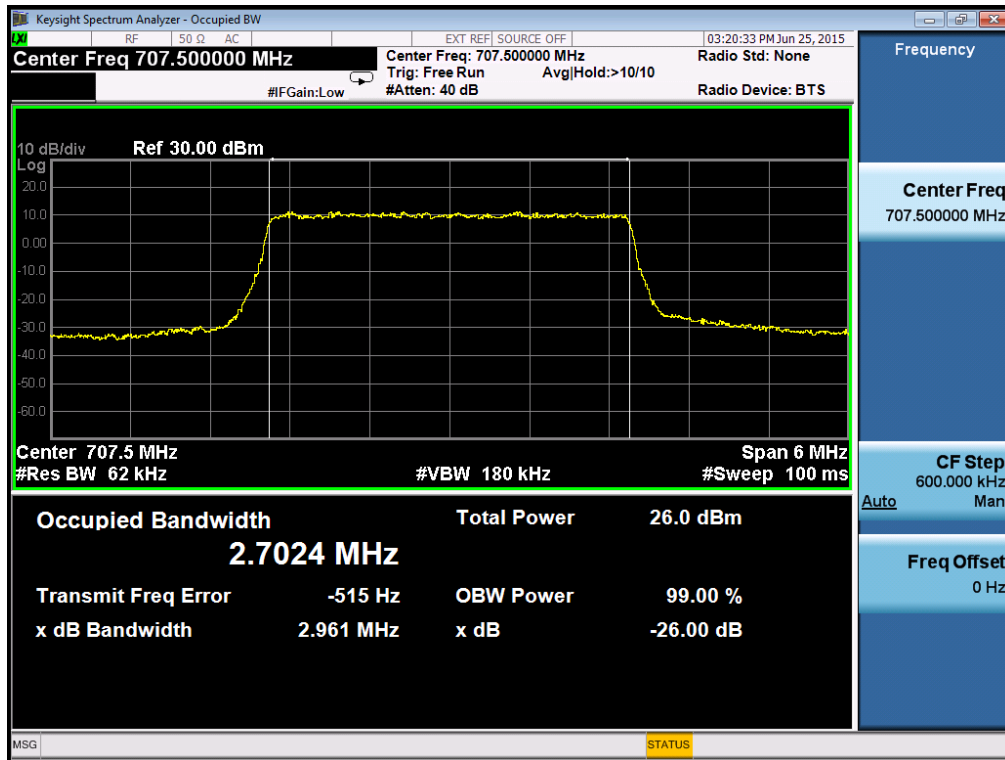

### 99% Occupied Bandwidth channel Highest

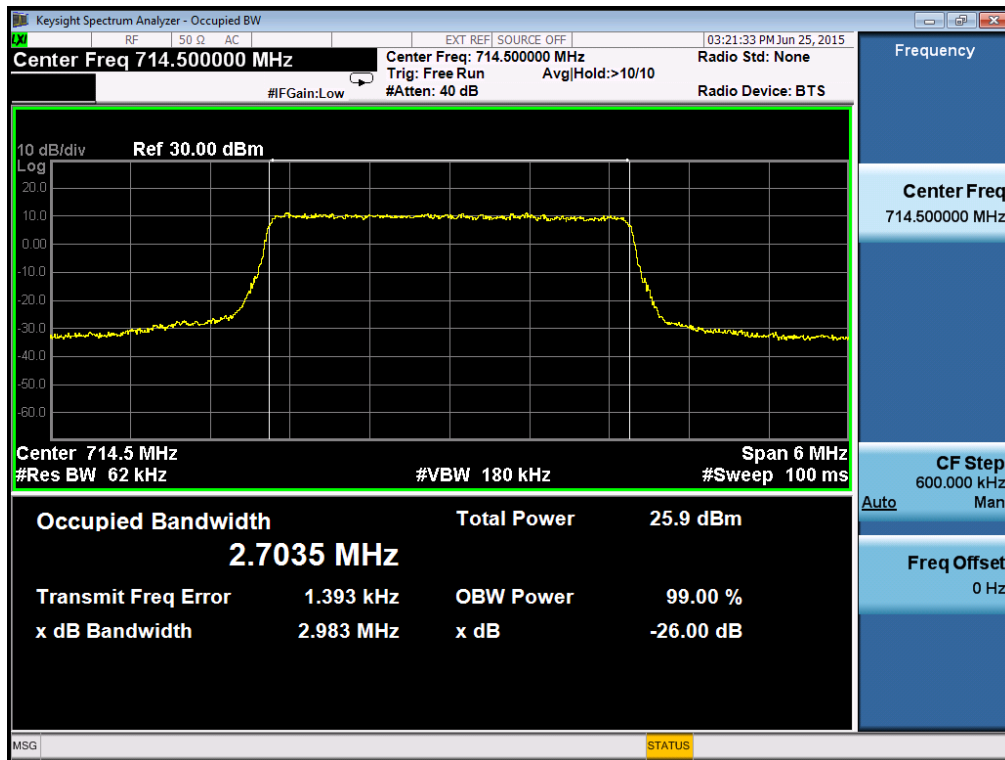



Test Mode : TX Mode Configuration QPSK-5M/25RB			
Channel	99% OBW (MHz)	-26dBc Bandwidth	Result
Lowest	4.499	4.857	Complies
Middle	4.511	4.859	Complies
Highest	4.511	4.885	Complies

### 99% Occupied Bandwidth channel Lowest

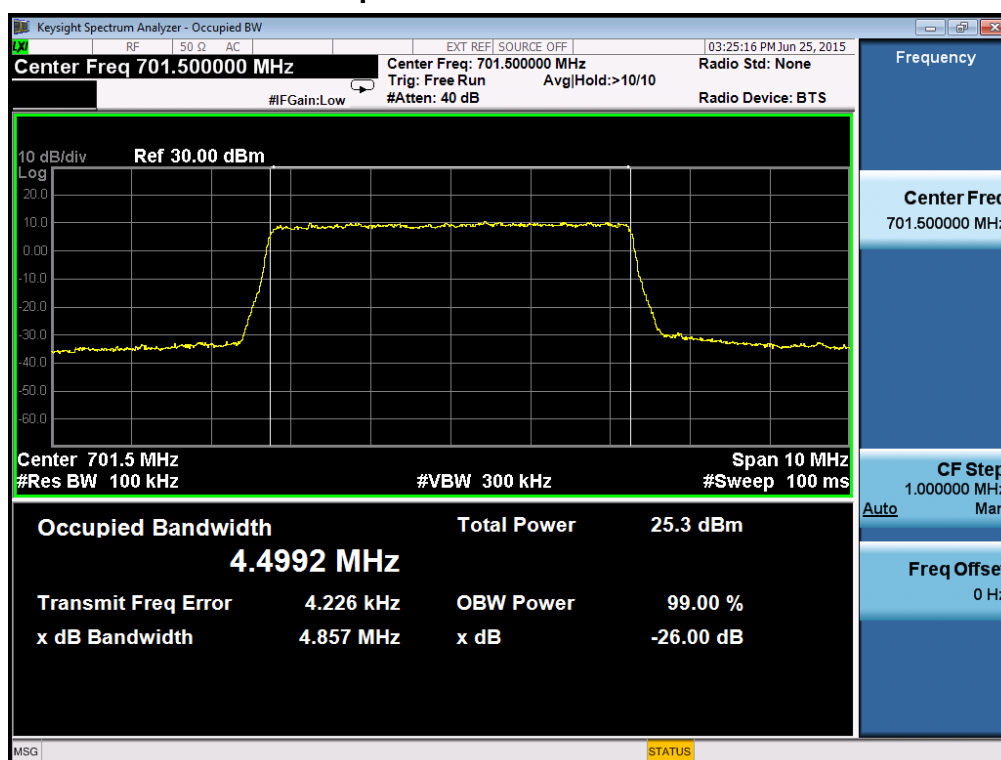

### 99% Occupied Bandwidth channel Middle

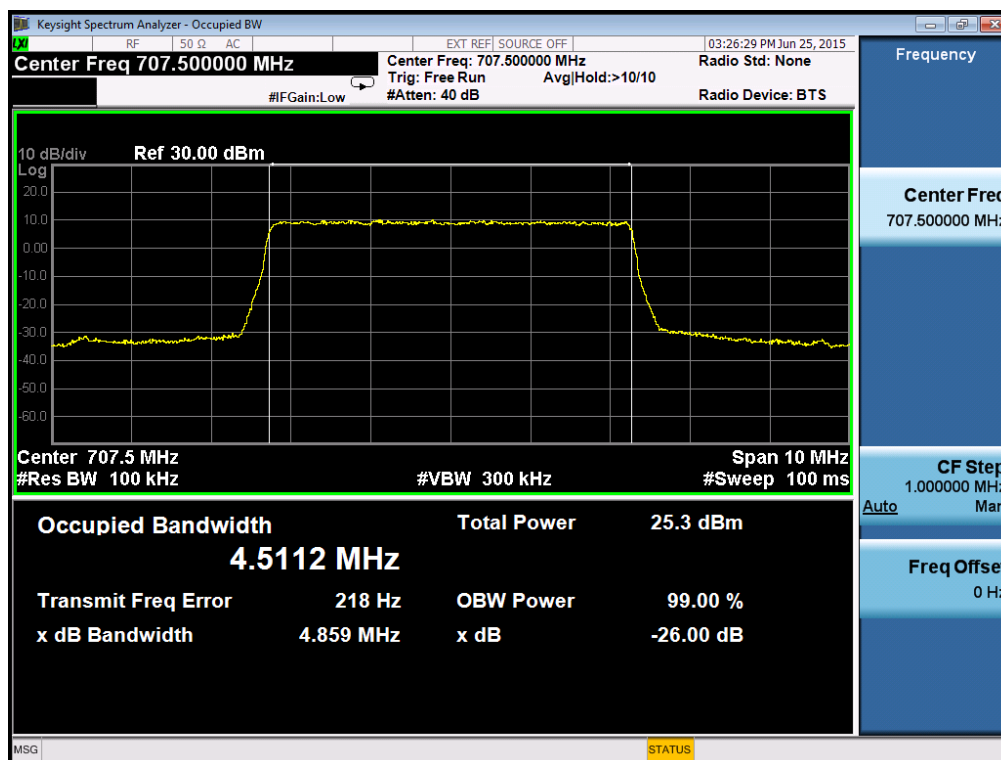

### 99% Occupied Bandwidth channel Highest

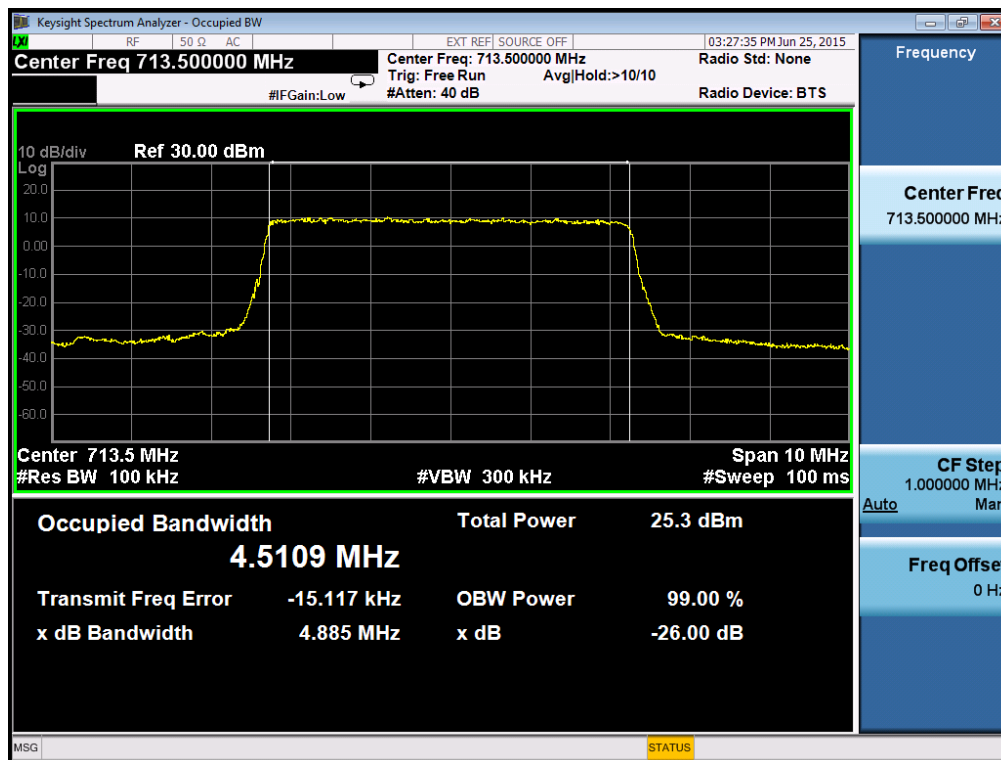

Test Mode : TX Mode Configuration QPSK-10M/50RB			
Channel	99% OBW (MHz)	-26dBc Bandwidth	Result
Lowest	8.962	9.557	Complies
Middle	8.999	9.593	Complies
Highest	8.990	9.613	Complies

### 99% Occupied Bandwidth channel Lowest

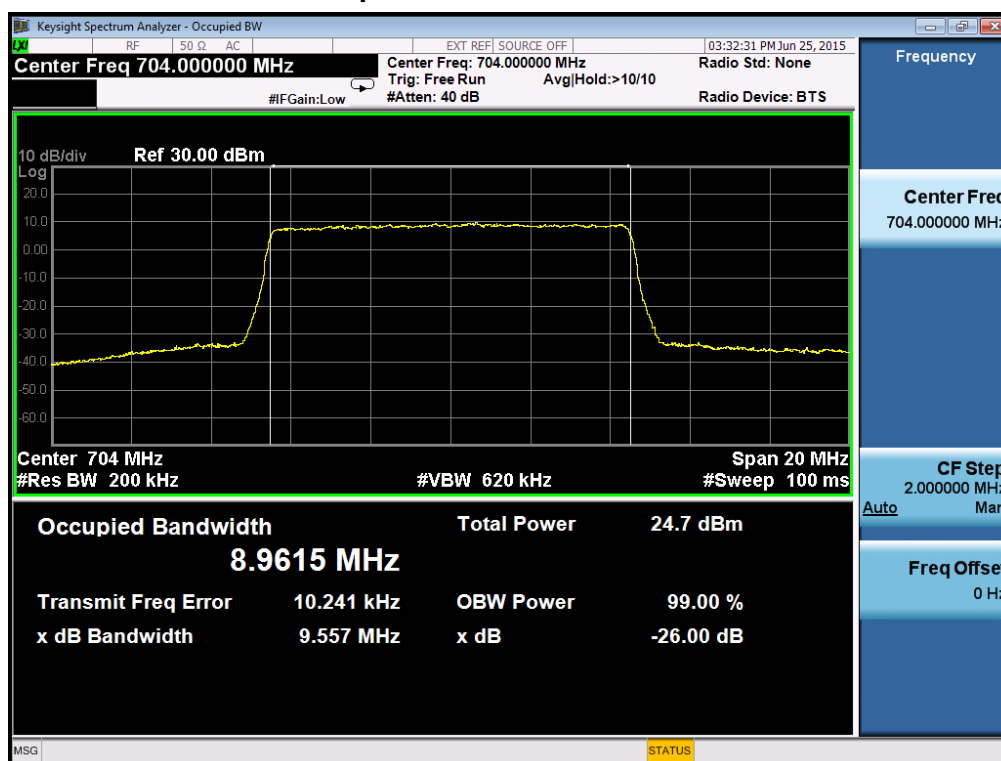

### 99% Occupied Bandwidth channel Middle

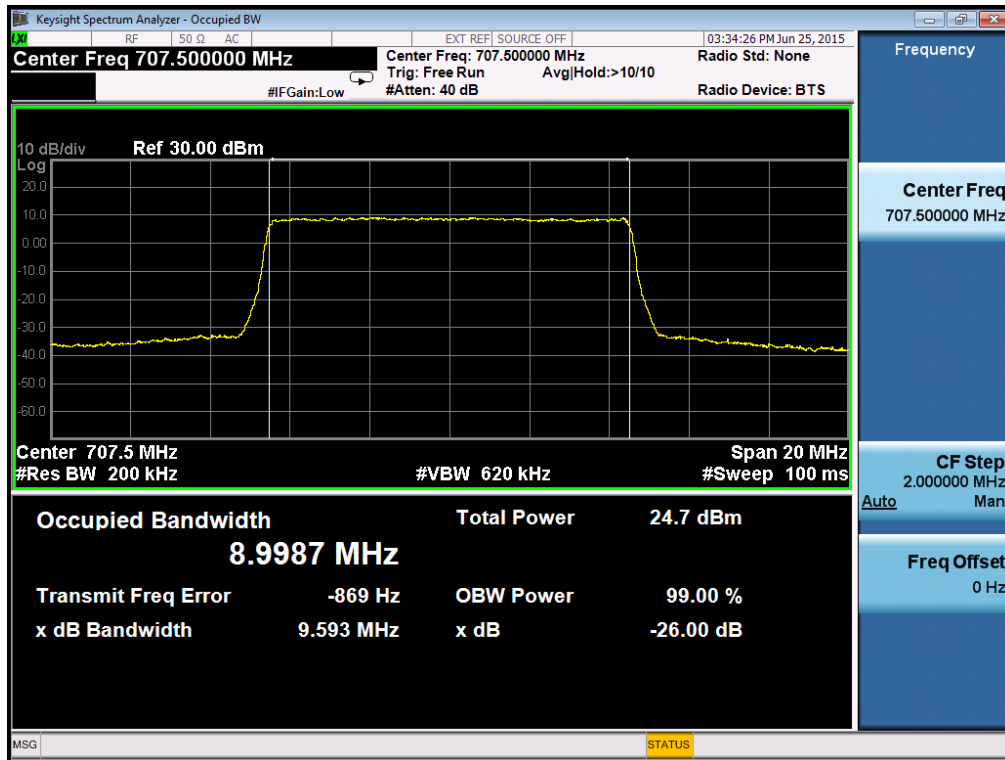

### 99% Occupied Bandwidth channel Highest

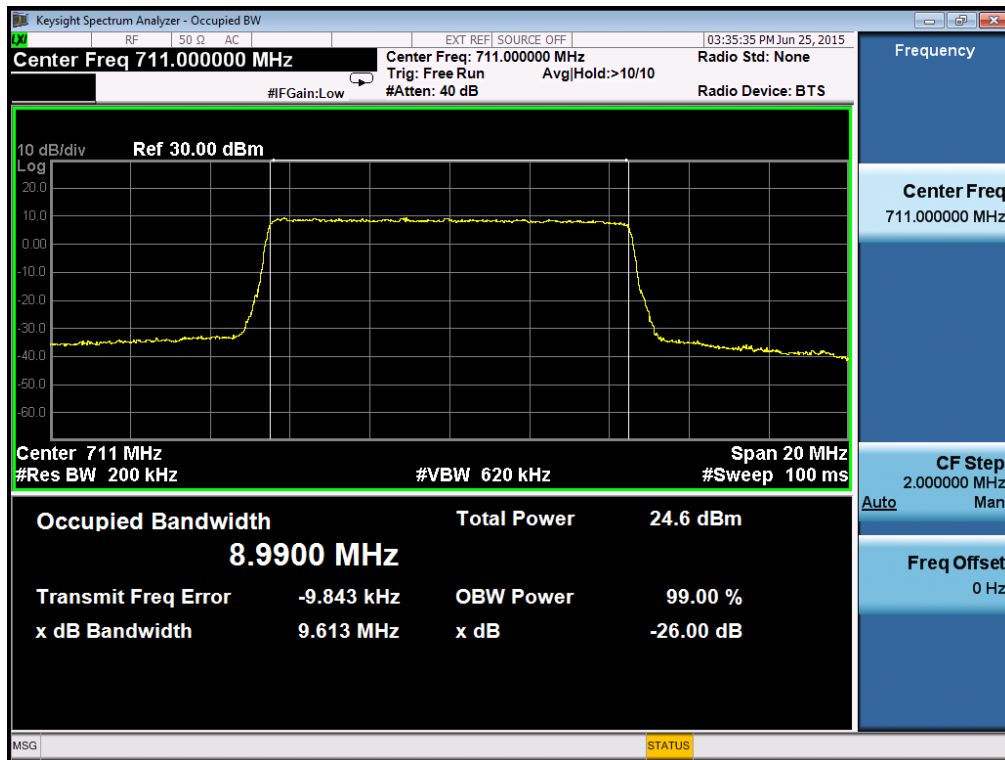

Test Mode : TX Mode Configuration16-QAM-1.4M//6RB			
Channel	99% OBW (MHz)	-26dBc Bandwidth	Result
Lowest	1.088	1.221	Complies
Middle	1.094	1.237	Complies
Highest	1.089	1.234	Complies

### 99% Occupied Bandwidth channel Lowest

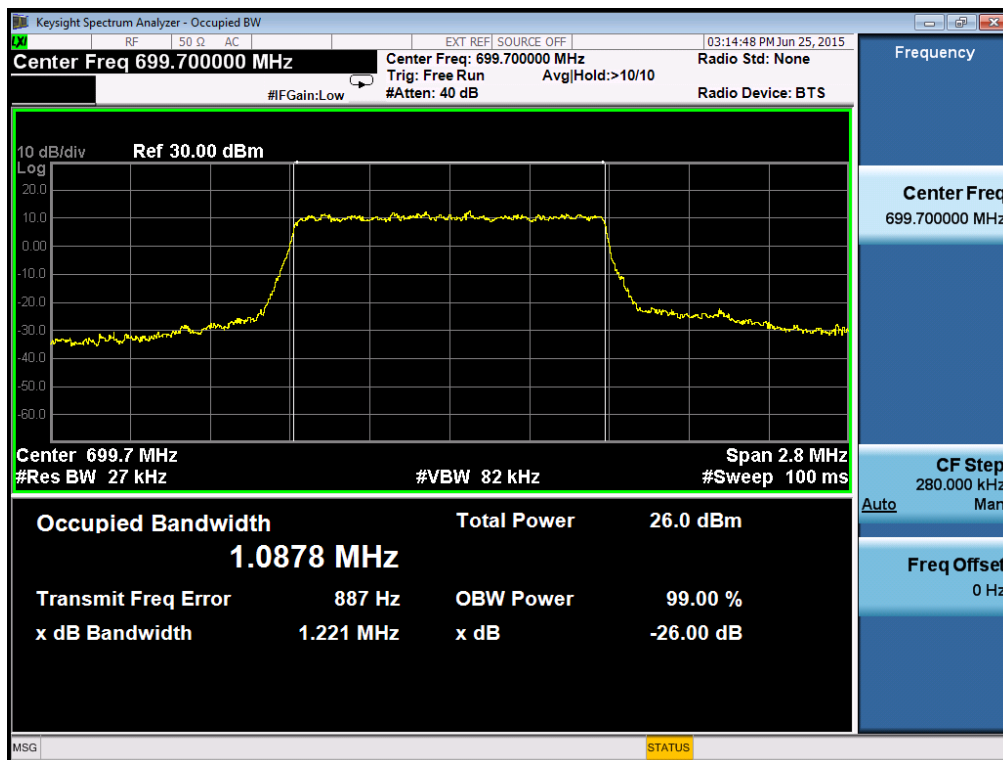

### 99% Occupied Bandwidth channel Middle

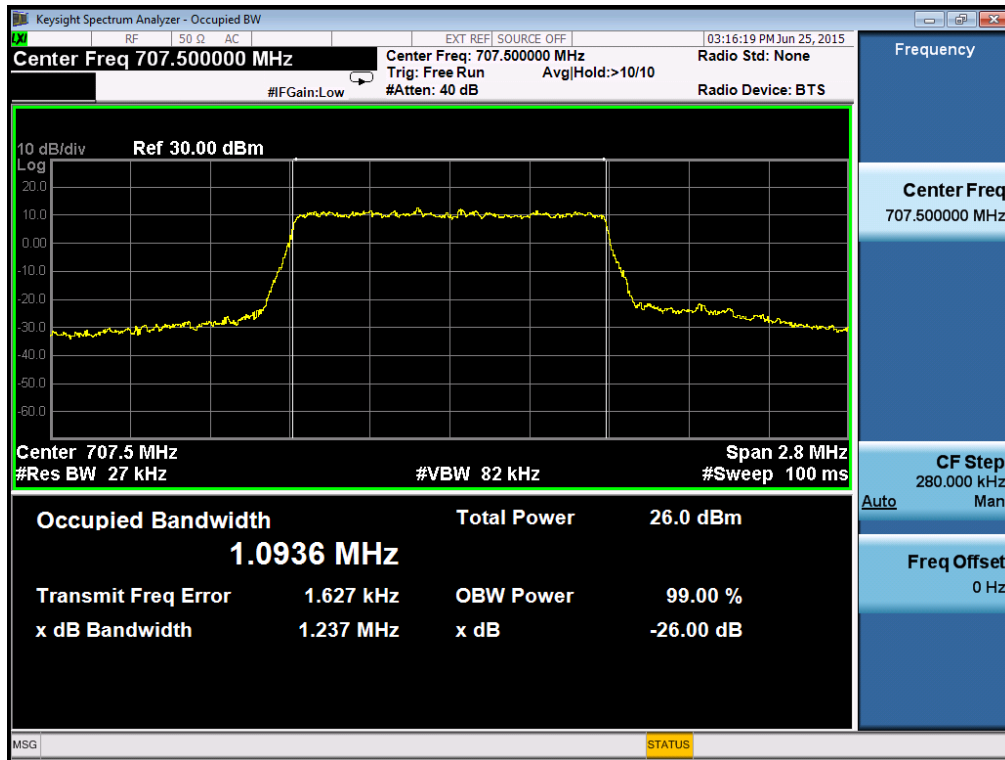

### 99% Occupied Bandwidth channel Highest

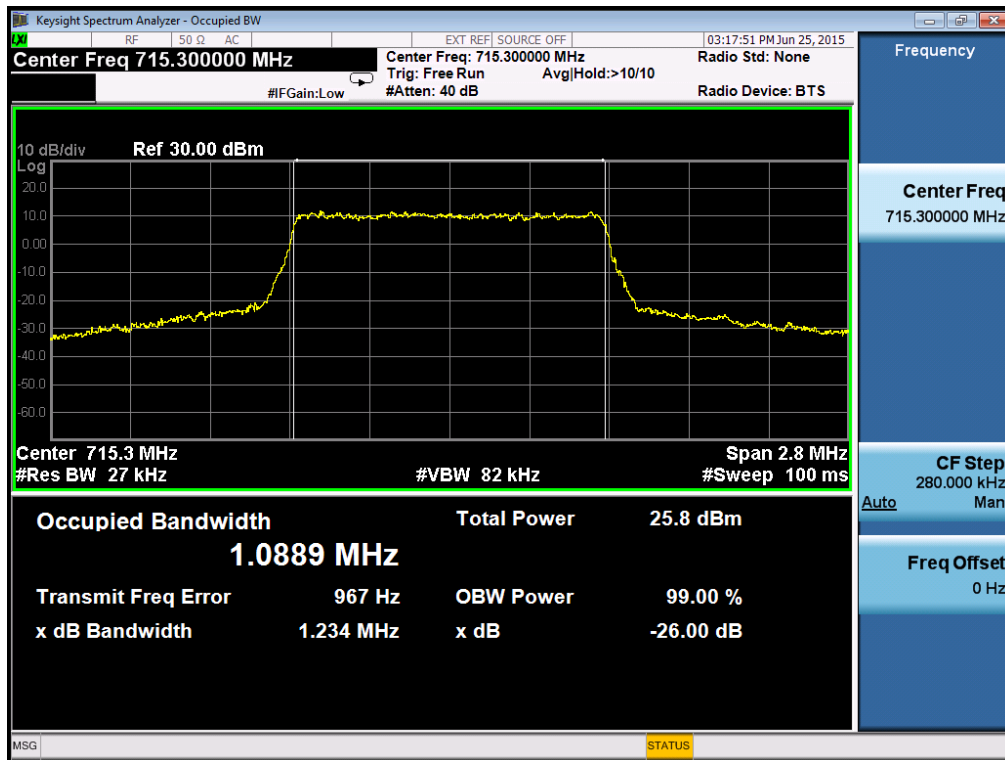

Test Mode : TX Mode Configuration16-QAM-3M/15RB			
Channel	99% OBW (MHz)	-26dBc Bandwidth	Result
Lowest	2.704	2.947	Complies
Middle	2.709	2.962	Complies
Highest	2.704	2.957	Complies

### 99% Occupied Bandwidth channel Lowest

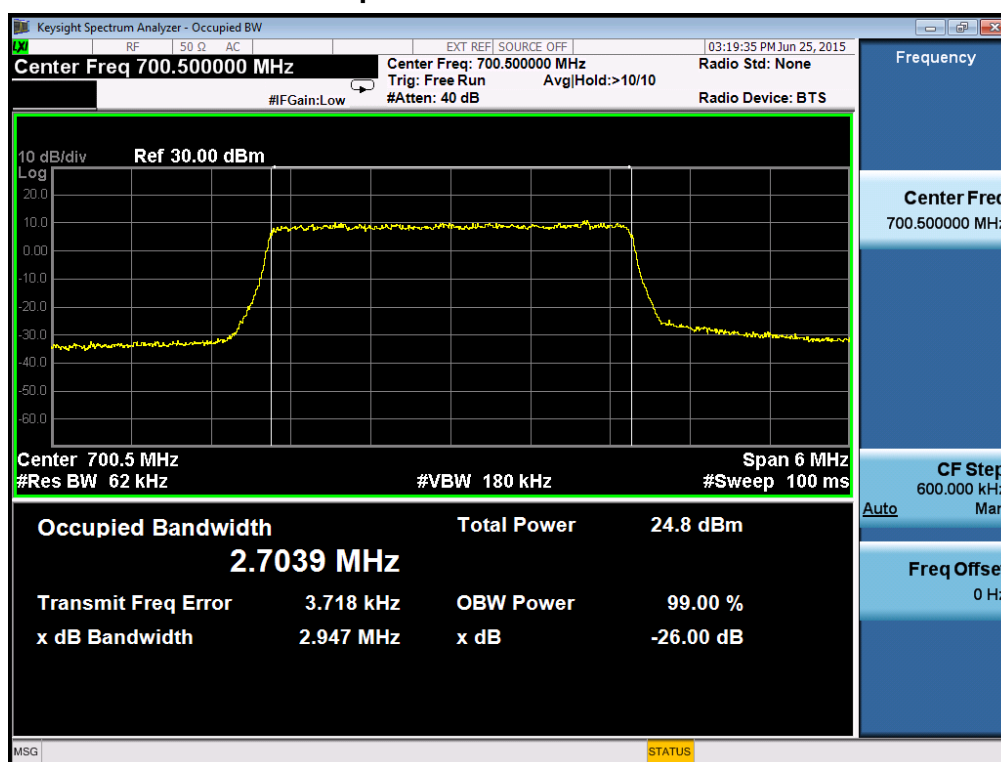

### 99% Occupied Bandwidth channel Middle

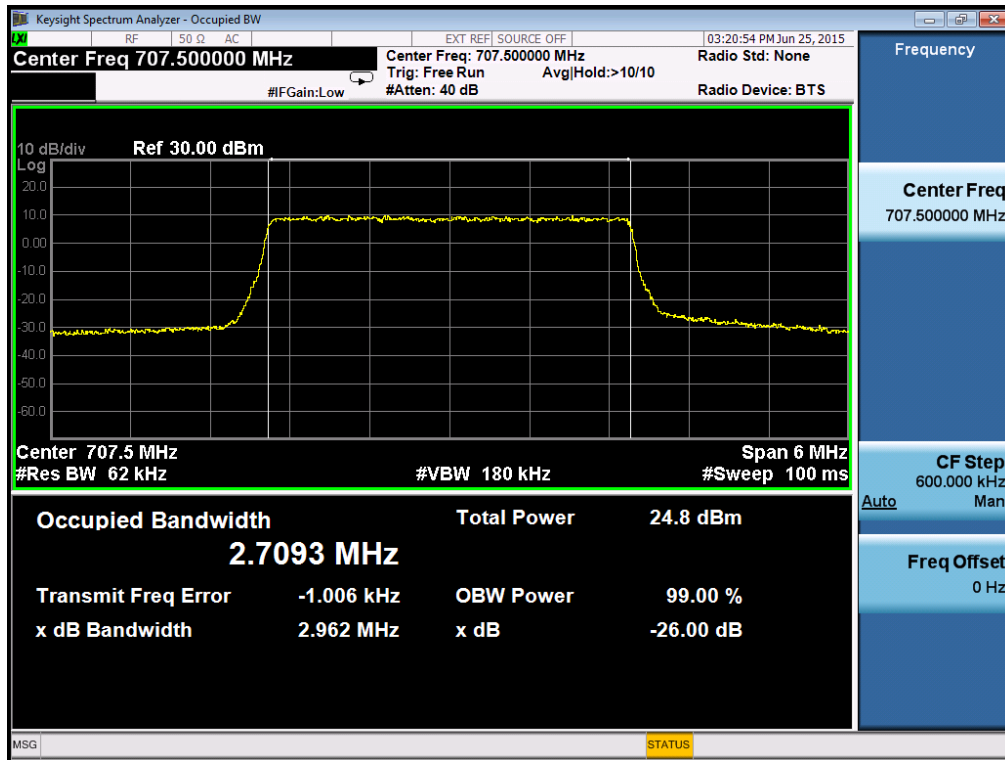

### 99% Occupied Bandwidth channel Highest

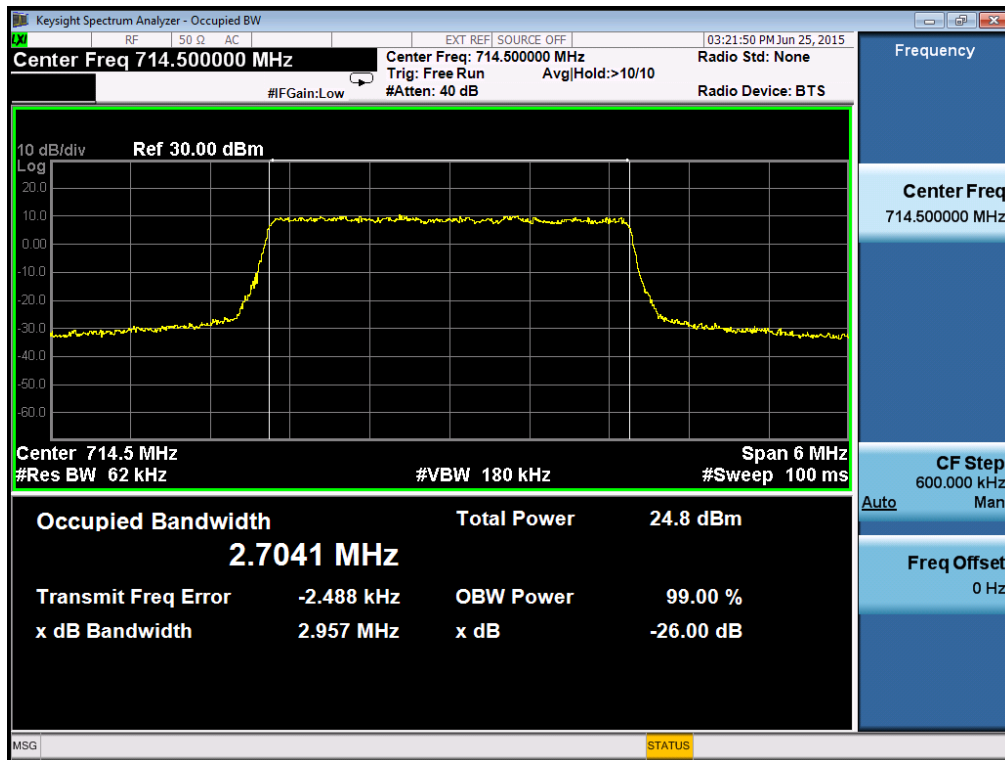



Test Mode : TX Mode Configuration16-QAM-5M/25RB			
Channel	99% OBW (MHz)	-26dBc Bandwidth	Result
Lowest	4.494	4.873	Complies
Middle	4.498	4.823	Complies
Highest	4.503	4.845	Complies

### 99% Occupied Bandwidth channel Lowest

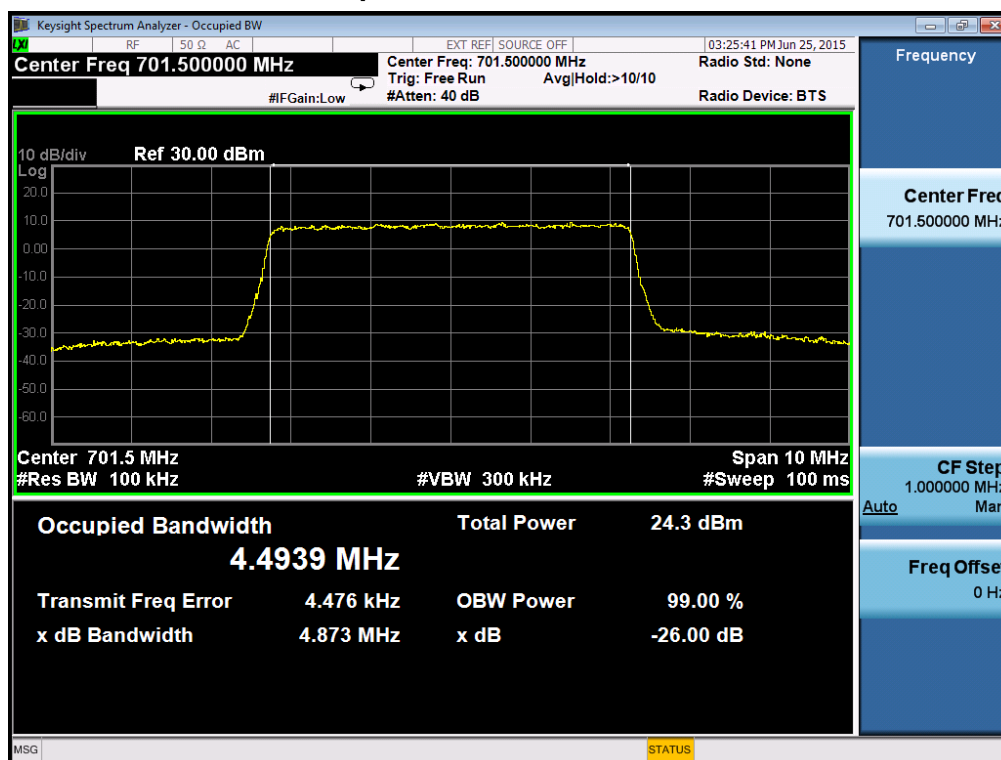

### 99% Occupied Bandwidth channel Middle

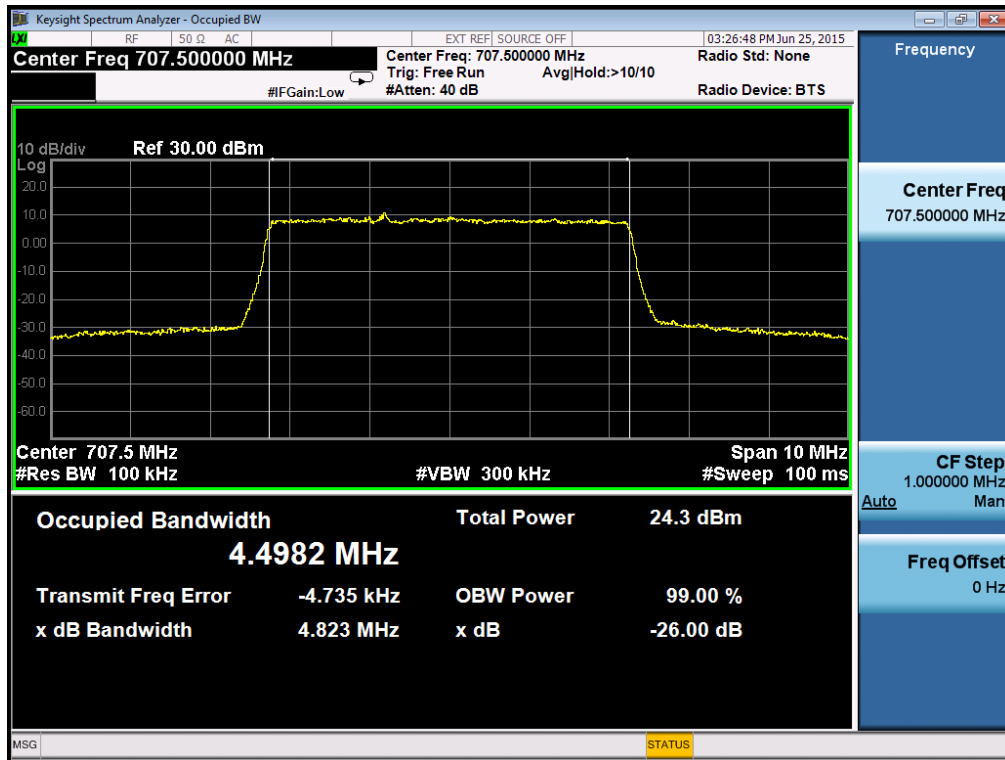

### 99% Occupied Bandwidth channel Highest

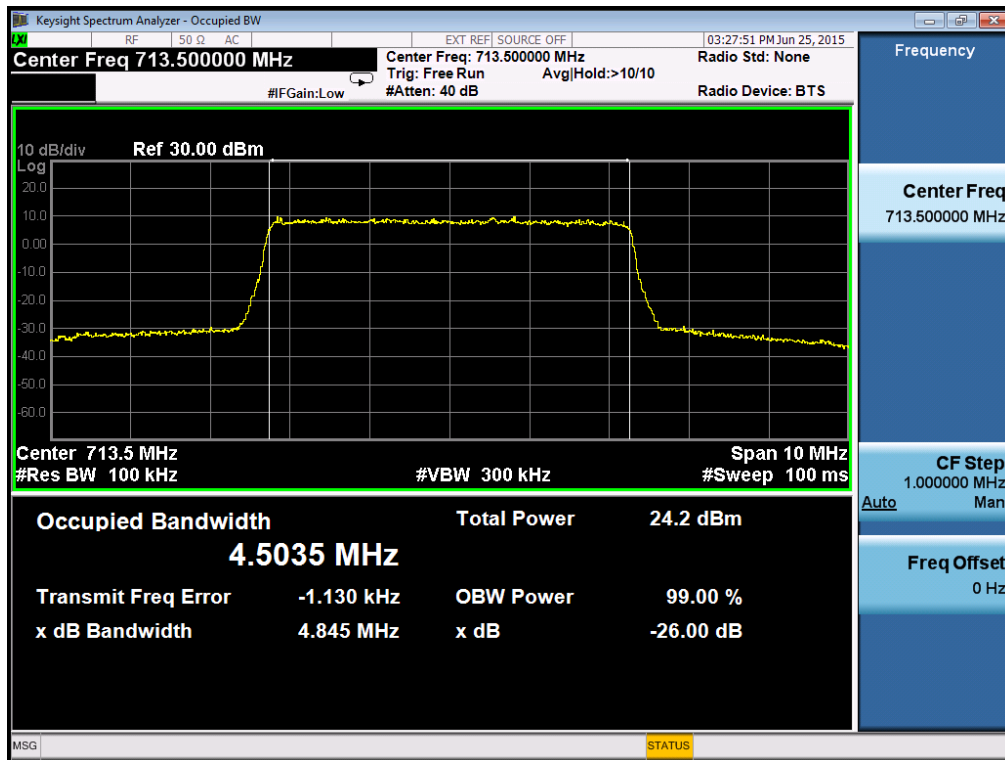

Test Mode : TX Mode Configuration16-QAM-10M/50RB			
Channel	99% OBW (MHz)	-26dBc Bandwidth	Result
Lowest	8.969	9.549	Complies
Middle	8.964	9.553	Complies
Highest	8.984	9.578	Complies

### 99% Occupied Bandwidth channel Lowest

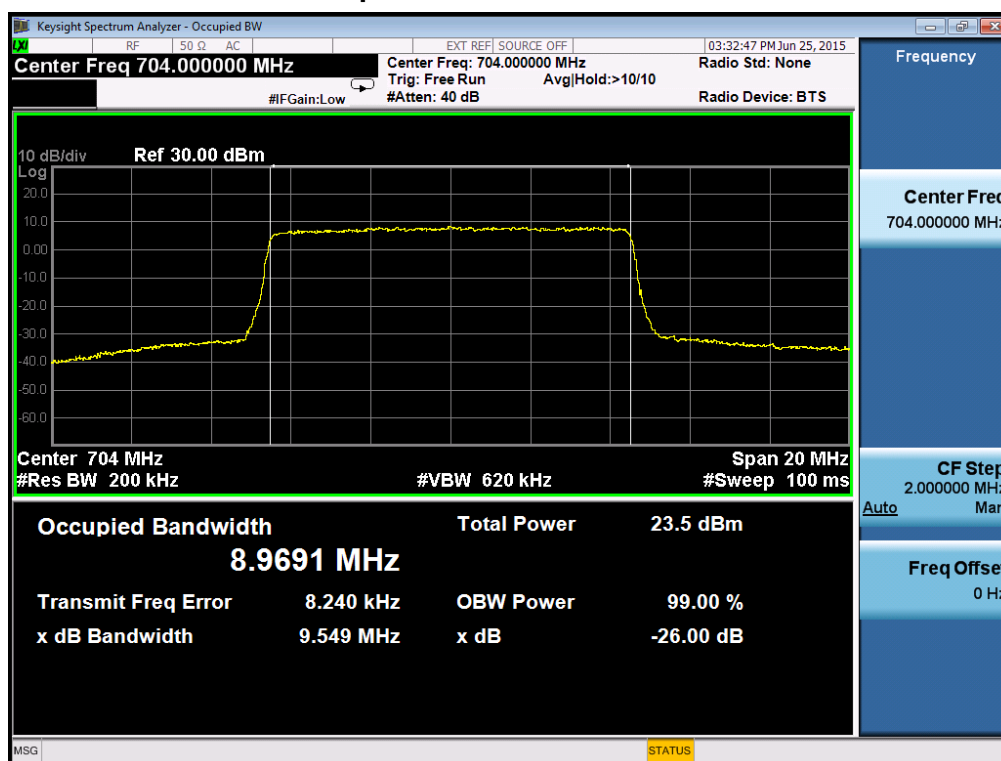

### 99% Occupied Bandwidth channel Middle

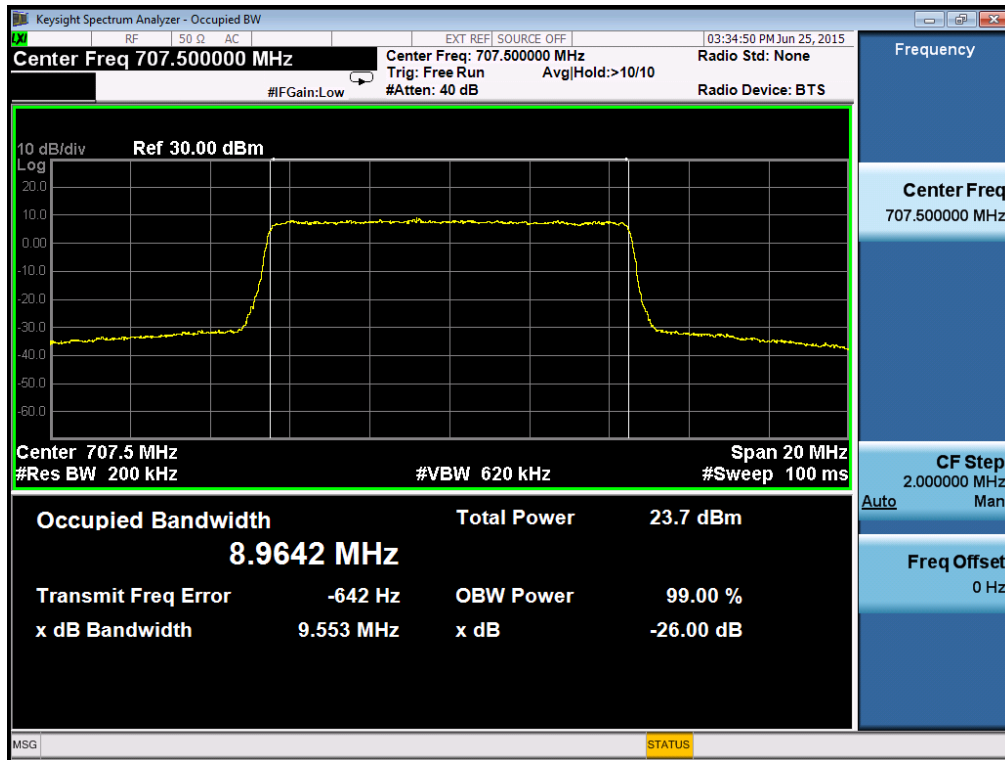

### 99% Occupied Bandwidth channel Highest

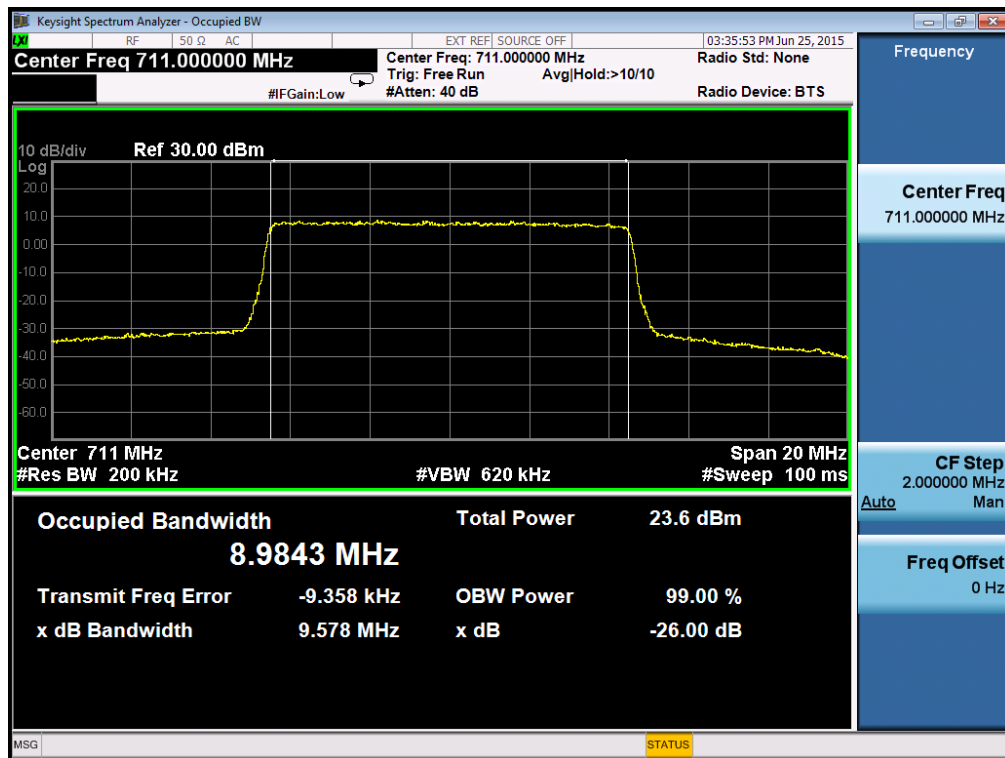

## **ATTACHMENT C - SPURIOUS EMISSIONS AT ANTENNA TERMINALS**

### Conducted Spurious of Configuration-QPSK-1.4M/1RB



### Conducted Spurious of Configuration-QPSK-3M/1RB

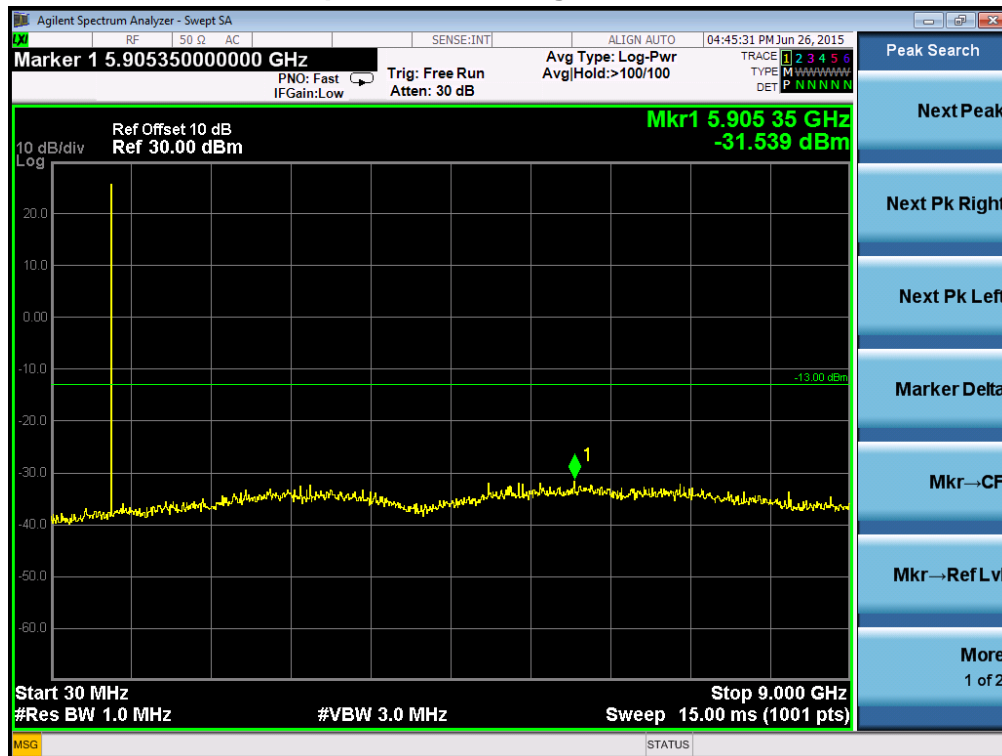

### Conducted Spurious of Configuration-QPSK-5M/1RB



### Conducted Spurious of Configuration-QPSK-10M/1RB

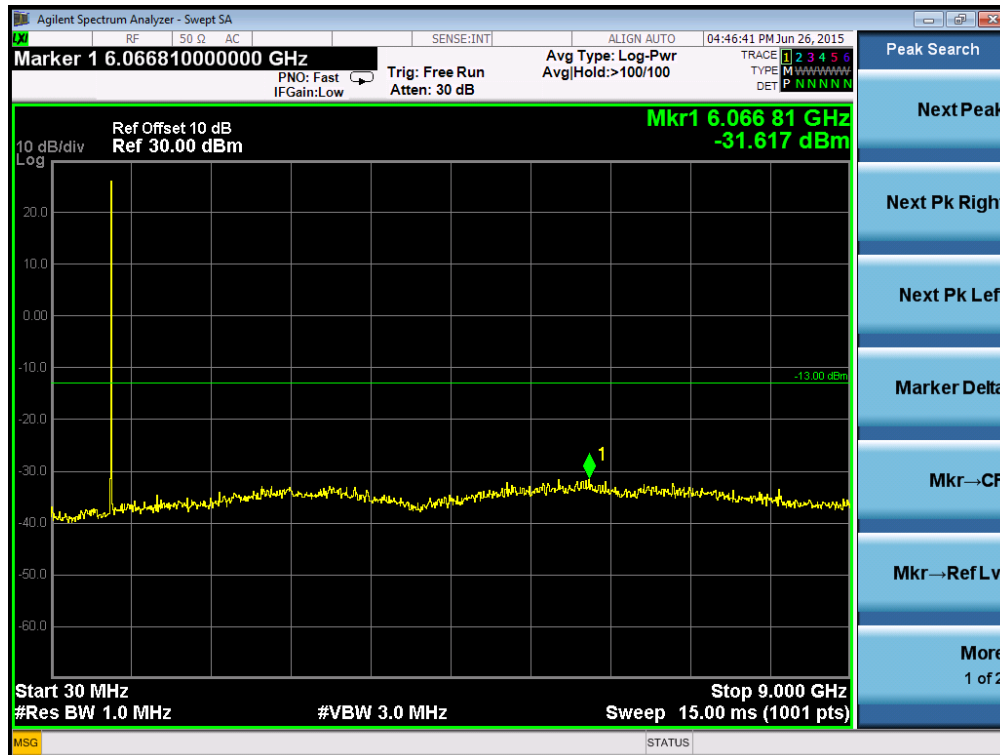

## **ATTACHMENTD - SPURIOUS RADIATED EMISSION**



Test Mode: TX Channel Middle-QPSK 1.4M/1RB

**Vertical**



No.	Mk.	Freq. MHz	Reading Level dBm	Correct Factor dB	Measure- ment dBm	Limit dBm	Margin dB	Detector	Comment
1		36.7900	-68.73	-0.18	-68.91	-13.00	-55.91	peak	
2		52.3100	-71.10	1.58	-69.52	-13.00	-56.52	peak	
3		160.9500	-72.89	2.87	-70.02	-13.00	-57.02	peak	
4		273.4700	-76.98	2.35	-74.63	-13.00	-61.63	peak	
5		505.3000	-78.60	7.54	-71.06	-13.00	-58.06	peak	
6	*	870.9900	-79.19	13.72	-65.47	-13.00	-52.47	peak	

Test Mode: TX Channel Middle-QPSK 1.4M/1RB

### Horizontal

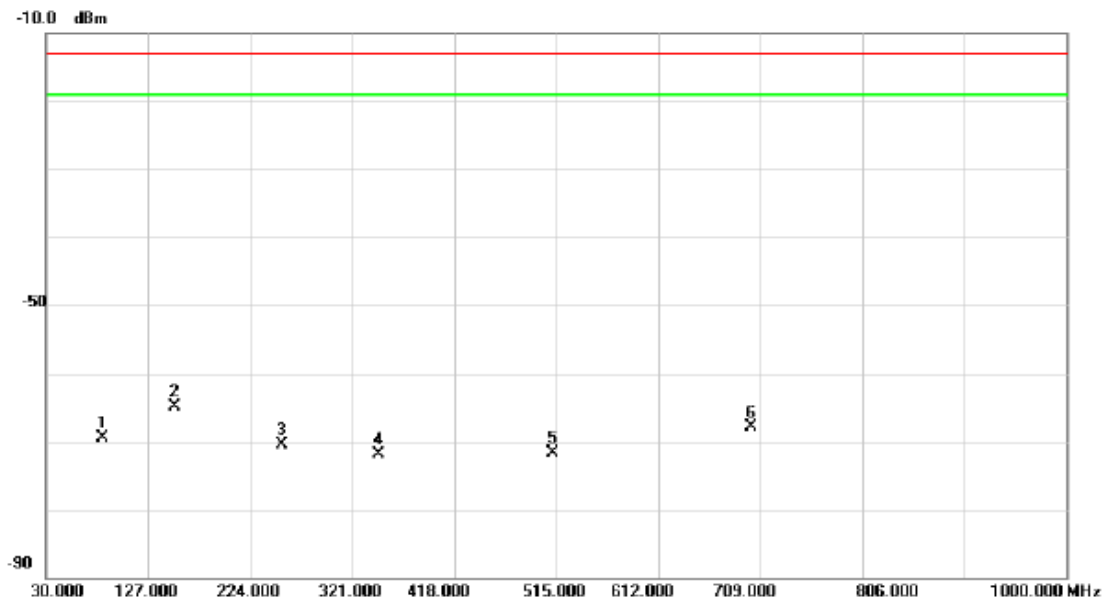

No.	Mk.	Freq. MHz	Reading Level dBm	Correct Factor dB	Measure- ment dBm	Limit dBm	Margin dB	Detector	Comment
1		83.3500	-61.65	-7.76	-69.41	-13.00	-56.41	peak	
2	*	152.2200	-68.72	3.91	-64.81	-13.00	-51.81	peak	
3		254.0700	-72.36	1.89	-70.47	-13.00	-57.47	peak	
4		346.2200	-74.72	2.90	-71.82	-13.00	-58.82	peak	
5		511.1200	-79.79	8.07	-71.72	-13.00	-58.72	peak	
6		700.2700	-81.82	13.97	-67.85	-13.00	-54.85	peak	

Test Mode: TX Channel Middle-QPSK 3M/1RB

**Vertical**

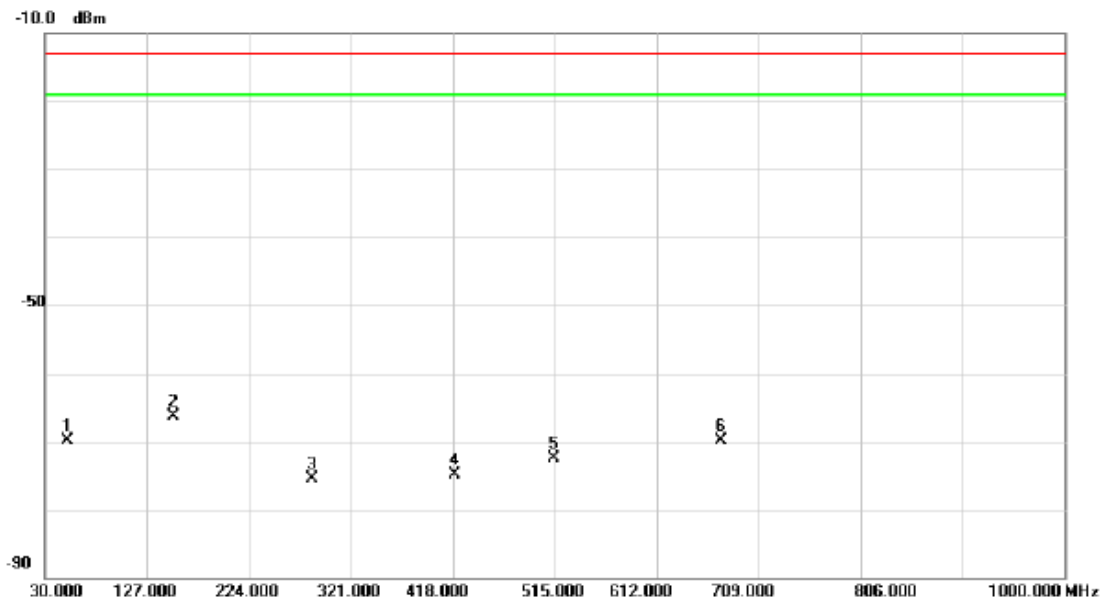

No.	Mk.	Freq. MHz	Reading Level dBm	Correct Factor dB	Measure- ment dBm	Limit dBm	Margin dB	Detector	Comment
1		51.3400	-71.10	1.17	-69.93	-13.00	-56.93	peak	
2	*	152.2200	-69.53	3.16	-66.37	-13.00	-53.37	peak	
3		284.1400	-78.06	2.47	-75.59	-13.00	-62.59	peak	
4		419.9400	-79.54	4.65	-74.89	-13.00	-61.89	peak	
5		514.0300	-80.08	7.52	-72.56	-13.00	-59.56	peak	
6		673.1100	-80.23	10.29	-69.94	-13.00	-56.94	peak	

Test Mode: TX Channel Middle-QPSK 3M/1RB

### Horizontal

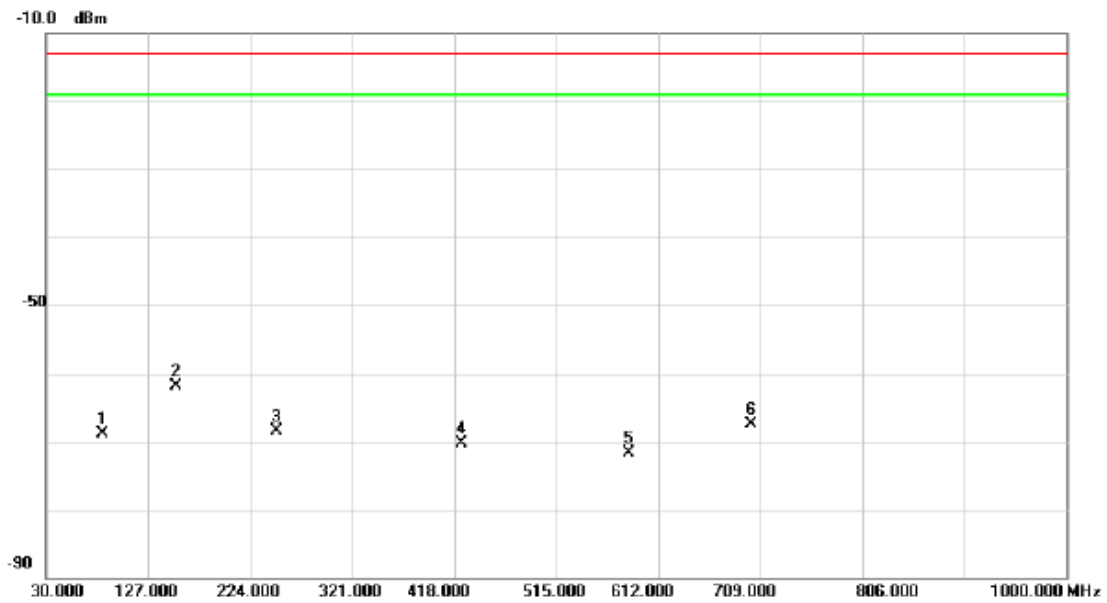

No.	Mk.	Freq. MHz	Reading Level dBm	Correct Factor dB	Measure- ment dBm	Limit dBm	Margin dB	Detector	Comment
1		83.3500	-61.21	-7.76	-68.97	-13.00	-55.97	peak	
2	*	153.1900	-65.73	3.76	-61.97	-13.00	-48.97	peak	
3		249.2200	-70.33	1.91	-68.42	-13.00	-55.42	peak	
4		424.7900	-76.64	6.34	-70.30	-13.00	-57.30	peak	
5		583.8700	-80.55	8.80	-71.75	-13.00	-58.75	peak	
6		700.2700	-81.50	13.97	-67.53	-13.00	-54.53	peak	

Test Mode: TX Channel Middle-QPSK 5M/1RB

Vertical

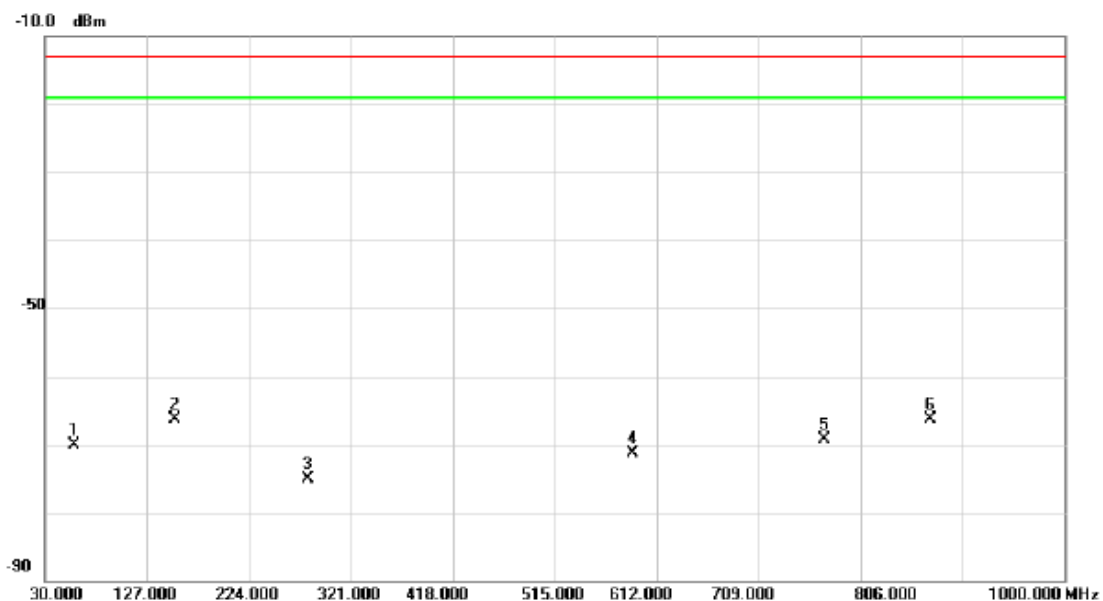

No.	Mk.	Freq. MHz	Reading Level dBm	Correct Factor dB	Measure- ment dBm	Limit dBm	Margin dB	Detector	Comment
1		58.1300	-71.45	1.31	-70.14	-13.00	-57.14	peak	
2		153.1900	-69.55	3.16	-66.39	-13.00	-53.39	peak	
3		280.2600	-77.71	2.64	-75.07	-13.00	-62.07	peak	
4		589.6900	-79.80	8.44	-71.36	-13.00	-58.36	peak	
5		772.0500	-81.42	12.22	-69.20	-13.00	-56.20	peak	
6	*	871.9600	-79.91	13.69	-66.22	-13.00	-53.22	peak	

Test Mode: TX Channel Middle-QPSK 5M/1RB

### Horizontal

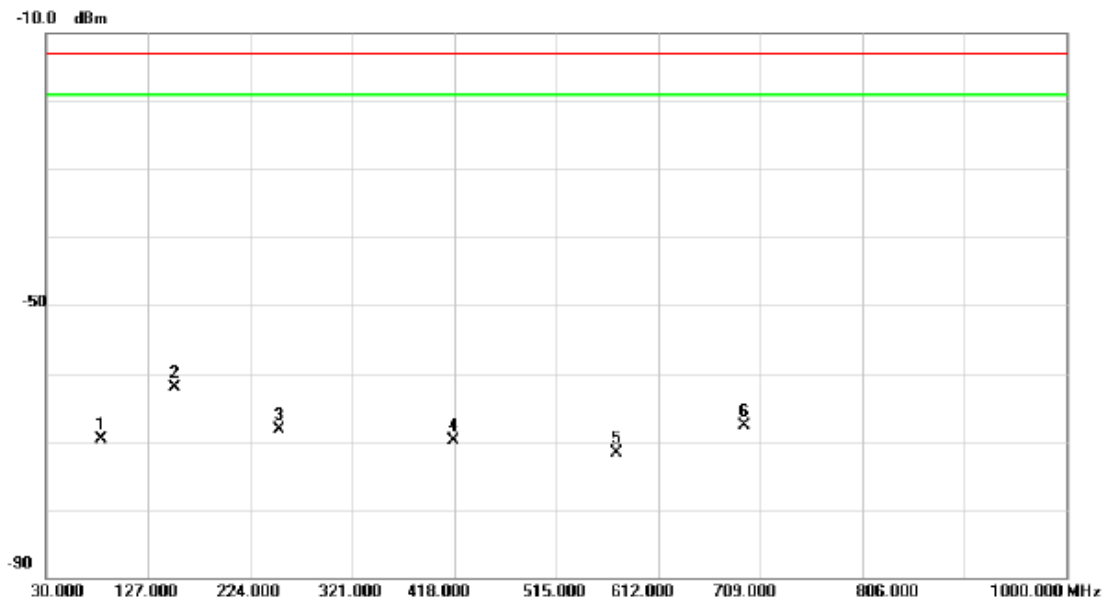

No.	Mk.	Freq. MHz	Reading Level dBm	Correct Factor dB	Measure- ment dBm	Limit dBm	Margin dB	Detector	Comment
1		82.3800	-62.12	-7.64	-69.76	-13.00	-56.76	peak	
2	*	152.2200	-65.94	3.91	-62.03	-13.00	-49.03	peak	
3		251.1600	-70.13	1.88	-68.25	-13.00	-55.25	peak	
4		417.0300	-76.66	6.73	-69.93	-13.00	-56.93	peak	
5		572.2300	-80.28	8.56	-71.72	-13.00	-58.72	peak	
6		693.4800	-81.32	13.54	-67.78	-13.00	-54.78	peak	

Test Mode: TX Channel Middle-QPSK 10M/1RB

Vertical



No.	Mk.	Freq. MHz	Reading Level dBm	Correct Factor dB	Measure- ment dBm	Limit dBm	Margin dB	Detector	Comment
1		36.7900	-70.88	-0.18	-71.06	-13.00	-58.06	peak	
2		58.1300	-71.90	1.31	-70.59	-13.00	-57.59	peak	
3		153.1900	-70.01	3.16	-66.85	-13.00	-53.85	peak	
4		271.5300	-77.50	2.26	-75.24	-13.00	-62.24	peak	
5		498.5100	-79.15	7.46	-71.69	-13.00	-58.69	peak	
6	*	870.9900	-78.94	13.72	-65.22	-13.00	-52.22	peak	

Test Mode: TX Channel Middle-QPSK 10M/1RB

### Horizontal

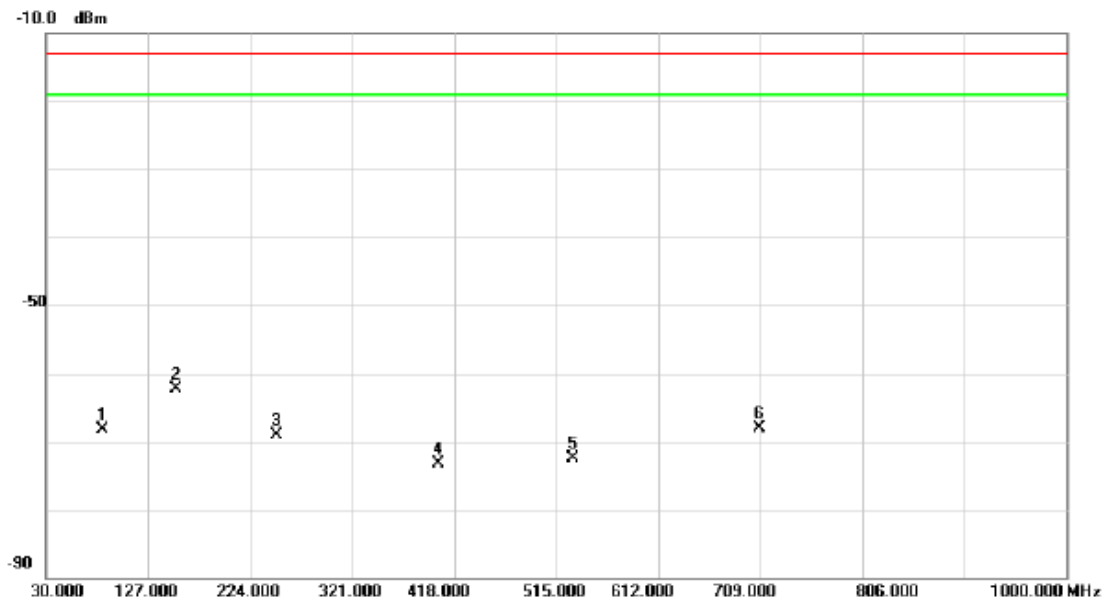

No.	Mk.	Freq. MHz	Reading Level dBm	Correct Factor dB	Measure- ment dBm	Limit dBm	Margin dB	Detector	Comment
1		83.3500	-60.46	-7.76	-68.22	-13.00	-55.22	peak	
2	*	153.1900	-65.99	3.76	-62.23	-13.00	-49.23	peak	
3		249.2200	-70.95	1.91	-69.04	-13.00	-56.04	peak	
4		403.4500	-79.36	6.05	-73.31	-13.00	-60.31	peak	
5		531.4900	-80.61	8.09	-72.52	-13.00	-59.52	peak	
6		708.0300	-81.85	13.79	-68.06	-13.00	-55.06	peak	



Test Mode: TX Channel Middle-QPSK 1.4M/1RB

Vertical

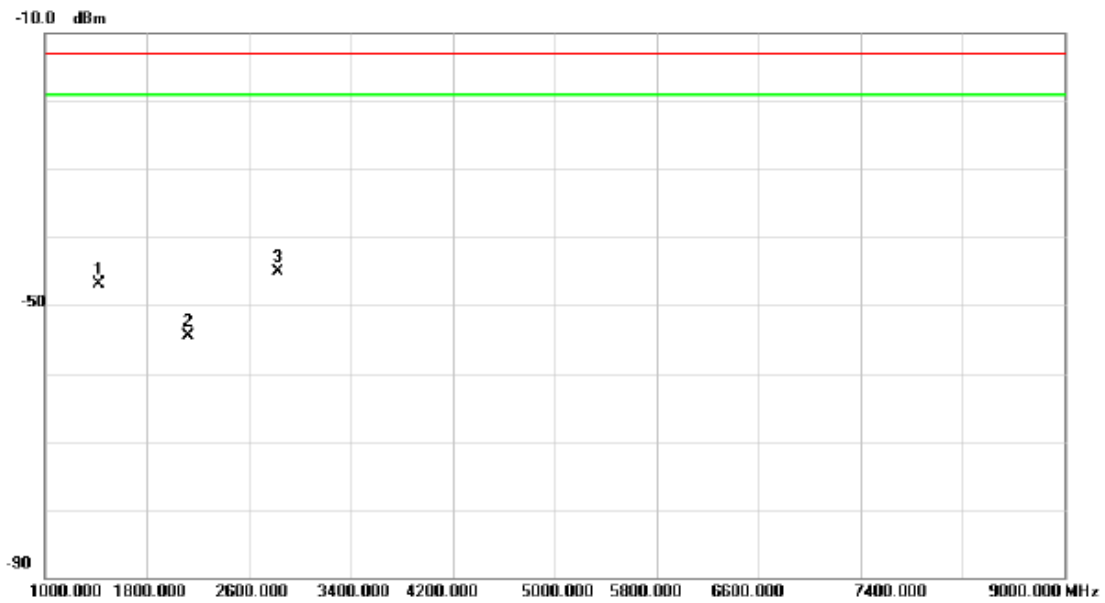

No.	Mk.	Freq. MHz	Reading Level dBm	Correct Factor dB	Measure- ment dBm	Limit dBm	Margin dB	Detector	Comment
1		1416.000	-44.41	-2.56	-46.97	-13.00	-33.97	peak	
2		2120.000	-55.22	0.78	-54.44	-13.00	-41.44	peak	
3	*	2828.000	-48.44	3.35	-45.09	-13.00	-32.09	peak	

Test Mode: TX Channel Middle-QPSK 1.4M/1RB

### Horizontal

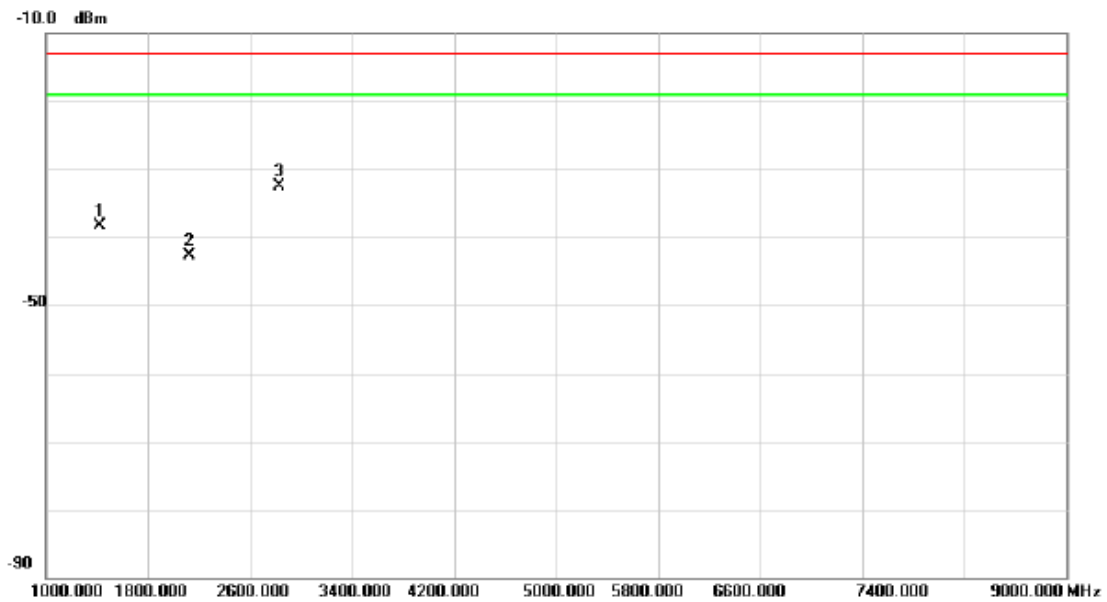

No.	Mk.	Freq. MHz	Reading Level dBm	Correct Factor dB	Measure- ment dBm	Limit dBm	Margin dB	Detector	Comment
1		1416.000	-40.12	1.82	-38.30	-13.00	-25.30	peak	
2		2120.000	-45.37	2.63	-42.74	-13.00	-29.74	peak	
3	*	2828.000	-38.92	6.39	-32.53	-13.00	-19.53	peak	

Test Mode: TX Channel Middle-QPSK 3M/1RB

**Vertical**

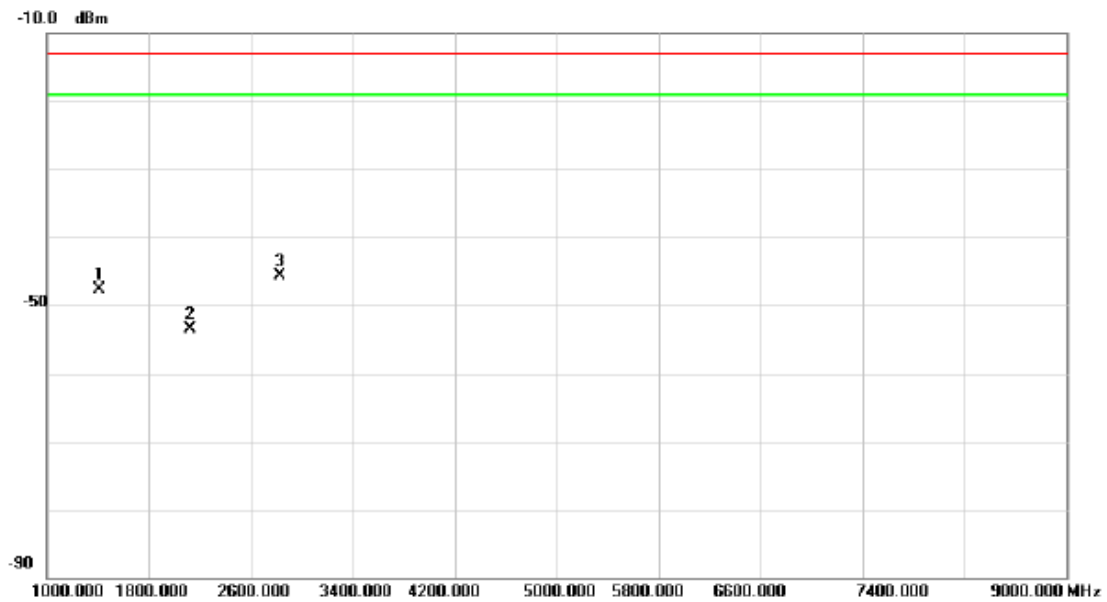

No.	Mk.	Freq. MHz	Reading Level dBm	Correct Factor dB	Measure- ment dBm	Limit dBm	Margin dB	Detector	Comment
1		1412.000	-45.07	-2.58	-47.65	-13.00	-34.65	peak	
2		2120.000	-54.36	0.78	-53.58	-13.00	-40.58	peak	
3	*	2824.000	-48.97	3.32	-45.65	-13.00	-32.65	peak	

Test Mode: TX Channel Middle-QPSK 3M/1RB

### Horizontal

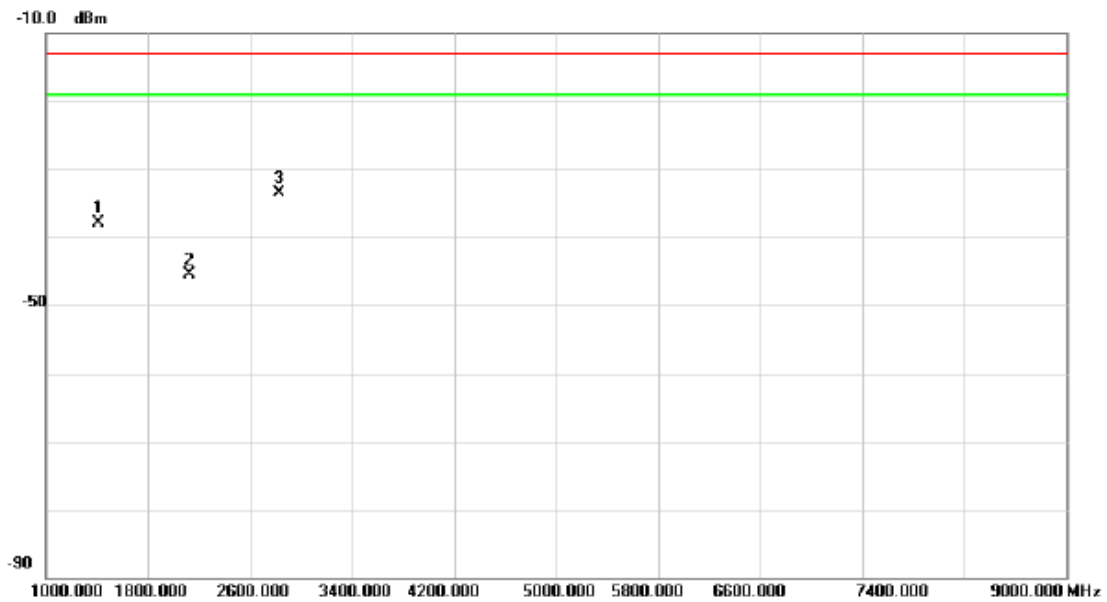

No.	Mk.	Freq. MHz	Reading Level dBm	Correct Factor dB	Measure- ment dBm	Limit dBm	Margin dB	Detector	Comment
1		1412.000	-39.60	1.76	-37.84	-13.00	-24.84	peak	
2		2120.000	-48.08	2.63	-45.45	-13.00	-32.45	peak	
3	*	2824.000	-39.83	6.34	-33.49	-13.00	-20.49	peak	

Test Mode: TX Channel Middle-QPSK 5M/1RB

Vertical

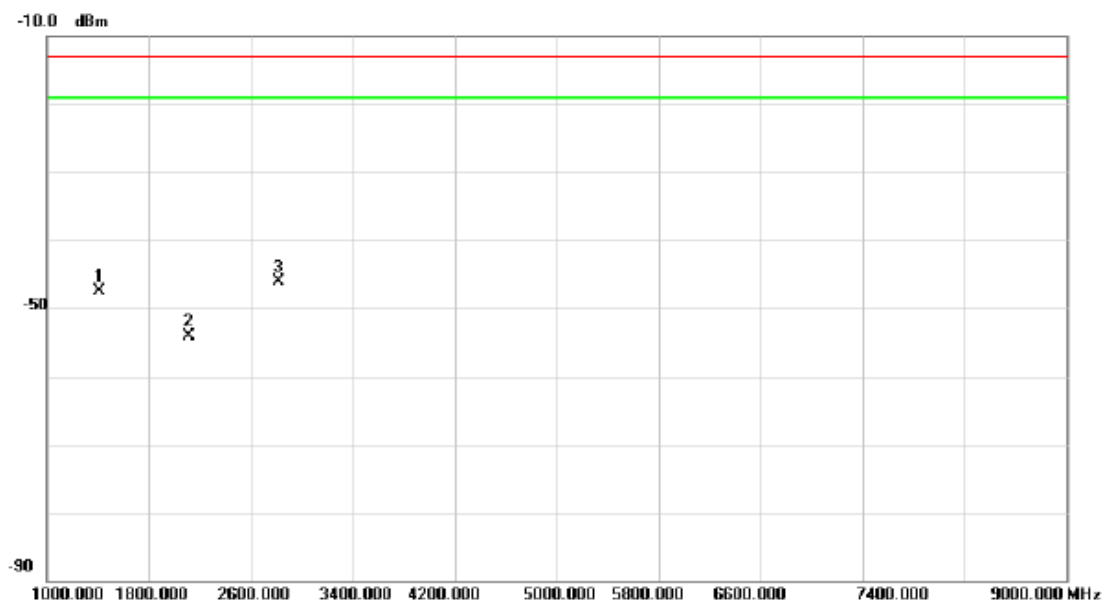

No.	Mk.	Freq. MHz	Reading Level dBm	Correct Factor dB	Measure- ment dBm	Limit dBm	Margin dB	Detector	Comment
1		1412.000	-44.92	-2.58	-47.50	-13.00	-34.50	peak	
2		2116.000	-54.88	0.78	-54.10	-13.00	-41.10	peak	
3	*	2820.000	-49.30	3.28	-46.02	-13.00	-33.02	peak	

Test Mode: TX Channel Middle-QPSK 5M/1RB

### Horizontal

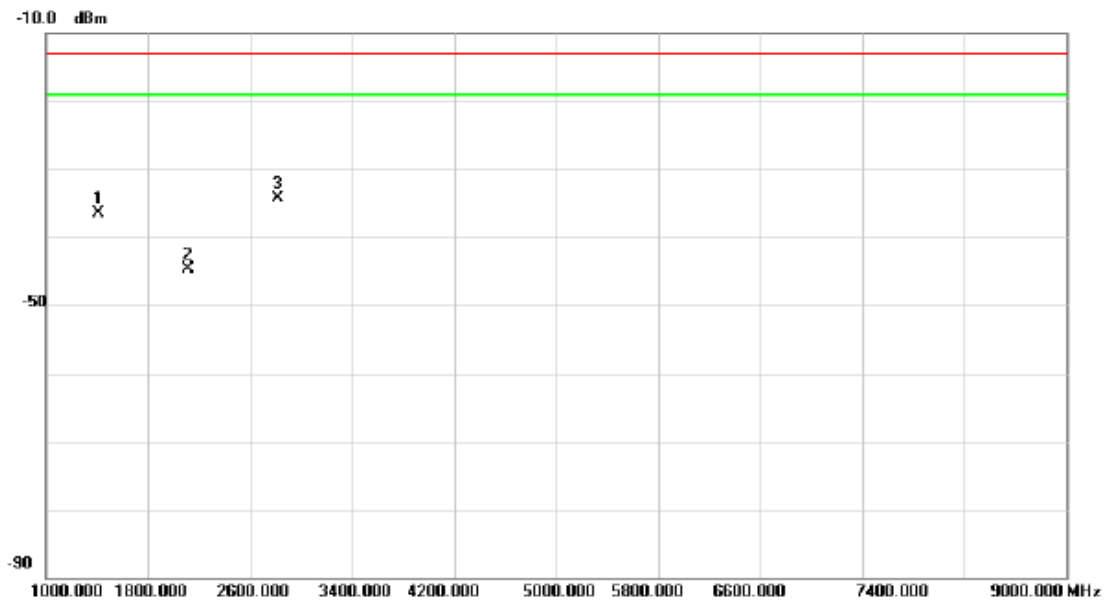

No.	Mk.	Freq. MHz	Reading Level dBm	Correct Factor dB	Measure- ment dBm	Limit dBm	Margin dB	Detector	Comment
1		1412.000	-38.30	1.76	-36.54	-13.00	-23.54	peak	
2		2116.000	-47.23	2.63	-44.60	-13.00	-31.60	peak	
3	*	2820.000	-40.52	6.30	-34.22	-13.00	-21.22	peak	

Test Mode: TX Channel Middle-QPSK 10M/1RB

Vertical

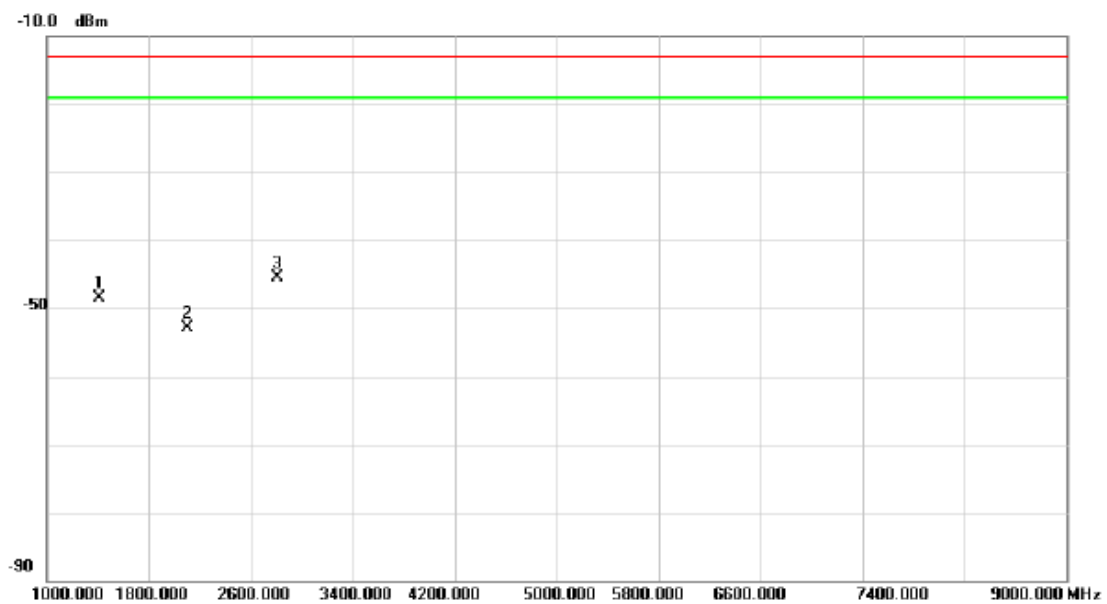

No.	Mk.	Freq. MHz	Reading Level dBm	Correct Factor dB	Measure- ment dBm	Limit dBm	Margin dB	Detector	Comment
1		1408.000	-45.95	-2.60	-48.55	-13.00	-35.55	peak	
2		2108.000	-53.69	0.79	-52.90	-13.00	-39.90	peak	
3	*	2812.000	-48.76	3.21	-45.55	-13.00	-32.55	peak	

Test Mode: TX Channel Middle-QPSK 10M/1RB

### Horizontal

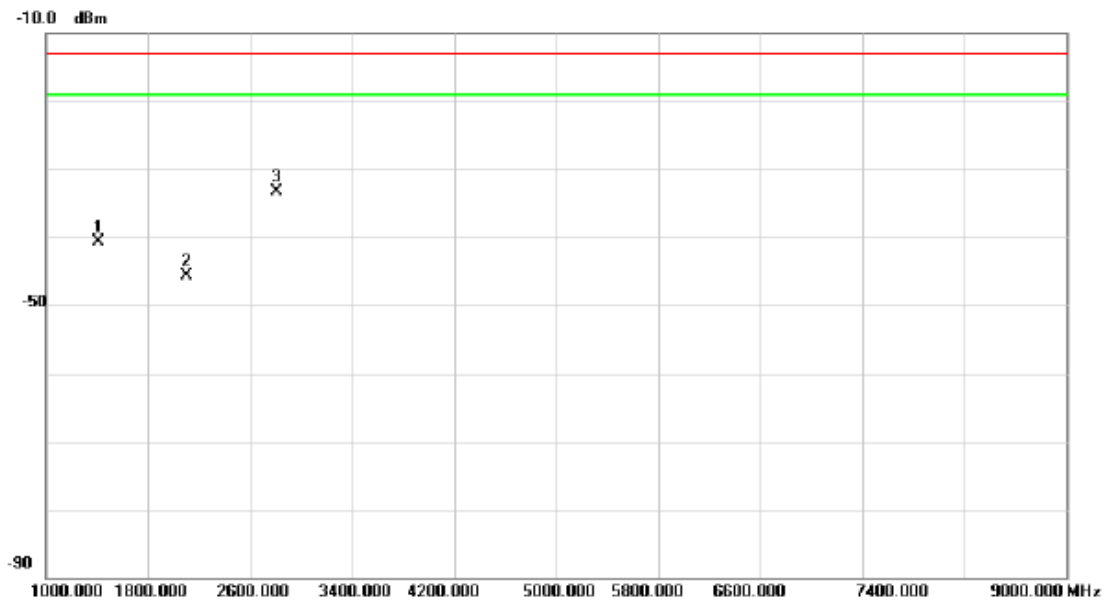

No.	Mk.	Freq. MHz	Reading Level dBm	Correct Factor dB	Measure- ment dBm	Limit dBm	Margin dB	Detector	Comment
1		1408.000	-42.34	1.71	-40.63	-13.00	-27.63	peak	
2		2108.000	-48.36	2.63	-45.73	-13.00	-32.73	peak	
3	*	2812.000	-39.57	6.21	-33.36	-13.00	-20.36	peak	



**ATTACHMENTE - BAND EDGE**

### Band Edge on Configuration QPSK-1.4M / 1RB Channel Lowest-CONDUCTED MODE

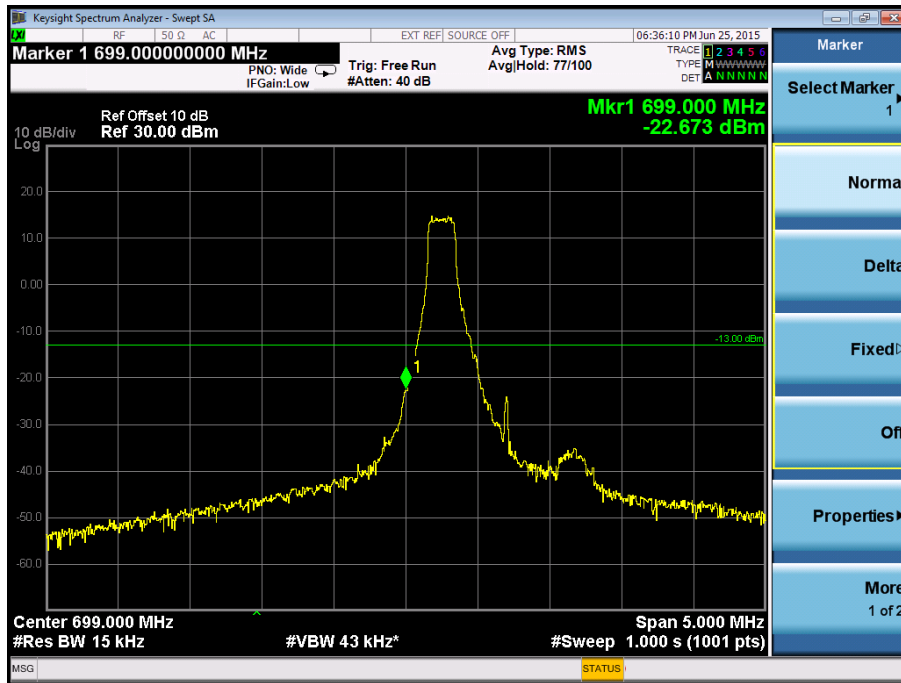

### Band Edge on Configuration QPSK-1.4M / 1RB Channel Highest-CONDUCTED MODE

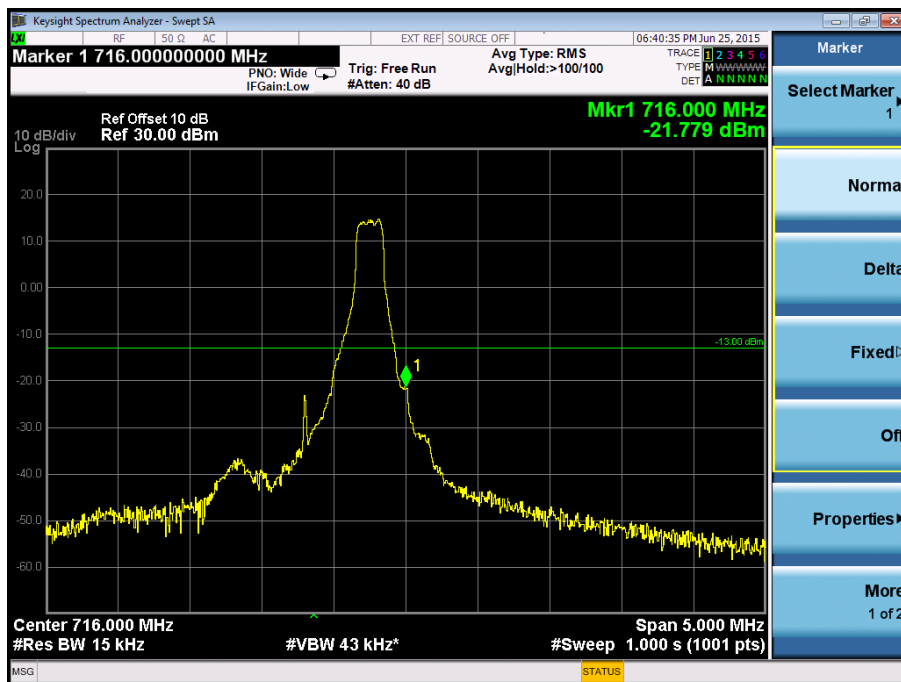

### Band Edge on Configuration QPSK-1.4M / 6RB Channel Lowest-CONDUCTED MODE



### Band Edge on Configuration QPSK-1.4M / 6RB Channel Highest-CONDUCTED MODE



### Band Edge on Configuration QPSK-3M / 1RB Channel Lowest-CONDUCTED MODE

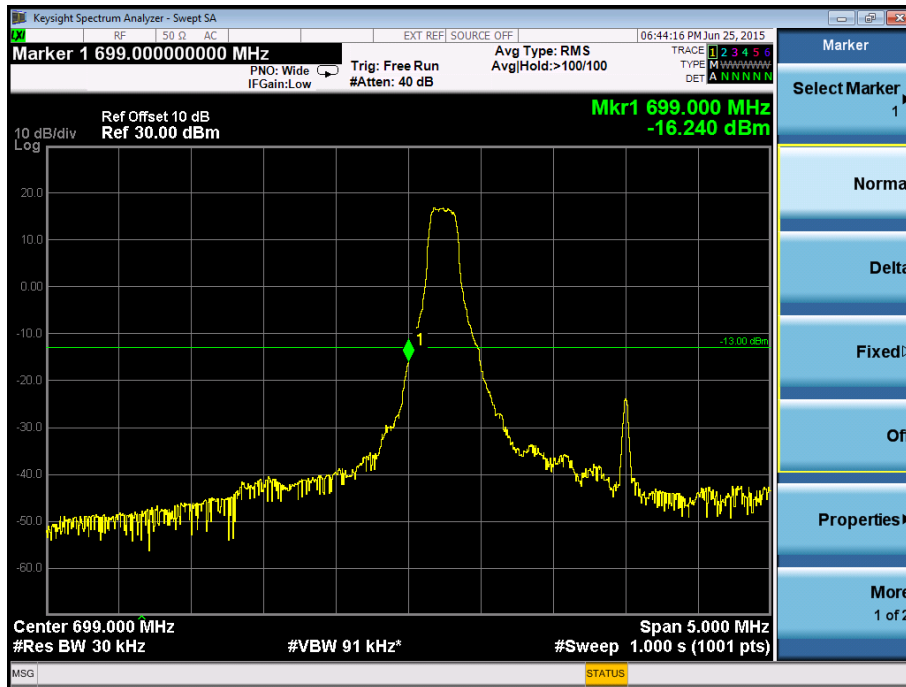

### Band Edge on Configuration QPSK-3M / 1RB Channel Highest-CONDUCTED MODE

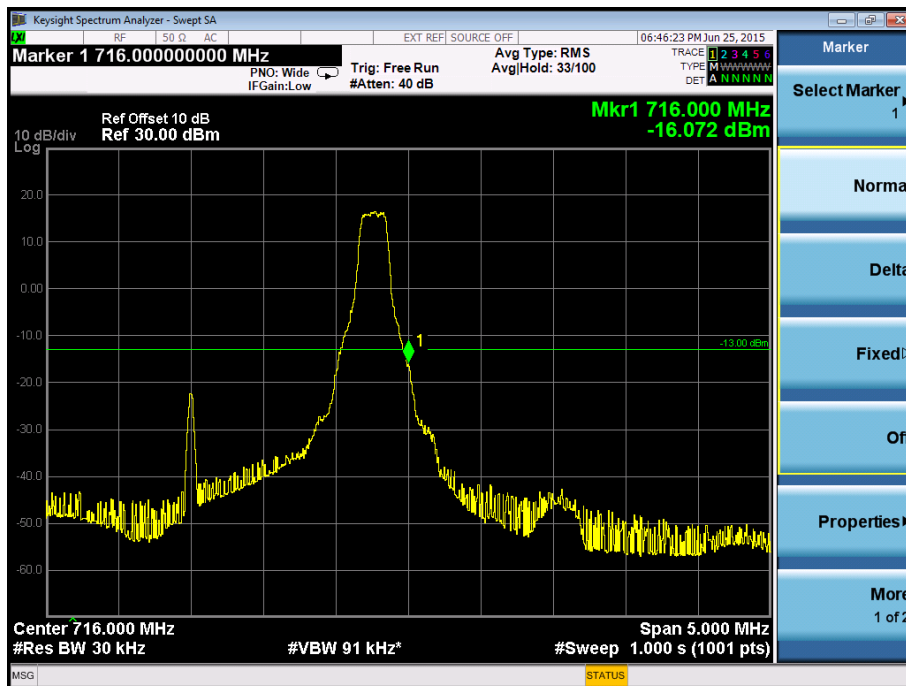

### Band Edge on Configuration QPSK-3M / 15RB Channel Lowest-CONDUCTED MODE

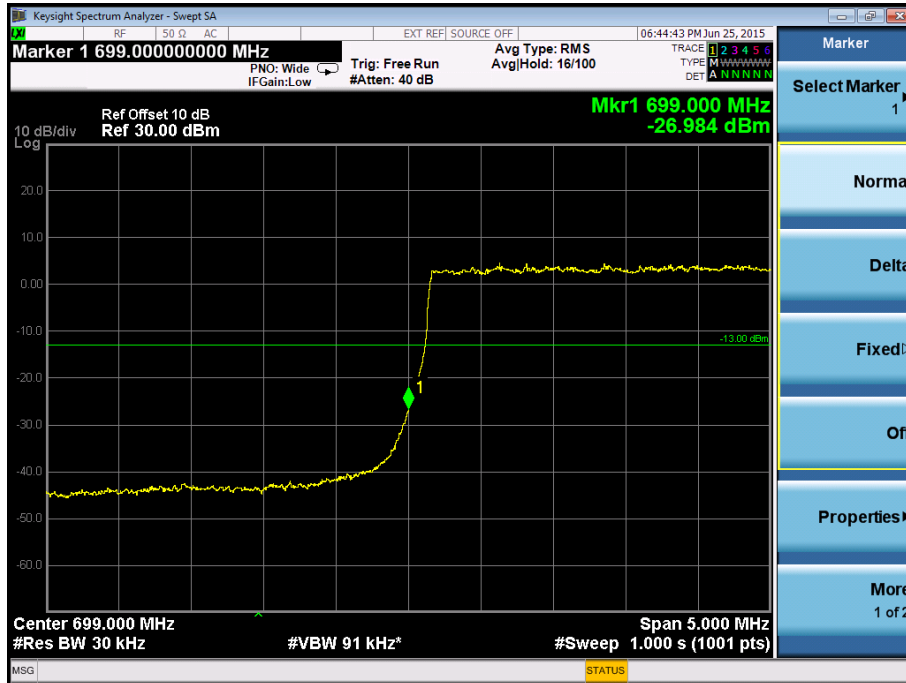

### Band Edge on Configuration QPSK-3M / 15RB Channel Highest-CONDUCTED MODE

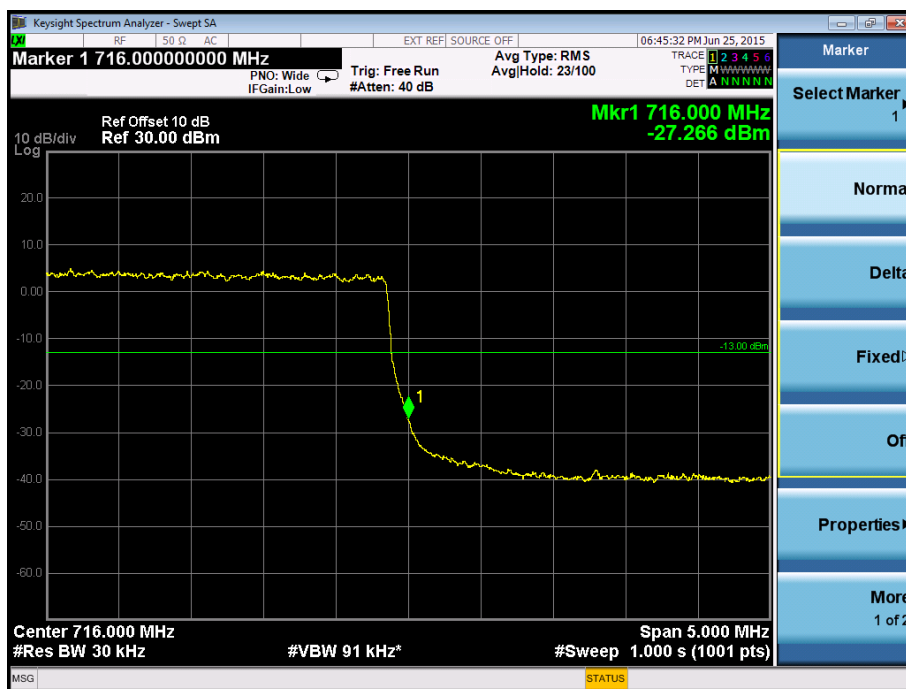

### Band Edge on Configuration QPSK-5M / 1RB Channel Lowest-CONDUCTED MODE

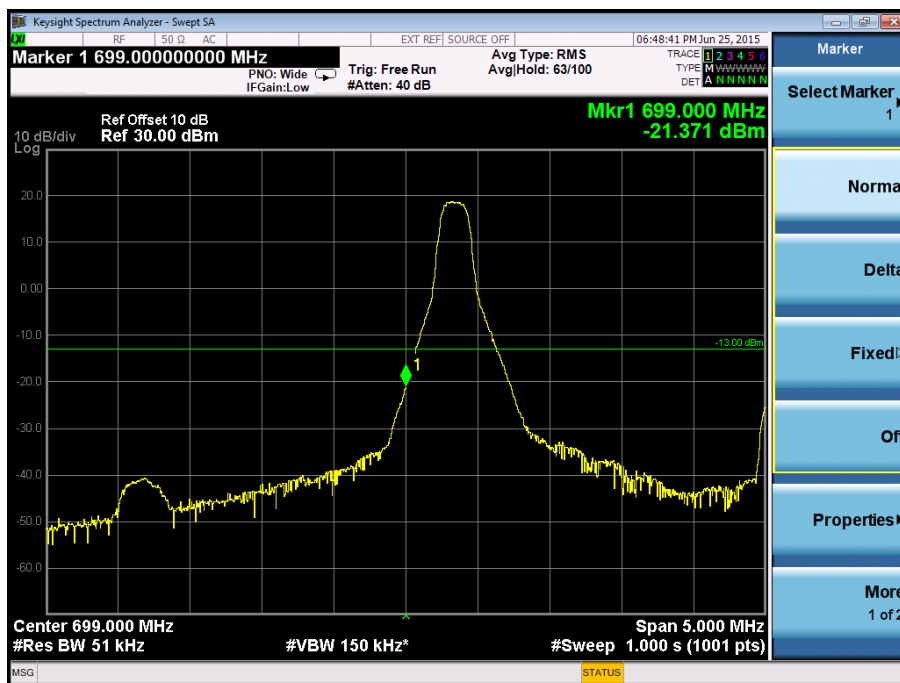

### Band Edge on Configuration QPSK-5M / 1RB Channel Highest-CONDUCTED MODE

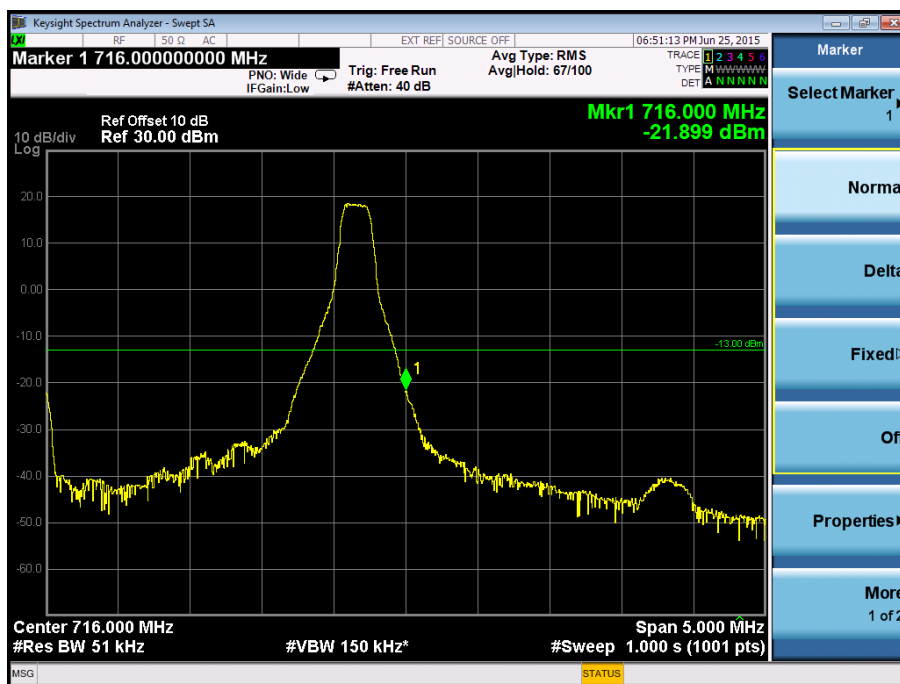

### Band Edge on Configuration QPSK-5M / 25RB Channel Lowest-CONDUCTED MODE

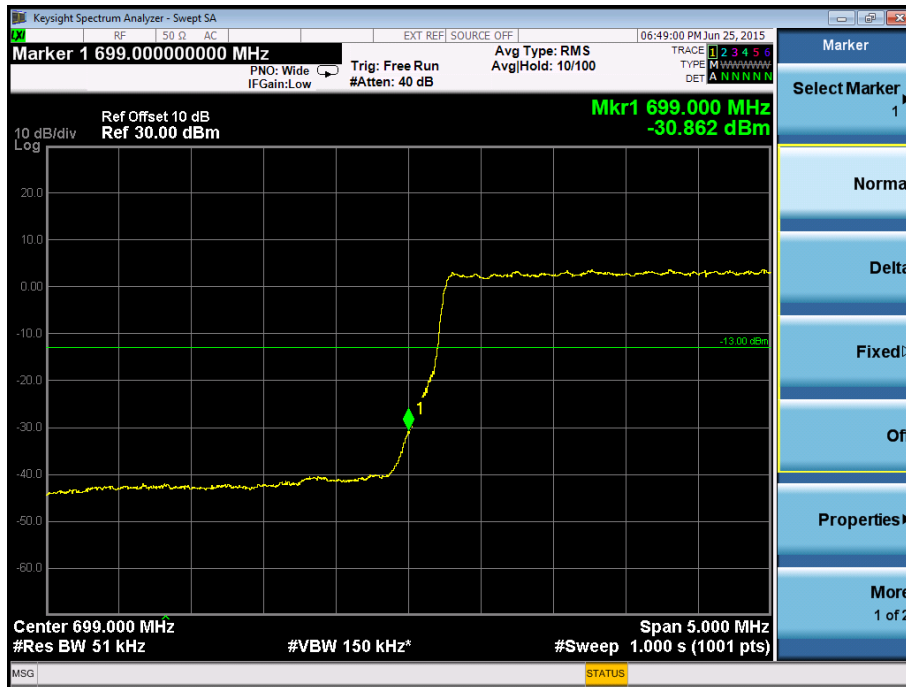

### Band Edge on Configuration QPSK-5M / 25RB Channel Highest-CONDUCTED MODE



### Band Edge on Configuration QPSK-10M / 1RB Channel Lowest-CONDUCTED MODE

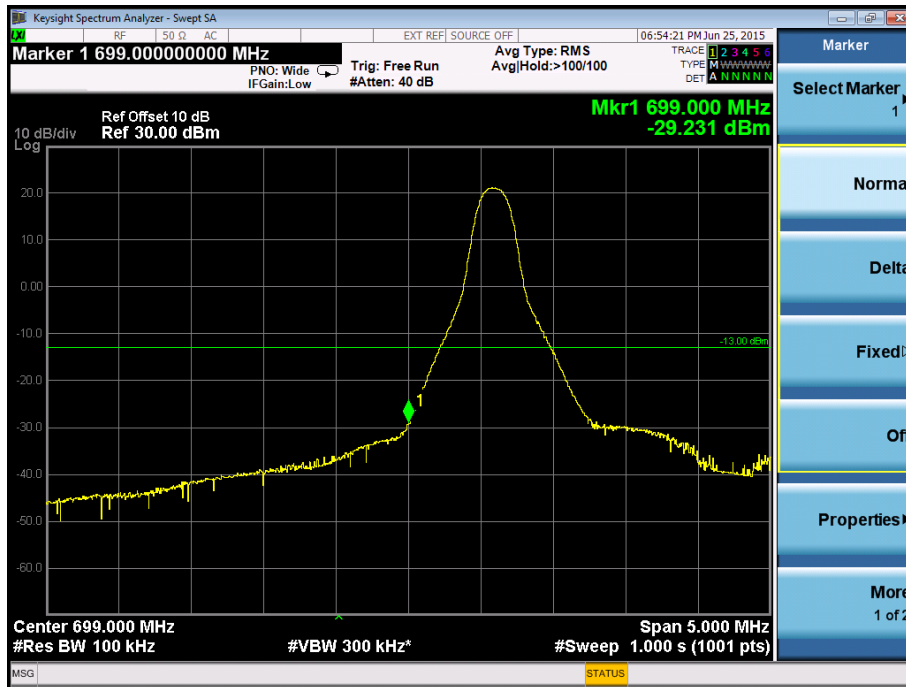

### Band Edge on Configuration QPSK-10M / 1RB Channel Highest-CONDUCTED MODE

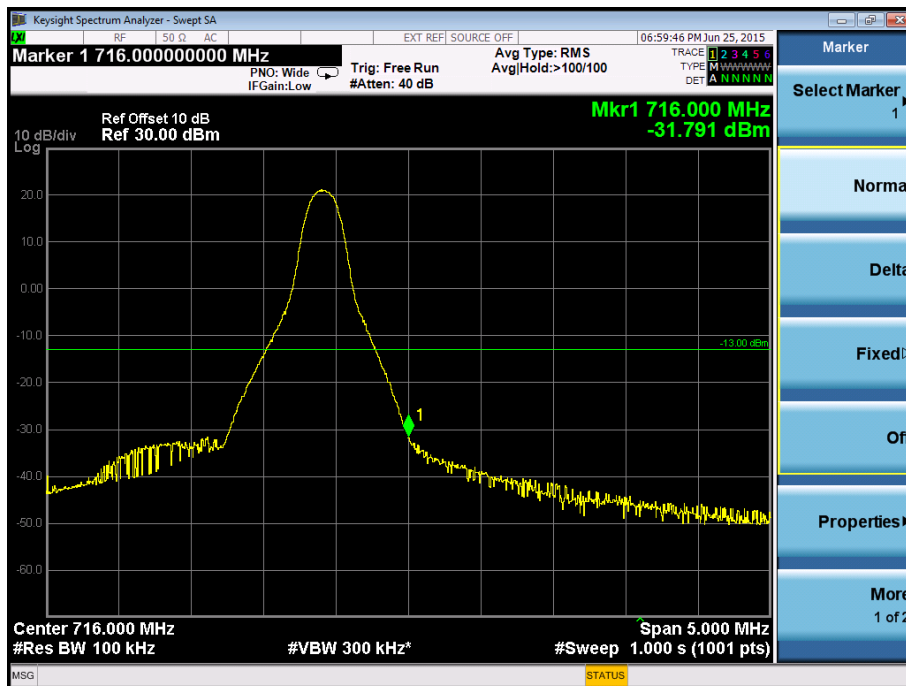



### Band Edge on Configuration QPSK-10M / 50RB Channel Lowest-CONDUCTED MODE



### Band Edge on Configuration QPSK-10M / 50RB Channel Highest-CONDUCTED MODE



## ATTACHMENTF - FREQUENCY STABILITY

Test Mode:	QPSKChannel Middle 1.4M/1RB 0 offset
------------	--------------------------------------

### Voltage vs. Frequency Stability

Temperature(°C)	Frequency Error (Hz)	Frequency Error (ppm)	Limit(ppm)
-10	1.76	0.002487633	2.5
0	-2.28	0.003222615	2.5
10	-1.64	0.002318021	2.5
20	-2.69	0.00380212	2.5
30	1.54	0.002176678	2.5
40	-2.18	0.003081272	2.5
45	-1.45	0.00204947	2.5
Max. Deviation (ppm)	<b>3.11</b>	<b>0.00439576</b>	2.5

### Voltage vs. Frequency Stability

Voltage(Volts)	Frequency Error (Hz)	Frequency Error (ppm)	Limit(ppm)
3.8	1.37	0.001936396	2.5
3.5	-2.84	0.004014134	2.5
4.35	1.66	0.00234629	2.5
Max. Deviation (ppm)	<b>2.84</b>	<b>0.004014134</b>	2.5

Test Mode:	QPSKChannel Middle 3M/1RB 0 offset
------------	------------------------------------

### Voltage vs. Frequency Stability

Temperature(°C)	Frequency Error (Hz)	Frequency Error (ppm)	Limit(ppm)
-10	1.05	0.001484099	2.5
0	-2.33	0.003293286	2.5
10	-2.94	0.004155477	2.5
20	7.24	0.010233216	2.5
30	1.23	0.001738516	2.5
40	1.65	0.002332155	2.5
45	-2.47	0.003491166	2.5
Max. Deviation (ppm)	<b>7.24</b>	<b>0.010233216</b>	2.5

### Voltage vs. Frequency Stability

Voltage(Volts)	Frequency Error (Hz)	Frequency Error (ppm)	Limit(ppm)
3.8	1.42	0.002007067	2.5
3.5	-2.53	0.003575972	2.5
4.35	-3.79	0.00535689	2.5
Max. Deviation (ppm)	<b>3.79</b>	<b>0.00535689</b>	2.5

Test Mode:	QPSKChannel Middle 5M/1RB 0 offset
------------	------------------------------------

### Voltage vs. Frequency Stability

Temperature(°C)	Frequency Error (Hz)	Frequency Error (ppm)	Limit(ppm)
-10	-1.46	0.002063604	2.5
0	1.05	0.001484099	2.5
10	-2.57	0.003632509	2.5
20	1.06	0.001498233	2.5
30	-2.47	0.003491166	2.5
40	-3.19	0.004508834	2.5
45	1.43	0.002021201	2.5
Max. Deviation (ppm)	<b>3.19</b>	<b>0.004508834</b>	2.5

### Voltage vs. Frequency Stability

Voltage(Volts)	Frequency Error (Hz)	Frequency Error (ppm)	Limit(ppm)
3.8	1.54	0.002176678	2.5
3.5	-2.76	0.00390106	2.5
4.35	-3.15	0.004452297	2.5
Max. Deviation (ppm)	<b>3.15</b>	<b>0.004452297</b>	2.5

Test Mode:	QPSKChannel Middle 10M/1RB 0 offset
------------	-------------------------------------

### Voltage vs. Frequency Stability

Temperature(°C)	Frequency Error (Hz)	Frequency Error (ppm)	Limit(ppm)
-10	1.17	0.00165371	2.5
0	-1.54	0.002176678	2.5
10	-2.48	0.0035053	2.5
20	-1.97	0.002784452	2.5
30	-2.57	0.003632509	2.5
40	-1.49	0.002106007	2.5
45	-3.05	0.004310954	2.5
Max. Deviation (ppm)	<b>1.17</b>	<b>0.004310954</b>	2.5

### Voltage vs. Frequency Stability

Voltage(Volts)	Frequency Error (Hz)	Frequency Error (ppm)	Limit(ppm)
3.8	0.95	0.001342756	2.5
3.5	-1.57	0.002219081	2.5
4.35	1.26	0.001780919	2.5
Max. Deviation (ppm)	<b>1.57</b>	<b>0.002219081</b>	2.5

## ATTACHMENTG - PEAK TO AVERAGE RATIO

### Peak to Average Ratio of Configuration-QPSK-1.4M/1RB channel Lowest

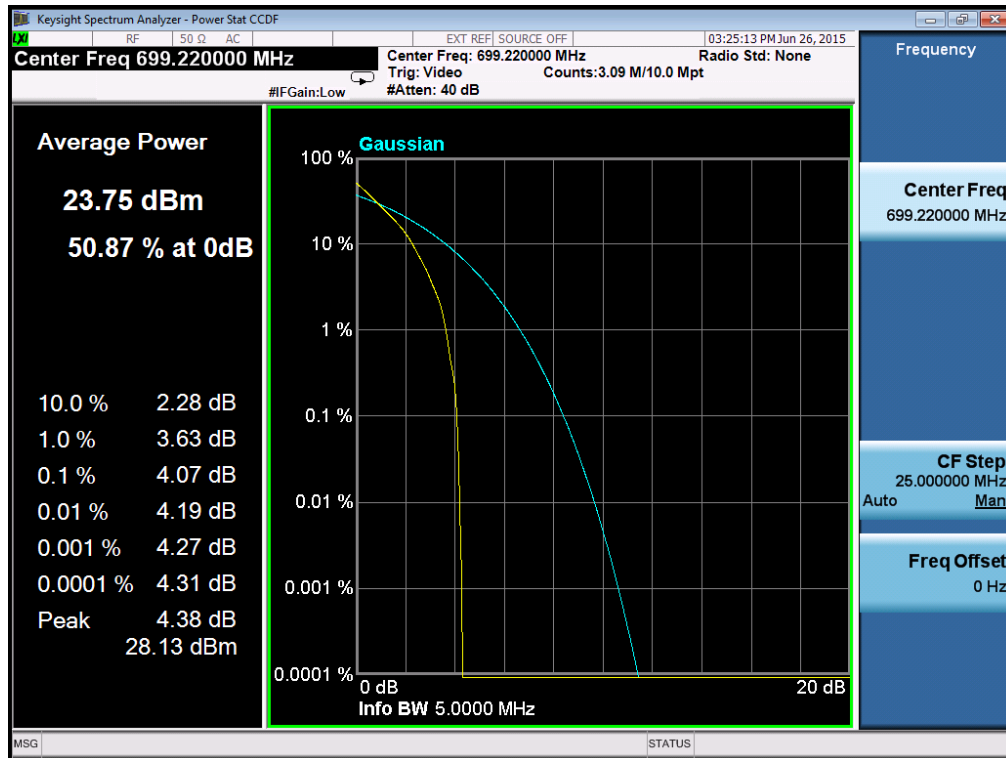

### Peak to Average Ratio of Configuration-QPSK-5M/1RB channel Middle

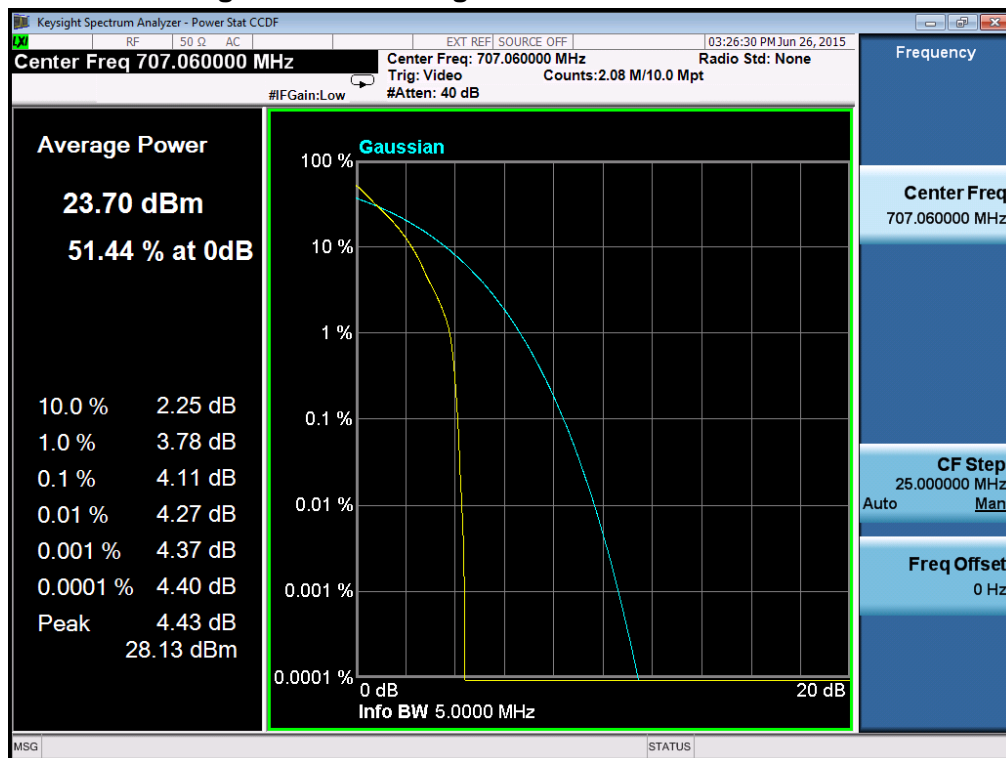



## Peak to Average Ratio of Configuration-QPSK-1.4M/1RB channel Highest

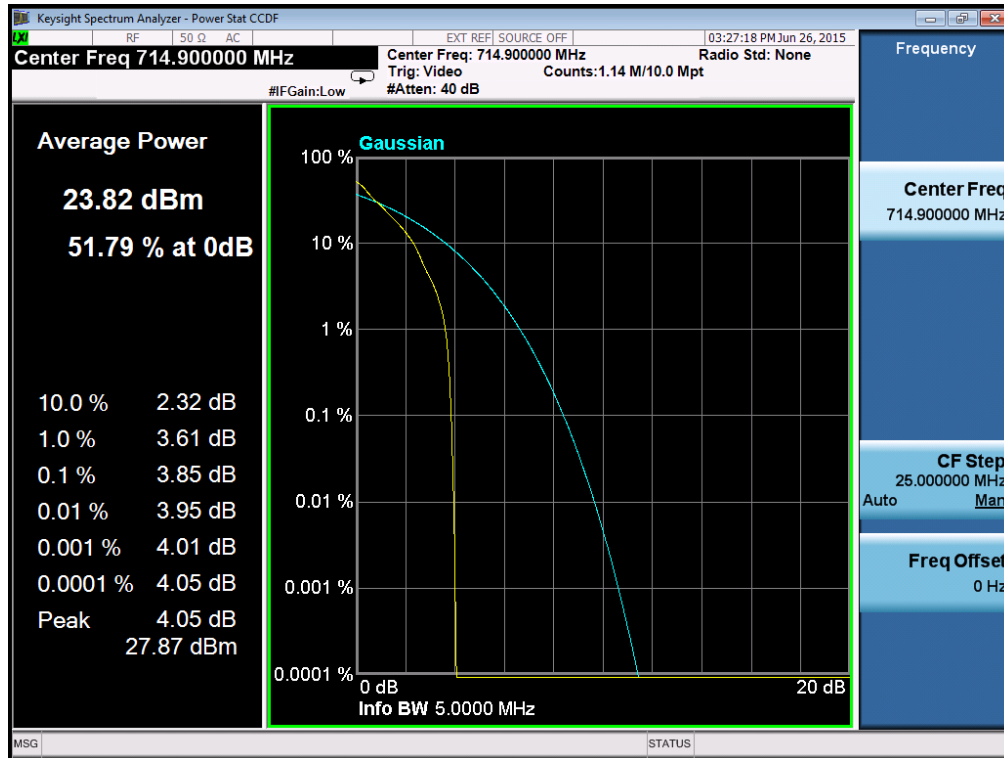

### Peak to Average Ratio of Configuration-QPSK-3M/1RB channel Lowest

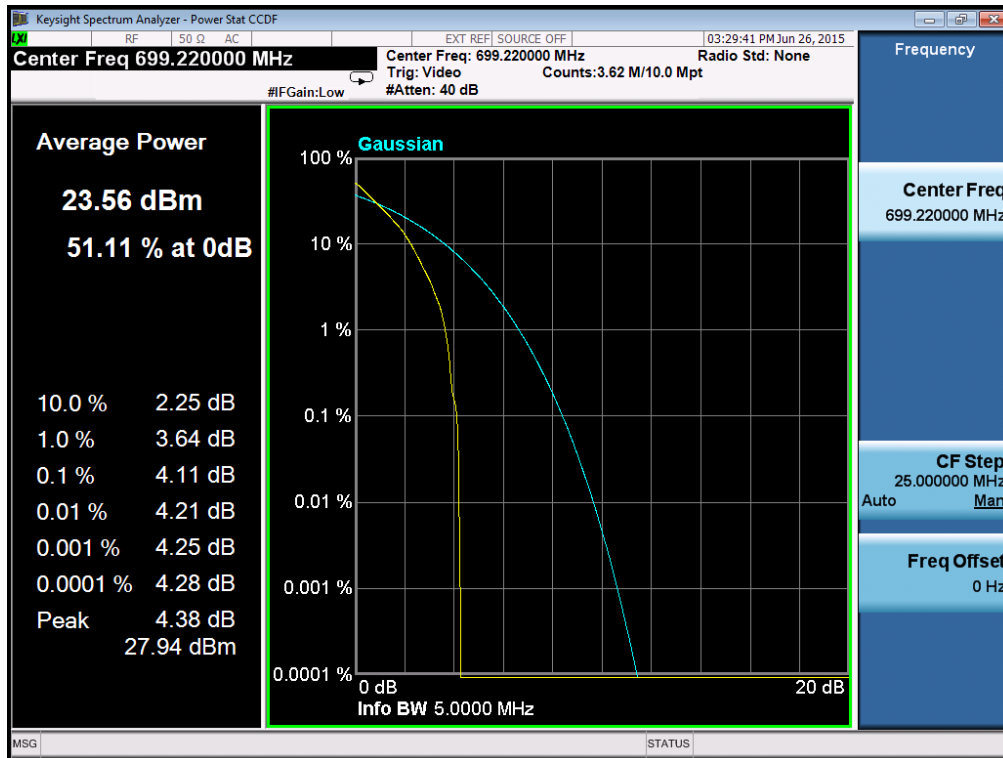

### Peak to Average Ratio of Configuration-QPSK-3M/1RB channel Middle

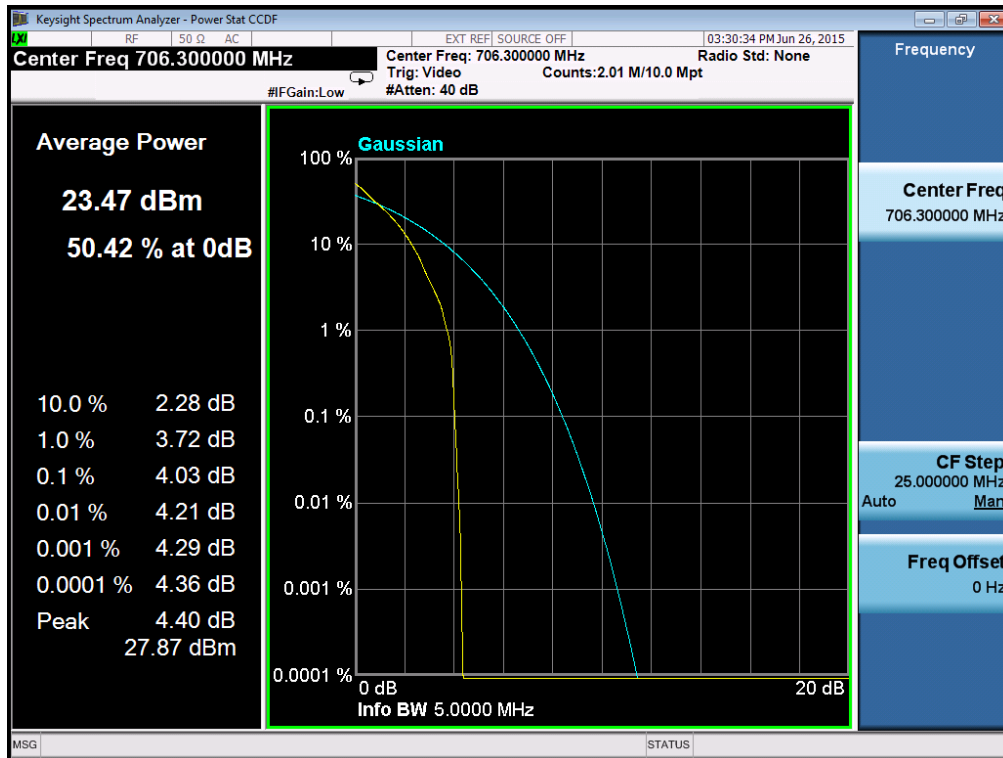

### Peak to Average Ratio of Configuration-QPSK-3M/1RB channel Highest

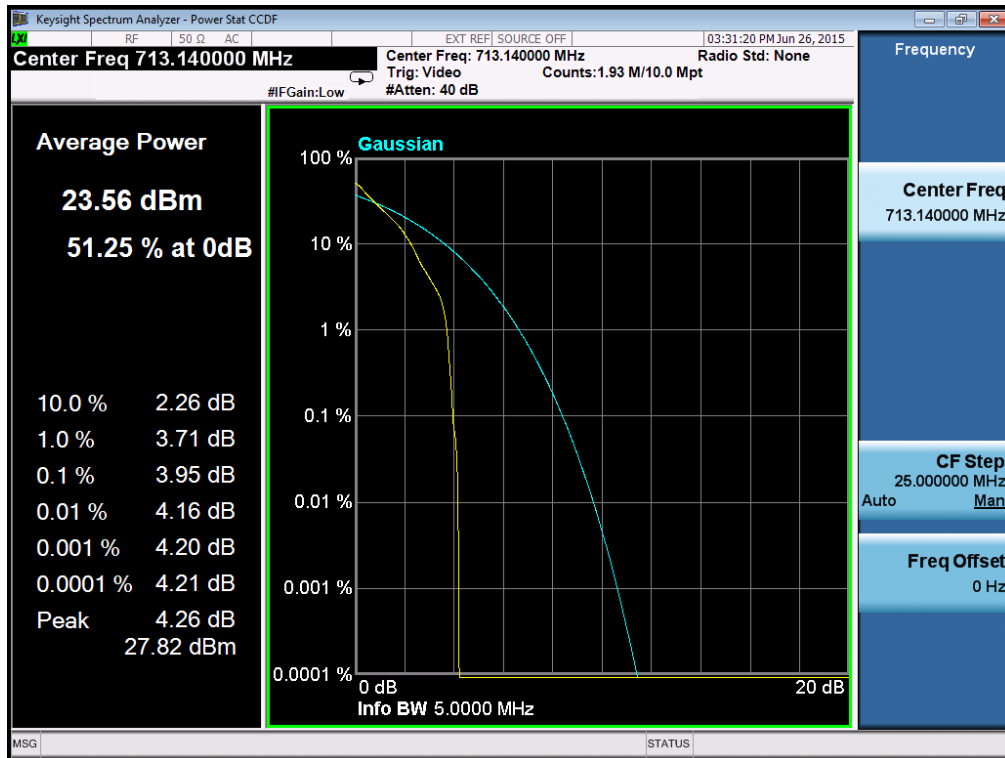

### Peak to Average Ratio of Configuration-QPSK-5M/1RB channel Lowest

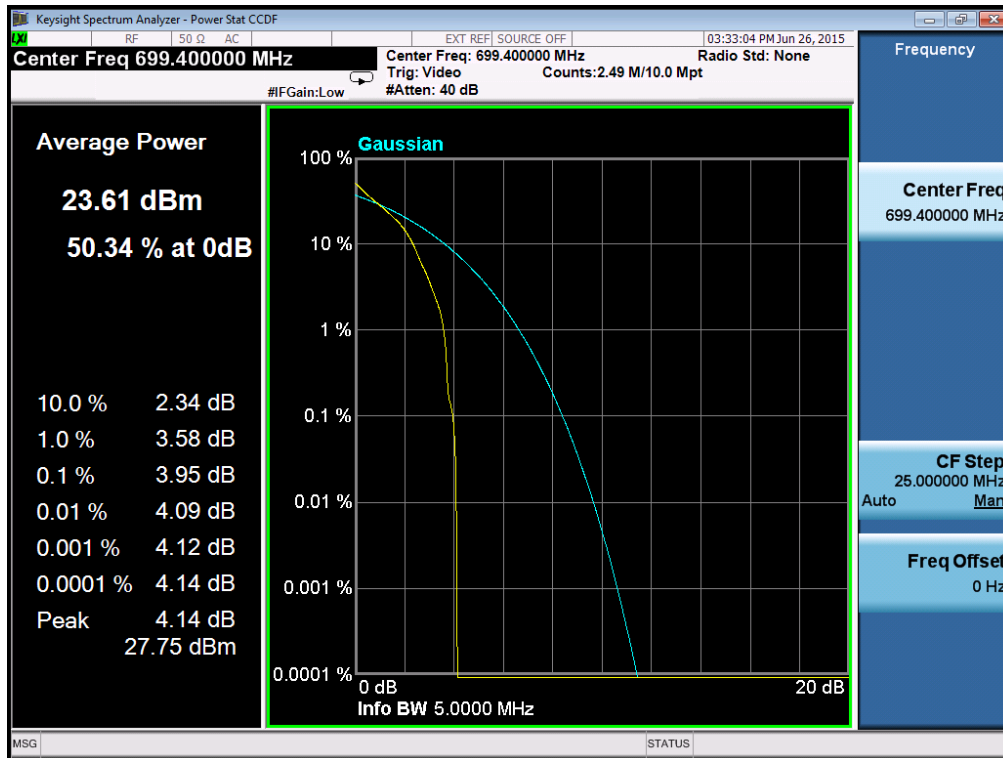

### Peak to Average Ratio of Configuration-QPSK-5M/1RB channel Middle

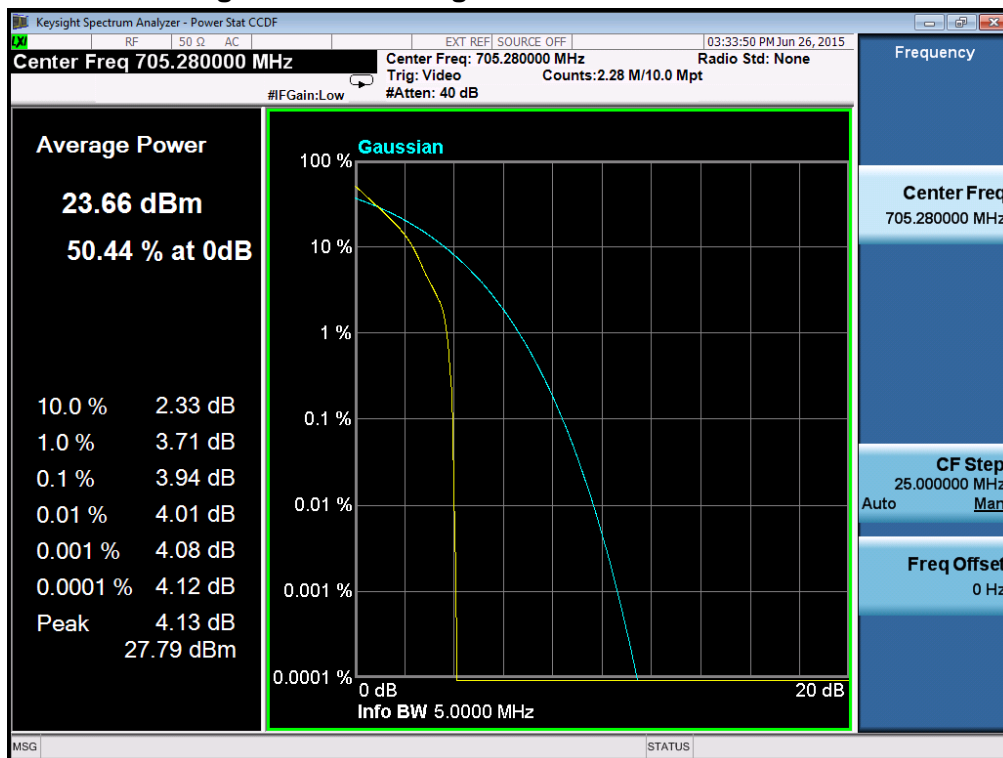

### Peak to Average Ratio of Configuration-QPSK-5M/1RB channel Highest

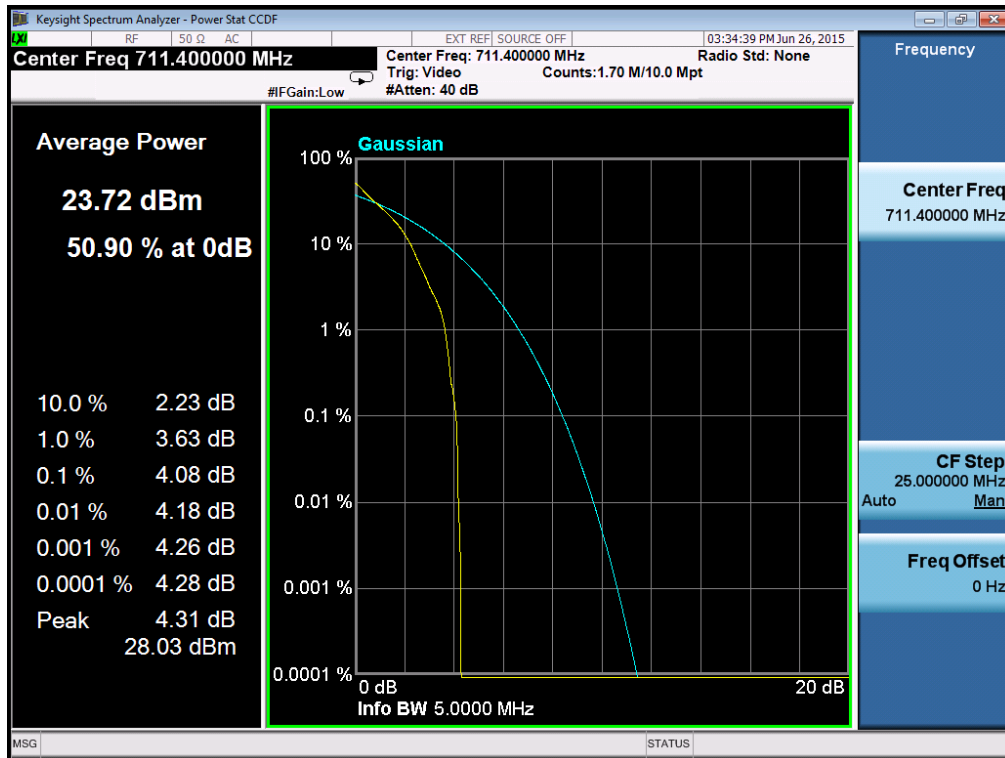

### Peak to Average Ratio of Configuration-QPSK-10M/1RB channel Lowest

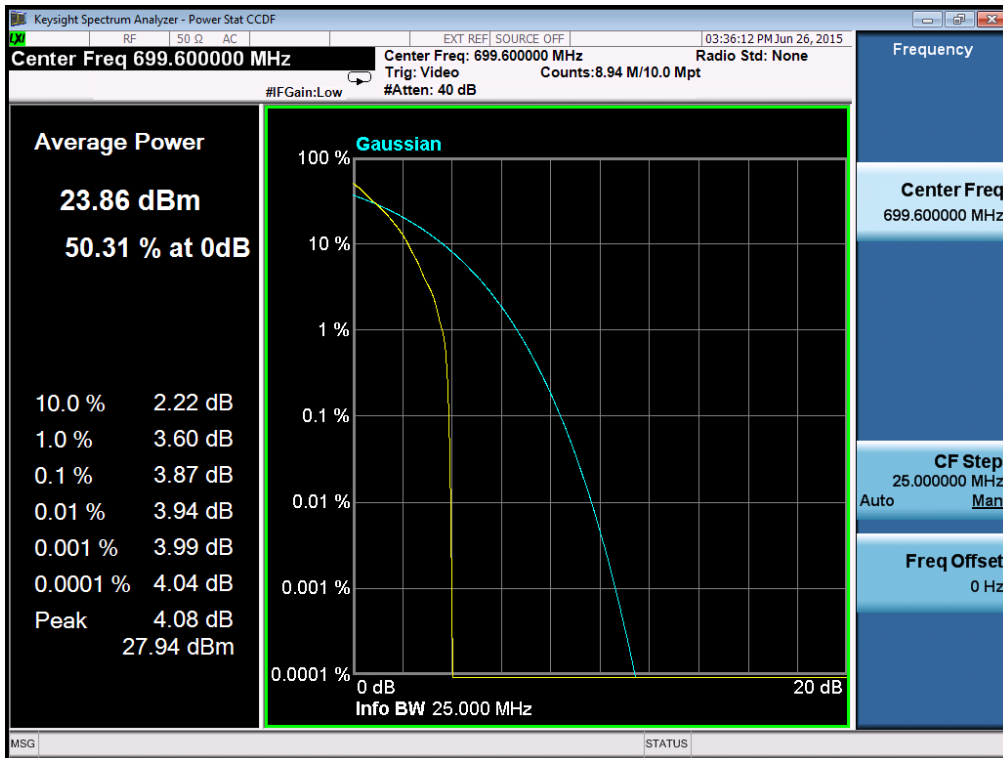

### Peak to Average Ratio of Configuration-QPSK-10M/1RB channel Middle

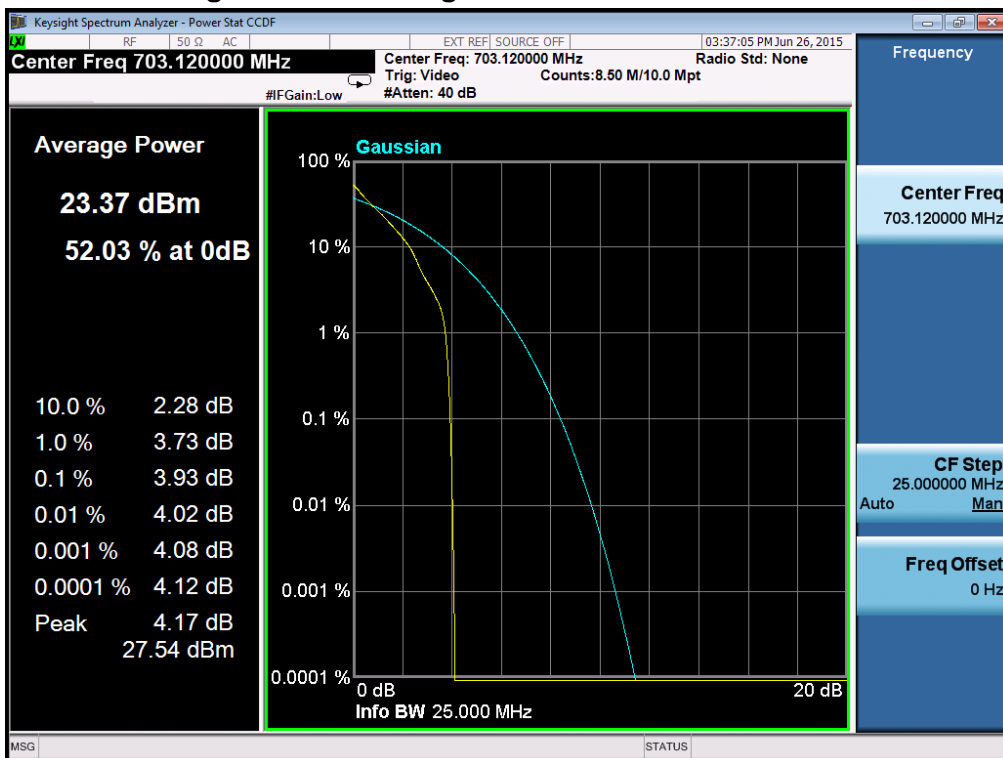

### Peak to Average Ratio of Configuration-QPSK-10M/1RB channel Highest

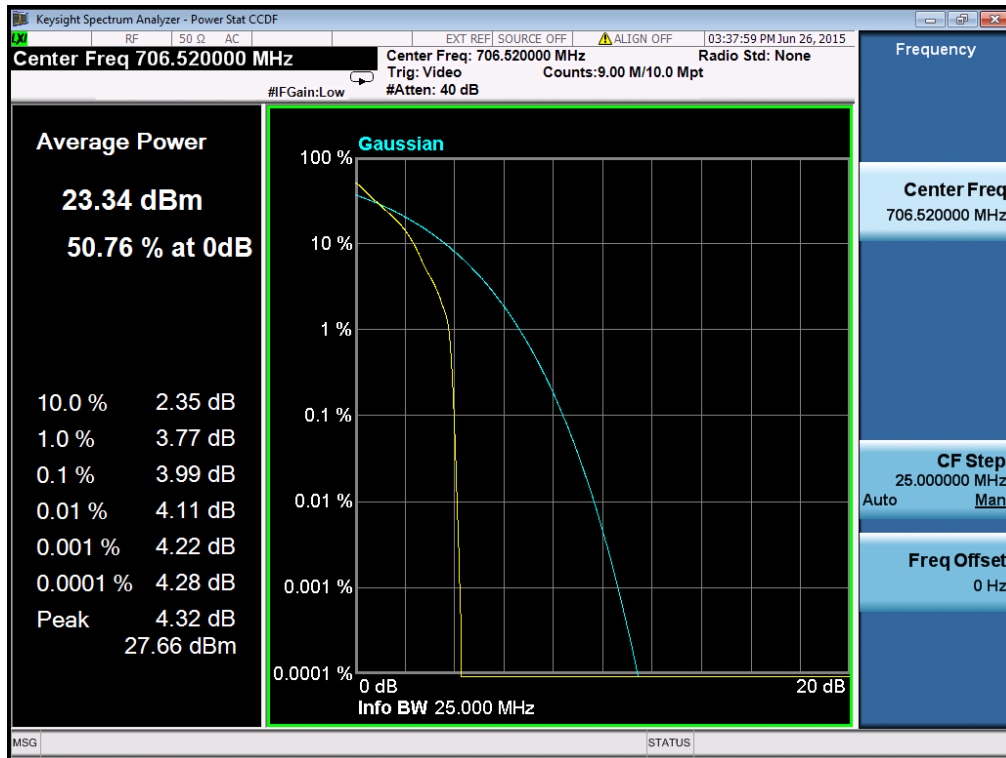

### Peak to Average Ratio of Configuration-16-QAM-1.4M/1RB channel Lowest

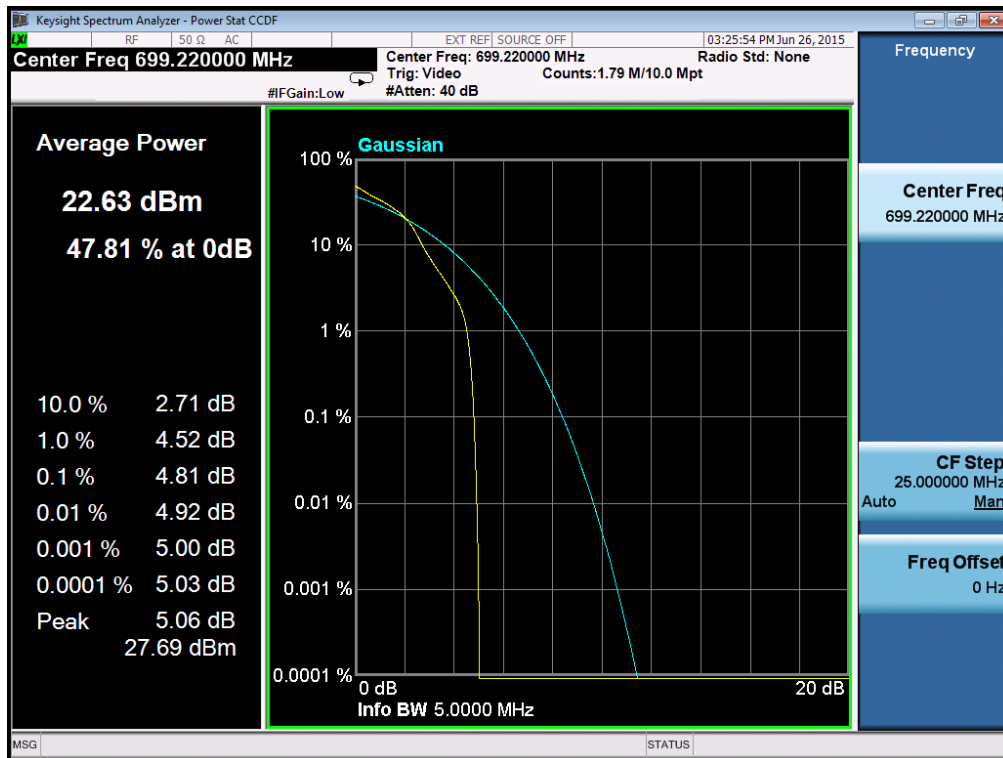

### Peak to Average Ratio of Configuration-16-QAM-1.4M/1RB channel Middle

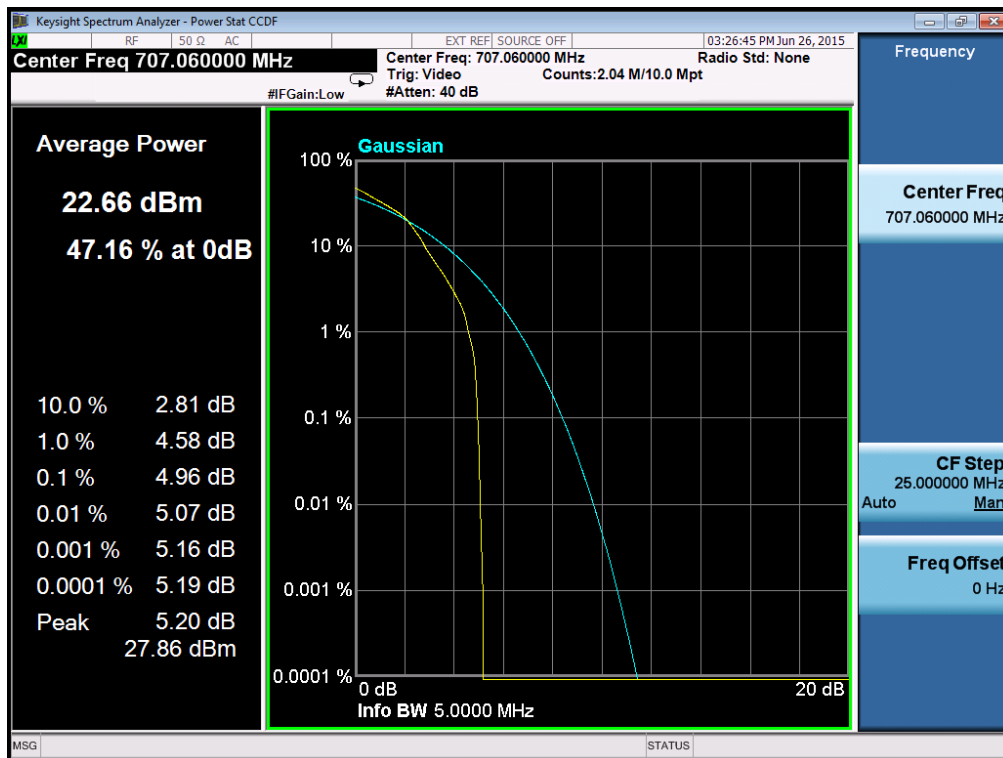



## Peak to Average Ratio of Configuration-16-QAM-1.4M/1RB channel Highest

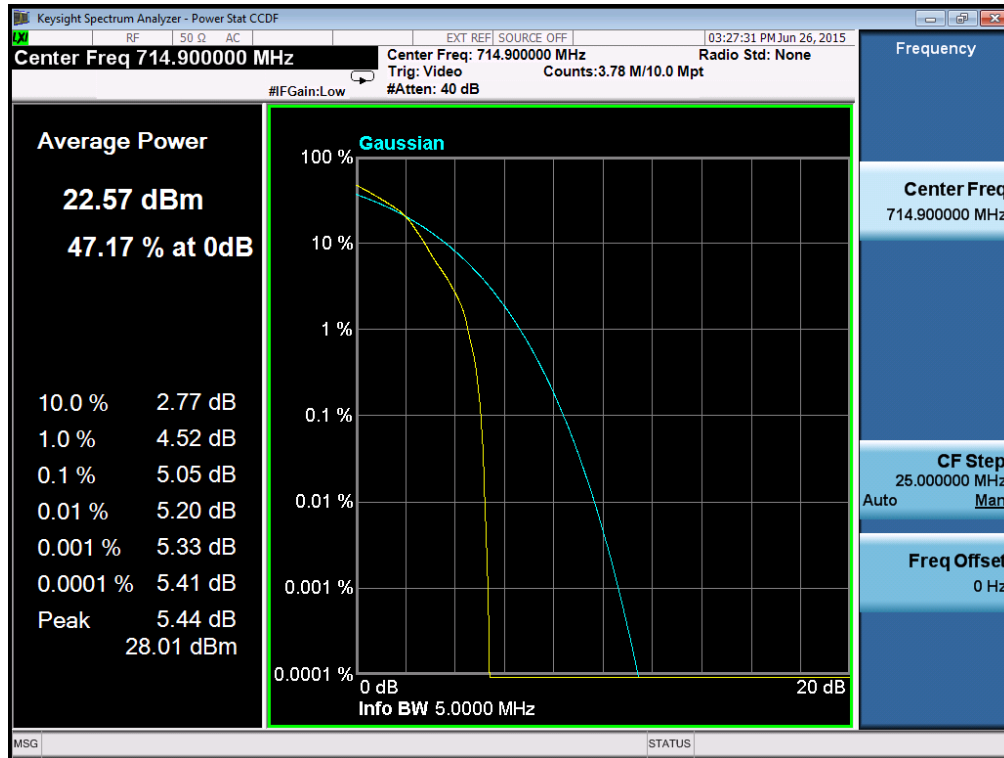

### Peak to Average Ratio of Configuration-16-QAM-3M/1RB channel Lowest

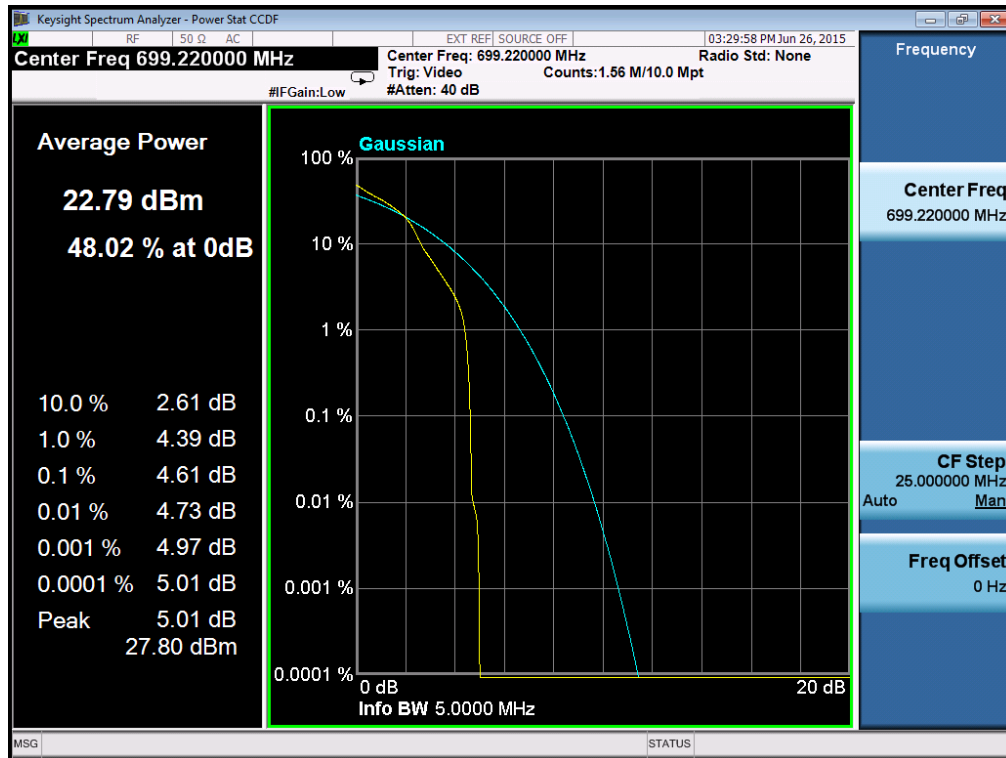

### Peak to Average Ratio of Configuration-16-QAM-3M/1RB channel Middle

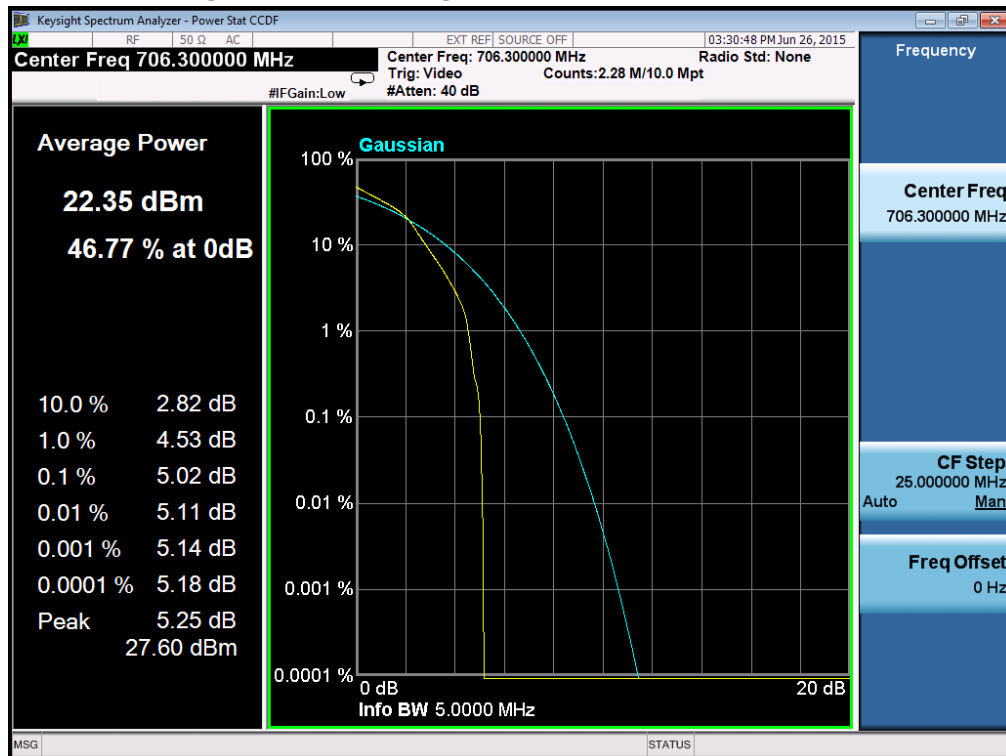

## Peak to Average Ratio of Configuration-16-QAM-3M/1RB channel Highest

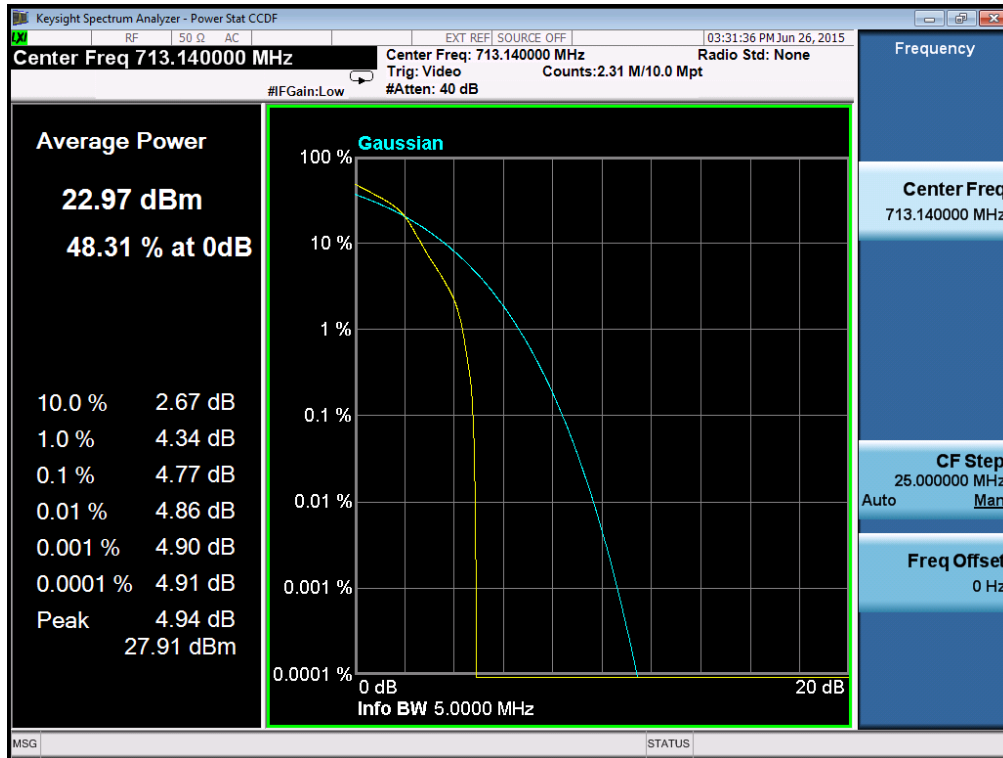

### Peak to Average Ratio of Configuration-16-QAM-5M/1RB channel Lowest

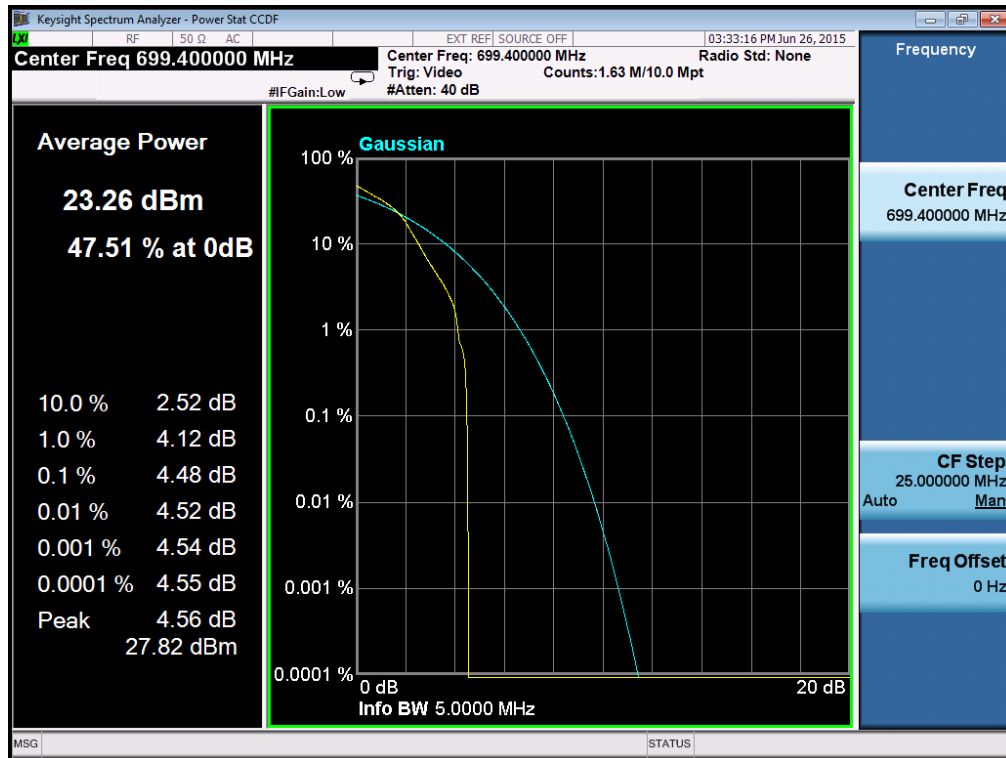

### Peak to Average Ratio of Configuration-16-QAM-5M/1RB channel Middle

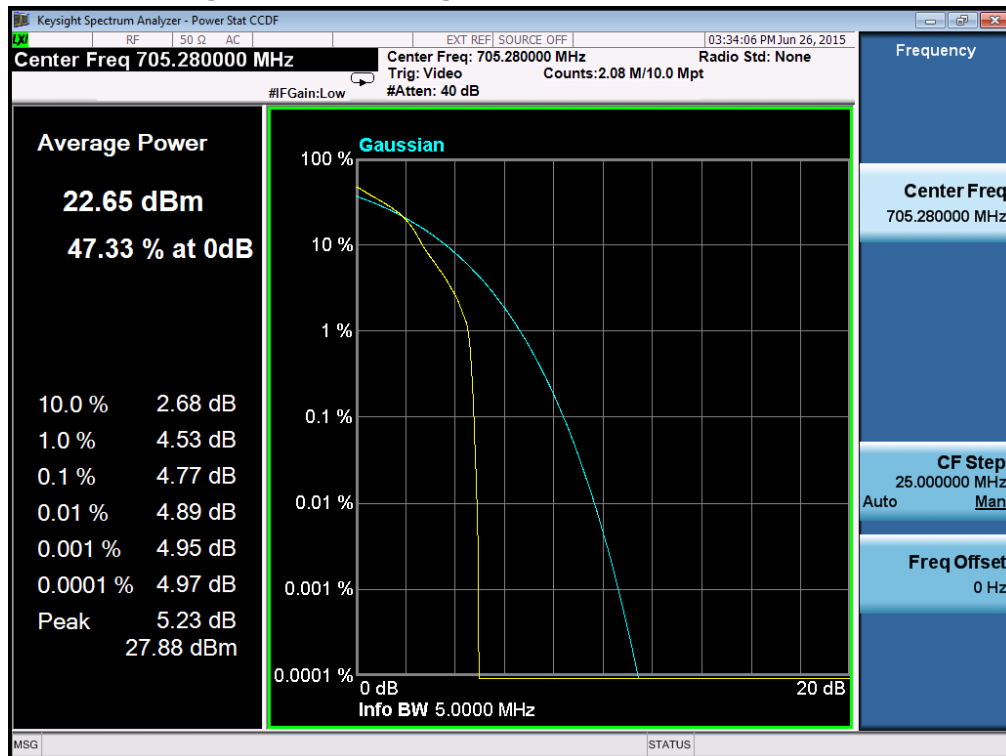

## Peak to Average Ratio of Configuration-16-QAM-5M/1RB channel Highest

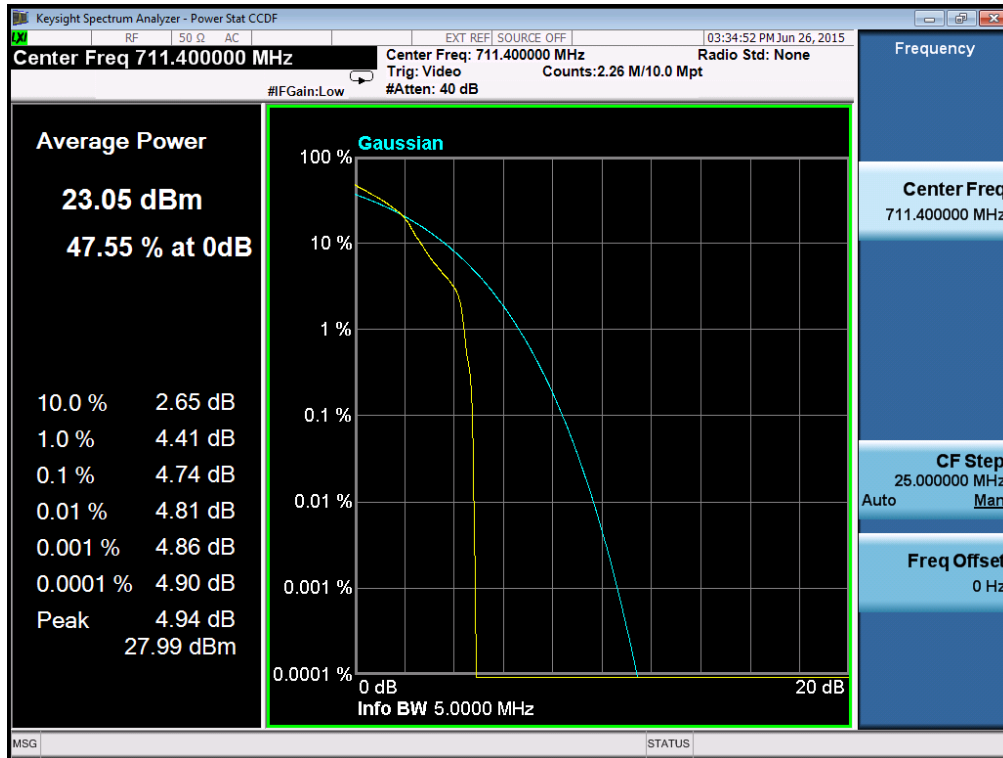

**Peak to Average Ratio of Configuration-16-QAM-10M/1RB channel  
Lowest**

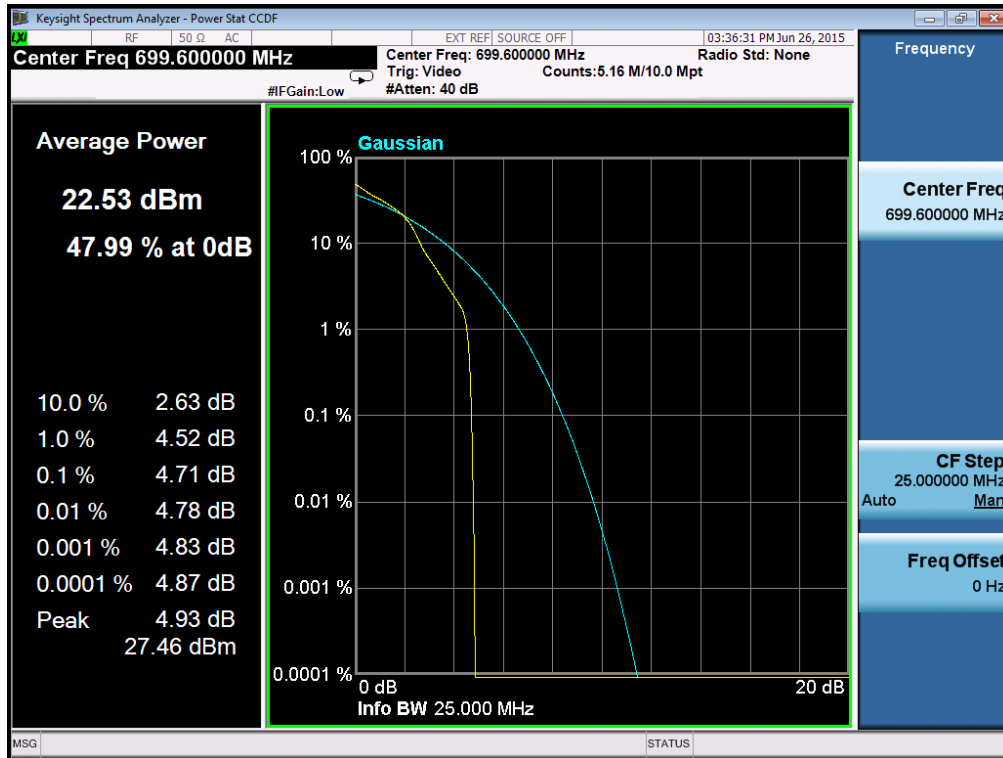

**Peak to Average Ratio of Configuration-16-QAM-10M/1RB channel  
Middle**

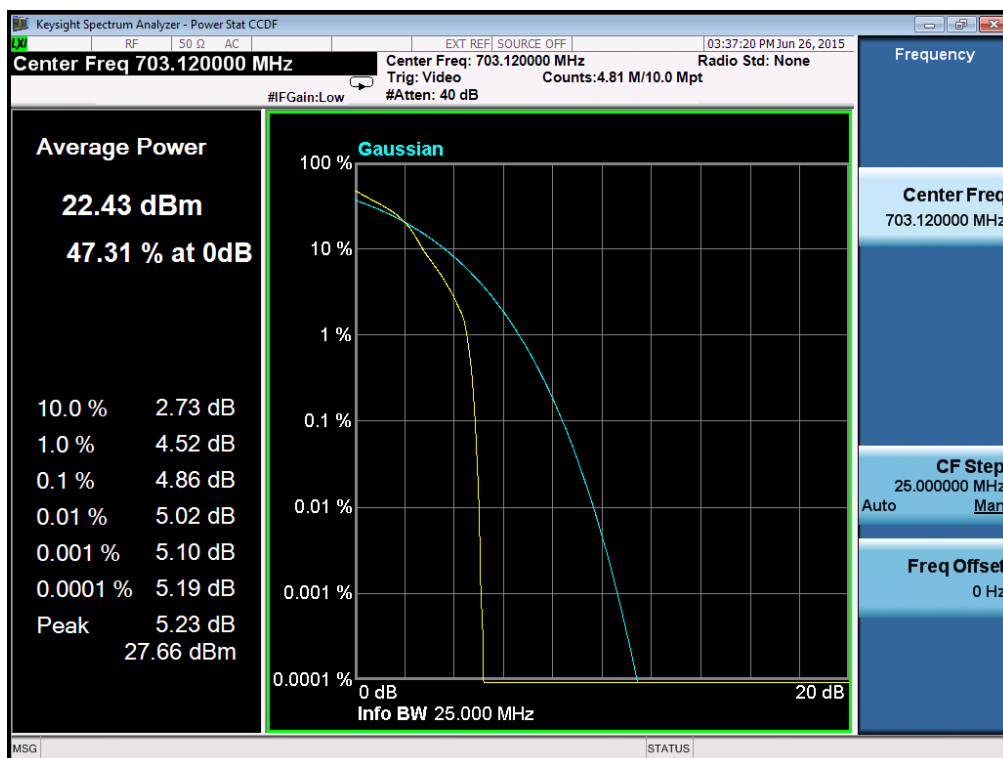

## Peak to Average Ratio of Configuration-16-QAM-10M/1RB channel Highest

