



# Tengxiang Technology.Inc

东莞市腾祥电子有限公司

Product Number: AN2400-02BC14SM-B

Product Name: Antenna

## Specification For Approval

Date: 2024.1.10

Version: 1.0

客户名称

Customer:

神牛

客户料号

Customer P/N:

122-10100-002

腾祥料号

TX P/N:

AN2400-02BC14SM-B

规格描述

Description:

2.4G 黑色天线 RG178 线 SMA Plug (公头公针)

Tengxiang Checked By: 腾祥审核		Customer Approved By: 客户审核	
DRAWN 制作	李艳坪	TESTED BY 检测	
CHECKED BY 审核	胡超	CHECKED BY 审核	
Q.C.DEPT. 品管	袁旭阳	Q.C.DEPT. 品管	
APPROVED BY 核准	韦佳	APPROVEDBY 核准	



NO.53 Shatou ShaChong Road, ChangAn Town, Guangdong province, China

中国广东省东莞市长安镇沙头区沙涌路 53 号

TEL:86-769-81873082 FAX:86-769-82663788

<http://www.tenxiang.cn>



# Tengxiang Technology.Inc

东莞市腾祥电子有限公司

Product Number: AN2400-02BC14SM-B

Product Name: Antenna

## Index:

1. Specification (规格)
2. Characteristics and Reliability Test (产品特性和可靠性测试标准)
3. Antenna - S Parameter Test Data (样品测试数据)
4. Antenna - Radiation Pattern Test Data (辐射模式测试数据)
5. Mechanical and Packing Drawing (图纸包装规范)

## Revision History (变更履历)

Revision	Date	Change Notification	Description
1.0	2024.1.10	初版	

Product Number: AN2400-02BC14SM-B

Product Name: Antenna

## 1. Specification

Sample Photo	
	
A. Electrical Characteristics	
Frequency 频率	2400-2500 MHz
S.W.R. 驻波比	<=2.0
Antenna Gain 增益	2.4dBi
Polarization 极化方式	Linear
Impedance 阻抗	50 ohm Nominal
B. Material & Mechanical Characteristics	
Cable Type 线材规格	RG178
Connector Type 连接器规格	SMA PLUG (公头公针)
C. Environmental	
Storage Temperature 存储温度	- 35 °C ~ + 65 °C
Operation Temperature 工作温度	- 35 °C ~ + 65 °C

Product Number: AN2400-02BC14SM-B

Product Name: Antenna

## 2. Characteristics and Reliability Test

Test Items 测试项目	Test Condition and Procedure 测试方法	Requirements 要求	Result 结果
1 V.S.W.R. 电压驻波比	Set DUT on Network Analyzer; make individual calibration to test 设置网络分析仪参数进行测试	Directive DUT specification 符合待测物规范	PASS
2 Insertion Loss 插入损失	Set DUT on Network Analyzer; make individual calibration to test 设置网络分析仪参数进行测试	Directive DUT specification 符合待测物规范	PASS
3 Antenna Gain 天线增益	Set DUT on Antenna Chamber; make individual calibration to test 设置天线暗室参数进行测试	Directive DUT specification 符合待测物规范	PASS
4 Solderability 可焊性	GB / T2423.28-2005 Temp: 260±5° C;Duration: 5 seconds 温度 260±5° C;持续 5 秒	Tin evenly on full 上锡均匀饱满	PASS
5 Pull Test 拉力	Holding with individual specification; force applied to axis of terminal .单独定义产品端子拉力	1. Directive DUT specification 2. Frequency Tol.≤5% 符合待测物规范;频率偏移≤5%	PASS
6 Dimension 尺寸	Inspection of dimension, color, material, package, surface process.检查尺寸,颜色,材料,包装,表面处理	Directive DUT specification 符合待测物规范	PASS
7 Salt Spray 盐雾	GB / T 2423.17-2008 Temp: 35°C; RH: ≥ 95%; NaCl solution: ≥ 5%;Time: 24H 温度 35°C; 湿度≥95%;盐水浓度≥5%; 测试 24H	1. No Visual Damage 2. Frequency Tol.≤5% 无明显外观不良;频率偏移≤5%	PASS
8 RoHS	With Reference to IEC 62321:2008 with flow chart 参考 IEC 62321 测试流程	Directive RoHS 2015/863/EU 符合 RoHS 2015/863/EU 标准	PASS

Product Number: AN2400-02BC14SM-B

Product Name: Antenna

### 3. Antenna - S Parameter Test Data

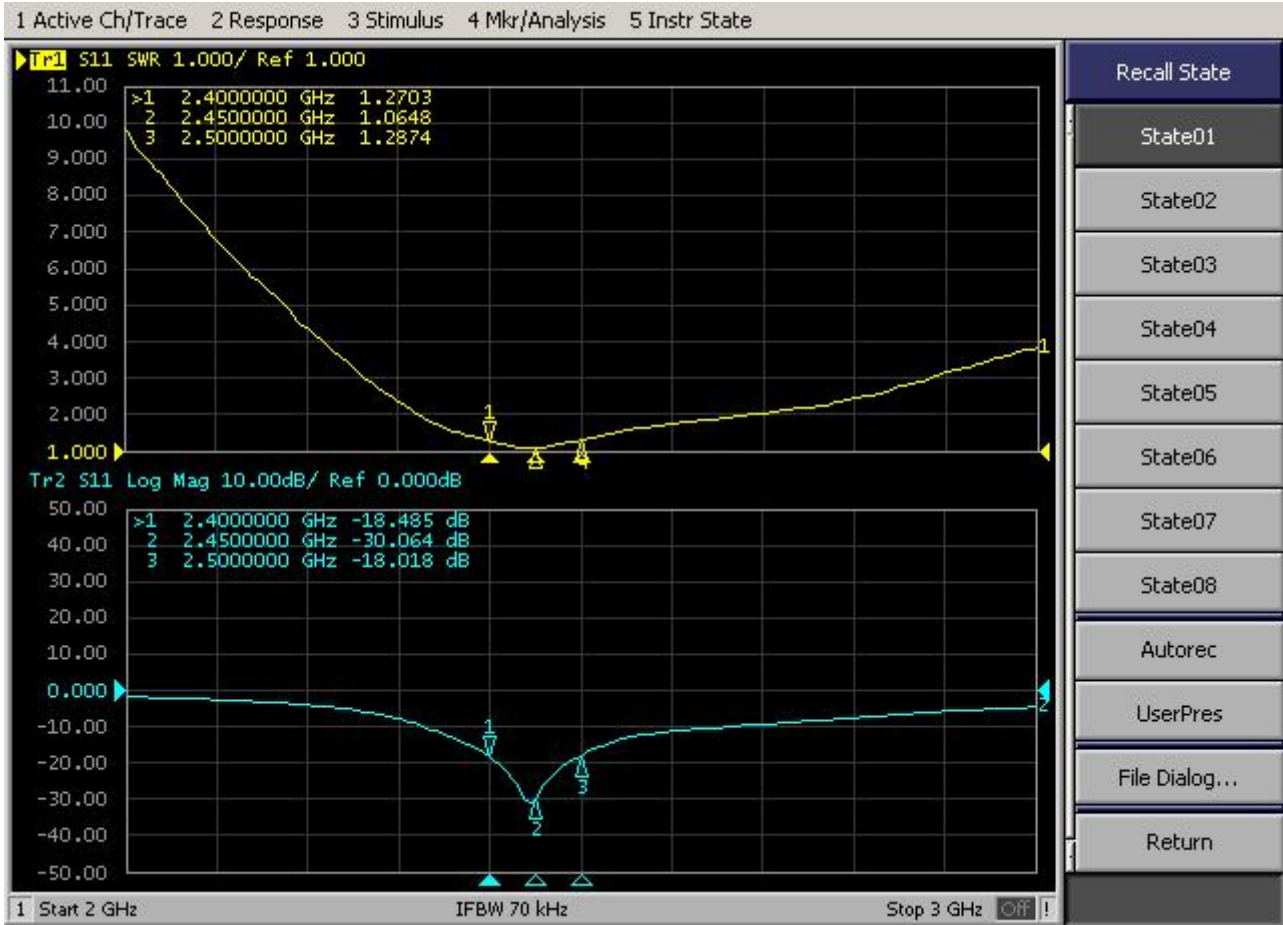

### 4. Antenna - Radiation Pattern Test Data

Frequency (MHz)	2400.0	2450.0	2500.0
Efficiency (%)	77.80	81.10	83.90
Gain (dBi)	2.20	2.40	2.61

Product Number: AN2400-02BC14SM-B

Product Name: Antenna

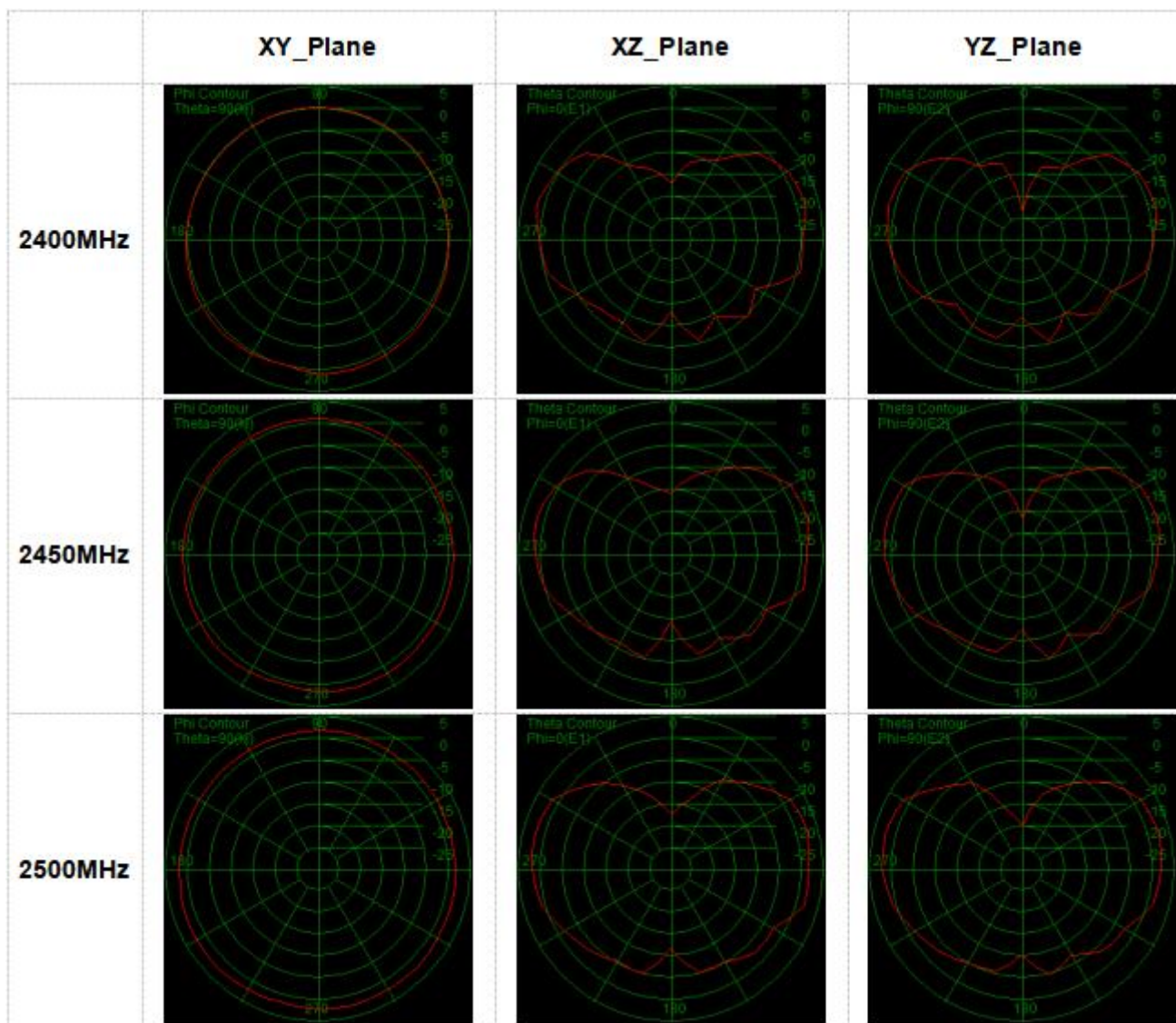
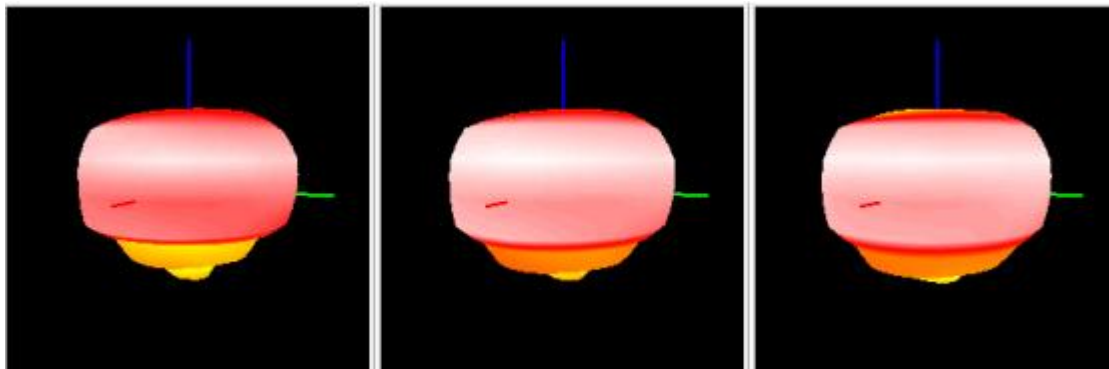

5. Mechanical Drawing See attached files

Product Number: AN2400-02BC14SM-B

Product Name: Antenna

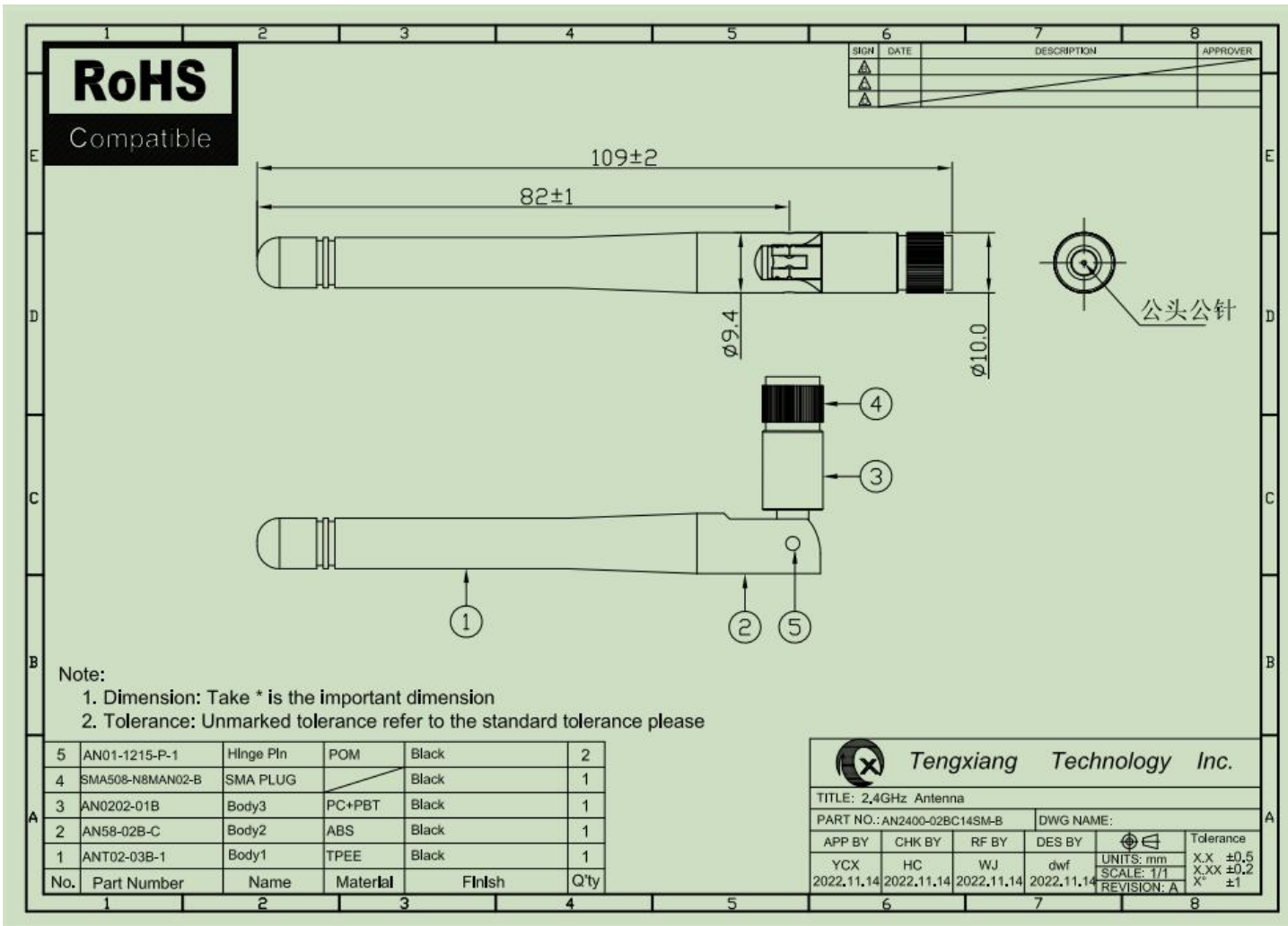

Product Number: AN2400-02BC14SM-B

Product Name: Antenna

## 產品包裝規範

### PACKING CRITERION

Date: 2022.11.14

Page: 1 of 1

Part Number : AN2400-02BC14SM-B	Revision : A
Name: Antenna	Customer : ALL

1 . Enter PE bag .

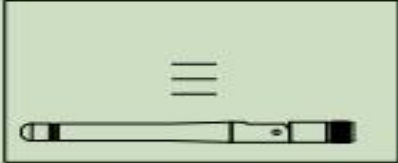

20pcs/ PE bag

2.PACKING -

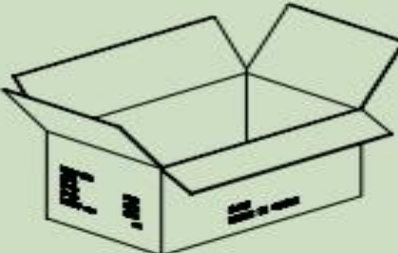

1000pcs/Carton

3. SEALING .

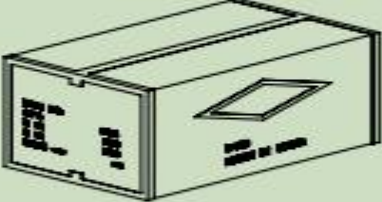

SIDE



FRONT



APPROVED BY : YCX

CHECKED BY : HC

DESIGNED BY : dwf