



Tengxiang Technology.Inc

东莞市腾祥电子有限公司

Product Number: AN2450-FPC76BX

Product Name: Antenna

Specification For Approval

Date: 2023.3.11

Version: 1.0

客户名称

Customer: _____

客户料号

Customer P/N: _____

腾祥料号

TX P/N:

AN2450-FPC76BX

规格描述

Description :

2.4G /5G FPC 天线 1.13mm 黑色线 L=80mm +IPEX

Tengxiang Checked By: 腾祥审核		Customer Approved By: 客户审核	
DRAWN 制作	路婷	TESTED BY 检测	
CHECKED BY 审核	胡超	CHECKED BY 审核	
Q.C.DEPT. 品管	梁凤珍	Q.C.DEPT. 品管	
APPROVED BY 核准	韦佳	APPROVEDBY 核准	



NO.53 Shatou ShaChong Road, ChangAn Town, Guangdong province, China

中国广东省东莞市长安镇沙头区沙涌路 53 号

TEL:86-769-81873082 FAX:86-769-82663788



Tengxiang Technology.Inc

东莞市腾祥电子有限公司

Product Number: AN2450-FPC76BX

Product Name: Antenna

Index:

1. Specification (规格)
2. Characteristics and Reliability Test (产品特性和可靠性测试标准)
3. Antenna - S Parameter Test Data (样品测试数据)
4. Antenna - Radiation Pattern Test Data (辐射模式测试数据)
5. Mechanical and Packing Drawing (图纸包装规范)

Revision History (变更履历)

Revision	Date	Change Notification	Description
1.0	2023.3.11	初版	

Product Number: AN2450-FPC76BX

Product Name: Antenna

1. Specification

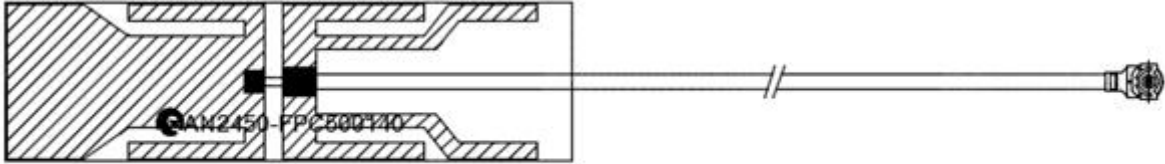
Sample Photo	
	
A. Electrical Characteristics	
Frequency 频率	2400-2500 MHz/5150-5850MHz
S.W.R. 驻波比	<= 2.0
Antenna Gain 增益	2.65 dBi /2.0dBi
Polarization 极化方式	Linear
Impedance 阻抗	50 Ohm
B. Material & Mechanical Characteristics	
Cable Type 线材规格	OD1.13mm ,Black
Connector Type 连接器规格	I-PEX
C. Environmental	
Storage Temperature 存储温度	- 40°C ~ +80 °C
Operation Temperature 工作温度	- 40°C ~ +80 °C

2. Characteristics and Reliability Test

Product Number: AN2450-FPC76BX

Product Name: Antenna

Test Items 测试项目	Test Condition and Procedure 测试方法	Requirements 要求	Result 结果
1 V.S.W.R. 电压驻波比	Set DUT on Network Analyzer; make individual calibration to test 设置网络分析仪参数进行测试	Directive DUT specification 符合待测物规范	PASS
2 Insertion Loss 插入损失	Set DUT on Network Analyzer; make individual calibration to test 设置网络分析仪参数进行测试	Directive DUT specification 符合待测物规范	PASS
3 Antenna Gain 天线增益	Set DUT on Antenna Chamber; make individual calibration to test 设置天线暗室参数进行测试	Directive DUT specification 符合待测物规范	PASS
4 Solderability 可焊性	GB / T2423.28-2005 Temp: 260±5° C;Duration: 5 seconds 温度 260±5° C;持续 5 秒	Tin evenly on full 上锡均匀饱满	PASS
5 Pull Test 拉力	Holding with individual specification; force applied to axis of terminal .单独定义产品端子拉力	1. Directive DUT specification 2. Frequency Tol.≤5% 符合待测物规范;频率偏移≤5%	PASS
6 Dimension 尺寸	Inspection of dimension, color, material, package, surface process.检查尺寸,颜色,材料,包装,表面处理	Directive DUT specification 符合待测物规范	PASS
7 Salt Spray 盐雾	GB / T 2423.17-2008 Temp: 35°C; RH: ≥ 95%; NaCl solution: ≥ 5%;Time: 24H 温度 35°C; 湿度≥95%;盐水浓度≥5%; 测试 24H	1. No Visual Damage 2. Frequency Tol.≤5% 无明显外观不良;频率偏移≤5%	PASS
8 RoHS	With Reference to IEC 62321:2008 with flow chart 参考 IEC 62321 测试流程	Directive RoHS 2015/863/EU 符合 RoHS 2015/863/EU 标准	PASS

3. Antenna - S Parameter Test Data

Product Number: AN2450-FPC76BX

Product Name: Antenna

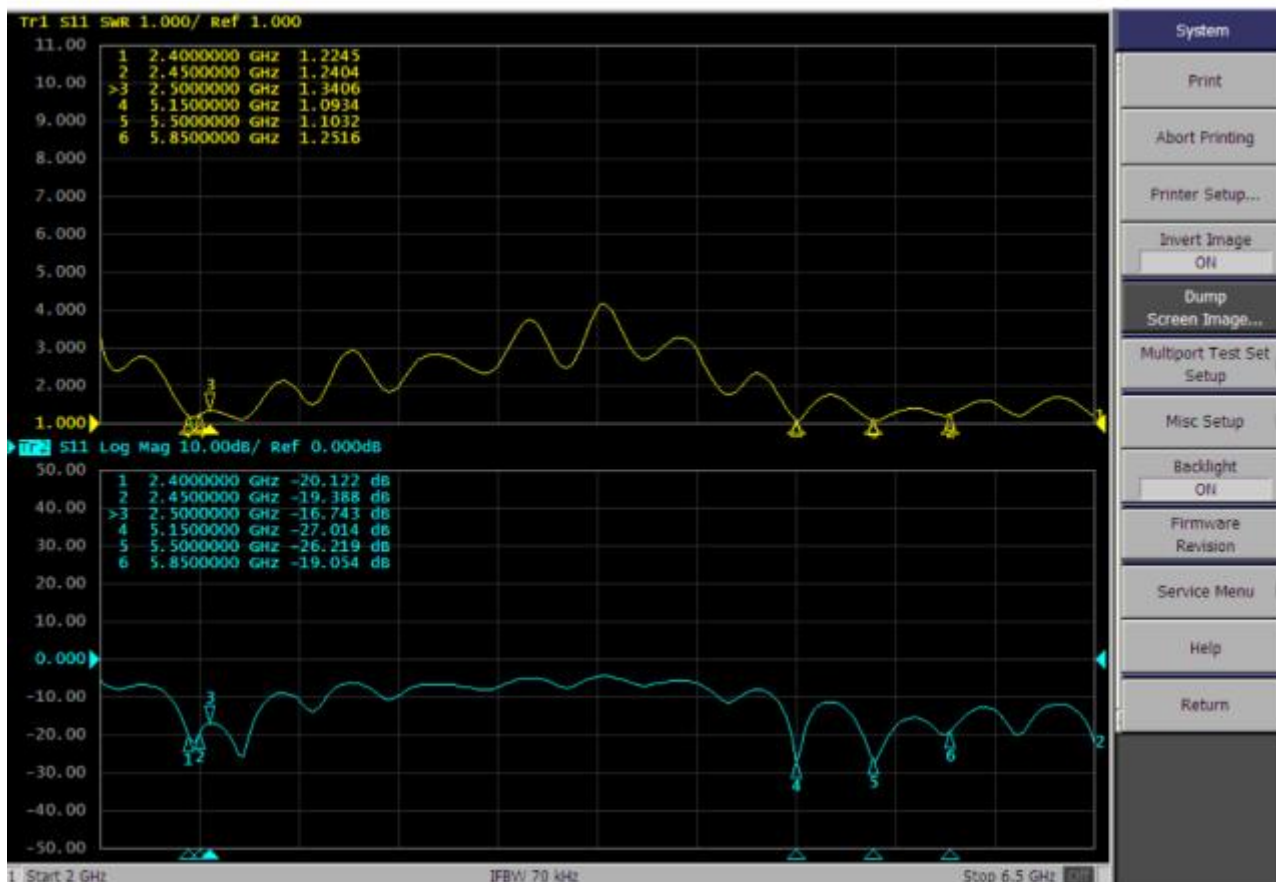

4. Antenna - Radiation Pattern Test Data

Frequency ID	1	2	3	4	5	6	7	8	9	10	11	12	13
Frequency (MHz)	2400.0	2410.0	2420.0	2430.0	2440.0	2450.0	2460.0	2470.0	2480.0	2490.0	2500.0	5150.0	5200.0
Gain (dBi)	2.00	2.00	2.51	2.65	2.55	2.16	1.78	1.64	1.63	1.71	1.89	1.12	1.25
Efficiency (%)	59.14	60.27	62.18	62.65	63.92	61.35	58.09	55.10	53.28	53.15	52.73	52.88	55.43

Frequency ID	14	15	16	17	18	19	20	21	22	23	24	25	26
Frequency (MHz)	5250.0	5300.0	5350.0	5400.0	5450.0	5500.0	5550.0	5600.0	5650.0	5700.0	5750.0	5800.0	5850.0
Gain (dBi)	1.25	0.98	1.61	1.57	1.85	1.73	1.57	1.89	1.86	1.48	1.82	1.97	1.45
Efficiency (%)	56.26	51.50	54.81	57.91	58.20	52.75	56.13	55.25	57.76	50.68	54.85	56.10	52.41

Product Number: AN2450-FPC76BX

Product Name: Antenna

2400MHz

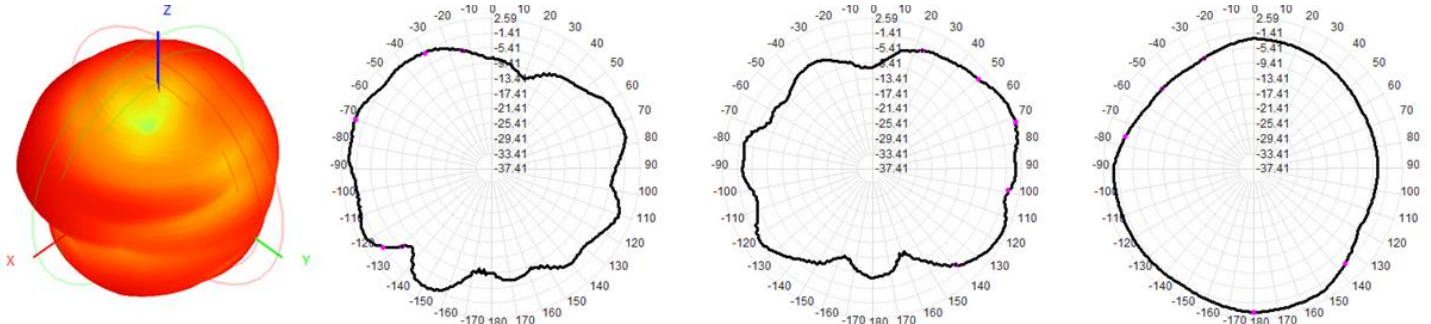

2450MHz

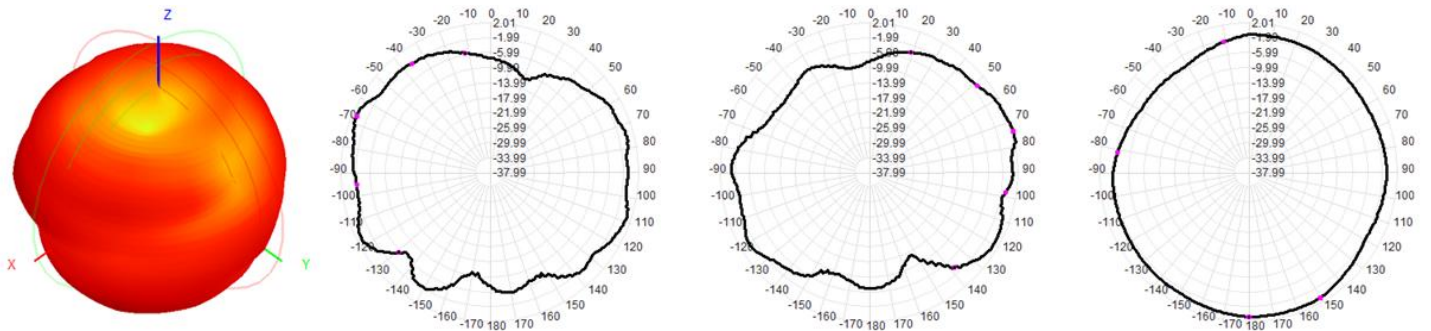

2500MHz

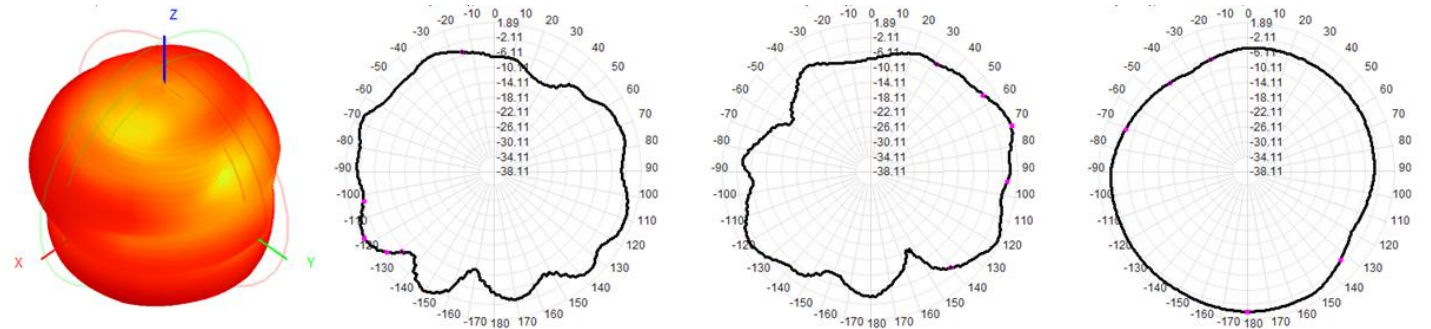

5150MHz

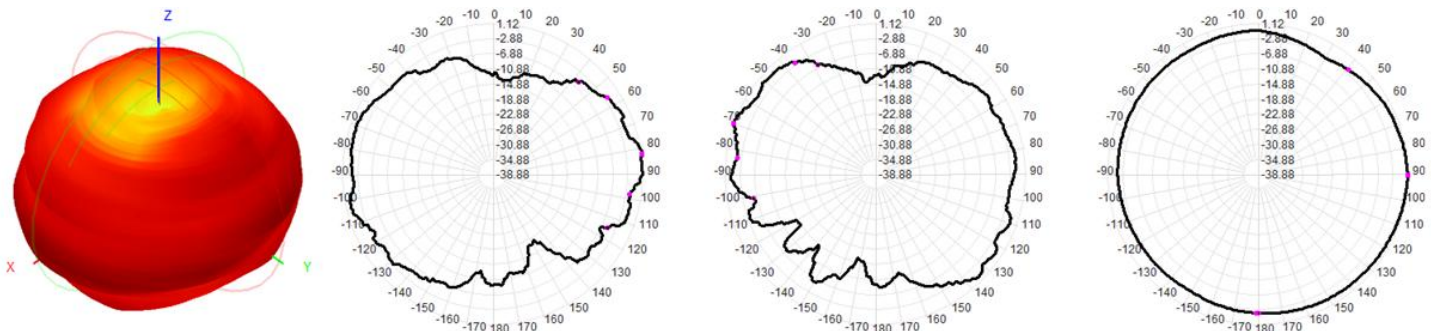

Product Number: AN2450-FPC76BX

Product Name: Antenna

5550MHz

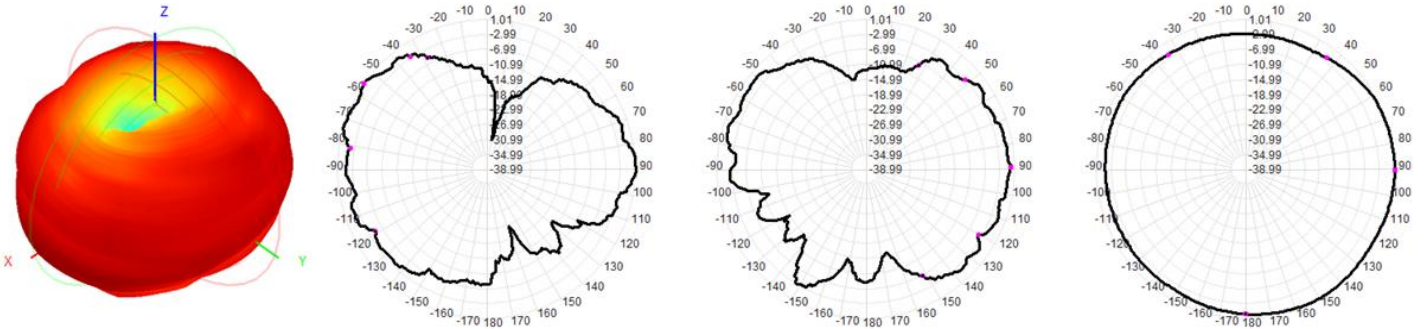

5850MHz

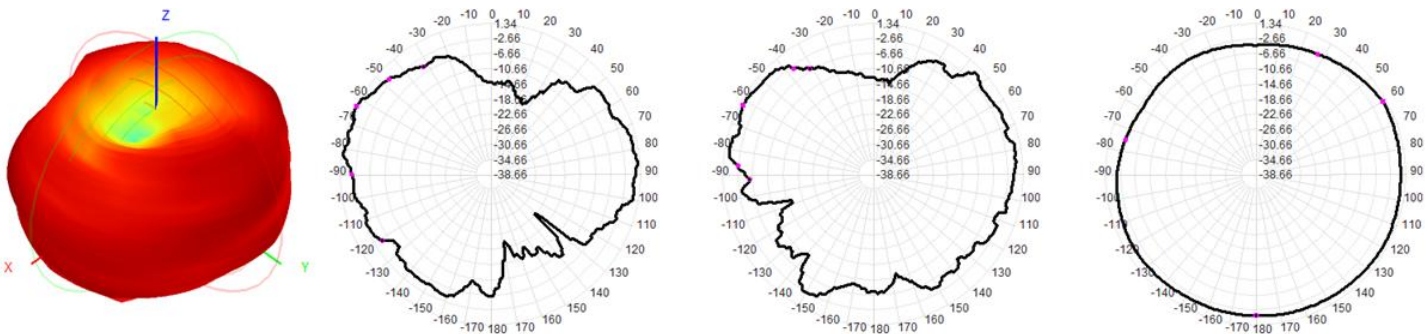

5. Mechanical Drawing See attached files

HF

RoHS2.0

REACH

CONFIDENTIAL

SIGN	DATE	DESCRIPTION	APPROVER
△			
△			
△			

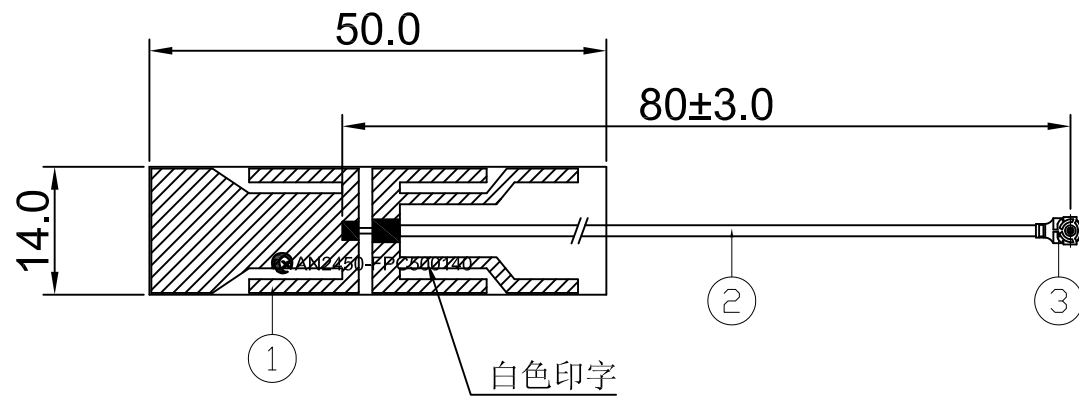

Note:

1. Mark * is important dimension; "Cpk "Identify for process control(CpK≥ 1.33).
2. Tolerance: Unmarked tolerance refer to the standard tolerance please.
3. Pay attention to the direction of the connector.

3	CR-113-ZP-A	I-PEX	Cu	Au Plating	1
2	CB-113BS	Coaxial Cable	OD1.13	Black	1
1	AN2450-FPC500140	FPC		Black	1
No.	Part Number	Name	Material	Finish	Q'ty

 **Tengxiang Electronics Co., Ltd.**

TITLE: 2.4G/5G Antenna					
PART NO.: AN2450-FPC76BX			CUSTOMER P/N: /		
APP BY	CHK BY	RF BY	DES BY		Tolerance
YCX	HC	WJ	DWF	UNITS: mm SCALE: 1/1 REVISION: A	X.X ±0.3
2023.03.11	2023.03.11	2023.03.11	2023.03.11		X.XX ±0.1
					X° ±1

產品包裝規範

PACKING CRITERION

Date: 2023.03.11

Page: 1 of 1

Part Number : AN2450-FPC76BX	Revision : A
Name: Antenna	Customer : ALL

1 . Enter PE bag。

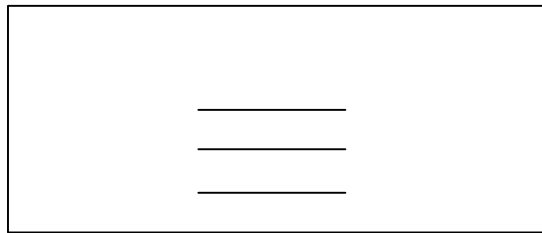

20pcs/ PE bag

2.PACKING 。

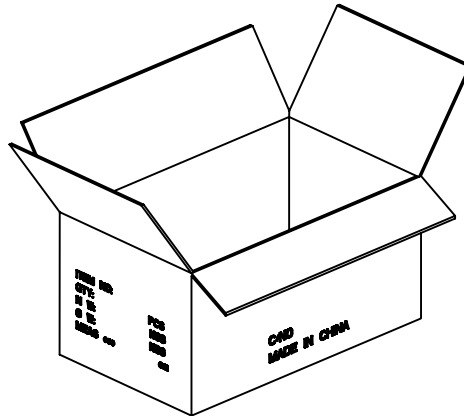

8000pcs/Carton

3. SEALING 。

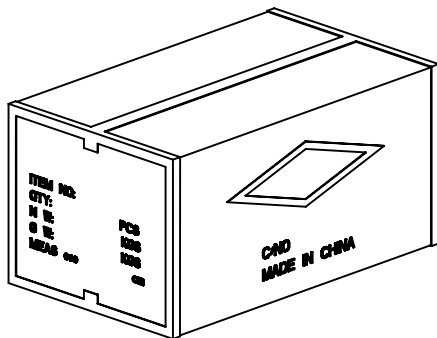

SIDE

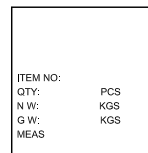

FRONT

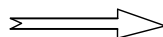
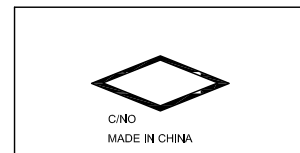

APPROVED BY : YCX

CHECKED BY : HC

DESIGNED BY : DWF