

BT Antenna Test Report Prepared for Godox Project

Author Ken

Date 2024.1.19

Client Information

Client	神牛(Godox)
Engineer of Client	
Project Name	
Project Stage	<input type="checkbox"/> Evaluation <input checked="" type="checkbox"/> EVT <input type="checkbox"/> DVT <input type="checkbox"/> PVT
Antenna Type	Linear Polarization
Antenna Band	2400~2500MHz
Antenna Engineer	Ken

Tuning Note

Version	Date	Revision Description	Designer
01	2024/1/19	Version 1	Ken

Antenna Info

LNA Name	Material	Dimension	Feed-In Location	PIN Length

1. Test Content :

BT Antenna in pattern measurement

2. Test Item :

Efficiency 、 Radiation Pattern 、 Total Gain 、 Average Gain

3. Test Setting :

Network Analyzer : Agilent E5071C

Source Antenna : Dual Polarization Horn Antenna

Test Frequency : 2400~2500MHz

4. Test Environment :

Room temperature : 22°C Humidity : 31%

5. Test Schematic Drawing of Setting :

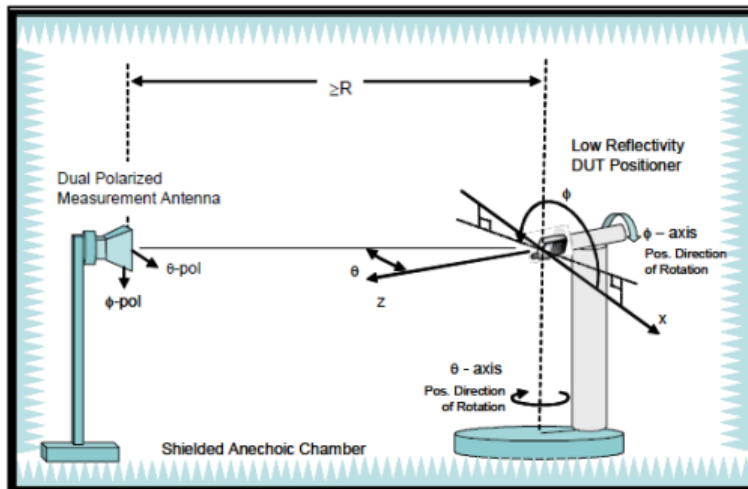
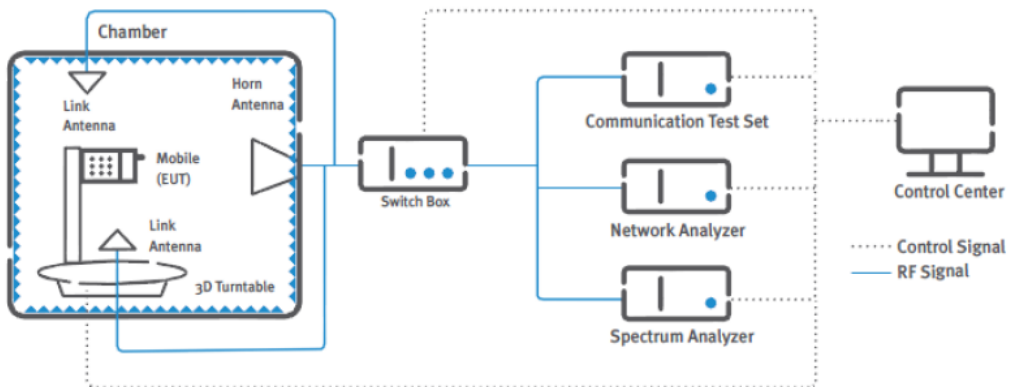

6. Test Data

Environment



Antenna S11 Return Loss Measurement

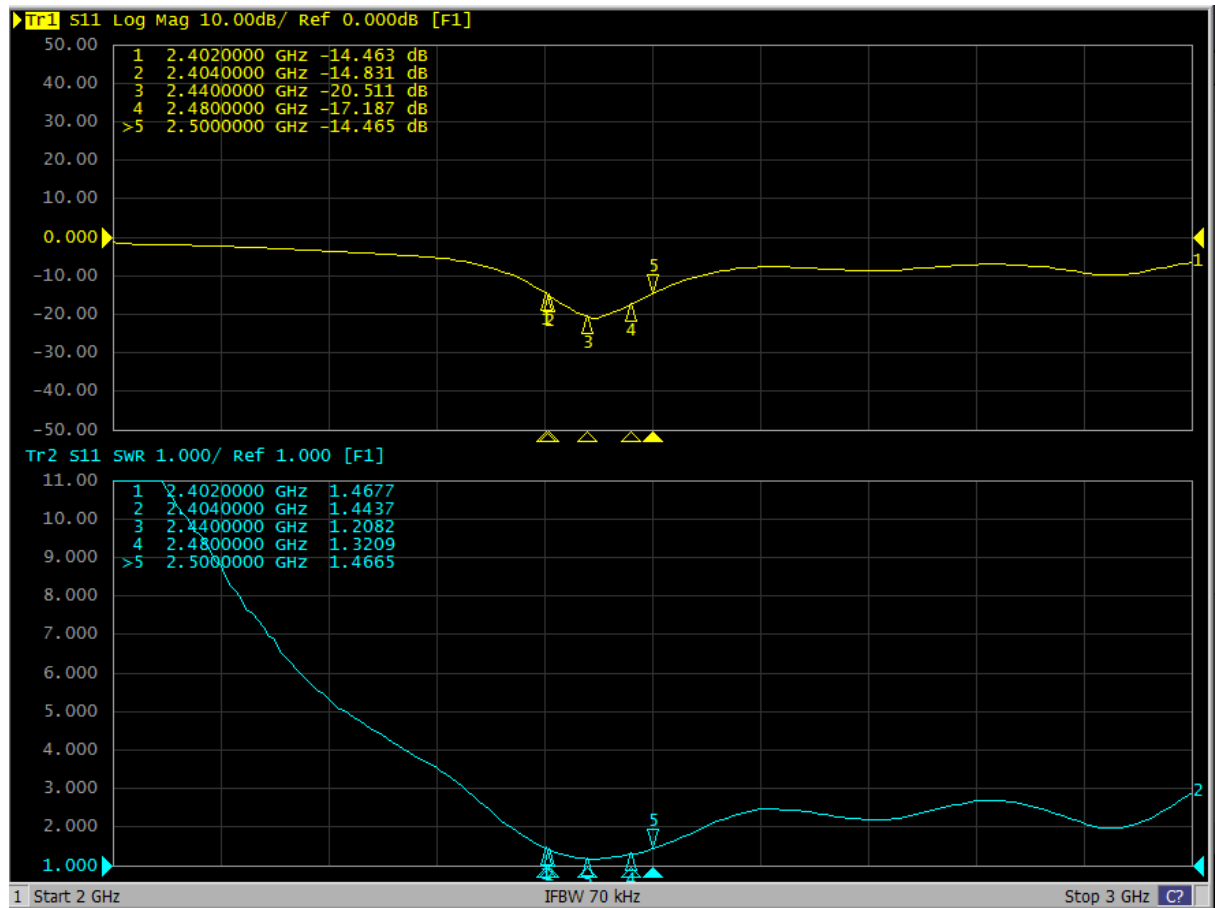

Coordinate

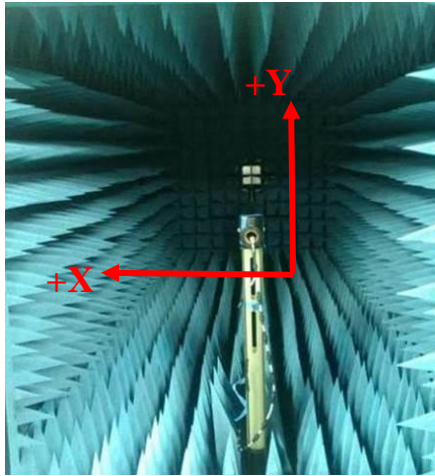

Chamber coordinate

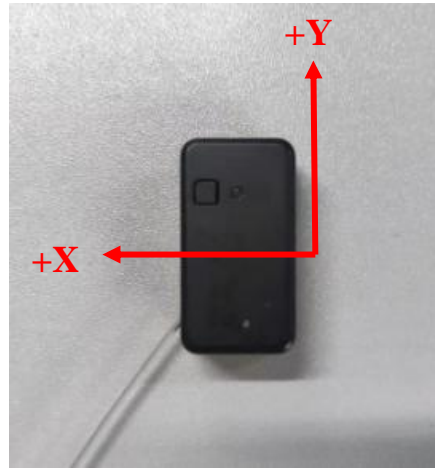

Antenna mounted on chamber coordinate

Radiation Pattern
Antenna 3D Pattern at 2400MHz

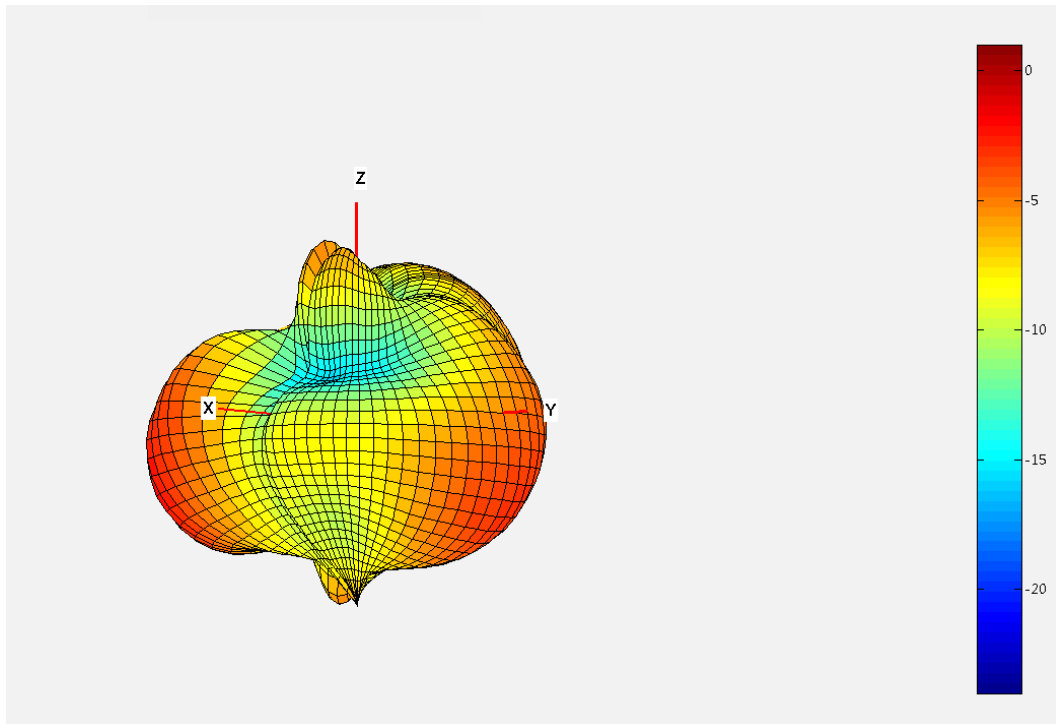

Antenna 3D Pattern at 2450MHz

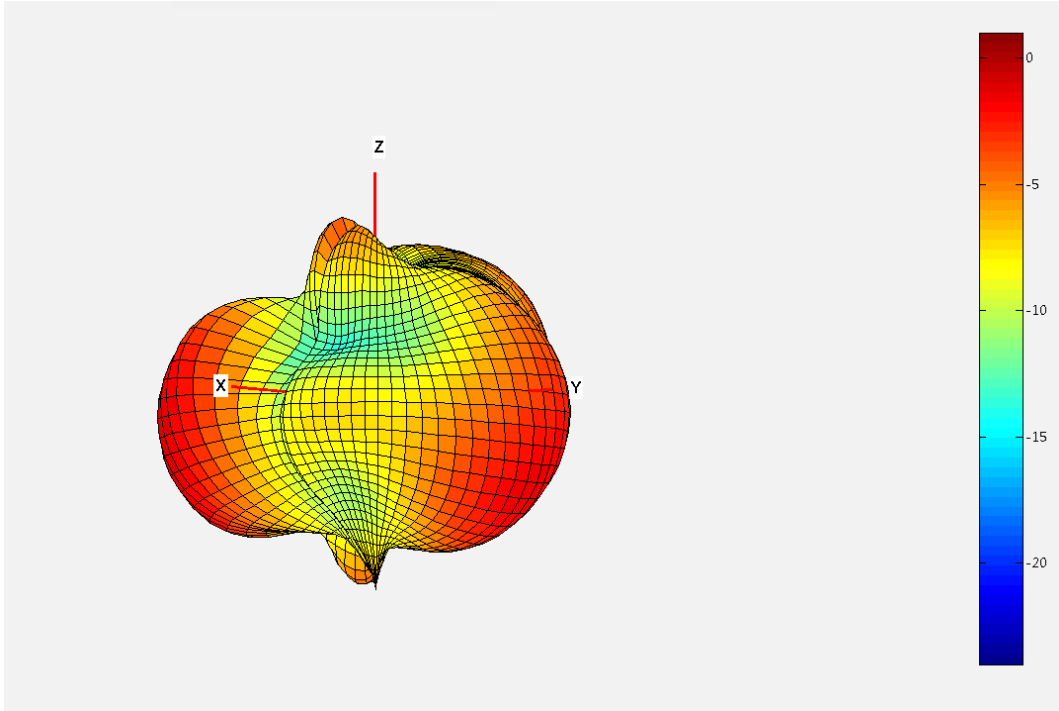

Antenna 3D Pattern at 2500MHz

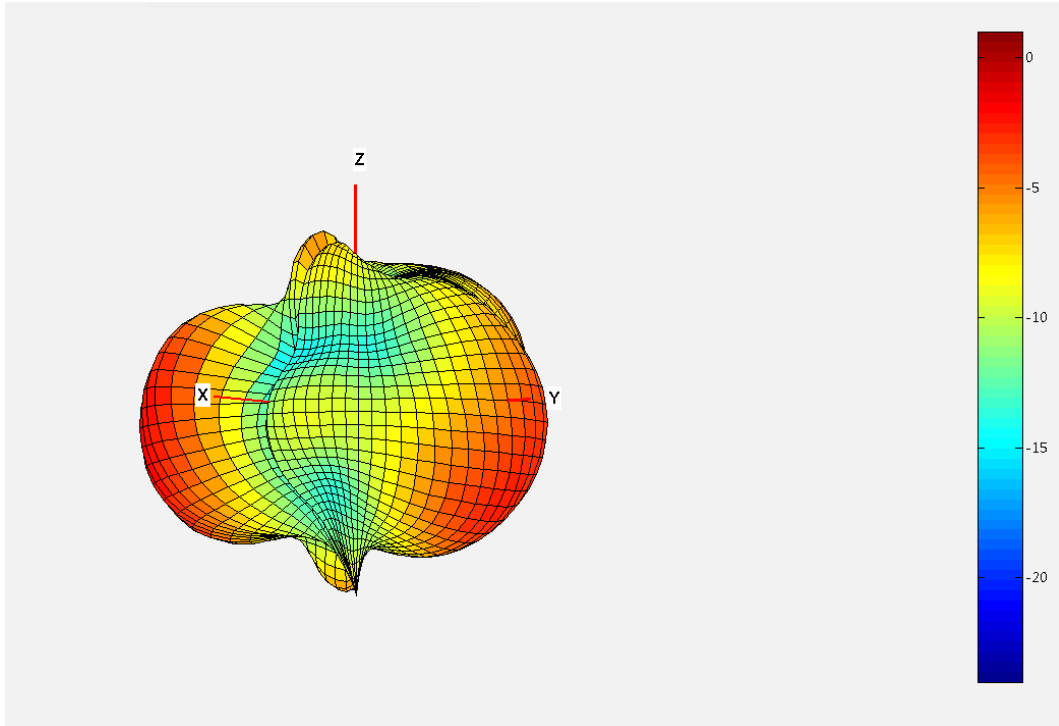

Measurements summary

Frequency	Efficiency (dB)	Efficiency (%)	Gain (dBi)
2402MHz	-4.58	34.83	-0.25
2404MHz	-4.55	35.08	-0.17
2440MHz	-4.31	37.07	0.19
2441MHz	-4.29	37.24	0.21
2472MHz	-4.47	35.73	-0.12
2480MHz	-4.51	35.4	-0.15

ANT size:3.05*1.6*0.55mm

