

GODOX设计文件图注			
项目类型	说明书	版本	2022-10-21
项目名称	潜水灯WT25R说明书		
产品料号	705-WT25R0-00		
尺寸(mm)	成品100x140mm		
尺寸公差	±1mm		
材质	105g哑粉纸		
工艺说明	单色印刷, 骑马钉		
备注/色值			
设计师	张云龙	校对	吴水宁

合格证  
QC PASS

Godox

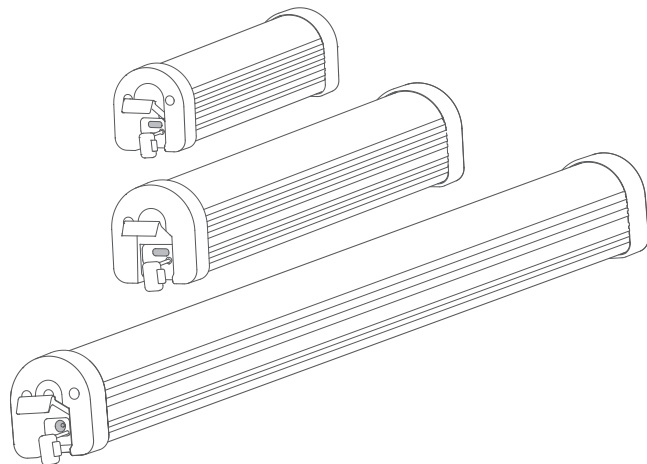

Wechat  
Official Account  
神牛微信公众号

深圳市神牛摄影器材有限公司

地址: 深圳市宝安区福海街道塘尾社区耀川工业区厂房2栋 电话: 0755-29609320(8062)

传真: 0755-25723423 邮箱: godox@godox.com

GODOX Photo Equipment Co.,Ltd.

Add.: Building 2, Yaochuan Industrial Zone, Tangwei Community, Fuhai Street, Bao'an District,  
Shenzhen 518103, China Tel: +86-755-29609320(8062) Fax: +86-755-25723423

E-mail: godox@godox.com

godox.com

Made in China | 705-WT25R0-00



WT25R  
WT40R  
WT60R

RGBWW 潜水灯  
RGBWW Dive Light

使用手册  
Instruction Manual

## 重要的安全说明及注意事项

首先作为最基本原则：本产品为专业灯光布景设备，应由专业灯光师使用或在专业人士指导下使用。使用时必须始终遵循基本的安全预防措施，具体安全预防措施如下：

1. 使用前必须阅读并理解产品说明书。
2. 专业灯具，禁止儿童使用。当儿童靠近时，家长或监护人必须密切监督，以免儿童因碰撞灯具或私人灯具造成人身伤害。
3. 本灯具并非普通照明灯具，不可用于普通照明，任何有过眼部损伤或眼部敏感的人群均应避免使用本灯具。
4. 灯具点亮时，必须小心使用，禁止接触高温部件，如LED灯珠，以免造成灼伤。
5. 灯具点亮时，任何情况下均禁止直视灯珠。应该在专业灯光师指导下使用强光，任何情况下避免长时间处于强光环境，如引起眼睛不适，请及时关闭灯具，暂停使用，请及时就医。
6. 倘灯珠损坏或因热变形，应停止使用，并及时联系制造商、服务代理商或合格的维修人员更换灯珠，以免发生意外。
7. 本产品仅适用于-10~+40°C工作环境温度环境下使用。
8. 请勿使用损坏的设备或设备配件，待专业维修人员检查维修，确认设备正常方可使用。
9. 在使用过程中，如果本产品由于跌落、受到挤压或遭受强烈冲击而造成外壳破裂的，请勿继续使用，以免因接触到内部电子元件而受到电击伤害。
10. 如需要延长线，请使用额定电流>该设备额定电流的延长线。如延长线额定电流小于该设备，可能导致过热。
11. 部分产品电源线较长，请合理放置电源线，使其处于安全位置。避免电源线接触过热物体表面、避免放置不当导致拉扯损坏或绊倒现场人员。请使用本厂原装电源线，如使用非本厂电源线导致产品损坏，概不在本厂维修范围内。
12. 在清洁和维修之前，请务必从电源插座上拔掉该设备插头。不使用时，禁止拉扯电源线以将设备插头从电源插座中拔出。正常断电，应是用手抓住该设备插头两端，将插头从电源插座中拔出。此设备需连接到接地插座中。
13. 请勿私自拆卸产品，如产品出现故障，须由本公司或授权的维修人员进行检查维修。
14. 存放本设备之前，请确保设备已完全冷却。存放时，将电源线从设备上拔出。设备应放置于设备便携包内或通风干燥处。
15. 请勿将设备放置在酒精、汽油等易燃易爆挥发的溶剂附近。
16. 本厂不推荐的产品附件，请勿使用，以免导致火灾、触电或人身伤害。
17. 清洁本设备时，请勿用湿布擦拭，请用干布、软布擦拭设备污垢。
18. 设备使用前，请注意将保护罩取下。
19. 本产品已通过ROHS, CE和FCC认证，请参考相关国家标准使用和操作。
20. 安全说明依据本厂严格测试制定，设备设计和规格如有变更，恕不另行通知。客户可以上神牛官网查看最新的电子版说明，了解产品最新资讯。
21. 部分产品内置锂电池。此类产品请使用专用的充电器进行充电，并且按正确的操作说明，在规定的电压、温度范围内使用。
22. 部分产品使用电池供电。此类产品请勿使用说明书中未指定的任何电池、电源或附件。请将电池和其他附件置于儿童及婴幼儿无法触及之处。如果儿童或婴幼儿吞下电池或附件，请立即就医。如果电池漏液、变色、变形、冒烟或发出异味，请立即将其取出。在取出过程中请小心，以免烫伤。如果继续使用，可能会引起火灾、触电或皮肤烫伤。请勿使用任何变形或改造过的电池。请勿拆卸或改造本产品或电池。请勿加热电池或焊接电池。请勿让电池与火或水接触。请勿让电池受到强烈的外力撞击。请勿将电池的正负端错误插入，或将新旧电池或不同类型的电池混合使用。

23. 一年保修期，消耗品电池、适配器、电源线等配件不在此保修范围内。
24. 经发现，擅自检修设备，将取消一年保修期，维修需要收取相关费用。
25. 对于不规范操作引起的机器故障不在保修范围内。

## 前言

感谢您购买神牛WT系列 RGBWW 潜水灯。

神牛全新推出一系列 IP68 级 RGBWW 潜水灯，可达水下40米，具备 RGBW 模式、超高输出功率、1800K-10000K 色温调节、蓝牙 APP 智能控制、37种逼真光效、亮度0%-100%精准调节、40 种色片模式、HSI 彩光模式等诸多特性。该系列水下条灯厂广泛适用于沿海深潜补光、湖泊潜水补光、水下拍照补光、水下录制补光、水下灯光表演、潜水培训等场景。

## 主要特点：

- 智能切换亮度模式，进入水下可开启高亮模式
- 防水等级IP68，WT25R/WT40R/WT60R皆可达水下40米
- 具备HSI彩光模式，高达36000种色彩可调，让您切换自如
- 支持1800K-10000K色温之间精准调节，获取更理想光效
- 支持蓝牙APP远程控制，满足摄影师在特定场景下远程操控（仅支持水上模式）
- 智能电量显示，让您随时随地知道灯体电量剩余时长
- 37种FX场景光效，可自定义调节光效亮度，助你获得逼真场景光效
- 具备 RGBW 模式，允许用户对红、绿、蓝和白色 LED 进行单独调整，产生千万种精美色彩
- WT25R/WT40R 充电接口为 USB Type-C，支持快速充电，支持充电宝、适配器等多种充电方式

## 警告

▲ 请勿私自拆卸产品，如产品出现故障须由本公司或授权的维修人员进行检查维修。

▲ 请勿让儿童接触本产品。

▲ 请勿在化学品、可燃性气体或其他特殊物质附近使用灯，有可能导致火灾或电磁干扰。在这些场合下，请注意相关警告标识。

▲ 内置锂电池，禁止拆卸、撞击、挤压或投入火中，若出现严重膨胀，请勿继续使用。

▲ 请勿放置在超过40°C 的高温环境中。使用产品要求参数的充电器进行充电，并且正确的按照操作说明，在规定的电压、温度范围内使用。

▲ 潜水灯下水前，请务必将硅胶盖子牢牢塞进充电口，然后盖紧外盖，以免造成产品损坏。

▲ 潜水灯在海里拍摄后，用清水冲洗干净，方可放置于干燥通风处。

## 部件名称

### 灯体

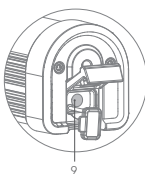
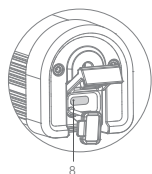
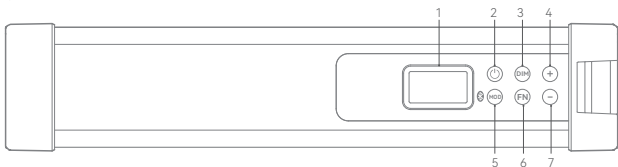

1. OLED 屏
2. 电源开关键
3. DIM 按键
4. +按键
5. MOD/蓝牙按键

6. FN 按键
7. -按键
8. Type-C 充电接口 (WT25R/WT40R)
9. DC 充电接口 (WT60R)

### 显示屏界面

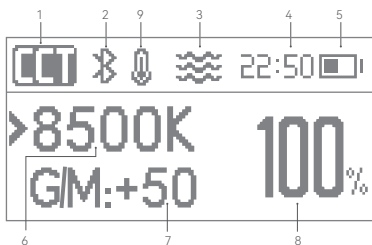

1. CCT 图标
2. 蓝牙
3. 水下高亮模式
4. 电池剩余时长
5. 电池电量
6. 色温值
7. 洋红/绿调节
8. 亮度调节百分比
9. 高温警告图标

3

### HSI 模式界面



1. HSI 图标
2. 蓝牙
3. 电池剩余时长
4. 电池电量
5. 色相
6. 色相范围 (0°-360°)
7. 亮度调节百分比
8. 饱和度
9. 饱和度范围 (0-100)
10. 水下高亮模式

### RGB 模式界面

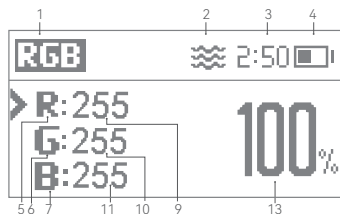

1. RGB 图标
2. 水下高亮模式
3. 电池剩余时长
4. 电池电量
5. 红光图标
6. 绿光图标
7. 蓝光图标
8. 白光图标

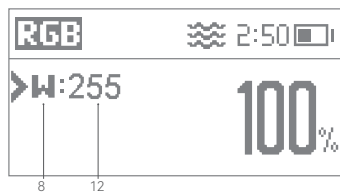

9. 红光调节范围 (0-255)
10. 绿光调节范围 (0-255)
11. 蓝光调节范围 (0-255)
12. 白光调节范围 (0-255)
13. 亮度调节百分比

### GEL 色片模式界面



1. GEL 图标
2. 蓝牙
3. 电池剩余时长
4. 电池电量
5. R-GEL 色片
6. L-GEL 色片
7. 色片模式亮度调节百分比
8. 水下高亮模式

4

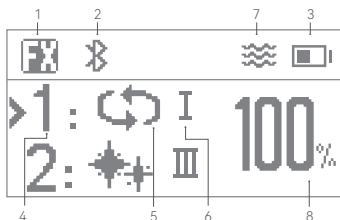

1. FX 图标
2. 蓝牙
3. 电池电量
4. 光效序号
5. 光效类型
6. 光效档位
7. 水下高亮模式
8. 亮度调节百分比

## 物品清单

型号	物品清单
WT25R	灯体*1、Type-c 快充线*1、手绳*1、1/4"转1"球头座*1
WT40R	灯体*1、Type-c 快充线*1、手绳*1、1/4"转1"球头座*1
WT60R	灯体*1、适配器*1、电源线*1、手绳*1、1/4"转1"球头座*1

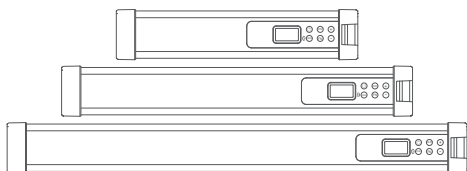

灯体



电源线



适配器



Type-C 快充线



手绳



1/4"转1"球头座

## 另购附件



夹具 WT-C01

## 使用说明

### 1. 开关机

长按1秒电源开关键，实现灯体开机/关机。开机且开启亮度时，短按一次电源开关键，光线消失，亮度值为0%；再次短按一次电源开关键恢复之前亮度值。

### 2. 亮度调节

短按一次 DIM 按键，亮度值出现闪烁，短按一次+按键可增加1个亮度值，长按+按键可快速增至所需亮度值。短按一次-按键可减少1个亮度值，长按-按键可快速减至所需亮度值。设置完毕，短按一次 DIM 按键退出亮度设置，或10s无人操作，亮度值停止闪烁，自动退出亮度设置。

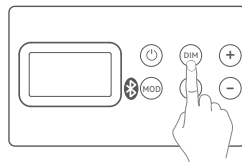

### 3. CCT色温模式/HSI彩光模式/RGBW模式/GEL色片模式/FX光效模式

短按 MOD/蓝牙按键可切换模式。

#### 3.1 CCT色温模式

切换至 CCT 色温模式，短按 FN 按键可选择色温调节或洋红 / 绿调节。

选择色温调节或洋红 / 绿调节后，短按一次+ 按键可增加100K 色温值或1个洋红 / 绿值，长按+ 按键可快速增至所需色温值或洋红 / 绿值。短按一次- 按键可减少100K 色温值或1个洋红 / 绿值，长按- 按键可快速减至所需色温值或洋红 / 绿值，色温调节范围为1800K-10000K，洋红 / 绿值调节范围为-50-+50。

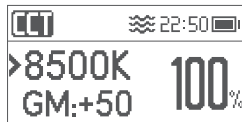

#### 3.2 HSI彩光模式

切换至 HSI 彩光模式，短按FN按键可选择色相调节或饱和度调节。

选择色相调节/饱和度调节后，短按一次+按键可增加1°色相值/1个饱和度值，长按+按键可快速增至所需色相值/饱和度值。短按一次-按键可减少1°色相值/1个饱和度值，长按-按键可快速减至所需色相值/饱和度值，色相调节范围为0°-360°，饱和度调节范围为0-100。



#### 3.3 RGBW模式

切换至 RGBW 模式时，短按FN按键可选择红光调节、绿光调节、蓝光调节或白光调节。选择红光调节/绿光调节/蓝光调节/白光调节后，短按一次+按键可增加1个单位值，长按+按键可快速增至所需单位值。短按一次-按键可减少1个单位值，长按-按键可快速减至所需单位值，红光/绿光/蓝光/白光调节范围均为0-255。

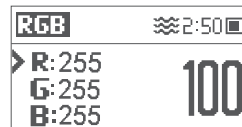

### 3.4 GEL 色片模式

切换至 GEL 色片模式, 短按FN按键可选择 R-GEL 色片或 L-GEL 色片。

选择 R-GEL 色片后, 短按一次+按键进入 R-GEL 色片设置界面, 此时短按 FN 按键可选择色片类型, 一共有20种 R-GEL, 最后短按一次-按键可返回上一级设置。

选择 L-GEL 色片后, 短按一次+按键进入 L-GEL 色片设置界面, 此时短按FN按键可选择色片类型, 一共有20种 L-GEL 色片。最后短按一次-按键可返回上一级设置。

色片	色片类型
R-GEL色片	128、153、156、165、723、724、220、342、720、910、990、16、17、38、47、65、92、93、4415、9406
L-GEL色片	002、007、008、036、110、115、117、128、131、134、148、153、156、165、243、244、327、701、723、724

### 3.5 FX 光效模式

切换至 FX 光效模式时, 短按 FN 按键可切换光效类型。快速按两次 FN 按键, 可切换至上一个光效。选好光效类别后, 短按 + 按键或 - 按键均可调节光效档位。



WT25R/WT40R/WT60R光效表 (13类37种)

序号	序号	场景	显示I	显示II	显示III
1		彩光循环	慢速	中速	快速
2		闪光灯	闪光	发布会	狗仔队
3		派对	生日会	KTV	迪斯科
4		雷闪电	间歇	频繁	持续
5		坏灯泡	间歇	频繁	持续
6		电视机	慢速	中速	快速
7		蜡烛	间歇	频繁	持续
8		火	柴火	篝火	火灾
9		烟花	短暂	连续	演出
10		警车	暴闪	频闪	快闪
11		消防车	暴闪	频闪	快闪
12		救护车	暴闪	频闪	快闪
13	SOS	SOS			

### 4. 模式说明



水上模式



水下高亮模式 (界面显示 )

### 5. 模式校准功能

当水上模式与水下模式切换异常, 则需进行模式校准。

模式校准: 在水上且灯体干燥时, 同时长按MOD按键与-按键即可模式校准。



界面显示“Calibrating”, 表示校准中。



界面显示一个“√”和“DONE”, 表示校准完成。

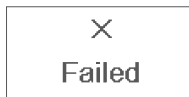

界面显示一个“×”和“Failed”, 表示校准失败, 需重新校准。

### 6. 蓝牙设置

长按 MOD/蓝牙按键, 进入蓝牙设置界面。短按FN按键选择蓝牙开关(ON/OFF)或蓝牙重置(RESET)。选择蓝牙开关后, 短按+按键或-按键开启/关闭蓝牙。选择蓝牙重置(RESET)后, 短按+按键或-按键进行蓝牙重置。显示屏出现“Reset”, 表示蓝牙正在重置。重置结束, 自动返回蓝牙设置界面。



扫描此二维码即可下载“GodoxLight”手机APP(安卓和苹果系统都可以使用)。

手机 APP 操作请打开 APP 里的“帮助”, 里面有详细教程。

注: 首个移动设备(手机或平板电脑)可直接使用 APP 操控灯体, 更换其他移动设备时, 灯体进行蓝牙重置 (Reset)后, 方可正常使用APP。

### 7. 充电异常提醒

当显示屏出现 图标, 说明可能出现电池异常或充电器异常等情况。

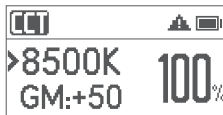

开机时异常提醒界面



关机时异常提醒界面

## 照度数据

### WT25R

色温	模式	照度单位	0.5m	1m	2m
1800K	水下模式	lux	867	222	58.8
		fc	80.6	20.7	5.5
	水上模式	lux	338	83.8	20.9
		fc	31.4	7.8	2
2800K	水下模式	lux	1380	356	93.3
		fc	128	33	8.7
	水上模式	lux	595	148	38.2
		fc	55.2	13.8	3.6
3200K	水下模式	lux	1470	376	97.9
		fc	137	34.9	9.1
	水上模式	lux	577	149	39.4
		fc	53.6	13.9	3.7
4300K	水下模式	lux	1560	397	104
		fc	145	36.9	9.7
	水上模式	lux	627	163	43
		fc	58.3	15.2	4
5600K	水下模式	lux	1620	415	109
		fc	151	38.5	10.1
	水上模式	lux	625	164	43.2
		fc	58.1	15.3	4
6500K	水下模式	lux	1660	422	109
		fc	154	39.2	10.1
	水上模式	lux	642	171	44.6
		fc	59.7	15.9	4.2
7500K	水下模式	lux	1650	418	109
		fc	153	38.8	10.1
	水上模式	lux	636	167	45
		fc	59.1	15.5	4.2
8500K	水下模式	lux	1610	407	107
		fc	149	37.8	9.9
	水上模式	lux	656	172	45.2
		fc	61	16	4.2
10000K	水下模式	lux	1800	447	116
		fc	167	41.5	10.8
	水上模式	lux	702	177	47.1
		fc	65.3	16.4	4.4

### WT40R

色温	模式	照度单位	0.5m	1m	2m
1800K	水下模式	lux	1940	503	146
		fc	181	46.8	13.6
	水上模式	lux	578	152	43
		fc	53.7	14	4
2800K	水下模式	lux	2850	754	206
		fc	265	70	19.1
	水上模式	lux	801	222	59.8
		fc	74.4	20.6	5.6
3200K	水下模式	lux	3300	880	239
		fc	307	81.8	22.2
	水上模式	lux	971	260	70
		fc	90.2	24.2	6.5
4300K	水下模式	lux	3550	947	255
		fc	330	87.9	23.7
	水上模式	lux	1040	280	76.1
		fc	97	26	7
5600K	水下模式	lux	3660	981	264
		fc	340	91.1	24.5
	水上模式	lux	1110	295	79
		fc	103	27.4	7.3
6500K	水下模式	lux	3810	1030	276
		fc	354	95.3	25.6
	水上模式	lux	1130	302	80.7
		fc	105	28.1	7.5
7500K	水下模式	lux	3380	913	244
		fc	314	84.8	22.7
	水上模式	lux	1030	275	73.5
		fc	95.6	25.5	6.8
8500K	水下模式	lux	3200	866	232
		fc	298	80.5	21.5
	水上模式	lux	976	261	69.8
		fc	90.7	24.2	6.5
10000K	水下模式	lux	3220	874	232
		fc	299	81.2	21.6
	水上模式	lux	981	262	70.1
		fc	91.1	24.3	6.5

## WT60R

色温	模式	照度单位			
1800K	水下模式	lux			
		fc			
	水上模式	lux			
		fc			
2800K	水下模式	lux			
		fc			
	水上模式	lux			
		fc			
3200K	水下模式	lux			
		fc			
	水上模式	lux			
		fc			
4300K	水下模式	lux			
		fc			
	水上模式	lux			
		fc			
5600K	水下模式	lux			
		fc			
	水上模式	lux			
		fc			
6500K	水下模式	lux			
		fc			
	水上模式	lux			
		fc			
7500K	水下模式	lux			
		fc			
	水上模式	lux			
		fc			
8500K	水下模式	lux			
		fc			
	水上模式	lux			
		fc			
10000K	水下模式	lux			
		fc			
	水上模式	lux			
		fc			

以上测试皆在灯体100%亮度下进行。

## 规格参数

型号	WT25R	WT40R	WT60R
供电	5V/2.5A、9V/1.5A、12V/1A、15V/0.8A、20V/0.75A	5V/3A、9V/3A、12V/3A、15V/2.7A、20V/2A	20V/3.25A
水下功率	最大20W	最大55W	最大77W
水上功率	最大7W	最大15W	最大14W
充电接口	Type-C	Type-C	DC输入口
色温	1800K-10000K		
TLCI	≥96		
CRI	≥96		
调光范围	0%-100%		
模式	CCT色温模式/HSI 彩光模式/RGBW 模式/GEL色片模式/FX光效模式		
防水等级	IP68(水下40米)		
充电时长	最快2小时10分	最快2小时20分	最快2小时20分
持续使用时间 (100%亮度)	≈1小时(水下模式) ≈3小时(水上模式)	≈1.5小时(水下模式) ≈5.8小时(水上模式)	≈2小时(水下模式) ≈10小时(水上模式)
控制方式	蓝牙 APP 控制		
蓝牙控制距离	≈25m (仅限水上使用)		
工作温度环境	-10°C~40°C		
尺寸	57mm*53mm*250mm	57mm*53mm*380mm	57mm*53mm*640mm
净重	0.66kg	1.1kg	1.9kg

规格参数如有变更, 恕不另行通知。



## Safety Instructions and Attentions

First of all, as the most basic principle: This product is a professional lighting set equipment and should be used by professional lighting engineers or under the guidance of professionals. Basic safety attentions must always be followed during use, as follows:

1. Before use, please read and understand these instructions and attentions.
2. Professional lighting is prohibited for children. When children are near, parents or accompanying persons must supervise closely to prevent children from personal injury due to collision with lamps or private use of lamps.
3. This lighting product is not ordinary lighting product and cannot be used for general lighting. Anyone who has suffered eye damage or has sensitive eyes should avoid using this product.
4. When the lamp is on, it must be used with care. Do not touch high-temperature parts, such as LED lamp beads, to avoid burns.
5. When the lamp is on, it is forbidden to look directly at the lamp beads under any circumstances. Strong light should be used under the guidance of professional lighting engineers. Avoid prolonged exposure to strong light under any circumstances. If eye discomfort, please turn off the lamp in time, suspend use, and see a doctor immediately.
6. If the lamp bead is damaged or deformed by heat, stop using this equipment, and contact the manufacturer, service agent or qualified maintenance personnel to replace the lamp bead in time to avoid accidents.
7. This product is only suitable for use in  $-10^{\circ}\text{C}$  to  $+40^{\circ}\text{C}$  operating environment .
8. Do not use damaged equipment or accessories, and wait for professional maintenance personnel to check and repair to confirm being normal before use.
9. During using, if the casing of this product is broken due to being dropped, squeezed or subjected to strong impact, please do not use it, so as to avoid electric shock injury due to contact with internal electronic components.
10. If an extension cord is required, please use an extension cord with a current rating greater than or equal to that of the equipment. If an extension cord is rated less than the equipment, overheating may result.
11. Some products have long power cords, please place the power cords properly and keep them in a safe place. Avoid contacting the power cord with overheating surfaces, avoid improper placement that could cause pulling damage, or trip on-site personnel. Please use the certified power cord from the original manufacturer. If the product is damaged by using a non-certified power cord, it will not be repaired by our factory.
12. Be sure to unplug equipment from the power outlet before cleaning and repairing. When not in use, do not pull the power cord to unplug the equipment. For normal power-off, please hold both ends of the plug of the equipment with your hands and pull the plug out of power outlet. This equipment needs to be connected to a grounded outlet. Do not disassemble the product without permission. If the product fails, it must be checked and repaired by authorized maintenance personnel.
13. Before storing, make sure that the equipment has cooled down completely. For storage, unplug the power cord from the equipment. The equipment should be placed in the carrying case or in a ventilated dry place.
15. Do not place equipment near flammable and volatile solvents such as alcohol and gasoline.
16. Do not use accessories that are not recommended by our factory to avoid fire, electric shock or personal injury.
17. When cleaning, do not wipe it with a damp cloth, please use a dry cloth or a soft cloth to wipe the dirt of the equipment.
18. Please take off the protective cover before using.
19. This product complies with RoHS, CE and FCC certification, please refer to the relevant national standards for use and operation.

20. The safety instructions are formulated according to the strict testing of the factory, and the design and specifications of the equipment are subject to change without prior notice. For latest product information, please check the GODOX website and view latest electronic instruction.
21. Some products have built-in lithium batteries. Please use specified chargers, and use them within a proper range of the specified voltage and temperature according to the correct operating instructions.
22. Some products are battery powered. Do not use any batteries, power sources or accessories not specified in the instructions for such products. Keep batteries and other accessories out of the reach of children and infants. In the instance that a child or infant swallows a battery or accessory, immediate emergency medical attention is required. If the battery leaks, becomes discolored, deformed, emits smoke, or emits an abnormal odor, remove it immediately. Be careful during removal to avoid burns. Continued use could result in fire, electric shock, or burns. Do not use any deformed or modified batteries. Do not disassemble or modify this product or battery. Do not heat or solder the battery. Keep the battery away from fire or water. Do not incorrectly insert the positive and negative ends of batteries, or mix old and new batteries or batteries of different types together.
24. One-year warranty period, accessories such as consumable batteries, adapters, power cords, etc. are not covered by this warranty.
25. If it is found that the equipment is repaired without authorization, the one-year warranty period will be cancelled and relevant fees will be charged for maintenance. Machine failures caused by non-standard operation are not covered by the warranty.

**keep these instructions!**

## Foreword

Thank you for purchasing!

RGBWW Dive Light series has a IP68 waterproof function of up to 40 meters, ultra-high output power, Bluetooth APP smart control, 13 realistic light effects and adjustable brightness from 0% to 100%. This series can be widely used for filling light in diving, underwater photography, underwater recording, underwater light show and etc.

## Main Features

- Smart brightness adjusting ability to enter high light mode under water.
- Waterproof rate IP68, workable up to 40m underwater.
- HSI mode has 36000 colors.
- Color temperature is precisely adjustable from 1800K to 10000K.
- Support Bluetooth APP remote control in abovewater mode.
- Smart battery level indication gives convenience and utility.
- 37 FX modes and freely adjustable brightness.
- RGBW mode allows separated adjustment of red, green, blue and white LED.
- WT25R and WT40R support fast charging through USB Type-C port.

## ▲Warning

- ▲ Do not disassemble. Should repairs become necessary, this product must be sent to an authorized maintenance center.
- ▲ Keep out of reach of children.
- ▲ Do not use the product in the presence of flammable gases, chemicals and other similar materials. In certain circumstance, please pay attention to the relevant warnings.

- ▲ Built-in lithium battery, do not disassemble, impact, squeeze or put it into fire. If serious bulge occurs, please do not use.
- ▲ Do not leave or store the product if the ambient temperature reads over 40°C.
- ▲ Please use the proper charger and follow the operation instruction.
- ▲ Make sure to seal the charging port with silicone lid and then close the cover before using under water.
- ▲ Please wash it with clean water and put it in a dry and ventilated place after using in the sea.

## Product Structure

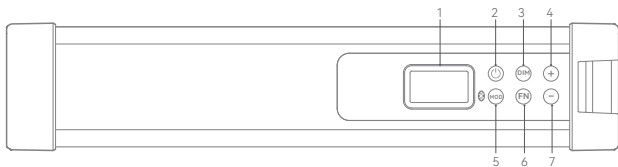

1. OLED Panel
2. Power Switch
3. DIM Button
4. + Button
5. MOD/Bluetooth Button

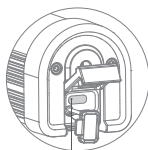

6. FN Button
7. - Button
8. Type-C Charging Port (WT25R/WT40R)
9. DC Charging Port (WT60R)

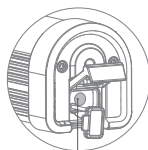

## Display

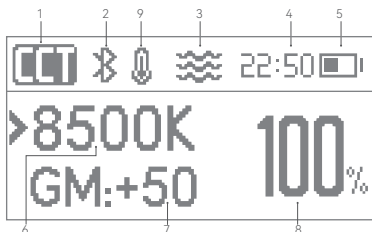

1. CCT Icon
2. Bluetooth
3. Underwater Highlight Mode
4. Battery Life
5. Battery Level
6. CCT Value
7. G/M Adjustment
8. DIM Adjust Ratio
9. Over-temperature Alert Icon

15

## HSI Mode Display

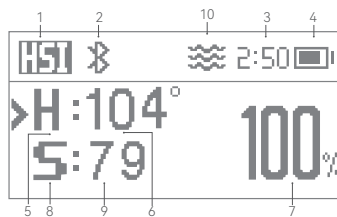

1. HSI Icon
2. Bluetooth
3. Battery Life
4. Battery Level
5. HUE
6. HUE Range (0°-360°)
7. DIM Adjust Ratio
8. Saturation
9. Saturation Range (0-100)
10. Underwater Highlight Mode

## RGBW Mode Display

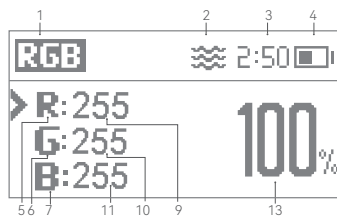

1. RGBW Icon
2. Underwater Highlight Mode
3. Battery Life
4. Battery Level
5. Red Light Icon
6. Green Light Icon
7. Blue Light Icon
8. White Light Icon



9. Red Light Range (0-255)
10. Green Light Range (0-255)
11. Blue Light Range (0-255)
12. White Light Range (0-255)
13. DIM Adjust Ratio

## GEL Mode Display



1. GEL Icon
2. Bluetooth
3. Battery Life
4. Battery Level
5. R-GEL
6. L-GEL
7. DIM Adjust Ratio of GEL Mode
8. Underwater Highlight Mode

16

## FX Mode Display

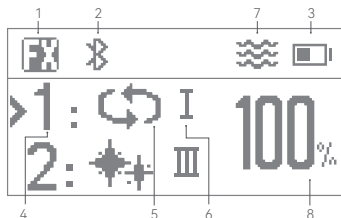

1. FX Icon
2. Bluetooth
3. Battery Level
4. FX No.
5. FX Type
6. FX Level
7. Underwater Highlight Mode
8. DIM Adjust Ratio

## Item List

Model	Item List
WT25R	Light body*1, Type-C charging cable*1, Portable rope*1, 1/4" to 1" ball joint *1
WT40R	Light body*1, Type-C charging cable*1, Portable rope*1, 1/4" to 1" ball joint *1
WT60R	Light body*1, Adapter*1, Power cable*1, Portable rope*1, 1/4" to 1" ball joint *1

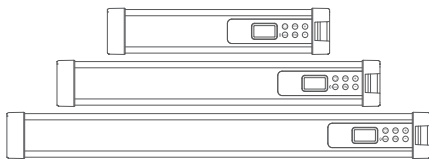

Light body



Power cable



Adapter



Type-C charging cable



Portable rope



1/4" to 1" ball joint

## Separately Sold Accessories

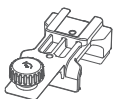

Light Clamp WT-C01

## Operation Instruction

### 1. Power Switch

Long press the power switch for 1 second to power on or off the device. When the light is on in power on status, short press the power switch once in power on status to turn off the light, the DIM value is 0%, short press again to resume the previous DIM value.

### 2. Brightness Adjustment

Short press the DIM button once to make the DIM value blinks. Then short press the + button once can increase the DIM value by 1 unit, long press the + button can increase the DIM value quickly. Short press the - button once can decrease the DIM value by 1 unit, long press the - button can decrease the DIM value quickly. Finally, short press the DIM button once can exit the brightness setting. It will automatically exit the brightness setting when the DIM value stops blinking after 10 seconds of idle use.

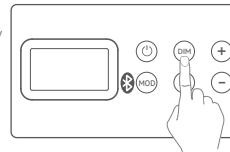

### 3. CCT Mode/HSI Mode/RGB Mode/GEL Mode/FX Mode

Short press the MOD/Bluetooth button to switch mode.

#### 3.1 CCT Mode

Short press the FN button in CCT mode to choose CCT adjustment or G/M adjustment.

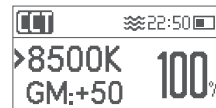

Short press the + button once can increase the CCT value by 100K or G/M value by 1 unit, long press the + button can increase the CCT value or G/M value quickly. Short press the - button once can decrease the CCT value by 100K or G/M value by 1 unit, long press the - button can decrease the DIM value or G/M value quickly. The CCT value is adjustable from 1800K to 10000K, and G/M value is adjustable from -50 to +50.

#### 3.2 HSI Mode

Short press the FN button in HSI mode to choose HUE adjustment or saturation adjustment.

Short press the + button once can increase the HUE value by 1° or saturation value by 1 unit, long press the + button can increase the HUE value or saturation value quickly. Short press the - button once can decrease the HUE value by 1° or saturation value by 1 unit, long press the - button can decrease the HUE value or saturation value quickly. The HUE value is adjustable from 0° to 360°, and saturation value is adjustable from 0 to 100.



#### 3.3 RGB Mode

Short press the FN button in RGB mode to choose red light adjustment, green light adjustment, blue light adjustment or white light adjustment. Short press the + button once can increase the light value by 1 unit, long press the + button can increase the light value quickly. Short press the - button once can decrease the light value by 1 unit, long press the - button can decrease the light value quickly. The red light/green light/blue light/white light value are all adjustable from 0 to 255.

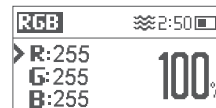

### 3.4 GEL Mode

Short press the FN button in GEL mode to choose R-GEL or L-GEL.

Short press the + button once in R-GEL mode to enter setting interface, short press the FN button to select among 20 R-GEL modes, then short press again to return to the previous interface.

Short press the + button once in L-GEL mode to enter setting interface, short press the FN button to select among 20 L-GEL modes, then short press again to return to the previous interface.

GEL	Type
R-GEL	128, 153, 156, 165, 723, 724, 220, 342, 720, 910, 990, 16, 17, 38, 47, 65, 92, 93, 4415, 9406
L-GEL	002, 007, 008, 036, 110, 115, 117, 128, 131, 134, 148, 153, 156, 165, 243, 244, 327, 701, 723, 724

### 3.5 FX Mode

Short press the FN button in FX mode to switch light effects. Short press the FN button twice to return to the previous light effect. Short press the + button or – button can adjust the FX level.



FX Table of WT25R/WT40 R/WT60 R (37 kinds within 13 types)

No.	Icon	Scene	Display I	Display II	Display III
1		RGB cycle	Slow speed	Medium speed	Quick speed
2		Flash	Flash	Press conference	Paparazzi
3		Party	Birth day party	KTV	Disco
4		Lightning	Discontinuous	Frequent	Sustainable
5		Broken bulb	Discontinuous	Frequent	Sustainable
6		TV	Slow speed	Medium speed	Quick speed
7		Candle	Discontinuous	Frequent	Sustainable
8		Fire	Firewood	Campfire	Fire hazard
9		Firework	Brief	Continuous	Show
10		Police car	Strong flash	Frequent flash	Quick flash
11		Fire truck	Strong flash	Frequent flash	Quick flash
12		Ambulance	Strong flash	Frequent flash	Quick flash
13	<b>SOS</b>	SOS			

### 4. Mode Description



Abovewater Mode



Underwater Highlight Mode  
(∞ is displayed on the panel)

### 5. Calibrating Function

The calibrating function is helpful when there are abnormalities in switching between abovewater mode and underwater mode.

Calibrating mode: Long press the MOD button and – button at the same time when the light is dry in abovewater mode to enter calibrating mode.

When the “Calibrating” is displayed on the panel, it means calibration is in process.

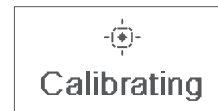

When the “✓” and “DONE” is displayed on the panel, it means calibration is completed.



When the “✗” and “Failed” is displayed on the panel, it means calibration is failed.

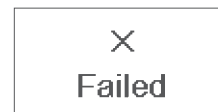

### 6. Bluetooth Setting

Long press the MOD/Bluetooth button to enter Bluetooth setting interface. Short press the FN button to choose Bluetooth switch (ON/OFF) or Bluetooth reset. If you choose Bluetooth switch, short press the + button or – button to turn on or off the Bluetooth. If you choose Bluetooth reset, short press the + button or – button to reset the Bluetooth. When “Reset” is displayed on the panel, it means resetting, after which, it will return to Bluetooth setting interface automatically.



Scan the following QR code to download "Godox Light" mobile APP (both Android and IOS systems are available).

For specific operations, please refer to the "Help" manual of the mobile APP, which contains detailed instruction.

Note: the APP can be used directly on the firstly installed device (smartphone or tablet). When changing to other mobile devices, the light shall be reset before normal usage of APP.

## 7. Abnormal Charging Alert

When the  icon appears on the display, there may be battery abnormality, charger abnormality or other abnormalities.

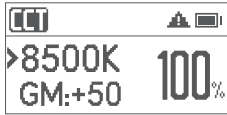

Abnormality alert interface  
in power on status

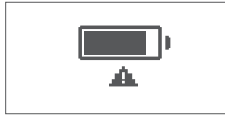

Abnormality alert interface in  
power off status

## Illuminance Data

### WT25R

CCT	Mode	Illuminance Unit	0.5m	1m	2m
1800K	Underwater	lux	867	222	58.8
		fc	80.6	20.7	5.5
	Abovewater	lux	338	83.8	20.9
		fc	31.4	7.8	2
2800K	Underwater	lux	1380	356	93.3
		fc	128	33	8.7
	Abovewater	lux	595	148	38.2
		fc	55.2	13.8	3.6
3200K	Underwater	lux	1470	376	97.9
		fc	137	34.9	9.1
	Abovewater	lux	577	149	39.4
		fc	53.6	13.9	3.7
4300K	Underwater	lux	1560	397	104
		fc	145	36.9	9.7
	Abovewater	lux	627	163	43
		fc	58.3	15.2	4
5600K	Underwater	lux	1620	415	109
		fc	151	38.5	10.1
	Abovewater	lux	625	164	43.2
		fc	58.1	15.3	4
6500K	Underwater	lux	1660	422	109
		fc	154	39.2	10.1
	Abovewater	lux	642	171	44.6
		fc	59.7	15.9	4.2
7500K	Underwater	lux	1650	418	109
		fc	153	38.8	10.1
	Abovewater	lux	636	167	45
		fc	59.1	15.5	4.2
8500K	Underwater	lux	1610	407	107
		fc	149	37.8	9.9
	Abovewater	lux	656	172	45.2
		fc	61	16	4.2
10000K	Underwater	lux	1800	447	116
		fc	167	41.5	10.8
	Abovewater	lux	702	177	47.1
		fc	65.3	16.4	4.4

**WT40R**

CCT	Mode	Illuminance Unit	0.5m	1m	2m
1800K	Underwater	lux	1940	503	146
		fc	181	46.8	13.6
	Abovewater	lux	578	152	43
		fc	53.7	14	4
2800K	Underwater	lux	2850	754	206
		fc	265	70	19.1
	Abovewater	lux	801	222	59.8
		fc	74.4	20.6	5.6
3200K	Underwater	lux	3300	880	239
		fc	307	81.8	22.2
	Abovewater	lux	971	260	70
		fc	90.2	24.2	6.5
4300K	Underwater	lux	3550	947	255
		fc	330	87.9	23.7
	Abovewater	lux	1040	280	76.1
		fc	97	26	7
5600K	Underwater	lux	3660	981	264
		fc	340	91.1	24.5
	Abovewater	lux	1110	295	79
		fc	103	27.4	7.3
6500K	Underwater	lux	3810	1030	276
		fc	354	95.3	25.6
	Abovewater	lux	1130	302	80.7
		fc	105	28.1	7.5
7500K	Underwater	lux	3380	913	244
		fc	314	84.8	22.7
	Abovewater	lux	1030	275	73.5
		fc	95.6	25.5	6.8
8500K	Underwater	lux	3200	866	232
		fc	298	80.5	21.5
	Abovewater	lux	976	261	69.8
		fc	90.7	24.2	6.5
10000K	Underwater	lux	3220	874	232
		fc	299	81.2	21.6
	Abovewater	lux	981	262	70.1
		fc	91.1	24.3	6.5

**WT60R**

CCT	Mode	Illuminance Unit			
1800K	Underwater	lux			
		fc			
	Abovewater	lux			
		fc			
2800K	Underwater	lux			
		fc			
	Abovewater	lux			
		fc			
3200K	Underwater	lux			
		fc			
	Abovewater	lux			
		fc			
4300K	Underwater	lux			
		fc			
	Abovewater	lux			
		fc			
5600K	Underwater	lux			
		fc			
	Abovewater	lux			
		fc			
6500K	Underwater	lux			
		fc			
	Abovewater	lux			
		fc			
7500K	Underwater	lux			
		fc			
	Abovewater	lux			
		fc			
8500K	Underwater	lux			
		fc			
	Abovewater	lux			
		fc			
10000K	Underwater	lux			
		fc			
	Abovewater	lux			
		fc			

All the above testings are conducted under the condition of 100% brightness.

## Technical Data

Model	WT25R	WT40R	WT60R
Power supply	5V/2.5A, 9V/1.5A, 12V/1A, 15V/0.8A, 20V/0.75A	5V/3A, 9V/3A, 12V/3A, 15V/2.7A, 20V/2A	20V/3.25A
Power underwater	Max.20W	Max.55W	Max.77W
Power abovewater	Max.7W	Max.15W	Max.14W
Charging port	Type-C	Type-C	DC input port
CCT	1800K-10000K		
TLCI	≥96		
CRI	≥96		
Brightness adjust ment range	0%-100%		
Mode	CCT Mode/HSI Mode /RGBW Mode /GEL Mode /FX Mode		
Water proof rate	IP68 (40 meters underwater)		
Charging time	2h10min at the soonest	2h20min at the soonest	2h at the soonest
Battery life (100% brightness)	≈1h (underwater) ≈3h (abovewater)	≈1.5h (underwater) ≈5.8h (abovewater)	≈2h (underwater) ≈10h (abovewater)
Control Method	Bluetooth APP control		
Bluetooth control distance	≈25m (only abovewater)		
Working environment temperature	-10°C~40°C		
Dimension	57mm*53mm*250mm	57mm*53mm*380mm	57mm*53mm*640mm
Net Weight	0.66kg	1.1kg	1.9kg

Specification and data may subject to changes without notice.

## FCC Statement

This device complies with part 15 of the FCC Rules. Operation is subject to the following two conditions:

- (1) This device may not cause harmful interference, and
- (2) This device must accept any interference received, including interference that may cause undesired operation.

Any Changes or modifications not expressly approved by the party responsible for compliance could void

the user's authority to operate the equipment.

Note: This equipment has been tested and found to comply with the limits for a Class B digital device, pursuant to part 15 of the FCC Rules. These limits are designed to provide reasonable protection against harmful interference in a residential installation. This equipment generates uses and can radiate radio frequency energy and, if not installed and used in accordance with the instructions, may cause harmful interference to radio communications. However, there is no guarantee that interference will not occur in a particular installation. If this equipment does cause harmful interference to radio or television reception, which can be determined by turning the equipment off and on, the user is encouraged to try to correct the interference by one or more of the following measures:

- Reorient or relocate the receiving antenna.
- Increase the separation between the equipment and receiver.
- Connect the equipment into an outlet on a circuit different from that to which the receiver is connected.
- Consult the dealer or an experienced radio/TV technician for help.

The device has been evaluated to meet general RF exposure requirement.

The device can be used in portable exposure condition without restriction.

## ▲ Warning

Operating frequency:2402MHz – 2480MHz  
WT40R Maximum EIRP Power: 6.90dBm  
WT25R Maximum EIRP Power: 6.57dBm  
WT60R Maximum EIRP Power: 5dBm

### Declaration of Conformity:

GODOX Photo Equipment Co.,Ltd. hereby declares that this equipment are in compliance with the essential requirements and other relevant provisions of Directive 2014/53/EU. In accordance with Article 10(2) and Article 10(10), this product is allowed to be used in all EU member states For more information of DoC, Please click this web link:[https://www.godox.com/DOC/GoDox\\_WT25R\\_WT40R\\_WT60R\\_DOC.pdf](https://www.godox.com/DOC/GoDox_WT25R_WT40R_WT60R_DOC.pdf). The device complies with RF specifications when the device used at 0mm from your body.

### IC Warning

This device complies with Industry Canada's licence-exempt RSSs. Operation is subject to the following two conditions:

- (1) This device may not cause interference; and
- (2) This device must accept any interference, including interference that may cause undesired operation of the device.

This equipment complies with IC radiation exposure limits set forth for an uncontrolled environment.

This equipment should be installed and operated with minimum distance 20cm between the radiator & your body.

Cet appareil est conforme aux CNR exemptes de licence d'Industrie Canada. Son fonctionnement est soumis aux

deux conditions suivantes :

- ( 1 ) Ce dispositif ne peut causer d'interférences ; et
- ( 2 ) Ce dispositif doit accepter toute interférence , y compris les interférences qui peuvent causer un mauvais fonctionnement de l'appareil.

Ce matériel est complété par une exposition de rayonnements IC pour un environnement naturel. Ce matériel doit

être installé et se faire avec une distance minimale de 20cm entre les radiateurs et les autresYour body shop.

## 产品保修

尊敬的用户, 本保修卡是申请保修服务的重要凭证, 请您配合销售商填写并妥善保管, 谢谢!

产品信息	型号	产品条码
用户信息	姓名	联系电话
	通信地址	
销售商信息	名称	
	联系电话	
	通信地址	
	销售日期	
备注		

注: 此表应由销售商盖章确认。

### 产品信息

本文件适用于相关《产品保修信息》(见后面说明)所列产品, 其他非属此范围的产品或部件(如促销品、赠品及其他出厂后附加的部件等)不在此保修承诺内。

### 保修期

产品及部件的相应保修期按相关的《产品保修信息》执行。保修期自产品首次购买日起算, 购买日以购买产品时保修卡登记日期为准。

### 如何获得保修服务

您可直接与产品销售商或授权服务机构联系, 也可拨打神牛产品售后服务电话, 与我们联系, 由我们的服务人员为您安排服务。申请保修时, 您应提供有效的保修卡作为保修凭证, 方可获得保修。如您不能提供有效的保修卡, 则在我们确认产品或部件属于保修范围的情况下, 也可以为您提供保修, 但这不作为我们的义务。

### 不适用保修的情况

如产品存在下列情况, 本文件项下的保证和服务将不适用: ①产品或部件超过相应保修期; ②错误或不适当使用、维护或保管导致的故障或损坏, 如: 不当搬运; 非按产品合理预期用途使用; 不当插接外接设备; 跌落或外力挤压; 接触或暴露于不适当温度、溶剂、酸碱、水浸或潮湿环境; ③由非神牛授权机构或人员安装、修理、更改、添加或拆卸造成的故障或损坏; ④产品或部件原有识别信息被修改变更或删除; ⑤无有效保修卡; ⑥使用非合法授权、非标准或非公开发行的软件造成的故障或损坏; ⑦因不可抗力或意外事件造成的故障或损坏; ⑧其他非因产品本身质量问题导致的故障或损坏。遇上述情况, 您应向相关责任方寻求解决, 神牛对此不承担任何责任。因非在保修期或保修范围内的部件、附件或软件导致产品不能正常使用的, 不是保修范围内的故障。产品使用过程中正常的脱色, 磨损和消耗, 不是保修范围内的故障。

## 产品保修和服务支持信息

产品的保修期和服务类型按以下《产品保修信息》执行:

产品类别	选件名称	保修期(月)	保修服务类型
部件	主机	12	客户送修
	电池	3	客户送修
	充电器等带电性能的部件。	12	客户送修
其他	如电源线、同步线闪光管、造型灯泡、外壳、保护罩、锁紧装置、包装等。	无	无保修

神牛产品售后服务电话 0755-29609320-8062



## Warranty

Dear customers, as this warranty card is an important certificate to apply for our maintenance service, please fill in the following form in coordination with the seller and safe-keep it. Thank you!

Product Information	Model	Product Code Number
Customer Information	Name	Contact Number
	Address	
Seller Information	Name	
	Contact Number	
	Address	
	Date of Sale	
Note		

Note: This form shall be sealed by the seller.

### Applicable Products

The document applies to the products listed on the Product Maintenance Information (see below for further information). Other products or accessories (e.g. promotional items, giveaways and additional accessories attached, etc.) are not included in this warranty scope.

### Warranty Period

The warranty period of products and accessories is implemented according to the relevant Product Maintenance Information. The warranty period is calculated from the day (purchase date) when the product is bought for the first time, and the purchase date is considered as the date registered on the warranty card when buying the product.

### How to Get the Maintenance Service

If maintenance service is needed, you can directly contact the product distributor or authorized service institutions. You can also contact the Godox after-sale service call and we will offer you service. When applying for maintenance service, you should provide valid warranty card. If you cannot provide valid warranty card, we may offer you maintenance service once confirmed that the product or accessory is involved in the maintenance scope, but that shall not be considered as our obligation.

### Inapplicable Cases

The guarantee and service offered by this document are not applicable in the following cases: ① **The product or accessory has expired its warranty period;** ② **Breakage or damage caused by inappropriate usage, maintenance or preservation, such as improper packing, improper usage, improper plugging in/out external equipment, falling off or squeezing by external force, contacting or exposing to the improper temperature, solvent, acid, base, flooding and damp environments, etc;** ③ **Breakage or damage caused by non-authorized institution or staff in the process of installation, maintenance, alternation, addition and detachment;** ④ **The original identifying information of product or accessory is modified, alternated, or removed;** ⑤ **No valid warranty card;** ⑥ **Breakage or damage caused by using**

**illegally authorized, nonstandard or non-public released software;** ⑦ **Breakage or damage caused by force majeure or accident;** ⑧ **Breakage or damage that could not be attributed to the product itself.** Once met these situations above, you should seek solutions from the related responsible parties and Godox assumes no responsibility. The damage caused by parts, accessories and software that beyond the warranty period or scope is not included in our maintenance scope. The normal discoloration, abrasion and consumption are not the breakage within the maintenance scope.

## Maintenance and Service Support Information

The warranty period and service types of products are implemented according to the following Product Maintenance Information:

Product Type	Name	Maintenance Period(month)	Warranty Service Type
Parts	Circuit Board	12	Customer sends the product to designated site
	Battery	3	Customer sends the product to designated site
	Electrical parts e.g. battery charger, etc.	12	Customer sends the product to designated site
Other Items	Flash tube, power cord, sync cable, modeling lamp, lamp body, lamp cover, locking device, package, etc.	No	Without warranty

Godox After-sale Service Call +86-755-29609320(8062)