

GODOX设计文件图注

项目名称	RGB 灯条		
项目类型	<input type="checkbox"/> 彩盒 <input type="checkbox"/> 彩卡 <input type="checkbox"/> 白盒 <input type="checkbox"/> 贴纸 <input checked="" type="checkbox"/> 说明书 <input type="checkbox"/> 内托 <input type="checkbox"/> 胶盒 <input type="checkbox"/> 吸塑 <input type="checkbox"/> 其他:		
产品料号	705-TL1200-00	版本	A
展开尺寸(mm)		成品尺寸(mm)	100x140mm
尺寸公差	±2mm		
材质	105G铜版纸		
工艺说明	骑马钉		
备注/色值	单色, 黑色印刷		
设计师	陈正丰	校对	杨入人

改

705-TL1200-00



扫二维码即可下载
“Godox Light”手机APP

Scan the QR code directly to download the
"GodoxLight" smartphone APP

合格证
QC PASS

深圳市神牛摄影器材有限公司

地址: 深圳市宝安区福海街道塘尾社区耀川工业区厂房2栋
电话: 0755-29609320(8062) 传真: 0755-25723423 邮箱: godox@godox.com

GODOX Photo Equipment Co., Ltd.

Add: Building 2, Yaochuan Industrial Zone, Tangwei Community, Fuhai Street, Bao'an District, Shenzhen 518103, China Tel: +86-755-29609320(8062)
Fax: +86-755-25723423 E-mail: godox@godox.com

godox.com Made in China



Godox

TL120

RGB Tube Light 条灯

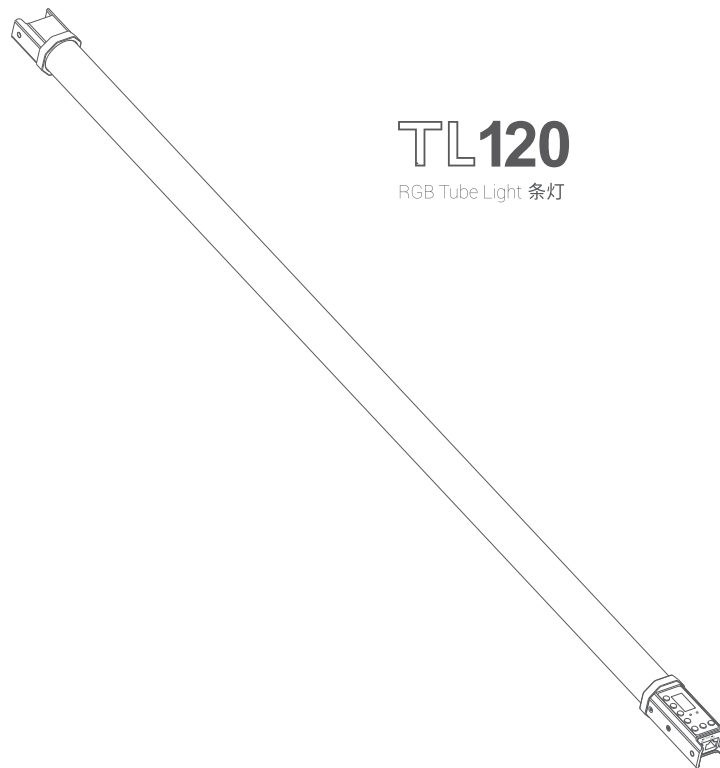

Instruction Manual 说明手册

加深, 模糊

前言

感谢您购买神牛产品!

RGB条灯TL120是一款双色温,红(R),绿(G),蓝(B),高亮度,多功能常亮灯,适用于任何场景:直播、野外露营、自拍、静物拍摄、化妆照明、视频录播、婚纱摄影、儿童拍摄及有限空间内补光、轻松动感补光等。多种遥控方式,操作便捷。

产品有以下亮点:

- 一灯多用,随心切换LED双色温模式、彩光模式和39种情景光效模式
- 自由调节色温、亮度、色相和色彩饱和度
- 跟随音乐跳动并变换颜色,营造多彩氛围
- 多灯联控,手机APP/2.4G无线/DMX控制
- 随心组合,打造各类创意灯光造型组

警告

- ⚠ 请保持干燥:请勿用湿手接触产品,亦不可将产品浸入水中或暴露于雨中。
- ⚠ 请勿私自拆卸产品,如产品出现故障须由本公司或授权的维修人员进行检查维修。请勿让儿童接触本产品。
- ⚠ 本产品不能防水,在雨天及潮湿环境下请注意防水。
- ⚠ 请勿在化学品、可燃性气体或其他特殊物质附近使用摄影灯。在这些场合下,请注意相关警告标识。
- ⚠ 内置锂电池,禁止拆卸、撞击、挤压或投入火中,若出现严重鼓胀,请勿继续使用。
- ⚠ 请勿放置在超过40°C的高温环境中。使用原配适配器充电,并且正确的按照操作说明,在规定的电压、温度范围内使用。

部件名称

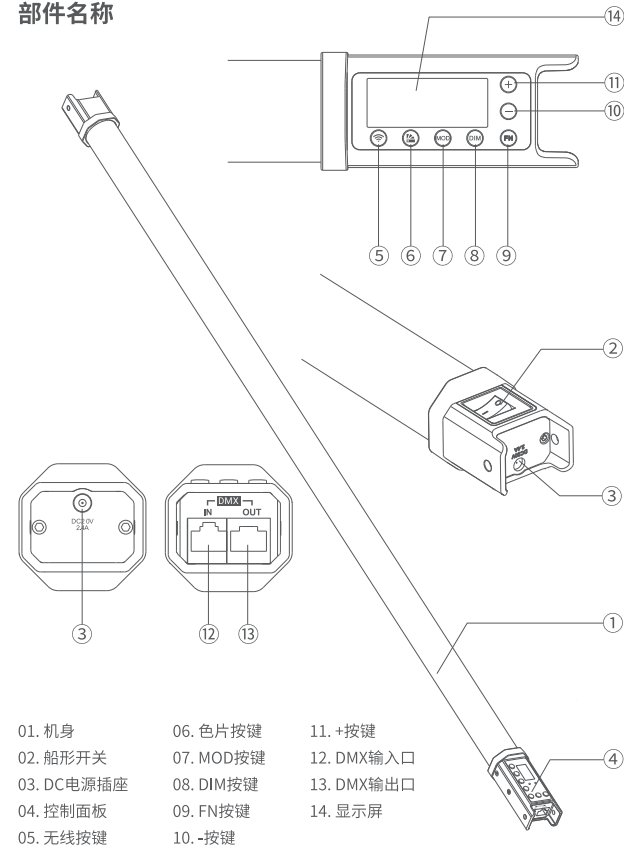

标配物品



灯体 *1



5米电源线 *1



适配器 *1



RJ45接口主从线 *1



固定夹 *2



钢丝绳 *2

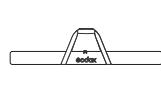

便携包CB46 *1



说明书 *1

四灯套装物品清单



灯体 *4



5米电源线 *4



适配器 *4



RJ45接口主从线 *4



固定夹 *8



钢丝绳 *8



适配器固定底座*4



遥控器(RC-R9)*1

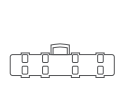

箱包CB48*1



说明书 *1

CB47

可选购附件

大功率适配器TL-A120、DC电源线、格栅、两灯灯架TL-B2、四灯灯架TL-B4、八灯灯架TL-B8

TL-G120 TL-B8

电源管理 排漏了一个大标题

1. 供电

内置锂电池，充满一次电100%亮度持续常亮约2.5H。也能直接用适配器连接电源使用。

2. 充电

充电时间约2.5H。充电时显示屏电池符号格数跳动，充满电电池显示满格。

TL-G120

功能使用操作说明

1. 开关机

使用船形开关控制机子的打开和关闭，LCD显示主机当前信息。

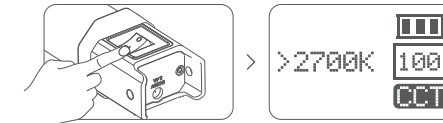

2. 模式选择：双色温模式/彩光模式/光效模式

按MOD按钮切换模式：



显示屏上显示为CCT即为双色温模式。

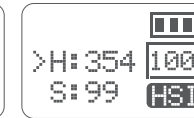

显示HSI即为彩光模式。



显示FX即为情景光效模式。

2.1 双色温模式：

2.1.1 色温调节：直接按“+”或“-”调节色温，调节范围2700K~6500K。

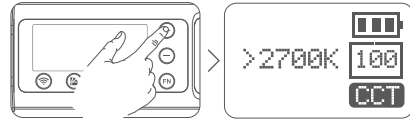

2.1.2 亮度调节: 按DIM后按“+”或“-”调节亮度, 调节范围0~100。

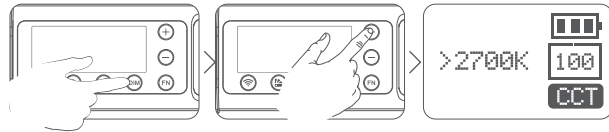

2.2 彩光模式:

2.2.1 调节色相H: 按FN按键选中H, 再按“+”或“-”调节色相, 色相调节范围0~360°。

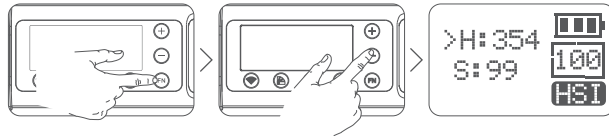

2.2.2 调节饱和度S: 按FN按键选中S, 再按“+”或“-”调节饱和度, 饱和度调节范围0-100。

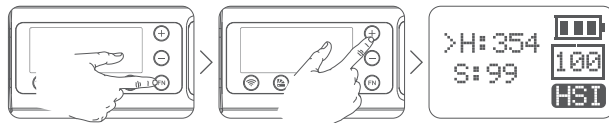

3. 情景光效模式(39种):

3.1 按“+”或“-”选择光效模式类别, 1~14类可选, 拨动拨轮循环出现。

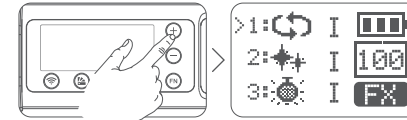

3.2 选中后按FN按键可选择当前类别中的模式: I、II、III 3种模式, 按FN按键循环出现。

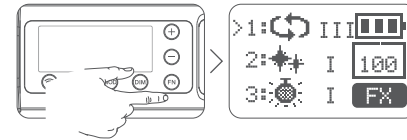

3.3 情景光效模式有14类共39种: 可根据需求选择

序号	显示	场景	显示 I	显示 II	显示 III
1	[circular arrow icon]	彩光循环	慢速	中速	快速
2	[starburst icon]	闪光灯	闪光	发布会	狗仔队
3	[laser icon]	激光彩灯	生日会	KTV	迪斯科
4	[lightning bolt icon]	雷闪电	间歇	频繁	持续
5	[light bulb icon]	环灯泡	间歇	频繁	持续
6	[TV icon]	电视机	慢速	中速	快速
7	[candle icon]	蜡烛	间歇	频繁	持续
8	[fire icon]	火花	柴火	篝火	火灾
9	[fireworks icon]	烟花	短暂	连续	演出
10	[police icon]	警车	暴闪	频闪	快闪
11	[fire truck icon]	消防车	暴闪	频闪	快闪
12	[ambulance icon]	救护车	暴闪	频闪	快闪
13	[music icon]	音乐	音乐 I	音乐 II	
14	[SOS icon]	SOS			

4. 控制模式选择:

蓝牙控制/2.4G无线遥控/DMX控制

按无线按键, 再按“+”或“-”按键选择控制模式, 选好模式后按FN按键或无线按键进入对应的设置界面, 按无线按键或其他按键退出设置界面。

4.1 蓝牙设置 排漏了一个大标题

4.1.1 开关蓝牙：按FN按键选中蓝牙，按“+”或“-” 按键开关蓝牙，显示ON为开，显示OFF为关。打开蓝牙时，指示灯显示蓝色。

4.1.2 蓝牙初始化：按FN按键选中RESET，按“+”或“-” 对蓝牙进行重置。

4.1.3 蓝牙号：MAC: XXXX，为本机蓝牙号。

4.2.2 4G无线设置：

TL120 RGB条灯具备无线遥控功能，可另购遥控器RC-R9进行无线遥控，使用2.4G无线技术，可同时分别控制6组灯，32个频道，99个无线ID，抗干扰强。

4.2.1 开关2.4G无线：

按FN按键选中无线图标，按“+”或“-” 按键开关2.4G无线，ON为打开(无线指示灯亮绿灯)，OFF为关闭(无线指示灯灭)。

4.2.2 频道设置：

按FN按键选中CH，按“+”或“-” 按键设置频道，可选频道32个(1~32)。

4.2.3 组别设置：

按FN按键选中GR，按“+”或“-” 按键设置的组别，可选组别6组(A~F)。

4.2.4 ID设置：

按FN按键选中ID，按“+”或“-” 按键设置的ID，可选ID有99个(OFF,1~99)。

注：蓝牙和2.4G同时打开时，指示灯显示青色。

使用前请把RGB条灯与遥控器的频道(CH)，组别(GR)，ID设为一致。RGB条灯在开机的状态下才能接收无线信号。

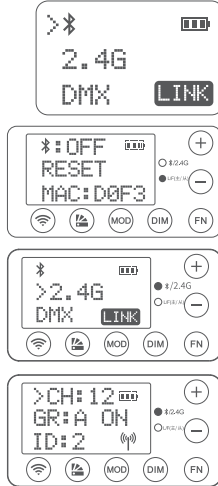

4.3. DMX控制台模式

4.3.1. 将灯设置从属模式FOLLOW，按FN按键选择ADD。

4.3.2. 按“+”或“-” 按键设置ADD，可选ADD有512个(001~512)，此时主从灯指示灯显示为蓝色。

4.3.3. 设置好ADD后用DMX连接线一端连接控制台DMX输出口，一端连接灯DMX输入口。

4.3.4. 控制台发送数据内容请参照下表：

运行模式 通道(ADD)	CCT	HSI	RGBW	FX	Filters	
n	0-52	52-103	104-155	156-207	208-255	
n+1	0-100 0-100% 亮度调节	0-100 0-100% 亮度调节	0-100 0-100% 亮度调节	0-100 0-100% 亮度调节	0-100 0-100% 亮度调节	
n+2	0-255 色温选择	0-180 H=180° 色相选择	0-255 红光强度	0-17: RGB循环 36-53: 迪斯科 72-89: 棒灯炮 108-125: 蜡烛 144-161: 烟花 180-197: 消防车 216-233: 音乐	18-35: 闪光灯 54-71: 闪电 90-107: 电视效果 126-143: 火把 162-179: 警车 198-215: 救护车 234-255: SOS	0-127: R色片 128-255: L色片
n+3	0-100 饱和度 设置	0-255 绿光强度	0-255 蓝光强度	0-85: 光效档位 I 86-171: 光效档位 II 172-255: 光效档位 III	0-255(L/R)色片切换 (每13个值对应一种色片)	
n+4			0-255 白光强度			
n+5						

4.4. DMX接口主从模式

4.4.1. 将一台灯设置为LEAD模式。

4.4.2. 将其他灯设置为FOLLOW模式(无需设置ADD)。

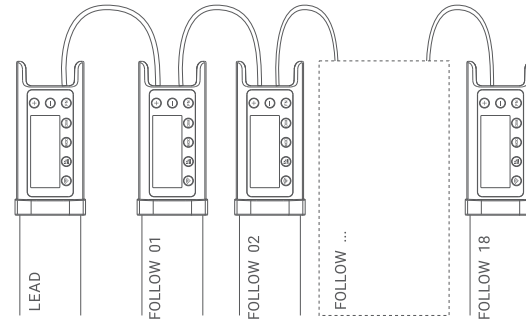

4.4.3. 用RJ45连接线将灯连接起来。

4.4.4. 处于FOLLOW模式下的灯将与LEAD模式下的灯自动同步。



备注：DMX接口使用主从灯控制时，从灯的数量不能超过18盏灯。

5. 色片设置:

按色片  按钮进入色片设置界面, 按 “+” 或 “-” 按键选择R-GEL色片组或L-GEL色片组, 再按  进入色片组里面选相应的色片, R-GEL和L-GEL色片组里面分别有20种色片可选, 总共40种。

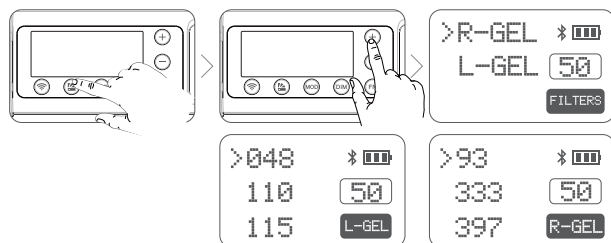

6. 连接手机APP

1. 将TL120蓝牙设置为ON。

2. TL120的灯体上有二维码的图片, 直接扫二维码即可下载“Godox Light”手机APP(安卓和苹果系统都可以使用)。

具体操作请参考手机APP“帮助”手册。

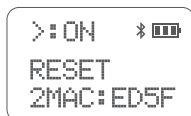

照度数据

色温值	光照单位	1m	2m	3m
2800K	lux	659	202	101
	fc	61.2	18.8	9.4

3200K	lux	610	187	93.3
	fc	56.7	17.4	8.7
4300K	lux	666	205	102
	fc	61.9	19	9.5
5600K	lux	685	210	104
	fc	63.7	19.5	9.7
6500K	lux	769	234	117
	fc	71.3	21.7	10.9

产品参数

型号	TL120
内置锂电池供电	14.4V/5200mAh/74.88Wh
适配器	输出20V/4.8A
功率	30W
频道	32个
组别	6组(A B C D E F)
色温范围	2700K~6500K
调光范围	0%~100%
RGB 色域	0~360°
CRI(≈)	96
TLCI(≈)	98
持续使用时间 (2700K 100%亮度) ≈	110 180分钟
控制方式	手机APP/2.4G无线遥控/DMX控制
蓝牙无线控制距离	≈30米
2.4无线控制距离	≈50米(另购遥控器RC-R9)
工作环境温度	-10~40°C
产品尺寸	直径48*1170mm
重量	1.27kg

* 设计和规格如有变更, 恕不另行通知。

维护保养

- 为了防止灰尘的堆积影响到产品的性能, 请定时用干净的湿布轻轻擦拭产品 外部。
- 1年保修, 消耗品电池, 适配器, 电源线等配件不在此保修范围内。
- 对于不规范操作引起的机器故障不在保修范围内。
- 所有维修概由本厂指定可供原厂配件之维修部负责。
- 经发现, 擅自检修本品, 将取消一年保修期, 维修需要收取相关费用。
- 如果本品出现故障或者被水淋湿, 在专业人员维修后方可继续使用。
- 如有技术更改, 恕不另行通知。

本设备包含型号核准代码为: CMIIT ID:2020DP13510, 为该产品的无线电发射模块。

Foreword

Thank you for purchasing this Godox Product!

This RGB Tube Light TL120 is a multifunctional RGB light with dual color temperature, ~~and~~ high light brightness ~~and wireless adjustment~~. Suitable for almost all shooting occasions e.g. live, camping, make up, portrait shooting, ~~make up, video~~, wedding, children photography, etc. It's portable and easy to be operated.

Features: Bi-color

Freely switch LED ~~CCT~~ mode, RGB mode and 39 special effects modes

Easy to adjust color temperature, ~~light~~ brightness, hue and color saturation ~~and~~

~~Change~~ change colors with the rhythm of music

Control by smartphone APP/2.4G wireless/DMX

Use in combination to make more creative light groups

⚠ Warning

- ⚠ Always keep this product dry. Do not use in rain or in damp conditions.
- ⚠ Do not disassemble. Should repairs become necessary, this product must be sent to an authorized maintenance center.
- ⚠ Keep out of reach of children.
- ⚠ As this product do not have waterproof function, please take measures of waterproof in rainy or damp environment.
- ⚠ Do not use the flash unit in the presence of flammable gases, chemicals and other similar materials. In certain circumstance, these materials may be sensitive to the strong light emitting from this flash unit and fire or electromagnetic interference may result.
- ⚠ As this product has built-in lithium battery, do not disassemble, impact, squeeze or put it into fire. If serious bulge occurs, please do not use. Do not use or store the product if the ambient temperature reads over 40°C. Please charge the product with included adapter and correctly operate it within the defined voltage and working temperate according to the instruction manual.

Names of Parts

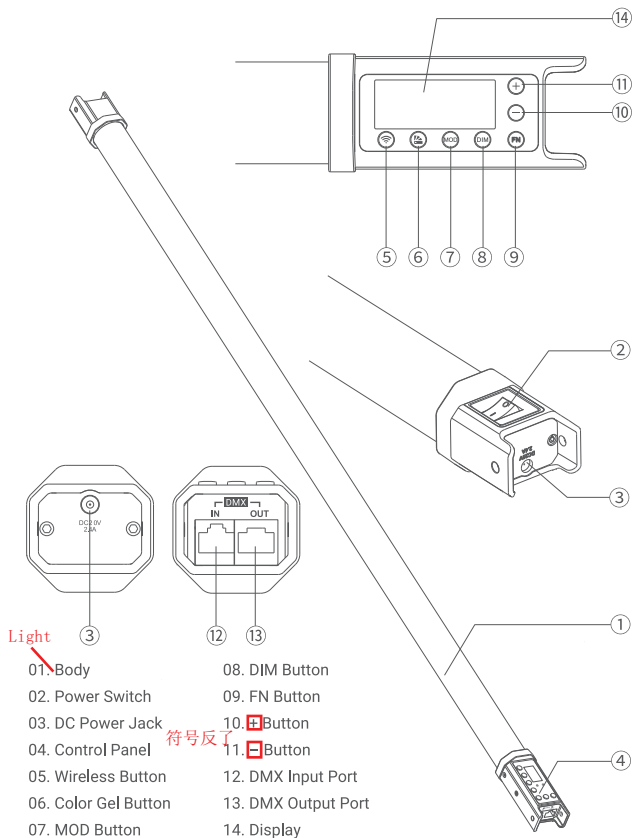

- 01. Body
- 02. Power Switch
- 03. DC Power Jack
- 04. Control Panel
- 05. Wireless Button
- 06. Color Gel Button
- 07. MOD Button
- 08. DIM Button
- 09. FN Button
- 10. Button
- 11. Button
- 12. DMX Input Port
- 13. DMX Output Port
- 14. Display

符号反了

What's in the Box

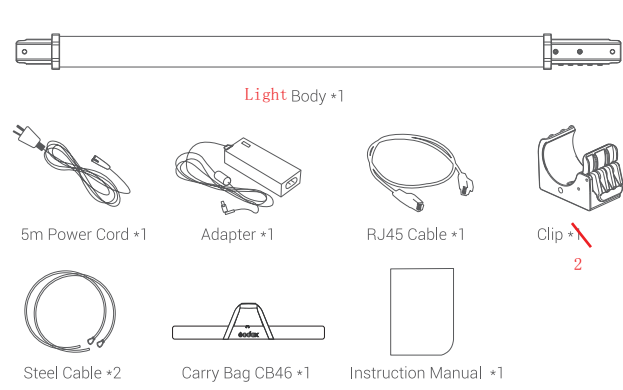

Four-light kit:

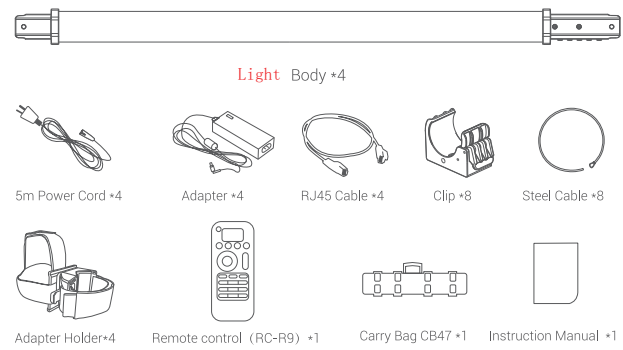

Optional Accessories

Adapter TL-A120, DC Power Cable, Grid TL-G120, Two-light Bracket TL-B2, Four-light Bracket TL-B4, Eight-light Bracket TL-B8

Battery Management

1. Power Supply

The built-in lithium battery can offer about 2.5 hours' lighting in 100% brightness once got fully charged.

The light can also put into usage by connecting the adapter to power source.

2. Charge

The whole charging takes about 2.5 hours. The charge grids indicator will be blinking in charging while displaying full grids once got fully charged.

Operation

1. Power Switch

Use the power switch to control the on or off of the RGB tube light. Then, the current information will be displayed on the LCD panel.

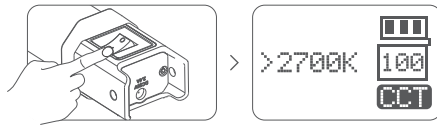

Bi-color

2. Mode Selection: ~~CCT~~ Mode/RGB Mode/Special Effects Mode

Press MOD button to switch different modes:



CCT displayed on the screen means ~~CCT~~ mode
Bi-color



HSI displayed on the screen means RGB mode

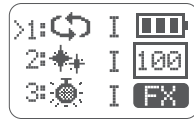

FX means special effects mode

Bi-color

2.1 ~~Bi-color~~ Mode

2.1.1 Color temperature adjustment: press the "+" or "-" button to adjust the color temperature from 2700K to 6500K.

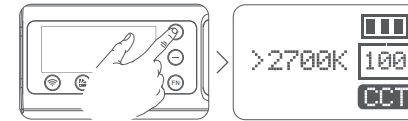

Brightness adjustment:

2.1.2 Press the DIM button, then, press the "+" or "-" button to adjust the brightness from 0 to 100.

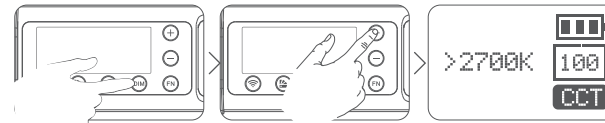

RGB

2.2 ~~Colorful~~ Mode

2.2.1 Adjust hue H: press the FN Button and H is selected. Then, press the "+" or "-" button to adjust the hue from 0 to 360°.

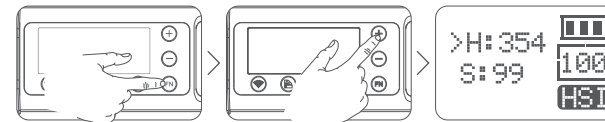

2.2.2 Adjust saturation S: press the FN Button dial and S is selected. Then, press the "+" or "-" button to adjust the saturation from 0 to 100.

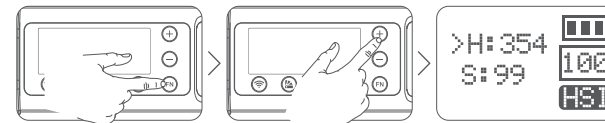

3. Special Effects Modes (39)

3.1 Press the "+" or "-" button to choose different special effects categories from 1 to 14. And the modes will display circularly by turning the select dial.

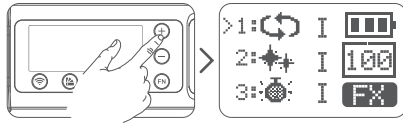

3.2 After choosing the current mode, press down the FN Button from I, II and III. And the modes will display circularly when keeping pressing the FN Button.

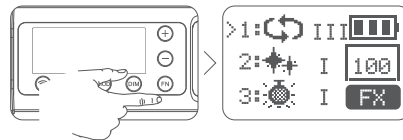

3.3 There're 39 kinds of situational special effects mode which are divided into 14 categories for your choice.

No.	Display	Situation	Display I	Display II	Display III
1		RGB cycle	Slowspeed	Mediumspeed	Quickspeed
2		Flash	Flash	Pressconference	Paparazzi
3		Laser	Birthdayparty	TV	Disco
4		Lightning	Discontinuous	Frequent	Sustainable
5		Broken bulb	Discontinuous	Frequent	Sustainable
6		TV	Slowspeed	Mediumspeed	Quickspeed
7		Candle	Discontinuous	Frequent	Sustainable
8		Fire	Firewood	Campfire	Firehazard
9		Firework	Brief	Continuous	Show
10		Police car	Strongflash	Frequentflash	Quickflash
11		Fire truck	Strongflash	Frequentflash	Quickflash
12		Ambulance	Strongflash	Frequentflash	Quickflash
13		Music	Music I	Music II	
14		sos			

加空格

加空格

另起一段

4. Control Modes Selection: Bluetooth/2.4G Wireless Remote Control/DMXControl

Press the wireless button firstly, then, press the "+" or "-" button to choose the control mode. After choosing the mode, press the FN or wireless button to enter the relevant setting interface. Press the wireless button or other button to exit the setting interface.



4.1 Bluetooth Setting

4.1.1 Bluetooth switch: press the FN button to select the Bluetooth. Then, press the "+" or "-" button to switch on or off. If "ON" is displayed, the Bluetooth is on and "OFF" means off. When the Bluetooth is on, the indicator will turn to blue.



4.1.2 Initialize the Bluetooth password: press the FN button to select RESET. Then, press the "+" or "-" button to reset the Bluetooth.

4.1.3 Bluetooth Number: MAC: xxxx is the Bluetooth number of this light.

4.2 2.4G Wireless Setting

With 2.4G wireless system, TL120 RGB tube light has remote grouping and control function. It is recommended to purchase RC-R9 remote control (optional) to achieve wireless control. Up to 6 groups of LED lights can be controlled. 32 channels and 99IDs are available with strong anti-interference capability.



4.2.1 2.4G Wireless switch: press the FN button to select the wireless icon. Then, press the "+" or "-" button to switch on or off 2.4G wireless. "ON" means 2.4G wireless is turned

on (wireless indicator is lightened green), "OFF" means turned off (wireless indicator is put off).

4.2.2 Chanel setting: press the FN button to select CH. Then, press the "+" or "-" button to select 32 channels from 1 to 32.

4.2.3 Group setting: press the FN button to select GR. Then, press the "+" or "-" button to select 6 groups from A to F.

4.2.4 ID setting: press the FN button to select ID. Then, press the "+" or "-" button to select 99 IDs from 1 to 99.

Note: When opening the Bluetooth and 2.4G simultaneously, the indicator will turn to cyan. Please make LED light's channel, group and ID to the same as remote control's. The RGB tube light can only receive wireless signals in powered-on status.

4.3 DMX Control Modes

4.3.1. Set the light to FOLLOW mode and press FN button to choose ADD.

4.3.2. Press the "+" or "-" button to set 512 ADDs from 001 to 512. ~~Now~~ the indicator will display blue.
 , 逗号

4.3.3. After set ADD, connect one end of the DMX cable to DMX output port of control center and the other end to DMX input port of the light.

4.3.4. The statistics sent by the control center are as follows:

Mode Channel (ADD)	CCT	HSI	RGBW	FX	Filters	
n	0-52	52-103	104-155	156-207	208-255	
n+1	0-100 0-100% Brightness Adjustment	0-100 0-100% Brightness Adjustment	0-100 0-100% Brightness Adjustment	0-100 0-100% Brightness Adjustment	0-100 0-100% Brightness Adjustment	
n+2	0-255 Color Temperature Selection	0-180 H=180*2 Hue Selection	0-255 Red Light	0-17: RGB Cycle 36-53: Disco 72-89: Broken Bulb 108-125: Candle 144-161: Firework 180-197: Fire Truck 216-233: Music	18-35: Flash 54-71: Lightning 90-107: TV 126-143: Fire 162-179: Police Car 198-215: Ambulance 234-255: SOS	0-127: R-GEL 128-255: L-GEL
n+3	0-100 Saturation Setting	0-255 Green Light	0-255 Blue Light	0-85: Light Effect I 86-171: Light Effect II 172-255: Light Effect III	0-255(L-GEL/R-GEL) Colored Paper Switch (Every 13 values refers to one colored paper)	
n+4		0-255 Blue Light	0-255 White Light			
n+5						

4.4 DMX LEAD and FOLLOW mode

4.4.1. Set one of the LED lights to LEAD mode.

4.4.2. Set other lights to FOLLOW modes.

4.4.3. Connect the lights with RJ45 cable.

4.4.4. The lights in FOLLOW modes will automatically synchronize the light in LEAD mode.

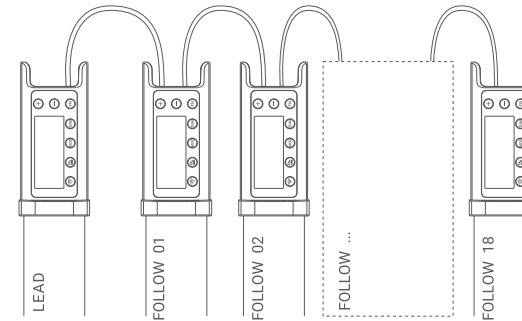

Note: When using LEAD and FOLLOW modes through DMX port, the quantity of lights in FOLLOW modes cannot be over 18.

5. Color Gel Setting

Press the color gel button to enter the interface. Then, press the "+" or "-" button to choose R-Gel or L-Gel group. Then, press the FN to enter the color gel group to select the corresponding color gel. There are both 20 color gel in R-Gel and L-Gel groups for your choice, 40 kinds in total.

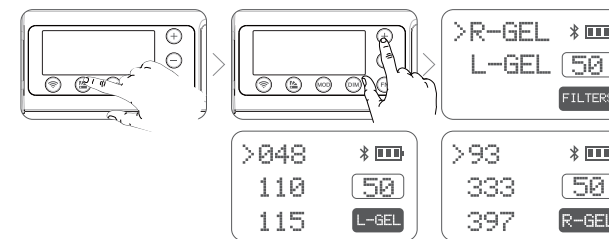

两段顺序换一下

6. Connect with Smartphone APP

2. As there is a QR code on the light body of TL120, please scan the QR code directly to download the "GodoxLight" smartphone APP(can be used by Android and Apple system).

For more smartphone APP operations, please open the "help" in APP to gain detailed guidance.

2. Set the Bluetooth of TL120 to ON.

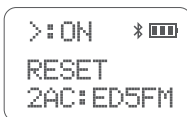

Illuminance Testing Data

CCT	Illumination Unit	1m	2m	3m
2800K	lux	659	202	101
	fc	61.2	18.8	9.4
3200K	lux	610	187	93.3
	fc	56.7	17.4	8.7
4300K	lux	666	205	102
	fc	61.9	19	9.5
5600K	lux	685	210	104
	fc	63.7	19.5	9.7
6500K	lux	769	234	117
	fc	71.3	21.7	10.9

Technical Data

LED Light	TL120
Built-in Lithium Battery	14.4V/5200mAh/74.88Wh
Adapter	Output 20V/4.8 20V/4.8A
Power	30W
Channel	32
Group	6(A B C D E F)
Color Temperature Range	2700K~6500K
Light Brightness Range	0%~100%
RGB Color Gamut	0 ~ 360°
CRI (≈)	96
TLCI (≈)	98
Duration(continuous output in 100% full power in 2700K) ≈	Approx. 100 170 minutes
Control Method	Smartphone APP/2.4G wireless/DMX control
Bluetooth Wireless Control Distance	≈30m
2.4G Wireless Control Distance	≈50m(with optional RC-R9 remote control)
Operation Temperature	-10~40 °C
Dimension	48*1170mm
Net Weight	1.27kg
BT Frequency Range	2402.0~2480.0MHz
Max. Transmitting Power	5dbm

* Product design and specifications are subject to change without notice.

Maintenance

This product, except consumables e.g. adapter and adapter cable, is supported with a one-year warranty.

Avoid sudden impacts and the product should be dedusted regularly.

Maintenance of the flash must be performed by our authorized maintenance department which can provide original accessories.

Unauthorized service will void the warranty.

If the product had failures or was wetted, do not use it until it is repaired by professionals.

Changes made to the specifications or designs may not be reflected in this manual.

FCC Statement

This device complies with part 15 of the FCC Rules. Operation is subject to the following two conditions: (1) This device may not cause harmful interference, and (2) this device must accept any interference received, including interference that may cause undesired operation.

Any Changes or modifications not expressly approved by the party responsible for compliance could void the user's authority to operate the equipment.

Note: This equipment has been tested and found to comply with the limits for a Class B digital device, pursuant to part 15 of the FCC Rules. These limits are designed to provide reasonable protection against harmful interference in a residential installation. This equipment generates uses and can radiate radio frequency energy and, if not installed and used in accordance with the instructions, may cause harmful interference to radio communications. However, there is no guarantee that interference will not occur in a particular installation. If this equipment does cause harmful interference to radio or television reception, which can be determined by turning the equipment off and on, the user is encouraged to try to correct the interference by one or more of the following measures:

- Reorient or relocate the receiving antenna.
- Increase the separation between the equipment and receiver.
- Connect the equipment into an outlet on a circuit different from that to which the receiver is connected.
- Consult the dealer or an experienced radio/TV technician for help.

The device has been evaluated to meet general RF exposure requirement.
The device can be used in portable exposure condition without restriction.

Declaration of Conformity:
GODOX Photo Equipment Co.,Ltd. hereby declares that the This equipment are in compliance with the essential requirements and other relevant provisions of EU Directive 2014/53/EU. They are allowed to be used in all EU member states.
For more information of DoC, Please click this web link:http://www.godox.com/DOC/Godox_TL120_DOC.pdf.

产品保修

尊敬的用户,本保修卡是申请保修服务的重要凭证,请您配合销售商填写并妥善保管,谢谢!

产品信息	型号	产品条码
用户信息	姓名	联系电话
	通信地址	
销售商信息	名称	
	联系电话	
	通信地址	
	销售日期	
备注		

注:此表应由销售商盖章确认。

适用产品

本文件适用于相关《产品保修信息》(见后面说明)所列产品,其他非属此范围的产品或部件(如促销品、赠品及其他出厂后附加的部件等)不在此保修承诺内。

保修期

产品及部件的相应保修期按相关的《产品保修信息》执行。保修期自产品首次购买日起算,购买日以购买产品时保修卡登记日期为准。

如何获得保修服务

您可直接与产品销售商或授权服务机构联系,也可拨打神牛产品售后服务电话,与我们联系,由我们的服务人员为您安排服务。申请保修时,您应提供有效的保修卡作为保修凭证,方可获得保修。如您不能提供有效的保修卡,则在我们确认产品或部件属于保修范围的情况下,也可以为您提供保修,但这不作为我们的义务。

不适用保修的情况

如产品存在下列情况,本文件项下的保证和服务将不适用 ①产品或部件超过相应保修期;②错误或不当使用、维护或保管导致的故障或损坏,如:不当搬运;非按产品合理预期用途使用;不当插拔外接设备;跌落或外力挤压;接触或暴露于不当温度、溶剂、酸碱、水浸或潮湿环境;③由非神牛授权机构或人员安装、修理、更改、添加或拆卸造成的故障或损坏;④产品或部件原有识别信息被修改变更或删除;⑤无有效保修卡;⑥使用非合法授权、非标准或非公开发行的软件造成的故障或损坏;⑦因不可抗力或意外事件造成的故障或损坏;⑧其他非因产品本身质量问题导致的故障或损坏。遇上述情况,您应向相关责任方寻求解决,神牛对此不承担任何责任。因非在保修期或保修范围内的部件、附件或软件导致产品不能正常使用的,不是保修范围内的故障。产品使用过程中正常的脱色,磨损和消耗,不是保修范围内的故障。

产品保修和服务支持信息

产品的保修期和服务类型按以下《产品保修信息》执行:

产品类别	选件名称	保修期(月)	保修服务类型
部件	电路板	12	客户送修
	电池	3	客户送修
	充电器、电源线,同步线等带电性能的部件。	12	客户送修
其他	如闪光灯管、造型灯泡、外壳、保护罩、锁紧装置、包装等。	无	无保修

神牛产品售后服务电话:0755-29609320-8062

Warranty

Dear customers, as this warranty card is an important certificate to apply for our maintenance service, please fill in the following form in coordination with the seller and safe-keep it. Thank you!

Product Information	Model	Product Code Number
Customer Information	Name	Contact Number
	Address	
Seller Information	Name	
	Contact Number	
	Address	
	Date of Sale	
Note:		

Note: This form shall be sealed by the seller.

Applicable Products

The document applies to the products listed on the Product Maintenance Information (see below for further information). Other products or accessories (e.g. promotional items, giveaways and additional accessories attached, etc.) are not included in this warranty scope.

Warranty Period

The warranty period of products and accessories is implemented according to the relevant Product Maintenance Information. The warranty period is calculated from the day(purchase date) when the product is bought for the first time, And the purchase date is considered as the date registered on the warranty card when buying the product.

How to Get the Maintenance Service

If maintenance service is needed, you can directly contact the product distributor or authorized service institutions. You can also contact the Godox after-sale service call and we will offer you service. When applying for maintenance service, you should provide valid warranty card. If you cannot provide valid warranty card, we may offer you maintenance service once confirmed that the product or accessory is involved in the maintenance scope, but that shall not be considered as our obligation.

Inapplicable Cases

The guarantee and service offered by this document are not applicable in the following cases: ①. The product or accessory has expired its warranty period; ②. Breakage or damage caused by inappropriate usage, maintenance or preservation, such as improper packing, improper usage, improper plugging in/out external equipment, falling off or squeezing by external force, contacting or exposing to the improper temperature, solvent, acid, base, flooding and damp environments, etc; ③. Breakage or damage caused by non-authorized institution or staff in the process of installation, maintenance, alternation, addition and detachment; ④. The original identifying information of product or accessory is modified, alternated, or removed; ⑤. No valid warranty card; ⑥. Breakage or damage caused by using illegally authorized, nonstandard or non-public released software; ⑦. Breakage or damage caused by force majeure or accident; ⑧. Breakage or damage that could not be attributed to the product itself. Once met these situations above, you should seek solutions from the related responsible parties and Godox assumes no responsibility. The damage caused by parts, accessories and software that beyond the warranty period or scope is not included in our maintenance scope. The normal discoloration, abrasion and consumption are not the breakage within the maintenance scope.