

Warning

- △ Do not look directly at the light source.
- △ The luminaire is intended for professional use only.
- △ Keep out of reach of children.
- △ Please take off the lamp cover before using.
- △ Do not leave or store the product if the ambient temperature reads over 40°C.
- △ Do not fire directly against human eyes as it may cause visual impairment.
- △ Please use the original power cable, damages caused by using other cables will invalid the warranty.
- △ As this product do not have waterproof function, please take measures of waterproof in rainy or damp environment.
- △ Always keep this product dry. Do not use in rain or in damp conditions.
- △ Do not use the product in the presence of flammable gases, chemicals and other similar materials.
- △ The light source contained in this luminaire shall only be replaced by the manufacturer or his service agent or a similar qualified person.
- △ Do not disassemble. Should repairs become necessary, this product must be sent to an authorized maintenance center.
- △ The lamp shall be changed if it has become damaged or thermally deformed.

Structure of Product

VL150II Light Body

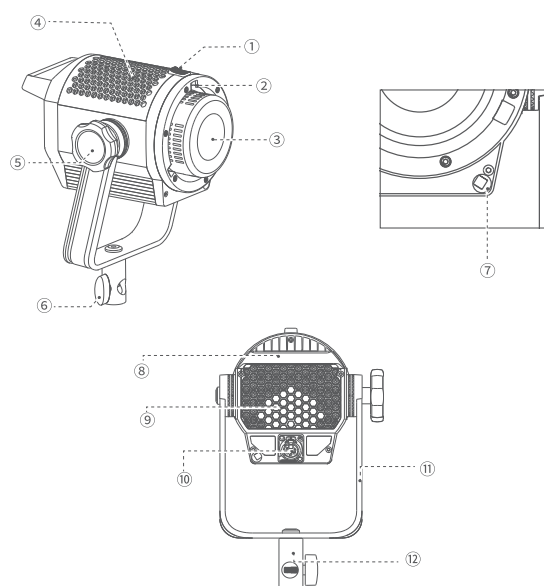

- | | |
|---------------------------|------------------------|
| 1. Accessory Locking Ring | 7. Umbrella Input |
| 2. Bowens Mount | 8. Handle |
| 3. LED Beads | 9. Thermovent |
| 4. Thermovent | 10. Power Input Socket |
| 5. Bracket Locking Ring | 11. U-type Bracket |
| 6. Bracket Sleeve Ring | 12. Bracket Sleeve |

VL150II Controller

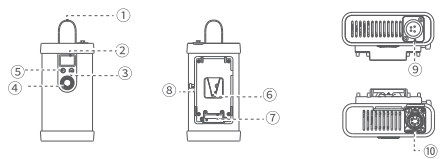

- | | |
|--|---|
| <ul style="list-style-type: none"> 1. Handle 2. LCD Panel 3. FX/⚡ Button 4. Adjust Dial 5. Power Switch | <ul style="list-style-type: none"> 6. V-port Battery Slot 7. Battery Compartment 8. Battery Locking Ring 9. DC Input Port 10. DC Output Port |
|--|---|

VL200II/VL300II Controller

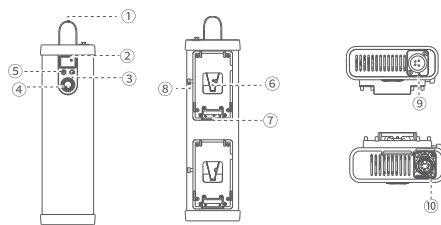

- | | |
|--|---|
| <ul style="list-style-type: none"> 1. Handle 2. LCD Panel 3. FX/⚡ Button 4. Power Switch 5. Adjust Dial | <ul style="list-style-type: none"> 6. Battery Locking Ring 7. V-port Battery Slot 8. Battery Compartment 9. DC Input Port 10. DC Output Port |
|--|---|

Included Items

Model	Included Items
VL150II	VL150II*1, Controller VLC150II*1, Reflector *1, Lamp cover *1, Connect cord*1, Adapter *1, Power cord *1, Back clip *1, Instruction Manual*1, Carry Bag CB62*1
VL200II	VL200II *1, Controller VLC200II*1, Reflector *1, Lamp cover *1, Connect cord*1, Adapter *1, Power cord *1, Back clip *1, Instruction Manual*1, Carry Bag CB63*1
VL300II	VL300II*1, Controller VLC300II*1, Reflector *1, Lamp cover *1, Connect cord*1, Adapter *1, Power cord *1, Back clip *1, Instruction Manual*1, Carry Bag CB64*1

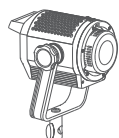

Light body VL150II/VL200II



Light body VL300II



Controller VLC150II



Controller VLC200II
VLC300II



Reflector



Lamp cover



Connect cord



Adapter



Power cord



Back clip



Instruction Manual

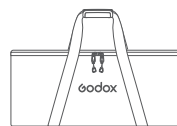

Carry Bag

Operation Instruction

1. Power on/off

Connect the adapter and controller, long press the Power Switch to power the LED light on or off.

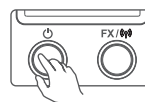

2. Mode selection: Constant on mode/FX mode

Constant on mode: The main interface is constant on mode, while the FX icon is not displayed on the left bottom of panel. Turn the adjust dial for light brightness to change the value from 0% to 100%.



FX mode: Long press FX/ button to make the FX displayed on the left bottom of panel, it is FX icon mode.

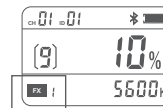

When the FX icon flashes, turn the adjust dial to select among the 8 light effects, then short press the FX/ button to confirm. Short press the FX/ button again can reselect the light effect.

Light effects table (8 types)

Display	FX1	FX2	FX3	FX4	FX5	FX6	FX7	FX8
Scenes	Flash 1	Flash 2	Flash	Storm 1	Storm 2	Storm 3	Broken bulb	TV

When the FX icon stops flashing, turn the adjust dial for light brightness to change the value from 0% to 100%.



3. 2.4GHz wireless setting

CH setting: Short press the FX/ button once to make the CH icon flashes, then turn the adjust dial to choose among 01 to 32 channels. When the CH icon stops flashing, it means CH setting completed and automatically exited, while the CH icon flashes means short pressing FX/ button 4 times can also automatically exit CH setting.



GR setting: Short press the FX/⏻ button twice to make the GR icon flashes, then turn the adjust dial to choose among A to F or 0 to 9 groups. When the GR icon stops flashing, it means GR setting completed and automatically exited, while the GR icon flashes means short pressing FX/⏻ button 3 times can also automatically exit GR setting.



ID setting: Short press the FX/⏻ button three times to make the ID icon flashes, then turn the adjust dial to choose among 01 to 99 IDs or OF. When the ID icon stops flashing, it means ID setting completed and automatically exited, while the ID icon flashes means short pressing FX/⏻ button twice can also automatically exit ID setting.



4. Power option(VL300II)

Press the power switch and FX/⏻ button at the same time in power off status to enter power option mode. Turn the adjust dial to choose power from 200, 250 and 300. The power is 300W by default. It will exit from this mode automatically without operation for 5 seconds.



Note: This function is used for the situation that the battery enter protection states and cannot work due to some v-port battery doesn't output the corresponding power in strong power output. When enter this mode, the output power of the light can be decreased and the battery can be loaded instead of being protected (this function only applies to VL300II).

5. Bluetooth control Check Bluetooth MAC code

Check Bluetooth MAC code

Short press the FX/⏻ button four times to make the Bluetooth icon and MAC code displayed, it is in Bluetooth setting interface.



Bluetooth reset

Long press the FX/⏻ button in Bluetooth setting interface to make the Bluetooth icon flashes, it means the Bluetooth is resetting. When the Bluetooth icon stops flashing means Bluetooth resetting is completed. It will exit from this mode automatically without operation for 10 seconds, short press the FX/⏻ button to exit is also available.

APP download

Scan the QR code to download the "Godox Light" mobile app. (It can be used on both Android and Apple systems)
For specific operations, please refer to the "Help" manual of the mobile APP, which contains detailed tutorials.



Note: The first mobile device (mobile phone or tablet) can directly use the APP to control the light body.
When replacing other mobile devices (mobile phones or tablets), the lamp body can be connected normally after Bluetooth reset.

Over-temperature Warning

When the light body is at a high temperature, the CCT value on the LCD panel turns to "HP", the light body still works normally.

When the light body is over-temperature, the light turns out, and "HP" flashes on the LCD panel.

When the light body changes from over-temperature state to a normal temperature state, "HP" on the LCD panel turns to the CCT value, and the light body restores its lighting.

Illuminance data

VL150II					
CCT	Testing Conditions	Illuminance Unit	1m	2m	3m
5600K	bare lamp	lux	6100	1700	810
		fc	570	160	76.0
	with reflector	lux	76000	16000	5400
		fc	7000	1500	500
VL200II					
CCT	Testing Conditions	Illuminance Unit	1m	2m	3m
5600K	bare lamp	lux	7400	2100	1100
		fc	700	190	100
	with reflector	lux	88900	19000	8000
		fc	8300	180	750

VL300II					
CCT	Testing Conditions	Illuminance Unit	1m	2m	3m
5600K	bare lamp	lux	11600	3500	1700
		fc	1100	300	160
	with reflector	lux	90000	20900	8800
		fc	8400	1950	820

* All the above tests are based on the condition of 100%brightness.

Technical Data

Model	VL150II	VL200II	VL300II
Adapter Input	AC100V-240V 50/60Hz 2A	AC100V-240V 50/60Hz 3.9A	AC100V-240V 50/60Hz 4.3A
Light Body Input	35V---4.3A	47.8V---4.2A	50V---6A
V-port battery	Standard voltage:14.8V (optional)		
Max. Power	165W	215W	320W
CCT Range	5600±200K		
CH	32		
GR	16 groups (A,B,C,D,E,F,G,H,I)		
ID	99		
CRI	≥96		
TLCI	≥96		
Brightness Adjustment Range	0% -100%		
Working Temperature Range	-10°C -40°C		
U-type Bracket Adjustable Angle	0°-360°		
Dimensions	Light Body: 270mm*175mm*212mm Controller: 114mm*59mm*258mm	Light Body: 270mm*175mm*212mm Controller: 60mm*114mm*426mm	Light Body: 272mm*176mm*292mm Controller: 60mm*114mm*426mm
Net Weight(=)	Light Body: 1.72kg Controller: 0.7kg	Light Body: 1.77kg Controller: 1.19kg	Light Body: 2.78kg Controller: 1.2kg

* Product design and specifications are subject to change without notice.

FCC Statement

This device complies with part 15 of the FCC Rules. Operation is subject to the following two conditions:

- (1) This device may not cause harmful interference, and
- (2) this device must accept any interference received, including interference that may cause undesired operation

Any Changes or modifications not expressly approved by the party responsible for compliance could void the user's authority to operate the equipment

Note: This equipment has been tested and found to comply with the limits for a Class B digital device, pursuant to part 15 of the FCC Rules. These limits are designed to provide reasonable protection against harmful interference in a residential installation. This equipment generates uses and can radiate radio frequency energy and, if not installed and used in accordance with the instructions, may cause harmful interference to radio communications. However, there is no guarantee that interference will not occur in a particular installation. If this equipment does cause harmful interference to radio or television reception, which can be determined by turning the equipment off and on, the user is encouraged to try to correct the interference by one or more of the following measures:

- Reorient or relocate the receiving antenna.
- Increase the separation between the equipment and receiver.
- Connect the equipment into an outlet on a circuit different from that to which the receiver is connected.
- Consult the dealer or an experienced radio/TV technician for help

This equipment complies with FCC radiation exposure limits set forth for an uncontrolled environment. This equipment should be installed and operated with minimum distance 20cm between the radiator & your body.

⚠ Warning

Operating frequency: 2402MHz-2480MHz
Maximum EIRP Power: 5dBm

Declaration of Conformity

GODOX Photo Equipment Co.,Ltd. hereby declares that this equipment are in compliance with the essential requirements and other relevant provisions of Directive 2014/53/EU. In accordance with Article 10(2) and Article 10(10), this product is allowed to be used in all EU member states. For more information of DoC, Please click this web link: https://www.godox.com/DOC/Godox_VLII_Series_DOC.pdf.

The device complies with RF specifications when the device used at 0mm from your body.

产品保修

尊敬的用户，本保修卡是申请保修服务的重要凭证，请您配合销售商填写并妥善保管，谢谢！

产品信息	型号	产品条码
用户信息	姓名	联系电话
	通讯地址	
销售商信息	名称	
	联系电话	
	通讯地址	
	销售日期	
备注		

注：此表应由销售商盖章确认。

产品信息

本文件适用于相关《产品保修信息》（见后面说明）所列产品，其他非属此范围的产品或部件（如促销品、赠品及其他出厂后附加的部件等）不在此保修承诺内。

保修期

产品及部件的相应保修期按相关的《产品保修信息》执行。保修期自产品首次购买日起算，购买日以购买产品时保修卡登记日期为准。

如何获得保修服务

您可直接与产品销售商或授权服务机构联系，也可拨打神牛产品售后服务电话，与我们联系，由我们的服务人员为您安排服务。申请保修时，您应提供有效的保修卡作为保修凭证，方可获得保修。如您不能提供有效的保修卡，则在我们可确认产品或部件属于保修范围的情况下，也可以为您提供保修，但这不作为我们的义务。

不适用保修的情况

如产品存在下列情况，本文件项下的保证和服务将不适用 ①产品或部件超过相应保修期；②错误或不适当使用、维护或保管导致的故障或损坏，如：不当搬运；非按产品合理预期用途使用；不当插拔外接设备；跌落或外力挤压；接触或暴露于不适当温度、溶剂、酸碱、水浸或潮湿环境；③由非神牛授权机构或人员安装、修理、更改、添加或拆卸造成的故障或损坏；④产品或部件原有识别信息被修改或删除；⑤无有效保修卡；⑥使用非合法授权、非标准或非公开发行的软件造成的故障或损坏；⑦因不可抗力或意外事件造成的故障或损坏；⑧其他非因产品本身质量问题导致的故障或损坏。遇上述情况，您应向相关责任方寻求解决，神牛对此不承担任何责任。因非在保修期或保修范围内的部件、附件或软件导致产品不能正常使用的，不是保修范围内的故障。产品使用过程中正常的脱色，磨损和消耗，不是保修范围内的故障。

产品保修和服务支持信息

产品的保修期和服务类型按以下《产品保修信息》执行：

产品类别	选件名称	保修期（月）	保修服务类型
部件	电路板	12	客户送修
	电池	3	客户送修
	充电器带电性能的部件	12	客户送修
其他	如闪光灯管、造型灯泡、外壳、保护罩、锁紧装置、包装、电源线、同步线等。	无	无保修

神牛产品售后服务电话 0755-29609320-8062

Warranty

Dear customers, as this warranty card is an important certificate to apply for our maintenance service, please fill in the following form in coordination with the seller and safe-keep it. Thank you!

Product Information	Model	Product Code Number
Customer Information	Name	Contact Number
	Address	
Seller Information	Name	
	Contact Number	
	Address	
	Date of Sale	
Note		

Note: This form shall be sealed by the seller.

Applicable Products

The document applies to the products listed on the Product Maintenance Information (see below for further information). Other products or accessories (e.g. promotional items, giveaways and additional accessories attached, etc.) are not included in this warranty scope.

Warranty Period

The warranty period of products and accessories is implemented according to the relevant Product Maintenance Information. The warranty period is calculated from the day(purchase date) when the product is bought for the first time, And the purchase date is considered as the date registered on the warranty card when buying the product.

How to Get the Maintenance Service

If maintenance service is needed, you can directly contact the product distributor or authorized service institutions. You can also contact the Godox after-sale service call and we will offer you service. When applying for maintenance service, you should provide valid warranty card. If you cannot provide valid warranty card, we may offer you maintenance service once confirmed that the product or accessory is involved in the maintenance scope, but that shall not be considered as our obligation.

Inapplicable Cases

The guarantee and service offered by this document are not applicable in the following cases: ① . The product or accessory has expired its warranty period; ② .Breakage or damage caused by inappropriate usage, maintenance or preservation, such as improper packing, improper usage, improper plugging in/out external equipment, falling off or squeezing by external force, contacting or exposing to the improper temperature, solvent, acid, base, flooding and damp environments, etc; ③ . Breakage or damage caused by non-authorized institution or staff in the process of installation, maintenance, alternation, addition and detachment; ④ . The original identifying information of product or accessory is modified, alternated, or removed; ⑤ . No valid warranty card; ⑥ . Breakage or damage caused by using illegally authorized, nonstandard or non-public released software; ⑦ . Breakage or damage caused by force majeure or accident; ⑧ . Breakage or damage that could not be attributed to the product itself. Once met these situations above, you should seek solutions from the related responsible parties and Godox assumes no responsibility. The damage caused by parts, accessories and software that beyond the warranty period or scope is not included in our maintenance scope. The normal discoloration, abrasion and consumption are not the breakage within the maintenance scope.

Maintenance and Service Support Information

The warranty period and service types of products are implemented according to the following Product Maintenance Information:

Product Type	Name	Maintenance Period(month)	Warranty Service Type
Parts	Circuit Board	12	Customer sends the product to designated site
	Battery	3	Customer sends the product to designated site
	Electrical parts e.g.battery charger, etc.	12	Customer sends the product to designated site
Other Items	Flash tube, modeling lamp, lamp body, lamp cover, locking device, package,power cord, sync cable, etc.	No	Without warranty



Wechat
Official Account
神牛微信公众号

深圳市神牛摄影器材有限公司

地址: 深圳市宝安区福海街道塘尾社区耀川工业区厂房2栋 电话: 0755-29609320(8062)
传真: 0755-25723423 邮箱: godox@godox.com

GODOX Photo Equipment Co.,Ltd.

Add.: Building 2, Yaochuan Industrial Zone, Tangwei Community, Fuhai Street, Bao'an District, Shenzhen
518103, China Tel: +86-755-29609320(8062) Fax: +86-755-25723423 E-mail: godox@godox.com

www.godox.com

Made in China | 705-VL1520-00

