

705-SZ150R-00

深圳市神牛摄影器材有限公司

地址: 深圳市宝安区福海街道塘尾社区耀川工业区厂房2栋

电话: 0755-29609320(8062) 传真: 0755-25723423 邮箱: godox@godox.com

GODOX Photo Equipment Co., Ltd.

Add: Building 2, Yaochuan Industrial Zone, Tangwei Community, Fuhai Street, Bao'an District,

Shenzhen, China Tel: +86-755-29609320(8062) Fax: +86-755-25723423 E-mail: godox@godox.com

godox.com

Made in China



Godox

变焦RGB LED摄影灯
Zoom RGB LED Video Light

SZ150R

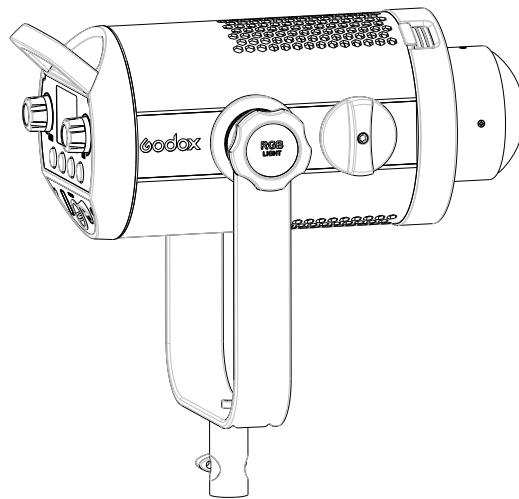

使用手册

Instruction Manual

前言

感谢您购买神牛产品！

变焦RGB LED摄影灯SZ150R是一款多功能的RGB常亮灯，适用于任何场景：直播、自拍、静物拍摄、化妆照明、视频录播、婚纱摄影、儿童拍摄、创意拍摄等。多种遥控方式，操作便捷，应用广泛。

主要特点：

- 一灯多用，随心切换LED双色温模式、彩光模式和37种情景特效模式
- 自由调节色温、亮度、色相和色彩饱和度
- 多灯联控，手机APP/2.4G无线/DMX控制台智能遥控
- 跟随音乐跳动并变换颜色，营造多彩氛围
- 静音模式：无风扇，零噪音，无干扰
- 强光模式：功率可达最大
- 20°~ 65°手动调焦
- 彩屏清晰显示，简单易懂
- 优秀的散热系统

警告

- △ 请保持干燥：请勿用湿手接触产品，亦不可将产品浸入水中或暴露于雨中。
- △ 请勿私自拆卸产品，如产品出现故障须由本公司或授权的维修人员进行检查维修。
- △ 请勿让儿童接触本产品。
- △ 本产品不能防水，在雨天及潮湿环境下请注意防水。
- △ 设备工作时发热现象，请小心触摸！

部件名称

• 灯体

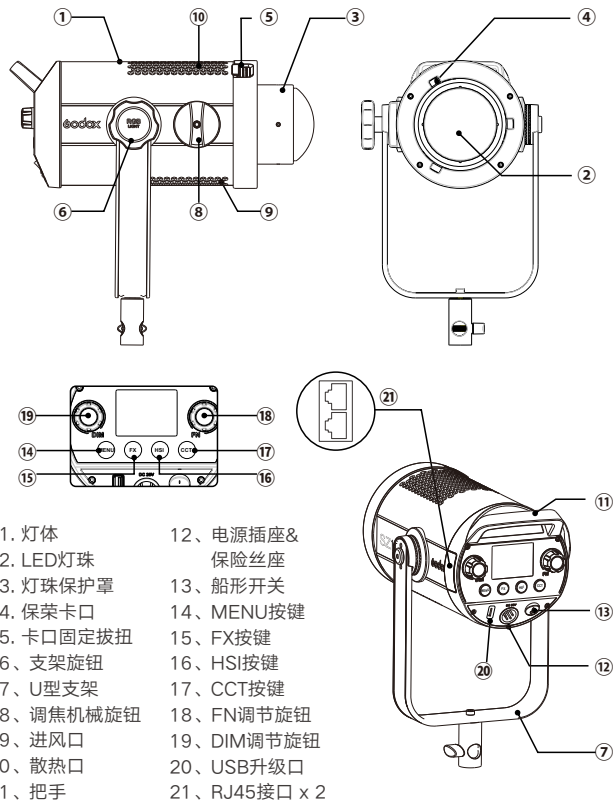

显示屏

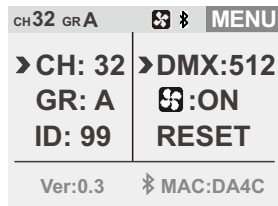

• MENU界面

1. CH通道
2. GR组别
3. ID号
4. DMX选项
5. 静音模式选择
6. 蓝牙功能复位
7. V0.3(版本号)
8. MAC (蓝牙号)

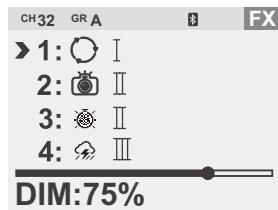

• FX界面

1. 1~13种特效不同功能显示
2. DIM: 亮度显示

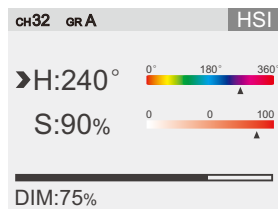

• HSI界面

1. H: 色环
2. S: 饱和度
3. DIM: 亮度显示

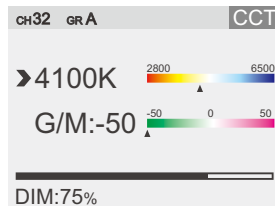

• CCT界面

1. 2800K~6500K: 色温
2. G/M: 色调
3. DIM: 亮度显示

标配物品

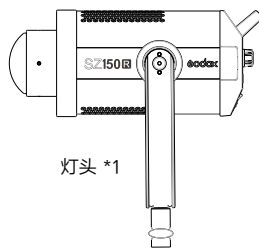

灯头 *1

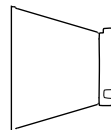

反光罩 *1



灯头保护盖 *1

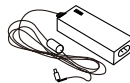

适配器 *1



电源线 *1



说明书 *1

可选购附件

可搭配本公司以下摄影附件使用，以获得最佳的拍摄效果和使用体验：
RC-R9遥控器、逆变器、柔光箱、反光伞、灯架、蜂巢、雷达罩、束光筒等。

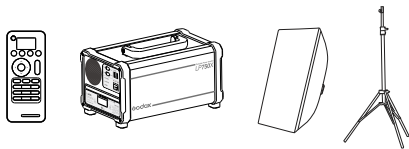

接通电源

通过电源线接通适配器，拨动LED灯上的电源开关。

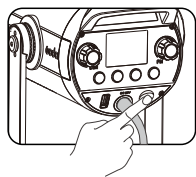

CH32 GR A		MENU	
➤ CH: 32	DMX: 512	GR: A	☑ ON
ID: 99	☑ RESET		
Ver: 0.3		✎ MAC: DA4C	

操作说明

• MENU按键

按MENU按键，LED灯进入菜单界面，可以设置CH通道(1~32)，GR组别(A/B/C/D/E/F)，ID(OFF/01~99)，DMX功能(OFF/ON)，静音模式(OFF/ON)，蓝牙(RESET)等功能。

CH32 GR A		MENU	
➤ CH: 32	DMX: 512	GR: A	☑ ON
ID: 99	☑ RESET		
Ver: 0.3		✎ MAC: DA4C	

• Fx按键

1. 按FX按键，LED灯进入FX界面，可以设置情景特效模式，有13类共37种，可根据需求选择。

CH32 GR A		FX	
➤ 1:		I	
2:		II	
3:		III	
4:		IV	
DIM: 75%			

序号	显示	场景	显示 I	显示 II	显示 III
1		彩光循环	慢速	中速	快速
2		闪光灯	闪光	发布会	狗仔队
3		激光彩灯	生日会	KTV	迪斯科
4		雷闪电	间歇	频繁	持续
5		坏灯泡	间歇	频繁	持续
6		电视机	慢速	中速	快速
7		蜡烛	间歇	频繁	持续
8		火	柴火	篝火	火灾
9		烟花	短暂	连续	演出
10		警车	暴闪	频闪	快闪
11		消防车	暴闪	频闪	快闪
12		救护车	暴闪	频闪	快闪
13	SOS	SOS			

2. 在FX模式下，LED灯通过按FN键可以选择特效模式的类别，1~13类可选，拨动拨轮循环出现；选中后按多功能按键FN可选择当前类别中的模式：I、II、III 3种模式，按多功能按键FN循环出现；旋转DIM键调节旋钮控制亮度，亮度调节范围0%-100% LCD显示屏将准确显示所设置的亮度。

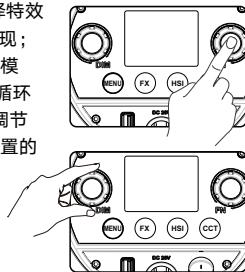

• HSI按键

按HSI按键，LED灯进入HSI界面，可以设置H色环(0°~360°)和S饱和度(0~100)。按DIM键调节旋钮控制亮度，亮度调节范围0%-100%，LCD显示屏将准确显示所设置的亮度。

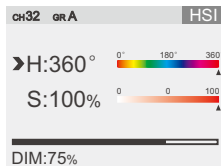

• CCT按键

按CCT按钮，进入常亮色温模式界面，可以设置色温(2800K~6500K),G/M色调可以设置调节。

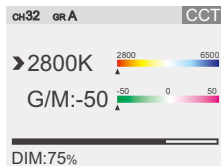

• 调焦机械旋钮

手动调节可实现照射角度从20°~65°改变。

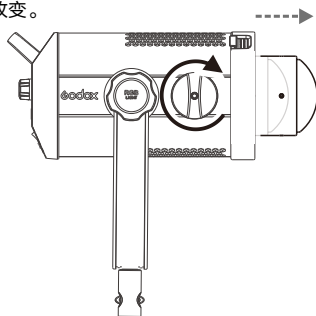

• USB升级口

在关机状态下，将已经存有新固件的U盘插入USB升级接口。然后开机，LED灯将自动进入升级界面，升级完成后自动跳回主界面。

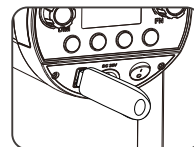

- 注：1. 必须官网下载新固件存放在U盘根目录，而且只有一个BIN文件。
2. USB口只能升级固件功能，不支持给其他产品充电功能。

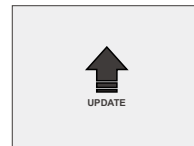

控制模式选择

1. DMX控制设置

在MENU界面选择DMX选项，可以设置DMX频道编号(OFF/001~512)。

通过RJ45口连接控制台，设置相同的频道，控制台就可以控制SZ150R LED灯的参数。

DMX:OFF

2. 2.4G无线控制

SZ150R LED摄影灯具备无线遥控功能，使用2.4G无线技术，可同时分别控制6个LED灯，32组通道频率，99个无线ID抗干扰强。

3. 蓝牙控制

1. 在MENU界面选择蓝牙选项设置为RESET功能。

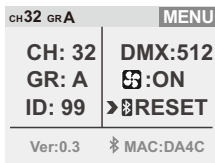

2. 打开APP: 点击 ，进入场景创建页面。

点击+号创建新的场景，点击当前场景，可以重命名场景或删除场景。

点击"Demo studio"，可以进入设置界面进行其他参数设置。

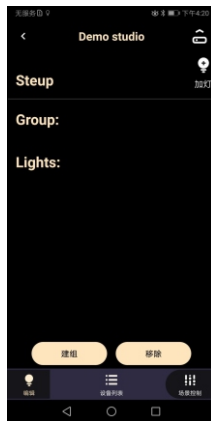
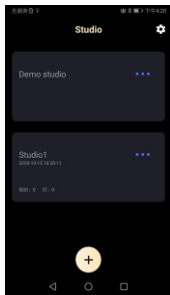

点击编辑，上方会出现加灯图标

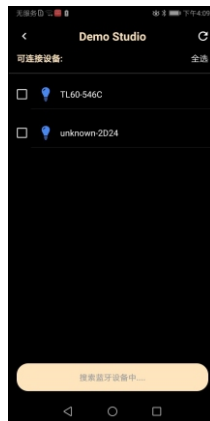

进入加灯界面查找对应的蓝牙ID号进行组网，组网成功后返回主页面，LED灯与手机APP连接成功。

备注：手机APP操作，请打开APP的“帮助”，里面有详细操作教程。

产品参数

LED灯	SZ150R
供电	AC100V-240V(50/60Hz)
功率	150W
频道	32个
组别	6组(A、B、C、D、E、F)
色温范围	2800K ~ 6500K
调光范围	0%-100%
RGB色域	0 ~ 360 °
100%光照度(LUX)	最大约19000 (测试距离1米)
CRI	≈97
TLCI	≈96
工作环境温度	-10° ~ 45°C
特效模式	共37种场景模式
模式	双色模式/HIS模式/场景模式
变焦	照射角度20° ~ 65°
控制方式	手机APP/2.4G无线/DMX控制台智能遥控
静音模式	有
显示	彩屏
产品尺寸	336*198.6*165mm
净重量	2.65kg(不带反光罩和保护盖)

* 设计和规格如有变更，恕不另行通知。

维护保养

- 为了防止灰尘的堆积影响到产品的性能，请定时用干净的湿布轻轻擦拭产品外部。
- 1年保修，消耗品电池，充电器，充电器电源线等配件不在此保修范围内。
- 对于不规范操作引起的机器故障不在保修范围内。
- 所有维修概由本厂指定可供原厂配件之维修部负责。
- 经发现，擅自检修本品，将取消一年保修期，维修需要收取相关费用。
- 如果本品出现故障或者被水淋湿，在专业人员维修后方可继续使用。
- 如有技术更改，恕不另行通知。

Foreword

Thank you for purchasing this Godox Product!

This Zoom RGB LED Video Light SZ150R is a RGB continuous light with multiple functions. Freely switch LED bicolor mode, colorful light mode and 37 situational special effects modes. Suitable for almost all shooting occasions e.g. live, camping, portrait shooting, make up, video, wedding, children photography, etc. It's portable and easy to be operated.

Features:

- Freely switch LED bicolor mode, colorful light mode and 37 situational special effects modes
- Easy to adjust color temperature, light brightness, hue and color saturation
- Combined control by smartphone APP/2.4G wireless/DMX control
- Blink and change colors with the rhythm of music
- Without fan, noise and interference in silent mode
- Offer strong light in light burst mode
- Manually zooming from 20° to 65°
- With a colored display to clearly show the parameters
- Excellent heat dissipation system

⚠ Warning

- ⚠ Always keep this product dry. Do not use in rain or in damp conditions.
- ⚠ Do not disassemble. Should repairs become necessary, this product must be sent to an authorized maintenance center.
- ⚠ Keep out of reach of children.
- ⚠ As this product do not have waterproof function, please take measures of waterproof in rainy or damp environment.
- ⚠ As this product may heat up in working, please do not touch.

Name of Body

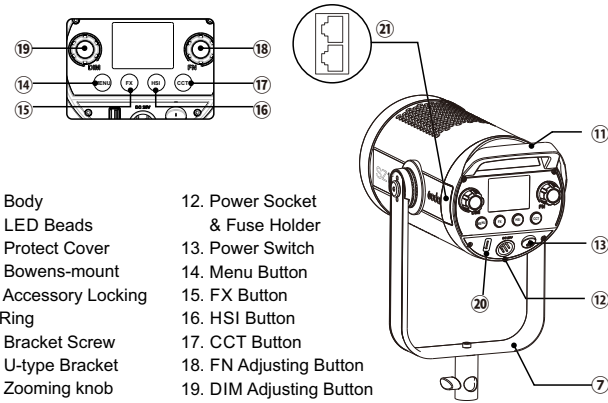
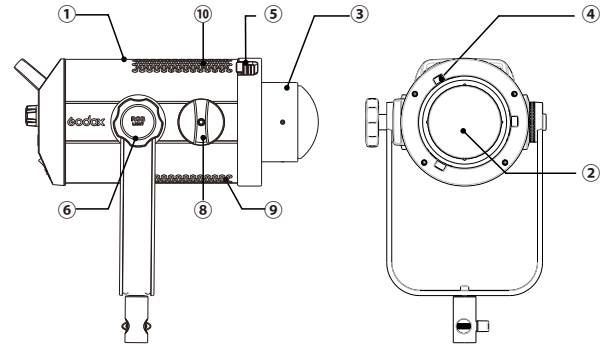

- | | |
|----------------------------|--------------------------------|
| 01. Body | 12. Power Socket & Fuse Holder |
| 02. LED Beads | 13. Power Switch |
| 03. Protect Cover | 14. Menu Button |
| 04. Bowens-mount | 15. FX Button |
| 05. Accessory Locking Ring | 16. HSI Button |
| 06. Bracket Screw | 17. CCT Button |
| 07. U-type Bracket | 18. FN Adjusting Button |
| 08. Zooming knob | 19. DIM Adjusting Button |
| 09. Fan Inlet | 20. USB Upgrade Port |
| 10. Thermovent | 21. RJ45 Port x2 |
| 11. Handle | |

LCD Panel

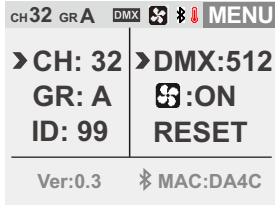

• Menu Interface

1. CH Chanel
2. GR Group
3. ID
4. DMX Option
5. Silent Mode Selection
6. Bluetooth Function Reset
7. V0.3 (version number)
8. MAC(Bluetooth number)

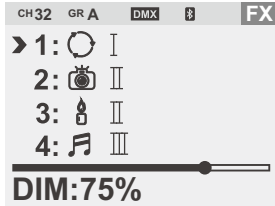

• FX Interface

1. Different Function Display from 1 to 13 special effects
2. DIM: Brightness Display

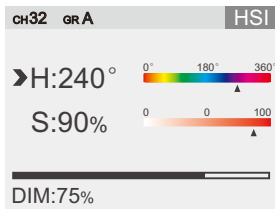

• HSI Interface

1. H: Color Circle
2. S: Saturation
3. DIM: Brightness Display

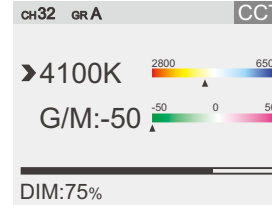

• CCT Interface

1. 2800K~6500K: Color Temperature
2. G/M: Hue
3. DIM: Brightness Display

Included Items

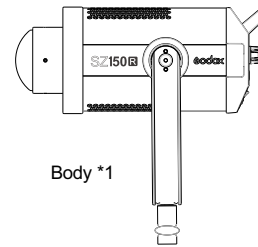

Body *1

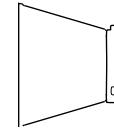

Reflector *1



Protect Cover *1



Adapter *1



Power Cable *1



Instruction Manual *1

Optional Accessory

The product can be used in combination with the following optional accessories so as to achieve best photography effects:

RC-R9 Remote control, inverter, softbox, umbrella, light stand, honey comb, beauty dish, snoot, etc.

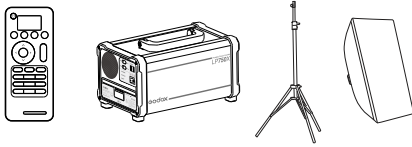

Power Supply

Connect the SZ150R to power source with adapter and power cable. Press the power switch to turn on the LED light.

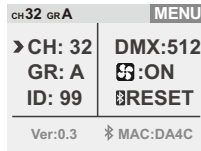
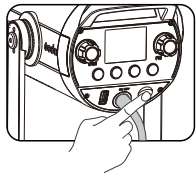

Operation

1. Setting

• Menu Button

Press the MENU button and the LED light will enter menu interface. In this interface, CH channel (1 to 32), GR group (A/B/C/D/E/F), ID (OFF/01 to 99), DMX function (OFF/ON), silent mode (OFF/ON) and Bluetooth can be set.

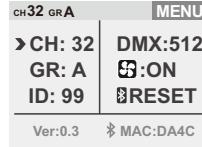

• FX Button

1. Press the FX button and the LED light will enter FX interface. In this interface, you can set 37 different special effects which are divided into 13 categories according to your demands.

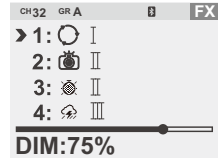

No.	Display	Situation	Display I	Display II	Display III
1		RGB cycle	Slow speed	Medium speed	Quick speed
2		Flash	Flash	Press conference	Paparazzi
3		Laser	Birthday party	KTV	Disco
4		Lightning	Discontinuous	Frequent	Sustainable
5		Broken bulb	Discontinuous	Frequent	Sustainable
6		TV	Slow speed	Medium speed	Quick speed
7		Candle	Discontinuous	Frequent	Sustainable
8		Fire	Firewood	Campfire	Fire hazard
9		Firework	Brief	Continuous	Show
10		Police car	Strong flash	Frequent flash	Quick flash
11		Fire truck	Strong flash	Frequent flash	Quick flash
12		Ambulance	Strong flash	Frequent flash	Quick flash
13		SOS			

2. In FX mode, press the FN select dial to choose the special effect modes from 1 to 13 categories. And the modes will display circularly by turning the select dial. After choosing the current mode, press down the FN multifunctional select dial from I, II and III. And the modes will display circularly when keeping pressing the FN multifunctional select dial. Turn the DIM select dial to choose brightness from 0% to 100% and the brightness value will be precisely displayed on the LCD panel.

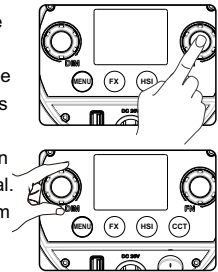

• HSI Button

Press HSI button and the LED light will enter HIS interface, setting H color circle from 0° to 360° and S saturation from 0 to 100. Turn the DIM select dial to choose brightness from 0% to 100% and the brightness value will be precisely displayed on the LCD panel.

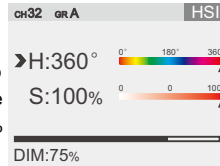

• CCT Button

Press the CCT button to enter color temperature setting interface of continuous light, setting color temperature from 2800K to 6500K and G or M hue.

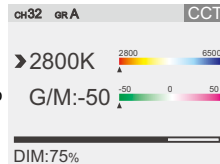

• Zooming Knob

By adjusting this knob, the beam angle can be changed from 20° to 65°.

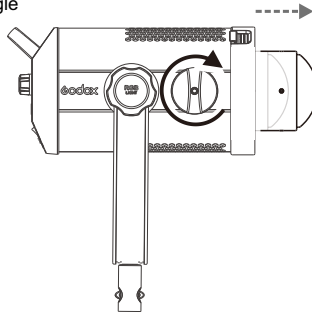

• USB Upgrade Port

In shutdown state, insert the U disk included the newest firmware into the USB upgrade port. Then, turn on the LED light and it will automatically enter upgrading interface and back to the main interface after upgrade finished.

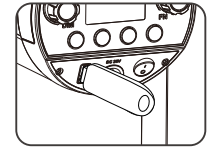

- Note:** 1. The newest firmware must be downloaded from the official website and stored in the root directory of U disk. And there can only be one BIN document.
2. The USB port can only support firmware upgrade function. Please do not charge other products through this port.



Control Mode Selection

1. DMX Control Setting

In NENU interface, choose DMX options to set DMX channels (OFF/001~512). Connect the LED light to DMX control panel by RJ45 port. Set them to the same channel, the SZ150R can be controlled by control panel.

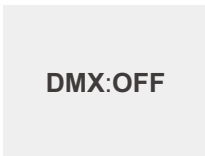



2. 2.4G Wireless Control

With 2.4G wireless system, SZ150R LED video light has remote grouping and control function. Up to 6 groups of LED lights can be controlled. 32 channels and 99IDs are available with strong anti-interference capability.

3. Bluetooth Control

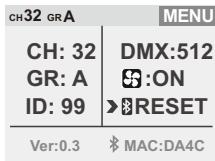
3.1 In MENU interface, set Bluetooth to RESET.



3.2 Open up the APP: click  to enter the situation creating interface.

Click "+" sign to create new situations. Click the current situation to rename or delete the situation.

Click the "Demo studio" to enter the setting interface and set other parameters.

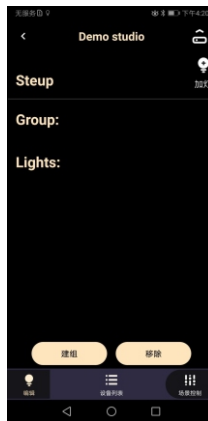
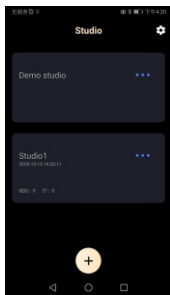

Click the "editor" button, and the icon of "add lights" will be displayed.

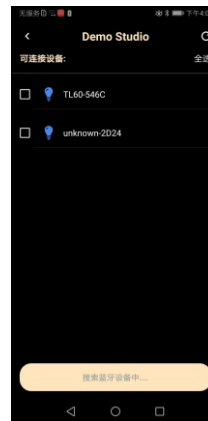

Enter the interface of "add lights" and search the corresponding Bluetooth ID to match. After being successfully matched, back to the main interface and the LED light is successfully connected to the smartphone APP.

Note: for more smartphone APP operations, please open the "help" in APP to gain detailed guidance.

Technical Data

LED Light	SZ150R
Power Supply	AC100V-240V(50/60HZ)
Power	150W
Channel	32
Group	6(A、B、C、D、E、F)
Color Temperature Range	2800K~6500K
Brightness Range	0%-100%
RGB Hue	0~360°
100% Illuminance(LUX)(≈)	Max. 19000 (1-meter testing distance)
CRI (≈)	97
TLCI (≈)	96
Working Environment Temperature	-10°~45°C
Special Effects Modes	39
Mode	Bicolor mode/HSI mode/situational mode
Zooming	Beam Angle 20°~65°
Control Method	Smartphone APP/2.4G wireless/ DMX intelligent control
Silent Mode	Yes
Display	Color Display
Dimension	336*198.6*165mm
Net Weight	2.65kg (not include reflector and protect cover)

* Product design and specifications are subject to change without notice.

Maintenance

This product, except consumables e.g. charger and charger cable, is supported with a one-year warranty.

Avoid sudden impacts and the product should be dedusted regularly.

Maintenance of the flash must be performed by our authorized maintenance department which can provide original accessories.

Unauthorized service will void the warranty.

If the product had failures or was wetted, do not use it until it is repaired by professionals.

Changes made to the specifications or designs may not be reflected in this manual.

FCC Statement

This device complies with part 15 of the FCC Rules. Operation is subject to the following two conditions: (1) This device may not cause harmful interference, and (2) this device must accept any interference received, including interference that may cause undesired operation.

Any Changes or modifications not expressly approved by the party responsible for compliance could void the user's authority to operate the equipment.

Note: This equipment has been tested and found to comply with the limits for a Class B digital device, pursuant to part 15 of the FCC Rules. These limits are designed to provide reasonable protection against harmful interference in a residential installation. This equipment generates uses and can radiate radio frequency energy and, if not installed and used in accordance with the instructions, may cause harmful interference to radio communications. However, there is no guarantee that interference will not occur in a particular installation. If this equipment does cause harmful interference to radio or television reception, which can be determined by turning the equipment off and on, the user is encouraged to try to correct the interference by one or more of the following measures:

- Reorient or relocate the receiving antenna.
- Increase the separation between the equipment and receiver.
- Connect the equipment into an outlet on a circuit different from that to which the receiver is connected.
- Consult the dealer or an experienced radio/TV technician for help.

The device has been evaluated to meet general RF exposure requirement. The device can be used in portable exposure condition without restriction.