

GODOX设计文件图注

项目名称	神牛 M600D-说明书		
项目类型	<input type="checkbox"/> 彩盒 <input type="checkbox"/> 彩卡 <input type="checkbox"/> 白盒 <input type="checkbox"/> 贴纸 <input checked="" type="checkbox"/> 说明书 <input type="checkbox"/> 内托 <input type="checkbox"/> 胶盒 <input type="checkbox"/> 吸塑 <input type="checkbox"/> 其他:		
产品料号	705-M600D0-00	版本	A
展开尺寸(mm)		成品尺寸(mm)	100*140mm
尺寸公差	±2mm		
材质	105G铜版纸		
工艺说明	骑马钉		
备注/色值	单色, 黑色印刷		
设计师	陈正丰	校对	吴水宁

705-xxxxxx-00

705-M600D0-00

合格证
QC PASS

Godox

LED影视灯

LED摄影灯

Knowled LED Light

Knowled M600D Daylight LED Light

M600D

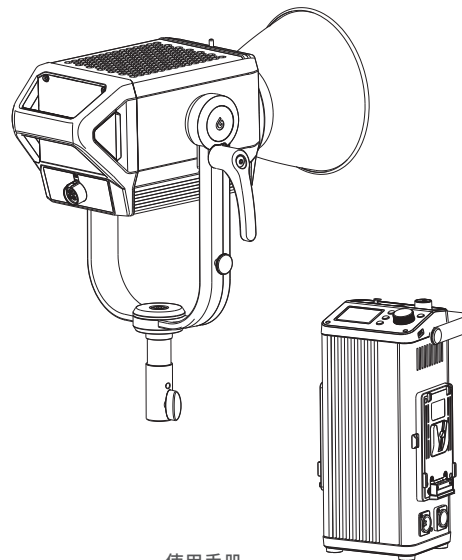

使用手册
Instruction Manual

深圳市神牛摄影器材有限公司

地址: 深圳市宝安区福海街道塘尾社区耀川工业区厂房2栋
电话: 0755-29609320(8062) 传真: 0755-25723423 邮箱: godox@godox.com

GODOX Photo Equipment Co., Ltd.

Add: Building 2, Yaochuan Industrial Zone, Tangwei Community, Fuhai Street, Bao'an District,
Shenzhen 518103, China Tel: +86-755-29609320(8062) Fax: +86-755-25723423
E-mail: godox@godox.com

godox.com

Made in China



IMPORTANT SAFETY INSTRUCTIONS

When using your photographic equipment, basic safety precautions should always be followed, including the following:

1. Read and understand all instructions before using.
2. Close supervision is necessary when any appliance is used by or near children. Do not leave appliance unattended while in use.
3. Care must be taken as burns can occur from touching hot parts.
4. The appliance switch is provided with the symbols 0 indicating off and 1 indicating on. The symbols and may be used for this purpose.
5. Do not operate appliance with a damaged cord or if the appliance has been dropped or damaged – until it has been examined by a qualified serviceman.
6. Position the cord so that it will not be tripped over, pulled, or contact hot surfaces.
7. If an extension cord is necessary, a cord with a current rating at least equal to that of the appliance should be used. Cords rated for less amperage than the appliance may overheat.
8. Always unplug appliance from electrical outlet before cleaning and servicing and when not in use. Never yank cord to pull plug from outlet. Grasp plug and pull to disconnect.
9. Let appliance cool completely before putting away. Loop cord loosely around appliance when storing.
10. To reduce the risk of electric shock, do not immerse this appliance in water or other liquids.
11. To reduce the risk of electric shock, do not disassemble this appliance, but take it to a qualified serviceman when service or repair work is required. Incorrect reassembly can cause electric shock when the appliance is used subsequently.
12. The use of an accessory attachment not recommended by the manufacturer may cause a risk of fire, electric shock, or injury to persons.
13. Connect this appliance to a grounded outlet.
14. Disconnect this unit from its source of supply before replacing the projection lamp.
15. This appliance has a polarized plug (one blade is wider than the other). To reduce the risk of electric shock, this plug is intended to fit in a polarized outlet only one way. If the plug does not fit fully in the outlet, reverse the plug. If it still does not fit, contact a qualified electrician. Do not modify the plug in any way.

SAVE THESE INSTRUCTIONS

Foreword

Thank you for purchasing!

Godox M600D is a LED Light product with superior performance. It has a separation design of light body and controller, high power, thousand-bit brightness adjustment and dimming curve adjustment functions, quite suitable for large photo studios, broadcast studios or large-scale field scenes.

Features:

- 600W high power to create bright light output.
- Brightness adjustment is accurate to 0.1%, controlling the brightness in subtle scenes.
- 4 dimming curves: linear, S-curve, exponential, and logarithmic.
- Bowens mount is perfectly compatible with more optical accessories, such as spotlight VSA.
- Various professional control methods: Bluetooth control/DMX512 remote control/2.4G wireless control.
- Super high color rendering index: CRI: ≥96, TLCI: ≥97, R9: ≥93, R12: ≥85
- 12 simulated scenes light effects: flash, lightning, TV, broken bulb, etc.
- Two power supply methods: controller (DC) power supply and V-mount battery power supply.
- Smart power supply: The controller can be charged while in use, and the side with the logo supports unilateral power supply.
- Simple control interface: 4 buttons, 1 knob, clear UI interface.

Warning

- ⚠ Always keep this product dry. Do not use in rain or in damp conditions.
- ⚠ Do not disassemble. Should repairs become necessary, this product must be sent to an authorized maintenance center.
- ⚠ Keep out of reach of children.
- ⚠ As this product do not have waterproof function, please take measures of waterproof in rainy or damp environment.
- ⚠ Do not use the product in the presence of flammable gases, chemicals and other similar materials.
- ⚠ **CAUTION:** Hot parts!When the product is always on and flickering, please do not touch the high temperature part of the LED head.
- ⚠ When replacing product accessories, please turn off the LED light and perform a cold cut.
- ⚠ The light source contained in this luminaire shall only be replaced by the manufacturer or his service agent or a similar qualified person.
- ⚠ The lamp shall be changed if it has become damaged or thermally deformed.
- ⚠ The luminaire is intended for professional use only.

Name of Body

Light Body

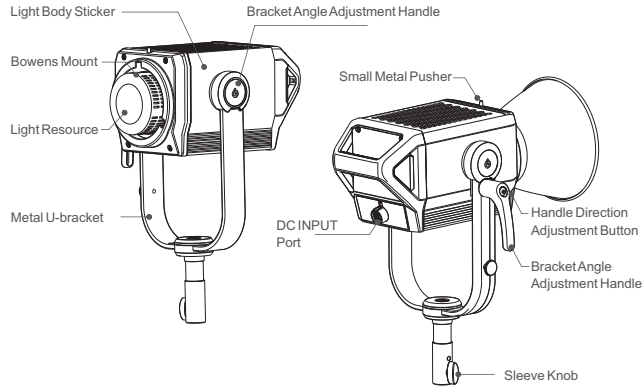

Controller

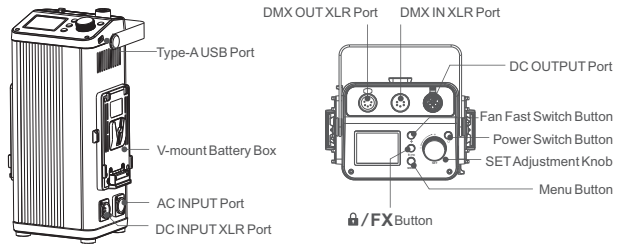

Remote Control (Separately Sold Accessory)

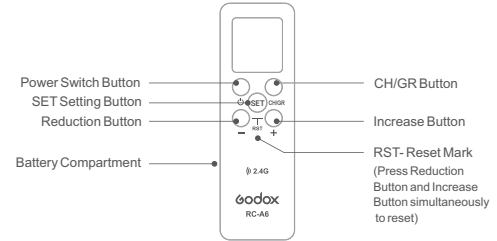

What's in the Box

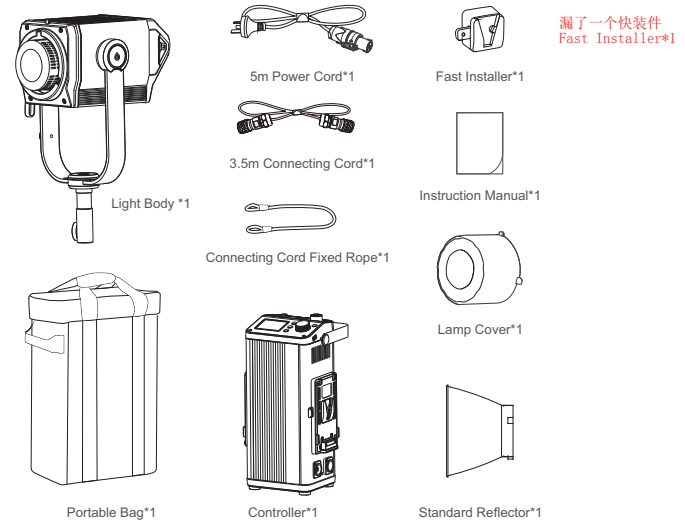

Separately Sold Accessories

Better shooting effects and using experience matched with following accessories:
RC-A6 Remote Control, 8m Power Cord

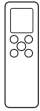

Installation and Disassembly Guide

1. Connect the controller and the light body

Press and hold the spring latch button of the connecting cord, insert the end of the connecting cord with DC OUTPUT Port into the DC INTPUT Port of the light body. Then continue press and hold the button to insert the end of the connecting cord with DC INTPUT Port into the DC OUTPUT Port of the controller to complete the connection.

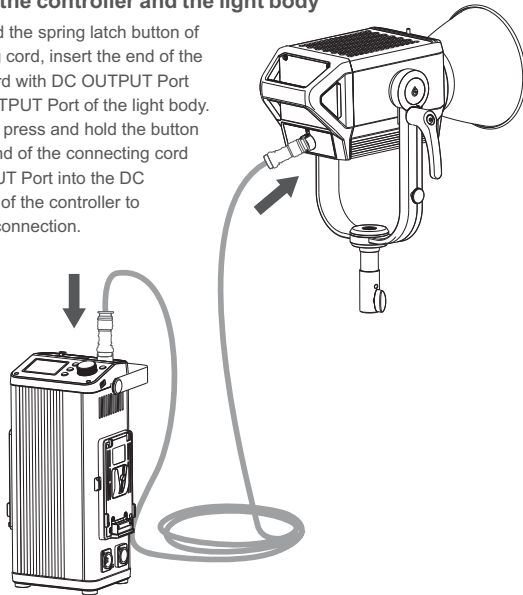

2. Mounted on the tripod

Adjust the light body to a proper angle, rotate the screw of sleeve knob to install the light body on the tripod, then rotate the screw of sleeve knob to fix the light body on the tripod.

The inclination angle of the light body could be adjusted by loosening the bracket angle adjustment handle and then screwing down the handle afterwards.

Note: The tripod belongs to separately sold accessories.

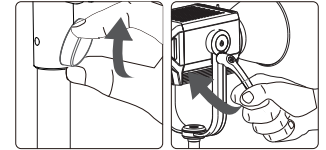

3. Installation and disassembly the lamp cover

Installation: Press the small metal pusher top-down, put the lamp cover on BOWENS Mount, and rotate clockwise to tighten it. Disassembly: Press the small metal pusher top-down, then rotate counterclockwise to remove it.

Note: Make sure to remove the lamp cover before use to avoid damage. Put on the lamp cover to protect the lamp when not in use.

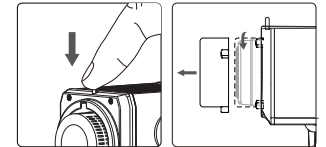

4. Installation and disassembly the standard reflector

Installation: Press the small metal pusher top-down, put the standard reflector on BOWENS Mount, and rotate clockwise to tighten it.

Disassembly: Press the small metal pusher top-down, then rotate counterclockwise to remove it.

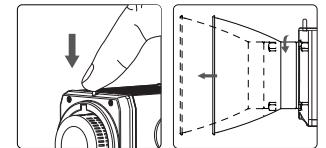

Installation Controller M600D-CL and DMX Controlling Box

The Connection operation diagram of Controller M600D-CL and DMX Controlling Box is as follows:

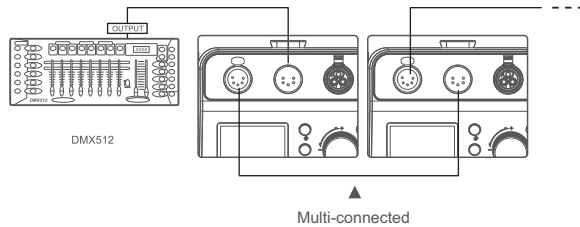

2.V-mount battery power supply

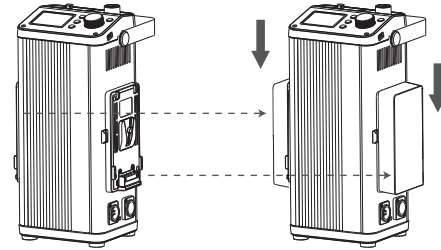

Note: Usable for 14.4V~26V V-mount battery.

Power Supply

1.DC adapter Power Supply

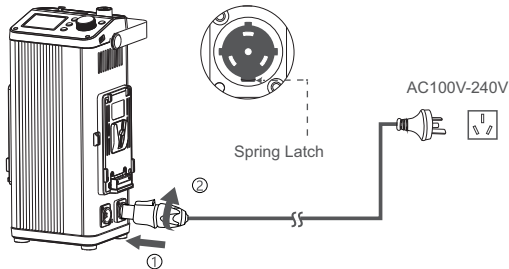

Note: Please press the latch button when installing or disassembling the power cord and connecting cord.

Display Screen

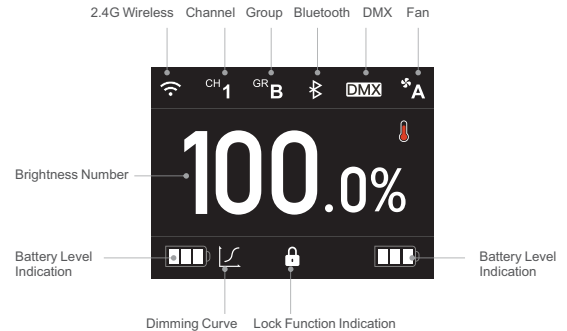

Controller Operation Instruction

1. Turn On/Off

Short press the controller < ⏻ > Button after connecting to the power supply to turn on or off.

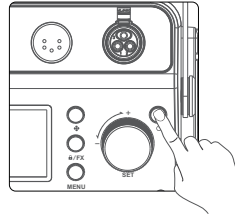

2. Brightness Adjustment (thousand-bit adjustment)

Turn the SET adjustment knob on the main interface to adjust brightness from 0% to 100%, with an increment of 0.1% in each level. Rotate clockwise to increase brightness, and counterclockwise to decrease brightness. The brightness will increase or decrease by 0.1 unit in normal rotation speed; and increase or decrease by 1 unit in rapid rotation speed.

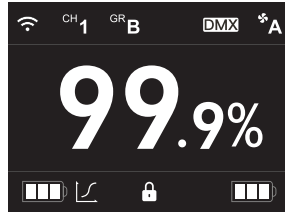

3. Menu Setting

Short press < MENU > Menu Button to enter the menu interface, displayed in order with Wireless Control, Bluetooth, DMX Mode, Fan Mode, Dimming Curve, Screen Brightness, Language, Restore Factory Setting, Version.

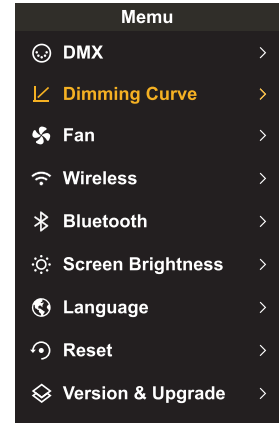

3.1 Wireless Control

Turn the SET adjustment knob on the menu interface and select Wireless control, then short press the SET adjustment knob again to enter the Wireless Control interface displayed in order with Wireless Switch, Channel, Group and ID. Finally, complete the settings of Wireless Switch, Channel, Group and ID by short press & turn the SET adjustment knob.

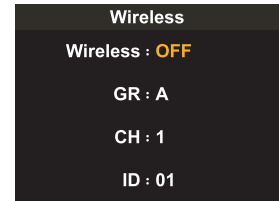

3.2 Bluetooth

Turn the SET adjustment knob on the menu interface and select < Bluetooth>, then short press the SET adjustment knob again to enter the Bluetooth Setting interface displayed in order with Bluetooth Switch, Reset and MAC Code.

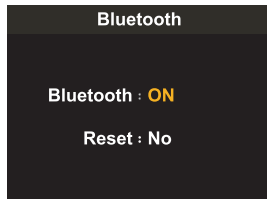

3.3 DMX Mode

Turn the SET adjustment knob on the menu interface and select < DMX >, then short press the SET adjustment knob again to enter the DMX Setting interface displayed with Address Channel. Turn the knob to OFF or 1-512, the lamp will be in master or slave mode respectively. Afterwards, short press the SET adjustment knob to return to the previous menu interface.

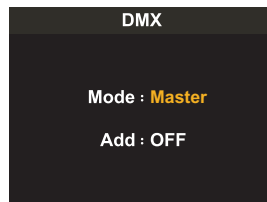

DMX Practical Form

Address Code	Operation Mode	CCT	FX
n(Mode)		0-51	52-255
n+1	DMX*(100/255) rounding off 0-100% brightness adjustment		DMX*(100/255) rounding off 0-100% brightness adjustment
n+2			DMX*(Total Light Effect/255) For Example: Total Light Effect 8,DMX=160, Light Effect NO.=60*8/255=5
n+3			0-85: Light Effect Level I 86-171: Light Effect Level II 172-255: Light Effect Level III
n+4			
n+5			

3.4 Fan Mode

Turn the SET adjustment knob on the menu interface and select < Fan >, then short press the SET adjustment knob again to enter the Fan Setting interface, finally turn the knob to choose Auto Speed Adjustment Mode, High-Speed Fan Cooling Mode, Low-Speed Fan Cooling Mode, Off Mode.

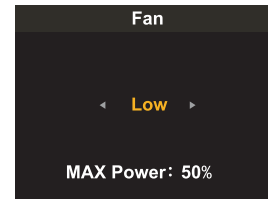

Note: Enter mute mode when turning off the fan.

3.5 Dimming Curve

Turn the SET adjustment knob on the menu interface and select < Dimming Curve >, then short press the SET adjustment knob again to enter the Dimming Curve Setting interface, finally turn the knob to choose linear/S-curve/exponential/logarithmic dimming curve.

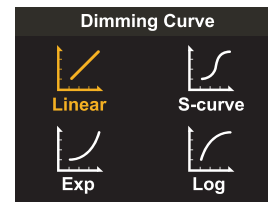

3.6 Screen Brightness

Turn the SET adjustment knob on the menu interface and select < Screen Brightness >, then short press the SET adjustment knob again to enter the Screen Brightness Setting interface, finally turn the knob to choose 1, 2, 3 levels of screen brightness.

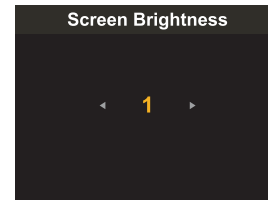

3.7 Language

Turn the SET adjustment knob on the menu interface and select < Language >, then short press the SET adjustment knob again to enter the Language Setting interface, finally turn the knob to choose English or Simplified Chinese.

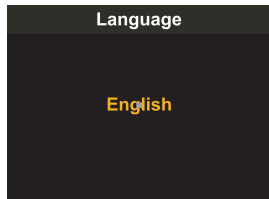

3.8 Restore Factory Setting

Turn the SET adjustment knob on the menu interface and select < Restore Factory Setting >, then short press the SET adjustment knob again to enter the Restore Factory Setting interface, turn the knob to choose "Yes" or "No" and short press to confirm. If you choose "Yes", the system will initiate resetting program and display resetting progress bar on the screen, after which it will return to the main interface, and the screen brightness shows 50.

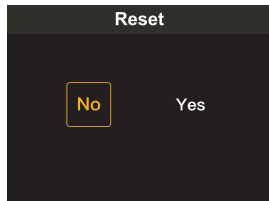

3.9 Version

Turn the SET adjustment knob on the menu interface and select < Version >, then short press the SET adjustment knob again to enter the Version display interface, the Version Code displayed on the screen is the firmware version of the Controller.



4. Light Effect Setting

Short press < ⏸/FX > button to enter FX Light Effect interface, turn the knob to turn-off Light Effect or switch to flash, lightning, TV or broken bulb scenes.

Note: Short press the SET adjustment knob to change the rate after choosing one of the above Light Effects.



Flash Mode



Lightning Mode

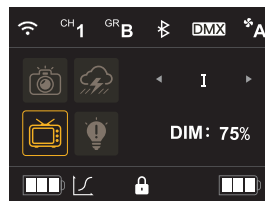

TV Mode



Broken Bulb Mode

Software Upgrade

1. Download the new firmware to the U disk from the official website (<http://www.godox.com.cn/Downloads.html>).
2. Turn off the M600D LED light. Insert the U disk with new firmware into the USB upgrade port.
3. Turn on the M600D LED Light, and it will automatically enter the upgrading interface..
4. It will return to main interface after completion.

Notes:

1. New firmware must be downloaded from the official website, and keep only one BIN file in the root directory of the USB disk.
2. The USB port can only support firmware upgrade function.

Over-Temperature Protection

If the temperature of the light body is too high, the Over-Temperature Protection icon flashes on the main interface, the light body can be used normally.

If the temperature of the light body exceeds the limit of Over-Temperature Protection, the Over-Temperature Protection icon flashes on the screen center, and the screen works properly after the light goes out in 3 seconds. When the temperature decreases to 50°C, the Over-Temperature Protection icon disappears, then the light body can resume working.

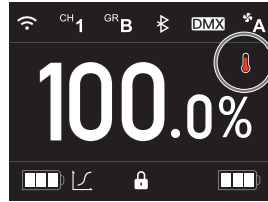

Troubleshooting

If ! icon appeared and blinking and fan icon is also appeared on the display, It might be the fan failure. Please contact with customer service.

If ! icon appeared and blinking and temperature icon is also appeared on the display:

1. If the icons are displayed in cool-light state (just being turned on or for a little while), it might be probe failure. Please contact with customer service.
2. If the icons are displayed in hot-light state (being turned on for a long while), it might be caused by long-time usage and over temperature. Please turn off the light and turn it on after the light is cooled down.

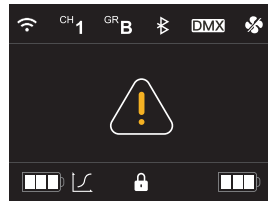

Maintenance

This product, except consumables e.g. adapter and power cable, is supported with a one-year warranty.

Maintenance of the light must be performed by our authorized maintenance department which can provide original accessories.

Unauthorized service will void the warranty.

If the product breaks down or gets wet, please do not use it until repaired by a professionals.

If there is anything abnormal during LED light's working, please turn it off immediately and identify the reasons.

Illuminance Testing Data

Testing Condition	1m	3m	5m
Bare Lamp	23800(lux)	3070(lux)	1440(lux)
	2210(fc)	285(fc)	133(fc)
Lamp with Cover	164000(lux)	15700(lux)	5720(lux)
	15200(fc)	1460(fc)	532(fc)

Technical Data

Mode	M600D
Output Power	600W
Adapter Power Supply Input	AC100-240V/10A
Adapter Power Supply Output	DC48V/15A
V-mount battery Input Parameter	14.8V 150Wh / 26V 260Wh
Channel	32(1~32)
Group	16(0~9, A~F)
ID	1~99, OFF
Color-Temperature	5600K
CRI	≥96
TLCI	≥97
Working Ambient Temperature	-10~40°C
FX Light Effect	12 kinds within 4 types
Controlling Method	Support DMX512 Remote Control, 2.4G Wireless Control, Bluetooth Control
Dimming Curve	4 types: linear/S-curve/ exponential/logarithmic
Mute Mode	YES
2.4G Wireless Control Distance	≈60m
Display Screen	2.4 inches
Light Body	447.3*242.8*152.9mm
Controller	332.4*121.6*179.2mm
Light Body Weight	4.5 kg
Controller Weight	3.987 kg

* Product design and specifications are subject to change without notice.

Maintenance

This product, except consumables e.g. cable, is supported with a one-year warranty. Avoid sudden impacts and the product should be dedusted regularly.

Maintenance of the flash must be performed by our authorized maintenance department which can provide original accessories.

Unauthorized service will void the warranty.

If the product had failures or was wetted, do not use it until it is repaired by professionals.

Changes made to the specifications or designs may not be reflected in this manual.

FCC Statement

This device complies with part 15 of the FCC Rules. Operation is subject to the following two conditions: (1) This device may not cause harmful interference, and (2) this device must accept any interference received, including interference that may cause undesired operation.

Any Changes or modifications not expressly approved by the party responsible for compliance could void the user's authority to operate the equipment.

Note: This equipment has been tested and found to comply with the limits for a Class B digital device, pursuant to part 15 of the FCC Rules. These limits are designed to provide reasonable protection against harmful interference in a residential installation. This equipment generates uses and can radiate radio frequency energy and, if not installed and used in accordance with the instructions, may cause harmful interference to radio communications. However, there is no guarantee that interference will not occur in a particular installation. If this equipment does cause harmful interference to radio or television reception, which can be determined by turning the equipment off and on, the user is encouraged to try to correct the interference by one or more of the following measures:

- Reorient or relocate the receiving antenna.
- Increase the separation between the equipment and receiver.
- Connect the equipment into an outlet on a circuit different from that to which the receiver is connected.
- Consult the dealer or an experienced radio/TV technician for help.

To maintain compliance with FCC's RF Exposure guidelines, This equipment should be installed and operated with minimum distance between 20cm the radiator your body: Use only the supplied antenna.

产品保修

尊敬的用户,本保修卡是申请保修服务的重要凭证,请您配合销售商填写并妥善保管,谢谢!

产品信息	型号	产品条码
用户信息	姓名	联系电话
	通信地址	
销售商信息	名称	
	联系电话	
	通信地址	
	销售日期	
备注		

注:此表应由销售商盖章确认。

适用产品

本文件适用于相关《产品保修信息》(见后面说明)所列产品,其他非属此范围的产品或部件(如促销品、赠品及其他出厂后附加的部件等)不在此保修承诺内。

保修期

产品及部件的相应保修期按相关的《产品保修信息》执行。保修期自产品首次购买日起算,购买日以购买产品时保修卡登记日期为准。

如何获得保修服务

您可直接与产品销售商或授权服务机构联系,也可拨打神牛产品售后服务电话,与我们联系,由我们的服务人员为您安排服务。申请保修时,您应提供有效的保修卡作为保修凭证,方可获得保修。如您不能提供有效的保修卡,则在我们确认产品或部件属于保修范围的情况下,也可以为您提供保修,但这不作为我们的义务。

不适用保修的情况

如产品存在下列情况,本文件项下的保证和服务将不适用 ①产品或部件超过相应保修期;②错误或不当使用、维护或保管导致的故障或损坏,如:不当搬运;非按产品合理预期用途使用;不当插拔外接设备;跌落或外力挤压;接触或暴露于不适当温度、溶剂、酸碱、水浸或潮湿环境;③由非神牛授权机构或人员安装、修理、更改、添加或拆卸造成的故障或损坏;④产品或部件原有识别信息被修改变更或删除;⑤无有效保修卡;⑥使用非合法授权、非标准或非公开发行的软件造成的故障或损坏;⑦因不可抗力或意外事件造成的故障或损坏;⑧其他非因产品本身质量问题导致的故障或损坏。遇上述情况,您应向相关责任方寻求解决,神牛对此不承担任何责任。因非在保修期或保修范围内的部件、附件或软件导致产品不能正常使用的,不是保修范围内的故障。产品使用过程中正常的脱色,磨损和消耗,不是保修范围内的故障。

产品保修和服务支持信息

产品的保修期和服务类型按以下《产品保修信息》执行:

产品类别	选件名称	保修期(月)	保修服务类型
部件	电路板	12	客户送修
	电池	3	客户送修
	充电器、电源线,同步线等带电性能的部件。	12	客户送修
其他	如闪光灯管、造型灯泡、外壳、保护罩、锁紧装置、包装等。	无	无保修

神牛产品售后服务电话 0755-29609320-8062

Warranty

Dear customers, as this warranty card is an important certificate to apply for our maintenance service, please fill in the following form in coordination with the seller and safe-keep it. Thank you!

Product Information	Model	Product Code Number
Customer Information	Name	Contact Number
	Address	
Seller Information	Name	
	Contact Number	
	Address	
	Date of Sale	
Note:		

Note: This form shall be sealed by the seller.

Applicable Products

The document applies to the products listed on the **Product Maintenance Information** (see below for further information). Other products or accessories (e.g. promotional items, giveaways and additional accessories attached, etc.) are not included in this warranty scope.

Warranty Period

The warranty period of products and accessories is implemented according to the relevant Product Maintenance Information. The warranty period is calculated from the day(purchase date) when the product is bought for the first time, And the purchase date is considered as the date registered on the warranty card when buying the product.

How to Get the Maintenance Service

If maintenance service is needed, you can directly contact the product distributor or authorized service institutions. You can also contact the Godox after-sale service call and we will offer you service. When applying for maintenance service, you should provide valid warranty card. If you cannot provide valid warranty card, we may offer you maintenance service once confirmed that the product or accessory is involved in the maintenance scope, but that shall not be considered as our obligation.

Inapplicable Cases

The guarantee and service offered by this document are not applicable in the following cases: ①. The product or accessory has expired its warranty period; ②. Breakage or damage caused by inappropriate usage, maintenance or preservation, such as improper packing, improper usage, improper plugging in/out external equipment, falling off or squeezing by external force, contacting or exposing to the improper temperature, solvent, acid, base, flooding and damp environments, etc; ③. Breakage or damage caused by non-authorized institution or staff in the process of installation, maintenance, alternation, addition and detachment; ④. The original identifying information of product or accessory is modified, alternated, or removed; ⑤. No valid warranty card; ⑥. Breakage or damage caused by using illegally authorized, nonstandard or non-public released software; ⑦. Breakage or damage caused by force majeure or accident; ⑧. Breakage or damage that could not be attributed to the product itself. Once met these situations above, you should seek solutions from the related responsible parties and Godox assumes no responsibility. The damage caused by parts, accessories and software that beyond the warranty period or scope is not included in our maintenance scope. The normal discoloration, abrasion and consumption are not the breakage within the maintenance scope.

Maintenance and Service Support Information

The warranty period and service types of products are implemented according to the following **Product Maintenance Information**:

Product Type	Name	Maintenance Period(month)	Warranty Service Type
Parts	Circuit Board	12	Customer sends the product to designated site
	Battery	3	Customer sends the product to designated site
	Electrical parts e.g.battery charger, power cord, sync cable, etc.	12	Customer sends the product to designated site
Other Items	Flash tube, modeling lamp, lamp body, lamp cover, lockingdevice, package, etc.	No	Without warranty

Godox After-sale Service Call 0755-29609320-8062