

Foreword

Thank you for purchasing Godox product!

E-sports LED Light ES45 Kit supports free brightness and color temperature adjustment, 2.4G wireless and smartphone APP control. It provides lighting for electronic sports, livestream, make up and video recording with compact body, easy operation and great portability.

Main Features

- 176 premium LED bulbs with all-in-one light board, offering soft light without blinding the eyes
- Freely adjust each group's brightness(0%-100%) or color temperature(2800K-6500K)
- Built-in lithium battery whose duration up to approx. 22 hours
- Can be easily controlled via detachable control panel
- Support 2.4G wireless or smartphone APP control
- OLED panel and parameters auto saved
- Simple, stylish and suitable for using on the table

⚠ Warning

- ⚠ Always keep this product dry. Do not put it in high-temperature or in damp conditions.
- ⚠ Built-in over-temperature protection functions, this product will enter protection status when the temperature is too high and back to normal after the temperature decreased.
- ⚠ Do not touch the product with wet hands. As this product do not have waterproof function, please take measures of waterproof in rainy or damp environment.

Names of Parts

• Main Body

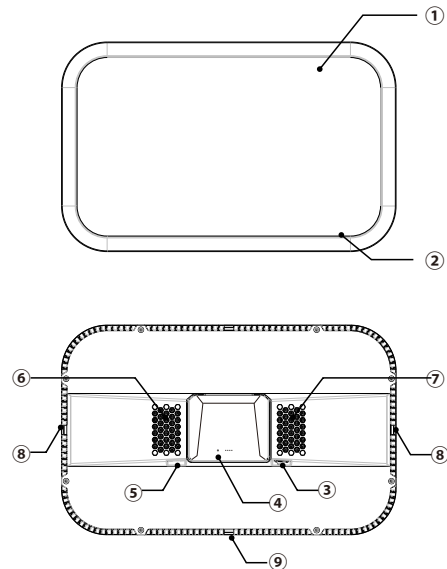

- | | |
|---------------------|-----------------------------|
| 01. 176 LED beads | 05. DC Power Socket |
| 02. light board | 06. Thermovent 1 |
| 03. Power Switch | 07. Thermovent 2 |
| 04. Indicator | 08. Bracket Mounting Hole 1 |
| 05. DC Power Socket | 09. Bracket Mounting Hole 2 |

• Function Operate Panel

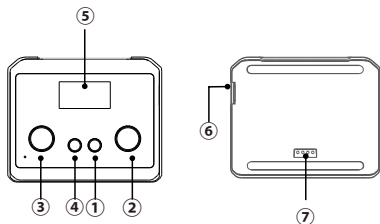

- 01. Power Switch
- 02. DIM Brightness Select Dial
- 03. CCT Color Temperature Select Dial
- 04. GR/CH Button
- 06. OLED Display (white in blue)
- 07. Type-C USB Port (only for charging)

What's in the Box

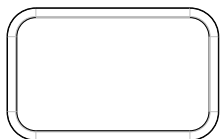

Light Body *1



Detachable Panel *1

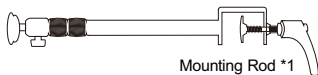

Mounting Rod *1



Power Cable *1



Adapter *1



Instruction Manual *1

Battery Management

1. Power Supply of Main Body

DC Power supply by adapter:
input: 100~240V 50/60Hz 1.3A,
output: 14V 3.42A.

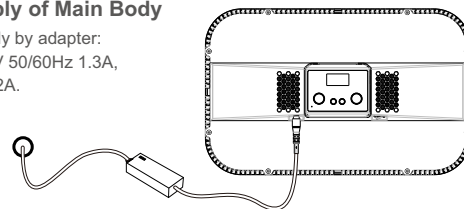

Note:

- * When connected to DC power, the control panel's battery power will be displayed in full level.
- * The included Godox adapter must be applied, otherwise, the tested parameters may not keep to the same.

2. Power Supply of Operate Panel

There are two methods to supply power for operate panel.

1. When the main body is being charged, install the operate panel onto the main body to get power.
2. Detach the operate panel from the main body. Then, charge the panel through Type-C USB cable.

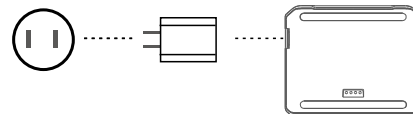

Operation

1. Using the Light

- Insert the adapter into DC port.
- Press the O- power switch to power it on, and the LED light will be lighted on.
When the blue light is always lighting the light's group is set to the same as the transmitter's and has already received the transmitter's signal, the indicator will be blinking in red.
- Short press the power switch of operate panel to power it on or off.
- The OLED panel will display the current information after being powered on.

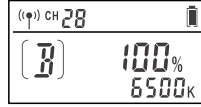

Brightness Adjustment

In normal status, turn the DIM select dial leftwards to decrease the brightness value while rightwards to increase. The light brightness can be adjusted from 0% to 100%. And the adjusted value is 1 in common adjustment and changes to 10 in quick adjustment.

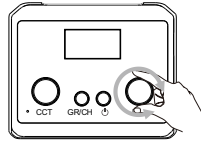

Color Temperature Adjustment

In normal status, turn the CCT select dial leftwards to decrease the color temperature value while rightwards to increase. The color temperature can be adjusted from 2800K to 6500K. And the adjusted value is 100 in common adjustment and changes to 500 in quick adjustment.

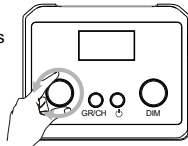

Wireless Modes Selection

1. The detachable operate panel processes 2.4G wireless remote functions.
Please put the operate panel onto the LED light and set the channel (CH) and group (GR) parameters. Then, detach the operate panel to adjust brightness, color temperature and other functions.

Note:

- The channels and groups of operate panel and LED light have been already matched by default. There is no need for resetting.
- The main body can only receive wireless signals after being powered.
- Several operate panel can be applied simultaneously. Set the channels and groups to the same as operate panel's to control the parameters of multiple LED lights.

CH Channel / GR Group Adjustment

1. **CH Channel adjustment:** In normal status, short press GR/CH button once, and the channel value is selected. Turn the CCT select dial to choose channel from 1 to 32.
2. **GR Group adjustment:** In normal status, short press GR/CH button twice, and the group value is selected. Turn the CCT select dial to choose group from A, B or C.
3. Short short press the GR/CH button thrice to exit from wireless adjustment of channels and groups.

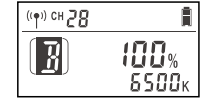
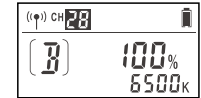

2. With smartphone APP control through Bluetooth, the operate panel can be connected to several LED lights to achieve convenient operation.

Bluetooth connection

Scan the QR code to download the "Godox Light" smartphone APP (can be used by Android and Apple system).

For more smartphone APP operations, please open the "help" in APP to gain detailed guidance.



Technical Data

Model	ESC45
DC Power Supply by Adapter	Input: 100~240V 50/60Hz 1.3A Output: 14V 3.42A
Lithium Battery of Operate Panel	3.7V Lithium battery (built-in)
Power	Up to approx.56W in max. (color temperature: 4100K)
Channel	32(1~32)
Group	3(A, B, C)
Color Temperature	2800~6500K
100% Lumen (lm)	Max. 2500
100% Luminosity (lx) (darkroom, 0.5m distance)	Max. ≈ 4100
CRI	≥96
TLCI	≥97
Brightness Range	0~100%
Control Method	Smartphone APP/2.4G Wireless
Quantity of LED Beads	176
Working Environment Temperature	-10~40°C
Dimension	367*230*31.04mm (operate panel is not included) 367*230*45.9mm (operate panel is included)
Weight	≈ 1.33KG (operate panel is included)

* Product design and specifications are subject to change without notice.

Note:

The MAC code check and Bluetooth password reset must be proceeded after the operate panel and main body have already been turned on and successfully connected.

1. MAC code check: when the operate panel and main body have been turned on, long press the GR/CH button for 2 seconds to enter the Bluetooth interface. The MAC code will be displayed on the top left.
2. Bluetooth password reset: in MAC code interface, turn the CCT select dial to choose Ψ_{ES} . Then, short press GR/CH button once, and the Bluetooth icon will be blinking, which means the password is reset. Turn the CCT select dial to choose . Then, short press the GR/CH button to back to the main interface.



Standby Functions

1. The display of operate panel will get darker automatically after detached from the main light body and without operation for 1 minute.
2. The LED light will turn off automatically after detached from the main light body and without operation for 1 hour.

Maintenance

Avoid sudden impacts and the product should be dedusted regularly.

This product, except consumables e.g. battery and adapter, is supported with a one-year warranty.

Maintenance of the flash must be performed by our authorized maintenance department which can provide original accessories.

Unauthorized service will void the warranty.

If the product had failures or was wetted, do not use it until it is repaired by professionals.

Changes made to the specifications or designs may not be reflected in this manual.

FCC Statement

This device complies with part 15 of the FCC Rules. Operation is subject to the following two conditions: (1) This device may not cause harmful interference, and (2) this device must accept any interference received, including interference that may cause undesired operation.

Any Changes or modifications not expressly approved by the party responsible for compliance could void the user's authority to operate the equipment.

Note: This equipment has been tested and found to comply with the limits for a Class B digital device, pursuant to part 15 of the FCC Rules. These limits are designed to provide reasonable protection against harmful interference in a residential installation. This equipment generates uses and can radiate radio frequency energy and, if not installed and used in accordance with the instructions, may cause harmful interference to radio communications. However, there is no guarantee that interference will not occur in a particular installation. If this equipment does cause harmful interference to radio or television reception, which can be determined by turning the equipment off and on, the user is encouraged to try to correct the interference by one or more of the following measures:

- Reorient or relocate the receiving antenna.
- Increase the separation between the equipment and receiver.
- Connect the equipment into an outlet on a circuit different from that to which the receiver is connected.
- Consult the dealer or an experienced radio/TV technician for help.

This equipment should be installed and operated with minimum distance 20cm between the radiator and your body.



Warranty

Dear customers, as this warranty card is an important certificate to apply for our maintenance service, please fill in the following form in coordination with the seller and safekeep it. Thank you!

Product Information	Model	Product Code Number
Customer Information	Name	Contact Number
	Address	
Seller Information	Name	
	Contact Number	
	Address	
	Date of Sale	
Note:		

Note: This form shall be sealed by the seller.

Applicable Products

The document applies to the products listed on the **Product Maintenance Information** (see below for further information). Other products or accessories (e.g. promotional items, giveaways and additional accessories attached, etc.) are not included in this warranty scope.

Warranty Period

The warranty period of products and accessories is implemented according to the relevant Product Maintenance Information. The warranty period is calculated from the date (purchase date) when the product is bought for the first time. And the purchase date is considered as the date registered on the warranty card when buying the product.

How to Get the Maintenance Service

If maintenance service is needed, you can directly contact the product distributor or authorized service institutions. You can also contact the Godox after-sale service call and we will offer you service. When applying for maintenance service, you should provide valid warranty card. If you cannot provide valid warranty card, we may offer you maintenance service once confirmed that the product or accessory is involved in the maintenance scope, but that shall not be considered as our obligation.

Inapplicable Cases

The guarantee and service offered by this document are not applicable in the following cases: ①. **The product or accessory has expired its warranty period;** ②. **Breakage or damage caused by inappropriate usage, maintenance or preservation, such as improper packing, improper usage, improper plugging in/out external equipment, falling off or squeezing by external force, contacting or exposing to the improper temperature, solvent, acid, base, flooding and damp environments, etc;** ③. **Breakage or damage caused by non-authorized institution or staff in the process of installation, maintenance, alternation, addition and detachment;** ④. **The original identifying information of product or accessory is modified, alternated, or removed;** ⑤. **No valid warranty card;** ⑥. **Breakage or damage caused by using illegally authorized, nonstandard or non-public released software;** ⑦. **Breakage or damage caused by force majeure or accident;** ⑧. **Breakage or damage that could not be attributed to the product itself.** Once met these situations above, you should seek solutions from the related responsible parties and Godox assumes no responsibility. The damage caused by parts, accessories and software that beyond the warranty period or scope is not included in our maintenance scope. The normal discoloration, abrasion and consumption are not the breakage within the maintenance scope.

Maintenance and Service Support Information

The warranty period and service types of products are implemented according to the following **Product Maintenance Information**:

Product Type	Name	Maintenance Period(month)	Warranty Service Type
Parts	Circuit Board	12	Customer sends the product to designated site
	Battery	3	Customer sends the product to designated site
	Electrical parts e.g. battery charger, power cord, sync cable, etc.	12	Customer sends the product to designated site
Other Items	Flash tube, modeling lamp, lamp body, lamp cover, locking device, package, etc.	No	Without warranty

Godox After-sale Service Call **0755-29609320-8062**