

GODOX设计文件图注			
项目类型	<input type="checkbox"/> 彩盒 <input type="checkbox"/> 彩卡 <input type="checkbox"/> 白盒 <input type="checkbox"/> 贴纸 <input checked="" type="checkbox"/> 说明书 <input type="checkbox"/> 内托 <input type="checkbox"/> 胶盒 <input type="checkbox"/> 吸塑 <input type="checkbox"/> 其他:		
项目名称	GODOX_V850III 说明书		
产品料号	705-V85030-00	版本	A
展开尺寸(mm)		成品尺寸(mm)	80x195mm
尺寸公差	±2mm		
材质	105g铜版纸单色印刷		
工艺说明	骑马钉		
备注/色值			
设计师	陈正丰	校对	杨入人

705-V85030-00

godox

锂电顶闪光灯
Pioneering Li-ion Camera Flash

V850^{III}



说明手册
INSTRUCTION MANUAL

深圳市神牛摄影器材有限公司

地址: 深圳市宝安区福海街道塘厦社区福川工业区厂房2栋
电话: 0755-29609320(8062) 传真: 0755-25723423 邮箱: godox@godox.com

GODOX Photo Equipment Co., Ltd.

Add: Building 2, Yaochuan Industrial Zone, Tangwei Community, Fuhai Street, Bao'an District,
Shenzhen, China Tel: +86-755-29609320(8062) Fax: +86-755-25723423
E-mail: godox@godox.com

godox.com

Made in China



在使用本产品之前:

请先仔细阅读本手册, 以确保您能安全使用。请保存好本手册以备将来查询参考。

Before using this product:

Please read this user manual carefully in order to ensure your safety and the proper operation of this product. Keep for future reference.

前言

感谢您购买神牛产品。

神牛锂电机顶闪光灯V850III采用神牛无线X系统,内置2.4G无线传输,可兼容AD360II-C、AD360II-N、TT685C、TT685N、X1T-C、X1T-N等无线控制系统。适用于各种品牌中带标准热靴的单反相机,包括佳能、尼康、宾得、奥林巴斯等。

产品特点突出表现在以下几方面:

- GN60 (m ISO 100, @200mm), 22级调光(1/1~1/128)
- 专业锂电, 优质体验
2600mAh锂聚合物电池, 全功率450次闪光, 1.5秒快速回电
- 内置2.4G无线传输
收发一体, 超远距离, 创意无限
- 拓展功能, 无限享用
高速同步, 无线功控, 高速频闪, 手动辅助对焦
- 光学研究, 输出稳定
高速连闪输出亮度和色温一致, 光线均匀分布
- 面板大气, 简单快捷
高清LCD液晶显示屏直观显示, 手感良好, 操作三步到位

警告

- ▲ 请保持干燥。
- ▲ 请勿私自拆卸产品, 如产品出现故障须由本公司或授权的维修人员进行检查维修。
- ▲ 请勿让儿童接触本产品。
- ▲ 禁止拆卸、撞击、挤压或投入火中, 若出现严重鼓胀, 请勿继续使用。请勿放置在超过50度的高温环境中。
- ▲ 请勿将闪光灯头正对人眼闪光(特别是婴儿的眼睛), 否则可能会在短时间内造成视力障碍。
- ▲ 请勿在化学品、可燃性气体或其他特殊物质附近使用闪光灯, 这些物质在特殊情况下可能对闪光灯发出的瞬间强光敏感, 有可能导致火灾或电磁干扰。在这些场合下, 请注意相关警告标识。
- ▲ 本产品不能防水, 在雨天及潮湿环境下请注意防水。
- ▲ 若发生任何故障, 请立即关闭闪光灯电源。

目录

01	前言
02	警告
05	部件名称
	机身
	控制面板
	LCD液晶显示屏
	标配物品
	可选购附件
07	电池
07	装卸闪光灯
08	使用闪光灯
	电源管理
	功率选择
	ZOOM: 设置闪光覆盖范围
	M普通模式
	Multi频闪模式
	S1光控模式
	S2光控模式
	H 高速同步模式
	对焦灯自定义功能
	蜂鸣控制
	无线闪光拍摄: 无线电(2.4G)传输
	同步插孔触发
	睡眠时间自定义功能
	C.Fn 自定义功能
13	保护功能
14	拍摄技巧
16	规格参数
16	维护保养

本说明书中使用的约定

- 此使用说明书中的操作步骤假定相机和闪光灯的电源开关已开启。
- 参考页码由(第**页)表示。
- 此使用说明书中使用以下警告符号:
 - ▲ 该“小心”符号表示避免出现拍摄问题的警告。
 - 该“注意”符号提供补充信息。

部件名称

• 机身

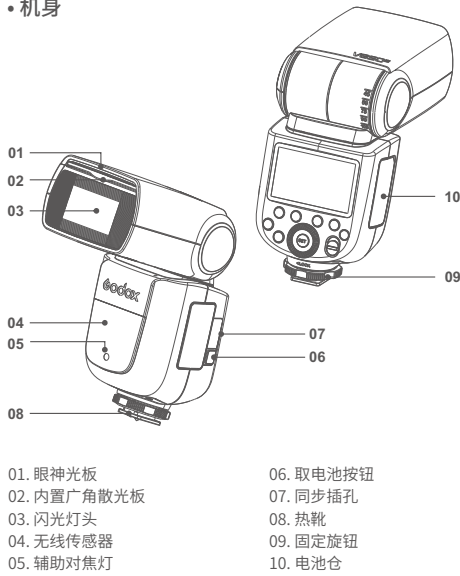

- | | |
|-------------|-----------|
| 01. 眼神光板 | 06. 取电池按钮 |
| 02. 内置广角散光板 | 07. 同步插孔 |
| 03. 闪光灯头 | 08. 热靴 |
| 04. 无线传感器 | 09. 固定旋钮 |
| 05. 辅助对焦灯 | 10. 电池仓 |

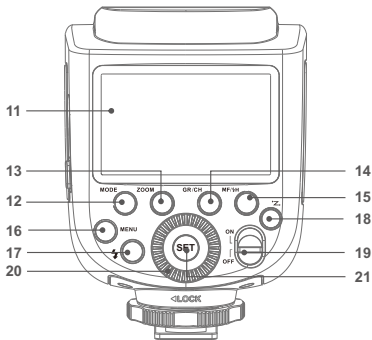

• 控制面板

- | | |
|--------------------------------|-----------------|
| 11. 显示屏 | 16. MENU 闪光灯菜单 |
| 12. MODE 闪光灯模式选择 | 17. 试闪按钮/回电指示灯 |
| 13. ZOOM 焦距设置 | 18. 无线设置按钮 |
| 14. GR/CH 组别/频道设置 (长按键) | 19. ON/OFF 电源开关 |
| 15. MF/SH 辅助对焦灯开关/高速同步按钮 (长按键) | 20. 调节拨轮 |
| | 21. SET 设置按钮 |

• LCD液晶显示屏

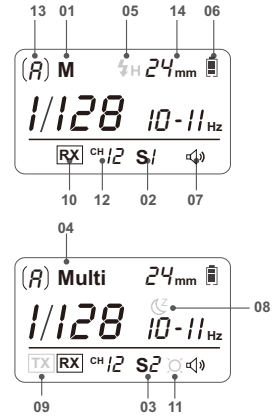

- | | |
|-----------------|----------------|
| 01. <M>手动闪光模式 | 08. <☾>休眠状态 |
| 02. <S1>S1预防闪 | 09. TX主控模式 |
| 03. <S2>S2预防闪 | 10. RX从属模式 |
| 04. <Multi>高速频闪 | 11. <O>对焦灯点亮提示 |
| 05. <4H>高速同步触发 | 12. 频道 |
| 06. 电池电量显示 | 13. 组别 |
| 07. <A>声音提示 | 14. 变焦焦距 |

• 标配物品

1. 灯体 2. 锂电池 3. 微型底座 4. 充电器电源线 5. 电池充电器
6. 保护包 7. 说明书

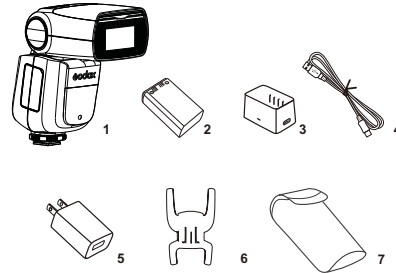

• 可选购附件

可搭配本公司以下摄影附件使用,以获得最佳的拍摄效果和使用体验:
XPro、X2、X1 TTL引闪器、迷你柔光箱、反光板、蜂巢、色片、束光布等。



电池

• 特性

1. 本品采用锂聚合物电池，支持反复充放电500次，使用寿命长。
2. 安全可靠，内置电路有过充保护、过放保护、过流保护、短路保护。
3. 使用标配电池充电器只需2.5个小时左右。

• 注意事项

1. 避免正负极短路；
2. 电池没有防水功能，不要把电池浸泡在雾、水中；
3. 放置于儿童不易接触的地方；
4. 电池充电不要放置超过24小时；
5. 电池应放置于凉爽、干燥及通风的地方存储；
6. 电池不要靠近和放置于火中；
7. 电池使用报废后请按当地的规定处理；
8. 如果电池超过3个月不使用，请对电池进行满电充电。
9. 长期不使用，请充电至60%左右再放置。
10. 反复充放电500次以上或电池使用3年以上，建议更换新电池。

• 装卸电池

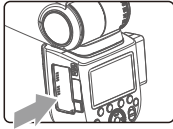

- 1 拆卸电池。
 - 用您的拇指按电池按钮，手往下推电池，便可取出电池。

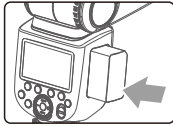

- 2 安装电池。
 - 按电池指示方向将锂电池插入电池仓，直至扣件卡住即可。

• 电池电量指示

把锂电池正确安装在闪光灯上，即可给闪光灯供电。使用时请查看闪光灯屏幕上电池图标，即可随时掌握电量状态。

电池电量显示	意义
3格	满电
2格	中电
1格	低电
无格	电量少，请及时充电。
无格闪烁	电量即将用尽，此状态不支持闪光灯工作。 注：此状态请尽快(10天内)充电，才可使用或放置。

装卸闪光灯

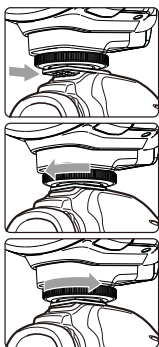

- 1 安装闪光灯。
 - 转动闪光灯旋转钮到左边便可以全插入相机的热靴。
- 2 扣紧闪光灯。
 - 转动闪光灯旋转钮到右边，便可以锁定热靴。
- 3 取下闪光灯。
 - 按下旋转钮上的按键，旋转到左边，便可解除锁定热靴。

使用闪光灯

1. 电源管理

ON/OFF电源开关控制V850III的打开和关闭，长时间不使用时请关闭电源。本产品设有睡眠功能，在长时间无人操作时，闪光灯会进入睡眠状态。具体睡眠时间设定，请参考后面说明。

2. 功率选择

您可以在1/128功率至1/1全功率间以1/3档为增量设置闪光输出。为获得正确的闪光曝光，请使用手持的闪光测光表确定所需的闪光输出。旋转调节旋钮<⊙>可以调节闪光输出，调节规则如下：

减小闪光输出指数 →

1/1	1/1-0.3	1/1-0.7	1/2	1/2-0.3	1/2-0.7	1/4	...	OF
	1/2+0.7	1/2+0.3		1/4+0.7	1/4+0.3		...	

← 增加闪光输出指数

▲ 当显示屏显示“OF”时，表示闪光无输出，即不能引闪。

3. ZOOM: 设置闪光覆盖范围

手动设置闪光覆盖范围以匹配20-200毫米的镜头焦距。按<ZOOM>按钮，旋转调节旋钮<⊙>可以更改闪光覆盖范围。

▲ 设置闪光覆盖范围时，确保其覆盖镜头焦距，这样可以避免照片出现阴影边缘。

4. M 普通模式

通过按MODE模式选择按钮<MODE>，可以使闪光灯进入M模式。在M模式下，闪光灯可以安装到相机或触发器热靴上进行引闪。拍摄时您只需要设定闪光输出，调整相机并按下快门，闪光灯会在相机同步信号下进行闪光。此模式下光控关闭。

5. Multi 频闪模式

按MODE模式选择按钮<MODE>，可以使闪光灯进入Multi模式。Multi模式下，使用频闪闪光，可以发出一系列快速的闪光。它可以在一张照片上拍摄移动物体的多个图像。您可以设置闪光频率(每秒的闪光次数，以Hz表示)、闪光次数和闪光输出。

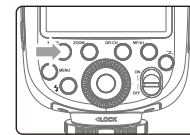

- 1 按<MODE>模式选择按钮，屏幕显示<Multi>。

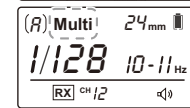

- 2 按下<SET>设置按钮，选择调节项目闪烁。

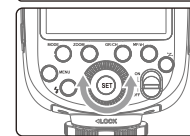

- 3 旋转调节旋钮<⊙>，调整数值。

计算快门速度

在频闪闪光过程中，到闪光停止为止快门应保持开启状态。使用下面的公式计算快门速度，然后用相机进行设置。

$$\text{闪光次数} / \text{闪光频率} = \text{快门速度}$$

例如，如果闪光次数是10，闪光频率是5Hz，快门速度则至少为2秒。

- ❗ * 反光很强的被摄体在暗背景前使用频闪闪光更加有效。
- * 推荐使用三脚架和遥控开关。
- * 闪光输出为1/1和1/2时不能设置频闪闪光。
- * 频闪闪光时也可以使用“buLb”。

最大频闪闪光次数

闪光输出	Hz	1	2	3	4	5	6-7	8-9
1/4		7	6	5	4	4	3	3
1/8		14	14	12	10	8	6	5
1/16		30	30	30	20	20	20	10
1/32		60	60	60	50	50	40	30
1/64		90	90	90	80	80	70	60
1/128		100	100	100	100	100	90	80

闪光输出	Hz	10	11	12-14	15-19	20-50	60-199
1/4		2	2	2	2	2	2
1/8		4	4	4	4	4	4
1/16		8	8	8	8	8	8
1/32		20	20	20	18	16	12
1/64		50	40	40	35	30	20
1/128		70	70	60	50	40	40

⚠ 为防止闪光灯头在频闪过程中因过热损坏，请勿执行连续10次以上的频闪闪光连拍。

6. S1 光控模式

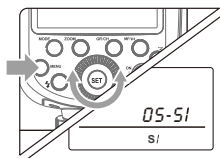

- 按MENU按钮进入用户菜单。
 - 按<SET>按钮选择OS，通过旋钮<⊙>选择OFF/S1/S2。
- 在OS模式下，闪光灯可作为副灯使用，创造多种照明效果，适用于手动闪光环境。它会与主闪光灯的第二次闪光同步触发闪光，效果与使用无线引闪器一致。

7. S2 光控模式

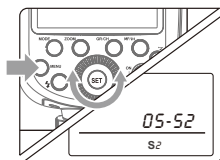

- 按MENU按钮进入用户菜单。
 - 按<SET>按钮选择OS，通过旋钮<⊙>选择OFF/S1/S2。
- S2模式下，可以做副灯使用，适用于TTL闪光环境。具有防预闪功能，使用带一次预闪功能的相机能用光控实现同步拍摄。它会与主闪光灯的第二次闪光同步触发闪光，即2次光控引闪。

8. 4H高速同步模式

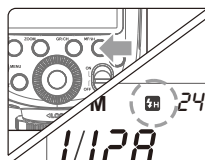

- 长按<MF/4H>按钮2秒可以使闪光灯进入4H模式。
- 如果想退出4H高速同步模式请按MODE模式或者长按<MF/4H>按钮超过2秒。
- 在高速同步模式下，使用高速同步遥控器，您可以实现闪光灯与相机所有快门速度的高速同步，最高可达1/8000秒(由相机决定)。开启高速同步模式，在使用光圈优先对人像进行填充闪光时特别方便。

❗ 注：
* 高速同步模式必须配合下列遥控器才可实现其功能。
(TTL 无线引闪器X1/X2/XPro系列)
* V850III 插在相机热靴上无法实现高速同步功能。

⚠ 为防止闪光灯头在高速连闪时因过热损坏，连续执行15次高速同步闪光后，系统会自动进入热保护，回电时间会比正常延时10秒。

9. 对焦灯自定义功能

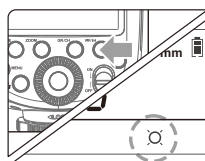

- 在低照度或低对比度等相机无法自动对焦情况下，通过按<MF/4H>按钮，可以点亮对焦灯，协助相机进行对焦。
- 无引闪时，辅助对焦灯数秒后会自动熄灭，从最后一次引闪到对焦灯自动熄灭之间的时间，用户可自行设置，出厂默认为10秒。
- 按MENU按钮，可以进入自定义设置状态；按SET按钮进入“FC”调整状态，液晶屏显示“FC”（FC表示无引闪时，辅助对焦灯会自动关闭）；拨动调节旋钮<⊙>调节对焦时间；按<zoom>按钮返回到上一层。

对焦辅助自动关闭时间设置	意义
10秒	无引闪时，离最后一次引闪10秒后辅助对焦灯自动熄灭。
20秒	无引闪时，离最后一次引闪20秒后辅助对焦灯自动熄灭。
30秒	无引闪时，离最后一次引闪30秒后辅助对焦灯自动熄灭。

10. 蜂鸣控制

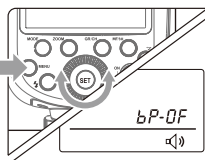

- 本机带有蜂鸣功能，通过按MENU按钮，可以进入自定义设置状态；按SET按钮进入“bP”调整状态。
- ON: 开蜂鸣，OF: 关蜂鸣
- 蜂鸣器处于打开状态时，显示屏的<⊙>符号会显示。

11. 无线闪光拍摄：无线电(2.4G) 传输

- V850III 是具有无线电传输无线拍摄功能的闪光灯(主控/从属), 轻松利用高级无线多重闪光照明进行拍摄。
- **无线模式设置:** 通过按 **之** 无线设置按钮设定TX/RX模式。
- **频道设置:** 通过长按 **<GR/CH>** 按钮2秒直至CH旁数值闪烁, 此时可通过旋钮设定频道1~32。
- **组别设置:** 通过短按 **<GR/CH>** 按钮设置组别, 在TX和RX模式下都有: A/B/C/D/E。
- **ID设置:** 按MENU进入菜单, 按SET按钮选择ID, 通过旋钮设定ID号OFF/1~99。
- V850III 采用神牛无线X系统, 可兼容XPro系列、X2T系列、X1T系列、QT600III、V860II系列、TT685系列、V860III系列、V1系列、TT585系列、V350系列、TT350系列、TT600系列、MS系列、DPIII系列、SKII系列、AD360II系列、AD1200Pro、AD400Pro、AD100Pro、AD200、AD600Pro系列、AD200Pro、AD300Pro无线控制。

定位和操作范围(无线闪光拍摄的示例)

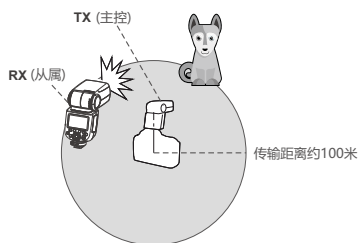

12. 同步插孔触发

同步插孔规格为Φ2.5mm, 此处可插入同步线或者触发器触发插头对闪光灯进行同步引闪。

13. 睡眠时间自定义功能

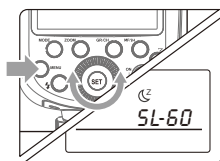

- 本产品设计有睡眠功能, 可避免长时间不操作消耗电池电量。
- 通过按 **<MENU>** 按钮, 可以进入自定义设置, 按SET按钮进入"SL"调整状态。液晶屏显示"SL"(Sleep表示睡眠)和"睡眠时间", 本产品出厂模式睡眠时间设置为10分钟, 拨动调节旋钮 **<C>** 即可更改睡眠时间或关闭睡眠功能。按 **<MENU>** 按钮返回到上一层。

睡眠时间设置	意义
OF	表示睡眠功能已关闭, 闪光灯不会自动休眠。
3	睡眠时间设置为3分钟。
10	睡眠时间设置为10分钟。
30	睡眠时间设置为30分钟。
60	睡眠时间设置为60分钟。

- 当闪光灯进入睡眠状态时, 显示屏将出现 **"☾"** 符号。
- 要唤醒闪光灯, 可以按下闪光灯任意键, 或者按下相机快门, 或者按下触发器的试闪按钮。

注: 无特殊需要时, 请设置短的睡眠时间, 可以延长闪光灯的工作时间!

14. C.Fn 自定义功能

符号	功能	设置与说明	操作说明
SL	睡眠时间设置	可设置时间: <3> 3分钟 <10> 10分钟 <30> 30分钟 <60> 60分钟 <OF> 无(OFF)	1. 按 <MENU> 按钮进入自定义设置状态; 2. 旋转 <C> 调节旋钮调节睡眠时间; 3. 按 <MENU> 按钮返回。 * 按任意按钮可唤醒; * 无需要时请设置短的睡眠时间, 这可以延长闪光灯的工作时间!
FC	对焦辅助自动关闭时间设置	<10> 10秒 <20> 20秒 <30> 30秒	1. 按 <MENU> 按钮进入自定义设置状态; 2. 按 <SET> 按钮进入"FC"调整状态; 3. 旋转 <C> 调节旋钮可调节; 4. 按 <MENU> 按钮返回。
BP	蜂鸣器功能设置	<ON> 开On <OF> 关Off	1. 按 <MENU> 按钮进入自定义设置状态; 2. 按 <SET> 按钮进入"bp"调整状态; 3. 旋转 <C> 调节旋钮可调节; 4. 按 <MENU> 按钮返回。
BL	背光设置	当操作按钮时, 背光亮可设置为: <ON>:持续点亮 <12>:点亮12秒 <OF>:熄灭	1. 按 <MENU> 按钮进入自定义设置状态; 2. 按 <SET> 按钮进入"bl"调整状态; 3. 旋转 <C> 调节旋钮可调节; 4. 按 <MENU> 按钮返回。
OS	光接收模式	<OF> 关闭 <S1> S1模式 <S2> S2模式	1. 按 <MENU> 按钮进入自定义设置状态; 2. 按 <SET> 按钮进入"OS"调整状态; 3. 旋转 <C> 调节旋钮可调节; 4. 按 <MENU> 按钮返回。

- 全显功能: 按住MENU+MODE, 开机可观看显示屏, 画面清晰。
- 查看软件版本号: 按住SET键开机, 可查看版本号。

保护功能

1. 热保护

- 为防止闪光灯过热并损坏，请勿在1/1功率时进行超过30次的快速连续闪光。30次连续闪光后，要让闪光灯至少冷却10分钟。
- 如您在进行超过30次连续闪光后马上继续进行更多次闪光，内部的防过热功能可能会被激活，使充电时间变为10秒以上。如果发生这种现象，请让闪光灯冷却约10分钟，闪光灯便会恢复正常。
- 热保护启动后，显示屏上  的符号会显示。

激活热保护功能的连续闪光次数：

次数 档位	ZOOM (mm)	20 - 200
1/1		35
1/2		50
1/4		100
1/8		200
1/16		300
1/32		500
1/64		1000
1/128		2000

高速同步模式下，激活热保护功能的连续闪光次数：

次数 档位	ZOOM (mm)	20 - 200
1/1		30
1/2		30
1/4		34
1/8		40
1/16		50
1/32		50
1/64		60
1/128		60

2. 其他保护

- 为了保证设备安全的工作，系统时刻进行预防保护，以下提示符号供您参考：

LCD显示	警示内容
E1	闪光灯回电系统出现问题，无法回电引闪，请重新开机，如无法解决请维修
E2	设备内温度过高，请停止引闪10分钟
E3	闪光灯管两端电压过高，请维修
E9	固件升级有误，请进行正确固件升级

拍摄技巧

反射闪光

通过将闪光灯头指向墙壁或天花板，闪光在照亮被摄体前被墙面反射。这可以减轻被摄物体背后的阴影，获得更自然的摄影效果。称之为反射闪光。

旋转闪光灯头来设置反射方向。

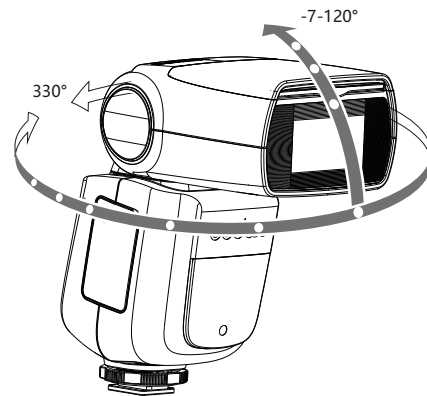

- 如果墙壁或天花板太远，反射闪光可能太弱并导致曝光不足。
- 墙壁或天花板应该是平坦的、白色的以利于高效的反射。如果反射表面不是白色的，照片将出现偏色。

创造眼神光

使用眼神光板，可以在被摄体的眼睛中创造眼神光以使面部表情更加生动。

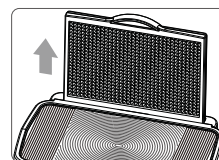

1 将闪光灯头向上旋转 90°。

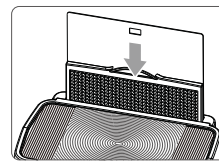

2 拉出广角散光板，同时弹出眼神光板。

3 推入广角散光板。
• 仅推入广角散光板。
• 按照反射闪光中相同的步骤进行。

- 请将闪光灯头向前指然后向上旋转90度。如果左右旋转闪光灯头就不会产生眼神光。
- 要获得最好的眼神光效果，被摄体不能处于相机1.5米/4.9英尺以内。

使用广角散光板

拉出广角散光板并将其置于闪光灯头上,使闪光范围扩大,闪光效果将更加柔和自然。

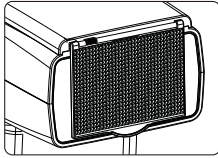

- 拉出广角散光板并将其置于闪光灯头上。闪光覆盖范围将扩展至 14 毫米。
- 同时弹出眼神光板。请推回眼神光板。

⚠ 神牛2.4G无线漏闪原因及解决办法

1. 外部环境2.4G信号干扰(如无线基站、2.4Gwifi路由、蓝牙设备等)
→ 请调节引闪器的频道CH设置(建议+10),找到无干扰的频道来工作,或者在工作时关闭其他2.4G设备。
2. 请确认闪光灯是否已经回电或者回电速度已经跟上连拍速度(闪光灯就绪指示灯已经亮起),并且没有处于过热保护或者其他异常状态中
→ 请下调闪光灯的档位。
3. 是否引闪器和闪光灯距离太近(距离<0.5m)
→ 请在引闪器上打开“近距离无线模式”:
X1系列:按住引闪按钮不放,然后开机,直至指示灯闪2次。
Xpro系列:设置C.Fn-DIST为0-30m。
4. 是否引闪器和接收端设备在低电状态
→ 请更换电池(引闪器电池建议使用1.5V一次性碱性电池)。

规格参数

型号	V850III
功率 (1/1档位)	76Ws
闪光指数(1/1档位, 200mm焦距)	GN≈60 (m ISO100)
闪光覆盖范围	20-200毫米 • 手动变焦 • 闪光灯头旋转/倾斜,水平0-360°, 垂直-7°~90°(反射闪光)
闪光持续时间	1/300秒-1/20000秒 • 无线闪光(无线电2.4G传输)
无线功能	主控单元,从属单元,关闭
主控单元组	A, B, C, D
可控制从属单元组	A, B, C, D, E (E组可使用X系列的引闪器控制)
传输范围(约)	100m
频道	32组: 01~32
ID	01~99
• 电源	
内置锂电	7.2V/2600mAh 锂电池
回电时间	约1.5秒,闪光灯就绪,LED绿色指示灯亮起
全功率闪光次数	约450次
节能	可设置无操作3、10、30、60分钟后进入休眠状态
• 同步触发方式	热靴, 2.5mm同步线
• 尺寸	
体积	199*71.5*60 mm
净重(不含电池)	390g
重量(含电池)	500g

维护保养

- 闪光灯在工作时,如发现异常,应立即关掉电源,查明原因。
- 灯体应避免震动,平时注意表面除尘。
- 灯体稍有发热为正常现象,无特别需要时,勿连续引闪。
- 闪光灯的所有维修概由本厂指定可供原厂配件之维修部负责。
- 一年保修,消耗品如灯管等,不在一年保修范围。
- 经发现,擅自检修此闪光灯的,将取消闪光灯之一年保修期,维修需要收取相关费用。
- 如果本品出现故障或者被水淋湿,在专业人员维修后方可继续使用。
- 如有技术更改,恕不另行通知。

本设备包含型号核准代码为: CMIIT ID:2020DP13510, 为该产品的无线电发射模块。

Foreword

Thank you for purchasing this product.

This V850III camera flash adopts Godox wireless X system and 2.4G ratio transmission, which is compatible with AD360II-C, AD360II-N, TT685C, TT685N, X1T-C, X1T-N, etc. Fit all DSLR camera brands e.g. Canon, Nikon, Sony, etc.

This camera flash features:

- GN60 (m ISO 100, @200mm). Adjust from 1/1 to 1/128 in 1/3rd stops
- Professional 2600mAh lithium battery offers 450 flashes and 1.5s recycle
- Built-in 2.4G wireless transmission to support transmitting and receiving
- High speed sync, wireless remote control, multi flash and manual focus assist
- Stable consistency and color temperature with good even lighting
- User-friendly LCD display & control panel



⚠ Warning

- ⚠ Always keep this product dry. Do not use in rain or in damp conditions.
- ⚠ Do not disassemble. Should repairs become necessary, this product must be sent to an authorized maintenance center.
- ⚠ Keep out of reach of children.
- ⚠ Stop using this product if it breaks open due to extrusion, falling or strong hit. Otherwise, electric shock may occur if you touch the electronic parts inside it.
- ⚠ Do not fire the flash directly into the eyes (especially those of babies) within short distances. Otherwise visual impairment may occur.
- ⚠ Do not use the flash unit in the presence of flammable gases, chemicals and other similar materials. In certain circumstance, these materials may be sensitive to the strong light emitting from this flash unit and fire or electromagnetic interference may result.
- ⚠ Do not leave or store the flash unit if the ambient temperature reads over 50°C. Otherwise the electronic parts may be damaged.
- ⚠ Turn off the flash unit immediately in the event of malfunction.

Contents

17	Foreword
18	Warning
21	Name of Parts
	Body
	Control Panel
	LCD Panel
	What's in the Box
	Separately Sold Accessories
23	Battery
24	Attaching to a Camera
24	Using the Flash
	Power Management
	Flash Output
	ZOOM: Setting the Flash Coverage
	M Mode: Manual Mode
	Multi Mode: Stroboscopic Flash
	S1 Mode
	S2 Mode
	 Hi-Speed Sync Triggering
	Custom Function----Focus Assist Beam
	Buzz Function
	Wireless Flash Shooting: Radio (2.4G) Transmission
	Sync Triggering
	Custom Function----Sleep Function
	C.Fn Setting Custom Functions
31	Protection Function
32	Advanced Application
34	Technical Data
34	Maintenance

Conventions used in this Manual

- This manual is based on the assumption that both the camera and camera flash's power switches are powered on.
- Reference page numbers are indicated by "p.**".
- The following alert symbols are used in this manual:
 -  The Caution symbol gives supplemental information.
 -  The Note symbol indicates a warning to prevent shooting problem.

Name of Parts

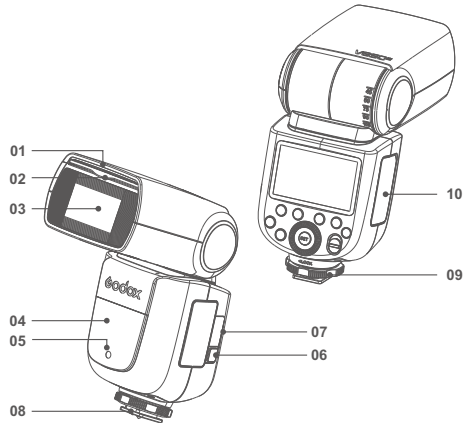

• Body

- | | |
|-------------------------------------|----------------------------|
| 01. Catchlight Panel | 06. Battery Release Button |
| 02. Built-In Wide Panel (Retracted) | 07. Sync Cord Jack |
| 03. Flash Head | 08. Hotshoe |
| 04. Optic Control Sensor | 09. Lock Ring |
| 05. Focus Assist Beam | 10. Battery Compartment |

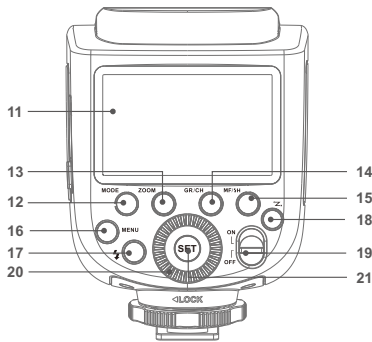

• Control Panel

- | | |
|---|---------------------------------------|
| 11. Display | 16. MENU Flash Menu |
| 12. MODE Flash Mode Selection | 17. Test Button/Flash Ready Indicator |
| 13. ZOOM Zoom Setting | 18. Σ Wireless Setting Button |
| 14. GR/CH Group/Channel Setting (long press) | 19. ON/OFF Power Switch |
| 15. MF/H Focus Assist Beam/High-speed Sync (long press) | 20. Select Dial |
| | 21. SET Set Button |

• LCD Panel

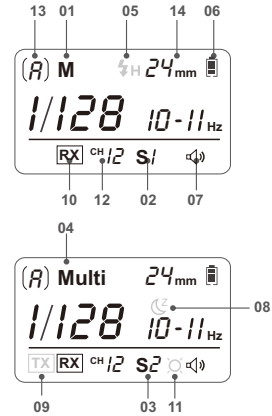

- | | |
|---|---|
| 19. <M>Manual Flash Mode | 25. <[Beep Icon]> Sound Beep Indication |
| 20. <S1>S1 Slave Flash Triggering | 26. <[Sleep Icon]> Sleep Status |
| 21. <S2>S2 Slave Flash Triggering | 27. TX Transmitter Mode |
| 22. <Multi>Multi/Stroboscopic Flash Mode | 28. RX Receiver Mode |
| 23. <H>High Speed Sync Triggering | 29. <[Beam Icon]> Focus Assist Beam Indicator |
| 24. <[Battery Icon]> Battery Level Indication | 30. Channel |
| | 31. Group |
| | 32. Zoom focal length |

• What's in the Box

- Flash Unit
- Li-ion Battery Pack
- Mini Stand
- Battery Charger Cable
- Battery Charger
- Protection Case
- Instruction Manual

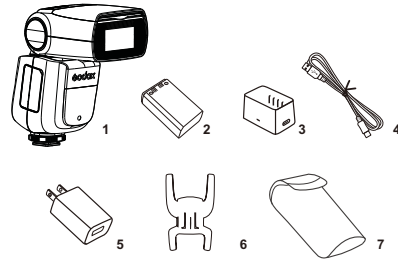

• Separately Sold Accessories

The product can be used in combination with the following accessories sold separately, so as to achieve best photography effects: X1, X2 and XPro TTL wireless flash trigger, Mini softbox, White & Silver Reflector, Honeycomb, Color gels, Snoot, etc.

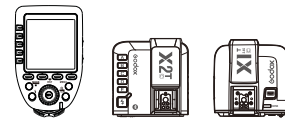

Battery

• Features

1. This flash unit uses Li-ion polymer battery which has long runtime. The available charge-and-discharge times are 500.
2. It is reliably safe. The inner circuit is against overcharge, overdischarge, overcurrent, and short circuit.
3. Take only 2.5 hours to fully charge the battery by using the standard battery charger.

• Cautions

1. Do not short circuit.
2. Do not expose to rain or immerse into water. This battery is not water proof.
3. Keep out of reach of children.
4. No over 24 hours' continuous charging.
5. Store in dry, cool, ventilated places.
6. Do not put aside or into fire.
7. Dead batteries should be disposed according to local regulations.
8. If the battery had ceased using for over 3 months, please make a full recharge.
9. If do not use it for a long time, please charge the battery to approx. 60% before placing it.
10. It is recommended to use a brand-new battery after charging and discharging over 500 times or being used over 3 years.

• Loading and Unloading the Battery

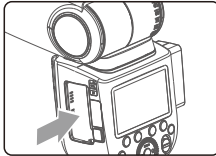

- 1 To unload the battery, hold down the battery remove button and push the battery downwardly to take it out.

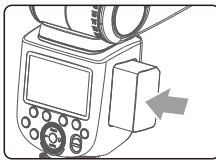

- 2 According to the triangle sign on the battery pack, insert it into the compartment until a white knob locks the battery with a click sound.

• Battery Level Indication

Make sure the battery pack is securely loaded in the flash. Check the battery level indication on the LCD panel to see the remaining battery level.

Battery Level Indication	Meaning
3 grids	Full
2 grids	Middle
1 grid	Low
Blank grid	Lower battery, please recharge it.
Blinking	The battery level is going to be used out immediately. And the flash will auto power off in 1 minute. Note: Please recharge the battery as soon as possible (within 10 days). Then, the battery can be used or be placed for long period.

Attaching to a Camera

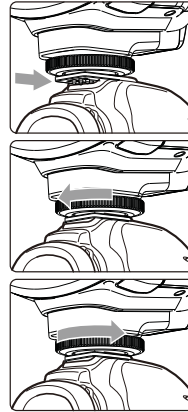

- 1 Attach the Camera Flash.
 - Rotate the hotshoe fixing buckle to the left and insert the camera flash into the camera's hotshoe.
- 2 Secure the Camera Flash.
 - Rotate the hotshoe fixing buckle to the right until it locks up.
- 3 Detach the Camera Flash.
 - Press the button and rotate the hotshoe fixing buckle to the left until it is loosened.

Using the Flash

1. Power Management

Use ON/OFF Power Switch to power the flash unit on or off. Turn off if it will not be used for an extended period of time. This flash unit has Sleep Function and will enter into sleep status when there is no operation for a long time. For Sleep Function setting, see the following instruction.

2. Flash Output

- Flash output can be varied from 1/128th power to 1/1 full power in 1/3 stop increments. To obtain a correct flash exposure, use a hand-held flash meter to determine the required flash output.
- Adjust the power output by rotating Select Dial . The following table makes it easier to see how the stop changes in terms of/ stop when you increase or decrease the flash output:

Figures displayed when reducing flash output level →

1/1	1/1-0.3	1/1-0.7	1/2	1/2-0.3	1/2-0.7	1/4	...	OF
	1/2+0.7	1/2+0.3		1/4+0.7	1/4+0.3		...	

← Figures displayed when increasing flash output level

▲ When "OF" is shown on the LCD display, it means no flash output and flash firing is turned off.

3. ZOOM: Setting the Flash Coverage

The flash coverage can be set to match the lens focal length from 20 mm to 200 mm. Press <ZOOM> button and rotate Select Dial <⊙> to change the flash coverage.

▲ When setting the flash coverage, make sure it covers the lens focal length so that the picture will not have a dark periphery.

4. M Mode: Manual Mode

Press MODE Selection Button <MODE> to enter M mode. In this mode, you can set the flash unit onto your camera hot shoe or your trigger hot shoe for firing. Before shooting, adjust the flash power output. When the camera's shutter is pressed, the flash will fire synchronously. Slave triggering mode is not available in M mode.

5. Multi Mode: Stroboscopic Flash

Press Mode Selection Button <MODE> to enter Multi mode (Stroboscopic flash). With stroboscopic flash, a rapid series of flashes is fired. It can be used to capture multiple images of a moving subject in a single photograph. You can set the firing frequency (number of flashes per sec. expressed as Hz), the number of flashes, and the flash output. For setting procedures, see the following:

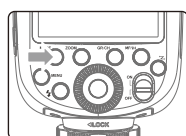

1 Press the Mode Selection Button <MODE> so that "Multi" is displayed.

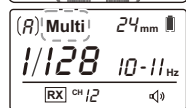

2 Press Set Button <SET> to select the item to be set. The item blinks.

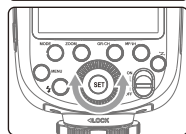

3 Rotate Select Dial <SEL> to set a desired number.

Calculating the Shutter Speed

During stroboscopic flash, the shutter remains open until the firing stops. Use the provided formula to calculate the shutter speed required to capture the full sequence of flashes:

$$\text{Number of flashes} / \text{Firing frequency} = \text{Shutter speed}$$

For example, if the number of flashes is 10 and the firing frequency is 5 Hz, the shutter speed should be at least 2 sec.

Note:

- Stroboscopic flash is most effective with a highly reflective subject against a dark background.
- Using a tripod and a remote switch is recommended.
- A flash output of 1/1 or 1/2 cannot be set for stroboscopic flash.
- Stroboscopic flash can be used with "buLb".

Maximum Stroboscopic Flashes :

Flash output \ Hz	1	2	3	4	5	6-7	8-9
1/4	7	6	5	4	4	3	3
1/8	14	14	12	10	8	6	5
1/16	30	30	30	20	20	20	10
1/32	60	60	60	50	50	40	30
1/64	90	90	90	80	80	70	60
1/128	100	100	100	100	100	90	80

Flash output \ Hz	10	11	12-14	15-19	20-50	60-199
1/4	2	2	2	2	2	2
1/8	4	4	4	4	4	4
1/16	8	8	8	8	8	8
1/32	20	20	20	18	16	12
1/64	50	40	40	35	30	20
1/128	70	70	60	50	40	40

▲ To avoid overheating and deteriorating the flash head during stroboscopic flash, do not use stroboscopic flash more than 10 times in succession.

6. S1 Mode: S1 Slave Triggering Mode

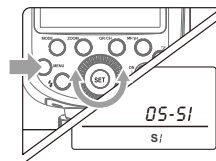

- Press the <MENU> button for 2 seconds to enter the custom menu and press <SET> Button to choose OS. Then, turn the Select Dial to choose OFF/S1/S2.
- In S1 mode, the flash unit can function as a slave flash for creating multiple lighting effects. It is respectively applicable to manual flash environment.
- In S1 mode, the flash unit will fire synchronously when the master flash fires, the same effect as

7. S2 Mode: S2 Slave Triggering Mode

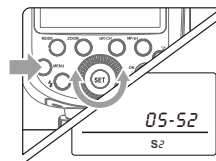

- Press the <MENU> button for 2 seconds to enter the custom menu and press <SET> Button to choose OS. Then, turn the Select Dial to choose OFF/S1/S2.
- In S2 mode, the flash unit can function as a slave flash for creating multiple lighting effects. It is applicable when using a TTL master flash.
- In S2 mode, the flash unit will ignore a single "preflash" from the master flash and will only fire in response to the second, actual flash from the master.

8. $\frac{1}{2}$ Hi-Speed Sync Triggering

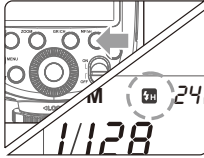

- To enter $\frac{1}{2}$ mode, long press <MF/SH> button and hold for 2 seconds.
- To exit $\frac{1}{2}$ mode, press Mode Selection Button or long press <MF/SH> button and hold for 2 seconds again.
- In $\frac{1}{2}$ hi-speed sync triggering mode, you can use a hi-speed sync trigger to have your flash unit synchronized with all shutter speeds of cameras (max. 1/8000 second, up to your camera). This is convenient when you want to use aperture priority for fill-flash portraits.

Note: *Hi-speed sync triggering mode is effective only when the flash unit is used together with the following flash triggers. (TTL wireless flash trigger X1, X2, Xpro)
*Hi-speed sync triggering mode is not available when V850III is mounted onto the camera.

⚠ To avoid overheating or deteriorating the flash head during high speed sync flash, the over-temperature protection function will be activated automatically after 10 continuous high-speed flashes and the cycle time becomes 10 seconds longer.

9. Custom Function--Focus Assist Lamp

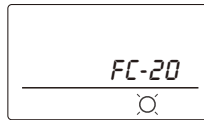
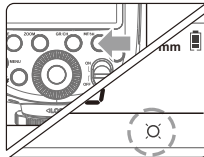

- Under poorly-lit or low-contrast conditions, you can press <MF/SH> button to turn on the focus assist beam in order to make it easier to autofocus.
- The beam will automatically put out certain seconds after the last pop is fired. The time between the last fire and the auto shutdown of focus assist beam is called No-Flash Time. The time is user adjustable and set to 10 seconds by default.
- Press <MENU> button to enter Custom Function. Then press "SET" button to enter "FC" mode. The LCD panel displays "FC" (Auto shutdown of focus assist lamp) and "No-Flash Time". Rotate Select Dial <> to set a desired time for the flash. Press <> button to return.

No-Flash Time	Meaning
10 seconds	10 seconds after the last fire, focus assist lamp will automatically get out.
20 seconds	20 seconds after the last fire, focus assist lamp will automatically get out.
30 seconds	30 seconds after the last fire, focus assist lamp will automatically get out.

10. Buzz Function

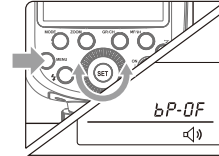

- To turn the buzz function on or off, press the <MENU> button to enter Custom Function.
- Then press "SET" button to enter "bp" mode. The LCD displays "ON" means buzz is turned on while "OF" means buzz is turned off.
- When the buzzer is turned on, <⏸> is shown on the LCD display.

11. Wireless Flash Shooting: Radio (2.4G) Transmission

- V850III has 2.4G radio transmission (Master/Slave)
- Wireless mode setting: Press the <> wireless setting button to set TX or RX mode.
- Channel setting: Long press <GR/CH> button and hold for 2 seconds until the figure besides the CH is blinking. Turn the Select Dial to choose the channel from 1~32.
- Group setting: Short press <GR/CH> button to select group. In TX or RX mode, groups can be selected from A/B/C/D/E.
- ID Setting: Press the <MENU> button to enter the menu. Then, press SET button to choose ID and turn the select dial to select ID from OFF, 01 to 99.
- As V850III adopts Godox wireless X system, it is compatible with XPro series, X2T series, X1T series, QT600III, V860II series, TT685 series, V860III series, V1 series, TT585 series, V350 series, TT350 series, TT600 series, MS series, DP III series, SKII series, AD360II series, AD1200Pro, AD400Pro, AD100Pro, AD200, AD600Pro series, AD200Pro, AD300Pro, etc.

- See the picture below:

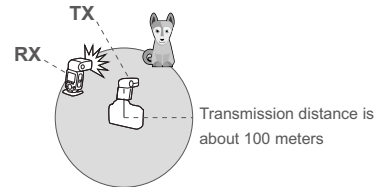

12. Sync Triggering

The Sync Cord Jack is a $\Phi 2.5$ mm plug. Insert a trigger plug here and the flash will be fired synchronously with the camera shutter.

13. Custom Function - Sleep Function

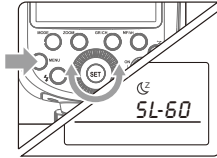

- This product is equipped with Sleep Function to avoid battery drain when the flash unit is idle.
- Press the <MENU> button to enter the sleep Function Mode. Press SET button to enter "SL" adjustment.

The LCD panel displays "SL" (Sleep) and "Sleeping Time". Idle time before entering Sleep Mode is 10 minutes by default. Rotate Select Dial <⊙> to set a desired time for the flash or to turn off Sleep Function. Press <MENU> button to return.

Idle Time	Meaning
OF	Sleep Function is turned off. The flash unit will not automatically enter sleep mode.
3	Idle time before entering Sleep Mode is set to 3 minutes.
10	Idle time before entering Sleep Mode is set to 10 minutes.
30	Idle time before entering Sleep Mode is set to 30 minutes.
60	Idle time before entering Sleep Mode is set to 60 minutes.

- When the flash enters sleep mode, the LCD panel displays a "Z" icon.
- To wake up the flash unit, press any button on the flash unit, or press the camera release button, or press the trigger TEST button.

Note:

The idle time before entering Sleep Mode is recommended to set short. This can ensure a longer battery life.

14. Custom Function - Sleep Function

Custom Function Signs	Function	Settings & Description	Operation
SL	Sleeping Time Setting	Settable Time: <3> 3 minutes <10> 10 minutes <30> 30 minutes <60> 60 minutes <OF> OFF	1. Press <MENU> button to enter Custom Functions. 2. Turn the Select Dial <⊙> to adjust sleeping time. 3. Press <MENU> button to return. *Press any button can wake up the flash. * The idle time before entering Sleep Mode is recommended to set short. This can ensure a longer battery life.
FC	Auto Power OFF Time Setting of Auto Focus Assist	<10>10 seconds <20>20 seconds <30>30 seconds	1. Press <MENU> button to enter Custom Functions. 2. Press <SET> button to enter FC states. 3. Turn the Select Dial <⊙> to adjust. 4. Press <MENU> button to return.
BP	Buzz Setting	<ON> On <OF> Off	1. Press <MENU> button to enter Custom Functions. 2. Press <SET> button to enter bp states. 3. Turn the Select Dial <⊙> to adjust. 4. Press <MENU> button to return.
BL	Backlight Setting	Backlight can be set as follows: <ON>: Always lighting <12>: Off in 12 sec <OF>: Off	1. Press <MENU> button to enter Custom Functions. 2. Press <SET> button to enter bL states. 3. Turn the Select Dial <⊙> to adjust. 4. Press <MENU> button to return.
OS	Optic Slave Mode	<OF> Off <S1> S1 mode <S2> S2 mode	1. Press <MENU> button to enter Custom Functions. 2. Press <SET> button to enter OS states. 3. Turn the Select Dial <⊙> to adjust. 4. Press <MENU> button to return.

- Display all functions: press and hold down MENU and MODE button, then, turn the flash on to check the display.
- Software version checking: press and hold down SET button, then, turn the flash on to check the number of version.

Protection Function

1. Over-Temperature Protection

- To avoid overheating and deteriorating the flash head, do not fire more than 30 continuous flashes in fast succession at 1/1 full power. After 30 continuous flashes, allow a rest time of at least 10 minutes.
- If you fire more than 30 continuous flashes and then fire more flashes in short intervals, the inner over-temperature protection function may be activated and make the recycling time over 10 seconds. If this occurs, allow a rest time of about 10 minutes, and the flash unit will then return to normal.
- When the over-temperature protection is started,  is shown on the LCD display.

Number of flashes that will activate over-temperature protection:

Number of Flashes	ZOOM (mm)	20 - 200
1/1		35
1/2		50
1/4		100
1/8		200
1/16		300
1/32		500
1/64		1000
1/128		2000

Number of flashes that will activate over-temperature protection in high-speed sync triggering mode:

Number of Flashes	ZOOM (mm)	20 - 200
1/1		30
1/2		30
1/4		34
1/8		40
1/16		50
1/32		50
1/64		60
1/128		60

2. Other Protections

The system provides real-time protection to secure the device and your safety. The following lists prompts for your reference:

Prompts on LCD Panel	Meaning
E1	A failure occurs on the recycling system so that the flash cannot fire. Please restart the flash unit. If the problem still exists, please send this product to a maintenance center.
E2	The system gets excessive heat. Please allow a rest time of 10 minutes.
E3	The voltage on two outlets of the flash tube is too high. Please send this product to a maintenance center.
E9	There are some errors occurred during the upgrading process. Please using the correct firmware upgrade method.

Advanced Application

• Bounce Flash

By pointing the flash head toward a wall or ceiling, the flash will bounce off the surface before illuminating the subject. This can soften shadows behind the subject for a more natural-looking shot. This is called bounce flash. To set the bounce direction, hold the flash head and turn it to a satisfying angle.

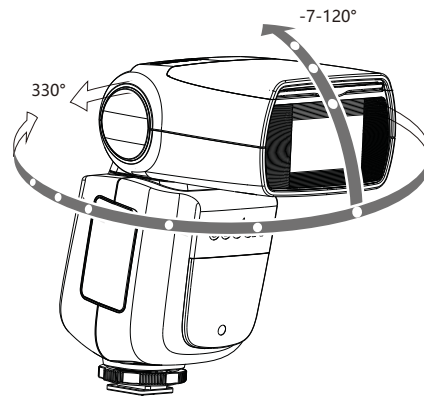

- If the wall or ceiling is too far away, the bounced flash might be too weak and result in underexposure.
- The wall or ceiling should be a plain, white color for high reflectance. If the bounce surface is not white, a color cast may appear in the picture.

• Creating a Catchlight

With the catchlight panel, you can create a catchlight in the subject's eyes to add life to the facial expression.

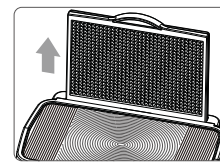

- Point the flash head upward by 90°.

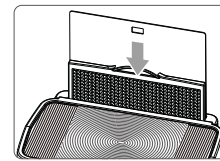

- Pull out the wide panel. The catchlight panel will come out at the same time.

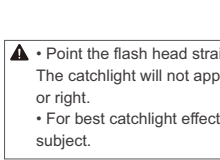

- Push the wide panel back in.
 - Push in only the wide panel.
 - Follow the same procedures as for bounce flash.

- Point the flash head straight ahead and then upward by 90°. The catchlight will not appear if you swing the flash head left or right.
- For best catchlight effect, stay 1.5m/4.9ft away from the subject.

• Using the Wide Panel

Pull out the built-in wide panel to enlarge the flash lighting range, so as to get more softened and natural lighting effect.

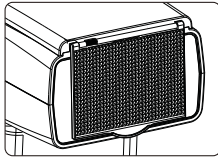

Pull out the wide panel and place it over the flash head as shown. The flash coverage will then be extended to 14 mm.

- The catchlight panel will come out at the same time. Push the catchlight panel back in.

▲ The Reason & Solution of Not Triggering in Godox 2.4G Wireless

- 1. Disturbed by the 2.4G signal in outer environment (e.g. wireless base station, 2.4G wifi router, Bluetooth, etc.)**
→ To adjust the channel CH setting on the flash trigger (add 10+ channels) and use the channel which is not disturbed. Or turn off the other 2.4G equipment in working.
- 2. Please make sure that whether the flash has finished its recycle or caught up with the continuous shooting speed or not (the flash ready indicator is lighten) and the flash is not under the state of over-heat protection or other abnormal situation.**
→ Please downgrade the flash power output.
- 3. Whether the distance between the flash trigger and the flash is too close or not**
→ Please turn on the "close distance wireless mode" on the flash trigger (< 0.5m):
X2 & X1 series: press the test button and hold on, then turning it on until the flash ready indicator blinks for 2 times.
XPro series: Set the C.Fn-DIST to 0-30m.
- 4. Whether the flash trigger and the receiver end equipment are in the low battery states or not**
→ Please replace the battery (the flash trigger is recommended to use 1.5V disposable alkaline battery).

Technical Data

Model	V850III
Power (1/1 output)	76Ws
Guide No.(1/1 output, 200mm)	GN=60 (m ISO100)
Flash Coverage	20 to 200mm • Manual zoom • Swinging/tilting flash head (bounce flash): 0 to 330° horizontally and -7° to 120° vertically
Flash Duration	1/300 to 1/20000 seconds
• Wireless Flash	
Wireless flash function	Transmitter, Receiver, Off
Transmitter groups	A, B, C, D
Controllable Receiver groups	A, B, C, D, E (E group can be controlled by X series flash trigger)
Transmission range (approx.)	100m
Channels	32 (1~32)
ID	01~99
• Power Supply	
Power source	7.2V/2600mAh Li-ion battery
Recycle time	Approx 1.5 seconds. Green LED indicator will light up when the flash is ready.
Full power flashes	Approx. 450
Power saving	Power off automatically after approx. 3, 10, 30 or 60 minutes of idle operation.
• Sync Triggering Mode	
	Hotshoe, 2.5mm sync line
• Dimensions	
W x H x D	199*71.5*60 mm
Weight without battery	390g
Weight with battery	500g
2.4G Wireless Frequency Range	2413.0MHz-2465.0 MHz
Max. Transmitting Power of 2.4G Wireless	5dbm

Maintenance

- Shut down the device immediately should abnormal operation be detected.
- Avoid sudden impacts and the product should be dedusted regularly.
- It is normal for the flash tube to be warm when in use. Avoid continuous flashes if unnecessary.
- Maintenance of the flash must be performed by our authorized maintenance department which can provide original accessories.
- This product, except consumables e.g. flash tube, is supported with a one-year warranty.
- Unauthorized service will void the warranty.
- If the product had failures or was wetted, do not use it until it is repaired by professionals.
- Changes made to the specifications or designs may not be reflected in this manual.

FCC Warning

This device complies with part 15 of the FCC Rules. Operation is subject to the following two conditions: (1) This device may not cause harmful interference, and (2) this device must accept any interference received, including interference that may cause undesired operation.

Any Changes or modifications not expressly approved by the party responsible for compliance could void the user's authority to operate the equipment.

Note: This equipment has been tested and found to comply with the limits for a Class B digital device, pursuant to part 15 of the FCC Rules. These limits are designed to provide reasonable protection against harmful interference in a residential installation. This equipment generates uses and can radiate radio frequency energy and, if not installed and used in accordance with the instructions, may cause harmful interference to radio communications. However, there is no guarantee that interference will not occur in a particular installation. If this equipment does cause harmful interference to radio or television reception, which can be determined by turning the equipment off and on, the user is encouraged to try to correct the interference by one or more of the following measures:

- ▶ Reorient or relocate the receiving antenna.
- ▶ Increase the separation between the equipment and receiver.
- ▶ Connect the equipment into an outlet on a circuit different from that to which the receiver is connected.
- ▶ Consult the dealer or an experienced radio/TV technician for help.

The device has been evaluated to meet general RF exposure requirement.

The device can be used in portable exposure condition without restriction.

***RF warning:**

This equipment complies with FCC radiation exposure limits set forth for an uncontrolled environment.

IC statement:

This device complies with Industry Canada licence-exempt RSS standard(s).

Operation is subject to the following two conditions: (1) this device may not cause interference, and (2) this device must accept any interference, including interference that may cause undesired operation of the device.

Le présent appareil est conforme aux CNR d'Industrie Canada applicables aux appareils radio exempts de licence. L'exploitation est autorisée aux deux conditions suivantes : (1) l'appareil ne doit pas produire de brouillage, et (2) l'utilisateur de l'appareil doit accepter tout brouillage radioélectrique subi, même si le brouillage est susceptible d'en compromettre le fonctionnement.

:

This equipment complies with Industry Canada radiation exposure limits set forth for an uncontrolled environment.

Cet équipement est conforme à l'exposition aux rayonnements Industry Canada limités établies pour un environnement non contrôlé.



产品保修

尊敬的用户，本保修卡是申请保修服务的重要凭证，请您配合销售商填写并妥善保管，谢谢！

产品信息	型号	产品条码
用户信息	姓名	联系电话
	通信地址	
销售商信息	名称	
	联系电话	
	通信地址	
	销售日期	
备注		

注：此表应由销售商盖章确认。

适用产品

本文件适用于相关《产品保修信息》(见后面说明)所列产品，其他非属此范围的产品或部件(如促销品、赠品及其他出厂后附加的部件等)不在此保修承诺内。

保修期

产品及部件的相应保修期按相关的《产品保修信息》执行。保修期自产品首次购买日起算，购买日以购买产品时保修卡登记日期为准。

如何获得保修服务

要保修服务，您可直接与产品销售商或授权服务机构联系，也可拨打神牛产品售后服务电话，与我们联系，由我们的服务人员为您安排服务。申请保修时，您应提供有效的保修卡作为保修凭证，方可获得保修。如您不能提供有效的保修卡，则在我们可确认产品或部件属于保修范围的情况下，也可以为您提供保修，但这不作为我们的义务。

不适用保修的情况

如产品存在下列情况，本文件项下的保证和服务将不适用 ①产品或部件超过相应保修期；②错误或不适当使用、维护或保管导致的故障或损坏，如：不当搬运；非按产品合理预期用途使用；不当插拔外接设备；跌落或外力挤压；接触或暴露于不当温度、溶剂、酸碱、水浸或潮湿环境；③由非神牛授权机构或人员安装、修理、更改、添加或拆卸造成的故障或损坏；④产品或部件原有识别信息被修改或删除；⑤无有效保修卡；⑥使用非合法授权、非标准或非公开发行的软件造成的故障或损坏；⑦因不可抗力或意外事件造成的故障或损坏；⑧其他非因产品本身质量问题导致的故障或损坏。遇上述情况，您应向相关责任方寻求解决，神牛对此不承担任何责任。因非在保修期或保修范围内的部件、附件或软件导致产品不能正常使用，不是保修范围内的故障。产品使用过程中正常的脱色、磨损和消耗，不是保修范围内的故障。

产品保修和服务支持信息

产品的保修期和服务类型按以下《产品保修信息》执行：

产品类别	选件名称	保修期(月)	保修服务类型
部件	电路板	12	客户送修
	电池	3	客户送修
	充电器、电源线、同步线等带电性能的部件。	12	客户送修
其他	如闪光灯管、造型灯泡、外壳、保护罩、锁紧装置、包装等。	无	无保修

神牛产品售后服务电话 0755-29609320-8062

Warranty

Dear customers, as this warranty card is an important certificate to apply for our maintenance service, please fill in the following form in coordination with the seller and safekeep it. Thank you!

Product Information	Model	Product Code Number
Customer Information	Name	Contact Number
	Address	
Seller Information	Name	
	Contact Number	
	Address	
	Date of Sale	
Note:		

Note: This form shall be sealed by the seller.

Applicable Products

The document applies to the products listed on the **Product Maintenance Information** (see below for further information). Other products or accessories (e.g. promotional items, giveaways and additional accessories attached, etc.) are not included in this warranty scope.

Warranty Period

The warranty period of products and accessories is implemented according to the relevant **Product Maintenance Information**. The warranty period is calculated from the day (purchase date) when the product is bought for the first time, and the purchase date is considered as the date registered on the warranty card when buying the product.

How to Get the Maintenance Service

If maintenance service is needed, you can directly contact the product distributor or authorized service institutions. You can also contact the Godox after-sale service call and we will offer you service. When applying for maintenance service, you should provide valid warranty card. If you cannot provide valid warranty card, we may offer you maintenance service once confirmed that the product or accessory is involved in the maintenance scope, but that shall not be considered as our obligation.

Inapplicable Cases

The guarantee and service offered by this document are not applicable in the following cases: ①. The product or accessory has expired its warranty period; ②. Breakage or damage caused by inappropriate usage, maintenance or preservation, such as improper packing, improper usage, improper plugging in/out external equipment, falling off or squeezing by external force, contacting or exposing to the improper temperature, solvent, acid, base, flooding and damp environments, etc; ③. Breakage or damage caused by non-authorized institution or staff in the process of installation, maintenance, alternation, addition and detachment; ④. The original identifying information of product or accessory is modified, alternated, or removed; ⑤. No valid warranty card; ⑥. Breakage or damage caused by using illegally authorized, nonstandard or non-public released software; ⑦. Breakage or damage caused by force majeure or accident; ⑧. Breakage or damage that could not be attributed to the product itself. Once met these situations above, you should seek solutions from the related responsible parties and Godox assumes no responsibility. The damage caused by parts, accessories and software that beyond the warranty period or scope is not included in our maintenance scope. The normal discoloration, abrasion and consumption are not the breakage within the maintenance scope.

Maintenance and Service Support Information

The warranty period and service types of products are implemented according to the following **Product Maintenance Information**:

Product Type	Name	Maintenance Period(month)	Warranty Service Type
Parts	Circuit Board	12	Customer sends the product to designated site
	Battery	3	Customer sends the product to designated site
	Electrical parts e.g. battery charger, power cord, sync cable, etc.	12	Customer sends the product to designated site
Other Items	Flash tube, modeling lamp, lamp body, lamp cover, locking device, package, etc.	No	Without warranty

Godox After-sale Service Call 0755-29609320-8062