



# FCC TEST REPORT

Report No: STS2109043W01

Issued for

GODOX PHOTO EQUIPMENT CO.LTD

1st to 4th Floor, Building 2/1st to 4th Floor, Building 4, Yaochuan Industrial Zone, Tangwei Community, Fuhai Street, Bao'an District, Shenzhen 518103, China

<b>Product Name:</b>	UHF Wireless Microphone System
<b>Brand Name:</b>	Godox
<b>Model Name:</b>	WMicS1 TX1
<b>Series Model:</b>	WMicS1 Kit1(TX1,RX1), WMicS1 Kit2(TX1*2,RX1)
<b>FCC ID:</b>	2ABYN009
<b>Test Standard:</b>	FCC Part 15.236

Any reproduction of this document must be done in full. No single part of this document may be reproduced without permission from STS, All Test Data Presented in this report is only applicable to presented Test sample.

Shenzhen STS Test Services Co., Ltd.  
 A 1/F, Building B, Zhuoke Science Park, No.190 Chongqing Road, HepingShequ,  
 Fuyong Sub-District, Bao'an District, Shenzhen, Guang Dong, China  
 TEL: +86-755 3688 6288 FAX: +86-755 3688 6277 E-mail:sts@stsapp.com





### TEST RESULT CERTIFICATION

**Applicant's Name** ..... : GODOX PHOTO EQUIPMENT CO.LTD  
 1st to 4th Floor, Building 2/1st to 4th Floor, Building 4, Yaochuan  
**Address** ..... : Industrial Zone, Tangwei Community, Fuhai Street, Bao'an  
 District, Shenzhen 518103, China  
**Manufacturer's Name** ..... : GODOX Photo Equipment Co.,Ltd.  
 4th Floor of Building 1, 1st to 4 th Floor of Building 2, 4th Floor  
**Address** ..... : of Building 3,1st to 4th Floor of Building 4, Yaochuan Industrial  
 Zone, Tangwei Community, Fuhai Street, Bao'an District,  
 Shenzhen 518103,China

#### Product Description

**Product Name** ..... : UHF Wireless Microphone System  
**Brand Name** ..... : Godox  
**Model Name** ..... : WMicS1 TX1  
**Series Model** ..... : WMicS1 Kit1(TX1,RX1), WMicS1 Kit2(TX1\*2,RX1)

**Test Standards** ..... : FCC Part 15.236

**Test Procedure** ..... : ANSI C63.10-2013

This device described above has been tested by STS, the test results show that the equipment under test (EUT) is in compliance with the FCC requirements. And it is applicable only to the tested sample identified in the report.

This report shall not be reproduced except in full, without the written approval of STS, this document only be altered or revised by STS, personal only, and shall be noted in the revision of the document.

**Date of Test** ..... :  
**Date of receipt of test item** ..... : 07 Sept. 2021  
**Date of performance of tests** ..... : 07 Sept. 2021 ~ 08 Oct. 2021  
**Date of Issue** ..... : 08 Oct. 2021  
**Test Result** ..... : Pass

Testing Engineer :   
 \_\_\_\_\_  
 (Chris Chen)

Technical Manager :   
 \_\_\_\_\_  
 (Sean she)

Authorized Signatory :   
 \_\_\_\_\_  
 (Vita Li)





Table of Contents	Page
<b>1. SUMMARY OF TEST RESULTS</b>	<b>5</b>
1.1 TEST FACTORY	6
1.2 MEASUREMENT UNCERTAINTY	6
<b>2. GENERAL INFORMATION</b>	<b>7</b>
2.1 GENERAL DESCRIPTION OF THE EUT	7
2.2 DESCRIPTION OF THE TEST MODES	9
2.3 BLOCK DIAGRAM SHOWING THE CONFIGURATION OF SYSTEM TESTED	10
2.4 DESCRIPTION OF NECESSARY ACCESSORIES AND SUPPORT UNITS	11
2.5 TEST EQUIPMENT	12
<b>3. EMC EMISSION TEST</b>	<b>13</b>
3.1 CONDUCTED EMISSION MEASUREMENT	13
3.2 RADIATED EMISSION MEASUREMENT	17
<b>4. PART 15.236 REQUIREMENTS</b>	<b>29</b>
4.1 RADIATED SPURIOUS EMISSION	29
4.2 EMISSION MASK	29
4.3 FREQUENCY STABILITY VS. TEMPERATURE & VOLTAGE	41
4.4 OCCUPIED BANDWIDTH	45
4.5 RADIATED POWER	48
<b>PHOTOS OF TEST SETUP</b>	<b>51</b>



**Revision History**

Rev.	Issue Date	Report NO.	Effect Page	Contents
00	08 Oct. 2021	STS2109043W01	ALL	Initial Issue





## 1. SUMMARY OF TEST RESULTS

Test procedures according to the technical standards:

The EUT has been tested according to FCC CFR 47:

Part 15.236: Operation of wireless microphones in the bands 54-72 MHz, 76-88 MHz, 174-216 MHz, 470-608 MHz and 614-698 MHz.

Emission			
Standard	Item	Limit	Result
FCC 15.236(g)	Radiated Spurious Emission	Refer to 300 422-1 V1.4.2 (8.4)	PASS
FCC 15.236(d)(1)	EIRP	≤50 mW	PASS
FCC 15.215	Occupied Bandwidth	--	PASS
FCC 15.236(f)(3)	Frequency tolerance	±0.005%	PASS
FCC 15.236(g)	Necessary Bandwidth (Mask)	Refer to 300 422-1 V1.4.2 (8.3)	PASS
FCC 15.207	Conducted Emission	--	N/A
FCC 15.209	Radiated Spurious Emission	Refer to Part 15.209(a)	PASS
FCC 15.205	Restricted bands of operation	Refer to Part 15.205(a)	PASS

NOTE:

(1) "N/A" denotes test is not applicable in this Test Report.



## 1.1 TEST FACTORY

SHENZHEN STS TEST SERVICES CO., LTD

Add. : A 1/F, Building B, Zhuoke Science Park, No.190 Chongqing Road, HepingShequ, Fuyong Sub-District, Bao'an District, Shenzhen, Guang Dong, China

FCC test Firm Registration Number: 625569

IC test Firm Registration Number: 12108A

A2LA Certificate No.: 4338.01

## 1.2 MEASUREMENT UNCERTAINTY

The reported uncertainty of measurement  $y \pm U$ , where expanded uncertainty  $U$  is based on a standard uncertainty multiplied by a coverage factor of  $k=2$ , providing a level of confidence of approximately 95 %.

No.	Item	Uncertainty
1	RF output power, conducted	$\pm 0.68\text{dB}$
2	Unwanted Emissions, conducted	$\pm 2.988\text{dB}$
3	All emissions, radiated 9K-30MHz	$\pm 2.84\text{dB}$
4	All emissions, radiated 30M-1GHz	$\pm 4.39\text{dB}$
5	All emissions, radiated 1G-6GHz	$\pm 5.10\text{dB}$
6	All emissions, radiated >6G	$\pm 5.48\text{dB}$
7	Conducted Emission (9KHz-150KHz)	$\pm 2.79\text{dB}$
8	Conducted Emission (150KHz-30MHz)	$\pm 2.80\text{dB}$



## 2. GENERAL INFORMATION

### 2.1 GENERAL DESCRIPTION OF THE EUT

Product Name:	UHF Wireless Microphone System
Brand Name:	Godox
Model Name:	WMicS1 TX1
Series Model :	WMicS1 Kit1(TX1,RX1), WMicS1 Kit2(TX1*2,RX1)
Model Difference description:	The prototype combination is different
Emission Bandwidth:	76.918KHz
Rating:	Type-C USB DC 5V DC 3V(2*1.5VAA batteries)
Operation Frequency Range	514.56-553.92MHz
Maximum Transmitter Power:	0.0002W(-7.11dBm)
Modulation mode / type:	FM
Frequency Tolerance:	0.00031%
Temperature Range:	-10°C-40°C
Test frequency list:	Please refer to the Note 5.
Software version number:	V1.0
Hardware version number:	20200224H33(transmitters)
Connecting I/O Port(s):	Please refer to the Note 1.

#### Note:

1. For a more detailed features description, please refer to the manufacturer's specifications or the User Manual.
2. Note: The product has the same digital working characters when operating in both two digitized voice/data mode. So only one set of test results for digital modulation modes are provided in this test report.



3.

Channel List Group A					
Channel	Frequency (MHz)	Channel	Frequency (MHz)	Channel	Frequency (MHz)
01	514.56	17	521.12	33	527.68
02	514.97	18	521.53	34	528.09
03	515.38	19	521.94	35	528.5
04	515.79	20	522.35	36	528.91
05	516.2	21	522.76	37	529.32
06	516.61	22	523.17	38	529.73
07	517.02	23	523.58	39	530.14
08	517.43	24	523.99	40	530.55
09	517.84	25	524.4	41	530.96
10	518.25	26	524.81	42	531.37
11	518.66	27	525.22	43	531.78
12	519.07	28	525.63	44	532.19
13	519.48	29	526.04	45	532.6
14	519.89	30	526.45	46	533.01
15	520.3	31	526.86	47	533.42
16	520.71	32	527.27	48	533.83

Channel List Group B					
Channel	Frequency (MHz)	Channel	Frequency (MHz)	Channel	Frequency (MHz)
49	534.65	65	541.21	81	547.77
50	535.06	66	541.62	82	548.18
51	535.47	67	542.03	83	548.59
52	535.88	68	542.44	84	549
53	536.29	69	542.85	85	549.41
54	536.7	70	543.26	86	549.82
55	537.11	71	543.67	87	550.23
56	537.52	72	544.08	88	550.64
57	537.93	73	544.49	89	551.05
58	538.34	74	544.9	90	551.46
59	538.75	75	545.31	91	551.87
60	539.16	76	545.72	92	552.28
61	539.57	77	546.13	93	552.69
62	539.98	78	546.54	94	553.1
63	540.39	79	546.95	95	553.51
64	540.8	80	547.36	96	553.92

4. Table for Filed Antenna

Ant	Brand	Model Name	Antenna Type	Connector	Gain (dBi)	NOTE
1	Godox	AN0470-3601B O-B	Integral Antenna	N/A	-1.14	Antenna

The EUT antenna is PCB Antenna. no antenna other than that furnished by the responsible party shall be used with the device.





## 5. Test frequency list

Test Channel List		
Test Channel	EUT Channel	Test Frequency (MHz)
lowest	CH01	514.56
middle	CH48	533.83
highest	CH96	553.92

Note:

In section 15.31(m), regards to the operating frequency range over 10 MHz, the Lowest frequency, the middle frequency, and the highest frequency of channel were selected to perform the test, please see the above listed frequency for testing.

## 2.2 DESCRIPTION OF THE TEST MODES

To investigate the maximum EMI emission characteristics generates from EUT, the test system was pre-scanning tested base on the consideration of following EUT operation mode or test configuration mode which possible have effect on EMI emission level. Each of these EUT operation mode(s) or test configuration mode(s) mentioned above was evaluated respectively.

Pretest Mode	Description
Mode 1	Low Channel
Mode 2	Middle Channel
Mode 3	High Channel

For Conducted/Radiated Emission	
Final Test Mode	Description
Mode 1	Low Channel
Mode 2	Middle Channel
Mode 3	High Channel

Note:

(1) Due to the different configuration and test, in this list only some worse mode. The worst test data of the worse mode is reported by this report.

### 2.3 BLOCK DIAGRAM SHOWING THE CONFIGURATION OF SYSTEM TESTED

#### Radiation Test Set

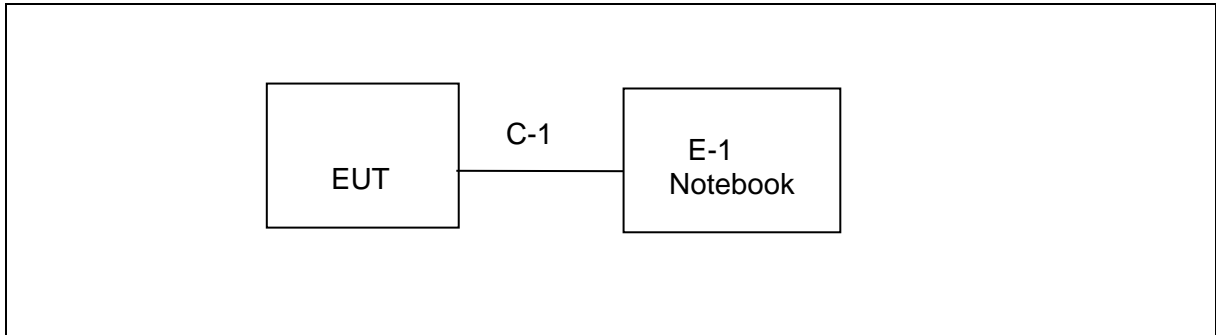

#### Conduction Test Set

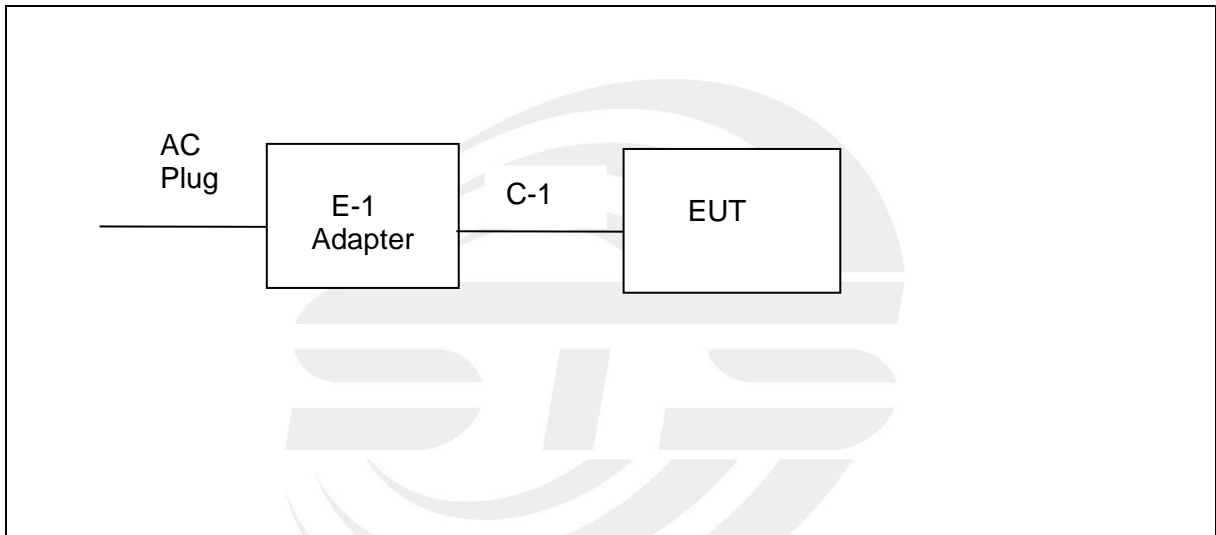



## 2.4 DESCRIPTION OF NECESSARY ACCESSORIES AND SUPPORT UNITS

The EUT has been tested as an independent unit together with other necessary accessories or support units. The following support units or accessories were used to form a representative test configuration during the tests.

### Necessary accessories

Item	Equipment	Mfr/Brand	Model/Type No.	Length	Note
N/A	N/A	N/A	N/A	N/A	N/A

### Support units

Item	Equipment	Mfr/Brand	Model/Type No.	Length	Note
E-1	Adapter	HUAWEI	HW-050450C00	N/A	N/A
C-1	Type-C Cable	N/A	N/A	50cm	NO

Note:

- (1) For detachable type I/O cable should be specified the length in cm in 『Length』 column.



2.5 TEST EQUIPMENT  
Radiation Test equipment

Kind of Equipment	Manufacturer	Type No.	Serial No.	Last calibration	Calibrated until
Bilog Antenna	TESEQ	CBL6111D	34678	2020.10.12	2022.10.11
Horn Antenna	SCHWARZBECK	BBHA 9120D(1201)	9120D-1343	2019.10.15	2021.10.14
Pre-Amplifier (0.1M-3GHz)	EM	EM330	060665	2020.10.12	2021.10.11
Pre-Amplifier (1G-18GHz)	SKET	LNPA-01018G-45	SK2018080901	2020.10.12	2021.10.11
Signal Analyzer	R&S	FSV 40-N	101823	2020.10.10	2021.10.09
Temperature & Humidity	HH660	Mieo	N/A	2020.10.13	2021.10.12
Turn table	EM	SC100_1	60531	N/A	N/A
Antenna mast	EM	SC100	N/A	N/A	N/A
AC Power Source	APC	KDF-11010G	F214050035	N.C.R	N.C.R
Test SW	FARAD	EZ-EMC(Ver.STSLAB-03A1 RE)			

RF Connected Test equipment

Kind of Equipment	Manufacturer	Type No.	Serial No.	Last calibration	Calibrated until
Power Sensor	Keysight	U2021XA	MY55520005	2020.10.10	2021.10.09
			MY55520006	2020.10.10	2021.10.09
			MY56120038	2020.10.10	2021.10.09
			MY56280002	2020.10.10	2021.10.09
Signal Generator	Agilent	N5182A	MY46240556	2020.10.10	2021.10.09
Signal Analyzer	Agilent	N9020A	MY51110105	2021.03.04	2022.03.03
Universal Radio communication tester	R&S	CMU200	119907	2020.10.12	2021.10.11
Audio analyzer	R&S	UPL	N/A	2021.03.04	2022.03.03
Temperature & Humidity	HH660	Mieo	N/A	2020.10.13	2021.10.12
Programmable power supply	Agilent	E3642A	MY40002025	2020.10.12	2021.10.11
Attenuator	HP	8494B	DC-18G	2021.04.28	2022.04.27
AC Power Source	APC	KDF-11010G	F214050035	N.C.R	N.C.R
Test SW	FARAD	LZ-RF /LzRf-3A3			



### 3. EMC EMISSION TEST

#### 3.1 CONDUCTED EMISSION MEASUREMENT

##### 3.1.1 POWER LINE CONDUCTED EMISSION LIMITS

The radio frequency voltage that is conducted back onto the AC power line on any frequency or frequencies, within the band 150 kHz to 30 MHz, shall not exceed the limits in the following table.

FREQUENCY (MHz)	Conducted Emissionlimit (dBuV)	
	Quasi-peak	Average
0.15 -0.5	66 - 56 *	56 - 46 *
0.50 -5.0	56.00	46.00
5.0 -30.0	60.00	50.00

Note:

- (1) The tighter limit applies at the band edges.
- (2) The limit of “ \* ” marked band means the limitation decreases linearly with the logarithm of the frequency in the range.

The following table is the setting of the receiver

Receiver Parameters	Setting
Attenuation	10 dB
Start Frequency	0.15 MHz
Stop Frequency	30 MHz
IF Bandwidth	9 kHz

3.1.2 TEST PROCEDURE

- a. The EUT is 0.8 m from the horizontal ground plane and 0.4 m from the vertical ground plane with EUT being connected to the power mains through a line impedance stabilization network (LISN). All other support equipments are powered from additional LISN(s). The LISN provides 50 Ohm/ 50uH of coupling impedance for the measuring instrument.
- b. Interconnecting cables that hang closer than 40 cm to the ground plane shall be folded back and forth in the center forming a bundle 30 to 40 cm long.
- c. I/O cables that are not connected to a peripheral shall be bundled in the center. The end of the cable may be terminated, if required, using the correct terminating impedance. The overall length shall not exceed 1 m.
- d. LISN is at least 80 cm from the nearest part of EUT chassis.
- e. For the actual test configuration, please refer to the related Item –EUT Test Photos.

3.1.3 TEST SETUP

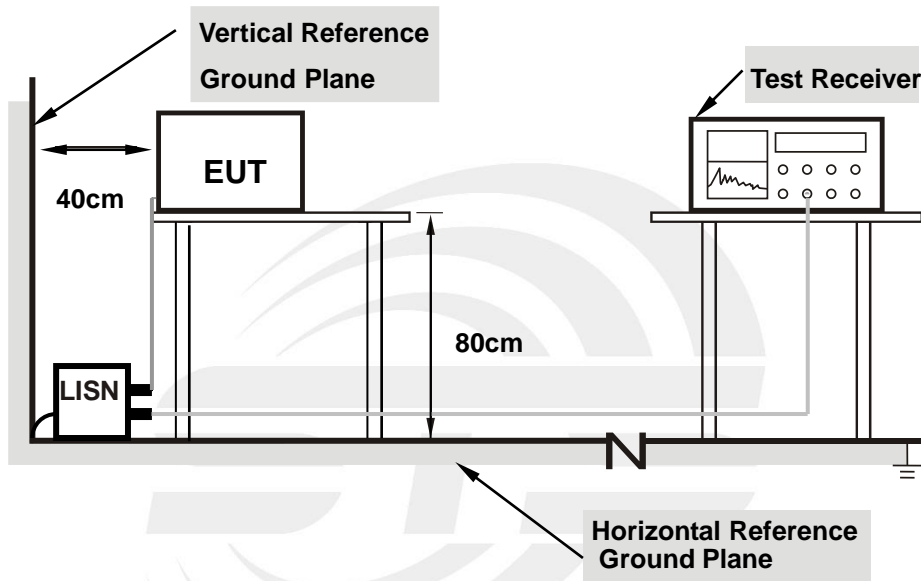

- Note:**
- 1.Support units were connected to second LISN.
  - 2.Both of LISNs (AMN) are 80 cm from EUT and at least 80 cm from other units and other metal planes support.



3.1.4 TEST RESULT

Temperature:	26.4(C)	Relative Humidity:	60%RH
Test Voltage:	DC 5V	Phase:	L
Test Mode:	Mode 1/2/3(Mode 1 worst mode)		

No.	Frequency (MHz)	Reading (dBuV)	Correct Factor(dB)	Result (dBuV)	Limit (dBuV)	Margin (dB)	Remark
1	0.6140	10.05	20.43	30.48	56.00	-25.52	QP
2	0.6140	-3.04	20.43	17.39	46.00	-28.61	AVG
3	0.8780	11.00	20.32	31.32	56.00	-24.68	QP
4	0.8780	4.25	20.32	24.57	46.00	-21.43	AVG
5	1.7540	9.39	20.30	29.69	56.00	-26.31	QP
6	1.7540	2.07	20.30	22.37	46.00	-23.63	AVG
7	3.5060	11.32	20.38	31.70	56.00	-24.30	QP
8	3.5060	5.42	20.38	25.80	46.00	-20.20	AVG
9	7.8900	10.86	20.76	31.62	60.00	-28.38	QP
10	7.8900	3.27	20.76	24.03	50.00	-25.97	AVG
11	11.3940	13.50	21.35	34.85	60.00	-25.15	QP
12	11.3940	-0.58	21.35	20.77	50.00	-29.23	AVG

Remark:

1. All readings are Quasi-Peak and Average values
2. Margin = Result (Result =Reading + Factor)–Limit
3. Factor=LISN factor+Cable loss+Limiter (10dB)

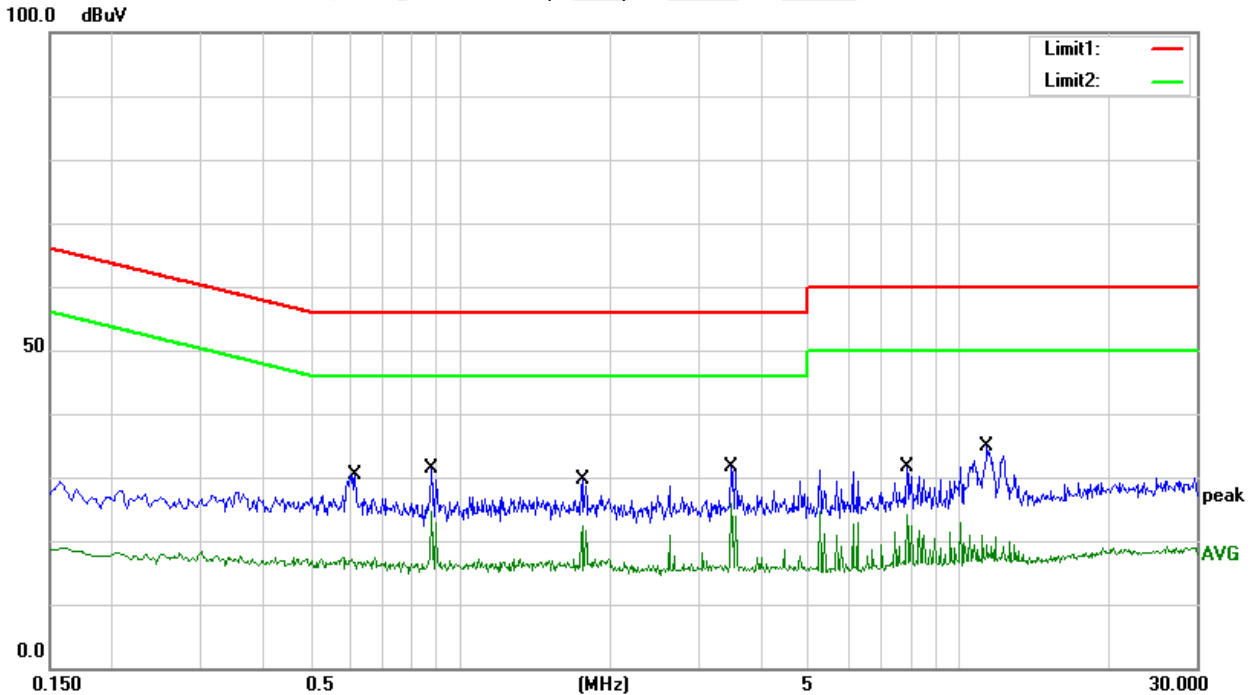



Temperature:	26.4(C)	Relative Humidity:	60%RH
Test Voltage:	DC 5V	Phase:	N
Test Mode:	Mode 1/2/3(Mode 1 worst mode)		

No.	Frequency (MHz)	Reading (dBuV)	Correct Factor(dB)	Result (dBuV)	Limit (dBuV)	Margin (dB)	Remark
1	0.6020	12.72	20.44	33.16	56.00	-22.84	QP
2	0.6020	-3.14	20.44	17.30	46.00	-28.70	AVG
3	1.1380	8.30	20.30	28.60	56.00	-27.40	QP
4	1.1380	-3.12	20.30	17.18	46.00	-28.82	AVG
5	1.9980	6.99	20.30	27.29	56.00	-28.71	QP
6	1.9980	-4.19	20.30	16.11	46.00	-29.89	AVG
7	3.5780	7.69	20.38	28.07	56.00	-27.93	QP
8	3.5780	1.89	20.38	22.27	46.00	-23.73	AVG
9	7.8900	7.99	20.76	28.75	60.00	-31.25	QP
10	7.8900	0.85	20.76	21.61	50.00	-28.39	AVG
11	20.3820	8.23	22.87	31.10	60.00	-28.90	QP
12	20.3820	-4.03	22.87	18.84	50.00	-31.16	AVG

Remark:

1. All readings are Quasi-Peak and Average values
2. Margin = Result (Result =Reading + Factor)–Limit
3. Factor=LISN factor+Cable loss+Limiter (10dB)

100.0 dBuV

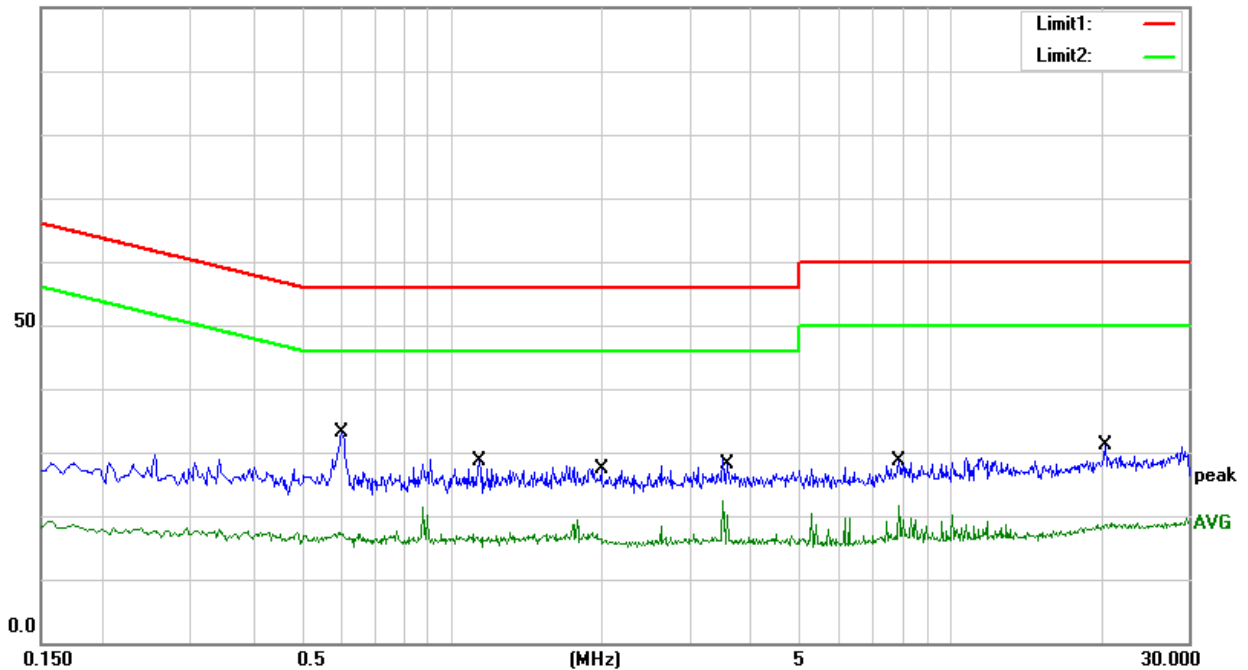





3.2 RADIATED EMISSION MEASUREMENT

3.2.1 RADIATED EMISSION LIMITS

In any 100 kHz bandwidth outside the operating frequency band. In case the emission fall within the Restricted band specified on Part15.205 (a) & 209 (a) limit in the table and according to ANSI C63.10-2013 below has to be followed.

LIMITS OF RADIATED EMISSION MEASUREMENT (0.009MHz - 1000MHz)

Frequencies (MHz)	Field Strength (micorvolts/meter)	Measurement Distance (meters)
0.009~0.490	2400/F(KHz)	300
0.490~1.705	24000/F(KHz)	30
1.705~30.0	30	30
30~88	100	3
88~216	150	3
216~960	200	3
Above 960	500	3

LIMITS OF RADIATED EMISSION MEASUREMENT (1GHz-25 GHz)

FREQUENCY (MHz)	(dBuV/m) (at 3M)	
	PEAK	AVERAGE
Above 1000	74	54

Notes:

- (1) The limit for radiated test was performed according to FCC PART 15C.
- (2) The tighter limit applies at the band edges.
- (3) Emission level (dBuV/m)=20log Emission level (uV/m).

LIMITS OF RESTRICTED FREQUENCY BANDS

FREQUENCY (MHz)	FREQUENCY (MHz)	FREQUENCY (MHz)	FREQUENCY (GHz)
0.090-0.110	16.42-16.423	399.9-410	4.5-5.15
0.495-0.505	16.69475-16.69525	608-614	5.35-5.46
2.1735-2.1905	16.80425-16.80475	960-1240	7.25-7.75
4.125-4.128	25.5-25.67	1300-1427	8.025-8.5
4.17725-4.17775	37.5-38.25	1435-1626.5	9.0-9.2
4.20725-4.20775	73-74.6	1645.5-1646.5	9.3-9.5
6.215-6.218	74.8-75.2	1660-1710	10.6-12.7
6.26775-6.26825	108-121.94	1718.8-1722.2	13.25-13.4
6.31175-6.31225	123-138	2200-2300	14.47-14.5
8.291-8.294	149.9-150.05	2310-2390	15.35-16.2
8.362-8.366	156.52475-156.52525	2483.5-2500	17.7-21.4
8.37625-8.38675	156.7-156.9	2690-2900	22.01-23.12
8.41425-8.41475	162.0125-167.17	3260-3267	23.6-24.0
12.29-12.293	167.72-173.2	3332-3339	31.2-31.8
12.51975-12.52025	240-285	3345.8-3358	36.43-36.5
12.57675-12.57725	322-335.4	3600-4400	Above 38.6
13.36-13.41			



For Radiated Emission

Spectrum Parameter	Setting
Attenuation	Auto
Detector	Peak/QP/AV
Start Frequency	9 KHz/150KHz(Peak/QP/AV)
Stop Frequency	150KHz/30MHz(Peak/QP/AV)
RB / VB (emission in restricted band)	200Hz (From 9kHz to 0.15MHz)/ 9KHz (From 0.15MHz to 30MHz); 200Hz (From 9kHz to 0.15MHz)/ 9KHz (From 0.15MHz to 30MHz)

Spectrum Parameter	Setting
Attenuation	Auto
Detector	Peak/QP
Start Frequency	30 MHz(Peak/QP)
Stop Frequency	1000 MHz (Peak/QP)
RB / VB (emission in restricted band)	120 KHz / 300 KHz

Spectrum Parameter	Setting
Attenuation	Auto
Detector	Peak/AV
Start Frequency	1000 MHz(Peak/AV)
Stop Frequency	10th carrier hamonic(Peak/AV)
RB / VB (emission in restricted band)	1 MHz / 3 MHz(Peak) 1 MHz/1/T MHz(AVG)

For Restricted band

Spectrum Parameter	Setting
Detector	Peak/AV
Start/Stop Frequency	400 to 614 MHz
RB / VB	1 MHz / 3 MHz(Peak) 1 MHz/1/T MHz(AVG)



Receiver Parameter	Setting
Attenuation	Auto
Start ~ Stop Frequency	9kHz~90kHz / RB 200Hz for PK & AV
Start ~ Stop Frequency	90kHz~110kHz / RB 200Hz for QP
Start ~ Stop Frequency	110kHz~490kHz / RB 200Hz for PK & AV
Start ~ Stop Frequency	490kHz~30MHz / RB 9kHz for QP
Start ~ Stop Frequency	30MHz~1000MHz / RB 120kHz for QP

### 3.2.2 TEST PROCEDURE

- The measuring distance at 3 m shall be used for measurements at frequency 0.009MHz up to 1GHz, and above 1GHz.
- The EUT was placed on the top of a rotating table 0.8 m (above 1GHz is 1.5 m) above the ground at a 3 m anechoic chamber test site. The table was rotated 360 degree to determine the position of the highest radiation.
- The height of the equipment shall be 0.8 m (above 1GHz is 1.5 m); the height of the test antenna shall vary between 1 m to 4 m. Horizontal and vertical polarization of the antenna are set to make the measurement.
- The initial step in collecting conducted emission data is a spectrum analyzer peak detector mode pre-scanning the measurement frequency range. Significant peaks are then marked and QuasiPeak detector mode will be re-measured.
- If the Peak Mode measured value is compliance with and lower than Quasi Peak Mode Limit, the EUT shall be deemed to meet QP Limits and no additional QP Mode measurement was performed.
- For the actual test configuration, please refer to the related Item –EUT Test Photos.

Note:

Both horizontal and vertical antenna polarities were tested and performed pretest to three orthogonal axis. The worst case emissions were reported.

### 3.2.3 DEVIATION FROM TEST STANDARD

No deviation.

### 3.2.4 TESTSETUP

#### (A) Radiated Emission Test-Up Frequency Below 30MHz

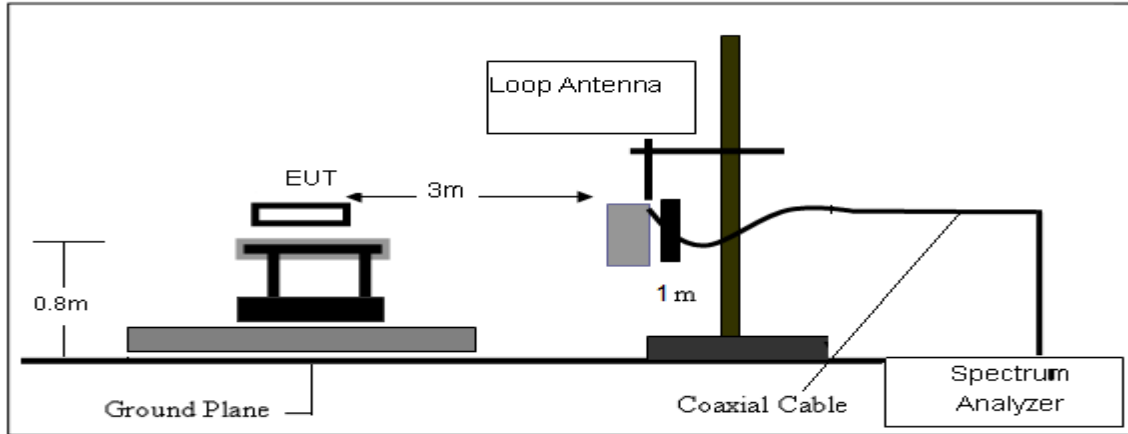

#### (B) Radiated Emission Test-Up Frequency 30MHz~1GHz

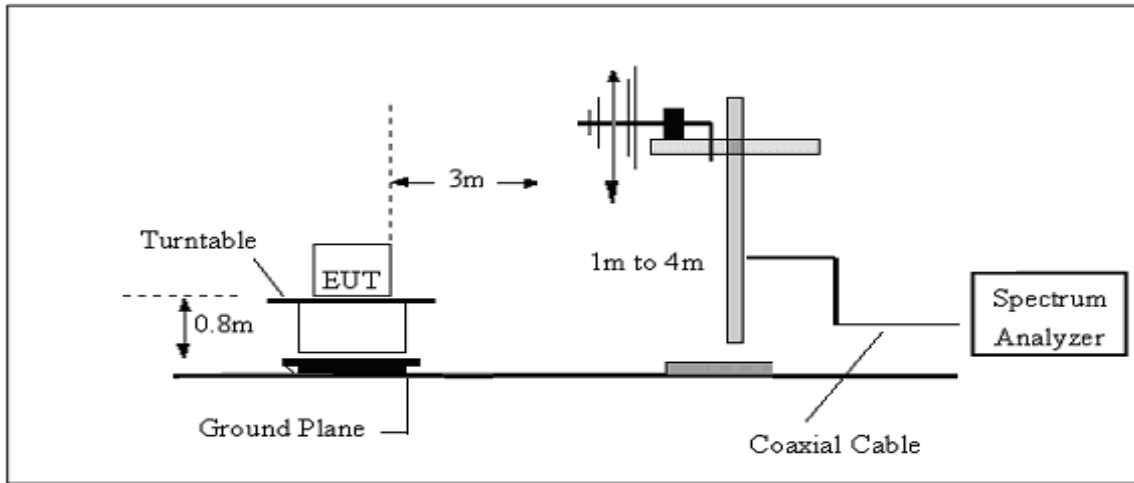

#### (C) Radiated Emission Test-Up Frequency Above 1GHz

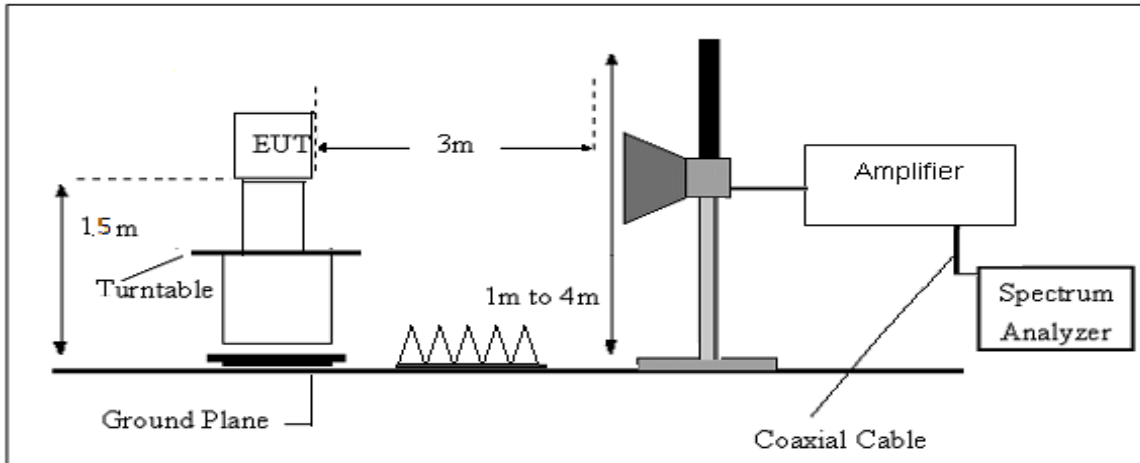

### 3.2.5 EUT OPERATING CONDITIONS

Please refer to section 2.3 of this report.



### 3.2.6 FIELD STRENGTH CALCULATION

The field strength is calculated by adding the Antenna Factor and Cable Factor and subtracting the Amplifier Gain and Duty Cycle Correction Factor (if any) from the measured reading. The basic equation with a sample calculation is as follows:

$$FS = RA + AF + CL - AG$$

Where

FS = Field Strength

CL = Cable Attenuation Factor (Cable Loss)

RA = Reading Amplitude

AG = Amplifier Gain

AF = Antenna Factor

For example

Frequency (MHz)	FS (dB $\mu$ V/m)	RA (dB $\mu$ V/m)	AF (dB)	CL (dB)	AG (dB)	Factor (dB)
300	40	58.1	12.2	1.6	31.9	-18.1

$$\text{Factor} = \text{AF} + \text{CL} - \text{AG}$$





## 3.2.7 TEST RESULTS

(9KHz-30MHz)

Temperature:	23.1(C)	Relative Humidity:	60%RH
Test Voltage:	DC 5V	Test Mode:	TX Mode

Freq. (MHz)	Reading (dBuV/m)	Limit (dBuV/m)	Margin (dB)	State P/F	Test Result
--	--	--	--	--	PASS
--	--	--	--	--	PASS

## Note:

The amplitude of spurious emissions which are attenuated by more than 20dB below the permissible value has no need to be reported.

Distance extrapolation factor =  $40 \log(\text{specific distance/test distance})$ (dB);

Limit line = specific limits (dBuV) + distance extrapolation factor.





(30MHz-1000MHz)

Temperature:	23.1(C)	Relative Humidity:	60%RH
Test Voltage:	DC 5V	Phase:	Horizontal
Test Mode:	Mode 1/2/3(Mode 1 worst mode)		

No.	Frequency (MHz)	Reading (dBuV)	Correct Factor(dB/m)	Result (dBuV/m)	Limit (dBuV/m)	Margin (dB)	Remark
1	108.5700	47.08	-19.22	27.86	43.50	-15.64	QP
2	308.3900	40.59	-14.52	26.07	46.00	-19.93	QP
3	453.8900	32.91	-9.59	23.32	46.00	-22.68	QP
4	733.2500	27.52	-2.35	25.17	46.00	-20.83	QP
5	874.8700	27.66	-0.59	27.07	46.00	-18.93	QP
6	955.3800	27.48	1.68	29.16	46.00	-16.84	QP

Remark:

- Margin = Result (Result =Reading + Factor )-Limit
- Factor= Antenna factor+Cable attenuation factor(cable loss)-Amplifier gain





Temperature:	23.1(C)	Relative Humidity:	60%RH
Test Voltage:	DC 5V	Phase:	Vertical
Test Mode:	Mode 1/2/3(Mode 1 worst mode)		

No.	Frequency (MHz)	Reading (dBuV)	Correct Factor(dB/m)	Result (dBuV/m)	Limit (dBuV/m)	Margin (dB)	Remark
1	42.6100	49.38	-19.44	29.94	40.00	-10.06	QP
2	318.0900	38.84	-14.09	24.75	46.00	-21.25	QP
3	453.8900	33.92	-9.59	24.33	46.00	-21.67	QP
4	676.0200	29.50	-4.40	25.10	46.00	-20.90	QP
5	881.6600	27.94	-0.66	27.28	46.00	-18.72	QP
6	989.3300	27.61	2.09	29.70	54.00	-24.30	QP

Remark:

- Margin = Result (Result =Reading + Factor)–Limit
- Factor= Antenna factor+Cable attenuation factor(cable loss)-Amplifier gain

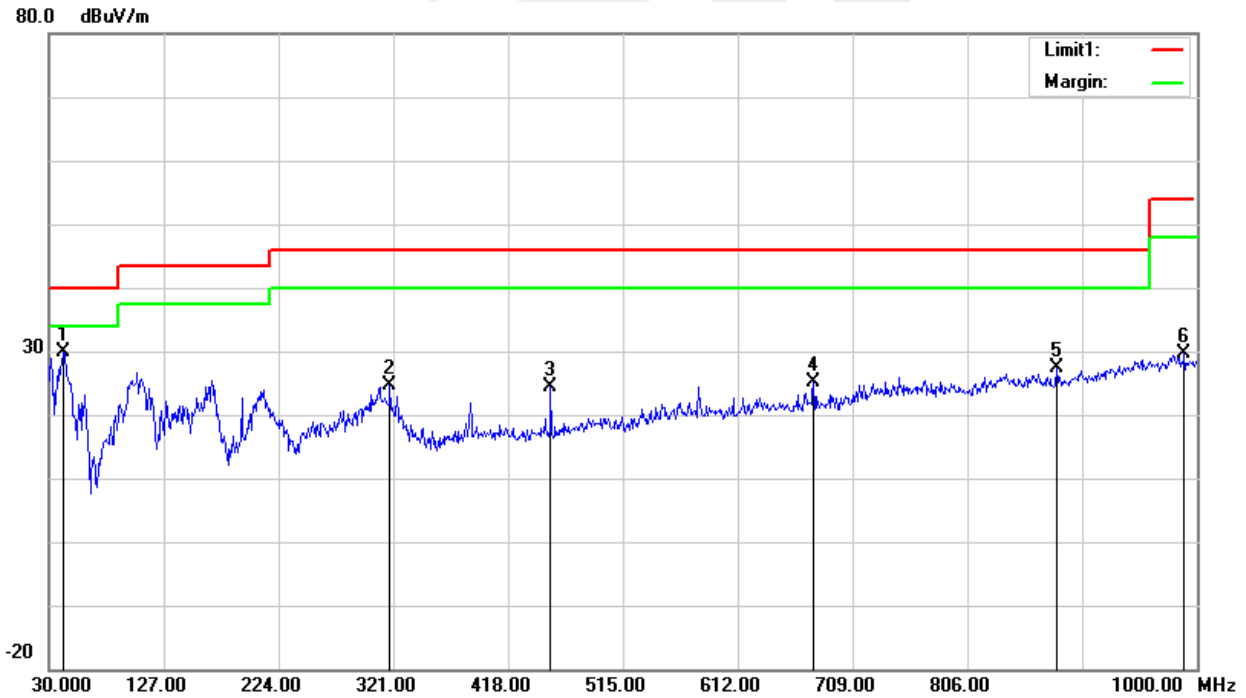





(Above 1GHz) Spurious emission Requirements

Frequency (MHz)	Meter Reading (dBμV)	Amplifier (dB)	Loss (dB)	Antenna Factor (dB/m)	Orrected Factor (dB)	Emission Level (dBμV/m)	Limits (dBμV/m)	Margin (dB)	Detector Type	Comment
Low Channel (514.56 MHz)										
1222.50	62.85	43.80	5.40	25.90	-12.50	50.35	74.00	-23.65	Pk	Vertical
1222.50	53.56	43.80	5.40	25.90	-12.50	41.06	54.00	-12.94	AV	Vertical
1222.71	62.67	43.80	5.40	25.90	-12.50	50.17	74.00	-23.83	Pk	Horizontal
1222.71	49.90	43.80	5.40	25.90	-12.50	37.40	54.00	-16.60	AV	Horizontal
1543.43	66.62	44.40	6.20	27.60	-10.60	56.02	74.00	-17.98	Pk	Vertical
1543.43	50.75	44.40	6.20	27.60	-10.60	40.15	54.00	-13.85	AV	Vertical
1543.44	64.71	44.40	6.20	27.60	-10.60	54.11	74.00	-19.89	Pk	Horizontal
1543.44	50.19	44.40	6.20	27.60	-10.60	39.59	54.00	-14.41	AV	Horizontal
1860.98	63.24	44.70	6.70	28.20	-9.80	53.44	74.00	-20.56	Pk	Vertical
1860.98	51.19	44.70	6.70	28.20	-9.80	41.39	54.00	-12.61	AV	Vertical
1860.96	62.72	44.70	6.70	28.20	-9.80	52.92	74.00	-21.08	Pk	Horizontal
1860.96	50.80	44.70	6.70	28.20	-9.80	41.00	54.00	-13.00	AV	Horizontal
2279.98	64.38	44.20	7.90	29.70	-6.60	57.78	74.00	-16.22	Pk	Vertical
2279.98	48.06	44.20	7.90	29.70	-6.60	41.46	54.00	-12.54	AV	Vertical
2279.94	67.54	44.20	7.90	29.70	-6.60	60.94	74.00	-13.06	Pk	Horizontal
2279.94	48.83	44.20	7.90	29.70	-6.60	42.23	54.00	-11.77	AV	Horizontal



Middle Channel (533.83 MHz)										
1251.72	63.53	43.80	5.40	25.90	-12.50	51.03	74.00	-22.97	Pk	Vertical
1251.72	52.96	43.80	5.40	25.90	-12.50	40.46	54.00	-13.54	AV	Vertical
1251.71	63.11	43.80	5.40	25.90	-12.50	50.61	74.00	-23.39	Pk	Horizontal
1251.71	49.78	43.80	5.40	25.90	-12.50	37.28	54.00	-16.72	AV	Horizontal
1601.23	66.92	44.40	6.20	27.60	-10.60	56.32	74.00	-17.68	Pk	Vertical
1601.23	51.09	44.40	6.20	27.60	-10.60	40.49	54.00	-13.51	AV	Vertical
1601.38	65.22	44.40	6.20	27.60	-10.60	54.62	74.00	-19.38	Pk	Horizontal
1601.38	51.40	44.40	6.20	27.60	-10.60	40.80	54.00	-13.20	AV	Horizontal
1905.43	63.14	44.70	6.70	28.20	-9.80	53.34	74.00	-20.66	Pk	Vertical
1905.43	50.52	44.70	6.70	28.20	-9.80	40.72	54.00	-13.28	AV	Vertical
1905.37	62.37	44.70	6.70	28.20	-9.80	52.57	74.00	-21.43	Pk	Horizontal
1905.37	50.43	44.70	6.70	28.20	-9.80	40.63	54.00	-13.37	AV	Horizontal
2334.21	65.46	44.20	7.90	29.70	-6.60	58.86	74.00	-15.14	Pk	Vertical
2334.21	48.12	44.20	7.90	29.70	-6.60	41.52	54.00	-12.48	AV	Vertical
2334.21	67.97	44.20	7.90	29.70	-6.60	61.37	74.00	-12.63	Pk	Horizontal
2334.21	48.64	44.20	7.90	29.70	-6.60	42.04	54.00	-11.96	AV	Horizontal
High Channel (553.92 MHz)										
1280.52	63.85	43.80	5.40	25.90	-12.50	51.35	74.00	-22.65	Pk	Vertical
1280.52	53.18	43.80	5.40	25.90	-12.50	40.68	54.00	-13.32	AV	Vertical
1280.67	62.94	43.80	5.40	25.90	-12.50	50.44	74.00	-23.56	Pk	Horizontal
1280.67	49.27	43.80	5.40	25.90	-12.50	36.77	54.00	-17.23	AV	Horizontal
1661.52	67.68	44.40	6.20	27.60	-10.60	57.08	74.00	-16.92	Pk	Vertical
1661.52	51.13	44.40	6.20	27.60	-10.60	40.53	54.00	-13.47	AV	Vertical
1661.57	65.68	44.40	6.20	27.60	-10.60	55.08	74.00	-18.92	Pk	Horizontal
1661.57	50.92	44.40	6.20	27.60	-10.60	40.32	54.00	-13.68	AV	Horizontal
1949.41	63.34	44.70	6.70	28.20	-9.80	53.54	74.00	-20.46	Pk	Vertical
1949.41	50.42	44.70	6.70	28.20	-9.80	40.62	54.00	-13.38	AV	Vertical
1949.44	62.54	44.70	6.70	28.20	-9.80	52.74	74.00	-21.26	Pk	Horizontal
1949.44	50.90	44.70	6.70	28.20	-9.80	41.10	54.00	-12.90	AV	Horizontal
2388.17	65.28	44.20	7.90	29.70	-6.60	58.68	74.00	-15.32	Pk	Vertical
2388.17	47.12	44.20	7.90	29.70	-6.60	40.52	54.00	-13.48	AV	Vertical
2388.28	67.47	44.20	7.90	29.70	-6.60	60.87	74.00	-13.13	Pk	Horizontal
2388.28	48.19	44.20	7.90	29.70	-6.60	41.59	54.00	-12.41	AV	Horizontal

Note:

1) Factor = Antenna Factor + Cable Loss – Pre-amplifier.

Emission Level = Reading + Factor

2) The frequency emission of peak points that did not show above the forms are at least 20dB below the limit, the frequency emission is mainly from the environment noise.



Restricted band Requirements

Low channel  
Horizontal

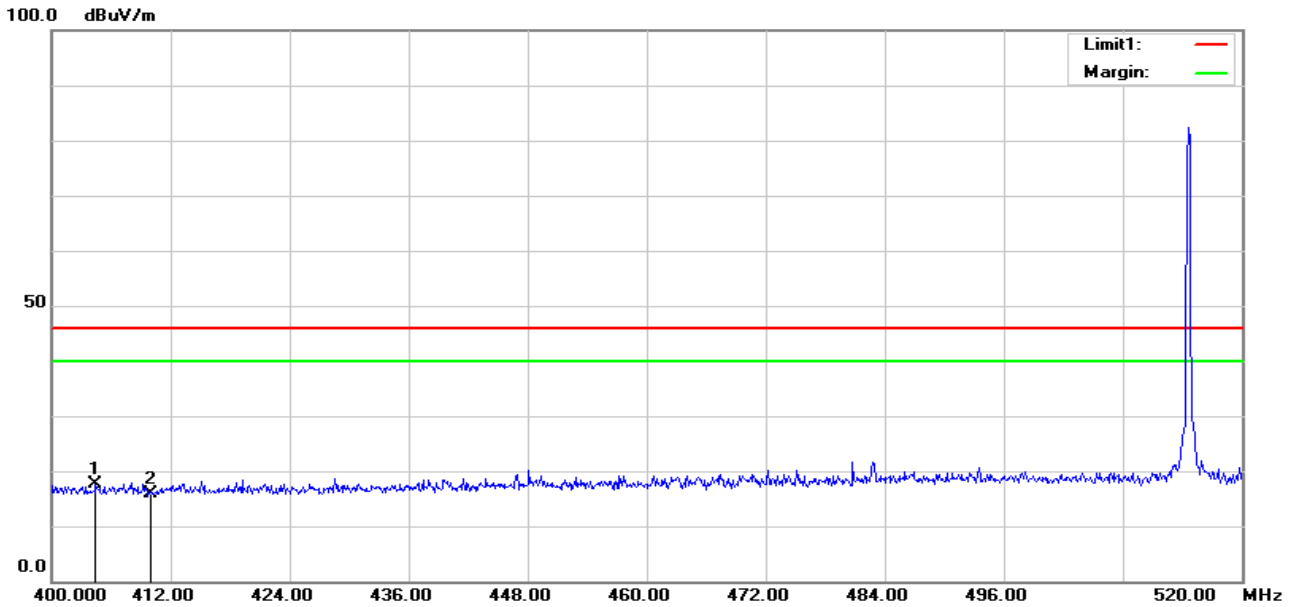

No.	Frequency (MHz)	Reading (dBuV)	Correct Factor(dB/m)	Result (dBuV/m)	Limit (dBuV/m)	Margin (dB)	Remark
1	404.4400	28.56	-10.88	17.68	46.00	-28.32	peak
2	410.0000	26.55	-10.57	15.98	46.00	-30.02	peak

Vertical

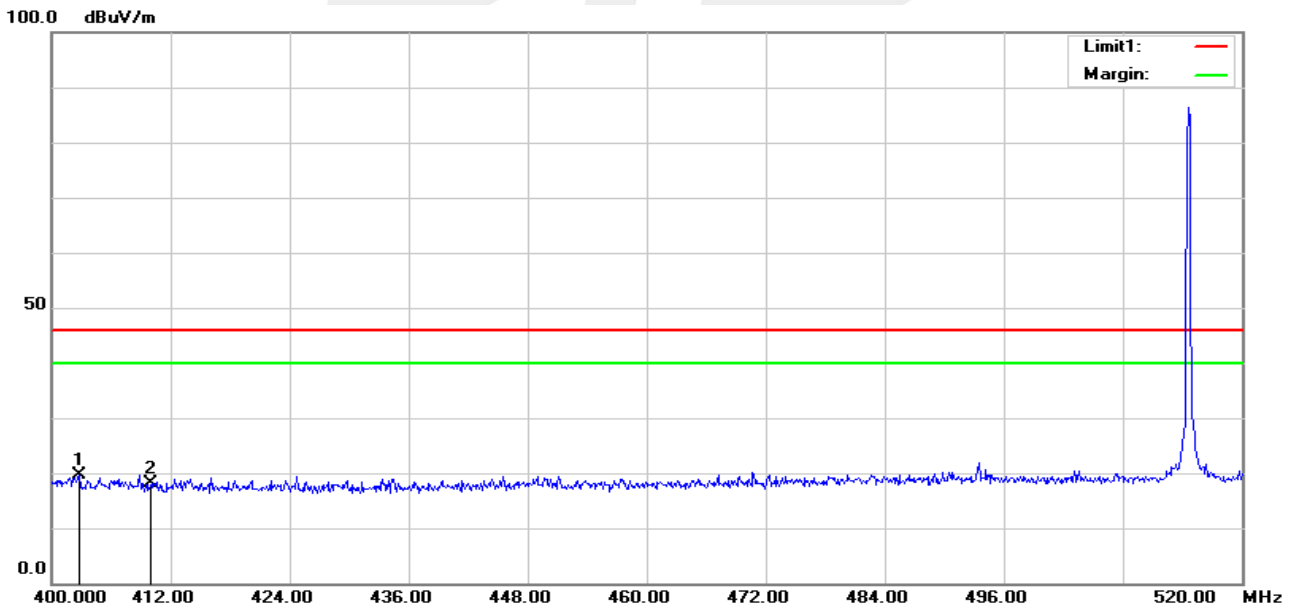

No.	Frequency (MHz)	Reading (dBuV)	Correct Factor(dB/m)	Result (dBuV/m)	Limit (dBuV/m)	Margin (dB)	Remark
1	402.7600	30.66	-10.98	19.68	46.00	-26.32	peak
2	410.0000	28.64	-10.57	18.07	46.00	-27.93	peak



High channel  
Horizontal

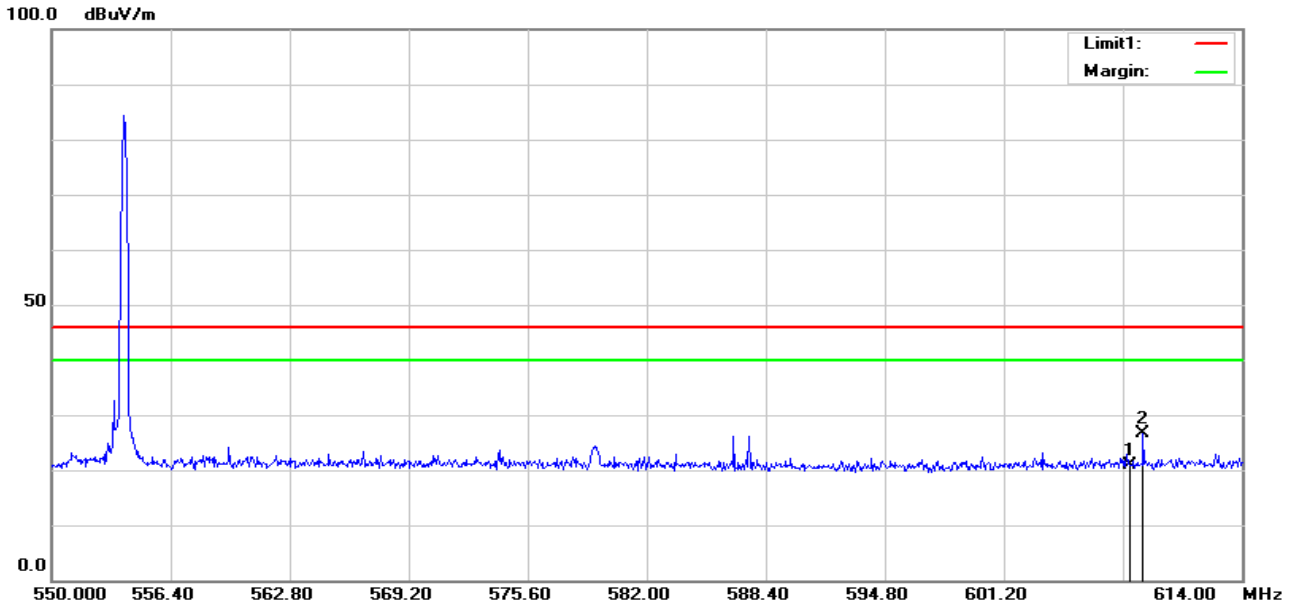

No.	Frequency (MHz)	Reading (dBuV)	Correct Factor(dB/m)	Result (dBuV/m)	Limit (dBuV/m)	Margin (dB)	Remark
1	608.0000	26.44	-5.57	20.87	46.00	-25.13	peak
2	608.6880	32.23	-5.55	26.68	46.00	-19.32	peak

Vertical

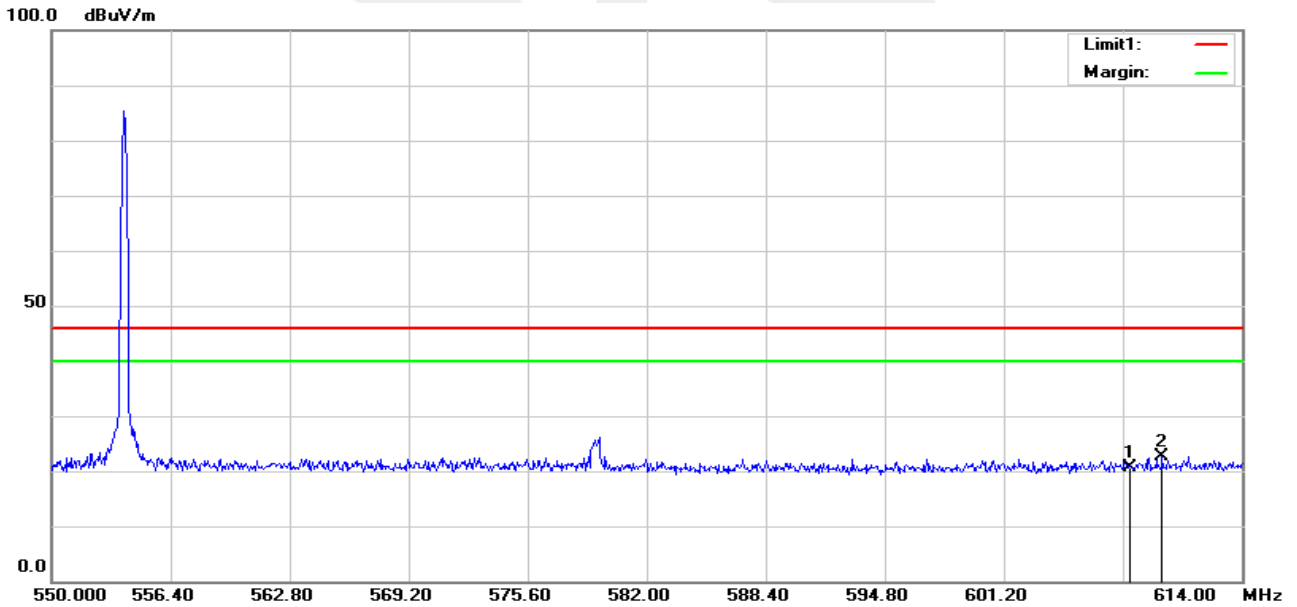

No.	Frequency (MHz)	Reading (dBuV)	Correct Factor(dB/m)	Result (dBuV/m)	Limit (dBuV/m)	Margin (dB)	Remark
1	608.0000	26.32	-5.57	20.75	46.00	-25.25	peak
2	609.7120	28.23	-5.51	22.72	46.00	-23.28	peak

#### 4. Part 15.236 REQUIREMENTS

##### 4.1 RADIATED SPURIOUS EMISSION

###### TEST LIMITS

According to Part 15.236 (g) and ETSI EN 300 422-1 V1.4.2 section 8.4.3, the limit will following below table.

**Table 3: Limits for spurious emissions**

State	Frequency		
	47 MHz to 74 MHz 87,5 MHz to 137 MHz 174 MHz to 230 MHz 470 MHz to 862 MHz	Other Frequencies below 1 000 MHz	Frequencies above 1 000 MHz
Operation	4 nW	250 nW	1 μW
Standby	2 nW	2 nW	20 nW

##### 4.2 EMISSION MASK

###### TEST LIMITS

- a. - According to Part 15.236 (g) and ETSI EN 300 422-1 V1.4.2 Clause 8.3.1.2, The transmitter output spectrum shall be within the mask defined in figure 3 where B is the declared channel bandwidth

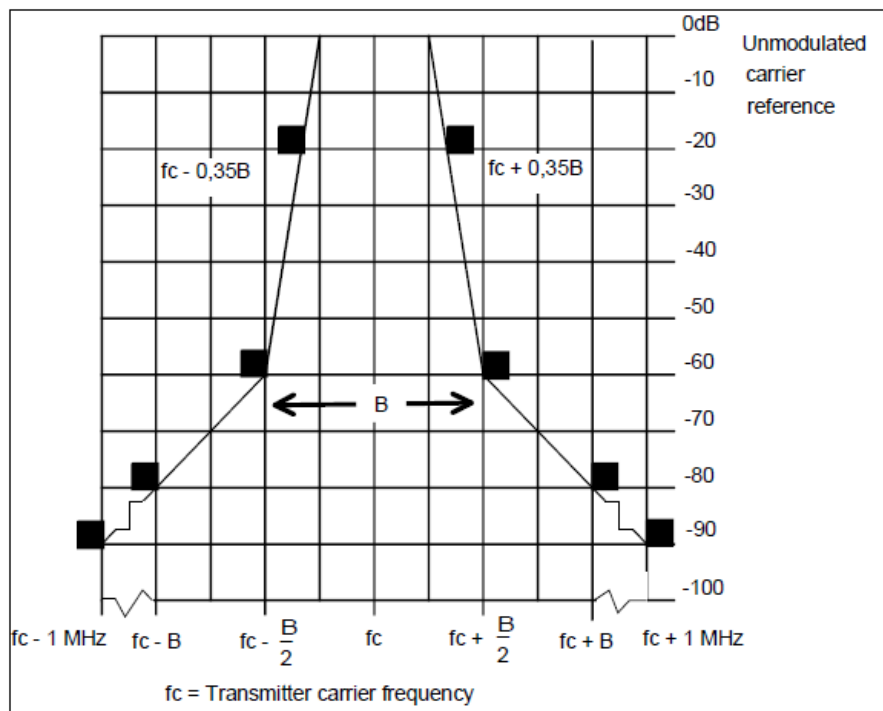

**Figure 3: Spectrum mask for analogue systems in all bands**

**TEST PROCEDURE**

- a. On a test site, the EUT shall be placed on a turntable and in the position closest to the normal use as declared by the user.
- b. The test antenna shall be oriented initially for vertical polarization located 3m from the EUT to correspond to the transmitter.
- c. The output of the antenna shall be connected to the measuring receiver and either a peak or quasi-peak detector was used for the measurement as indicated on the report. The detector selection is based on how close the emission level was approaching the limit.
- d. The transmitter shall be switched on; if possible, without the modulation and the measurement receiver shall be tuned to the frequency of the transmitter under test.
- e. The test antenna shall be raised and lowered through the specified range of height until the measuring receiver detects a maximum signal level.
- f. The transmitter shall than be rotated through 360°in the horizontal plane, until the maximum signal level is detected by the measuring receiver.
- g The test antenna shall be raised and lowered again through the specified range of height until the measuring receiver detects a maximum signal level.
- h The maximum signal level detected by the measuring receiver shall be noted.
- i The measurement shall be repeated with the test antenna set to horizontal polarization.
- j Replace the antenna with a proper Antenna (substitution antenna).
- k The substitution antenna shall be oriented for vertical polarization and, if necessary, the length of the substitution antenna shall be adjusted to correspond to the frequency of transmitting.
- l The substitution antenna shall be connected to a calibrated signal generator.
- m If necessary, the input attenuator setting of the measuring receiver shall be adjusted in order to increase the sensitivity of the measuring receiver.
- n The test antenna shall be raised and lowered through the specified range of the height to ensure that the maximum signal is received.
- o The input signal to substitution antenna shall be adjusted to the level that produces a level detected by the measuring receiver, that is equal to the level noted while the transmitter radiated power was measured, corrected for the change of input attenuation setting of the measuring receiver.
- p The input level to the substitution antenna shall be recorded as power level in dBm, corrected for any change of input attenuator setting of the measuring receiver.
- q The measurement shall be repeated with the test antenna and the substitution antenna oriented for horizontal polarization.

**TEST CONFIGURATION**

(A) Radiated Emission Test-Up Frequency Above 30MHz  
Ground Plane

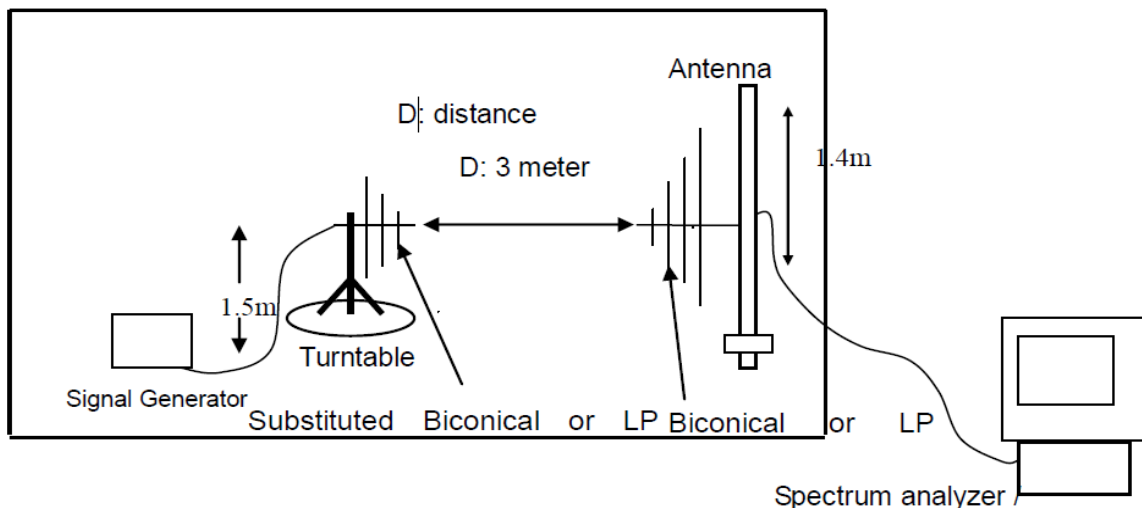

(B) Radiated Emission Test-Up Frequency Above 1GHz

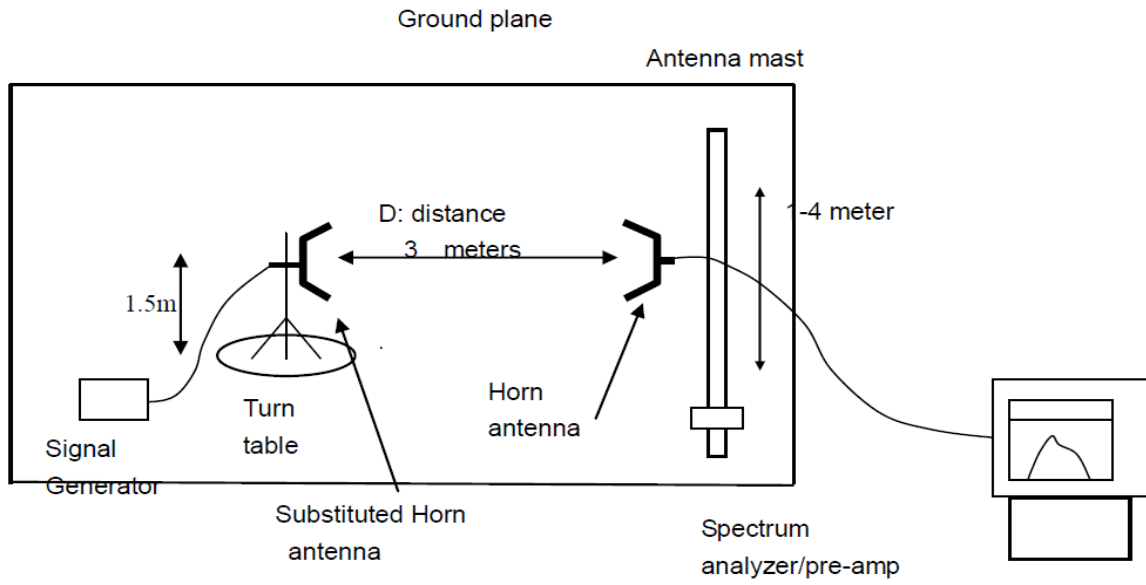



**TEST RESULTS**

Radiated Spurious Emission:

Low channel  
Horizontal

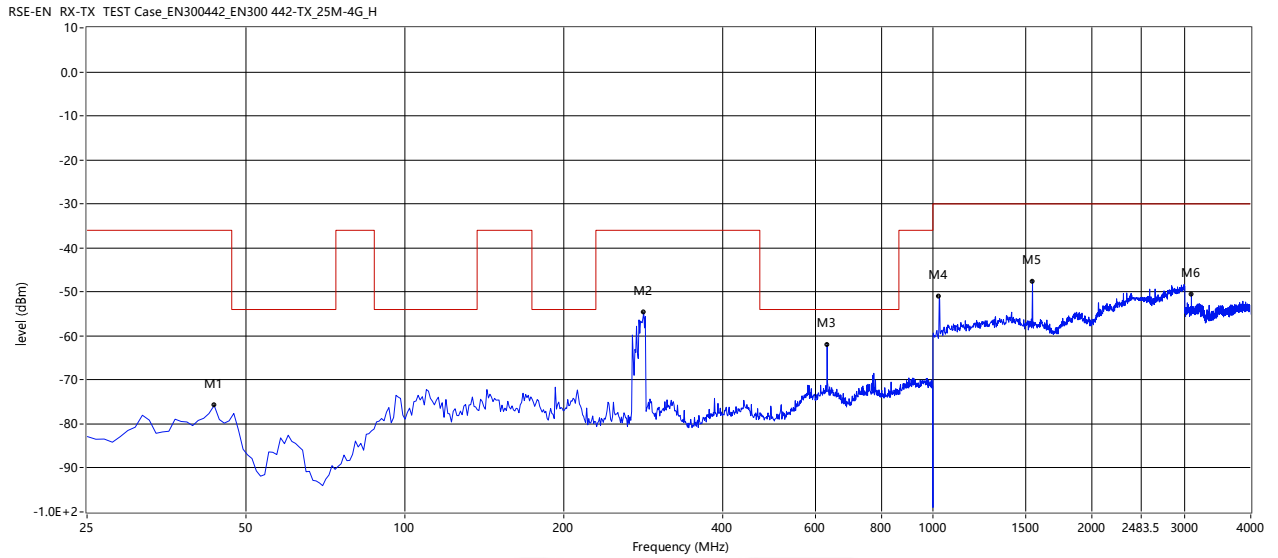

Frequency (MHz)	Result (dBm)	Factor (dB)	PK Limit (dBm)	Over Limit (dB)	Table (o)	ANT	EUT	Verdict
43.525	-75.80	-6.88	-36.0	-39.80	49.50	Horizontal	Vertical	Pass
283.375	-54.74	-5.82	-36.0	-18.74	139.00	Horizontal	Vertical	Pass
630.475	-62.00	7.26	-54.0	-8.00	137.00	Horizontal	Vertical	Pass
1028.000	-51.08	10.75	-30.0	-21.08	334.90	Horizontal	Vertical	Pass
1544.000	-47.68	12.73	-30.0	-17.68	355.50	Horizontal	Vertical	Pass
3087.000	-50.56	2.81	-30.0	-20.56	276.10	Horizontal	Vertical	Pass





Vertical

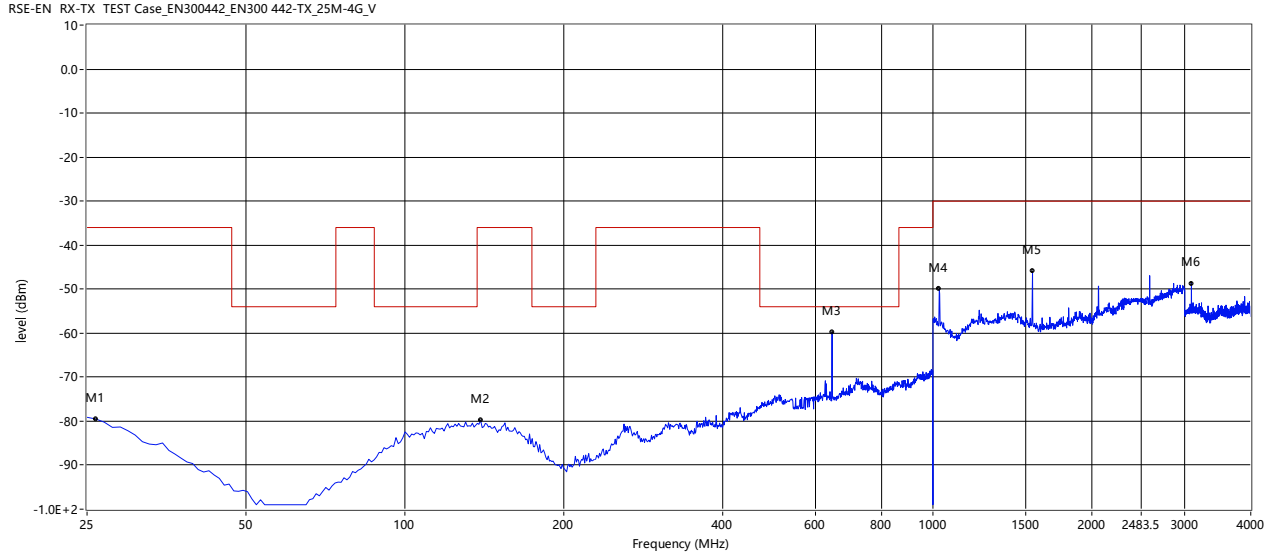

Frequency (MHz)	Result (dBm)	Factor (dB)	PK Limit (dBm)	Over Limit (dB)	Table (o)	ANT	EUT	Verdict
25.975	-79.51	-1.09	-36.0	-43.51	315.30	Vertical	Vertical	Pass
139.075	-79.77	-1.18	-36.0	-43.77	255.20	Vertical	Vertical	Pass
644.125	-59.81	5.18	-54.0	-5.81	35.10	Vertical	Vertical	Pass
1028.000	-49.99	12.04	-30.0	-19.99	124.70	Vertical	Vertical	Pass
1544.000	-45.90	12.46	-30.0	-15.90	359.80	Vertical	Vertical	Pass
3088.000	-48.74	2.23	-30.0	-18.74	339.40	Vertical	Vertical	Pass



Mid channel  
Horizontal

RSE-EN RX-TX TEST Case\_EN300442\_EN300 442-TX\_25M-4G\_H

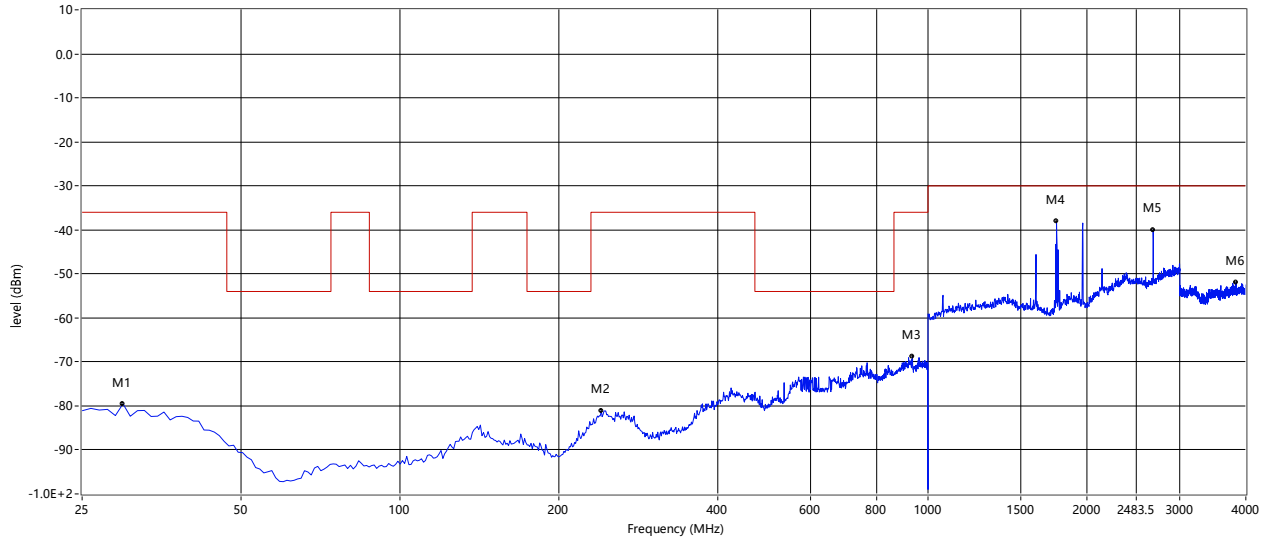

Frequency (MHz)	Result (dBm)	Factor (dB)	PK Limit (dBm)	Over Limit (dB)	Table (o)	ANT	EUT	Verdict
29.875	-79.52	-1.92	-36.0	-43.52	137.80	Horizontal	Vertical	Pass
240.475	-81.09	-0.79	-36.0	-45.09	64.40	Horizontal	Vertical	Pass
934.675	-68.71	8.57	-36.0	-32.71	296.20	Horizontal	Vertical	Pass
1752.000	-38.06	12.76	-30.0	-8.06	78.50	Horizontal	Vertical	Pass
2670.000	-43.14	18.93	-30.0	-13.14	288.20	Horizontal	Vertical	Pass
3829.000	-51.99	3.91	-30.0	-21.99	1.30	Horizontal	Vertical	Pass



Vertical

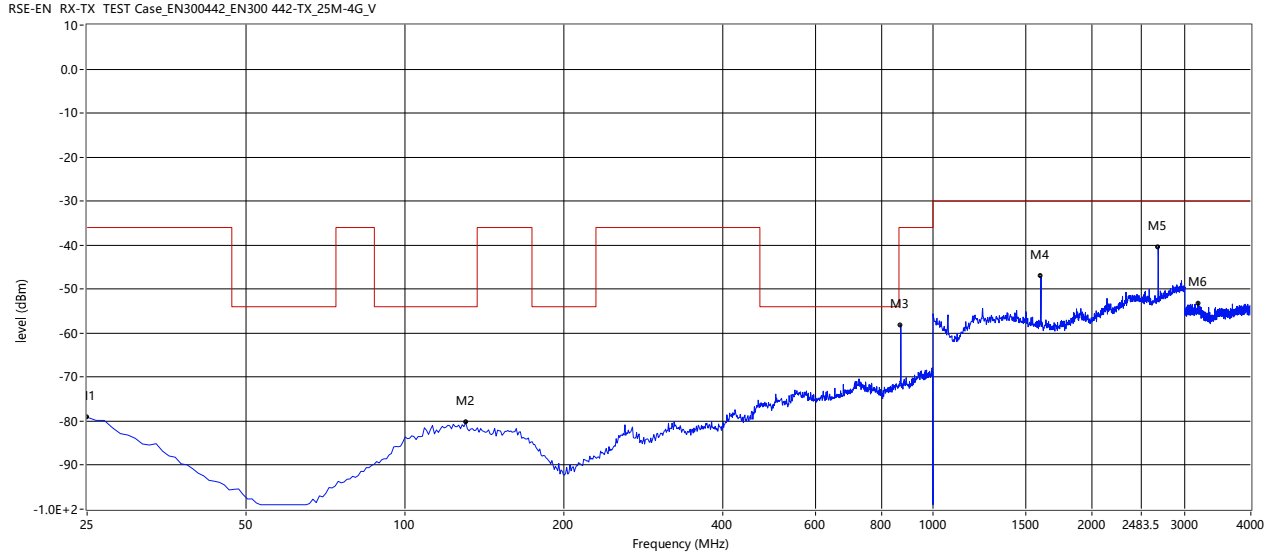

Frequency (MHz)	Result (dBm)	Factor (dB)	PK Limit (dBm)	Over Limit (dB)	Table (o)	ANT	EUT	Verdict
25.000	-79.09	-0.46	-36.0	-43.09	306.00	Vertical	Vertical	Pass
130.300	-80.28	-1.51	-54.0	-26.28	0.00	Vertical	Vertical	Pass
869.350	-58.19	8.22	-36.0	-22.19	33.50	Vertical	Vertical	Pass
1602.000	-47.05	11.99	-30.0	-17.05	54.20	Vertical	Vertical	Pass
2670.000	-40.53	18.48	-30.0	-10.53	39.70	Vertical	Vertical	Pass
3180.000	-53.21	2.60	-30.0	-23.21	163.00	Vertical	Vertical	Pass



### High channel Horizontal

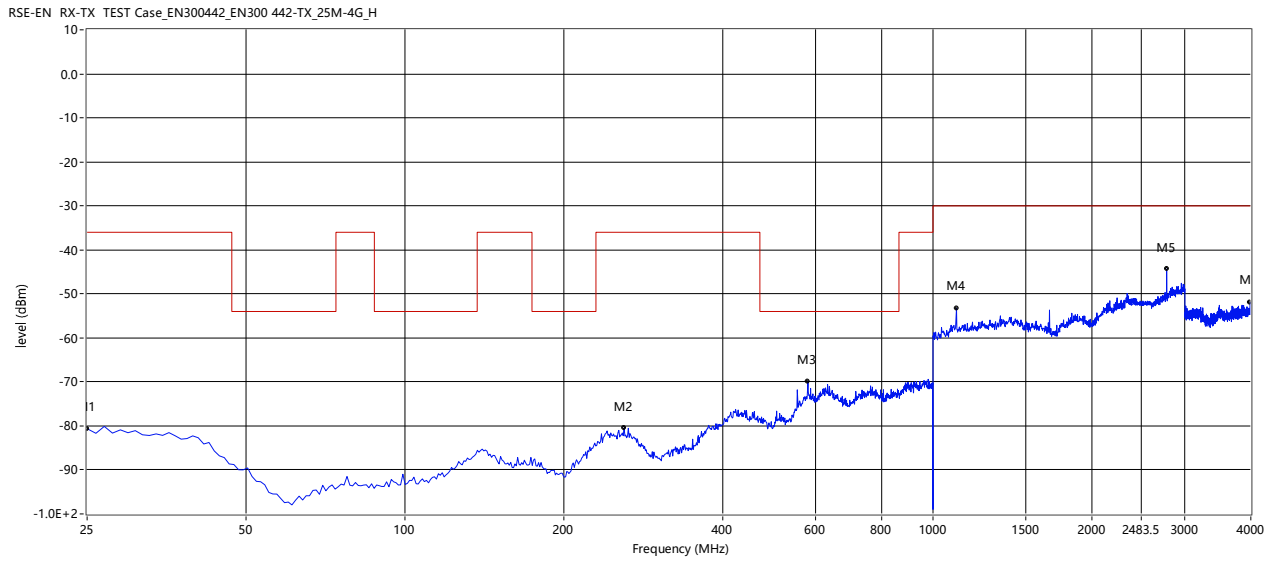

Frequency (MHz)	Result (dBm)	Factor (dB)	PK Limit (dBm)	Over Limit (dB)	Table (o)	ANT	EUT	Verdict
25.000	-80.62	-1.95	-36.0	-44.62	287.20	Horizontal	Vertical	Pass
259.975	-80.43	-1.53	-36.0	-44.43	52.30	Horizontal	Vertical	Pass
579.775	-69.99	6.69	-54.0	-15.99	136.30	Horizontal	Vertical	Pass
1108.000	-53.25	12.22	-30.0	-23.25	65.10	Horizontal	Vertical	Pass
2772.000	-44.36	20.07	-30.0	-14.36	39.90	Horizontal	Vertical	Pass
3989.000	-51.90	4.12	-30.0	-21.90	303.50	Horizontal	Vertical	Pass



Vertical

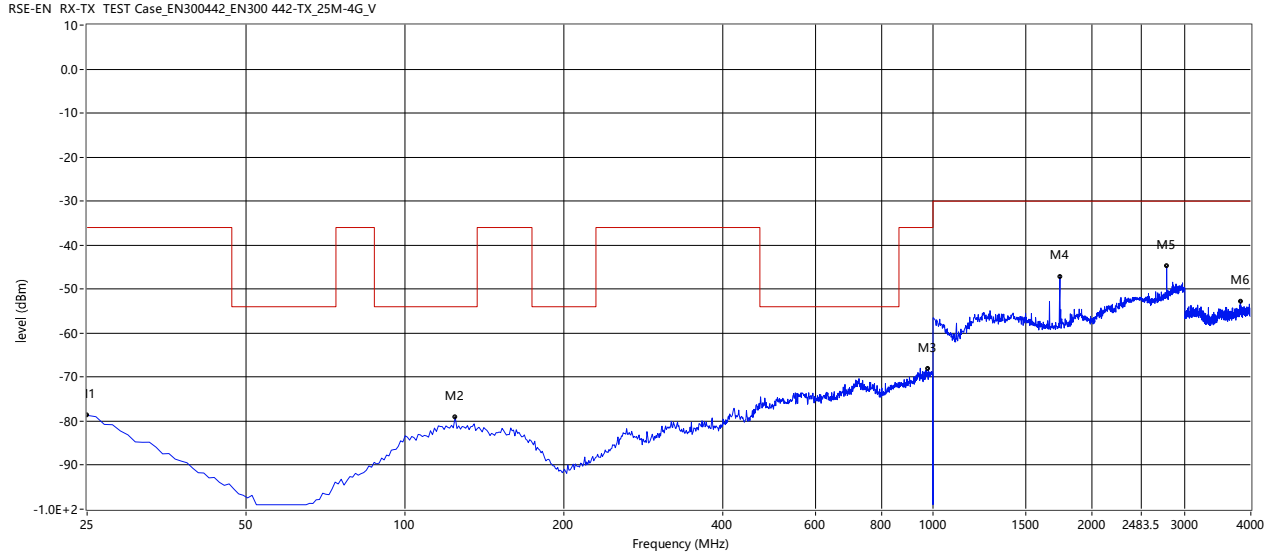

Frequency (MHz)	Result (dBm)	Factor (dB)	PK Limit (dBm)	Over Limit (dB)	Table (o)	ANT	EUT	Verdict
25.000	-78.67	-0.46	-36.0	-42.67	220.30	Vertical	Vertical	Pass
124.450	-79.08	-1.73	-54.0	-25.08	147.40	Vertical	Vertical	Pass
980.500	-68.23	10.42	-36.0	-32.23	111.90	Vertical	Vertical	Pass
1740.000	-47.18	12.14	-30.0	-17.18	294.90	Vertical	Vertical	Pass
2770.000	-46.20	19.27	-30.0	-16.20	51.80	Vertical	Vertical	Pass
3824.000	-52.91	2.94	-30.0	-22.91	4.50	Vertical	Vertical	Pass



### Emission Mask

ETSI EN 300 422-1 V1.4.2 Clause 8.3.1.2 The Maximum Measurement of Necessary Bandwidth Test Plot:

Frequency	Declared Bandwidth	B/2	
514.56 MHz	100K	50K	0.35B
533.83 MHz	100K	50K	35K
553.92 MHz	100K	50K	35K

### Low CH

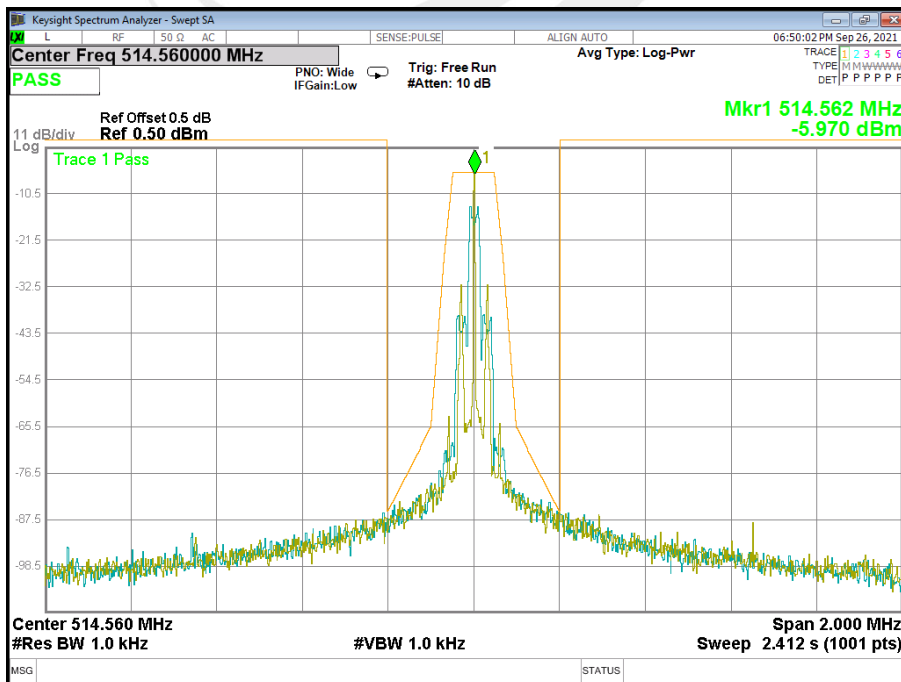
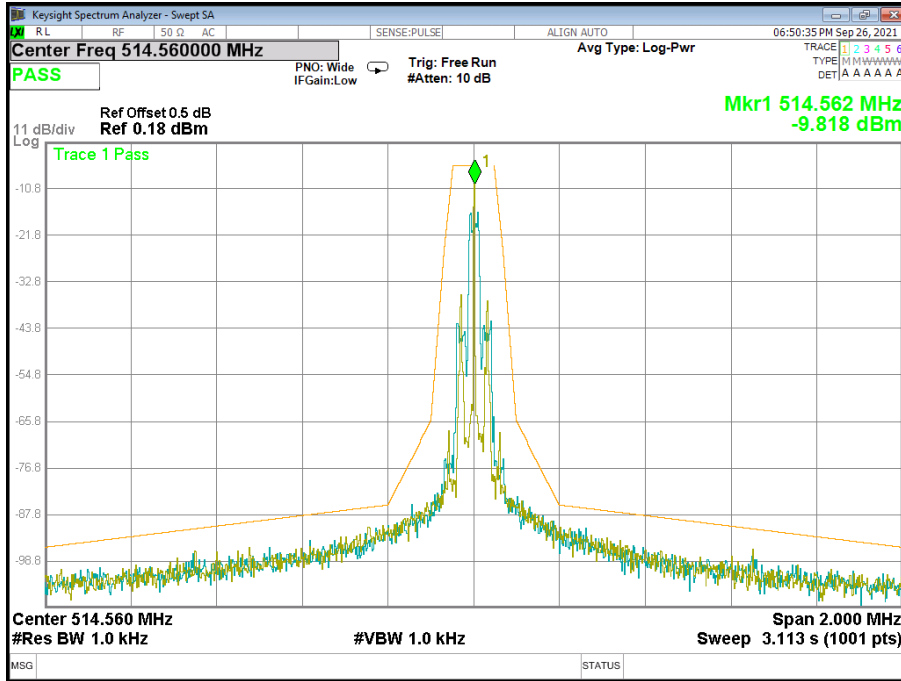



### Mid CH

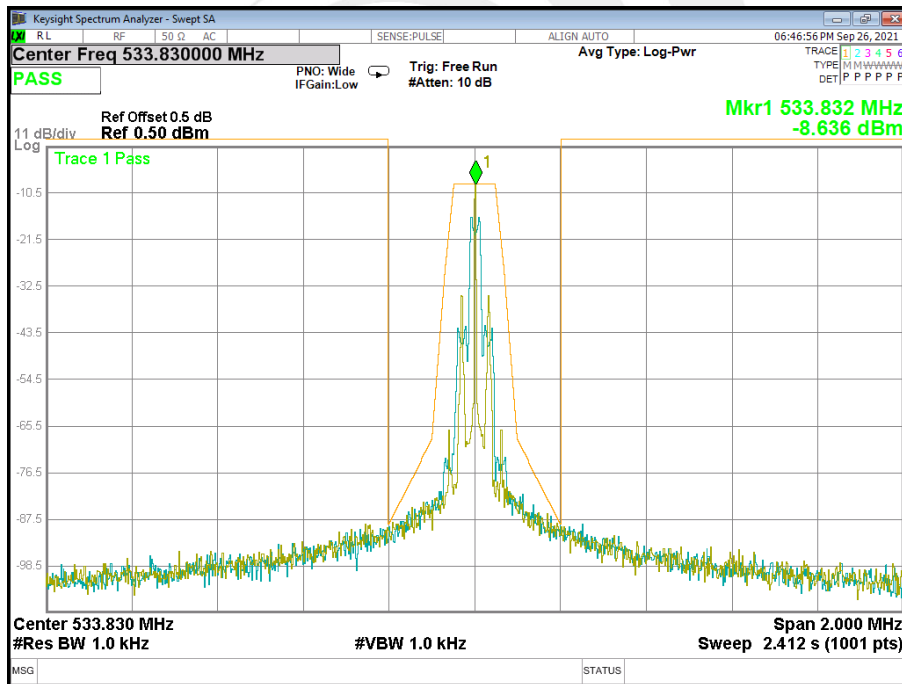
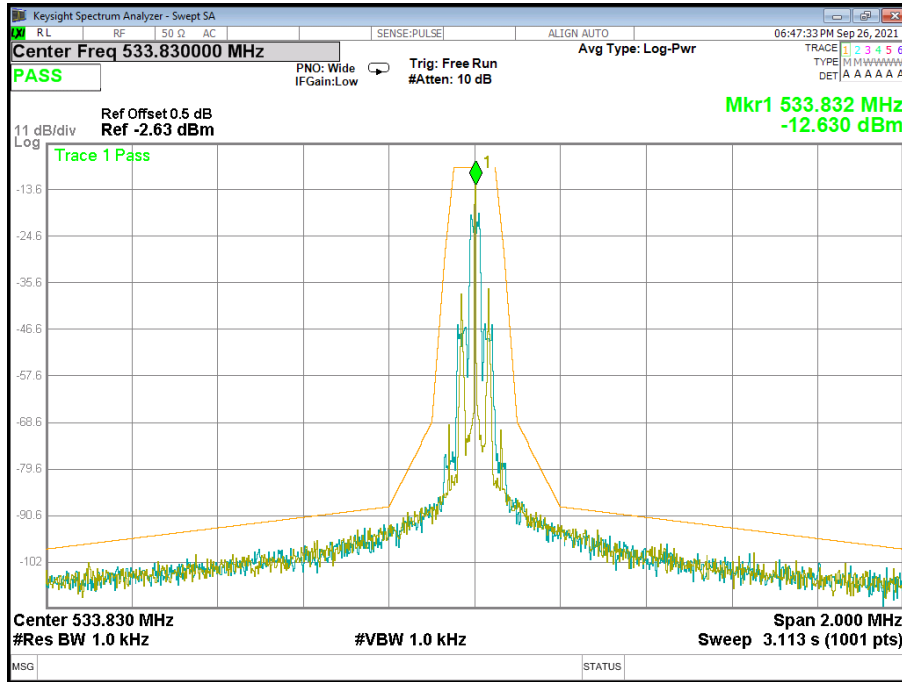



### High CH

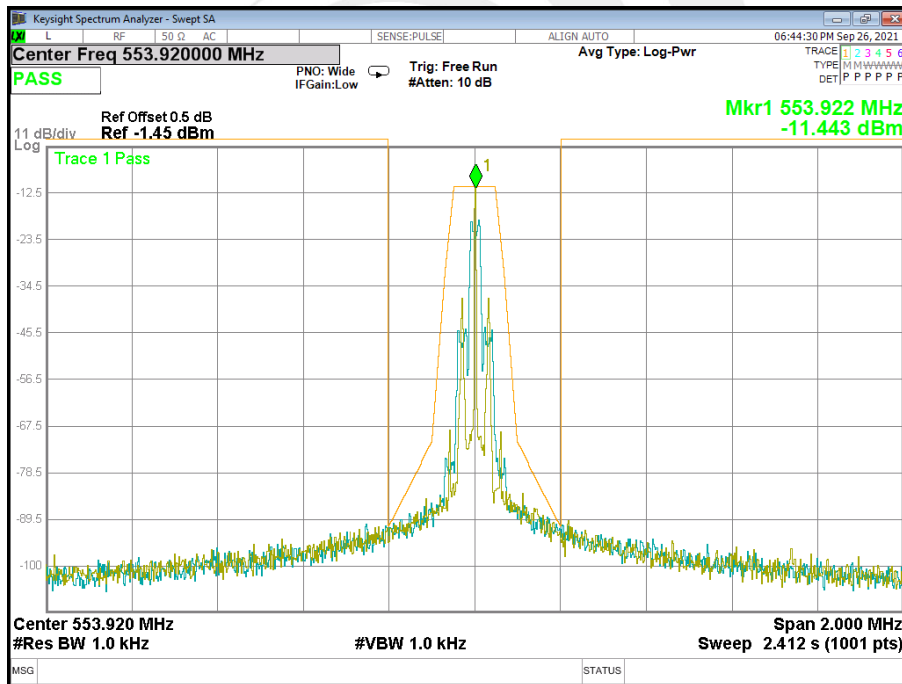
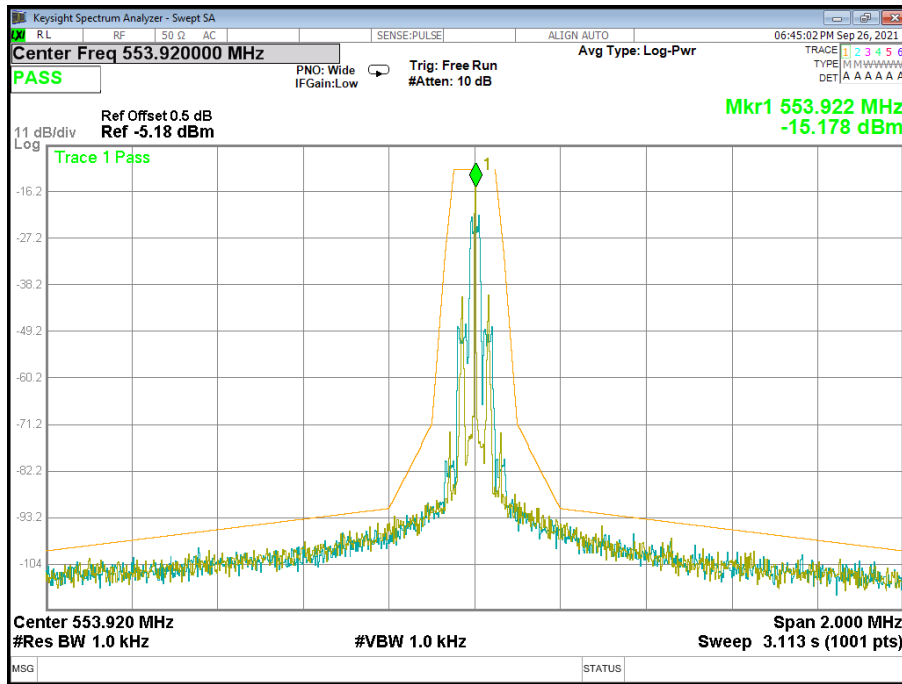



### 4.3 FREQUENCY STABILITY VS. TEMPERATURE & VOLTAGE

#### TEST LIMIT

According to Part 15.236 (f)(3), the frequency tolerance of the carrier signal shall be maintained within  $\pm 0.005\%$  of the operating frequency over a temperature variation of  $-20$  degrees to  $+50$  degrees C at normal supply voltage, and for a variation in the primary supply voltage from 85% to 115% of the rated supply voltage at a temperature of 20 degrees C. Battery operated equipment shall be tested using a new battery.

#### TEST CONFIGURATION

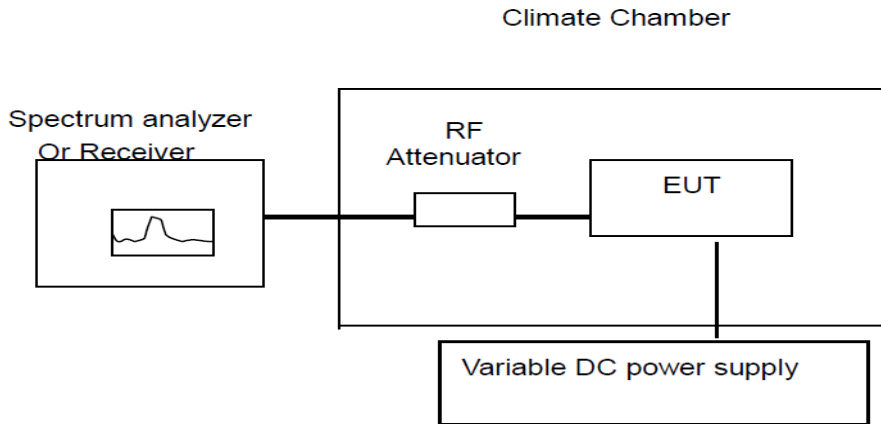

#### TEST PROCEDURE

The EUT was connected to an external DC power supply and the RF output was connected to a frequency counter via feed through attenuators. The EUT was placed inside the temperature chamber. The DC leads and the RF output cable, exited the chamber through an opening made for that purpose.

After the temperature stabilized the frequency output was recorded from the counter.

An external variable DC power supply was connected to the battery terminals of the equipment under test.

- b. For hand carried, battery powered equipment primary supply voltage was reduced to the battery operating end point as specified by the manufacturer. The output frequency was recorded for each battery voltage.

**TEST RESULTS**

- (1) Frequency stability versus input voltage (Supply Nominal voltage is DC 1.5\*2V)  
 (2) Frequency stability versus input voltage (Supply battery operating end point which shall be specified by the manufacturer DC 3.45V)

Reference Frequency: 514.56MHz					
Power Supply	Environment Temperature (°C)	Frequency Error (Hz)	Frequency Error (%)	Limit (%)	Results
3.45	20	1600	0.00031	±0.005	PASS
3.00	20	1601	0.00031		
2.55	20	1606	0.00031		
BEP	20	1593	0.00031		

Reference Frequency: 514.56MHz				
Environment Temperature(°C)	Frequency Deviation measured with time Elapse(30 minutes)			
	Frequency Error (Hz)	Frequency Error (%)	Limit (%)	Results
50	1618	0.00031	±0.005	PASS
40	1615	0.00031		
30	1616	0.00031		
20	1616	0.00031		
10	1613	0.00031		
0	1614	0.00031		
-10	1622	0.00032		
-20	1619	0.00031		



Reference Frequency: 533.83MHz					
Power Supply	Environment Temperature (°C)	Frequency Error (Hz)	Frequency Error (%)	Limit (%)	Results
3.45	20	1332	0.00025	±0.005	PASS
3.00	20	1336	0.00025		
2.55	20	1335	0.00025		
BEP	20	1335	0.00025		

Reference Frequency: 533.83MHz				
Environment Temperature(°C)	Frequency Deviation measured with time Elapse(30 minutes)			
	Frequency Error (Hz)	Frequency Error (%)	Limit (%)	Results
50	1337	0.00025	±0.005	PASS
40	1337	0.00025		
30	1339	0.00025		
20	1338	0.00025		
10	1337	0.00025		
0	1343	0.00025		
-10	1336	0.00025		
-20	1333	0.00025		



Reference Frequency: 553.92MHz					
Power Supply	Environment Temperature (°C)	Frequency Error (Hz)	Frequency Error (%)	Limit (%)	Results
3.45	20	1646	0.00027	±0.005	PASS
3.00	20	1646	0.00027		
2.55	20	1648	0.00027		
BEP	20	1656	0.00028		

Reference Frequency: 553.92MHz				
Environment Temperature(°C)	Frequency Deviation measured with time Elapse(30 minutes)			
	Frequency Error (Hz)	Frequency Error (%)	Limit (%)	Results
50	1647	0.00027	±0.005	PASS
40	1642	0.00027		
30	1648	0.00027		
20	1658	0.00028		
10	1664	0.00028		
0	1627	0.00027		
-10	1641	0.00027		
-20	1651	0.00028		



#### 4.4 OCCUPIED BANDWIDTH

##### TEST PROCEDURE

- a. The EUT was directly connected to the spectrum analyzer and antenna output port as show in the block diagram below.
- b. Spectrum Setting : RBW= 3KHz, VBW $\geq$ RBW, Sweep time = Auto.

##### TEST CONFIGURATION



##### EUT OPERATION CONDITIONS

TX mode.





TEST RESULT

Frequency(MHz)	20 dB Bandwidth(KHz)	Result
514.56	26.66	Pass
533.83	26.86	Pass
553.92	26.25	Pass

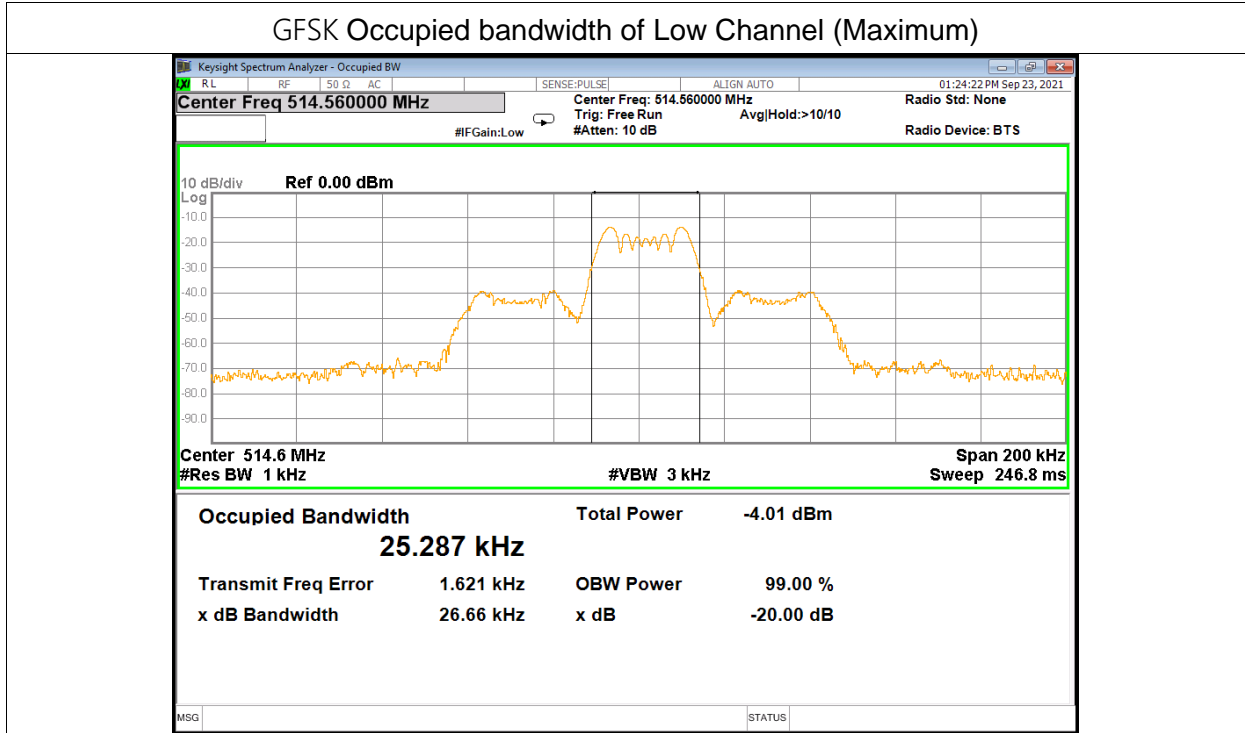



### GFSK Occupied bandwidth of Mid Channel (Maximum)

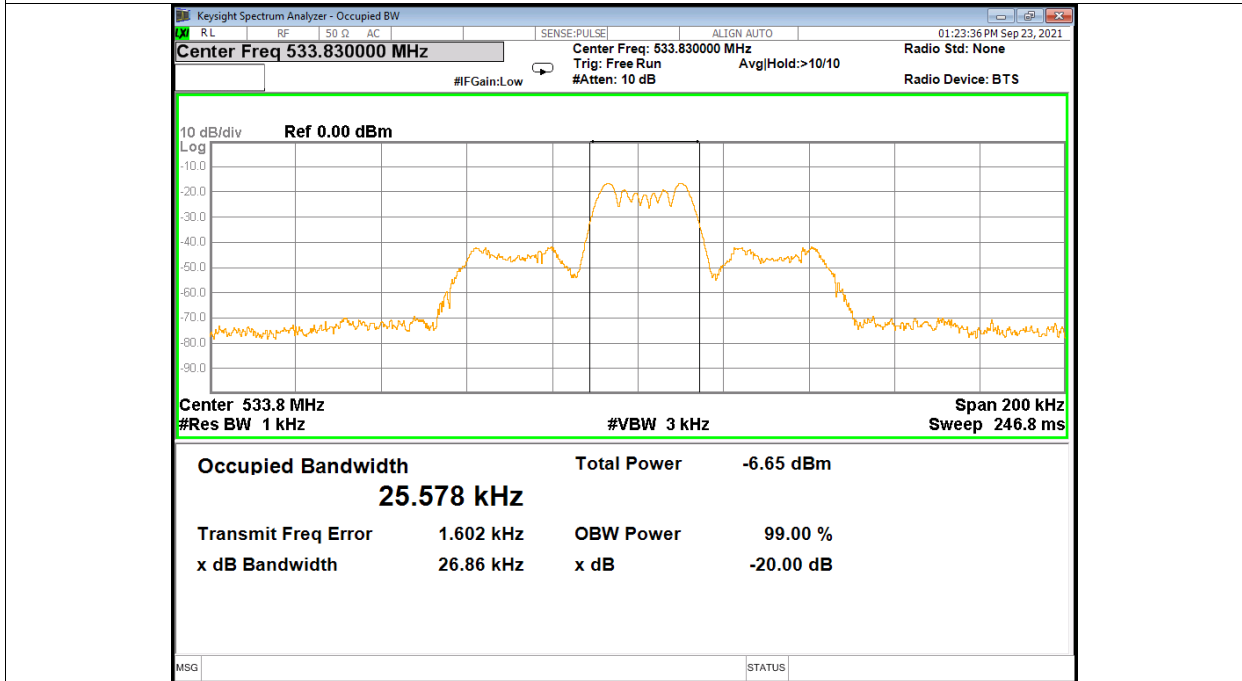

### GFSK Occupied bandwidth of High Channel (Maximum)

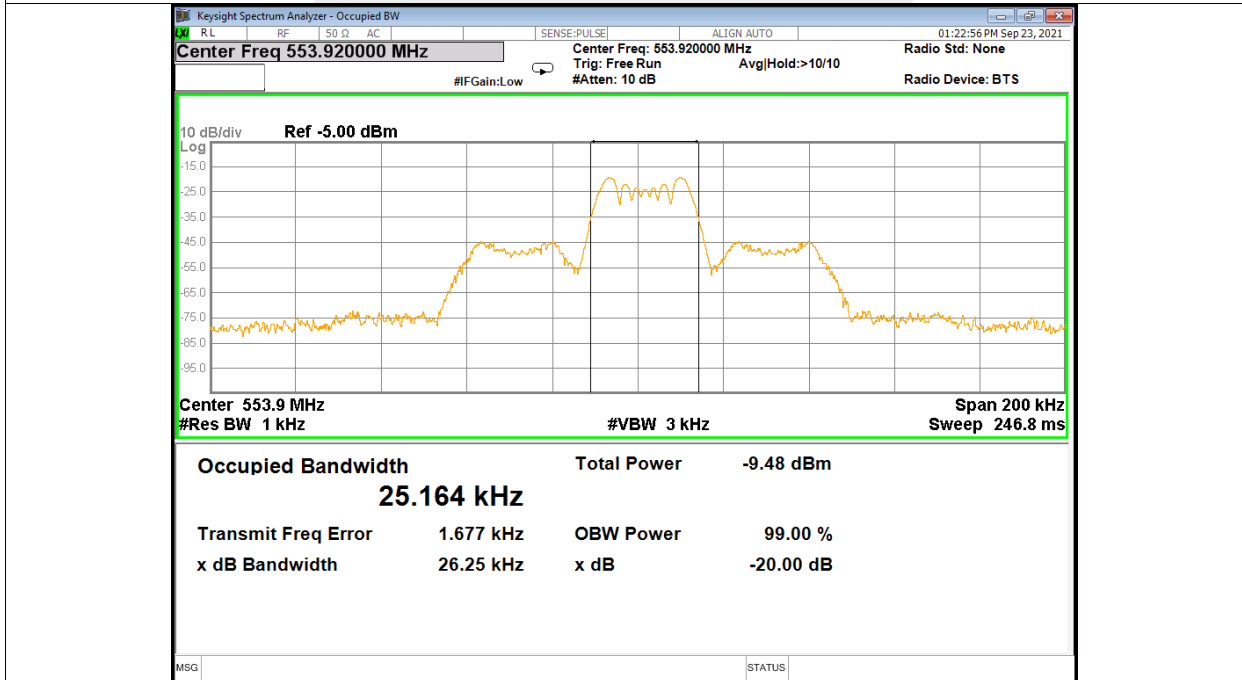

### 4.5 RADIATED POWER

#### TEST LIMIT

According to Part 15.236(d), the maximum radiated power shall not exceed the following:

- (1) In the bands allocated and assigned for broadcast television and in the 600 MHz service band: 50 mW EIRP
- (2) In the 600 MHz guard band and the 600 MHz duplex gap: 20 mW EIRP.

#### TEST CONFIGURATION

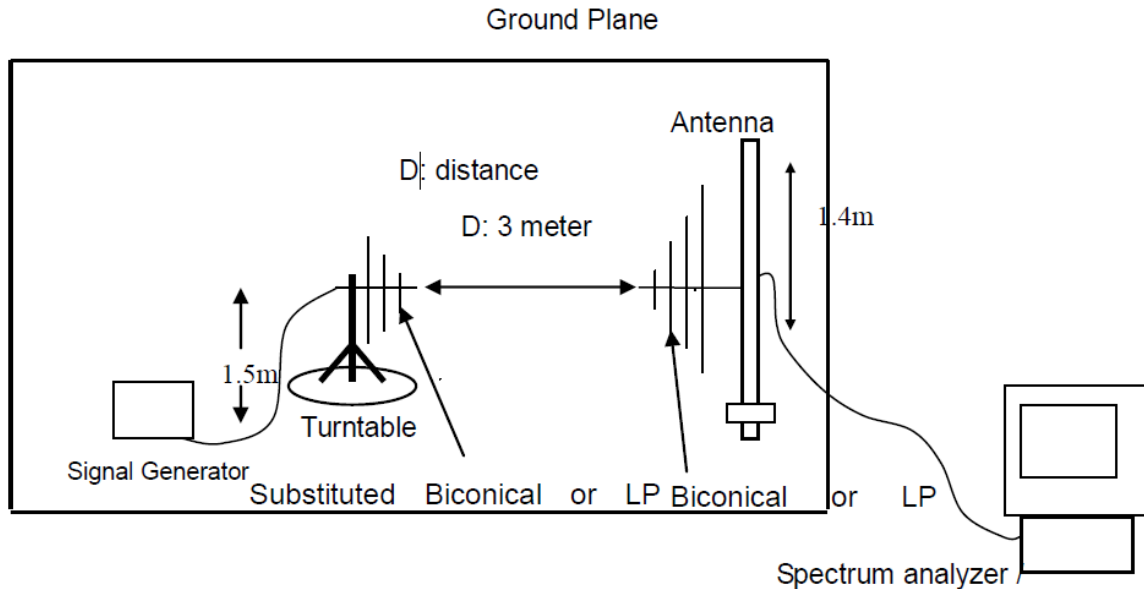

#### Conduction

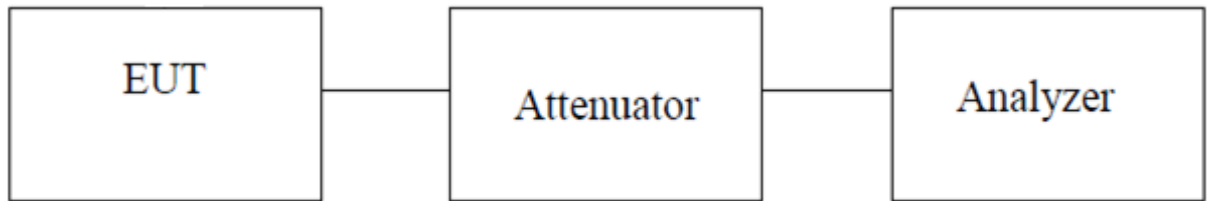

#### TEST PROCEDURE

- a. On a test site, the EUT shall be placed on a turntable and in the position closest to the normal use as declared by the user.
- b. The test antenna shall be oriented initially for vertical polarization located 3m from the EUT to correspond to the transmitter.
- c. The output of the antenna shall be connected to the measuring receiver and either a peak or quasi-peak detector was used for the measurement as indicated on the report. The detector selection is based on how close the emission level was approaching the limit.
- d. The transmitter shall be switched on; if possible, without the modulation and the measurement receiver shall be tuned to the frequency of the transmitter under test.
- e. The test antenna shall be raised and lowered through the specified range of height until the measuring receiver detects a maximum signal level.
- f. The transmitter shall then be rotated through 360° in the horizontal plane, until the maximum signal level is detected by the measuring receiver.
- g. The test antenna shall be raised and lowered again through the specified range of height until the measuring receiver detects a maximum signal level.
- h. The maximum signal level detected by the measuring receiver shall be noted.
- i. The measurement shall be repeated with the test antenna set to horizontal polarization.





- j Replace the antenna with a proper Antenna (substitution antenna).
- k The substitution antenna shall be oriented for vertical polarization and, if necessary, the length of the substitution antenna shall be adjusted to correspond to the frequency of transmitting.
- l The substitution antenna shall be connected to a calibrated signal generator.
- m If necessary, the input attenuator setting of the measuring receiver shall be adjusted in order to increase the sensitivity of the measuring receiver.
- n The test antenna shall be raised and lowered through the specified range of the height to ensure that the maximum signal is received.
- o The input signal to substitution antenna shall be adjusted to the level that produces a level detected by the measuring receiver, that is equal to the level noted while the transmitter radiated power was measured, corrected for the change of input attenuation setting of the measuring receiver.
- p The input level to the substitution antenna shall be recorded as power level in dBm, corrected for any change of input attenuator setting of the measuring receiver.
- q The measurement shall be repeated with the test antenna and the substitution antenna oriented for horizontal polarization.

### TEST PROCEDURE (Conduction)

- a. The RF output of the transceiver was connected to the input of the spectrum analyzer through sufficient attenuation.
- b. Set the RBW  $>20\text{BW}$ , VBW  $>3\text{xRBW}$ .
- c. Detector = peak.
- d Sweep time = auto couple.
- e Trace mode = max hold.
- f Allow trace to fully stabilize.
- g Use the peak marker function to determine the maximum amplitude level.



## TEST RESULT

Maximum Equivalent Isotropically Radiated Power								
Ambient temperature: 22 °C			Relative humidity: 55%					
Frequency	S.G.Lev	Ant	Loss	EIRP	EIRP	Limit	Polarity	Result
(MHz)	(dBm)	( dBi)	(dB)	(dBm)	(mW)	(mW)		
514.56	-10.48	4.80	1.6	-7.28	0.19	50.00	H	Pass
514.56	-10.31	4.80	1.6	-7.11	0.19	50.00	V	Pass

Maximum Equivalent Isotropically Radiated Power								
Ambient temperature: 22 °C			Relative humidity: 55%					
Frequency	S.G.Lev	Ant	Loss	EIRP	EIRP	Limit	Polarity	Result
(MHz)	(dBm)	( dBi)	(dB)	(dBm)	(mW)	(mW)		
533.83	-13.06	4.80	1.6	-9.86	0.10	50.00	H	Pass
533.83	-13.00	4.80	1.6	-9.80	0.10	50.00	V	Pass

Maximum Equivalent Isotropically Radiated Power								
Ambient temperature: 22 °C			Relative humidity: 55%					
Frequency	S.G.Lev	Ant	Loss	EIRP	EIRP	Limit	Polarity	Result
(MHz)	(dBm)	( dBi)	(dB)	(dBm)	(mW)	(mW)		
553.92	-15.91	4.80	1.6	-12.71	0.05	50.00	H	Pass
553.92	-15.82	4.80	1.6	-12.62	0.05	50.00	V	Pass



## PHOTOS OF TEST SETUP

Note: See test photos in setup photo document for the actual connections between Product and support equipment.

※※※※※END OF THE REPORT※※※※※

