

## TEST REPORT

<b>Report Number</b> .....:	90686-23-72-23-PP001	
<b>Date of issue</b> .....:	2023-08-11	
<b>Tested by (+signature)</b> .....:	Duke Chen	<i>Duke Chen</i>
<b>Approved by (+signature)</b> .....:	Jason Gao	<i>Jason gao</i>
<b>Testing Laboratory name</b> .....:	SLG-CPC Testlaboratory Co., Ltd.	
<b>Address</b> .....:	No. 11, Wu Song Road, Dongcheng District, Dongguan, Guangdong Province, China 523117	
<b>Applicant's name</b> .....:	Adam Elements International Co., LTD.	
<b>Address</b> .....:	8F.-5, No.148, Sec. 4, Zhongxiao E Rd., Da'an Dist., Taipei City 106, Taiwan	
<b>Manufacturer's name</b> .....	Power System Electronic Technology Co., Ltd.	
<b>Address</b> .....:	No.1 Shangbian Road, Puxin Industrial District, Shipai Town, Dongguan City, Guangdong, China	
<b>Factory's name</b> .....	Power System Electronic Technology Co., Ltd.	
<b>Address</b> .....:	No.1 Shangbian Road, Puxin Industrial District, Shipai Town, Dongguan City, Guangdong, China	
<b>Standard(s)</b> .....:	FCC Rules and Regulations Part 15 Subpart C, Section 209	
<b>Test item description</b> .....:	Magnetic Power Bank with Foldable Stand	
<b>Trade Mark</b> .....:		
<b>Model/Type reference</b> .....:	GRAVITY CS10, GRAVITY CS5	
<b>FCC ID</b> .....:	2ABY9GRAVITY-CS10	
<b>Date of receipt of test item</b> .....:	July 19, 2023	
<b>Date (s) of performance of test:</b>	July 19, 2023--July 25, 2023	
<b>Summary of Test Results</b> .....:	<b>Pass</b>	
The Summary of Test Results based on a technical opinion belongs to the standard(s).		
<b>General disclaimer:</b>		
This report shall not be reproduced except in full, without the written approval of SLG-CPC Testlaboratory Co., Ltd. The test results in the report only apply to the tested sample.		

## TABLE OF CONTENT

<b>TABLE OF CONTENT .....</b>	<b>2</b>
<b>1. SUMMARY OF TEST RESULTS .....</b>	<b>3</b>
<b>2. GENERAL INFORMATION .....</b>	<b>4</b>
2.1. Description of Device (EUT) .....	4
2.2. Independent Operation Modes .....	5
2.3. Description of Test Facility .....	5
2.4. Description of Support Device .....	6
2.5. Measurement Uncertainty .....	6
<b>3. MEASURING DEVICE AND TEST EQUIPMENT .....</b>	<b>7</b>
3.1. MEASUREMENT EQUIPMENT USED .....	7
<b>4. 20DB BANDWIDTH .....</b>	<b>8</b>
4.1. Test Procedure .....	8
4.2. Test Results .....	8
<b>5. POWER LINE CONDUCTED EMISSION MEASUREMENT .....</b>	<b>10</b>
5.1. Block Diagram of Test Setup .....	10
5.2. Limits .....	10
5.3. Test Procedure .....	10
5.4. Measuring Results .....	11
<b>6. RADIATED EMISSION TEST .....</b>	<b>16</b>
6.1. Measurement Procedure .....	16
6.2. Test SET-UP (Block Diagram of Configuration) .....	16
6.3. Radiated Emission Limit .....	17
6.4. Measurement Result .....	18
<b>7. ANTENNA APPLICATION .....</b>	<b>30</b>
7.1. Antenna Requirement .....	30
7.2. Result .....	30

## 1. SUMMARY OF TEST RESULTS

<b>EMISSION</b>		
Description of Test Item	Standard & Limits	Results
Conducted Emission	FCC Part 15, Subpart C- Section 15.207 ANSI C63.10-2013	Pass
Radiated Emission	FCC Part 15, Subpart C- Section 15.209 ANSI C63.10-2013	Pass
20dB Bandwidth	FCC Part 15, Subpart C- Section 15.215 ANSI C63.10-2013	Pass
Antenna Application	FCC Part 15, Subpart C- Section 15.203 ANSI C63.10-2013	Pass
Note: N/A is an abbreviation for Not Applicable.		

## 2. GENERAL INFORMATION

### 2.1. Description of Device (EUT)

Product Name	Magnetic Power Bank with Foldable Stand
Trade Name	
Model Name	GRAVITY CS10, GRAVITY CS5
Model Differences	The battery capacity of GRAVITY CS10 is 10000mAh. The battery capacity of GRAVITY CS5 is 5000mAh.  All the models have the same circuit diagram and PCB layout, except for model name, size, battery capacity and colour.
Series Model	N/A
Test Model	GRAVITY CS10
Operation frequency	110-205KHz
Modulation Type	FSK
Antenna Type	Inductive Loop Antenna with 11 Turns
Wireless Charging	5W/7.5W/10W/15W
Hardware version number	V1.0
Software version number	V1.0
Connecting I/O Port(s)	Please refer to the User's Manual

## 2.2. Independent Operation Modes

	Mode	TEST MODE DESCRIPTION
	1.	Full Load+Wireless Charging
	2.	Half Load+Wireless Charging
	3	No Load+Wireless Charging
Note: 1. All test modes were pre - tested, but we only recorded the worst case in this report.		

## 2.3. Description of Test Facility

### Site Description

FCC recognition of accreditation for SLG-CPC Test laboratory Co., Ltd.

Designation Number: CN1287

Test Firm Registration:394054

## 2.4. Description of Support Device

No.	Equipment	Trade name	Model	S/N	Input/ Output
1.	Mobile phone	Xiao mi	Mi 11	6F7DFA8A	50W MAX.
2.	ADAPTER	Huanwei		/	Input:100-240VAC, 50/60Hz Output: 5V3A, 9V2A
3.					
4.					

## 2.5. Measurement Uncertainty

Test Item	Uncertainty
Occupied Channel Bandwidth	: $\pm 2.3\%$
Conducted Emission Uncertainty	: 3.08dB
Radiated Emission Uncertainty	: 3.60dB (30MHz~1GHz)
	3.46dB(0.009MHz~30MHz)
(3m Chamber)	4.48dB (1~6GHz)

### 3. MEASURING DEVICE AND TEST EQUIPMENT

#### 3.1. MEASUREMENT EQUIPMENT USED

Equipment	Manufacturer	Model	S/N	Last Cal.	Cal. Due
<b>RF Connected Test</b>					
Vector Signal Generater	Rohde & Schwarz	SMBV100B(6G)	101166	2023/06/04	1 year
Analog Signal Generator	Rohde & Schwarz	SMB100A(40G)	181333	2023/06/02	1 year
Signal Analyzer	Rohde & Schwarz	FSV40	101527	2023/03/29	1 year
Power Analyzer	Rohde & Schwarz	OSP-B157W8	N/A	2023/06/02	1 year
Wideband Radio Communication Tester	R&S	CMW270	101985	2023/06/16	1 year
Temperature&Humidity test chamber	ESPEC	VC 4018	/	2023/04/11	1 year
Wideband Radio Communication Tester	Rohde & Schwarz	CMW500	166898	2023/06/16	1 year
Spectrum control unit	Agilent	N9020A	MY48011676	2023/02/15	1 year
Testing software	Tonscend	JS0806-2	10165	2023/02/15	1 year
Testing software	Tonscend	JSTS1120-3	10165	2023/02/15	1 year
<b>Radiated Emission Test</b>					
EMI Test Receiver	KEYSIGHT	N9010A	MY56070465	2022/12/7	1 year
EMI Test Receiver	Rohde & Schwarz	FSV40	101511	2023/03/29	1 year
Bilog Antenna	Schwarzbeck	VULB 9163	01335	2023/03/29	3 year
Power Amplifier	EMEC	EM330	060676	2022/12/7	1 year
Cable	Tuyue	F4309	L-400-NmNm-12000	2022/12/7	1 year
Signal Analyzer	Rohde & Schwarz	FSV40	101511	2023/03/29	1 year
Horn Antenna	Schwarzbeck	BBHA9170	00954	2022/09/13	3 year
Power Amplifier	Rohde & Schwarz	SCU-18F	180118	2023/04/21	1 year
Active Loop Antenna	ETS LINDGREN	6512	41623	2022/04/23	3 year
Test Software	Farad	EZ-EMC	Ver.CPC-3A1	/	
<b>Conducted Emission Test</b>					
LISN	Schwarzbeck	NSLK 8127	8127-892	2023/03/21	1 year
EMI Test Receiver	R&S	ESR3	102124	2022/12/7	1 year
Pulse Limiter	R&S	ESH3-Z2	357.8810.52	2022/12/7	1 year
Test Software	Farad	EZ-EMC	Ver.CPC-3A1	/	

## 4. 20DB BANDWIDTH

### 4.1. Test Procedure

Set to the maximum power setting and enable the EUT transmit continuously

- a) The spectrum analyzer center frequency is set to the nominal EUT channel center frequency. The span range for the EMI receiver or spectrum analyzer shall be between two times and five times the OBW.
  - b) The nominal IF filter bandwidth (3 dB RBW) shall be in the range of 1% to 5% of the OBW and video bandwidth (VBW) shall be approximately three times RBW.
  - c) Set the reference level of the instrument as required, keeping the signal from exceeding the maximum input mixer level for linear operation.
  - d) The dynamic range of the instrument at the selected RBW shall be more than 10 dB below the target “-xx dB down” requirement
  - e) Set detection mode to peak and trace mode to max hold.
  - f) Determine the “-xx dB down amplitude” using [(reference value) - xx]. Alternatively, this calculation may be made by using the marker-delta function of the instrument.
- Measure and record the results in the test report.

### 4.2. Test Results

Note: Because the measured signal is CW-like, adjusting the RBW per C63.10 would not be practical since measurement bandwidth will always follow the RBW. The RBW is set to 300 Hz to perform the occupied bandwidth test.

Test model: GRAVITY CS10

Temperature:	24°C	Test Date:	July 20, 2023
Humidity:	53 %	Test By:	Ken
Frequency	143.5 kHz	20 dB occupied bandwidth	955 Hz
		99% occupied bandwidth	710 Hz

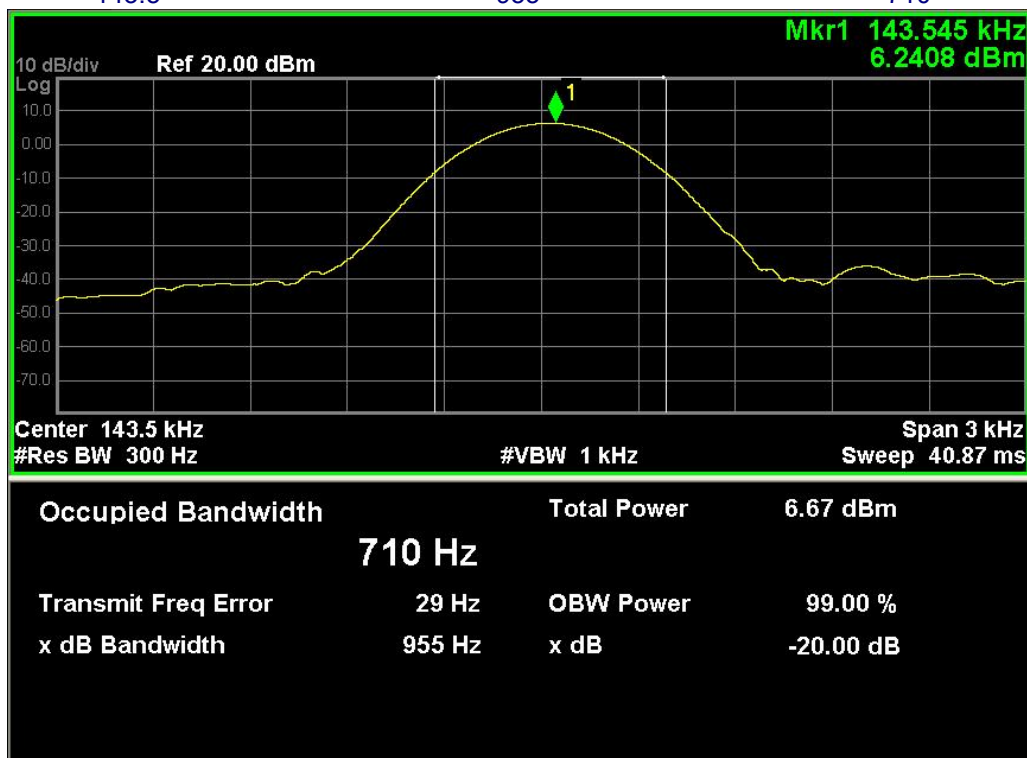



Test model: GRAVITY CS5

Temperature: 24°C  
Humidity: 53 %

Test Date: July 20, 2023  
Test By: Ken

Frequency	20 dB occupied bandwidth	99% occupied bandwidth
kHz	Hz	Hz
148.9	1005	747



## 5. POWER LINE CONDUCTED EMISSION MEASUREMENT

### 5.1. Block Diagram of Test Setup

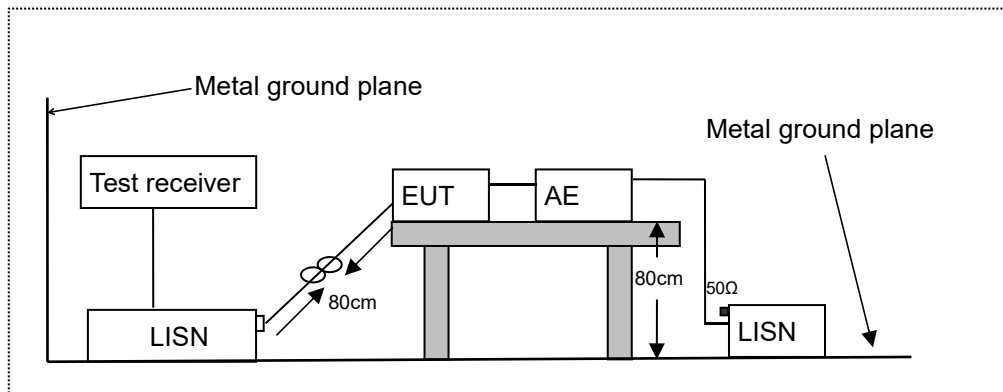

LISN: Line Impedance Stabilization Network  
 AE: Associated equipment  
 EUT: Equipment under test

### 5.2. Limits

FCC Part 15.207

Frequency (MHz)	Limit (dB $\mu$ V)	
	Quasi-peak Level	Average Level
0.15 ~ 0.50	66.0 ~ 56.0 *	56.0 ~ 46.0 *
0.50 ~ 5.00	56.0	46.0
5.00 ~ 30.00	60.0	50.0

NOTE1-The lower limit shall apply at the transition frequencies.  
 NOTE2-The limit decreases linearly with the logarithm of the frequency in the range 0.15MHz to 0.50MHz.

### 5.3. Test Procedure

The EUT was placed on a desk 0.8 m height from the metal ground plane and 0.4 m from the conducting wall of the shielding room and it was kept at least 0.8 m from any other grounded conducting surface. The size of the table will nominally be 1.5 m x1.0 m.

The rear of the arrangement shall be flush with the back of the supporting tabletop unless that would not be possible or typical of normal use.

All units of equipment forming the system under test (includes the EUT as well as connected peripherals and associated equipment or devices) shall be arranged such that a nominal 0.1 m separation is achieved between the neighboring units.

Connect EUT to the power mains through a line impedance stabilization network (LISN). Where the mains cable supplied by the manufacturer is longer than 1 m, the excess should be folded at the centre into a bundle no longer than 0.4 m, so that its length is shortened to 1 m.

All the support units are connecting to the other LISN.

The LISN provides 50 ohm coupling impedance for the measuring instrument.

Both sides of AC line were checked for maximum conducted interference.

The frequency range from 150 kHz to 30 MHz was sweep.

Set the test-receiver system to quasi peak detect function and average detect function, and to measure the conducted emissions values.

Test results were obtained from the following equation:

Emission Level (dB $\mu$ V) = LISN Factor (dB) + Cable Loss (dB) + Reading (dB $\mu$ V)

Margin (dB) = Emission Level (dB $\mu$ V) - Limit (dB $\mu$ V)

#### 5.4. Measuring Results

**PASS.**

M/N	:	GRAVITY CS10			
Test Mode	:	FSK			
Test Phase	:	Power Line; Live			
Test Voltage	:	AC 120V/60Hz			
Temperature (°C):	23.5	Relative Humidity (%):	42	Atmospheric Pressure(kPa) :	101.4

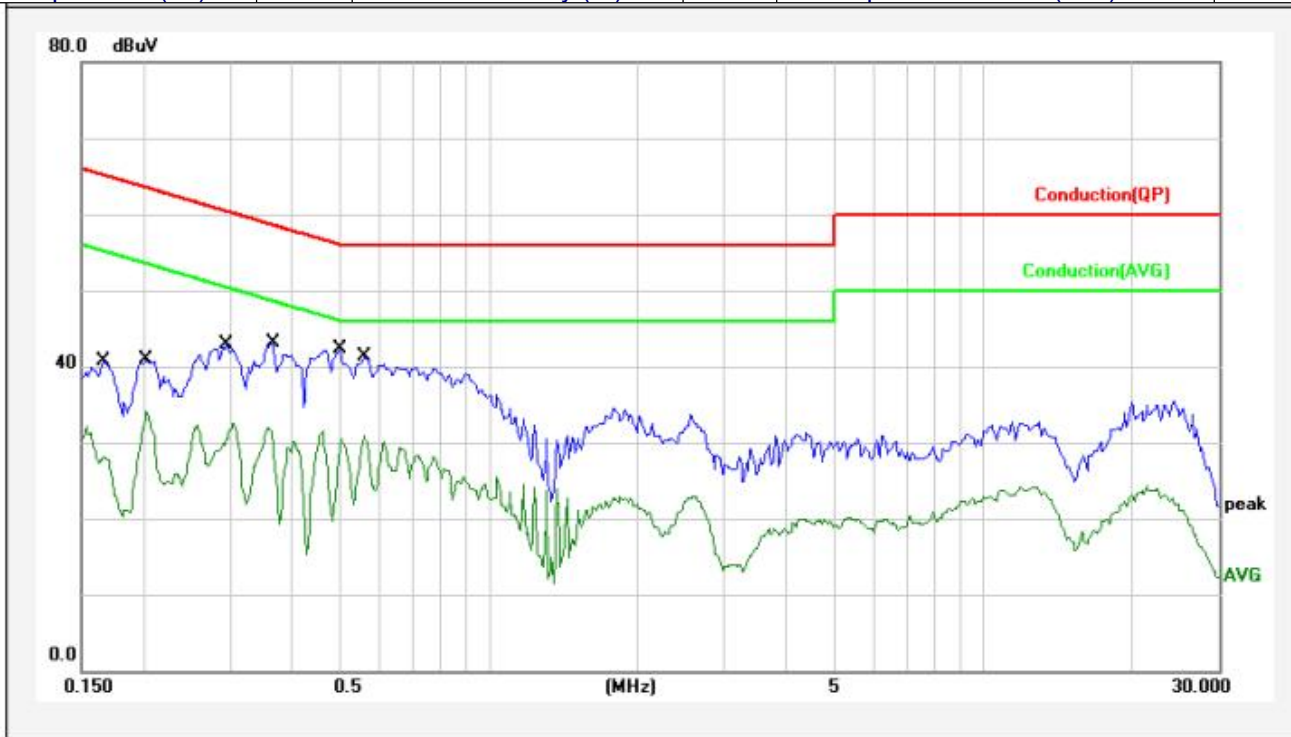

No.	Frequency (MHz)	Factor (dB)	Reading (dBuV)	Level (dBuV)	Limit (dBuV)	Margin (dB)	Detector	P/F	Remark
1	0.1663	10.30	27.35	37.65	65.14	-27.49	QP	P	
2	0.1663	10.30	21.72	32.02	55.14	-23.12	AVG	P	
3	0.2030	10.31	27.57	37.88	63.49	-25.61	QP	P	
4	0.2030	10.31	23.70	34.01	53.49	-19.48	AVG	P	
5	0.2952	10.34	29.47	39.81	60.38	-20.57	QP	P	
6	0.2952	10.34	22.23	32.57	50.38	-17.81	AVG	P	
7	0.3660	10.36	29.66	40.02	58.59	-18.57	QP	P	
8	0.3660	10.36	21.47	31.83	48.59	-16.76	AVG	P	
9	0.4995	10.40	28.86	39.26	56.01	-16.75	QP	P	
10	0.4995	10.40	21.02	31.42	46.01	-14.59	AVG	P	
11	0.5584	10.42	27.91	38.33	56.00	-17.67	QP	P	
12	0.5584	10.42	20.43	30.85	46.00	-15.15	AVG	P	

Note: Level=Reading+Factor.  
Margin=Level-Limit.

M/N	:	GRAVITY CS10			
Test Mode	:	FSK			
Test Phase	:	Power Line; Neutral			
Test Voltage	:	AC 120V/60Hz			
Temperature (°C):	23.5	Relative Humidity (%):	42	Atmospheric Pressure(kPa) :	101.4

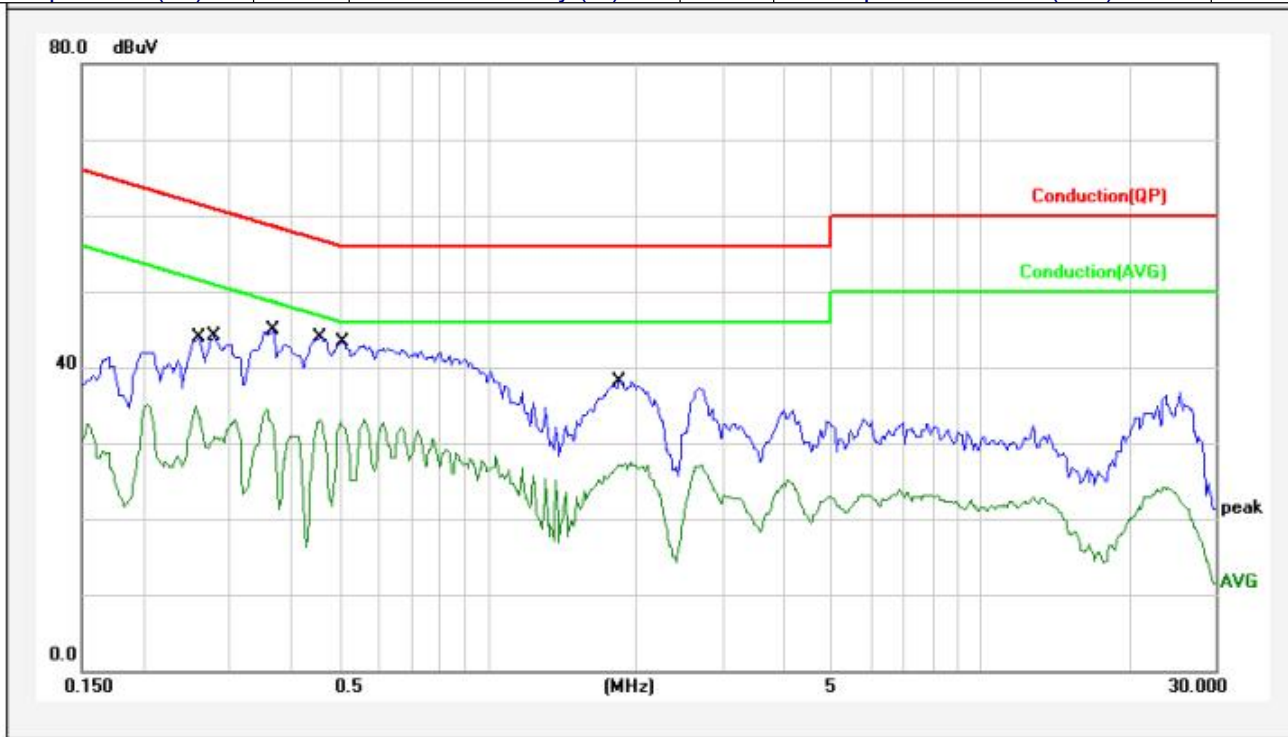

No.	Frequency (MHz)	Factor (dB)	Reading (dBuV)	Level (dBuV)	Limit (dBuV)	Margin (dB)	Detector	P/F	Remark
1	0.2600	10.37	30.53	40.90	61.43	-20.53	QP	P	
2	0.2600	10.37	24.54	34.91	51.43	-16.52	AVG	P	
3	0.2792	10.38	30.78	41.16	60.84	-19.68	QP	P	
4	0.2792	10.38	22.72	33.10	50.84	-17.74	AVG	P	
5	0.3690	10.40	31.48	41.88	58.52	-16.64	QP	P	
6	0.3690	10.40	24.06	34.46	48.52	-14.06	AVG	P	
7	0.4576	10.42	30.45	40.87	56.74	-15.87	QP	P	
8	0.4576	10.42	22.67	33.09	46.74	-13.65	AVG	P	
9	0.5076	10.43	29.91	40.34	56.00	-15.66	QP	P	
10	0.5076	10.43	22.63	33.06	46.00	-12.94	AVG	P	
11	1.8456	10.57	24.46	35.03	56.00	-20.97	QP	P	
12	1.8456	10.57	17.00	27.57	46.00	-18.43	AVG	P	

Note: Level=Reading+Factor.  
Margin=Level-Limit.

M/N	:	GRAVITY CS5			
Test Mode	:	FSK			
Test Phase	:	Power Line; Live			
Test Voltage	:	AC 120V/60Hz			
Temperature (°C):	23.5	Relative Humidity (%):	42	Atmospheric Pressure(kPa):	101.4

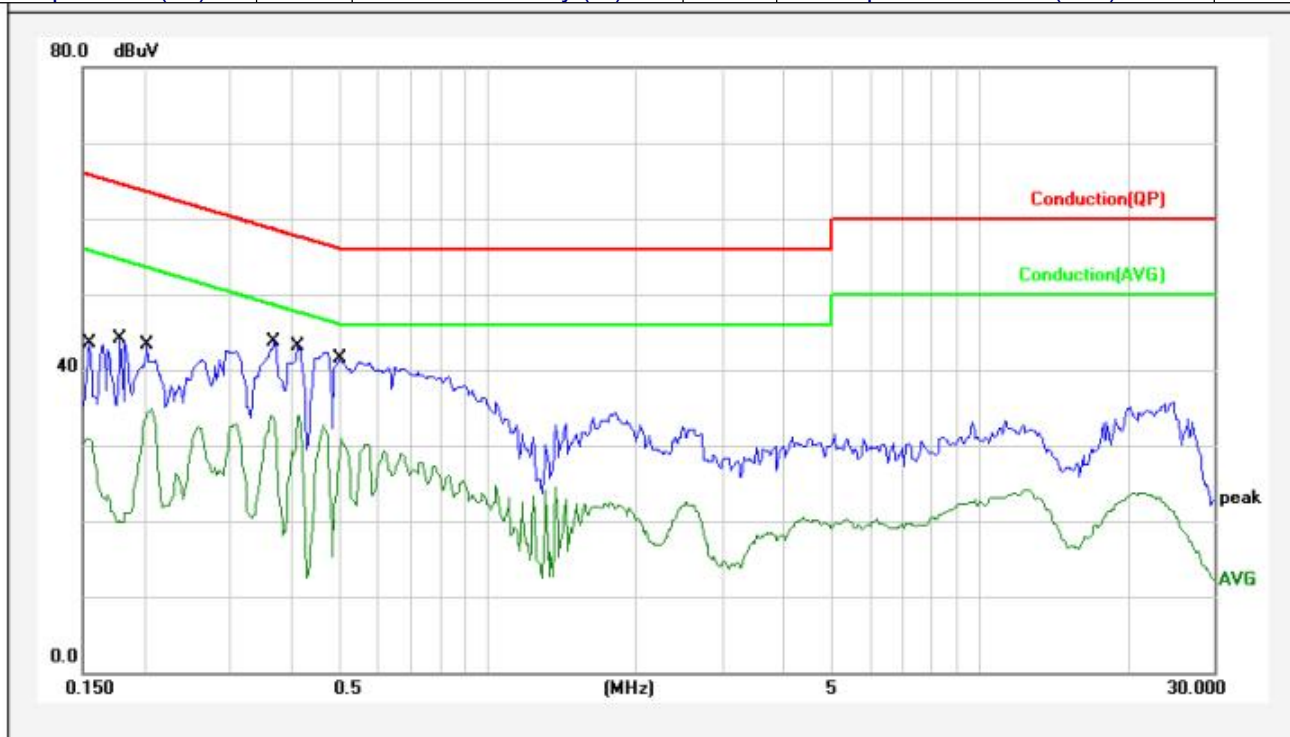

No.	Frequency (MHz)	Factor (dB)	Reading (dBuV)	Level (dBuV)	Limit (dBuV)	Margin (dB)	Detector	P/F	Remark
1	0.1547	10.30	30.23	40.53	65.74	-25.21	QP	P	
2	0.1547	10.30	20.59	30.89	55.74	-24.85	AVG	P	
3	0.1785	10.31	30.76	41.07	64.56	-23.49	QP	P	
4	0.1785	10.31	11.08	21.39	54.56	-33.17	AVG	P	
5	0.2030	10.31	30.01	40.32	63.49	-23.17	QP	P	
6	0.2030	10.31	24.50	34.81	53.49	-18.68	AVG	P	
7	0.3690	10.36	30.38	40.74	58.52	-17.78	QP	P	
8	0.3690	10.36	23.60	33.96	48.52	-14.56	AVG	P	
9	0.4126	10.37	29.73	40.10	57.60	-17.50	QP	P	
10	0.4126	10.37	23.61	33.98	47.60	-13.62	AVG	P	
11	0.4995	10.40	28.04	38.44	56.01	-17.57	QP	P	
12	0.4995	10.40	20.58	30.98	46.01	-15.03	AVG	P	

Note: Level=Reading+Factor.  
Margin=Level-Limit.

M/N	:	GRAVITY CS5			
Test Mode	:	FSK			
Test Phase	:	Power Line; Neutral			
Test Voltage	:	AC 120V/60Hz			
Temperature (°C):	23.5	Relative Humidity (%):	42	Atmospheric Pressure(kPa):	101.4

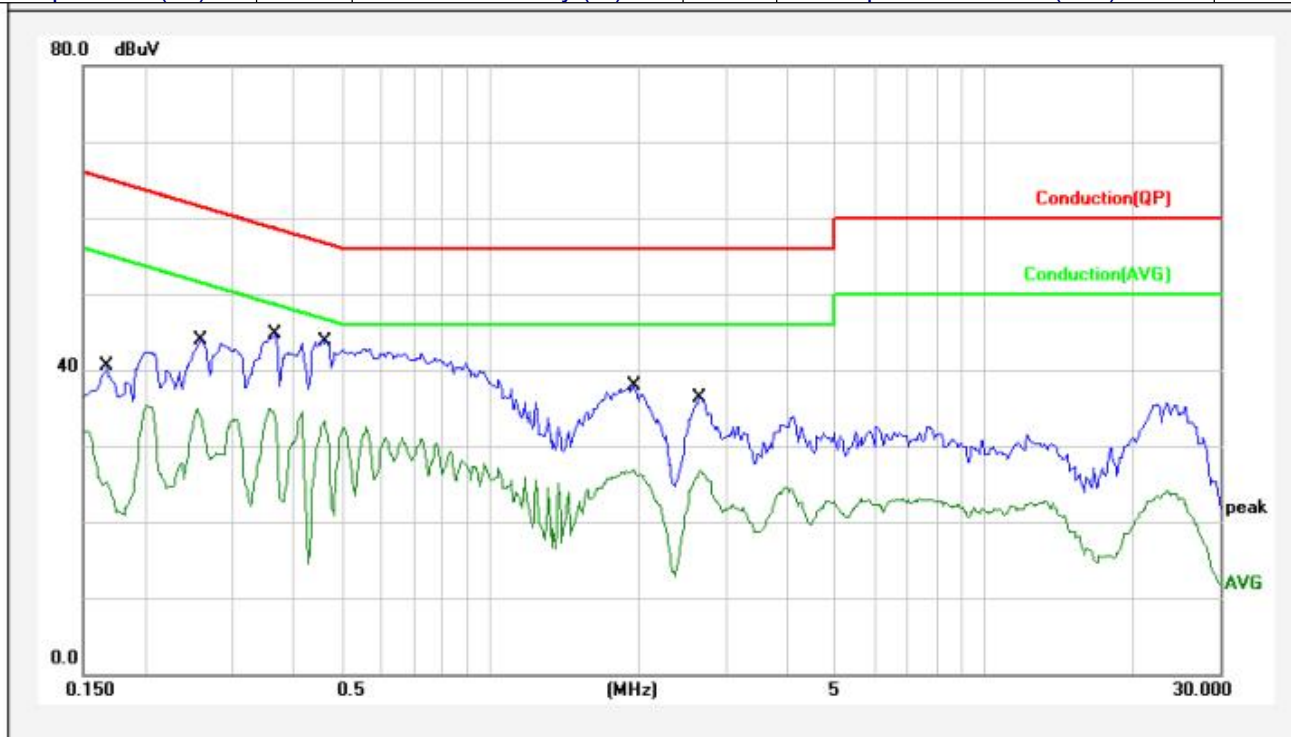

No.	Frequency (MHz)	Factor (dB)	Reading (dBuV)	Level (dBuV)	Limit (dBuV)	Margin (dB)	Detector	P/F	Remark
1	0.1676	10.35	27.14	37.49	65.08	-27.59	QP	P	
2	0.1676	10.35	21.61	31.96	55.08	-23.12	AVG	P	
3	0.2600	10.37	30.49	40.86	61.43	-20.57	QP	P	
4	0.2600	10.37	24.45	34.82	51.43	-16.61	AVG	P	
5	0.3690	10.40	31.32	41.72	58.52	-16.80	QP	P	
6	0.3690	10.40	24.54	34.94	48.52	-13.58	AVG	P	
7	0.4650	10.42	30.33	40.75	56.60	-15.85	QP	P	
8	0.4650	10.42	24.15	34.57	46.60	-12.03	AVG	P	
9	1.9515	10.57	24.40	34.97	56.00	-21.03	QP	P	
10	1.9515	10.57	16.43	27.00	46.00	-19.00	AVG	P	
11	2.6627	10.59	22.71	33.30	56.00	-22.70	QP	P	
12	2.6627	10.59	16.06	26.65	46.00	-19.35	AVG	P	

Note: Level=Reading+Factor.  
Margin=Level-Limit.

## 6. RADIATED EMISSION TEST

### 6.1. Measurement Procedure

1. The EUT was placed on a turn table which is 0.8m above ground plane.
2. Maximum procedure was performed on the six highest emissions to ensure EUT compliance.
3. And also, each emission was to be maximized by changing the polarization of receiving antenna both horizontal and vertical.
4. Repeat above procedures until all frequency measured were complete.
5. Use the following receiver/spectrum analyzer settings:  
 Span = wide enough to fully capture the emission being measured  
 RBW=200Hz for 9KHz to 150KHz,  
 RBW=9kHz for 150KHz to 30MHz,  
 RBW=120KHz for 30MHz to 1GHz  
 VBW  $\geq 3 \times$  RBW  
 Sweep = auto  
 Detector function = QP  
 Trace = max hold

### 6.2. Test SET-UP (Block Diagram of Configuration)

(A) Radiated Emission Test Set-Up, Frequency Below 30MHz

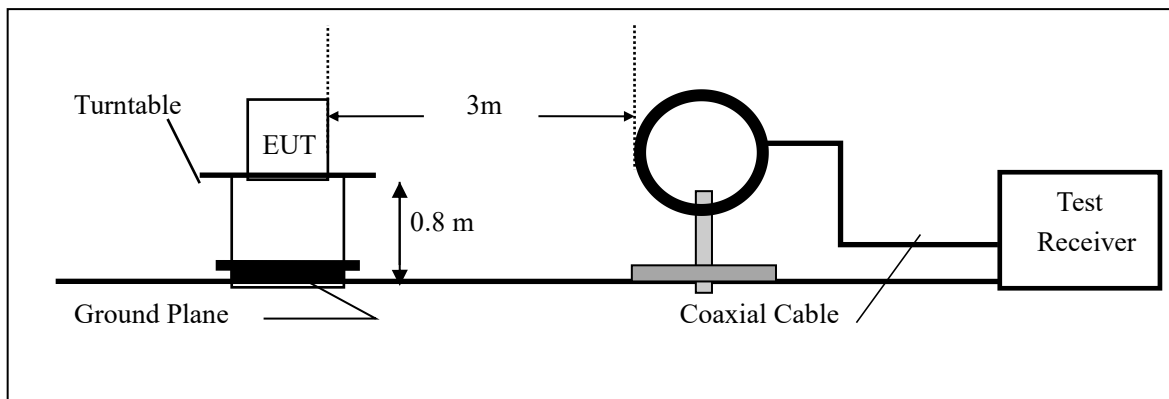

(B) Radiated Emission Test Set-Up, Frequency Below 1000MHz

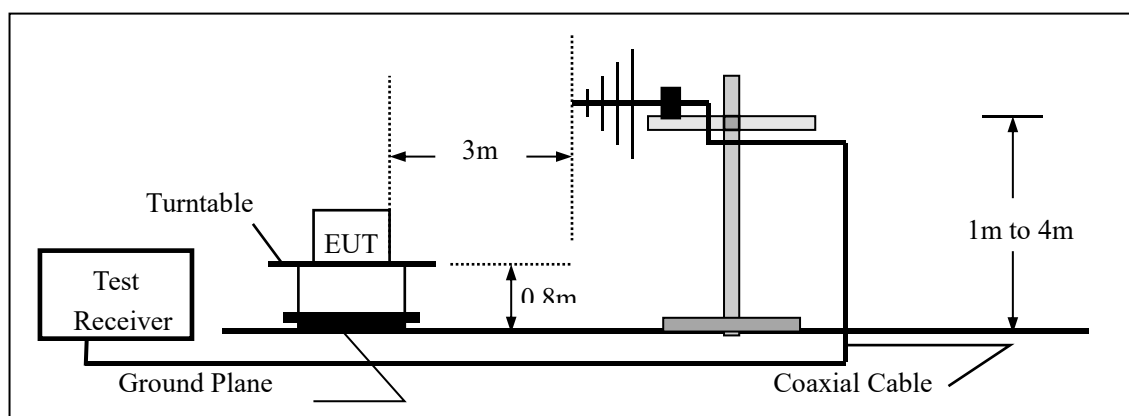



### 6.3. Radiated Emission Limit

The emissions from an intentional radiator shall not exceed the field strength levels specified in the following table 15.209(a):

FCC Part 15.209				
Frequency (MHz)	Field Strength Limitation		Field Strength Limitation Frequency tion at 3m Measurement Dist	
	(uV/m)	Dist	(uV/m)	(dBuV/m)
0.009 – 0.490	2400 / F(KHz)	300m	10000 * 2400/F(KHz)	20log 2400/F(KHz) + 80
0.490 – 1.705	24000 / F(KHz)	30m	100 * 24000/F(KHz)	20log 24000/F(KHz) + 40
1.705 – 30.00	30	30m	100* 30	20log 30 + 40
30.0 – 88.0	100	3m	100	20log 100
88.0 – 216.0	150	3m	150	20log 150
216.0 – 960.0	200	3m	200	20log 200
Above 960.0	500	3m	500	20log 500

### 15.205 Restricted bands of operation

MHz	MHz	MHz	GHz
0.090 - 0.110	16.42 - 16.423	399.9 - 410	4.5 - 5.15
<sup>1</sup> 0.495 - 0.505	16.69475 - 16.69525	608 - 614	5.35 - 5.46
2.1735 - 2.1905	16.80425 - 16.80475	960 - 1240	7.25 - 7.75
4.125 - 4.128	25.5 - 25.67	1300 - 1427	8.025 - 8.5
4.17725 - 4.17775	37.5 - 38.25	1435 - 1626.5	9.0 - 9.2
4.20725 - 4.20775	73 - 74.6	1645.5 - 1646.5	9.3 - 9.5
6.215 - 6.218	74.8 - 75.2	1660 - 1710	10.6 - 12.7
6.26775 - 6.26825	108 - 121.94	1718.8 - 1722.2	13.25 - 13.4
6.31175 - 6.31225	123 - 138	2200 - 2300	14.47 - 14.5
8.291 - 8.294	149.9 - 150.05	2310 - 2390	15.35 - 16.2
8.362 - 8.366	156.52475 - 156.52525	2483.5 - 2500	17.7 - 21.4
8.37625 - 8.38675	156.7 - 156.9	2690 - 2900	22.01 - 23.12
8.41425 - 8.41475	162.0125 - 167.17	3260 - 3267	23.6 - 24.0
12.29 - 12.293	167.72 - 173.2	3332 - 3339	31.2 - 31.8
12.51975 - 12.52025	240 - 285	3345.8 - 3358	36.43 - 36.5
12.57675 - 12.57725	322 - 335.4	3600 - 4400	( <sup>2</sup> )

- Remark:
1. Emission level in dBuV/m=20 log (uV/m)
  2. Measurement was performed at an antenna to the closed point of EUT distance of meters.
  3. Only spurious frequency is permitted to locate within the Restricted Bands specified in provision of § 15.205, and the emissions located in restricted bands also comply with 15.209 limit.

### 6.4.Measurement Result

Test Model: GRAVITY CS10

9kHz-150kHz:

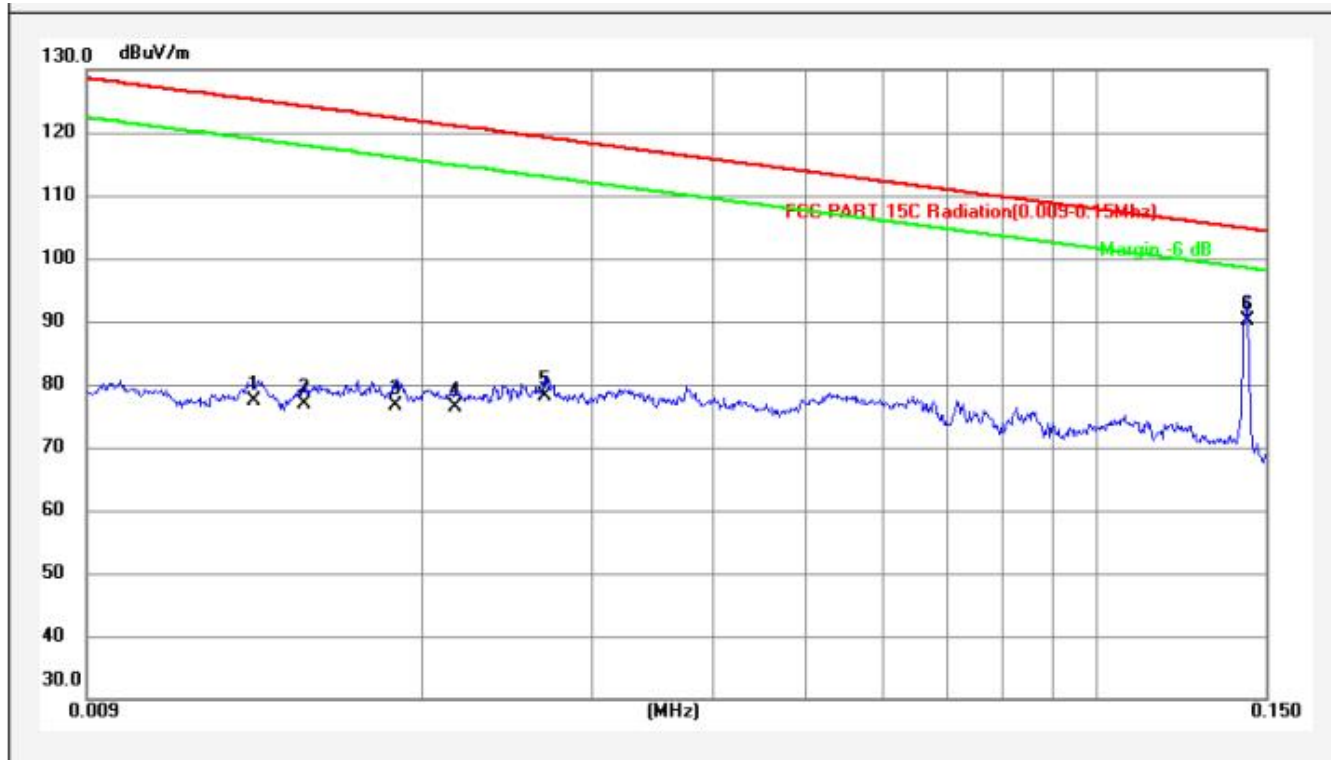

No.	Frequency (MHz)	Factor (dBuV/m)	Reading (dBuV)	Level (dBuV/m)	Limit (dBuV/m)	Margin (dB)	Detector	MK.	Remark
1	0.0134	0.28	77.02	77.30	124.88	-47.58	QP		
2	0.0151	0.28	76.62	76.90	123.85	-46.95	QP		
3	0.0188	0.29	76.41	76.70	121.96	-45.26	QP		
4	0.0217	0.29	76.21	76.50	120.73	-44.23	QP		
5	0.0268	0.29	77.81	78.10	118.91	-40.81	QP		
6	0.1433	0.37	89.73	90.10	104.47	-14.37	QP	*	

150kHz-30MHz:

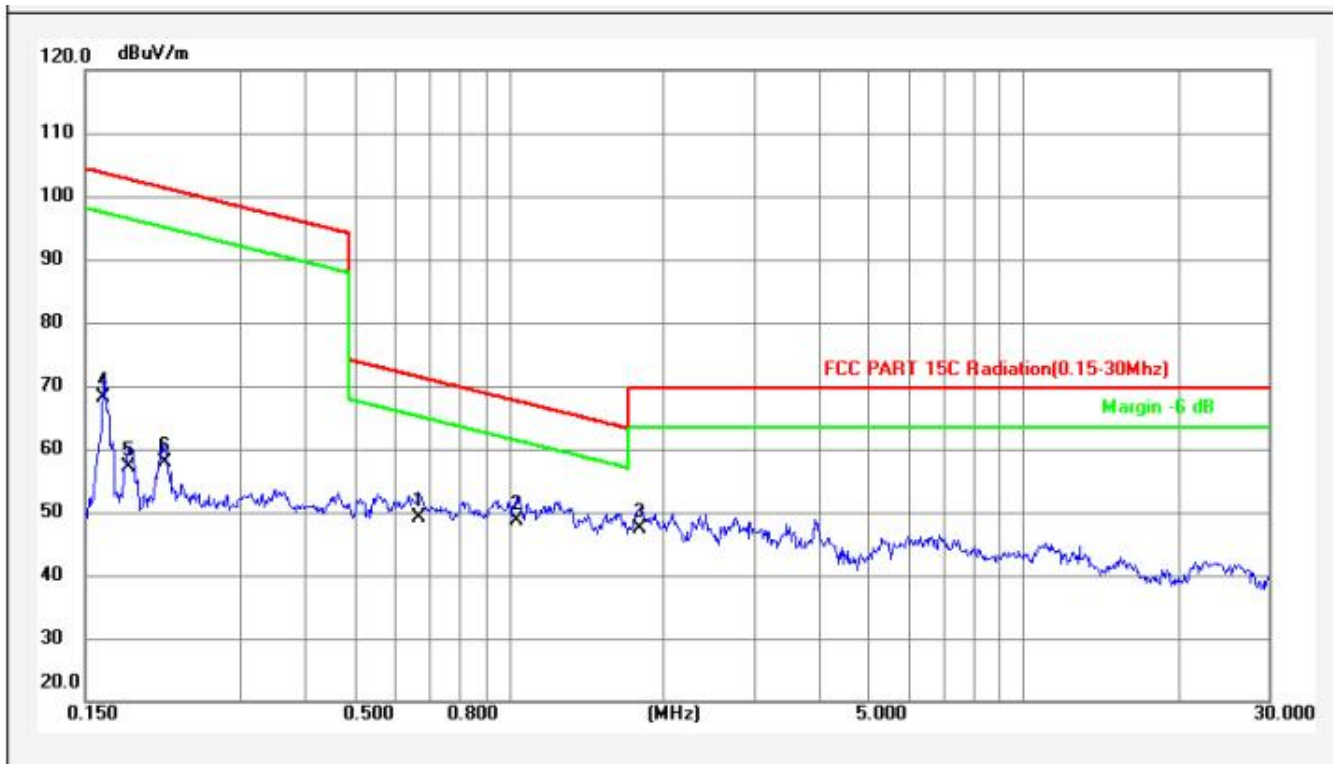

No.	Frequency (MHz)	Factor (dBuV/m)	Reading (dBuV)	Level (dBuV/m)	Limit (dBuV/m)	Margin (dB)	Detector	MK.	Remark
1	0.6683	0.60	48.60	49.20	71.10	-21.90	QP		
2	1.0319	0.68	48.02	48.70	67.33	-18.63	QP	*	
3	1.7903	0.69	46.81	47.50	69.50	-22.00	QP		
4	0.1621	0.38	67.72	68.10	103.41	-35.31	QP		
5	0.1814	0.39	56.81	57.20	102.43	-45.23	QP		
6	0.2139	0.41	57.59	58.00	101.00	-43.00	QP		

30MHz-1GHz:

M/N	:	GRAVITY CS10				
Test Mode	:	FSK				
Test Phase	:	Vertical				
Test Voltage	:	AC 120V/60Hz				
Temperature (°C):	24.8	Relative Humidity (%):	58	Atmospheric Pressure(kPa):	101.4	

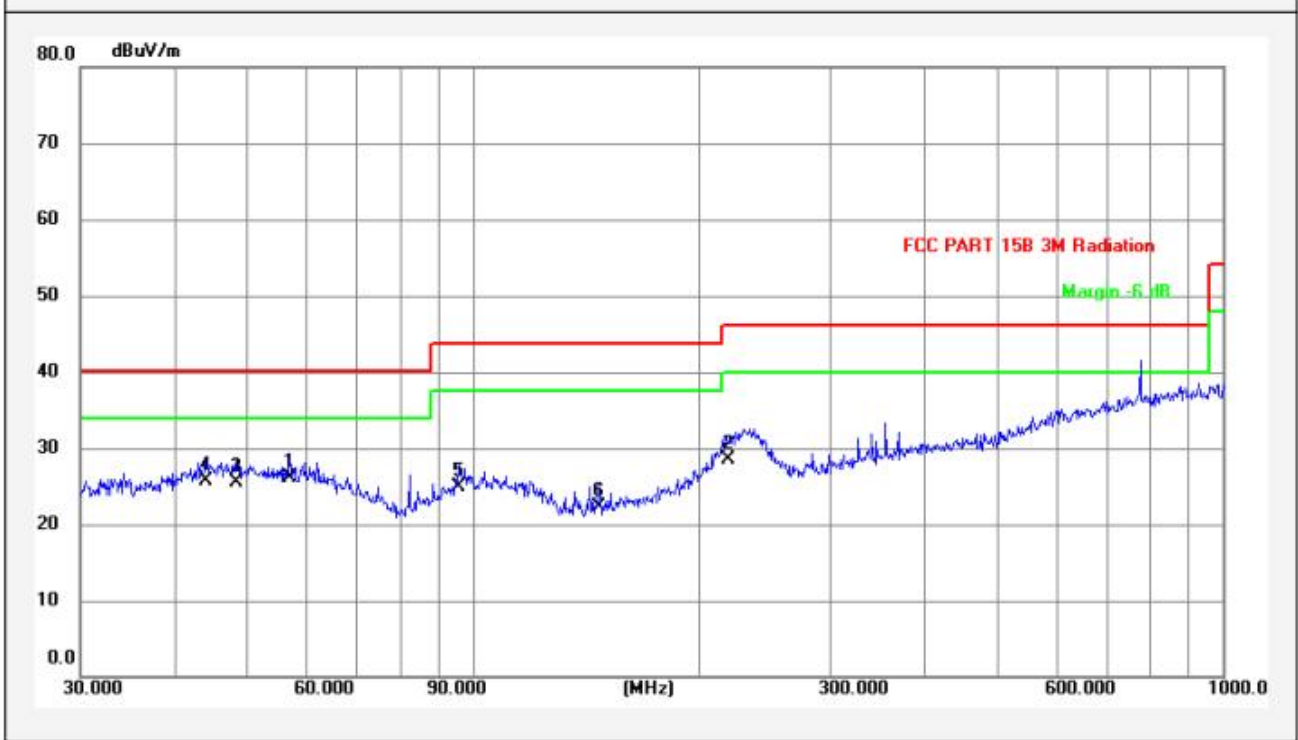

No.	Frequency (MHz)	Factor (dBuV/m)	Reading (dBuV)	Level (dBuV/m)	Limit (dBuV/m)	Margin (dB)	Detector	MK.	Remark
1	56.9912	13.72	12.38	26.10	40.00	-13.90	QP	*	
2	218.3085	13.27	15.23	28.50	46.00	-17.50	QP		
3	48.3316	14.30	11.20	25.50	40.00	-14.50	QP		
4	44.1202	14.21	11.59	25.80	40.00	-14.20	QP		
5	95.7622	11.82	13.08	24.90	43.50	-18.60	QP		
6	147.4036	9.23	13.17	22.40	43.50	-21.10	QP		

Note: Level=Reading+Factor.  
Margin=Level-Limit.

M/N	:	GRAVITY CS10					
Test Mode	:	FSK					
Test Phase	:	Horizontal					
Test Voltage	:	AC 120V/60Hz					
Temperature (°C):	24.5	Relative Humidity (%):	58	Atmospheric Pressure(kPa):	101.4		

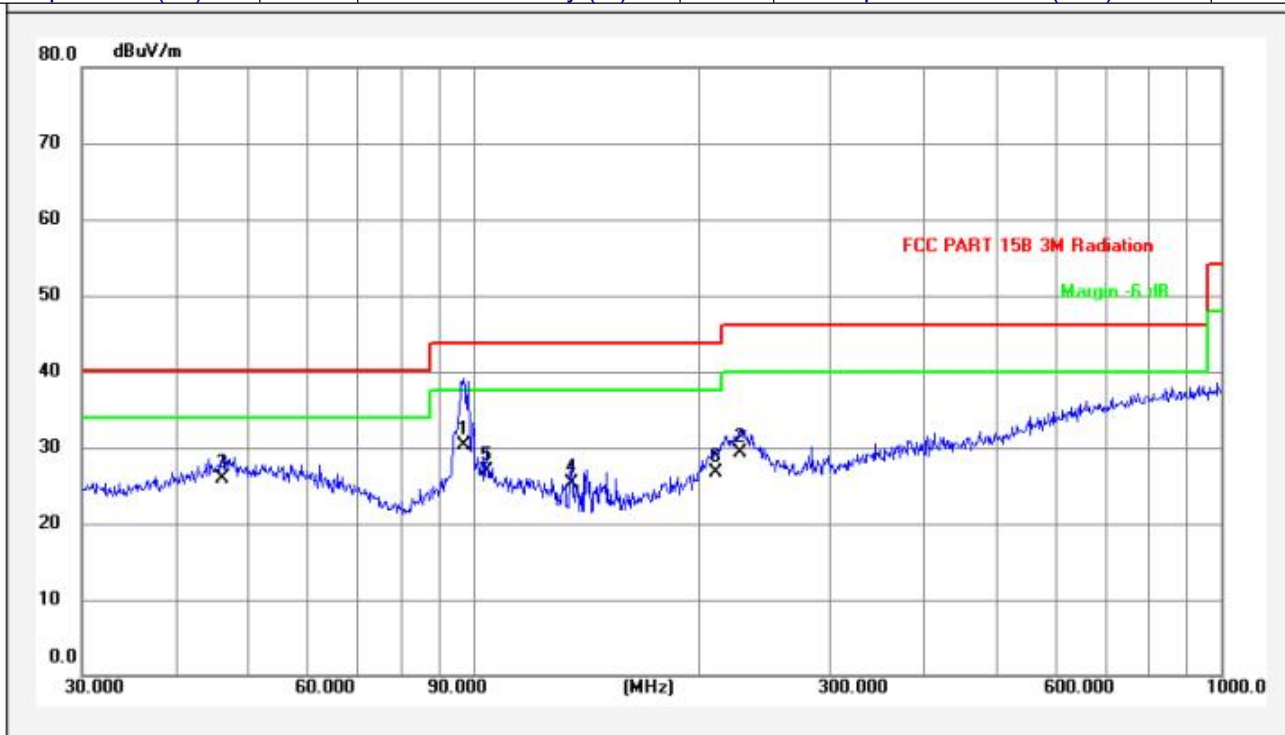

No.	Frequency (MHz)	Factor (dBuV/m)	Reading (dBuV)	Level (dBuV/m)	Limit (dBuV/m)	Margin (dB)	Detector	MK.	Remark
1	97.1148	12.05	18.25	30.30	43.50	-13.20	QP	*	
2	227.6906	13.45	15.85	29.30	46.00	-16.70	QP		
3	46.1779	14.42	11.48	25.90	40.00	-14.10	QP		
4	135.5061	9.40	16.00	25.40	43.50	-18.10	QP		
5	104.1701	12.35	14.65	27.00	43.50	-16.50	QP		
6	211.5264	13.08	13.72	26.80	43.50	-16.70	QP		

Note: Level=Reading+Factor.  
Margin=Level-Limit.

M/N	:	GRAVITY CS10			
Test Mode	:	Charging			
Test Phase	:	Vertical			
Test Voltage	:	AC 120V/60Hz			
Temperature (°C):	24.8	Relative Humidity (%):	58	Atmospheric Pressure(kPa):	101.4

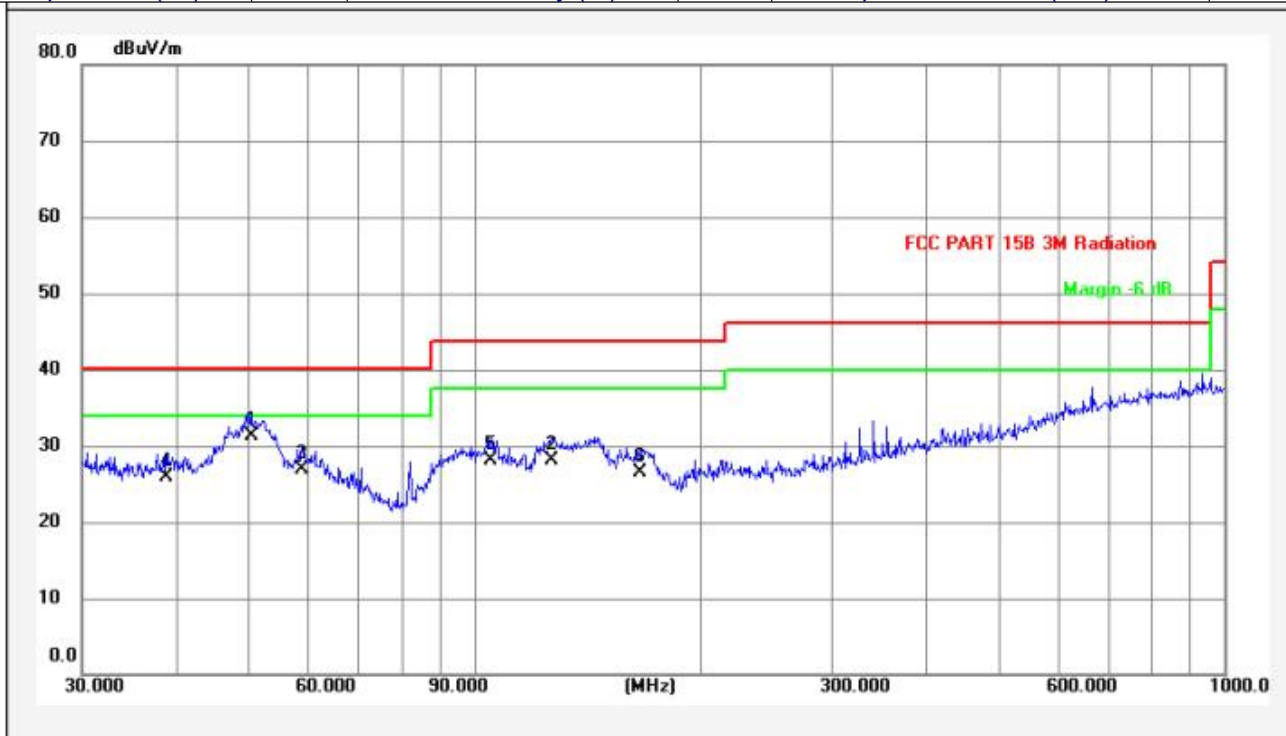

No.	Frequency (MHz)	Factor (dBuV/m)	Reading (dBuV)	Level (dBuV/m)	Limit (dBuV/m)	Margin (dB)	Detector	MK.	Remark
1	50.4089	14.18	17.12	31.30	40.00	-8.70	QP	*	
2	126.7723	10.54	17.56	28.10	43.50	-15.40	QP		
3	58.8185	13.59	13.41	27.00	40.00	-13.00	QP		
4	38.8877	12.69	13.21	25.90	40.00	-14.10	QP		
5	105.2716	12.30	15.90	28.20	43.50	-15.30	QP		
6	166.6512	10.31	16.29	26.60	43.50	-16.90	QP		

Note: Level=Reading+Factor.  
Margin=Level-Limit.

M/N	:	GRAVITY CS10				
Test Mode	:	Charging				
Test Phase	:	Horizontal				
Test Voltage	:	AC 120V/60Hz				
Temperature (°C):	24.5	Relative Humidity (%):	58	Atmospheric Pressure(kPa):	101.4	

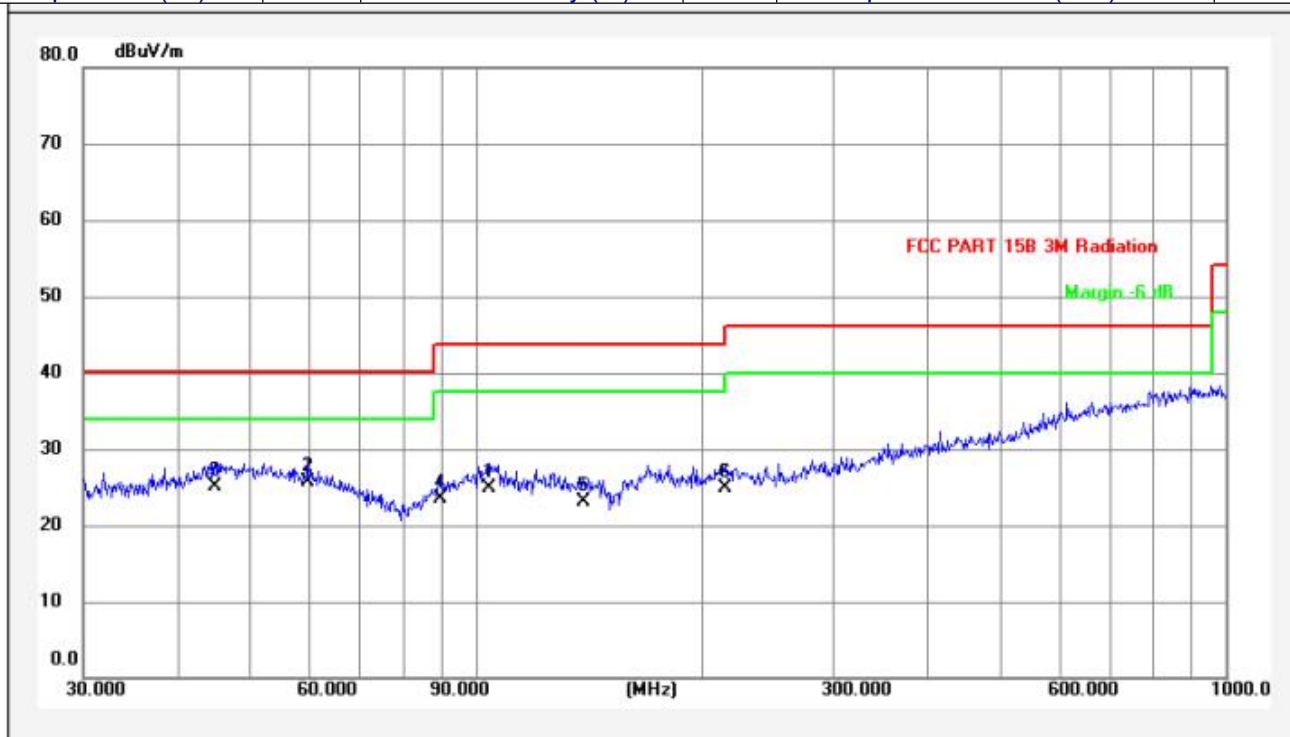

No.	Frequency (MHz)	Factor (dBuV/m)	Reading (dBuV)	Level (dBuV/m)	Limit (dBuV/m)	Margin (dB)	Detector	MK.	Remark
1	103.8055	12.37	12.63	25.00	43.50	-18.50	QP		
2	59.6493	13.54	12.16	25.70	40.00	-14.30	QP	*	
3	44.9004	14.46	10.74	25.20	40.00	-14.80	QP		
4	89.5899	10.76	12.84	23.60	43.50	-19.90	QP		
5	139.3611	8.99	14.11	23.10	43.50	-20.40	QP		
6	215.2677	13.19	11.71	24.90	43.50	-18.60	QP		

Note: Level=Reading+Factor.  
Margin=Level-Limit.

**Test Model: GRAVITY CS5**

9kHz-150kHz:

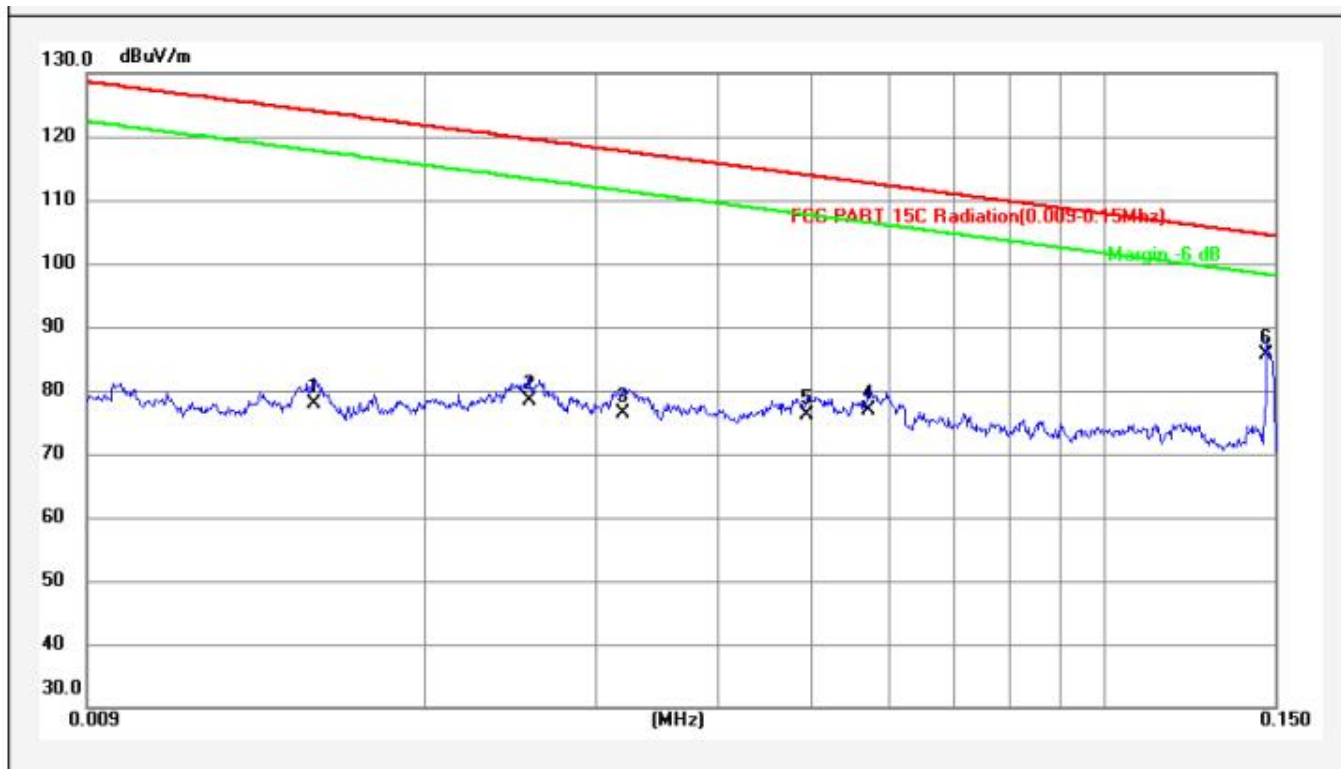

No.	Frequency (MHz)	Factor (dBuV/m)	Reading (dBuV)	Level (dBuV/m)	Limit (dBuV/m)	Margin (dB)	Detector	MK.	Remark
1	0.0154	0.29	77.61	77.90	123.68	-45.78	QP		
2	0.0256	0.29	78.21	78.50	119.30	-40.80	QP		
3	0.0320	0.30	76.20	76.50	117.38	-40.88	QP		
4	0.0572	0.32	76.68	77.00	112.38	-35.38	QP		
5	0.0495	0.31	75.89	76.20	113.63	-37.43	QP		
6	0.1469	0.37	85.23	85.60	104.26	-18.66	QP	*	



150kHz-30MHz:

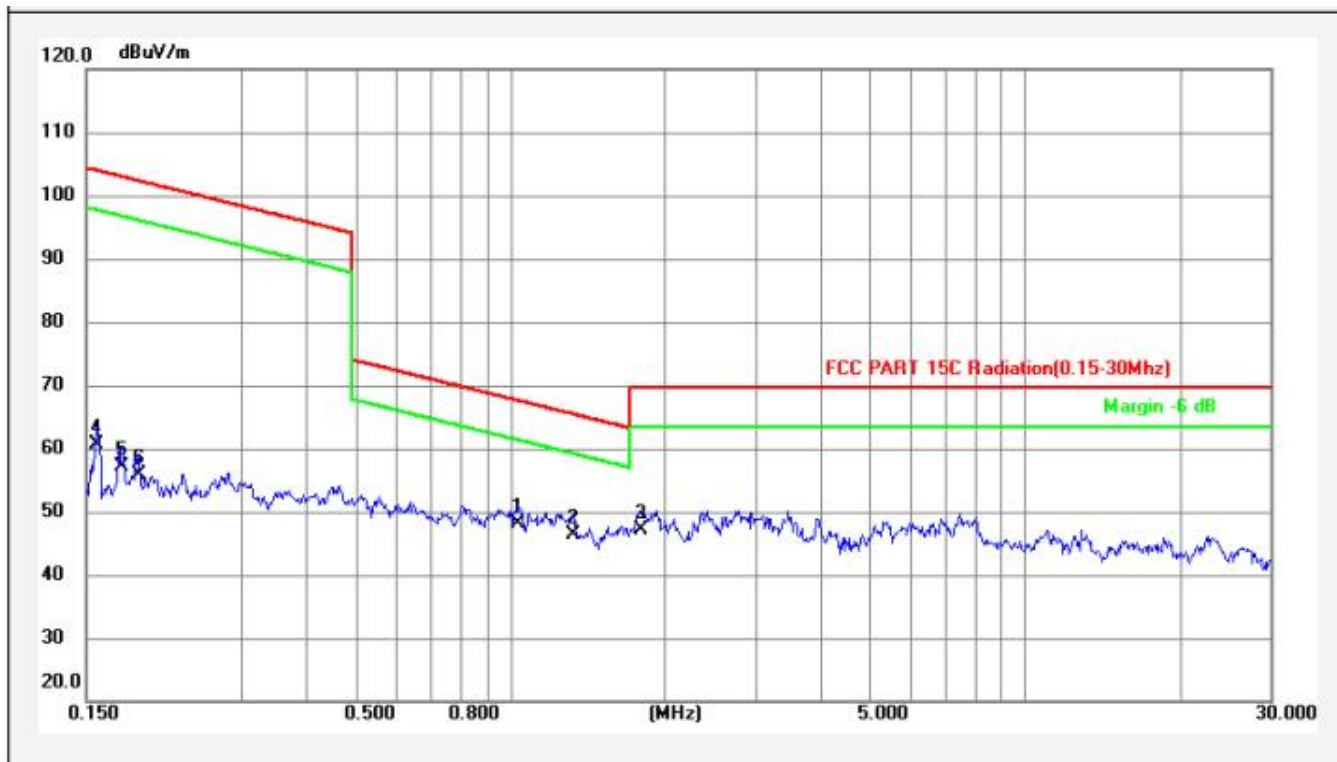

No.	Frequency (MHz)	Factor (dBuV/m)	Reading (dBuV)	Level (dBuV/m)	Limit (dBuV/m)	Margin (dB)	Detector	MK.	Remark
1	1.0319	0.68	47.52	48.20	67.33	-19.13	QP		
2	1.3237	0.69	45.81	46.50	65.16	-18.66	QP	*	
3	1.7903	0.69	46.41	47.10	69.50	-22.40	QP		
4	0.1564	0.38	60.22	60.60	103.72	-43.12	QP		
5	0.1758	0.39	56.71	57.10	102.70	-45.60	QP		
6	0.1892	0.40	55.60	56.00	102.06	-46.06	QP		

30MHz-1GHz:

M/N	:	GRAVITY CS5			
Test Mode	:	FSK			
Test Phase	:	Vertical			
Test Voltage	:	AC 120V/60Hz			
Temperature (°C):	24.8	Relative Humidity (%):	58	Atmospheric Pressure(kPa):	101.4

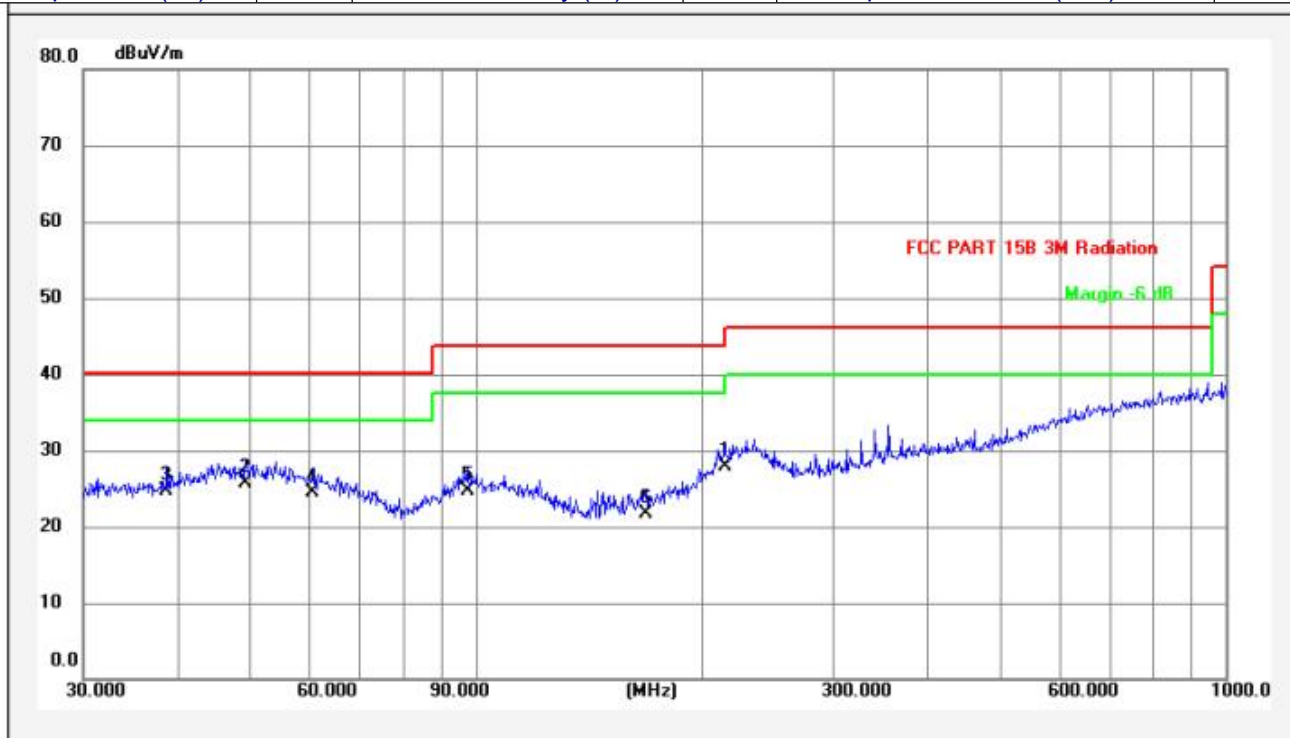

No.	Frequency (MHz)	Factor (dBuV/m)	Reading (dBuV)	Level (dBuV/m)	Limit (dBuV/m)	Margin (dB)	Detector	MK.	Remark
1	214.5143	13.17	14.73	27.90	43.50	-15.60	QP		
2	49.3594	14.25	11.55	25.80	40.00	-14.20	QP	*	
3	38.7517	12.67	12.13	24.80	40.00	-15.20	QP		
4	60.7043	13.36	11.24	24.60	40.00	-15.40	QP		
5	97.4559	12.10	12.70	24.80	43.50	-18.70	QP		
6	168.4137	10.40	11.40	21.80	43.50	-21.70	QP		

Note: Level=Reading+Factor.  
Margin=Level-Limit.

M/N	:	GRAVITY CS5				
Test Mode	:	FSK				
Test Phase	:	Horizontal				
Test Voltage	:	AC 120V/60Hz				
Temperature (°C):	24.5	Relative Humidity (%):	58	Atmospheric Pressure(kPa):	101.4	

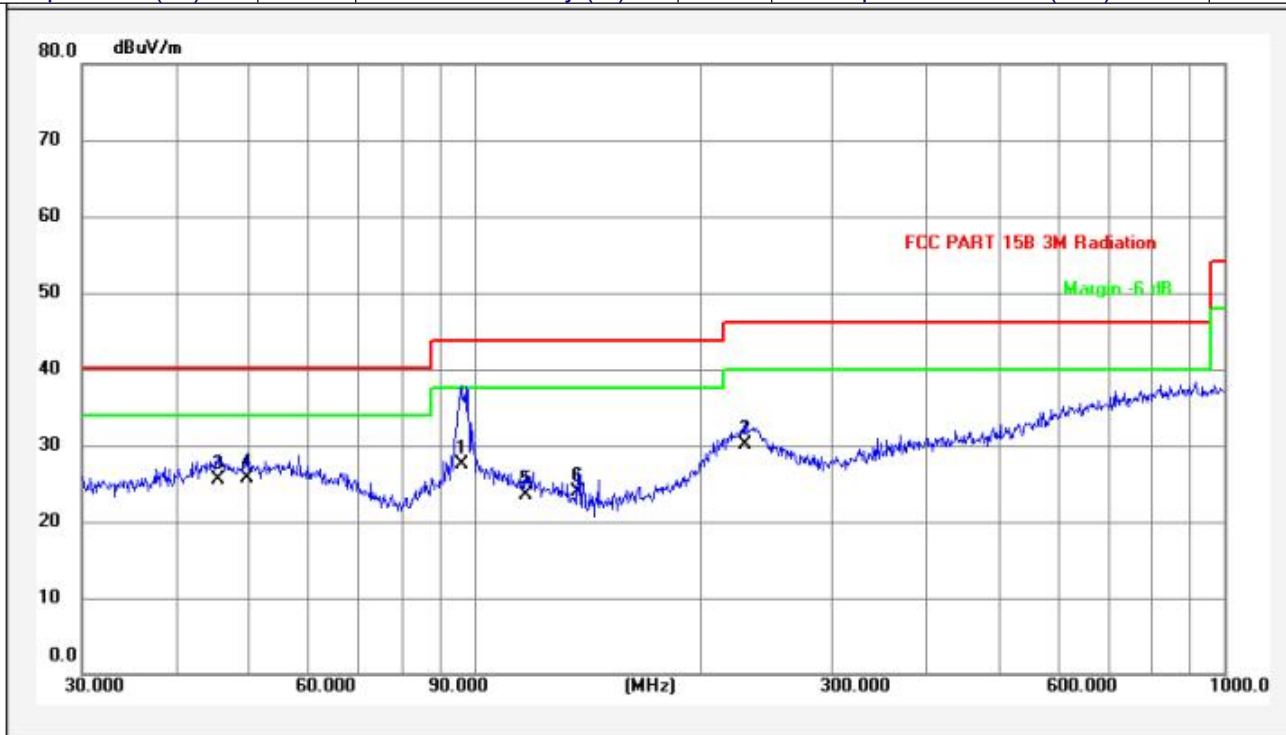

No.	Frequency (MHz)	Factor (dBuV/m)	Reading (dBuV)	Level (dBuV/m)	Limit (dBuV/m)	Margin (dB)	Detector	MK.	Remark
1	96.0986	11.88	15.62	27.50	43.50	-16.00	QP		
2	229.2931	13.44	16.76	30.20	46.00	-15.80	QP		
3	45.5348	14.46	11.14	25.60	40.00	-14.40	QP		
4	49.8814	14.22	11.48	25.70	40.00	-14.30	QP	*	
5	116.9494	11.81	11.79	23.60	43.50	-19.90	QP		
6	137.4202	9.19	14.81	24.00	43.50	-19.50	QP		

Note: Level=Reading+Factor.  
Margin=Level-Limit.

M/N	:	GRAVITY CS5			
Test Mode	:	Charging			
Test Phase	:	Vertical			
Test Voltage	:	AC 120V/60Hz			
Temperature (°C):	24.8	Relative Humidity (%):	58	Atmospheric Pressure(kPa):	101.4

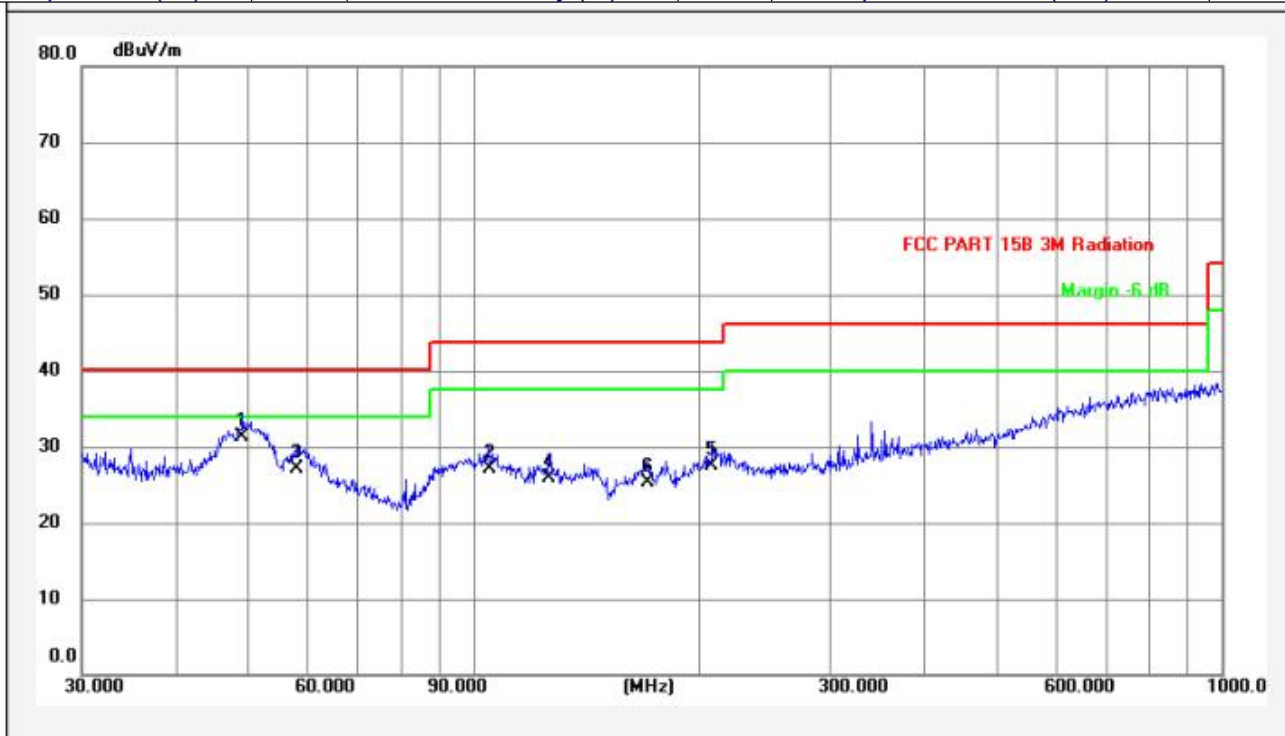

No.	Frequency (MHz)	Factor (dBuV/m)	Reading (dBuV)	Level (dBuV/m)	Limit (dBuV/m)	Margin (dB)	Detector	MK.	Remark
1	49.1865	14.26	17.04	31.30	40.00	-8.70	QP	*	
2	104.9033	12.32	14.88	27.20	43.50	-16.30	QP		
3	58.2029	13.63	13.47	27.10	40.00	-12.90	QP		
4	126.3285	10.61	15.29	25.90	43.50	-17.60	QP		
5	208.5801	13.00	14.50	27.50	43.50	-16.00	QP		
6	170.7926	10.54	14.86	25.40	43.50	-18.10	QP		

Note: Level=Reading+Factor.  
Margin=Level-Limit.

M/N	:	GRAVITY CS5					
Test Mode	:	Charging					
Test Phase	:	Horizontal					
Test Voltage	:	AC 120V/60Hz					
Temperature (°C):	24.5	Relative Humidity (%):	58	Atmospheric Pressure(kPa):	101.4		

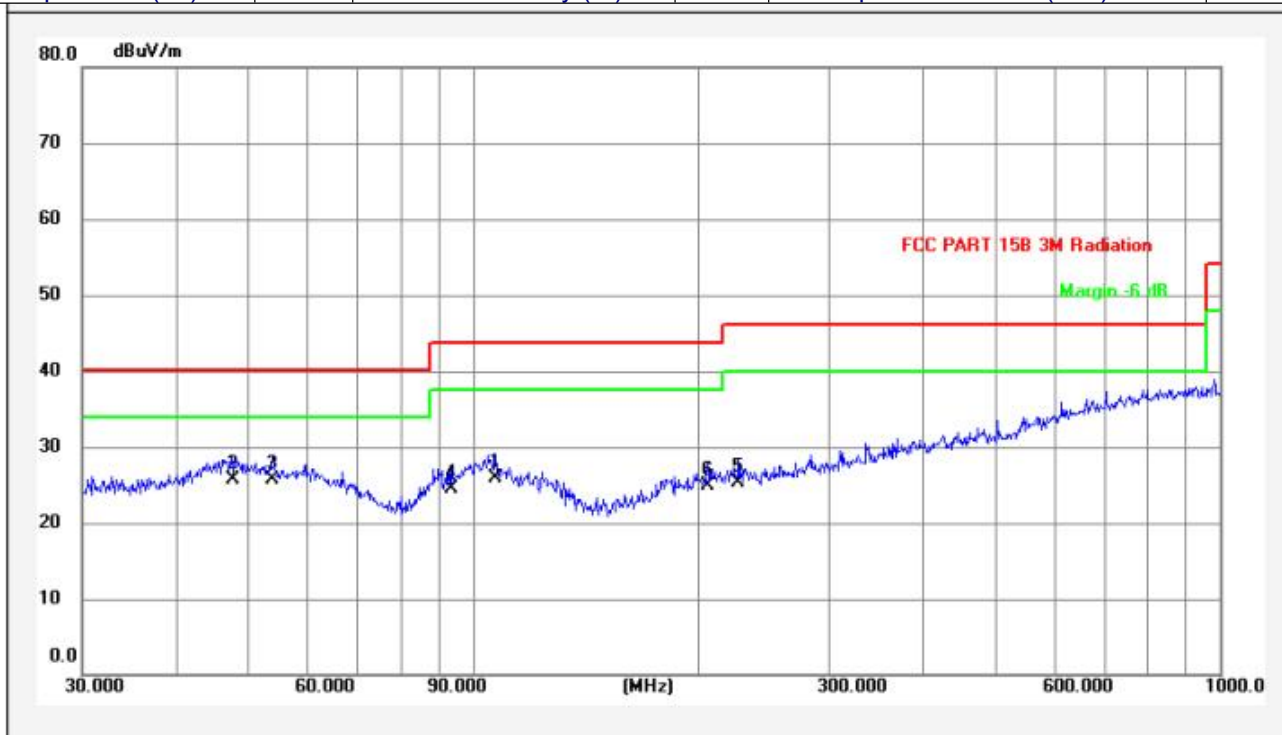

No.	Frequency (MHz)	Factor (dBuV/m)	Reading (dBuV)	Level (dBuV/m)	Limit (dBuV/m)	Margin (dB)	Detector	MK.	Remark
1	107.1337	12.23	13.77	26.00	43.50	-17.50	QP		
2	47.4918	14.35	11.45	25.80	40.00	-14.20	QP	*	
3	53.8817	13.94	11.76	25.70	40.00	-14.30	QP		
4	93.4402	11.43	13.07	24.50	43.50	-19.00	QP		
5	226.8936	13.45	11.85	25.30	46.00	-20.70	QP		
6	206.3975	12.93	11.97	24.90	43.50	-18.60	QP		

Note: Level=Reading+Factor.  
Margin=Level-Limit.

## 7. ANTENNA APPLICATION

### 7.1. Antenna Requirement

Standard	Requirement
FCC CRF Part 15.203	<p>An intentional radiator shall be designed to ensure that no antenna other than that furnished by the responsible party shall be used with the device. The use of a permanently attached antenna or of an antenna that uses a unique coupling to the intentional radiator shall be considered sufficient to comply with the provisions of this section. The manufacturer may design the unit so that a broken antenna can be replaced by the user, but the use of a standard antenna jack or electrical connector is prohibited. This requirement does not apply to carrier current devices or to devices operated under the provisions of §15.211, §15.213, §15.217, §15.219, or §15.221. Further, this requirement does not apply to intentional radiators that must be professionally installed, such as perimeter protection systems and some field disturbance sensors, or to other intentional radiators which, in accordance with §15.31(d), must be measured at the installation site. However, the installer shall be responsible for ensuring that the proper antenna is employed so that the limits in this part are not exceeded.</p>

For intentional device, according to FCC 47 CFR Section 15.203, an intentional radiator shall be designed to ensure that no antenna other than that furnished by the responsible party shall be used with the device. And according to FCC 47 CFR Section 15.247 (b), if transmitting antennas of directional gain greater than 6dBi are used, the power shall be reduced by the amount in dB that the directional gain of the antenna exceeds 6dBi.

### 7.2. Result

**PASS.**

Note:

- Antenna use a permanently attached antenna which is not replaceable.
- Using the unique antenna connector with external fpc antenna.
- Not using a standard antenna jack or electrical connector for antenna replacement
- The antenna has to be professionally installed (please provide method of installation)

which in accordance to section 15.203, please refer to the internal photos.

-----The end-----