

## TEST REPORT

**Report Number: 102599840MPK-001**

**Project Number: G102599840**

**June 21, 2016**

**Testing performed on  
Tile Slim - Bluetooth Location Finder**

**Model: T2001**

**FCC ID: 2ABXLT2001**

**IC: 11858A-T2001**

**to**

**FCC Part 15 Subpart C (15.247)**

**Industry Canada RSS-247 Issue 1**

**For**

**Tile, Inc.**

Test Performed by:

Intertek

1365 Adams Court

Menlo Park, CA 94025 USA

Test Authorized by:

Tile, Inc.

2121 S. El Camino Real, Suite C-100

San Mateo, CA 94403, USA

Prepared by:

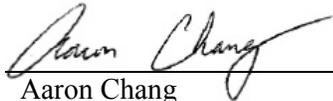
  
Aaron Chang

**Date:** June 21, 2016

Reviewed by:

  
Krishna K Vemuri

**Date:** June 21, 2016

*This report is for the exclusive use of Intertek's Client and is provided pursuant to the agreement between Intertek and its Client. Intertek's responsibility and liability are limited to the terms and conditions of the agreement. Intertek assumes no liability to any party, other than to the Client in accordance with the agreement, for any loss, expense or damage occasioned by the use of this report. Only the Client is authorized to copy or distribute this report and then only in its entirety. Any use of the Intertek name or one of its marks for the sale or advertisement of the tested material, product or service must first be approved in writing by Intertek. The observations and test results in this report are relevant only to the sample tested. This report by itself does not imply that the material, product, or service is or has ever been under an Intertek certification program. This report must not be used to claim product endorsement by A2LA, NIST nor any other agency of the U.S. Government.*

## Report No. 102599840MPK-001

<b>Equipment Under Test:</b>	Tile Slim - Bluetooth Location Finder
<b>Trade Name:</b>	Tile, Inc.
<b>Model Number:</b>	T2001
<b>Serial Number:</b>	MPK1606021529-003
<b>Applicant:</b>	Tile, Inc.
<b>Contact:</b>	Sandor Kiss
<b>Address:</b>	Tile, Inc. 2121 S. El Camino Real, Suite C-100 San Mateo, CA 94403
<b>Country:</b>	USA
<b>Tel. Number:</b>	(415) 902-9629
<b>Email:</b>	Sandor@thetileapp.com
<b>Applicable Regulation:</b>	FCC Part 15 Subpart C (15.247) Industry Canada RSS-247 Issue 1
<b>Date of Test:</b>	June 3 - 7, 2016

*We attest to the accuracy of this report:*

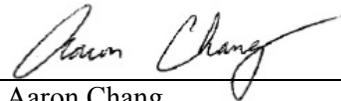

Aaron Chang  
Project Engineer



Krishna K Vemuri  
Engineering Team Lead

## TABLE OF CONTENTS

<b>1.0</b>	<b>Summary of Tests .....</b>	<b>5</b>
<b>2.0</b>	<b>General Information.....</b>	<b>6</b>
2.1	Product Description .....	6
2.2	Related Submittal(s) Grants.....	7
2.3	Test Facility .....	7
2.4	Test Methodology.....	7
2.5	Measurement Uncertainty.....	7
<b>3.0</b>	<b>System Test Configuration.....</b>	<b>8</b>
3.1	Support Equipment .....	8
3.2	Block Diagram of Test Setup.....	8
3.3	Justification.....	9
3.4	Software Exercise Program.....	9
3.5	Mode of Operation during Test.....	9
3.5	Modifications Required for Compliance .....	9
3.6	Additions, Deviations and Exclusions from Standards.....	9
<b>4.0</b>	<b>Measurement Results.....</b>	<b>10</b>
4.1	6-dB Bandwidth and Occupied Bandwidth .....	10
4.1.1	Requirement.....	10
4.1.2	Procedure .....	10
4.1.3	Test Result .....	10
4.2	Maximum Peak Conducted Output Power at Antenna Terminals .....	17
4.2.1	Requirement.....	17
4.2.2	Procedure .....	17
4.3.3	Test Result .....	17
4.3	Maximum Power Spectral Density .....	21
4.3.1	Requirement.....	21
4.3.2	Procedure .....	21
4.3.3	Test Result .....	21
4.4	Unwanted Conducted Emissions .....	25
4.4.1	Requirement.....	25
4.4.2	Procedure .....	25
4.4.3	Test Result .....	25
4.5	Transmitter Radiated Emissions .....	30
4.5.1	Requirement.....	30
4.5.2	Procedure .....	30
4.5.3	Field Strength Calculation .....	31
4.5.4	Antenna-port conducted measurements.....	32
4.5.6	General Procedure for conducted measurements in restricted bands.....	32
4.5.7	Test Results.....	32
4.5.8	Test setup photographs .....	41
<b>5.0</b>	<b>RF Exposure Evaluation .....</b>	<b>43</b>
<b>6.0</b>	<b>List of Test Equipment .....</b>	<b>44</b>



7.0 Document History .....45

## 1.0 Summary of Tests

Test	Reference FCC	Reference Industry Canada	Result
<b>RF Output Power</b>	15.247(b)(3)	RSS-247, 5.4.4	Complies
<b>6 dB Bandwidth</b>	15.247(a)(2)	RSS-247, 5.2.1	Complies
<b>Power Density</b>	15.247(e)	RSS-247, 5.2.2	Complies
<b>Out of Band Antenna Conducted Emission</b>	15.247(d)	RSS-247, 5.5	Complies
<b>Transmitter Radiated Emissions</b>	15.247(d), 15.209, 15.205	RSS-247, 5.5	Complies
<b>AC Line Conducted Emission</b>	15.207	RSS-GEN	Not Applicable*
<b>Antenna Requirement</b>	15.203	RSS-GEN	Complies (Internal Antenna & Unique connector)
<b>RF Exposure</b>	15.247(i), 2.1093(d)	RSS-102	Complies

\*EUT is battery operated. The battery is single use only.

**EUT receive date:** June 3, 2016

**EUT receive condition:** The pre-production version of the EUT was received in good condition with no apparent damage. As declared by the Applicant, it is identical to the production units.

**Test start date:** June 3, 2016

**Test completion date:** June 7, 2016

The test results in this report pertain only to the item tested.

## 2.0 General Information

### 2.1 Product Description

Equipment under Test (EUT) is the Tile Slim - Bluetooth Location Finder, Model T2001. As described by the manufacturer, Tile Slim - Bluetooth Location Finder is intended to be used on a variety of items in order to track them using a smartphone enabled with Bluetooth Low Energy technology. Description of product as it is marketed as “Tile Slim Bluetooth Location Finder -The World's Largest Lost & Found”.

Information about the Bluetooth 4.0 (BLE) radio is presented below:

For more information, refer to the following product specification, declared by the manufacturer.

Information about the 2.4 GHz radio is presented below:

<b>Applicant</b>	Tile, Inc.
<b>Model No.</b>	T2001
<b>FCC Identifier</b>	2ABXLT2001
<b>IC Identifier</b>	11858A-T2001
<b>Type of transmission</b>	Digital Transmission System (DTS)
<b>Rated RF Output</b>	-0.86 dBm (0.82 mW)
<b>Antenna(s) &amp; Gain</b>	PCB antenna, Gain: 0 dBi
<b>Frequency Range</b>	2402 – 2480 MHz
<b>Type of modulation/data rate</b>	GFSK / 1Mbit/s
<b>Number of Channel(s)</b>	40
<b>Applicant Name &amp; Address</b>	Tile, Inc. 2121 S. El Camino Real, Suite C-100 San Mateo, CA 94403, USA

## 2.2 Related Submittal(s) Grants

None.

## 2.3 Test Facility

The test site used to collect the radiated data is site 1 (10-m semi-anechoic chamber). This test facility and site measurement data have been fully placed on file with the FCC, IC and A2LA accredited.

## 2.4 Test Methodology

Antenna conducted measurements were performed according to the FCC documents “Guidance for Performing Compliance Measurement on Digital Transmission Systems (DTS) Operating under §15.247” (KDB 558074 D01 DTS Meas Guidance v03r04 January 7, 2016), and RSS-247, RSS-GEN.

Radiated emissions and AC mains conducted emissions measurements were performed according to the procedures in ANSI C63.10-2013. Radiated tests were performed at an antenna to EUT distance of 3 meters, unless stated otherwise in the "Data Sheet" of this report.

## 2.5 Measurement Uncertainty

Compliance with the limits was based on the results of the measurements and doesn't take into account the measurement uncertainty.

### Estimated Measurement Uncertainty

Measurement	Expanded Uncertainty (k=2)		
	0.15 MHz – 1 GHz	1 GHz – 2.5 GHz	> 2.5 GHz
RF Power and Power Density – antenna conducted	-	0.7 dB	-
Unwanted emissions - antenna conducted	1.1 dB	1.3 dB	1.9 dB
Bandwidth – antenna conducted	-	30 Hz	-
Radiated emissions	4.2 dB	3.4 dB	4.4 dB
AC mains conducted emissions	2.4 dB	-	-

### 3.0 System Test Configuration

#### 3.1 Support Equipment

EUT was tested as a standalone device. No Support equipment is used in test setup.

#### 3.2 Block Diagram of Test Setup

Antenna was removed and co-axial connector with a cable was installed for Conducted Measurements.

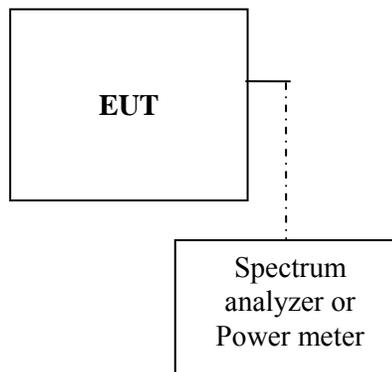

<b>S</b> = Shielded	<b>F</b> = With Ferrite
<b>U</b> = Unshielded	<b>m</b> = Length in Meters

### 3.3 Justification

For radiated emission measurements the EUT is placed on a non-conductive table.

### 3.4 Software Exercise Program

The EUT exercise program used during radiated and conducted testing was provided by Tile, Inc..

### 3.5 Mode of Operation during Test

During transmitter testing, the transmitter was setup to transmit at maximum RF power on low, middle and high frequencies/channels.

### 3.5 Modifications Required for Compliance

Intertek installed no modifications during compliance testing in order to bring the product into compliance.

### 3.6 Additions, Deviations and Exclusions from Standards

No additions, deviations or exclusions from the standard were made.

#### 4.0 Measurement Results

##### 4.1 6-dB Bandwidth and Occupied Bandwidth FCC Rule: 15.247(a)(2); RSS-247 A8.2 and RSS-GEN;

###### 4.1.1 Requirement

The minimum 6-dB bandwidth shall be at least 500 kHz

###### 4.1.2 Procedure

A spectrum analyzer was connected to the antenna port of the transmitter.

For FCC 6dB Channel Bandwidth the Procedure described in the FCC Publication 558074 D01 DTS Meas Guidance v03r04 January 7, 2016 was used to determine the DTS occupied bandwidth. Section 8.1 Option 1 was used.

1. Set RBW = 100 kHz.
2. Set the video bandwidth (VBW)  $\geq 3 \times$  RBW.
3. Detector = Peak.
4. Trace mode = max hold.
5. Sweep = auto couple.
6. Allow the trace to stabilize.
7. Measure the maximum width of the emission that is constrained by the frequencies associated with the two outermost amplitude points (upper and lower frequencies) that are attenuated by 6 dB relative to the maximum level measured in the fundamental emission.

For 99% power bandwidth measurement, the bandwidth was determined by using the built-in 99% occupied bandwidth function of the spectrum analyzer. The resolution bandwidth is set to 1% of the selected span as is without being below 1%. The video bandwidth shall be set to 3 times the resolution bandwidth.

###### 4.1.3 Test Result

Frequency (MHz)	6-dB bandwidth FCC 15.247 & RSS-GEN, MHz	Occupied bandwidth, RSS-GEN, MHz	Plot
2402	0.745	--	1.1
	--	1.077	1.4
2434	0.735	--	1.2
	--	1.077	1.5
2480	0.740	--	1.3
	--	1.077	1.6

<b>Date of Test:</b>	June 6, 2016
<b>Results</b>	<b>Complies</b>

Plot 1. 1

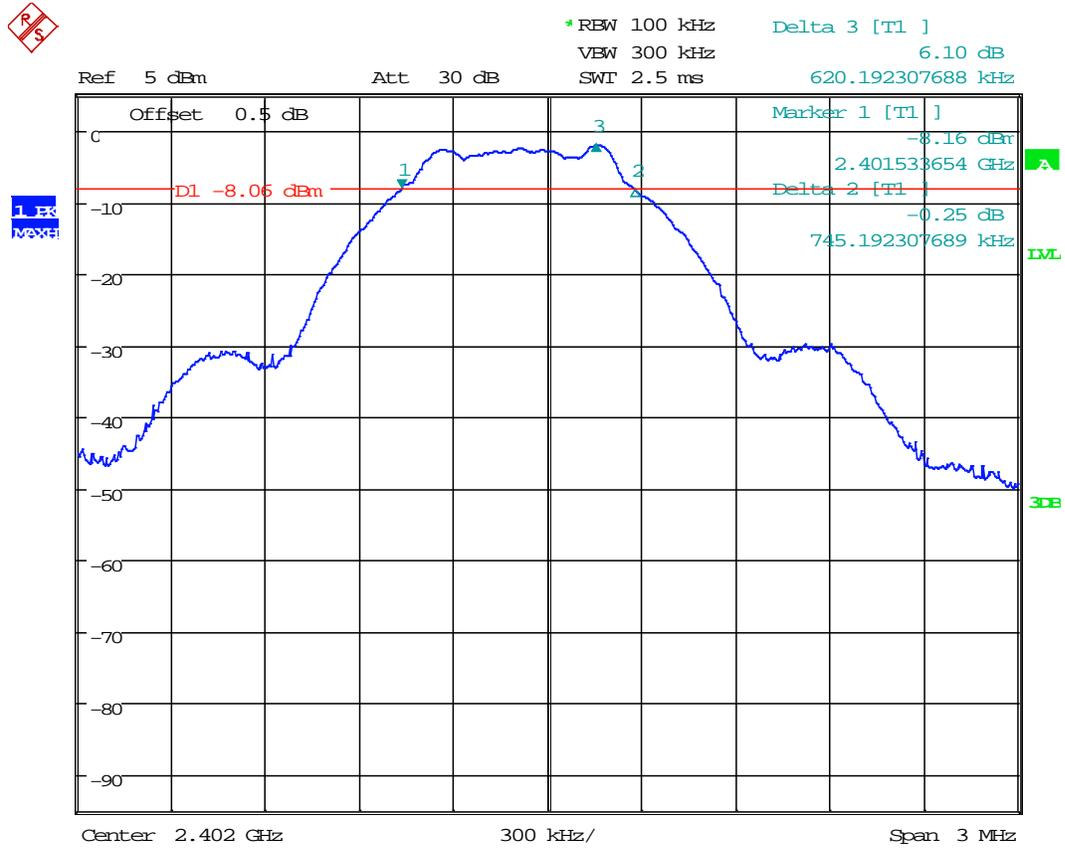

Date: 6.JUN.2016 14:23:18

Plot 1.2

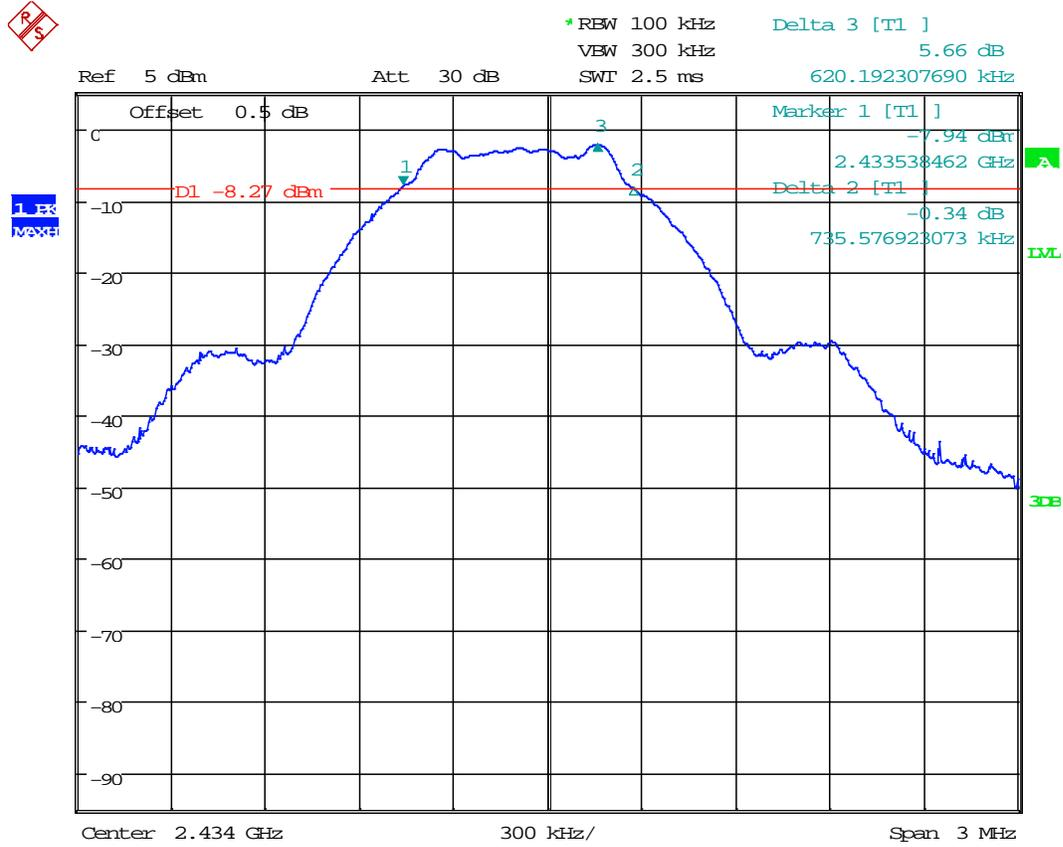

Date: 6.JUN.2016 14:25:07

Plot 1.3

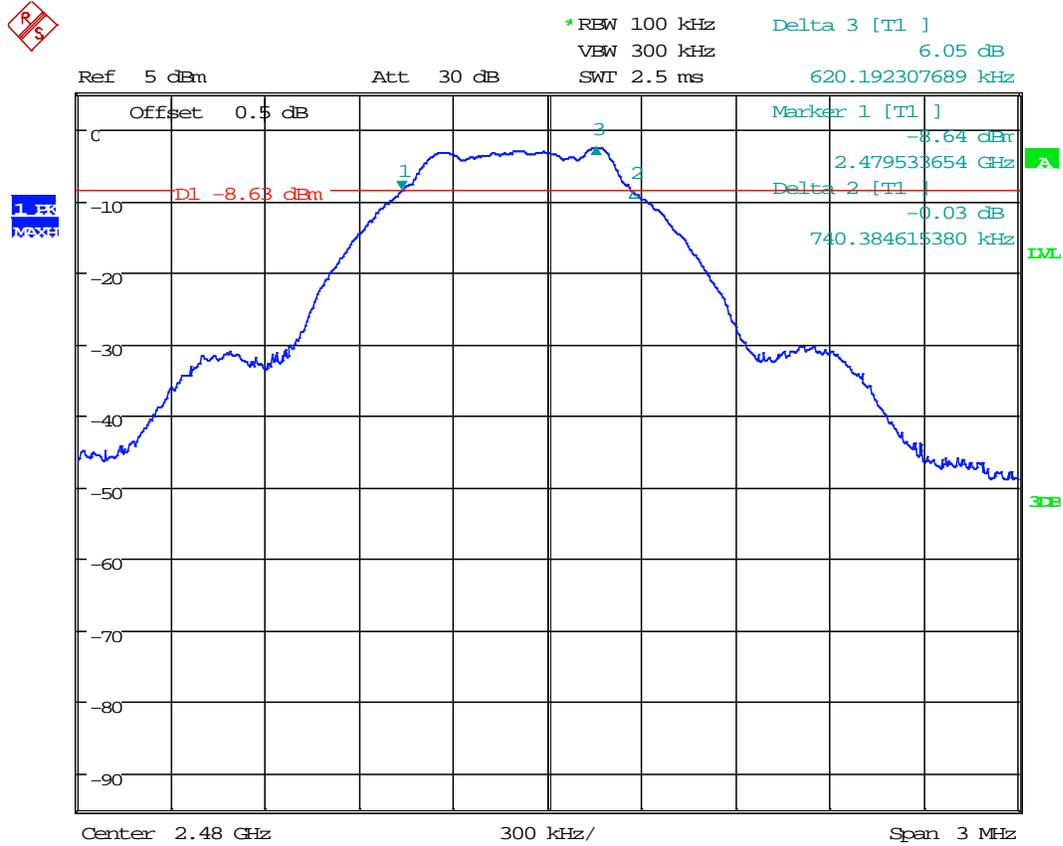

Date: 6.JUN.2016 14:26:31

Plot 1. 4

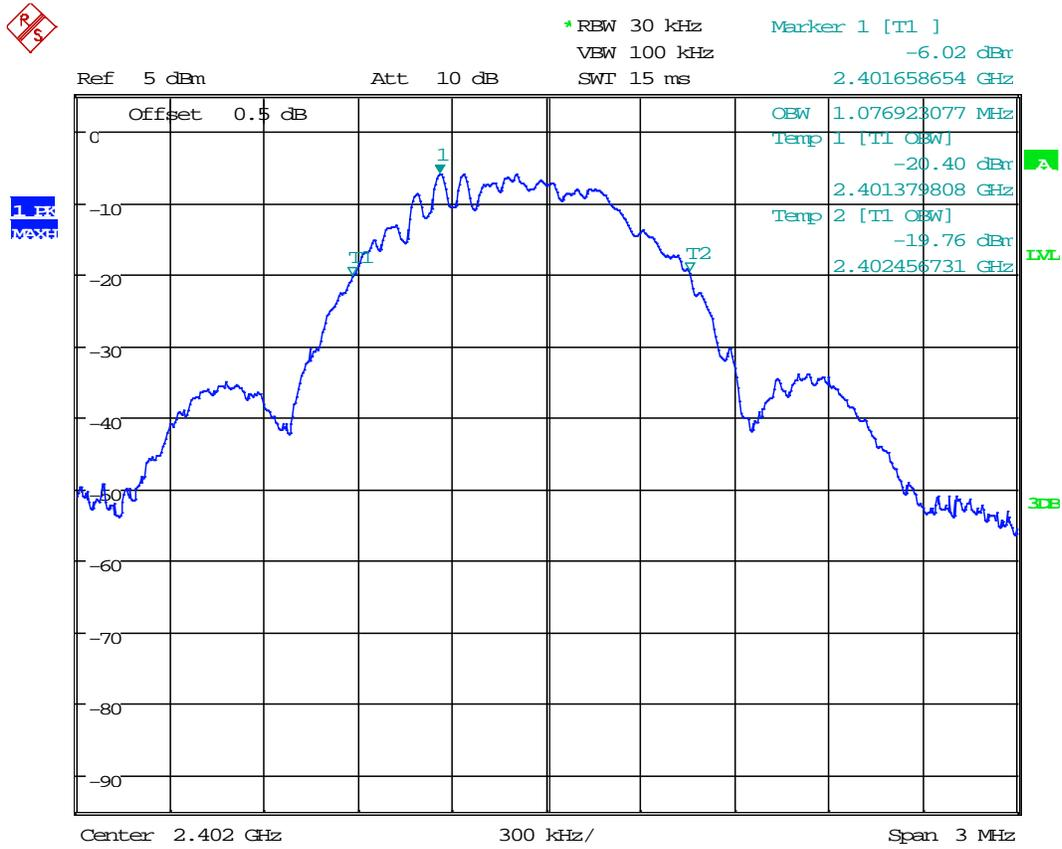

Date: 6.JUN.2016 14:28:34

Plot 1.5

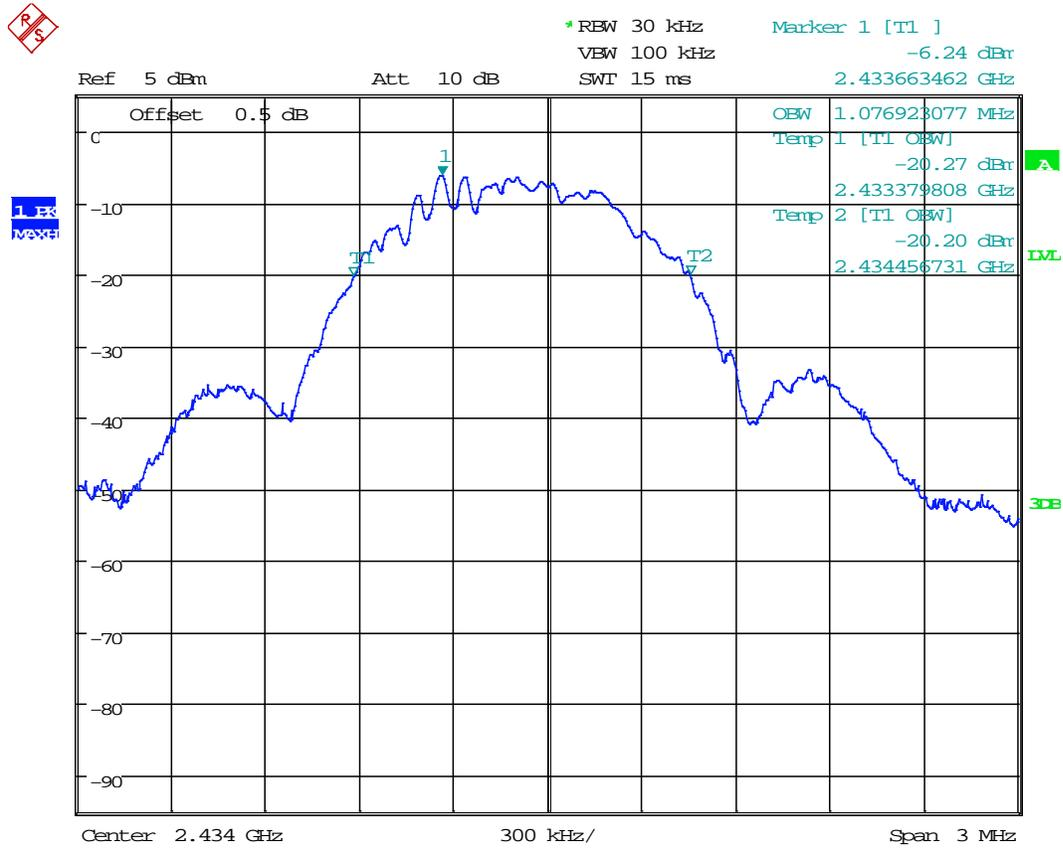

Date: 6.JUN.2016 14:29:22

Plot 1.6

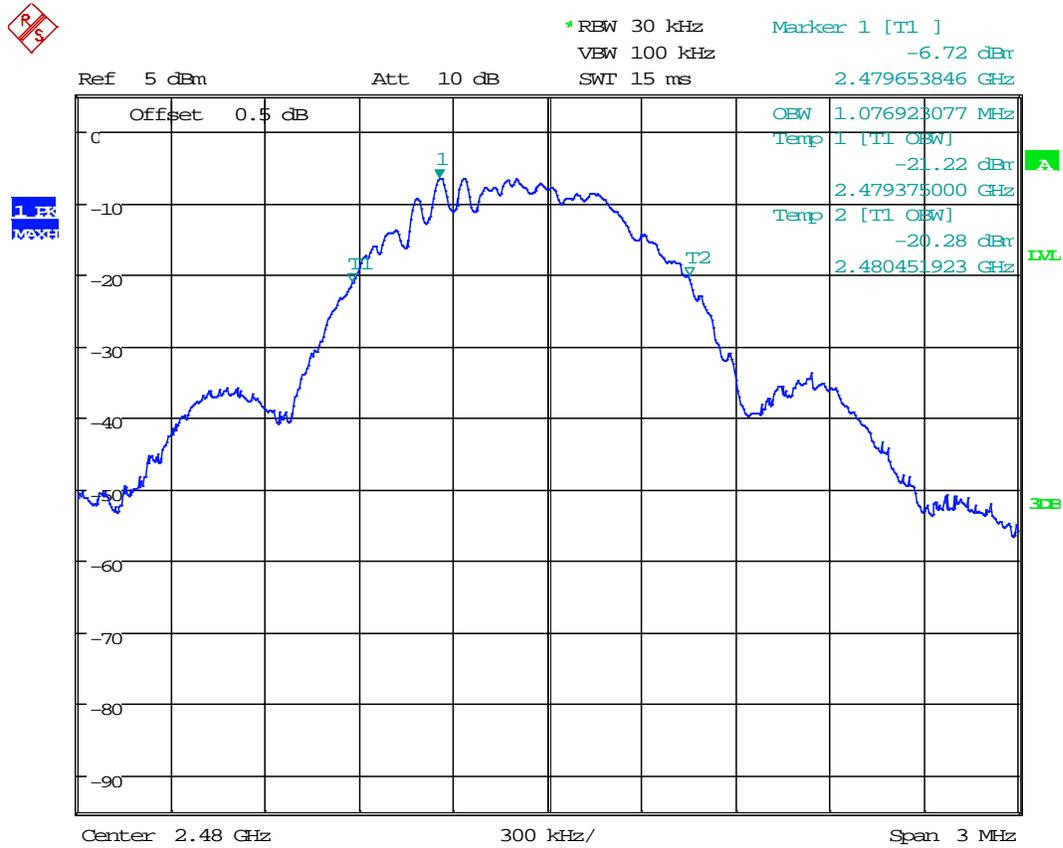

Date: 6.JUN.2016 14:30:04

4.2 Maximum Peak Conducted Output Power at Antenna Terminals  
 FCC Rule: 15.247(b)(3); RSS-247 A8.4;

4.2.1 Requirement

For antennas with gains of 6 dBi or less, maximum allowed transmitter output is 1 watt or 30 dBm. For antennas with gains greater than 6 dBi, transmitter output level must be decreased appropriately, by the amount in dB that the directional gain of the antenna exceeds 6 dBi.

4.2.2 Procedure

The procedure described in FCC Publication 558074 D01 DTS Meas Guidance v03r04 January 7, 2016 was used. Specifically, section 9.1.1 RBW ≥ DTS Bandwidth was utilized as the spectrum analyzer’s resolution bandwidth was greater than the DTS bandwidth.

1. Set the RBW ≥ DTS Bandwidth
2. Set the VBW ≥ 3 x RBW
3. Set the span ≥ 3 x RBW
4. Detector = Peak
5. Sweep time = Auto couple
6. Trace mode = Max Hold
7. Allow trace to fully stabilize
8. Use peak marker function to determine the peak amplitude level.

A spectrum analyzer was connected to the antenna port of the transmitter.

4.3.3 Test Result

Refer to the following plots 2.1 – 2.3 for the test details.

Frequency, MHz	Conducted Power (peak), dBm	Conducted Power (peak), mW	Plot
2402	-0.86	0.820	2.1
2434	-1.06	0.783	2.2
2480	-1.34	0.735	2.3

<b>Date of Test:</b>	June 6, 2016
<b>Results</b>	<b>Complies</b>

Plot 2. 1

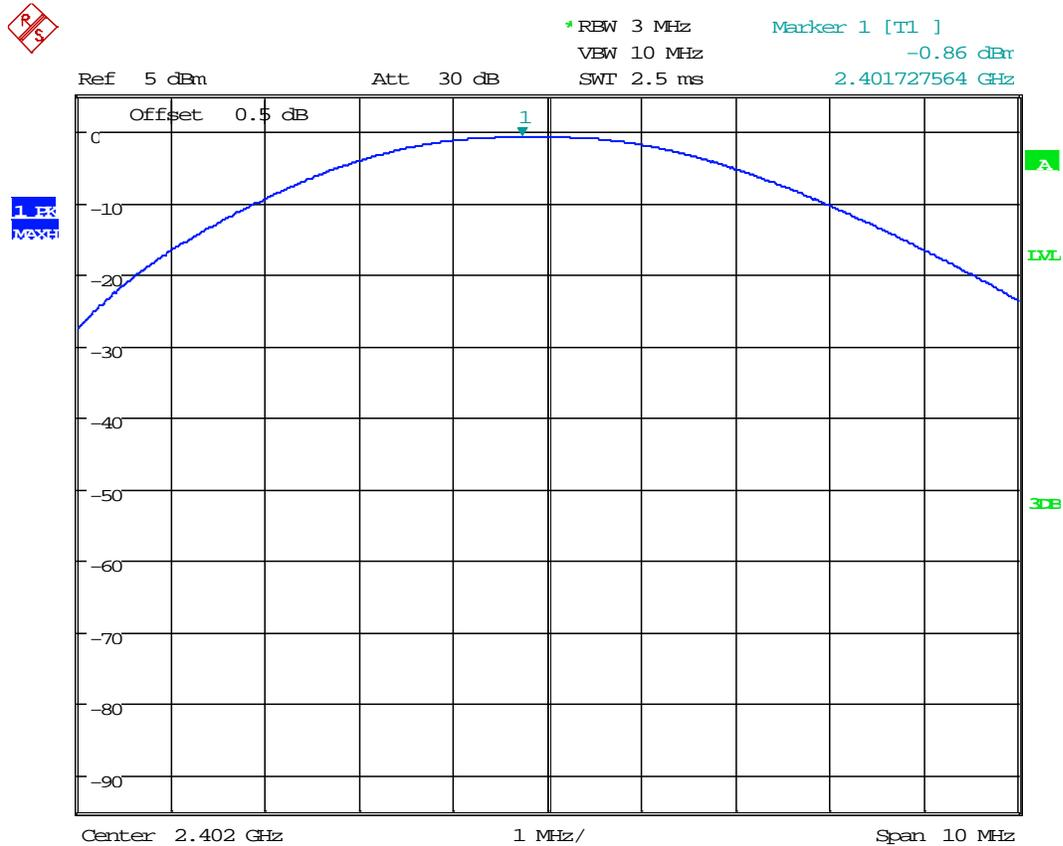

Date: 6.JUN.2016 14:04:15

Plot 2. 2

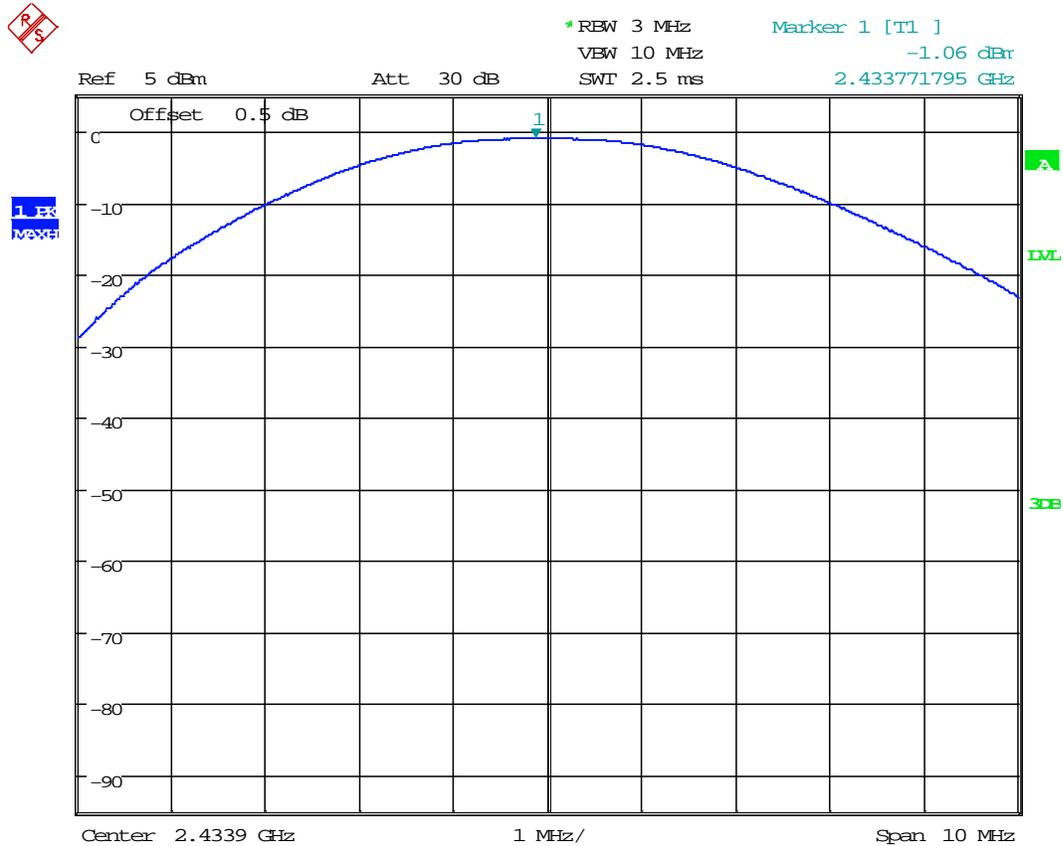

Date: 6.JUN.2016 14:05:39

Plot 2.3

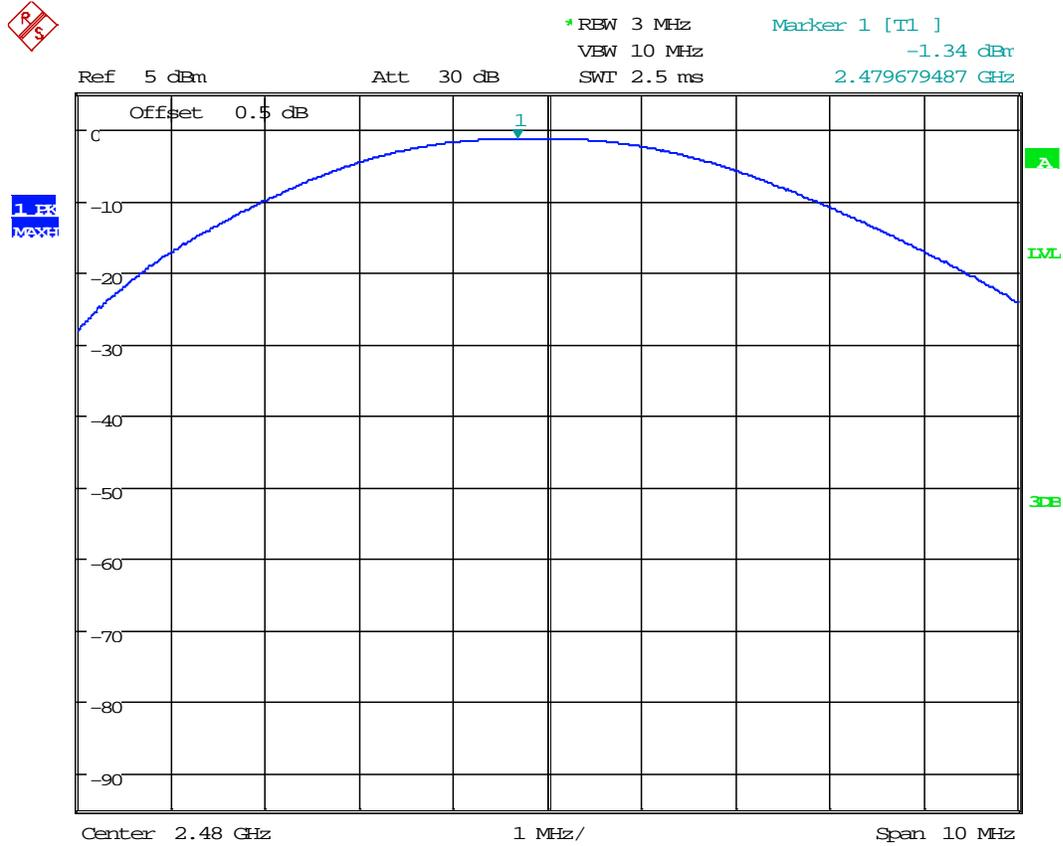

Date: 6.JUN.2016 14:06:07

4.3 Maximum Power Spectral Density  
FCC: 15.247 (e); RSS-247 A8.2b;

4.3.1 Requirement

For digitally modulated systems, the power spectral density conducted from the intentional radiator to the antenna should not be greater than 8 dBm in any 3 kHz band during any time interval of continuous transmission.

4.3.2 Procedure

A spectrum analyzer was connected to the antenna port of the transmitter.

The procedure described in FCC Publication 558074 D01 DTS Meas Guidance v03r04 January 7, 2016, specifically section 10.2 Method PKPSD (peak PSD).

1. Set analyzer center frequency to DTS channel center frequency.
2. Set the span to 1.5 times the *DTS bandwidth*.
3. Set the RBW to:  $3 \text{ kHz} \leq \text{RBW} \leq 100 \text{ kHz}$ .
4. Set the VBW  $\geq 3 \times \text{RBW}$ .
5. Detector = peak.
6. Sweep time = auto couple.
7. Trace mode = max hold.
8. Allow trace to fully stabilize.
9. Use the peak marker function to determine the maximum amplitude level within the RBW.
10. If measured value exceeds limit, reduce RBW (no less than 3 kHz) and repeat.

4.3.3 Test Result

Refer to the following plots for the test result

Frequency, MHz	Maximum Power Spectral Density, dBm	Maximum Power Spectral Density Limit, dBm	Margin, dB	Plot
2402	-6.02	8.0	-14.02	3.1
2434	-6.18	8.0	-14.18	3.2
2480	-6.62	8.0	-14.62	3.3

<b>Date of Test:</b>	June 6, 2016
<b>Results</b>	<b>Complies</b>

Plot 3. 1

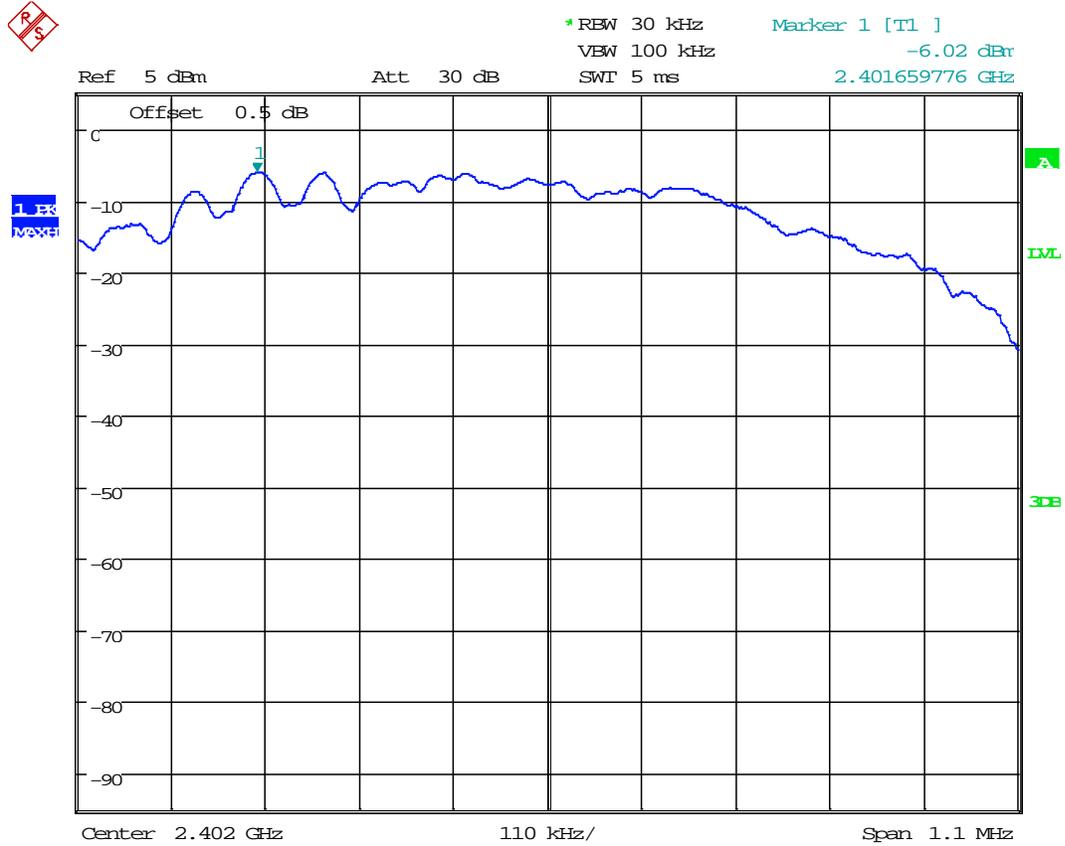

Date: 6.JUN.2016 14:20:49

Plot 3.2

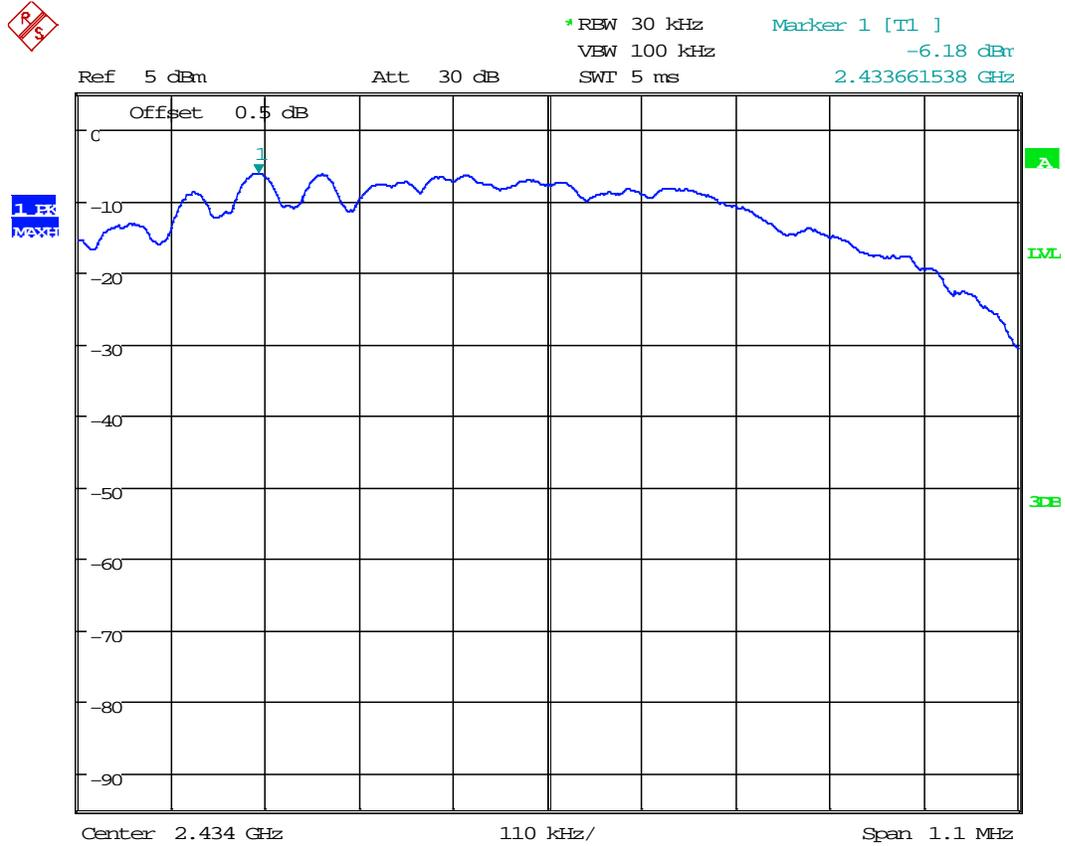

Date: 6.JUN.2016 14:19:01

Plot 3.3

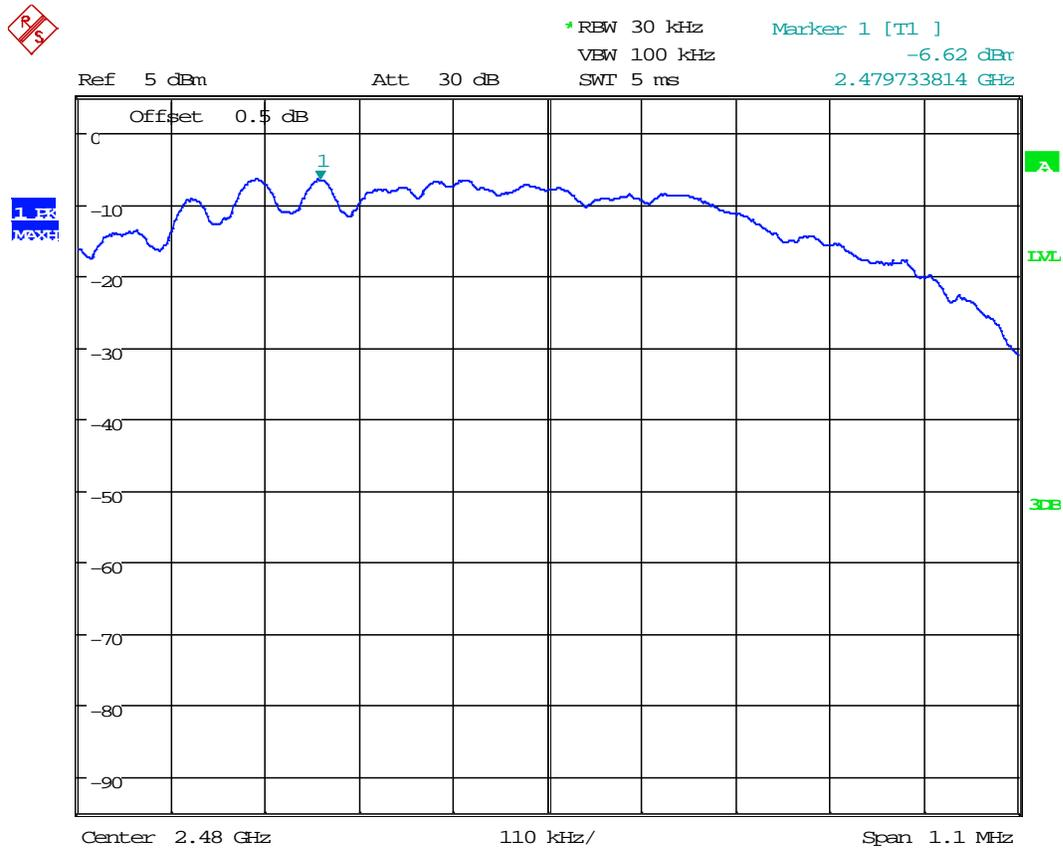

Date: 6.JUN.2016 14:19:35

4.4 Unwanted Conducted Emissions  
FCC: 15.247(d); RSS-247 A8.5;

4.4.1 Requirement

In any 100 kHz bandwidth outside the EUT pass-band, the RF power shall be below the maximum in-band 100 kHz emissions by at least 20 dB (if peak power of in-band emission is measured) or 30 dB (if average power of in-band emission is measured).

In addition, radiated emissions which fall in the restricted bands, as defined in § 15.205(a), must also comply with the radiated emission limits specified in § 15.209(a)

4.4.2 Procedure

The procedure described in FCC Publication 558074 D01 DTS Meas Guidance v03r04 January 7, 2016, specifically section 11.0 Emissions in non-restricted frequency bands.

A spectrum analyzer was connected to the antenna port of the transmitter.

1. Set the RBW = 100 kHz.
2. Set the VBW  $\geq 3 \times$  RBW.
3. Detector = peak.
4. Sweep time = auto couple.
5. Trace mode = max hold.
6. Allow trace to fully stabilize.
7. Use the peak marker function to determine the maximum amplitude level.

The unwanted emissions were measured from 30 MHz to 25 GHz. Plots below are corrected for cable loss and then compared to the limits.

4.4.3 Test Result

Refer to the following plots 4.1 – 4.5 for unwanted conducted emissions. The plot shows -20dB attenuation limit line.

<b>Date of Test:</b>	June 6, 2016
<b>Results</b>	<b>Complies</b>



Tx @ Low Channel, 2400 MHz Band Edge  
Plot 4.1

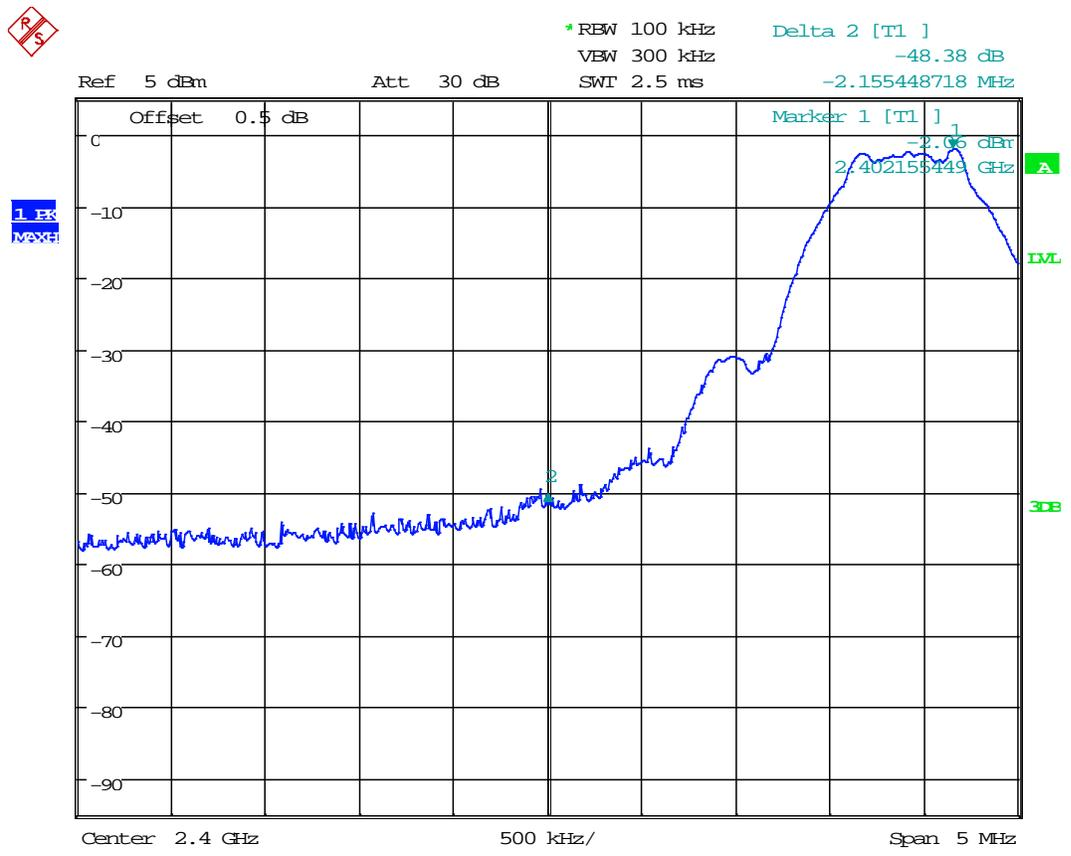

Date: 6.JUN.2016 14:34:56



Tx @ Low Channel, 2483.5 MHz Band Edge  
Plot 4.2

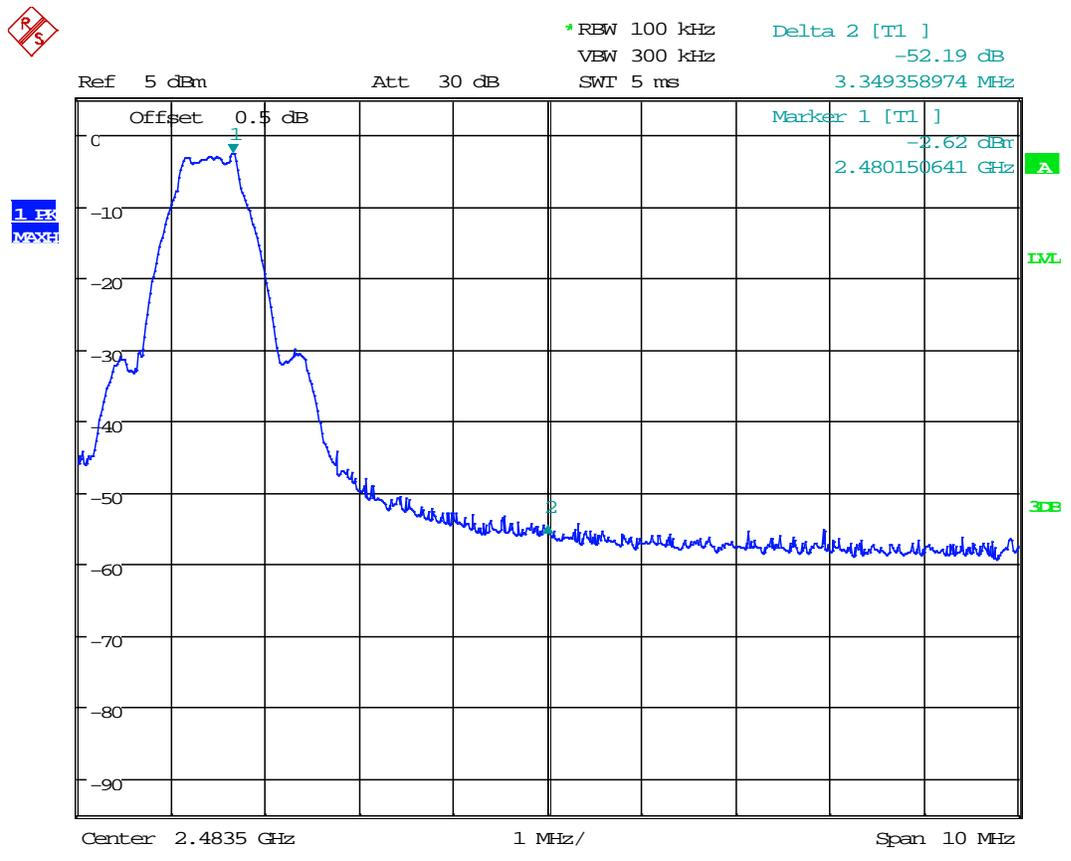

Date: 6.JUN.2016 14:32:55

Tx @ Low Channel, 2402 MHz  
30MHz -26GHz Conducted Spurious  
Plot 4.3

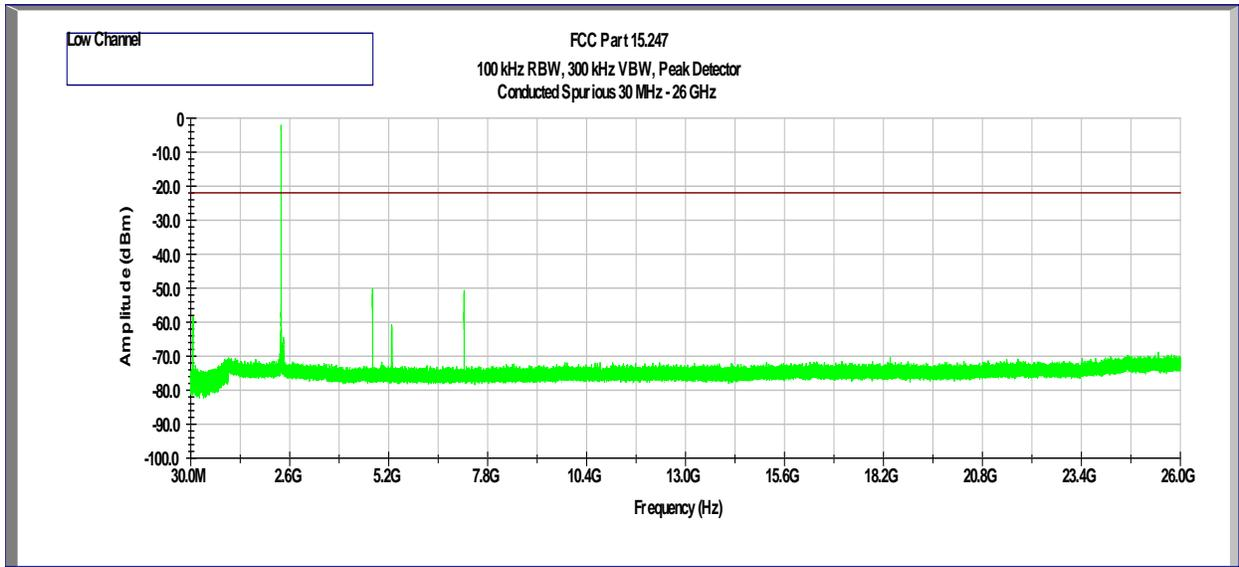

Tx @ Mid Channel, 2434 MHz  
30MHz -26GHz Conducted Spurious  
Plot 4.4

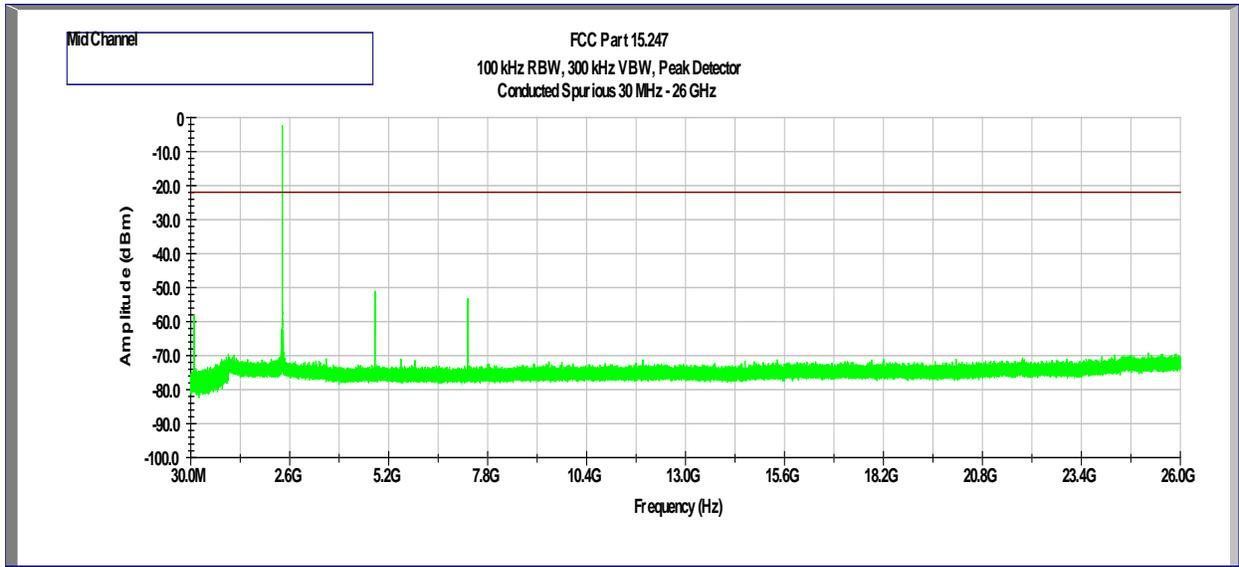

Tx @ High Channel, 2480 MHz  
30MHz -26GHz Conducted Spurious  
Plot 4.5

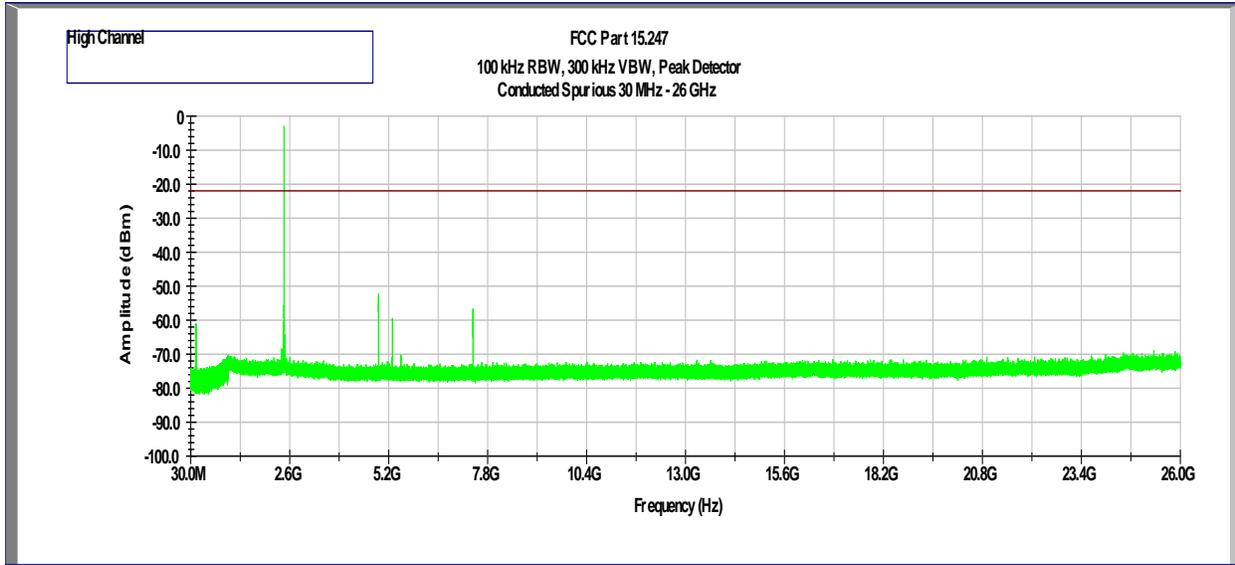

#### 4.5 Transmitter Radiated Emissions FCC Rules: 15.247(d), 15.209, 15.205; RSS-247;

##### 4.5.1 Requirement

Radiated emissions which fall in the restricted bands, as defined in §15.205(a), must also comply with the radiated emission limits specified in §15.209(a) (see §15.205(c)).

For out of band radiated emissions (except for frequencies in restricted bands), in any 100 kHz bandwidths outside the EUT pass-band, the RF power shall be at least 20dB (peak) or 30 dB (average) below that of the maximum in-band 100 kHz emissions.

##### 4.5.2 Procedure

Radiated emission measurements were performed from 30 MHz to 25 GHz according to the procedure described in ANSI C63.10. Spectrum Analyzer Resolution Bandwidth is 100 kHz or greater for frequencies 30 MHz to 1000 MHz, 1 MHz for frequencies above 1000 MHz. Above 1000 MHz Peak and Average measurements were performed.

The EUT is placed on a plastic turntable that is 80 cm in height for below 1000MHz and 1.5m in height for above 1GHz. If the EUT attaches to peripherals, they are connected and operational (as typical as possible). During testing, all cables were manipulated to produce worst-case emissions. The signal is maximized through rotation. The antenna height and polarization are varied during the search for maximum signal level. The antenna height is varied from 1 to 4 meters.

Radiated emissions are taken at 3 meters for frequencies above 1 GHz and at 10 meters for frequencies below 1 GHz.

Measurements made from 1 GHz to 18GHz had a 2.4-2.5GHz notch filter in place. A preamp was used from 30MHz to 26GHz.

All measurements were made with a Peak Detector and compared to QP limits for 30MHz – 1GHz and Average limits for 1GHz – 26GHz.

Data is included of the worst-case configuration (the configuration which resulted in the highest emission levels).

### 4.5.3 Field Strength Calculation

#### Field Strength Calculation

The field strength is calculated by adding the Antenna Factor and Cable Factor, and subtracting the Amplifier Gain (if any) from the measured reading. The basic equation with a sample calculation is as follows:

$FS = RA + AF + CF - AG$ ; if measurement is performed at a distance other than specified in the rule, a Distance Correction Factor (DCF) shall be added.

Where  $FS$  = Field Strength in  $dB(\mu V/m)$

$RA$  = Receiver Amplitude (including preamplifier) in  $dB(\mu V)$ ;  $AF$  = Antenna Factor in  $dB(1/m)$

$CF$  = Cable Attenuation Factor in  $dB$ ;  $AG$  = Amplifier Gain in  $dB$

Assume a receiver reading of  $52.0\text{ dB}(\mu V)$  is obtained. The antennas factor of  $7.4\text{ dB}(1/m)$  and cable factor of  $1.6\text{ dB}$  is added. The amplifier gain of  $29\text{ dB}$  is subtracted, giving field strength of  $32\text{ dB}(\mu V/m)$ . This value in  $dB(\mu V/m)$  was converted to its corresponding level in  $\mu V/m$ .

$RA = 52.0\text{ dB}(\mu V)$

$AF = 7.4\text{ dB}(1/m)$

$CF = 1.6\text{ dB}$

$AG = 29.0\text{ dB}$

$FS = 52.0 + 7.4 + 1.6 - 29.0 = 32\text{ dB}(\mu V/m)$ .

Level in  $\mu V/m = \text{Common Antilogarithm} [(32\text{ dB}\mu V/m)/20] = 39.8\text{ }\mu V/m$ .

#### 4.5.4 Antenna-port conducted measurements

Antenna-port conducted measurements may also be used as an alternative to radiated measurements for demonstrating compliance in the restricted frequency bands. If conducted measurements are performed, then proper impedance matching must be ensured and an additional radiated test for cabinet/case spurious emissions is required.

#### 4.5.6 General Procedure for conducted measurements in restricted bands

- a) Measure the conducted output power (in dBm) using the detector specified for determining quasi-peak, peak, and average conducted output power, respectively.
- b) Add the maximum transmit antenna gain (in dBi) to the measured output power level to determine the EIRP level (see 12.2.5 for guidance on determining the applicable antenna gain)
- c) Add the appropriate maximum ground reflection factor to the EIRP level (6 dB for frequencies  $\leq 30$  MHz, 4.7 dB for frequencies between 30 MHz and 1000 MHz, inclusive and 0 dB for frequencies  $> 1000$  MHz).
- d) For devices with multiple antenna-ports, measure the power of each individual chain and sum the EIRP of all chains in linear terms (*e.g.*, Watts, mW).
- e) Convert the resultant EIRP level to an equivalent electric field strength using the following relationship:  
$$E = \text{EIRP} - 20\log D + 104.8$$
where:  
E = electric field strength in dB $\mu$ V/m,  
EIRP = equivalent isotropic radiated power in dBm  
D = specified measurement distance in meters.
- f) Compare the resultant electric field strength level to the applicable limit.
- g) Perform radiated spurious emission test

#### 4.5.7 Test Results

The data on the following pages list the significant emission frequencies, the limit and the margin of compliance where emissions are within 3dB of the limit.

All conducted antenna port plots are corrected with the consideration of a 0 dBi Antenna Gain.

Radiated emission measurements were performed up to 26GHz. No Emissions were identified when scanned from 18-25 GHz.

Test Results: 15.209/15.205 Restricted Band Emissions at Antenna Port

Out-of-Band Spurious Emissions at the Band Edge – Tx @ 2402 MHz

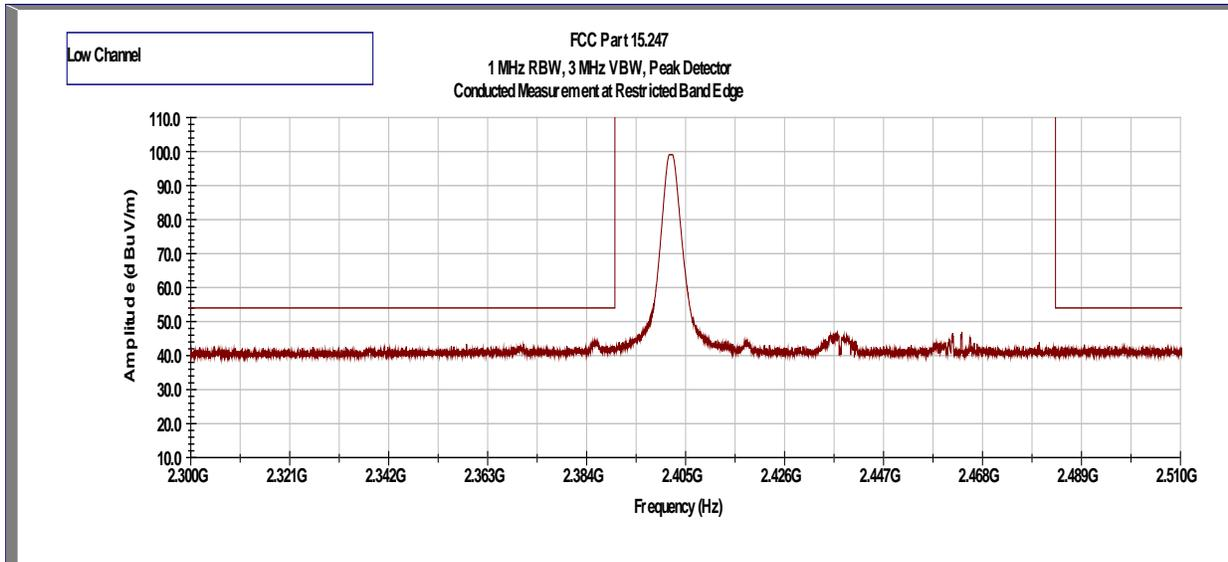

### Out-of-Band Spurious Emissions at the Band Edge – Tx @ 2480 MHz

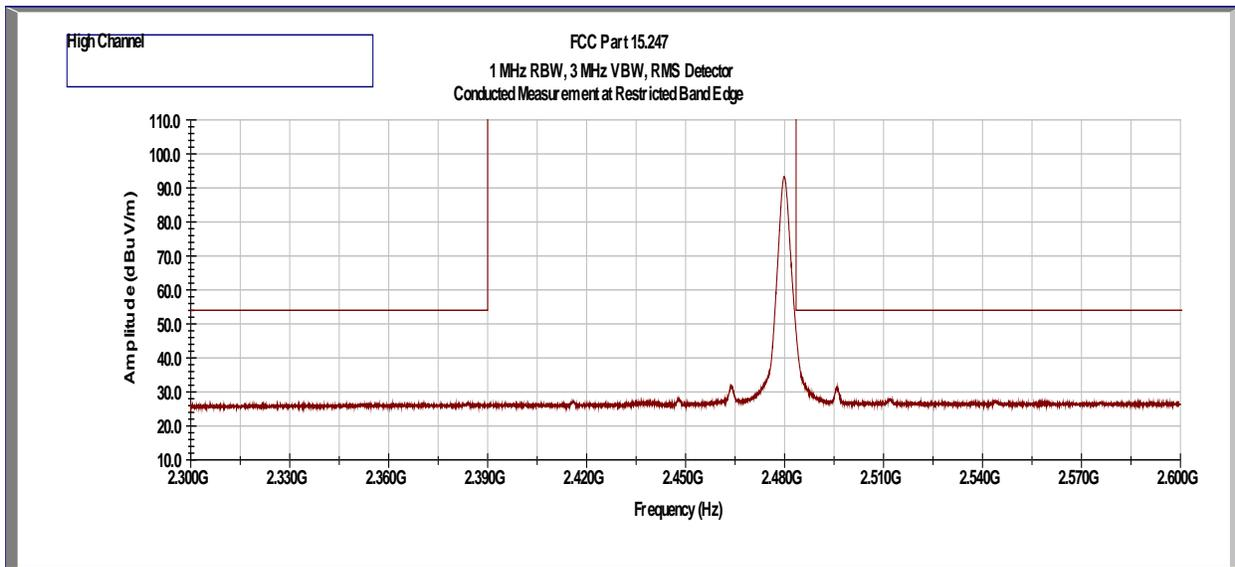
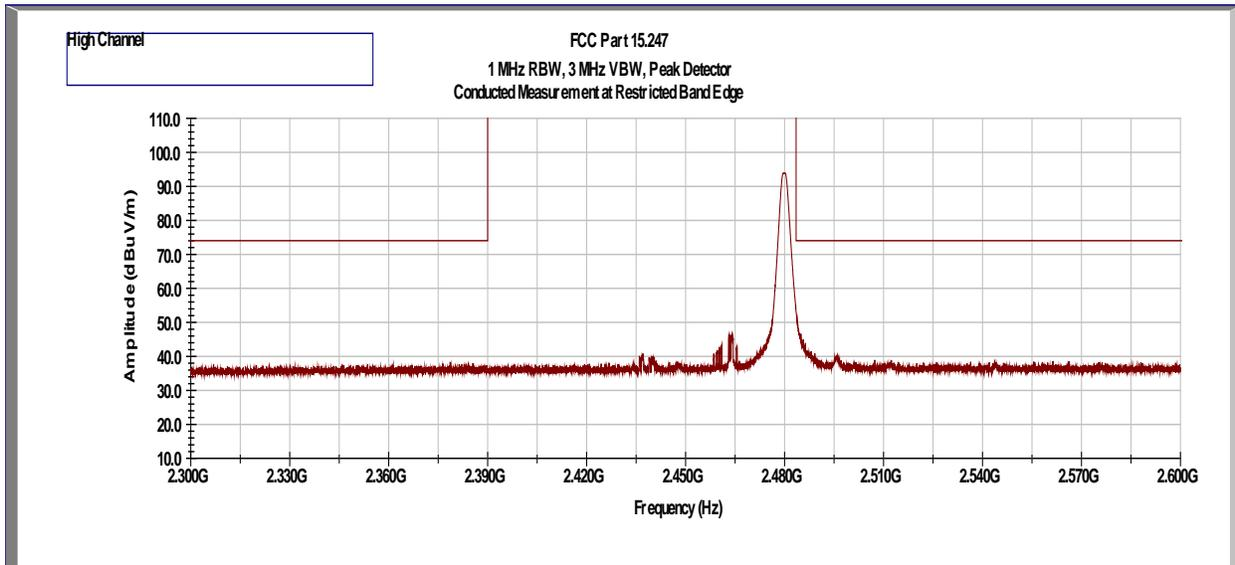

Frequency	Corrected Amplitude	Avg Limit	Margin	Detector	Results
GHz	dBμV/m	dBμV/m	dB		
2.4835	47.5	54	-6.5	RMS	Pass

### Out-of-Band Conducted Spurious Emissions (at Antenna Port)

**Tx @ 2402MHz**

Out-of-Band Spurious Emissions at Antenna Port - 30 MHz to 1 GHz

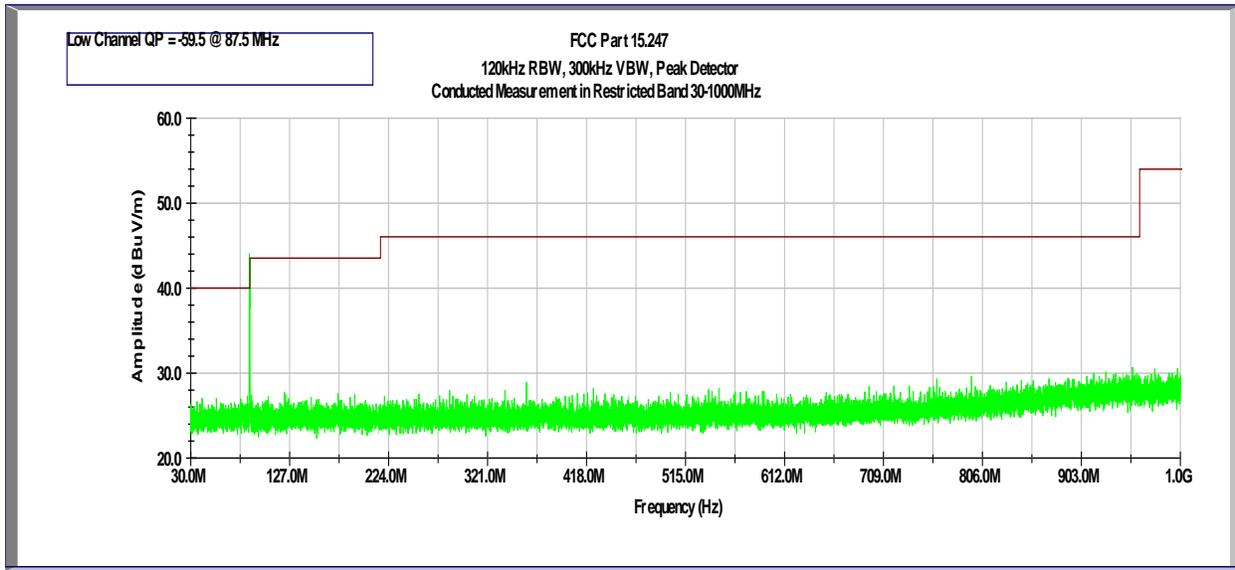

\*Peak at 87 MHz does not fall in the restricted band according to FCC §15.205. Please see Plot 4.3 for non-restricted band spurious emission.

Out-of-Band Spurious Emissions at Antenna Port – 1 - 26 GHz Peak Detector vs Avg Limit

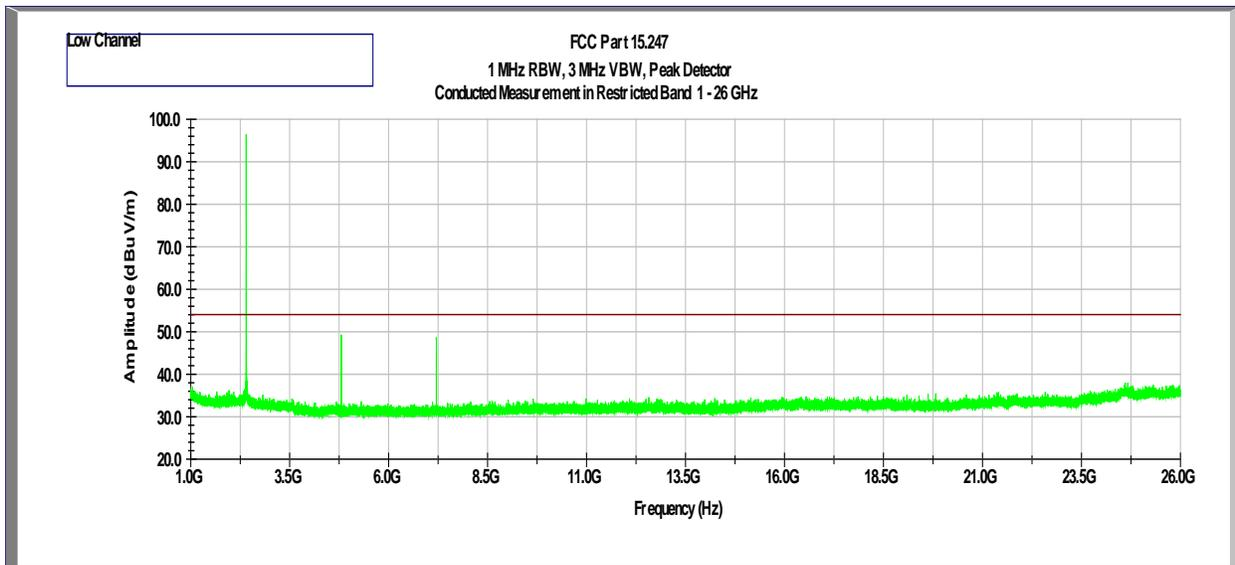



**Out-of-Band Conducted Spurious Emissions (at Antenna Port)**

**Tx @ 2434MHz**

Out-of-Band Spurious Emissions at Antenna Port - 30 MHz to 1 GHz

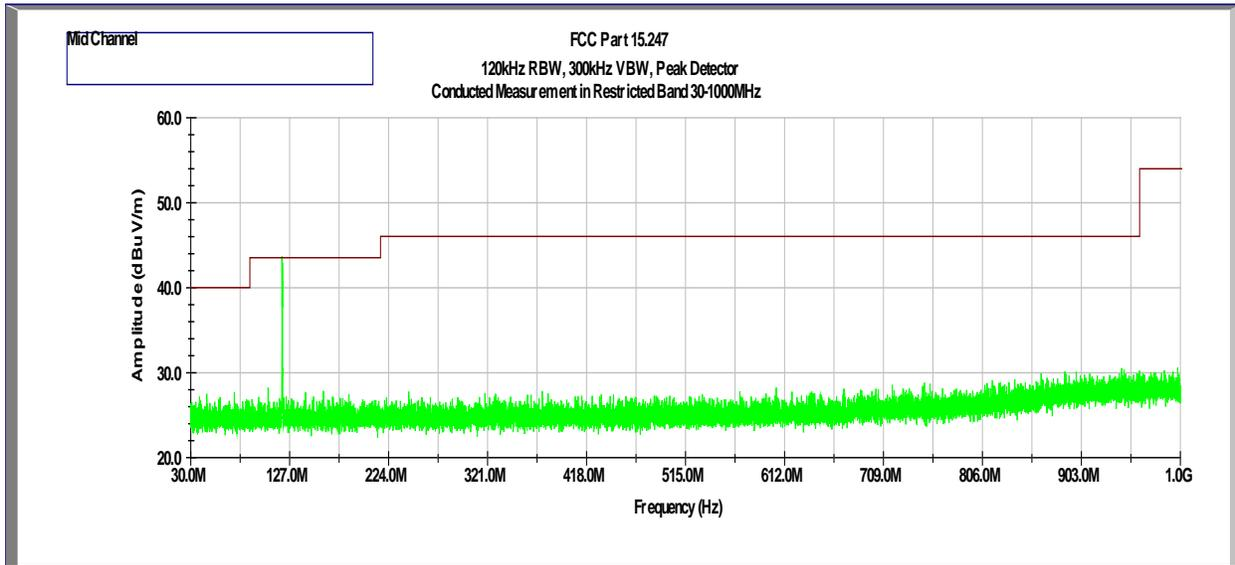

Frequency	Corrected Amplitude	Limit	Margin	Detector	Results
MHz	dB $\mu$ V/m	dB $\mu$ V/m	dB		
119.45	42.9	43.5	-0.6	QP	Pass

Out-of-Band Spurious Emissions at Antenna Port – 1 - 26 GHz Peak Detector vs Avg Limit

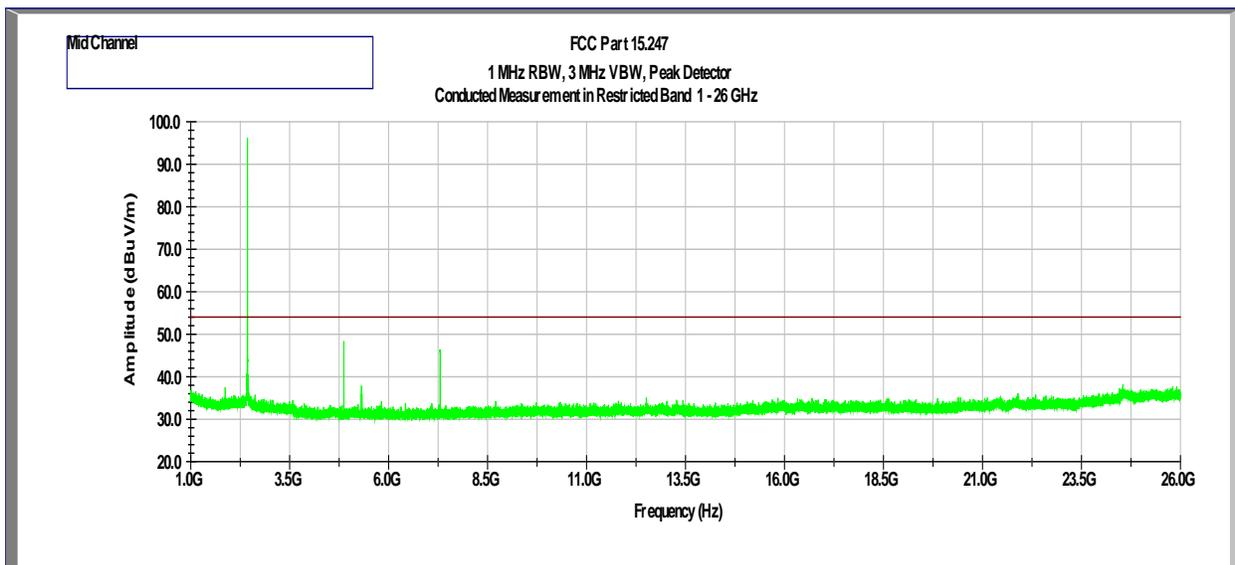

**Out-of-Band Conducted Spurious Emissions (at Antenna Port)**

**Tx @ 2480MHz**

Out-of-Band Spurious Emissions at Antenna Port - 30 MHz to 1 GHz

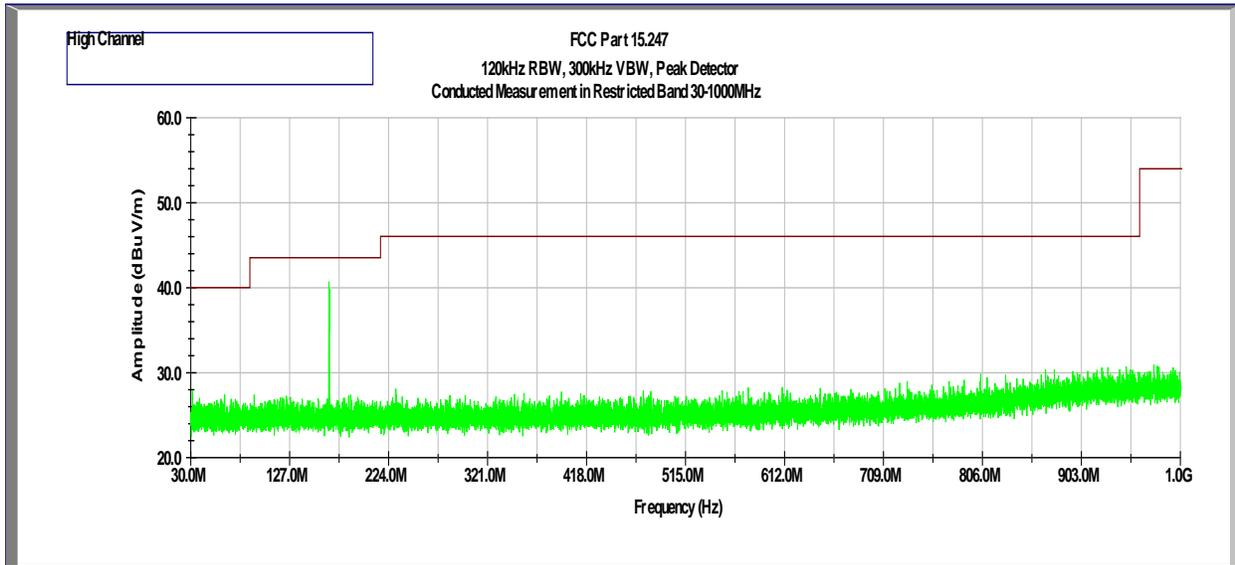

Out-of-Band Spurious Emissions at Antenna Port – 1 - 26 GHz Peak Detector vs Avg Limit

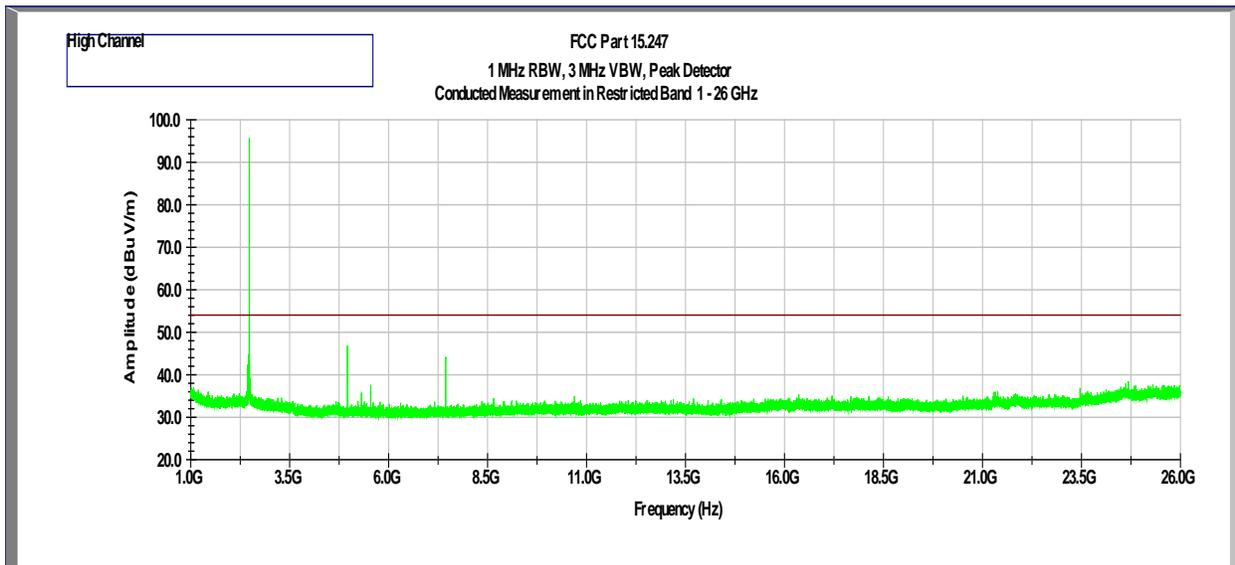



### Out-of-Band Radiated Spurious Emissions (Cabinet Radiation)

Test Results: 15.209 Radiated Spurious Emissions Low Channel, Tx at 2402MHz

Radiated Spurious Emissions 30 MHz - 1000 MHz

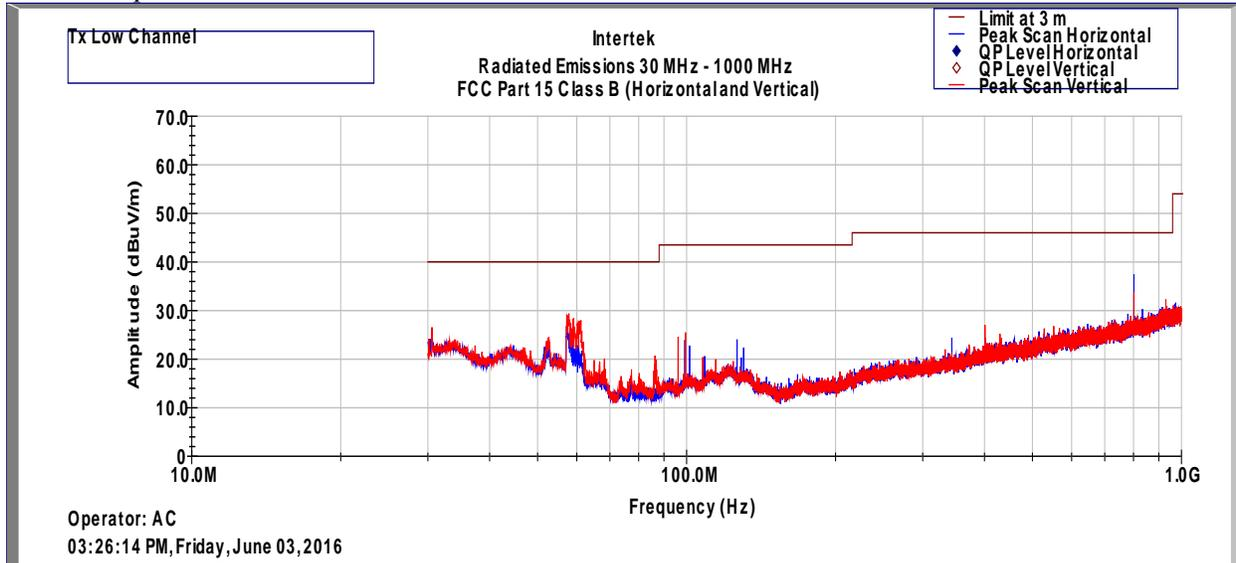

Radiated Spurious Emissions 1000 - 18000 MHz, Peak Scan vs Avg Limit

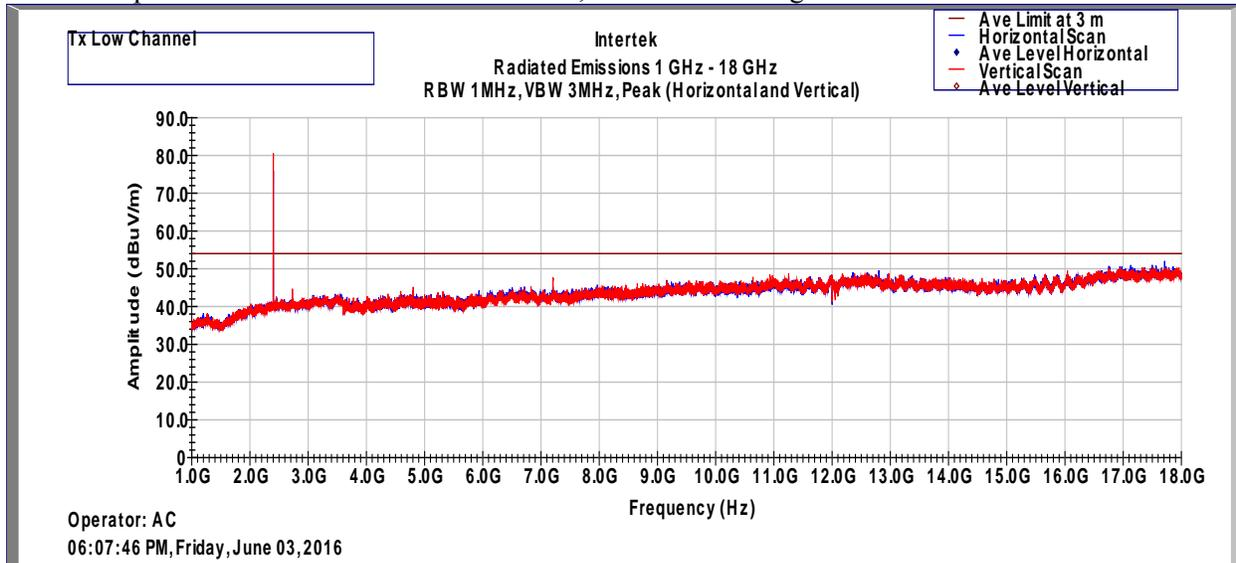

Note: Radiated emission measurements were performed up to 25GHz. No Emissions were identified when scanned from 18-25 GHz

Note:  $FS@3m = RA + AF + CF - \text{Preamp}$



Test Results: 15.209 Radiated Spurious Emissions Mid Channel, Tx at 2434MHz

### Radiated Spurious Emissions 30 MHz - 1000 MHz

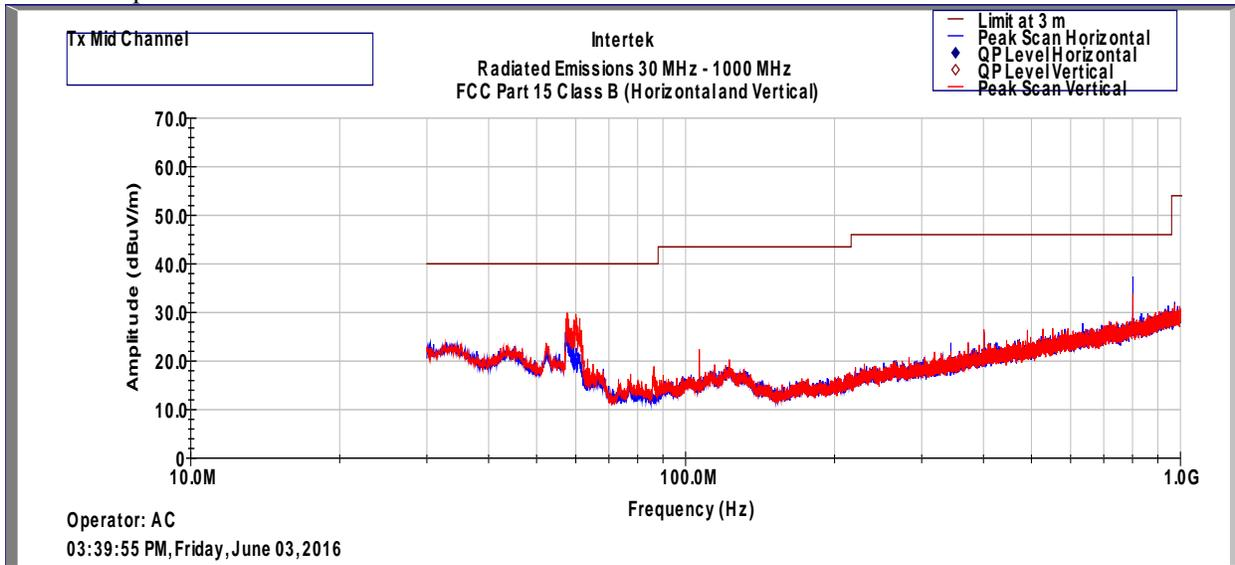

### Radiated Spurious Emissions 1000 - 18000 MHz, Peak Scan vs Avg Limit

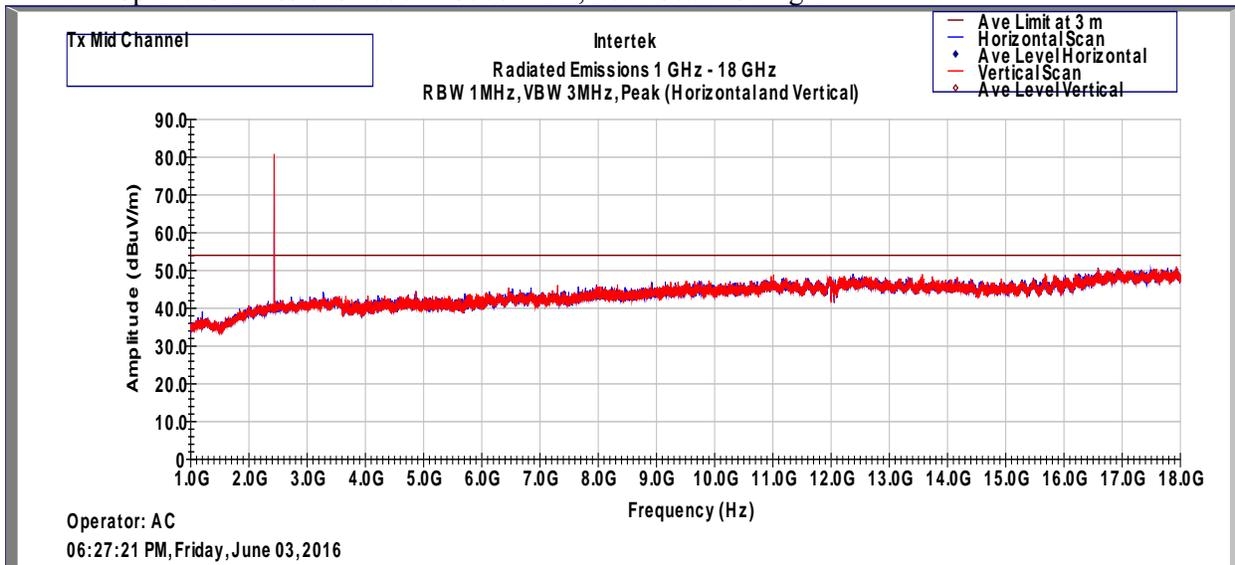

Note: Radiated emission measurements were performed up to 25GHz. No Emissions were identified when scanned from 18-25 GHz

Note: FS@3m = RA + AF + CF - Preamp

Test Results: 15.209 Radiated Spurious Emissions High Channel, Tx at 2480MHz

## Radiated Spurious Emissions 30 MHz - 1000 MHz

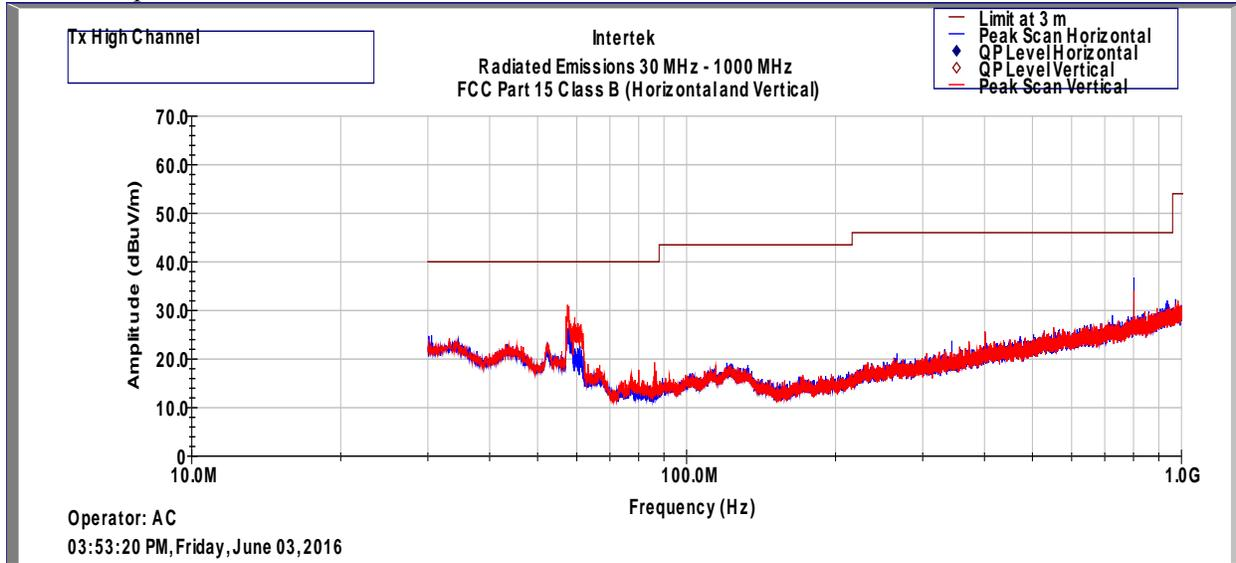

## Radiated Spurious Emissions 1000 - 18000 MHz, Peak Scan vs Avg Limit

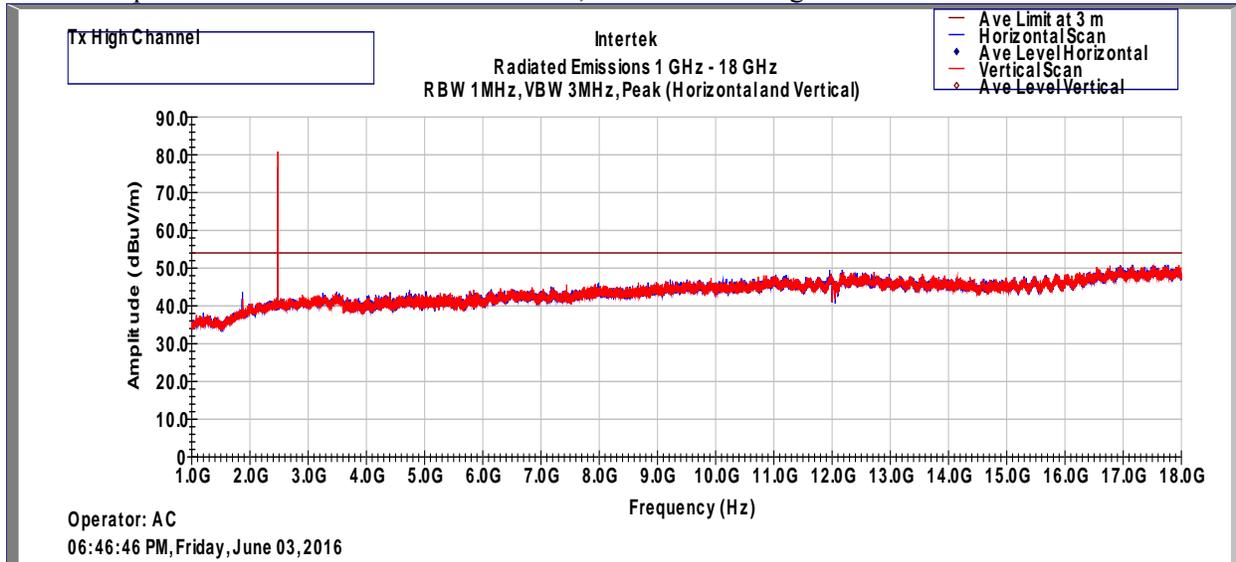

Note: Radiated emission measurements were performed up to 25GHz. No Emissions were identified when scanned from 18-25 GHz

Note: FS@3m = RA + AF + CF - Preamp

**Results**

**Complies**

#### 4.5.8 Test setup photographs

The following photographs show the testing configurations used.

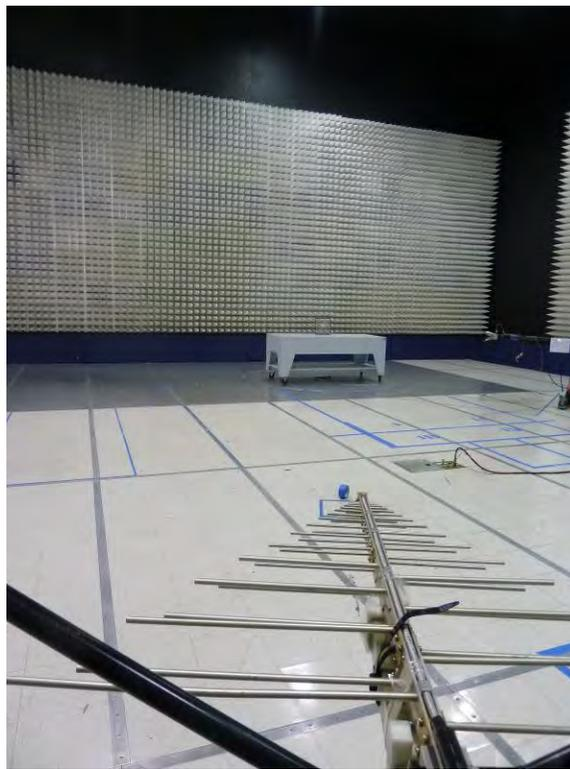

4.5.5 Test setup photographs (Continued)



## 5.0 RF Exposure Evaluation

The device is used in a portable RF exposure configuration – at a distance less than 20 cm from human’s body. For this configuration SAR evaluation is required.

The RF Power is low; therefore the SAR test exclusion threshold is calculated.

**SAR test exclusion threshold formula according to FCC KDB 447898 D01 v05r02 is**

$$P \cdot \sqrt{f/d} < 3$$

Where:

**P** is maximum RF conducted power of a channel or EIRP, including tune-up tolerance, mW;

**f** is operating frequency in GHz;

**d** is the minimum test separation distance, mm; the minimum distance is 5 mm.

The maximum Peak EIRP calculated is -0.86 dBm (RF Conducted Power) + 0 dBi (Antenna Gain) = -0.86 dBm or 0.82 mW (P).

The **SAR test exclusion threshold** at 5mm distance is calculated as:

$$0.82 \times \sqrt{2.480 \div 5} = 0.26 < 3.$$

**Therefore, SAR testing is not required as the SAR Test Exclusion Threshold condition is satisfied.**

For IC: **SAR Exemption limit according to IC RSS-102 Issue 5, at 5 mm separation distance = 4 mW**

*Routine evaluation is not required since the higher of the maximum conducted or equivalent isotropically radiated power (e.i.r.p.) source-based, time averaged output power is below the exemption limit.*

<b>Date of Test:</b>	June 6, 2016
<b>Results</b>	<b>Complies</b>

## 6.0 List of Test Equipment

Measurement equipment used for emission compliance testing utilized the equipment on the following list:

Equipment	Manufacturer	Model/Type	Asset #	Cal Int	Cal Due
EMI Receiver	Rohde and Schwarz	ESU	ITS 01375	12	12/11/16
Spectrum Analyzer	Rohde and Schwarz	FSU	ITS 00913	12	01/05/17
BI-Log Antenna	ARA	LPB-2513/A	ITS 00355	12	09/11/16
Pyramidal Horn Antenna	EMCO	3160-09	ITS00571	#	#
Pre-Amplifier	Sonoma Instrument	310N	ITS 00942	12	01/07/17
Pre-Amplifier (18-40GHz)	Miteq	JSD44-18004000-305P	ITS 00921	12	06/18/16
Active Horn Antenna	ETS-Lindgren	3117-PA	ITS 01365	12	10/15/16

# No Calibration required

## 7.0 Document History

<b>Revision/ Job Number</b>	<b>Writer Initials</b>	<b>Reviewers Initials</b>	<b>Date</b>	<b>Change</b>
1.0 / G102599840	AC	KV	June 21, 2016	Original document