



MET Laboratories, Inc. *Safety Certification - EMI - Telecom Environmental Simulation*

914 WEST PATAPSCO AVENUE ! BALTIMORE, MARYLAND 21230-3432 ! PHONE (410) 354-3300 ! FAX (410) 354-3313
33439 WESTERN AVENUE ! UNION CITY, CALIFORNIA 94587 ! PHONE (510) 489-6300 ! FAX (510) 489-6372
3162 BELICK STREET ! SANTA CLARA, CA 95054 ! PHONE (408) 748-3585 ! FAX (510) 489-6372
13301 MCCALLEN PASS ! AUSTIN, TX 78753 ! PHONE (512) 287-2500 ! FAX (512) 287-2513

January 29, 2019

Mikado Model Helicopters GmbH
Friedrich-Klausing-Str. 2
Potsdam, Germany 14469

Dear Bryan Barrow,

Enclosed is the EMC Wireless test report for compliance testing of the Mikado Model Helicopters GmbH, VBar NEO as tested to the requirements of Title 47 of the CFR, Ch. 1 (10-1-06 ed.) FCC Part 15 Subpart C for Intentional Radiators.

Thank you for using the services of MET Laboratories, Inc. If you have any questions regarding these results or if MET can be of further service to you, please feel free to contact me.

Sincerely yours,
MET LABORATORIES, INC.

Joel Huna
Documentation Department

Reference: (\Mikado Model Helicopters GmbH\EMC99023B-FCC247 Rev. 2)

Certificates and reports shall not be reproduced except in full, without the written permission of MET Laboratories, Inc. While use of the A2LA logo in this report reflects MET accreditation under these programs, the report must not be used by the client to claim product certification, approval, or endorsement by A2LA or any agency of the Federal Government. This letter of transmittal is not a part of the attached report.



The Nation's First Licensed Nationally Recognized Testing Laboratory

Electromagnetic Compatibility Criteria Test Report

for the

**Mikado Model Helicopters GmbH
VBar NEO**

Tested under
the FCC Certification Rules
contained in
Title 47 of the CFR, Parts 15 Subpart C
15.247 for Intentional Radiators

MET Report: EMC99023B-FCC247 Rev. 2

January 29, 2019

Prepared For:

**Mikado Model Helicopters GmbH
Friedrich-Klausing-Str. 2
Potsdam, Germany 14469**

Prepared By:
MET Laboratories, Inc.
914 West Patapsco Avenue,
Baltimore, MD 21230

Electromagnetic Compatibility Criteria Test Report

for the

**Mikado Model Helicopters GmbH
VBar NEO**

Tested under
the FCC Certification Rules
contained in
Title 47 of the CFR, Parts 15
15.247 Subpart C for Intentional Radiators



William Lash, Project Engineer
Electromagnetic Compatibility Lab



Joel Huna
Documentation Department

Engineering Statement: The measurements shown in this report were made in accordance with the procedures indicated, and the emissions from this equipment were found to be within the limits applicable. I assume full responsibility for the accuracy and completeness of these measurements, and for the qualifications of all persons taking them. It is further stated that upon the basis of the measurements made, the equipment tested is capable of operation in accordance with the requirements of the FCC Rules Part 15.247 under normal use and maintenance.

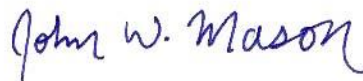

John Mason,
Director, Electromagnetic Compatibility Lab



Report Status Sheet

Revision	Report Date	Reason for Revision
Ø	November 6, 2018	Initial Issue.
1	January 9, 2019	TCB Corrections.
2	January 29, 2019	TCB Corrections.

Table of Contents

I.	Executive Summary	1
	A. Purpose of Test	2
	B. Executive Summary	2
II.	Equipment Configuration	3
	A. Overview.....	4
	B. References.....	5
	C. Test Site	5
	D. Measurement Uncertainty	5
	E. Description of Test Sample.....	6
	F. Equipment Configuration.....	7
	G. Support Equipment	7
	H. Ports and Cabling Information.....	7
	I. Mode of Operation.....	8
	J. Method of Monitoring EUT Operation	8
	K. Modifications	8
	a) Modifications to EUT	8
	b) Modifications to Test Standard.....	8
	L. Disposition of EUT	8
III.	Electromagnetic Compatibility Criteria for Intentional Radiators	9
	§ 15.203 Antenna Requirement	10
	§ 15.247(a)(1) 20 dB Occupied Bandwidth.....	11
	§ 15.247(a)(1) Average Time of Occupancy (Dwell Time)	13
	§ 15.247(a)(1) Number of RF Channels	15
	§ 15.247(a)(1) RF Channel Separation.....	17
	§ 15.247(b) Peak Power Output	18
	§ 15.247(d) Radiated Spurious Emissions Requirements and Band Edge.....	21
	§ 15.247(g)(h) Declaration Statements for FHSS.....	33
IV.	Test Equipment	35
V.	Certification & User's Manual Information	37
	A. Certification Information	38
	B. Label and User's Manual Information	42

List of Tables

Table 1. Executive Summary of EMC Part 15.247 Compliance Testing	2
Table 2. EUT Summary Table.....	4
Table 3. References	5
Table 4. Uncertainty Calculations Summary.....	5
Table 5. Support Equipment.....	7
Table 6. Ports and Cabling Information	7
Table 7. Antenna List	10
Table 8. Occupied Bandwidth, Test Results.....	11
Table 9. Average Time of Occupancy.....	13
Table 10. Peak Radiated Output Power, Test Results	19
Table 11. Restricted Bands of Operation.....	21
Table 12. Radiated Emissions Limits Calculated from FCC Part 15, § 15.209 (a)	22
Table 13. Test Equipment List	36

List of Plots

Plot 1. 20 dB Occupied Bandwidth, High Channel, final.....	12
Plot 2. 20 dB Occupied Bandwidth, Low Channel.....	12
Plot 3. 20 dB Occupied Bandwidth, Mid Channel	12
Plot 4. Dwell Time, # of pulses calculation.....	14
Plot 5. Dwell Time, # of pulses	14
Plot 6. Dwell Time, Pulse Width.....	14
Plot 7. Number of Hopping Channels, 2.4-2.42 GHz.....	15
Plot 8. Number of Hopping Channels, 2.42-2.44 GHz.....	15
Plot 9. Number of Hopping Channels, 2.44-2.46 GHz.....	16
Plot 10. Number of Hopping Channels, 2.46-2.4835 GHz.....	16
Plot 11. Channel Separation, High Channel.....	17
Plot 12. Channel Separation, Low Channel.....	17
Plot 13. Channel Separation, Mid Channel	17
Plot 14. Peak Power Output, 11.31dBm, High.....	20
Plot 15. Peak Power Output, 11.31dBm, Low.....	20
Plot 16. Peak Power Output, 18.96dBm, Mid	20
Plot 17. Radiated Emissions, Average, 1 – 18 GHz, High Channel.....	23
Plot 18. Radiated Emissions, Average, 1 – 18 GHz, Mid Channel	23
Plot 19. Radiated Emissions, Average, Mid Channel, Zoom, 4800 MHz	23
Plot 20. Radiated Emissions, Average, Mid Channel, Zoom, 7320 MHz	24
Plot 21. Radiated Emissions, Average, 1 – 18 GHz, Low Channel,.....	24
Plot 22. Radiated Emissions, Peak, 1 – 18 GHz, High Channel.....	24
Plot 23. Radiated Emissions, Peak, 1 – 18 GHz, Mid Channel	25
Plot 24. Radiated Emissions, Peak, 1 – 18 GHz, Low Channel	25
Plot 25. Radiated Emissions, 15.209, 30 MHz - 1 GHz, prescan, Low	25
Plot 26. Radiated Emissions, 15.209, 30 MHz - 1 GHz, prescan, Mid	26
Plot 27. Radiated Emissions, 15.209, 30 MHz - 1 GHz, prescan, High	26
Plot 28. Radiated Band Edge, High, Average	27
Plot 29. Radiated Band Edge, High, Peak	27
Plot 30. Radiated Band Edge, 2483.5 Zoom	28
Plot 31. Radiated Band Edge, 2483.5 Zoom	28
Plot 32. Radiated Band Edge, Low, Average.....	29
Plot 33. Radiated Band Edge, Low, Peak.....	29
Plot 34. Radiated Band Edge, Low Channel	30

Plot 34. Radiated Band Edge, High Channel.....30

List of Figures

Figure 1. Block Diagram of Test Configuration..... 6
Figure 2. Block Diagram, Occupied Bandwidth Test Setup.....11
Figure 3. Peak Power Output Test Setup.....18

List of Photographs

Photograph 1. Radiated Spurious Emissions, Above 1 GHz, Test Setup31
Photograph 2. Radiated Spurious Emissions, Close up, Test Setup31

List of Terms and Abbreviations

AC	Alternating Current
ACF	Antenna Correction Factor
Cal	Calibration
<i>d</i>	Measurement Distance
dB	Decibels
dBμA	Decibels above one microamp
dBμV	Decibels above one microvolt
dBμA/m	Decibels above one microamp per meter
dBμV/m	Decibels above one microvolt per meter
DC	Direct Current
E	Electric Field
DSL	Digital Subscriber Line
ESD	Electrostatic Discharge
EUT	Equipment Under Test
<i>f</i>	Frequency
FCC	Federal Communications Commission
GRP	Ground Reference Plane
H	Magnetic Field
HCP	Horizontal Coupling Plane
Hz	Hertz
IEC	International Electrotechnical Commission
kHz	kilohertz
kPa	kilopascal
kV	kilovolt
LISN	Line Impedance Stabilization Network
MHz	Megahertz
μH	microhenry
μ	microfarad
μs	microseconds
NEBS	Network Equipment-Building System
PRF	Pulse Repetition Frequency
RF	Radio Frequency
RMS	Root-Mean-Square
TWT	Traveling Wave Tube
V/m	Volts per meter
VCP	Vertical Coupling Plane

I. Executive Summary

A. Purpose of Test

An EMC evaluation was performed to determine compliance of the Mikado Model Helicopters GmbH VBar NEO, with the requirements of Part 15, §15.247. All references are to the most current version of Title 47 of the Code of Federal Regulations in effect. In accordance with §2.1033, the following data is presented in support of the Certification of the VBar NEO. Mikado Model Helicopters GmbH should retain a copy of this document which should be kept on file for at least two years after the manufacturing of the VBar NEO, has been **permanently** discontinued.

B. Executive Summary

The following tests were conducted on a sample of the equipment for the purpose of demonstrating compliance with Part 15, §15.247, in accordance with Mikado Model Helicopters GmbH, purchase order number 1001. All tests were conducted using measurement procedure ANSI C63.4-2003.

FCC Reference 47 CFR Part 15.247:2005	Description	Compliance
Title 47 of the CFR, Part 15 §15.203	Antenna Requirement	Compliant – The EUT employs an integrated antenna.
Title 47 of the CFR, Part 15 §15.207(a)	Conducted Emission Limits	Not Applicable – This EUT is battery powered.
Title 47 of the CFR, Part 15 §15.247(a)(1)	20 dB Occupied Bandwidth	Compliant
Title 47 of the CFR, Part 15 §15.247(a)(1)	Average Time of Occupancy (Dwell Time)	Compliant
Title 47 of the CFR, Part 15 §15.247(a)(1)	Number of RF Channels	Compliant
Title 47 of the CFR, Part 15 §15.247(a)(1)	RF Channel Separation	Compliant
Title 47 of the CFR, Part 15 §15.247(b)	Peak Power Output	Compliant
Title 47 of the CFR, Part 15 §15.247(d); §15.209; §15.205	Radiated Spurious Emissions	Compliant
Title 47 of the CFR, Part 15 §15.247(d)	Spurious Conducted Emissions	Not Applicable
Title 47 of the CFR, Part 15 §15.247(g) & (h)	Declaration Statements for FHSS	Compliant
Title 47 of the CFR, Part 15 §15.247(i)	Maximum Permissible Exposure (MPE)	Compliant

Table 1. Executive Summary of EMC Part 15.247 Compliance Testing

II. Equipment Configuration

A. Overview

MET Laboratories, Inc. was contracted by Mikado Model Helicopters GmbH to perform testing on the VBar NEO, under Mikado Model Helicopters GmbH's purchase order number 1001.

This document describes the test setups, test methods, required test equipment, and the test limit criteria used to perform compliance testing of the Mikado Model Helicopters GmbH, VBar NEO.

The results obtained relate only to the item(s) tested.

Model(s) Tested:	VBar NEO	
Model(s) Covered:	VBar NEO	
EUT Specifications:	Primary Power: Battery Pack 5-8,4V is needed. Current draw 70-90 mA	
	FCC ID: 2ABXHVBBCRX20	
	Type of Modulations:	MSK
	Equipment Code:	FHSS
	Peak RF Output Power:	18.96 dBm
	EUT Frequency Ranges:	2.401 GHz to 2.481 GHz
Analysis:	The results obtained relate only to the item(s) tested.	
Environmental Test Conditions:	Temperature: 15-35° C	
	Relative Humidity: 30-60%	
	Barometric Pressure: 860-1060 mbar	
Evaluated by:	William Lash	
Report Date(s):	January 29, 2019	

Table 2. EUT Summary Table

B. References

CFR 47, Part 15, Subpart C	Federal Communication Commission, Code of Federal Regulations, Title 47, Part 15: General Rules and Regulations, Allocation, Assignment, and Use of Radio Frequencies
ANSI C63.4:2003	Methods and Measurements of Radio-Noise Emissions from Low-Voltage Electrical And Electronic Equipment in the Range of 9 kHz to 40 GHz
ISO/IEC 17025:2005	General Requirements for the Competence of Testing and Calibration Laboratories
ANSI C63.10-2009	American National Standard for Testing Unlicensed Wireless Devices

Table 3. References

C. Test Site

All testing was performed at MET Laboratories, Inc., 914 West Patapsco Avenue, Baltimore, MD 21230. All equipment used in making physical determinations is accurate and bears recent traceability to the National Institute of Standards and Technology.

Radiated Emissions measurements were performed in a 3 meter semi-anechoic chamber (equivalent to an Open Area Test Site). In accordance with §2.948(a)(3), a complete site description is contained at MET Laboratories.

D. Measurement Uncertainty

Test Method	Typical Expanded Uncertainty	K	Confidence Level
RF Frequencies	±4.52 Hz	2	95%
RF Power Conducted Emissions	±2.32 dB	2	95%
RF Power Conducted Spurious Emissions	±2.25 dB	2	95%
RF Power Radiated Emissions	±3.01 dB	2	95%

Table 4. Uncertainty Calculations Summary

E. Description of Test Sample

The Mikado Model Helicopters GmbH VBar NEO, Equipment Under Test (EUT), is the counterpart of the system that is installed in the R/C Model. It contains a control unit to control the model, as well as radio circuit to communicate with VBar Control. The Unit has to be installed by the user inside the model and comprises different ports to maintain this (Servo connectors, Power Connector). Only radiated samples were submitted

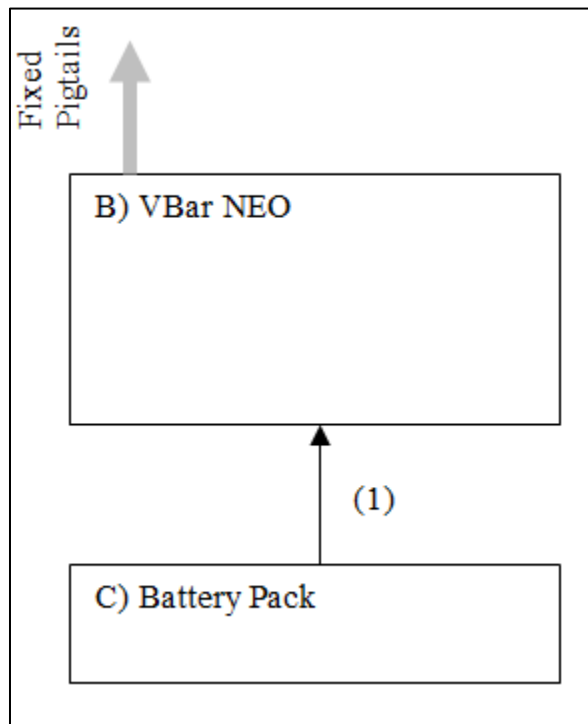

Figure 1. Block Diagram of Test Configuration

F. Equipment Configuration

The EUT was set up as outlined in Figure 1, Block Diagram of Test Setup.

G. Support Equipment

Support equipment necessary for the operation and testing of the EUT is included in the following list.

Ref. ID	Name / Description	Manufacturer	Model Number	*Customer Supplied Calibration Data
A	VBar Control Transmitter	Mikado		
B	VBar NEO	Mikado		
C	Battery Pack	-		

The 'Customer Supplied Calibration Data' column will be marked as either not applicable, not available, or will contain the calibration date supplied by the customer.

Table 5. Support Equipment

H. Ports and Cabling Information

Ref. ID	Port name on EUT	Cable Description or reason for no cable	Qty	Length as tested (m)	Max Length (m)	Shielded ? (Y/N)	Termination Box ID & Port Name
1	ESC	3-pol Battery Power	1	0.1		N	Batt

Table 6. Ports and Cabling Information

I. Mode of Operation

There are two operation modes for the user: Bind Mode and Normal operation. For certification purposes a testmode is available, that allows to stop the Frequency hopping, so better parameter measuring is possible.

Bind Mode:

This Mode allows to create a Connection between the VBar Control and the VBar NEO. This allows the user to assign a VBar NEO to an VBar Control (Binding). In Bind Mode, the Power is reduced, so binding is only possible with nearby devices.

Normal Operation:

Once bound, both units operate in normal mode. The User is now able to control the servos in the bound model, and view some telemetry values on the VControls display.

Test Mode:

Same as Normal Operation, but with switched off Frequency Hopping.

Normal Operation is the mode with the highest expected emissions. VBar Control always operates in normal mode after switch on. No other conditions are needed to meet.

VBar NEO needs a VBar Control in Range to operate in normal Mode. (Note: if no VBar Control is in range, the radio cannot send, since it lacks the synchronization).

J. Method of Monitoring EUT Operation

The Transmitter shows if a connection is available. Start and stop of connection in normal Mode is clearly visibly on the mainscreen, additionally sounds are audible if the status changes.

An strength indicator shows the RSSI of the current connection on the VBar Control Display. Additionally a detailed antenna status can be viewed in the "Model Status"

The NEO shows a solid green light if connected.

K. Modifications

a) Modifications to EUT

No modifications were made to the EUT.

b) Modifications to Test Standard

No modifications were made to the test standard.

L. Disposition of EUT

The test sample including all support equipment submitted to the Electro-Magnetic Compatibility Lab for testing was returned to Mikado Model Helicopters GmbH upon completion of testing.

III. Electromagnetic Compatibility Criteria for Intentional Radiators

Electromagnetic Compatibility Criteria for Intentional Radiators

§ 15.203 Antenna Requirement

Test Requirement: § 15.203: An intentional radiator shall be designed to ensure that no antenna other than that furnished by the responsible party shall be used with the device. The use of a permanently attached antenna or of an antenna that uses a unique coupling to the intentional radiator shall be considered sufficient to comply with the provisions of this section. The manufacturer may design the unit so that a broken antenna can be replaced by the user, but the use of a standard antenna jack or electrical connector is prohibited.

The structure and application of the EUT were analyzed to determine compliance with Section 15.203 of the Rules. Section 15.203 states that the subject device must meet at least one of the following criteria:

- a.) Antenna must be permanently attached to the unit.
- b.) Antenna must use a unique type of connector to attach to the EUT.
- c.) Unit must be professionally installed. Installer shall be responsible for verifying that the correct antenna is employed with the unit.

Results: The EUT as tested is compliant the criteria of §15.203. This EUT employs an integrated antenna.

Test Engineer(s): Benjamin Taylor

Test Date(s): June 26, 2018

Gain	Type	Model	Manufacturer
2 dBi	Dual Pigtails – User Replaceable	05063	Mikado Model Helicopters GmbH

Table 7. Antenna List

Electromagnetic Compatibility Criteria for Intentional Radiators

§ 15.247(a)(1) 20 dB Occupied Bandwidth

Test Requirements: § 15.247(a): Operation under the provisions of this section is limited to frequency hopping and digitally modulated intentional radiators that comply with the following provisions:

For systems using digital modulation techniques, the EUT may operate in the 902-928 MHz, 2401-2483.5 MHz and 5725-5850 MHz bands. For DTS, the minimum 6 dB bandwidth shall be at least 500 kHz. For frequency hopping systems, the EUT shall have hopping channel carrier frequencies separated by a minimum of 25 kHz or the 20 dB bandwidth of the hopping channel, whichever is greater.

Test Procedure: The bandwidth of the fundamental frequency was measured with the spectrum analyzer using a RBW approximately equal to 1% of the total emission bandwidth. The 20 dB bandwidth was measured and recorded.

Test Results The EUT was compliant with § 15.247 (a)(2). No anomalies detected.

Test Engineer(s): William Lash

Test Date(s): June 26, 2018

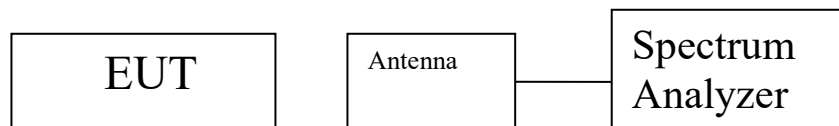
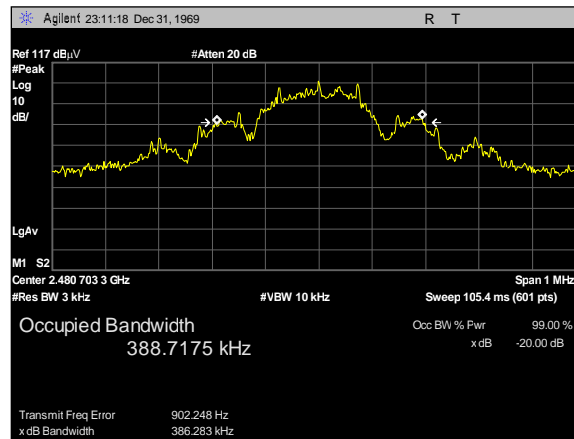

Figure 2. Block Diagram, Occupied Bandwidth Test Setup

Occupied Bandwidth		
Carrier Channel	Frequency (MHz)	Measured 20 dB Bandwidth (MHz)
Low	2401	0.386
Mid	2440	0.394
High	2481	0.393

Table 8. Occupied Bandwidth, Test Results

20 dB Occupied Bandwidth Test Results



Plot 1. 20 dB Occupied Bandwidth, High Channel, final

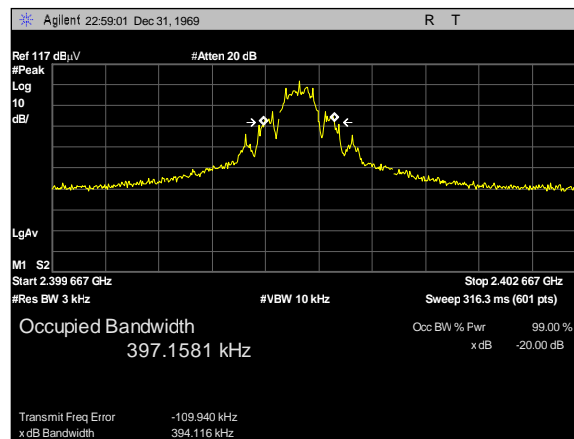

Plot 2. 20 dB Occupied Bandwidth, Low Channel

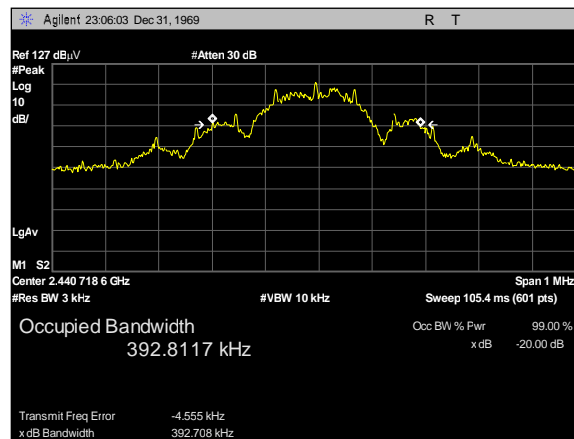

Plot 3. 20 dB Occupied Bandwidth, Mid Channel

Electromagnetic Compatibility Criteria for Intentional Radiators

§ 15.247(a)(1) Average Time of Occupancy (Dwell Time)

Remarks: The average time of occupancy on any frequency shall not be greater than 0.4 seconds within a 20 second period.

Total hopping channels is 80. The EUT meets the specifications of Section 15.247(a) (1) (iii) for Number of Hopping Channels.

Dwell Time							
Frequency Range	No. of Channels	Hopping Period (s)	No. of Burst per Period	Burst duration (s)	Dwell Time (s)	Limit (s)	Margin
2401-2483.5	80	32	19	0.001833	0.034827	0.4	-0.365173

Table 9. Average Time of Occupancy

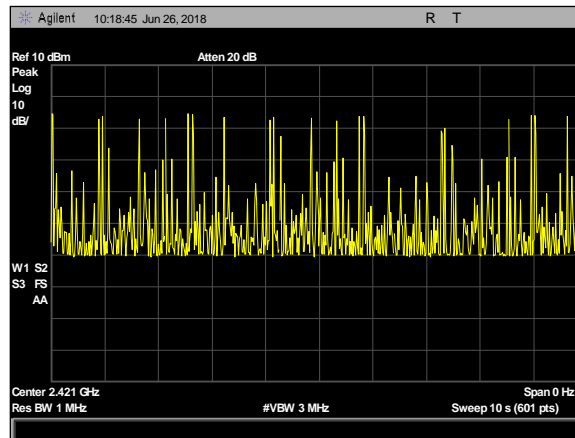

Plot 4. Dwell Time, # of pulses calculation

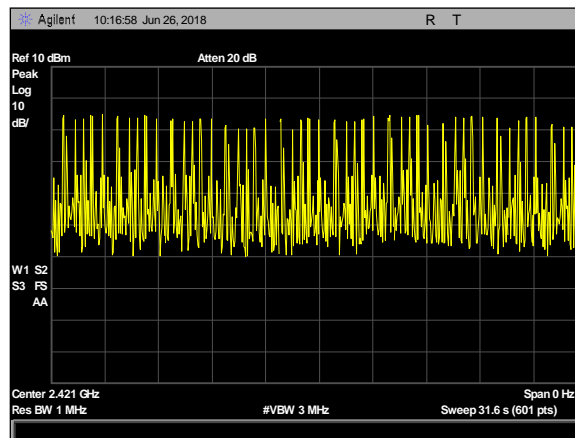

Plot 5. Dwell Time, # of pulses

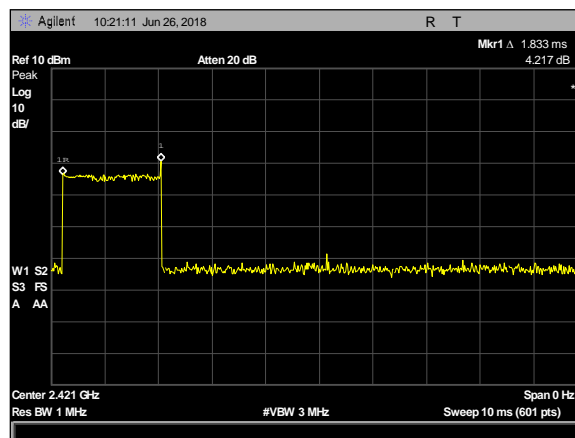

Plot 6. Dwell Time, Pulse Width

Electromagnetic Compatibility Criteria for Intentional Radiators

§ 15.247(a)(1) Number of RF Channels

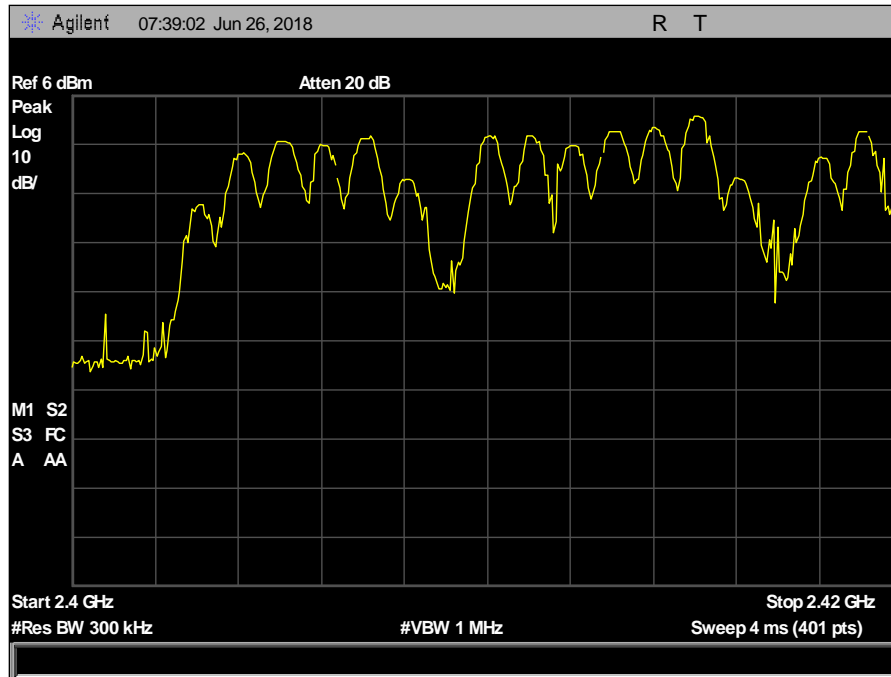

Plot 7. Number of Hopping Channels, 2.4-2.42 GHz

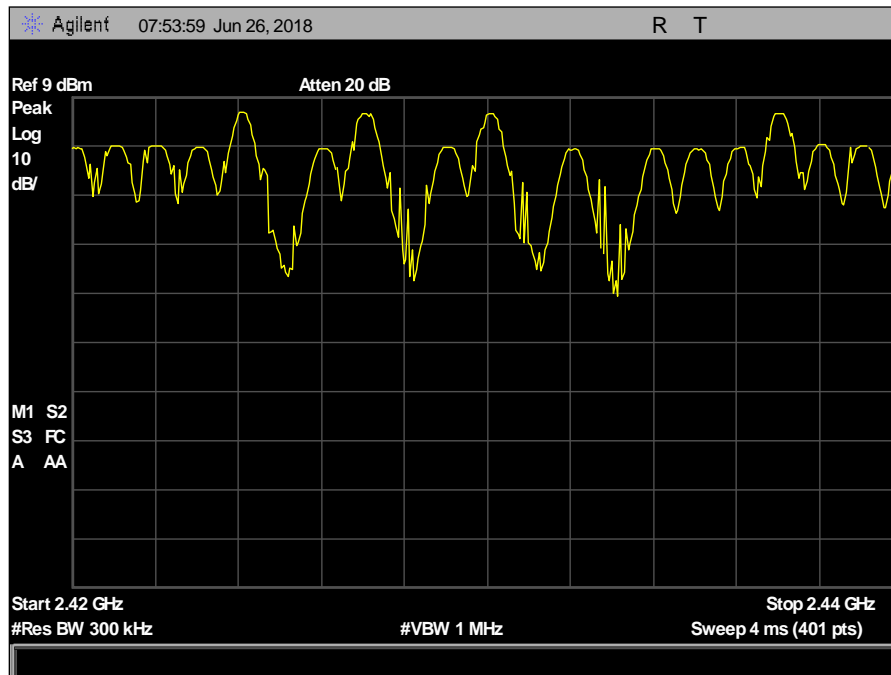

Plot 8. Number of Hopping Channels, 2.42-2.44 GHz

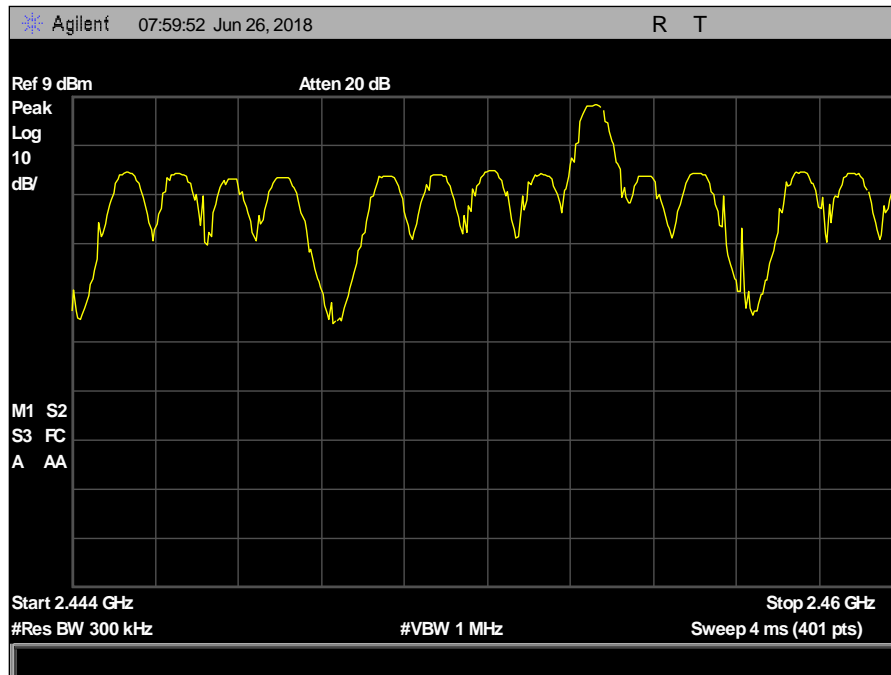

Plot 9. Number of Hopping Channels, 2.44-2.46 GHz

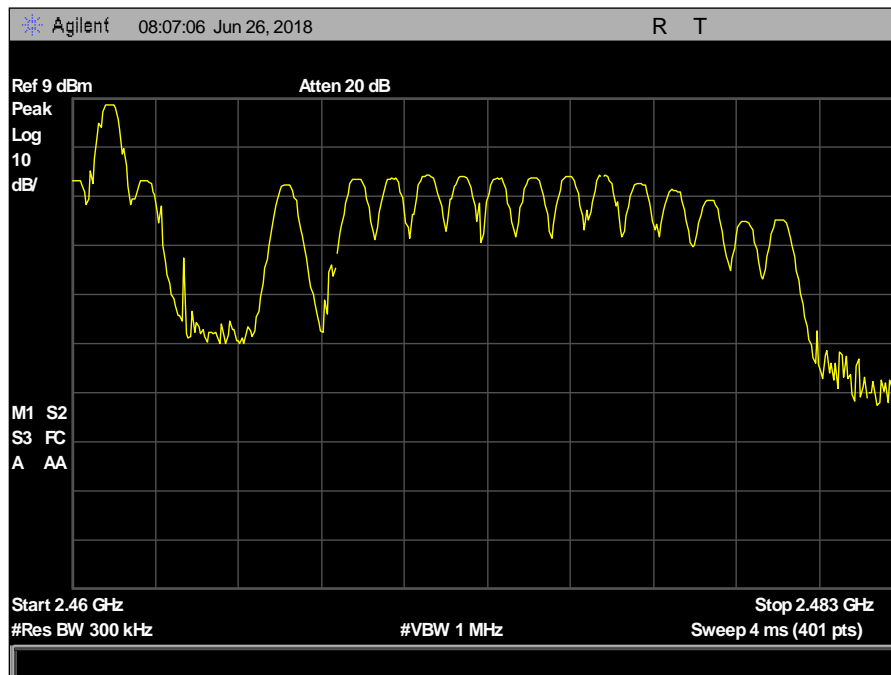

Plot 10. Number of Hopping Channels, 2.46-2.4835 GHz

Electromagnetic Compatibility Criteria for Intentional Radiators

§ 15.247(a)(1) RF Channel Separation

Requirement: Frequency hopping systems shall have hopping channel carrier frequencies separated by a minimum of 25 kHz or the 20 dB bandwidth of the hopping channel, whichever is greater. Alternatively, frequency hopping systems operating in the 2401–2483.5 MHz band may have hopping channel carrier frequencies that are separated by 25 kHz or two-thirds of the 20 dB bandwidth of the hopping channel, whichever is greater, provided the systems operate with an output power no greater than 125 mW.

Remarks: EUT operates below 125mW (20dBm). Channels are separated by more than two thirds of the -20dB Bandwidth.

$$\text{EDR} - 2/3 * 1.393 \text{ MHz (20dB Bandwidth)} = 929 \text{ kHz Minimum Separation Distance}$$

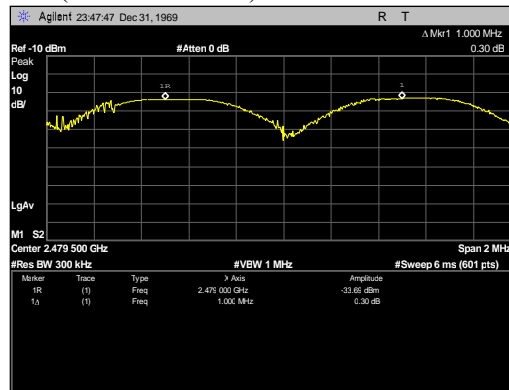

Plot 11. Channel Separation, High Channel

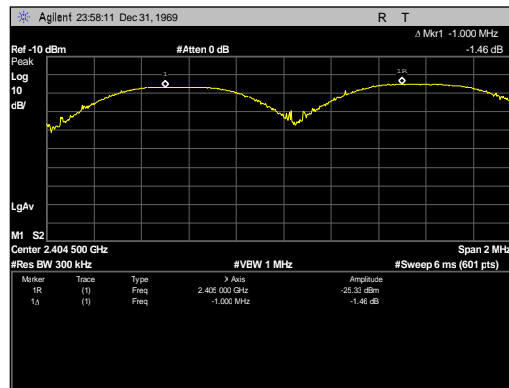

Plot 12. Channel Separation, Low Channel

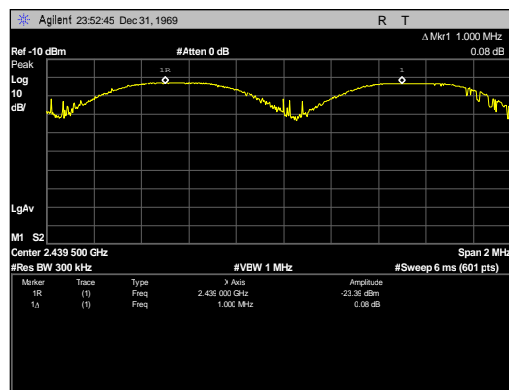

Plot 13. Channel Separation, Mid Channel

Electromagnetic Compatibility Criteria for Intentional Radiators

§ 15.247(b) Peak Power Output

Test Requirements: §15.247(b)(1): The maximum peak output power of the intentional radiator shall not exceed 0.125 Watts for frequency hopping systems operating in the 2401-2483.5 MHz band. .

§15.247(c): if transmitting antennas of directional gain greater than 6 dBi are used the peak output power from the intentional radiator shall be reduced below the stated values, as appropriate, by the amount in dB that the directional gain of the antenna exceeds 6 dBi.

Systems operating in the 2401 – 2483.5 MHz band and using a point to point application may employ transmitting antennas with directional gain greater than 6 dBi provided the maximum peak output power of the intentional radiator is reduced by 1 dB for every 3 dB that the directional gain of the antenna exceeds 6 dBi.

Systems operating in the 5725 – 5850 MHz band that are used exclusively for fixed, point-to-point operations may employ transmitting antennas with directional gain greater than 6 dBi without any corresponding reduction in transmitter peak output power.

Fixed, point-to-point operation excludes the use of point-to-multipoint systems, omnidirectional applications, and multiple co-located intentional radiators transmitting the same information. The operator of the spread spectrum intentional radiator or, if the equipment is professionally installed, the installer is responsible for ensuring that the system is used exclusively for fixed, point-to-point operations. The instruction manual furnished with the intentional radiator shall contain language in the installation instructions informing the operator and the installer of this responsibility.

Test Procedure: The transmitter was broadcasting to a calibrated spectrum analyzer with an antenna. The EUT was measured at the low, mid and high channels of each band. The EUT was utilizes a 2dBi Omni Antenna, so the maximum power allowed is 30dBm.

Test Results: The EUT was compliant with the Peak Power Output limits of §15.247(b). No anomalies detected.

Test Engineer(s): William Lash

Test Date(s): July 25, 2018

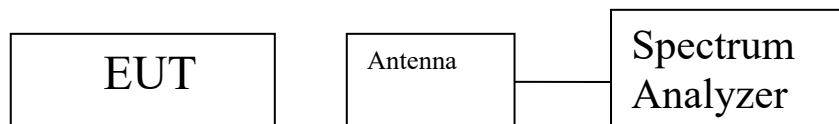
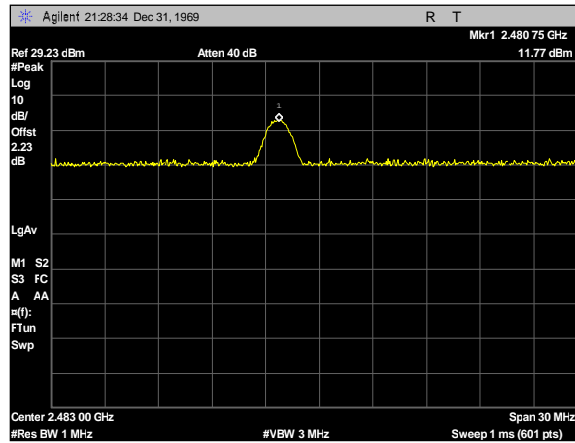

Figure 3. Peak Power Output Test Setup

Peak Radiated Output Power							
Carrier Channel	Frequency (MHz)	Measured Peak Output Power dBm	Antenna Gain (dBi)	Conducted Power Calculation (dBm)	Limit (dBm)	Margin	Result
Low	2401	11.31	2	9.31	30	-20.69	Pass
Mid	2440	18.96	2	16.96	30	-13.04	Pass
High	2481	11.77	2	9.77	30	-20.23	Pass

Table 10. Peak Radiated Output Power, Test Results

Peak Power Output Test Results



Plot 14. Peak Power Output, 11.31dBm, High

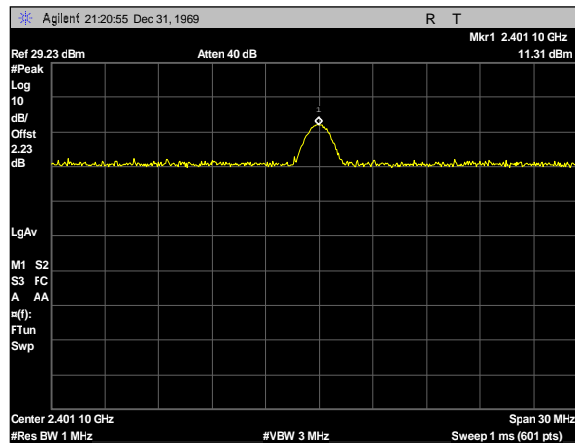

Plot 15. Peak Power Output, 11.31dBm, Low

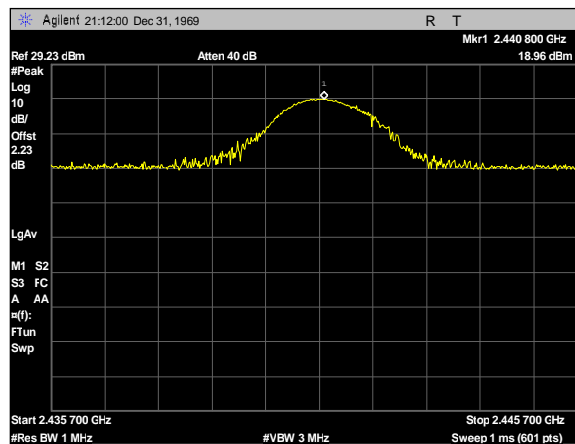

Plot 16. Peak Power Output, 18.96dBm, Mid

Electromagnetic Compatibility Criteria for Intentional Radiators

§ 15.247(d) Radiated Spurious Emissions Requirements and Band Edge

Test Requirements: §15.247(d); §15.205: Emissions outside the frequency band.

§15.247(d): In any 100 kHz bandwidth outside the frequency band in which the spread spectrum or digitally modulated intentional radiator is operating, the radio frequency power that is produced by the intentional radiator shall be at least 20 dB below that in the 100 kHz bandwidth within the band that contains the highest level of the desired power, based on either an RF conducted or a radiated measurement. Attenuation below the general limits specified in § 15.209(a) is not required. In addition, radiated emissions which fall in the restricted bands, as defined in § 15.205(a), must also comply with the radiated emission limits specified in § 15.209(a).

§15.205(a): Except as shown in paragraph (d) of this section, only spurious emissions are permitted in any of the frequency bands listed below:

MHz	MHz	MHz	GHz
0.090–0.110-----	16.42–16.423	399.9–410	4.5–5.15
¹ 0.495–0.505-----	16.69475–16.69525	608–614	5.35–5.46
2.1735–2.1905-----	16.80425–16.80475	960–1240	7.25–7.75
4.125–4.128-----	25.5–25.67	1300–1427	8.025–8.5
4.17725–4.17775-----	37.5–38.25	1435–1626.5	9.0–9.2
4.20725–4.20775-----	73–74.6	1645.5–1646.5	9.3–9.5
6.215–6.218-----	74.8–75.2	1660–1710	10.6–12.7
6.26775–6.26825-----	108–121.94	1718.8–1722.2	13.25–13.4
6.31175–6.31225-----	123–138	2200–2300	14.47–14.5
8.291–8.294-----	149.9–150.05	2310–2390	15.35–16.2
8.362–8.366-----	156.52475–156.52525	2483.5–2500	17.7–21.4
8.37625–8.38675-----	156.7–156.9	2655–2900	22.01–23.12
8.41425–8.41475-----	162.0125–167.17	3260–3267	23.6–24.0
12.29–12.293-----	167.72–173.2	3332–3339	31.2–31.8
12.51975–12.52025-----	240–285	3345.8–3358.36	43–36.5
12.57675–12.57725-----	322–335.4	3600–4400	(²)

Table 11. Restricted Bands of Operation

¹ Until February 1, 1999, this restricted band shall be 0.490 – 0.510 MHz.

² Above 38.6

Test Requirement(s): § 15.209 (a): Except as provided elsewhere in this subpart, the emissions from an intentional radiator shall not exceed the field strength levels specified in Table 12.

Frequency (MHz)	§ 15.209(a), Radiated Emission Limits (dBµV) @ 3m
30 - 88	40.00
88 - 216	43.50
216 - 960	46.00
Above 960	54.00

Table 12. Radiated Emissions Limits Calculated from FCC Part 15, § 15.209 (a)

Test Procedure: The transmitter was set to the mid channel at the highest output power and placed on a 0.8 m high wooden table inside in a semi-anechoic chamber. Measurements were performed with the EUT rotated 360 degrees and varying the adjustable antenna mast with 1 m to 4 m height to determine worst case orientation for maximum emissions. Measurement were repeated the measurement at the low and highest channels.

For frequencies from 30 MHz to 1 GHz, measurements were made using a quasi-peak detector with a 120 kHz bandwidth.

For intentional radiators with a digital device portion which operates below 10 GHz, the spectrum was investigated as per §15.33(a)(1) and §15.33(a)(4); i.e., the lowest RF signal generated or used in the device up to the 10th harmonic of the highest fundamental frequency or to 40 GHz, whichever is lower.

In accordance with §15.35(b) the limit on the radio frequency emissions as measured using instrumentation with a peak detector function shall be 20 dB above the maximum permitted average limit for the frequency being investigated unless a different peak emission limit is otherwise specified in the rules.

EUT Field Strength Final Amplitude = Raw Amplitude – Preamp gain + Antenna Factor + Cable Loss – Distance Correction Factor

Test Results: The EUT was compliant with the Radiated Spurious Emission limits of §15.247(d). No anomalies detected.

Test Engineer(s): William Lash

Test Date(s): July 27, 2018

Radiated Spurious Emissions Test Results

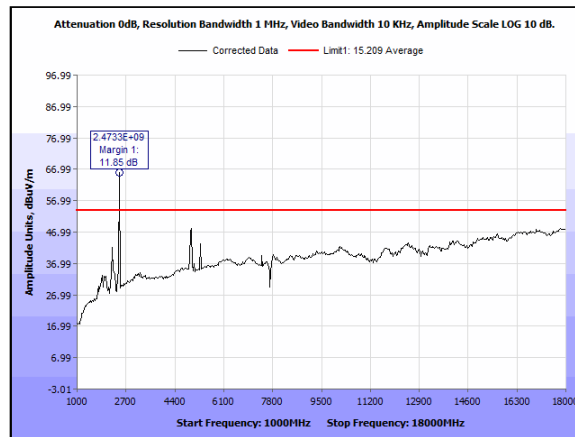

Plot 17. Radiated Emissions, Average, 1 – 18 GHz, High Channel

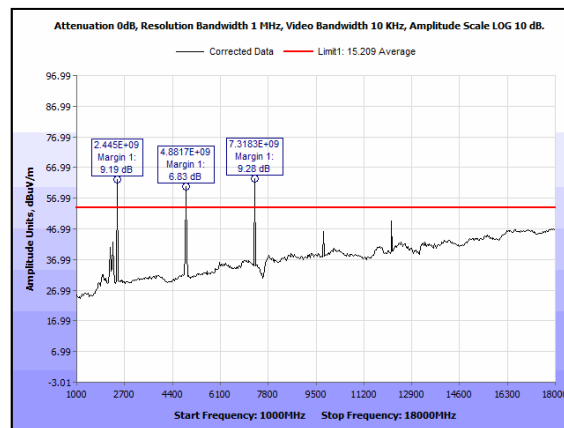

Plot 18. Radiated Emissions, Average, 1 – 18 GHz, Mid Channel

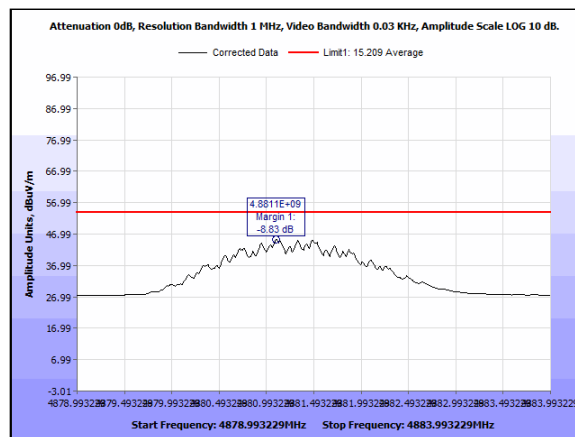

Plot 19. Radiated Emissions, Average, Mid Channel, Zoom, 4800 MHz

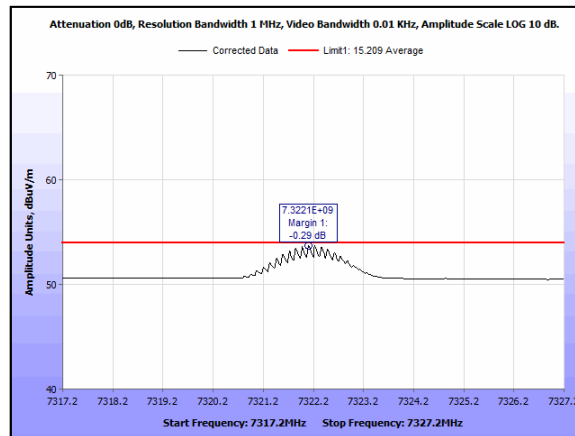

Plot 20. Radiated Emissions, Average, Mid Channel, Zoom, 7320 MHz

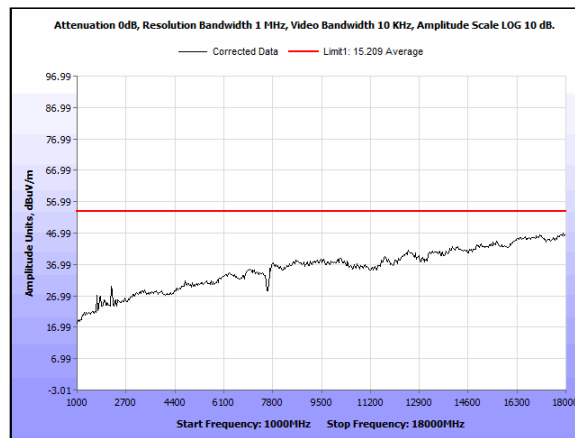

Plot 21. Radiated Emissions, Average, 1 – 18 GHz, Low Channel,

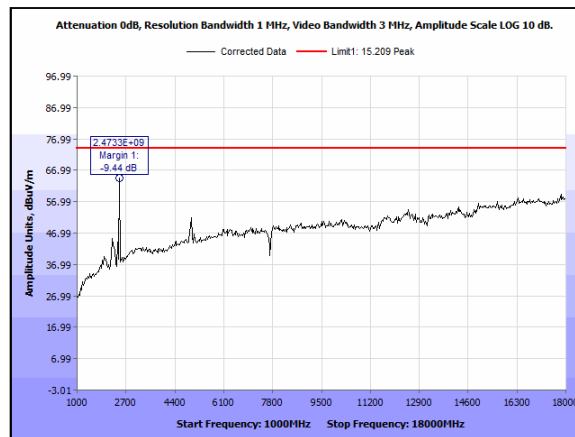

Plot 22. Radiated Emissions, Peak, 1 – 18 GHz, High Channel

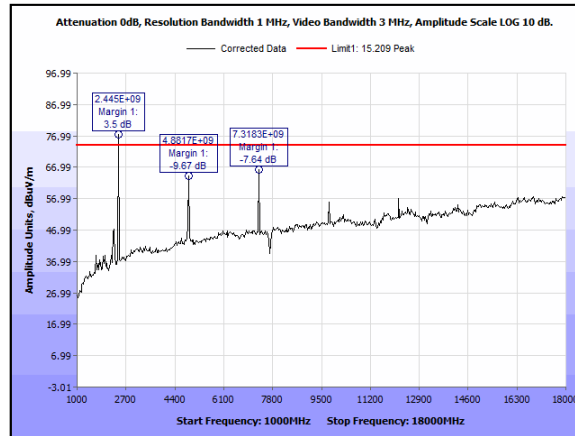

Plot 23. Radiated Emissions, Peak, 1 – 18 GHz, Mid Channel

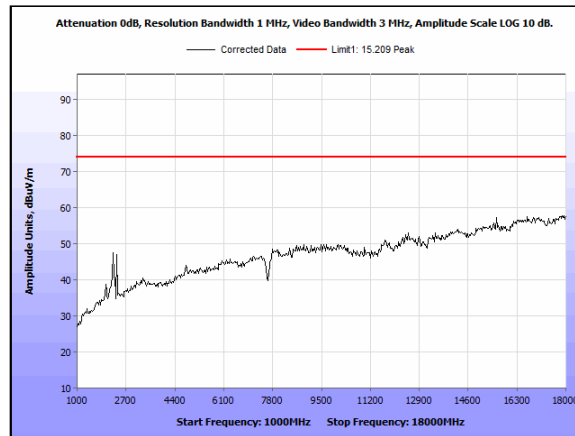

Plot 24. Radiated Emissions, Peak, 1 – 18 GHz, Low Channel

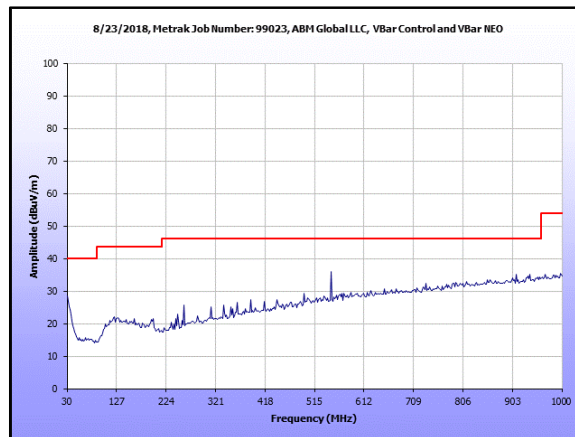

Plot 25. Radiated Emissions, 15.209, 30 MHz - 1 GHz, prescan, Low

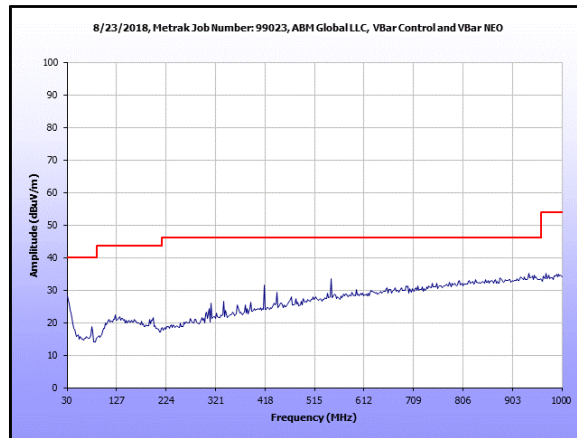

Plot 26. Radiated Emissions, 15.209, 30 MHz - 1 GHz, prescan, Mid

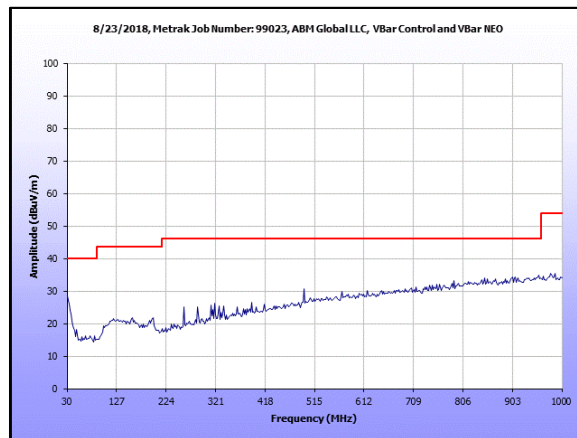

Plot 27. Radiated Emissions, 15.209, 30 MHz - 1 GHz, prescan, High

Radiated Band Edge Measurements

Test Procedures: The transmitter was turned. Measurements were performed of the low and high Channels. The EUT was rotated orthogonally through all three axes. Plots shown are corrected for both antenna correction factor and distance.

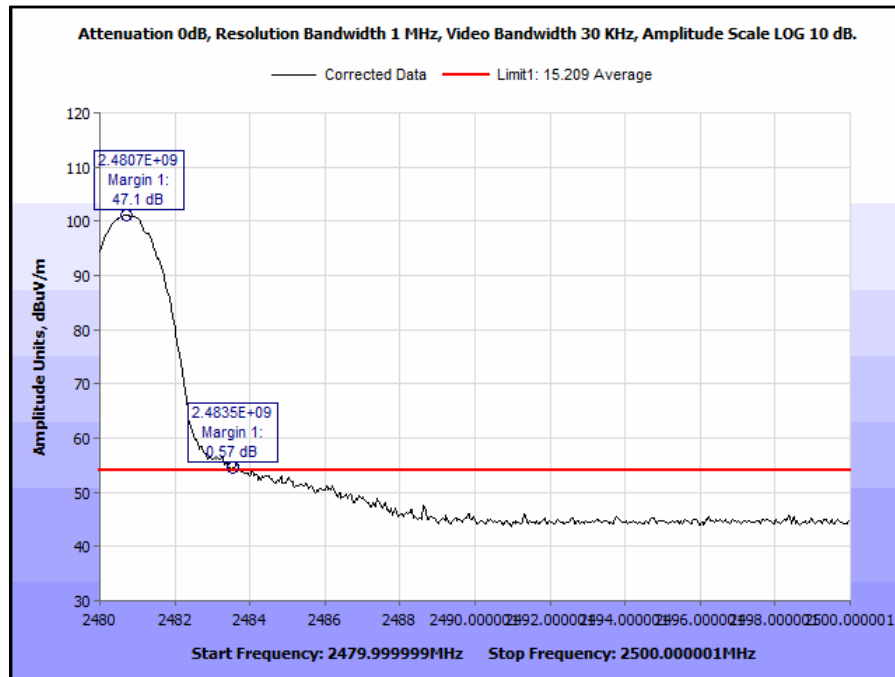

Plot 28. Radiated Band Edge, High, Average

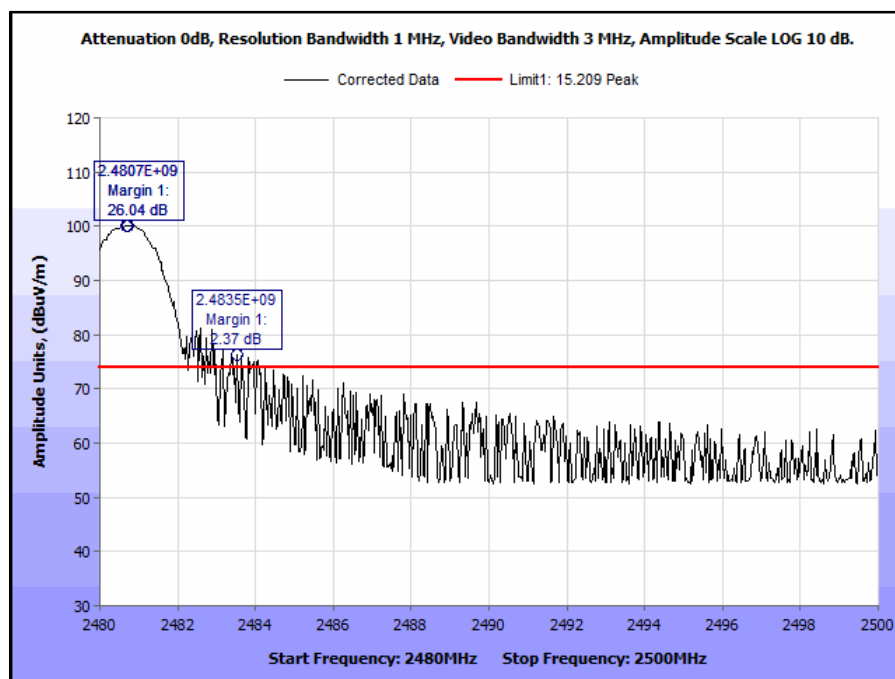

Plot 29. Radiated Band Edge, High, Peak

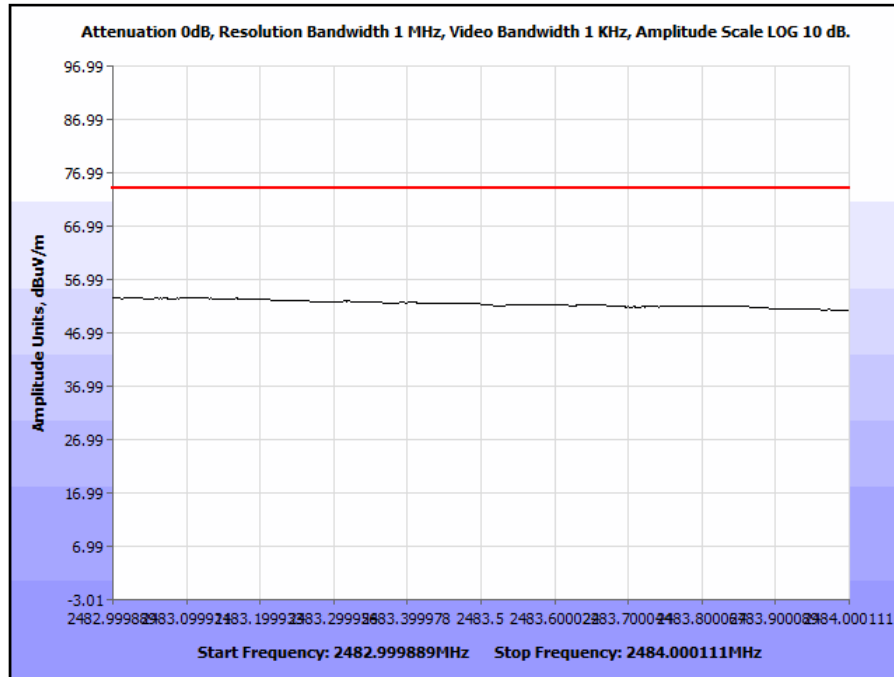

Plot 30. Radiated Band Edge, 2483.5 Zoom

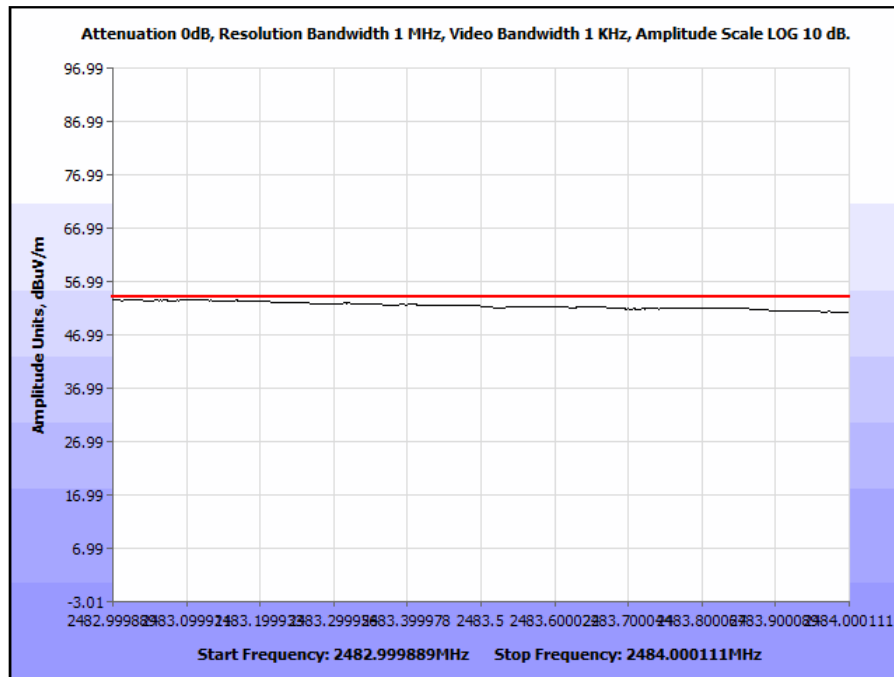

Plot 31. Radiated Band Edge, 2483.5 Zoom

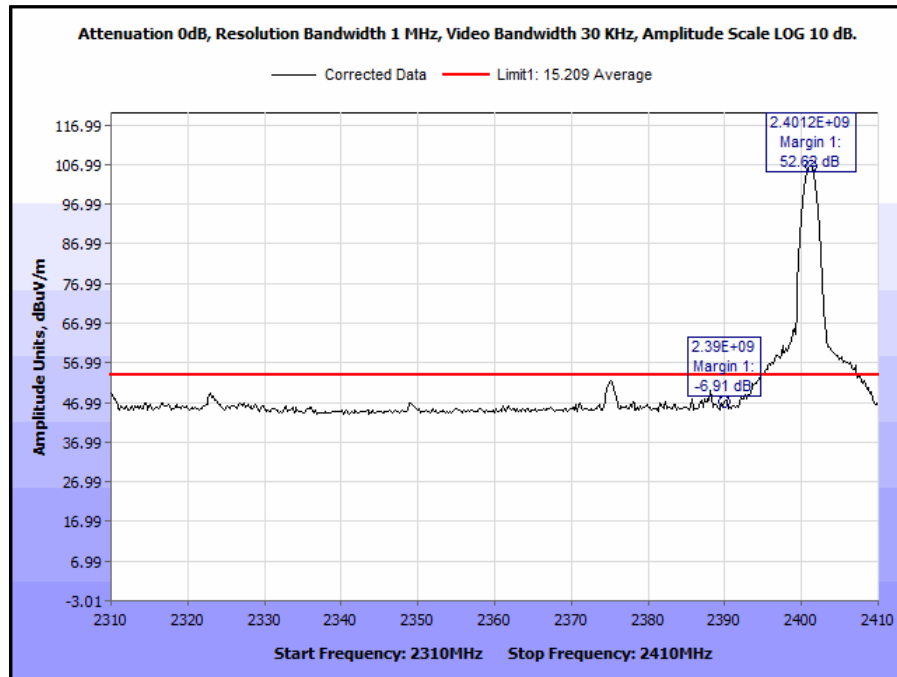

Plot 32. Radiated Band Edge, Low, Average

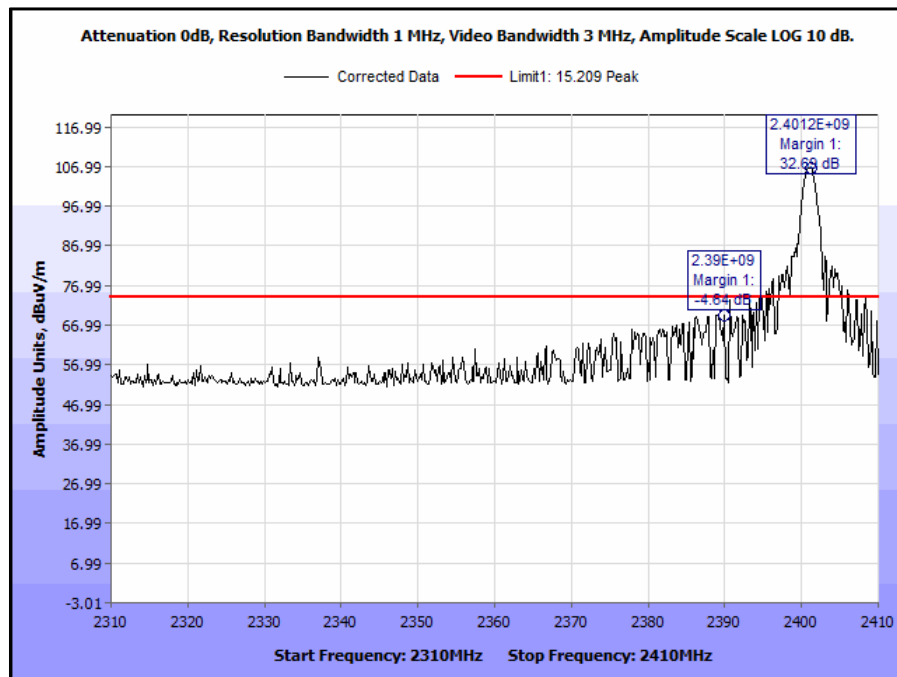

Plot 33. Radiated Band Edge, Low, Peak

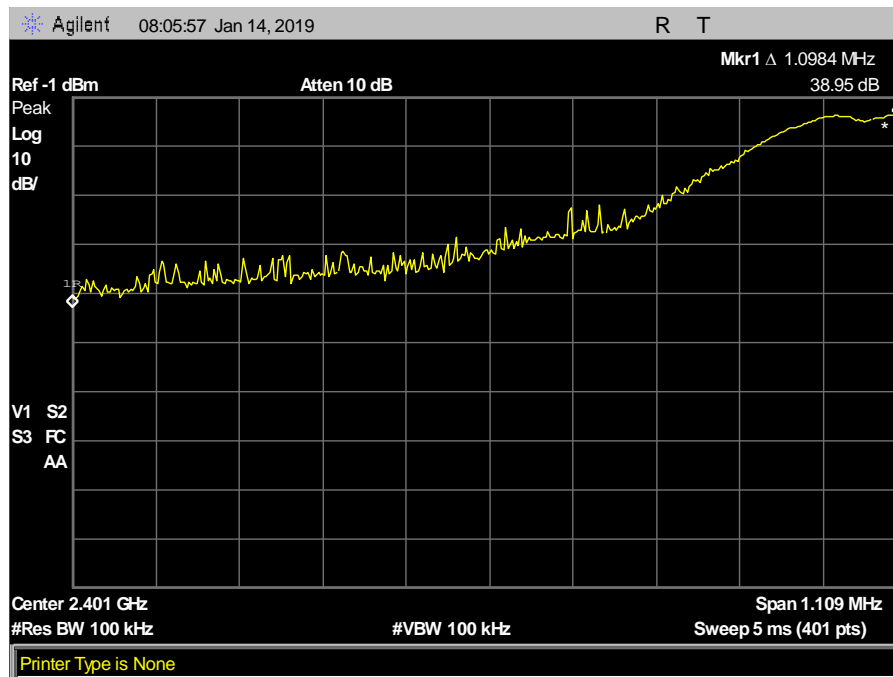

Plot 34. Radiated Band Edge, Low Channel

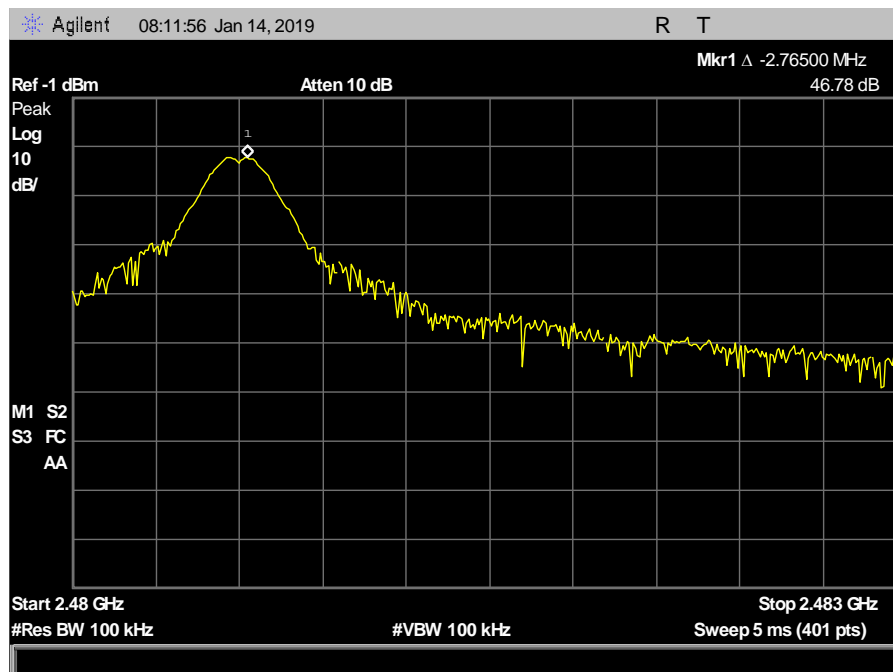

Plot 35. Radiated Band Edge, High Channel

Radiated Spurious Emissions Test Setup



Photograph 1. Radiated Spurious Emissions, Above 1 GHz, Test Setup

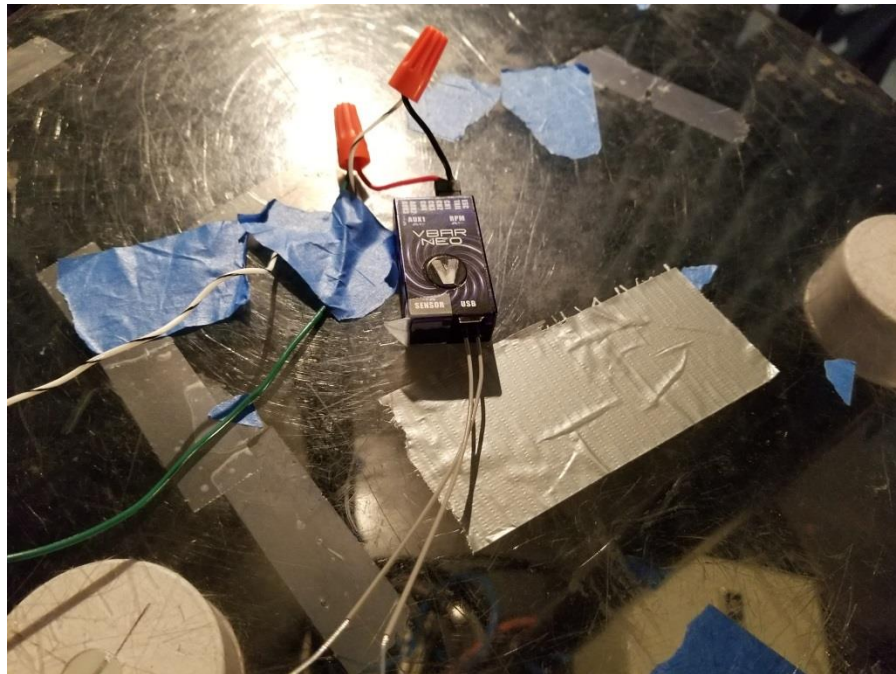

Photograph 2. Radiated Spurious Emissions, Close up, Test Setup



Photograph 2. Radiated Spurious Emissions, Below 1 GHz, Test Setup

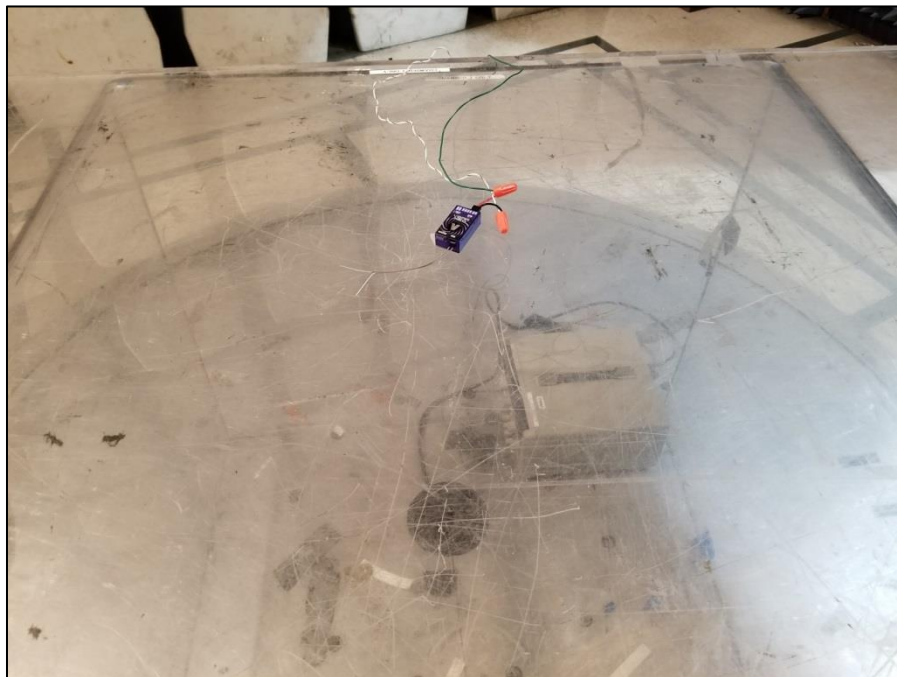

Photograph 2. Radiated Spurious Emissions, Below 1 GHz, Zoom

Electromagnetic Compatibility Criteria for Intentional Radiators
§ 15.247(g)(h) Declaration Statements for FHSS

FHSS Declaration Statement

This device (FCC ID: 2ABXHVBCTX10, 2ABXHVBCRX10 and 2ABXHVBCRX20) complies with the following Part 15 regulations.

15.247(a)(1)

- the hopping sequence must be pseudorandom
- all channels are used equally on average
- the receiver input bandwidth is approximately equal to the transmitter bandwidth
- the receiver hops in sequence with the transmitted signal

15.247(g) the system is designed to comply with all of the regulations in Section 15.247 when the transmitter is presented with a continuous data (or information)

15.247(h) the system does not coordinate its channel selection/hopping sequence with other frequency hopping systems for the express purpose of avoiding the simultaneous occupancy of individual hopping frequencies by multiple transmitters

Electromagnetic Compatibility Criteria for Intentional Radiators

§ 15.247(i) Maximum Permissible Exposure

RF Exposure Requirements: §1.1307(b)(1) and §1.1307(b)(2): Systems operating under the provisions of this section shall be operated in a manner that ensures that the public is not exposed to radio frequency energy levels in excess of the Commission’s guidelines.

RF Radiation Exposure Limit: §1.1310: As specified in this section, the Maximum Permissible Exposure (MPE) Limit shall be used to evaluate the environmental impact of human exposure to radiofrequency (RF) radiation as specified in Sec. 1.1307(b), except in the case of portable devices which shall be evaluated according to the provisions of Sec. 2.1093 of this chapter.

MPE Limit Calculation: EUT’s operating frequencies @ 2401-2483.5 MHz; highest conducted power = 16.18dBm (peak) therefore, **Limit for Uncontrolled exposure: 1 mW/cm² or 10 W/m²**

EUT maximum antenna gain = 2 dBi.

Equation from page 18 of OET 65, Edition 97-01

$$S = PG / 4\pi R^2 \quad \text{or} \quad R = \sqrt{PG / 4\pi S}$$

where, S = Power Density (0.02482mW/cm²)
P = Power Input to antenna (78.705mW)
G = Antenna Gain (1.585 numeric)

$$R = (49.659 * 1.585 / 4 * 3.14 * 0.01566)^{1/2} = (78.70 / .1966)^{1/2} = 20\text{cm}$$

FCC									
Frequency (MHz)	Con. Pwr. (dBm)	Con. Pwr. (mW)	Ant. Gain (dBi)	Ant. Gain numeric	Pwr. Density (mW/cm ²)	Limit (mW/cm ²)	Margin	Distance (cm)	Result
2435.7	16.96	49.659	2	1.585	0.01566	1	0.98434	20	Pass

Note: Only radiated samples were submitted.

IV. Test Equipment

Test Equipment

Calibrated test equipment utilized during testing was maintained in a current state of calibration per the requirements of ISO/IEC 17025:2005.

MET Asset #	Equipment	Manufacturer	Model	Last Cal Date	Cal Due Date
1T4149	High-Frequency Anechoic Chamber	Ray Proof	81	N/A	N/A
1T4771	PSA Spectrum Analyzer	Agilent Technologies	E4446A	05/16/2018	11/16/2019
1T4483	Antenna; Horn	ETS-Lindgren	3117	04/19/2017	10/19/2018
1T8818	Spectrum Analyzer	Agilent Technologies	E4407B	06/04/2018	06/04/2019
1T4409	EMI Receiver	Rohde & Schwarz	ESIB7	12/07/2016	12/07/2018
1T4751	Antenna - Bilog	Sunol Sciences	JB6	02/28/2017	08/28/2018
1T4300A	SEMI-ANECHOIC CHAMBER # 1 (FCC)	EMC TEST SYSTEMS	NONE	01/31/2016	01/31/2019

Table 13. Test Equipment List

Note: Functionally tested equipment is verified using calibrated instrumentation at the time of testing.

V. Certification & User's Manual Information

Certification & User's Manual Information

A. Certification Information

The following is extracted from Title 47 of the Code of Federal Regulations, Part 2, Subpart I — Marketing of Radio frequency devices:

§ 2.801 Radio-frequency device defined.

As used in this part, a radio-frequency device is any device which in its operation is capable of Emitting radio-frequency energy by radiation, conduction, or other means. Radio- frequency devices include, but are not limited to:

- (a) The various types of radio communication transmitting devices described throughout this chapter.
- (b) *The incidental, unintentional and intentional radiators defined in Part 15 of this chapter.*
- (c) The industrial, scientific, and medical equipment described in Part 18 of this chapter.
- (d) Any part or component thereof which in use emits radio-frequency energy by radiation, conduction, or other means.

§ 2.803 Marketing of radio frequency devices prior to equipment authorization.

- (a) Except as provided elsewhere in this chapter, no person shall sell or lease, or offer for sale or lease (including advertising for sale or lease), or import, ship or distribute for the purpose of selling or leasing or offering for sale or lease, any radio frequency device unless:
 - (1) In the case of a device subject to certification, such device has been authorized by the Commission in accordance with the rules in this chapter and is properly identified and labeled as required by §2.925 and other relevant sections in this chapter; or
 - (2) In the case of a device that is not required to have a grant of equipment authorization issued by the Commission, but which must comply with the specified technical standards prior to use, such device also complies with all applicable administrative (including verification of the equipment or authorization under a Declaration of Conformity, where required), technical, labeling and identification requirements specified in this chapter.
- (d) Notwithstanding the provisions of paragraph (a) of this section, the offer for sale solely to business, commercial, industrial, scientific or medical users (but not an offer for sale to other parties or to end users located in a residential environment) of a radio frequency device that is in the conceptual, developmental, design or pre-production stage is permitted prior to equipment authorization or, for devices not subject to the equipment authorization requirements, prior to a determination of compliance with the applicable technical requirements *provided* that the prospective buyer is advised in writing at the time of the offer for sale that the equipment is subject to the FCC rules and that the equipment will comply with the appropriate rules before delivery to the buyer or to centers of distribution.

- (e)(1) Notwithstanding the provisions of paragraph (a) of this section, prior to equipment authorization or determination of compliance with the applicable technical requirements any radio frequency device may be operated, but not marketed, for the following purposes and under the following conditions:
- (i) *Compliance testing*;
 - (ii) Demonstrations at a trade show provided the notice contained in paragraph (c) of this section is displayed in a conspicuous location on, or immediately adjacent to, the device;
 - (iii) Demonstrations at an exhibition conducted at a business, commercial, industrial, scientific or medical location, but excluding locations in a residential environment, provided the notice contained in paragraphs (c) or (d) of this section, as appropriate, is displayed in a conspicuous location on, or immediately adjacent to, the device;
 - (iv) Evaluation of product performance and determination of customer acceptability, provided such operation takes place at the manufacturer's facilities during developmental, design or pre-production states; or
 - (v) Evaluation of product performance and determination of customer acceptability where customer acceptability of a radio frequency device cannot be determined at the manufacturer's facilities because of size or unique capability of the device, provided the device is operated at a business, commercial, industrial, scientific or medical user's site, but not at a residential site, during the development, design or pre-production stages.
- (e)(2) For the purpose of paragraphs (e)(1)(iv) and (e)(1)(v) of this section, the term *manufacturer's facilities* includes the facilities of the party responsible for compliance with the regulations and the manufacturer's premises, as well as the facilities of other entities working under the authorization of the responsible party in connection with the development and manufacture, but not the marketing, of the equipment.
- (f) For radio frequency devices subject to verification and sold solely to business, commercial, industrial, scientific and medical users (excluding products sold to other parties or for operation in a residential environment), parties responsible for verification of the devices shall have the option of ensuring compliance with the applicable technical specifications of this chapter at each end user's location after installation, provided that the purchase or lease agreement includes a proviso that such a determination of compliance be made and is the responsibility of the party responsible for verification of the equipment.

Certification & User's Manual Information

The following is extracted from Title 47 of the Code of Federal Regulations, Part 2, Subpart J — Equipment Authorization Procedures:

§ 2.901 Basis and Purpose

- (a) In order to carry out its responsibilities under the Communications Act and the various treaties and international regulations, and in order to promote efficient use of the radio spectrum, the Commission has developed technical standards for radio frequency equipment and parts or components thereof. The technical standards applicable to individual types of equipment are found in that part of the rules governing the service wherein the equipment is to be operated.¹ *In addition to the technical standards provided, the rules governing the service may require that such equipment be verified by the manufacturer or importer, be authorized under a Declaration of Conformity, or receive an equipment authorization from the Commission by one of the following procedures: certification or registration.*
- (b) The following sections describe the verification procedure, the procedure for a Declaration of Conformity, and the procedures to be followed in obtaining certification from the Commission and the conditions attendant to such a grant.

§ 2.907 Certification.

- (a) Certification is an equipment authorization issued by the Commission, based on representation and test data submitted by the applicant.
- (b) Certification attaches to all units subsequently marketed by the grantee which are identical (see Section 2.908) to the sample tested except for permissive changes or other variations authorized by the Commission pursuant to Section 2.1043.

¹ In this case, the equipment is subject to the rules of Part 15. More specifically, the equipment falls under Subpart B (of Part 15), which deals with unintentional radiators.

Certification & User's Manual Information

§ 2.948 Description of measurement facilities.

- (a) Each party making measurements of equipment that is subject to an equipment authorization under Part 15 or Part 18 of this chapter, regardless of whether the measurements are filed with the Commission or kept on file by the party responsible for compliance of equipment marketed within the U.S. or its possessions, shall compile a description of the measurement facilities employed.
- (1) If the measured equipment is subject to the verification procedure, the description of the measurement facilities shall be retained by the party responsible for verification of the equipment.
- (i) *If the equipment is verified through measurements performed by an independent laboratory, it is acceptable for the party responsible for verification of the equipment to rely upon the description of the measurement facilities retained by or placed on file with the Commission by that laboratory. In this situation, the party responsible for the verification of the equipment is not required to retain a duplicate copy of the description of the measurement facilities.*
- (ii) If the equipment is verified based on measurements performed at the installation site of the equipment, no specific site calibration data is required. It is acceptable to retain the description of the measurement facilities at the site at which the measurements were performed.
- (2) If the equipment is to be authorized by the Commission under the certification procedure, the description of the measurement facilities shall be filed with the Commission's Laboratory in Columbia, Maryland. The data describing the measurement facilities need only be filed once but must be updated as changes are made to the measurement facilities or as otherwise described in this section. At least every three years, the organization responsible for filing the data with the Commission shall certify that the data on file is current.

Certification & User's Manual Information

1. Label and User's Manual Information

The following is extracted from Title 47 of the Code of Federal Regulations, Part 15, Subpart A — General:

§ 15.19 Labeling requirements.

(a) *In addition to the requirements in Part 2 of this chapter, a device subject to certification or verification shall be labeled as follows:*

- (1) Receivers associated with the operation of a licensed radio service, e.g., FM broadcast under Part 73 of this chapter, land mobile operation under Part 90, etc., shall bear the following statement in a conspicuous location on the device:

This device complies with Part 15 of the FCC Rules. Operation is subject to the condition that this device does not cause harmful interference.

- (2) A stand-alone cable input selector switch, shall bear the following statement in a conspicuous location on the device:

This device is verified to comply with Part 15 of the FCC Rules for use with cable television service.

- (3) All other devices shall bear the following statement in a conspicuous location on the device:

This device complies with Part 15 of the FCC Rules. Operation is subject to the following two conditions: (1) This device may not cause harmful interference, and (2) this device must accept any interference received, including interference that may cause undesired operation.

- (4) Where a device is constructed in two or more sections connected by wires and marketed together, the statement specified under paragraph (a) of this section is required to be affixed only to the main control unit.

- (5) When the device is so small or for such use that it is not practicable to place the statement specified under paragraph (a) of this section on it, the information required by this paragraph shall be placed in a prominent location in the instruction manual or pamphlet supplied to the user or, alternatively, shall be placed on the container in which the device is marketed. However, the FCC identifier or the unique identifier, as appropriate, must be displayed on the device.

§ 15.21 Information to user.

The users manual or instruction manual for an intentional or unintentional radiator shall caution the user that changes or modifications not expressly approved by the party responsible for compliance could void the user's authority to operate the equipment.

Verification & User's Manual Information

The following is extracted from Title 47 of the Code of Federal Regulations, Part 15, Subpart B — Unintentional Radiators:

§ 15.105 Information to the user.

- (a) For a Class A digital device or peripheral, the instructions furnished the user shall include the following or similar statement, placed in a prominent location in the text of the manual:

Note: This equipment has been tested and found to comply with the limits for a Class A digital device, pursuant to Part 15 of the FCC Rules. These limits are designed to provide reasonable protection against harmful interference when the equipment is operated in a commercial environment. This equipment generates, uses, and can radiate radio frequency energy and, if not installed and used in accordance with the instruction manual, may cause harmful interference to radio communications. Operation of this equipment in a residential area is likely to cause harmful interference in which case the user will be required to correct the interference at own expense.

- (b) For a Class B digital device or peripheral, the instructions furnished the user shall include the following or similar statement, placed in a prominent location in the text of the manual:

Note: This equipment has been tested and found to comply with the limits for a Class B digital device, pursuant to Part 15 of the FCC Rules. These limits are designed to provide reasonable protection against harmful interference when the equipment is operated in a residential environment. This equipment generates, uses, and can radiate radio frequency energy and, if not installed and used in accordance with the instruction manual, may cause harmful interference to radio communications. However, there is no guarantee that interference will not occur in a particular installation. If this equipment does cause harmful interference to radio or television reception, which can be determined by turning the equipment off and on, the user is encouraged to try to correct the interference by one or more of the following measures:

- Reorient or relocate the receiving antenna.
- Increase the separation between the equipment and receiver.
- Connect the equipment into an outlet on a circuit different from that to which the receiver is connected.
- Consult the dealer or an experienced radio/TV technician for help.



End of Report