

SHARED & ASSIGNED USE FUNCTIONALITY

Versa locks with a touch-free activation RFID interface are operated by a RFID Credential or an ADA compliant User Key. Manager Keys provide management access and external power. Programming is accomplished via a Programming Key unique to the lock system. For Advanced Models of Versa, an optional mobile application tool is available to simplify lock system management and provide audit trail.

LOCK ORIENTATION

Mini Front Unit

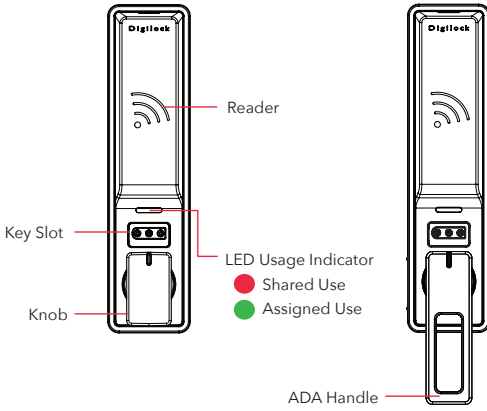

Vertical with Knob on Bottom

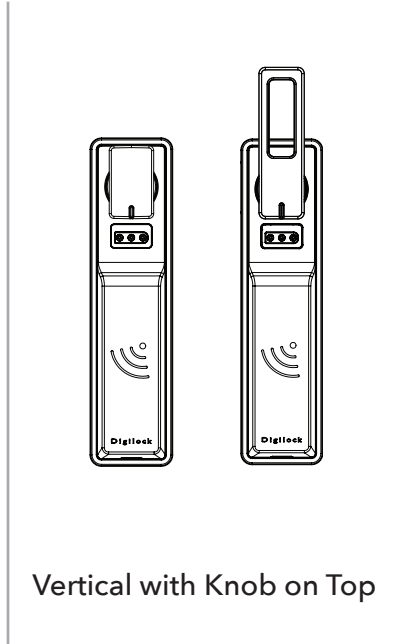

Vertical with Knob on Top

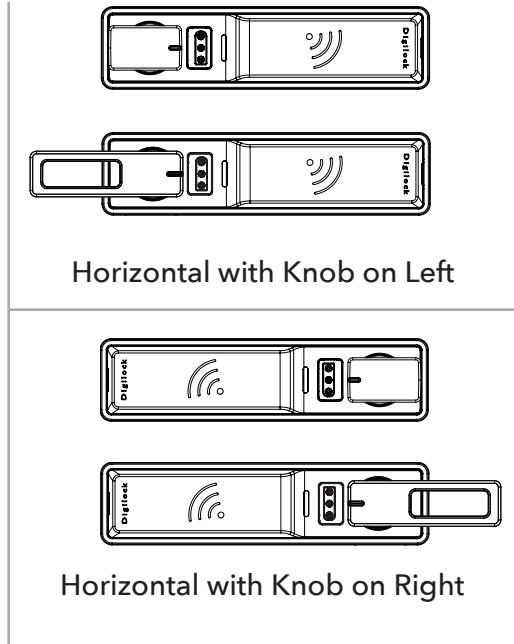

Horizontal with Knob on Left

Horizontal with Knob on Right

Standard Front Unit

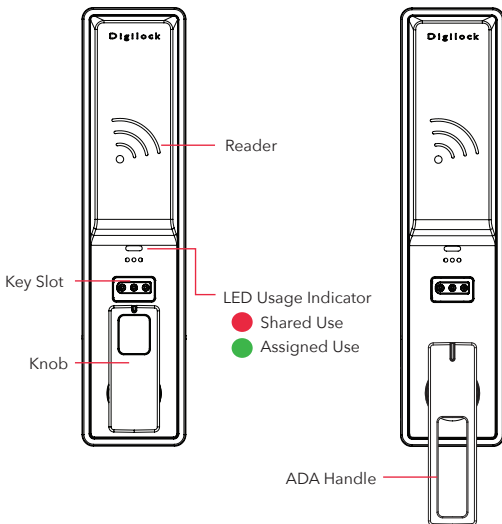

Vertical with Knob on Bottom

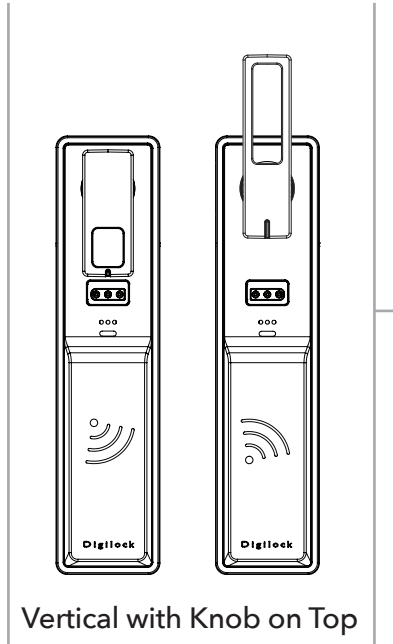

Vertical with Knob on Top

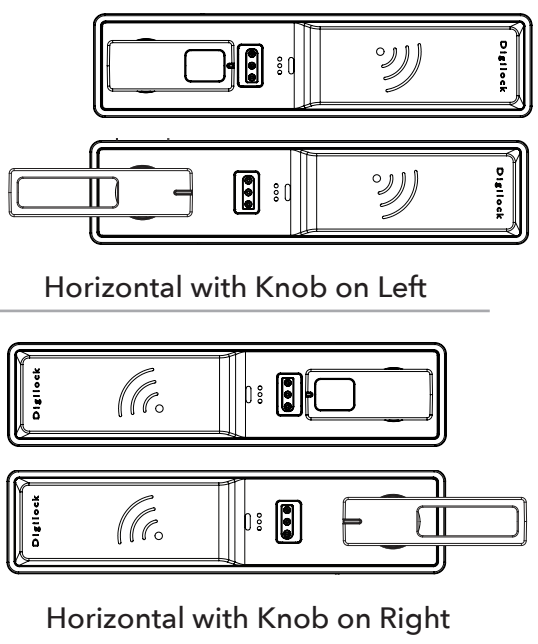

Horizontal with Knob on Left

Horizontal with Knob on Right

LOCK ORIENTATION

Hybrid Front Unit

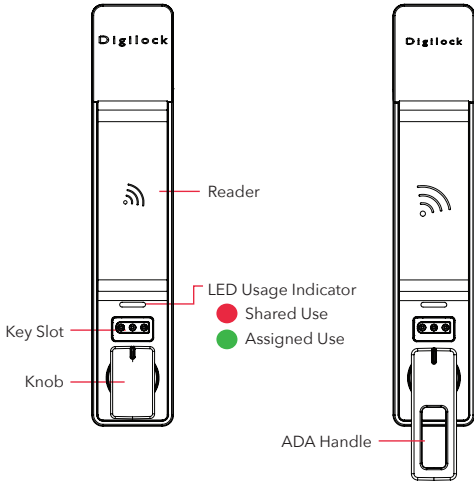

Vertical with Knob on Bottom

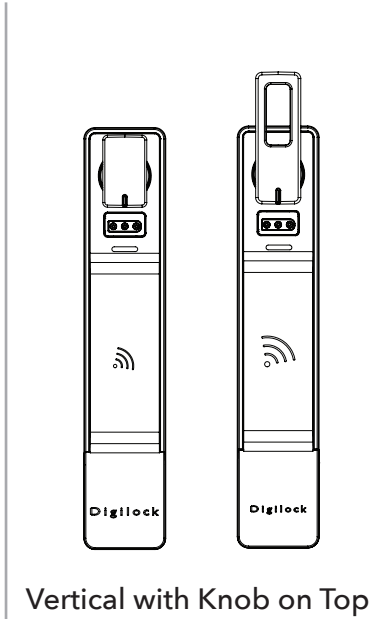

Vertical with Knob on Top

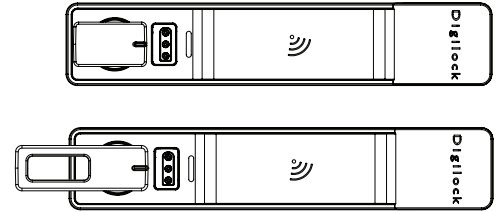

Horizontal with Knob on Left

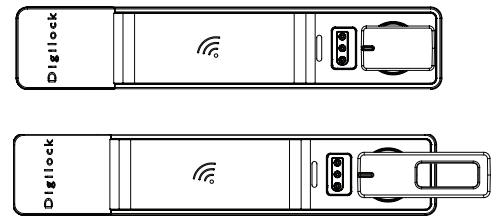

Horizontal with Knob on Right

RFID Credentials

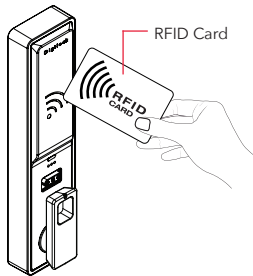

RFID Adhesive Label



RFID Keyfob



RFID Wristband

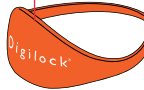

KEYS



User Key



Manager Key¹

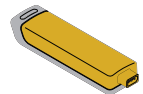

Programming Key²

Operates the lock	•	•	•
Overrides user access		•	•
Allows management inspection		•	•
Provides external power*		•	•
Programs Manager Keys to the lock			•
Assigns user credentials ³ (in assigned use functionality)		•	
Sets lock functionality			•

¹ Up to 6 manager credentials (Manager Key or RFID credential) may be programmed to each lock. If managed with the optional Mobile App, up to 250 Manager Keys may be programmed to each lock.

² 1 Programming Key allowed per lock system.

³ Up to 20 user credentials may be assigned to each lock. If managed with the optional Mobile App, up to 250 user credentials may be assigned to each lock.

KEY INSERTION

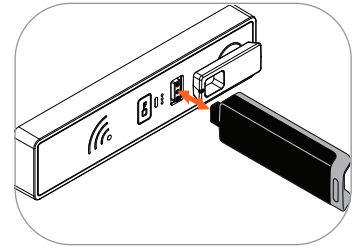
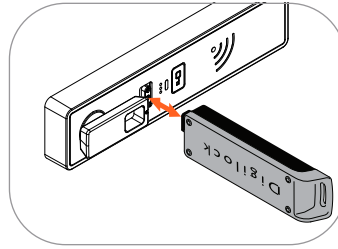
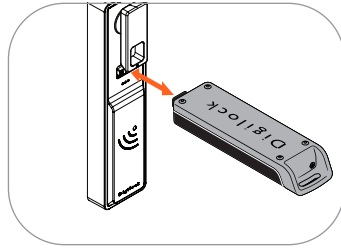
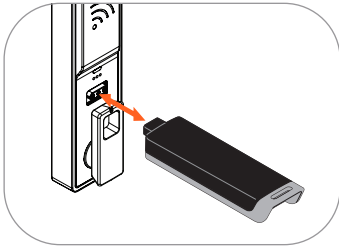

Refer to the above images for proper key insertion.

SETUP

Locks are shipped with factory default settings (only operates by presenting hand to lock). Each lock must be set up to operate with a Programming Key and Manager Credentials (Manager Key or Manager RFID Credential).

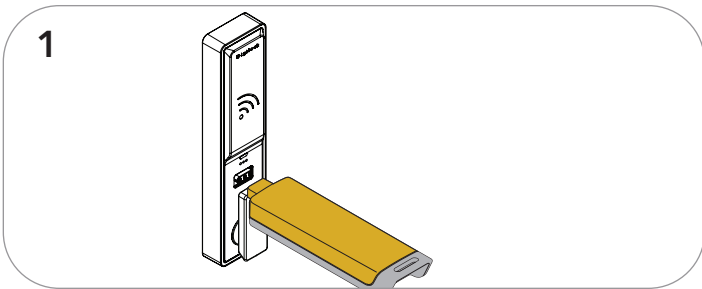

1 Insert the Programming Key.
A two-tone beep will be heard and the LED will turn on.

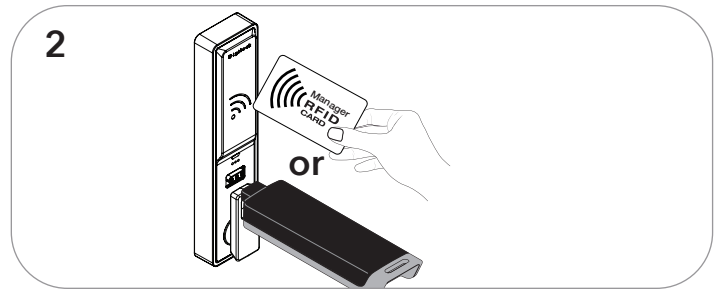

2 While the LED is on, insert one Manager Key or present one Manager RFID Credential at a time.
A two-tone beep will be heard for each Manager Credential programmed.

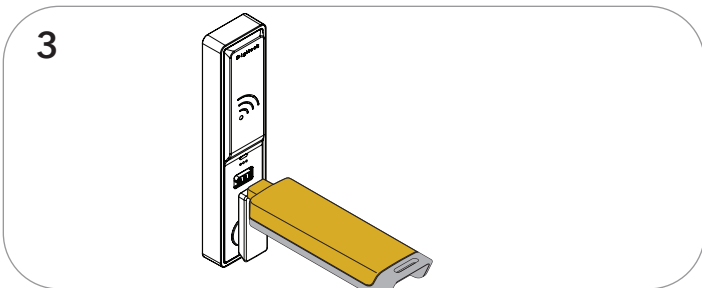

3 Insert the Programming Key.
A two-tone beep will be heard and the LED will turn off.

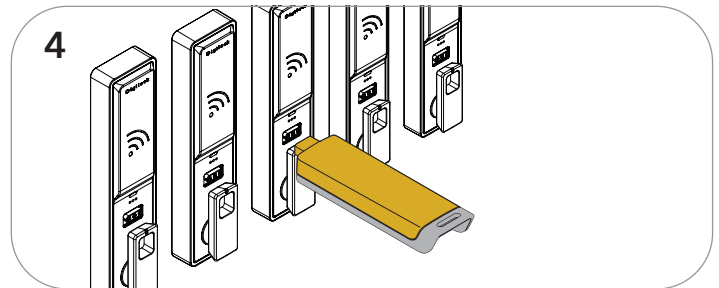

4 Repeat above steps for each lock or follow instructions to [Express Register Manager Credentials](#) to set up all locks.

PROGRAMMING INSTRUCTIONS

Express Register Manager Credentials

The Programming Key can quickly program multiple locks to operate with the same manager credentials.

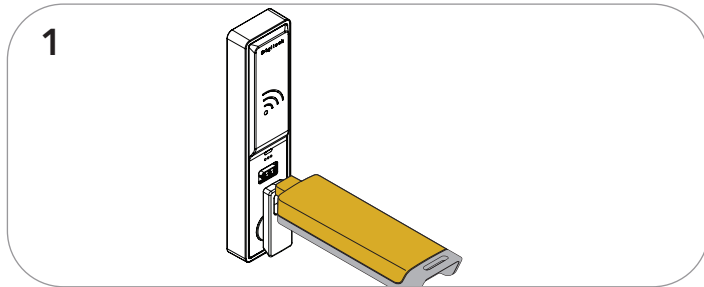

1 Go to a lock already programmed to operate with the manager credentials.
Insert and hold Programming Key in place for 10 seconds (a two-tone beep will be heard after 5 seconds followed by a second set of two-tone beeps after 10 seconds).
The LED will turn on.

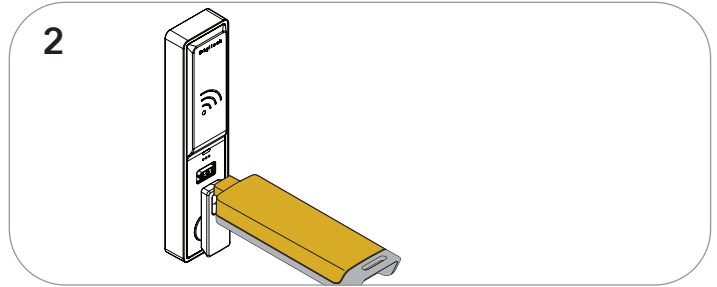

2 Remove key and reinsert key.
A two-tone confirmation beep will be heard and the LED will turn off.

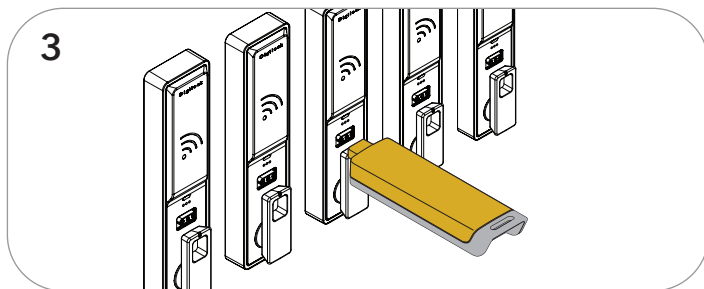

3 Insert the Programming Key to program each lock to operate with the same manager credentials.
Two sets of two-tone beeps will be heard and the LED will flash once to indicate successful programming.

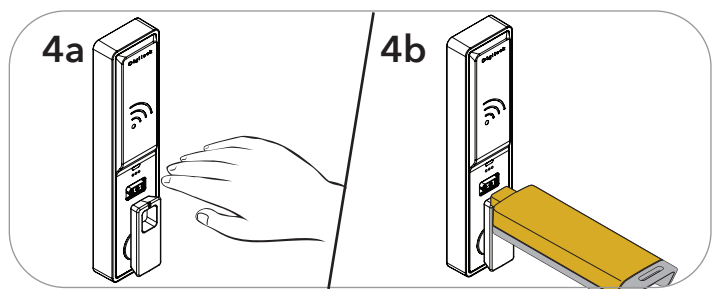

4a End express registration mode.*
Go to any programmed lock.
4b Present hand to lock until a single beep is heard, then insert the Programming Key to operate the lock.

*The Programming Key will continue to function in express registration mode until it is used to operate a lock.

Add Manager Credentials

Manager credentials can be programmed to the locks at any time.

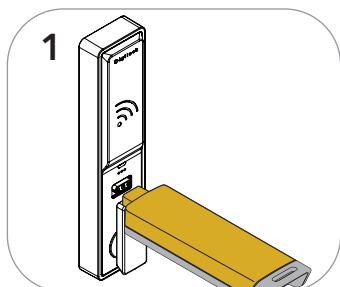

1 Insert and hold Programming Key in place for 5 seconds.
A two-tone beep will be heard.

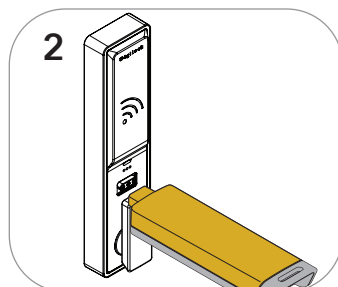

2 Once beep is heard, remove key then reinsert key.
The LED will turn on.

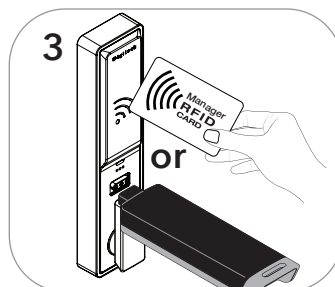

3 Insert each additional Manager Key or present each Manager RFID Credential one at a time.
A two-tone beep will be heard for each manager credential programmed.

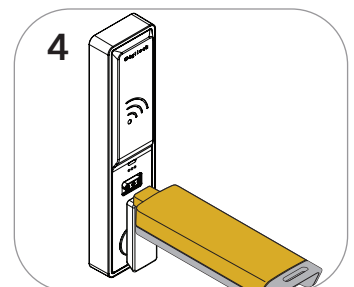

4 Insert the Programming Key.
A two-tone beep will be heard and the LED will turn off.
Repeat above steps for each lock or follow instructions to [Express Register Manager Credentials](#) to quickly program multiple locks to operate with the same manager credentials.

PROGRAMMING INSTRUCTIONS

Replace Programming Key or Manager Credentials

The locks must be reprogrammed to prevent the lost/stolen Programming Key or manager credentials from operating a lock.

To Replace the Programming Key

1

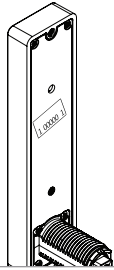

Note the order or serial number (found on the lock's rear unit).

2



Contact Digilock support to purchase a replacement Programming Key.

To Replace Manager Credentials

1

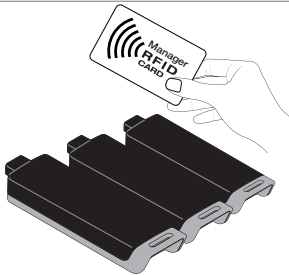

Collect all remaining and replacement manager credentials. Go to any lock operated by the lost/stolen manager credentials.

2a

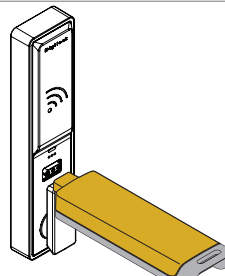

2b

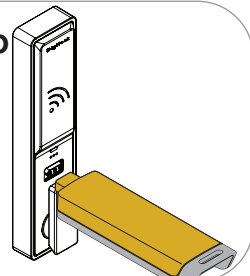

Insert programming key and hold for 5 secs, a two-tone beep will be heard.
 Remove programming key and reinsert again, LED will turn on. Remove key and insert again.
 Three sets of two-tone beeps will be heard and the LED will turn off. All previously programmed manager credentials will be erased.
 Follow instructions to [Add Manager Credentials](#) to program the remaining and replacement manager credentials to the locks.

Request Functionality Change

1

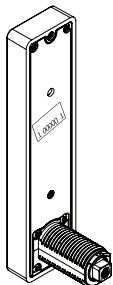

Note the order or serial number (found on the lock's rear).

2

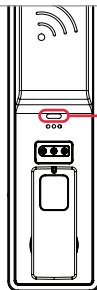

LED Usage Indicator
 ● Shared Use
 ● Assigned Use

Note the current color of the LED.

3



To change the functionality of the locks (between shared use and assigned use), contact Digilock support to request a Function Key.

PROGRAMMING INSTRUCTIONS - IN ASSIGNED USE FUNCTIONALITY

Assign User Credentials

Up to 20 user credentials (User Key or RFID Credential) may be assigned to each lock.

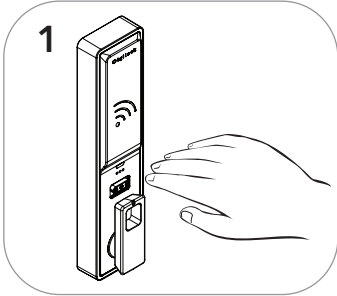

1 Present hand to wake up the lock.

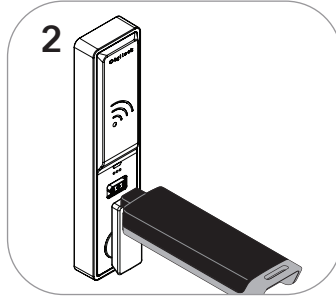

2 Insert a valid Manager Key for 5 seconds. Two sets of two-tone beeps will be heard. Remove the Manager Key. The LED will turn on.

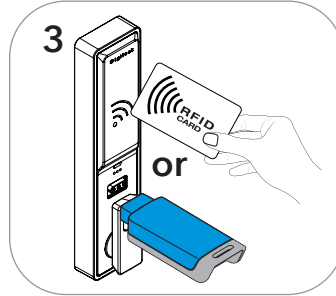

3 Insert each User Key or present each User RFID Credential one at a time. Two sets of two-tone beeps will be heard for each user credential assigned to the lock.

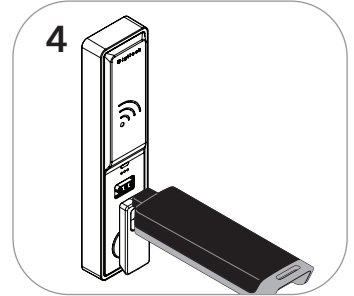

4 Insert a valid Manager Key. A two-tone beep will be heard and the LED will turn off.

Express Register User and Manager Credentials

The Programming Key can quickly program multiple locks to operate with the same user and manager credentials.

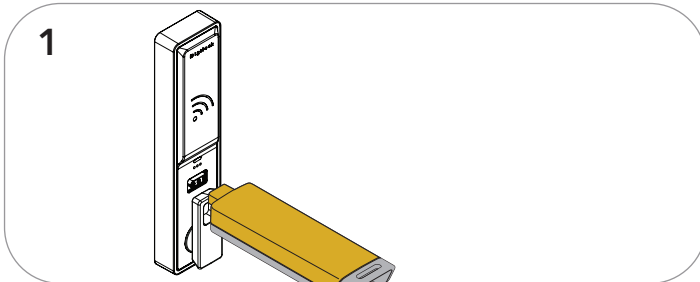

1 Go to a lock already programmed to operate with the user and manager credentials. Insert Programming Key and hold for 15 seconds (a two-tone beep will be heard after 5 seconds followed by 2 sets of two-tone beeps after 10 seconds followed by 3 sets of two-tone beeps after 15 seconds). The LED will flash.

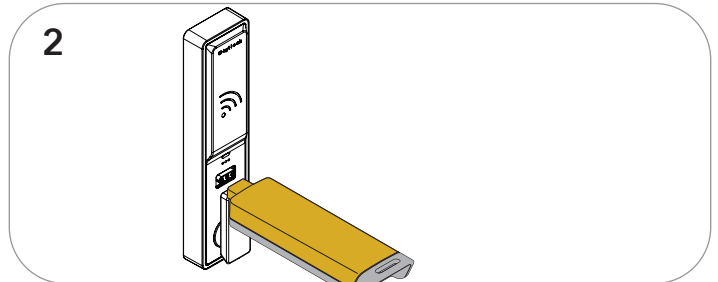

2 Remove and reinsert the Programming Key. A two-tone beep will be heard and the LED will turn off.

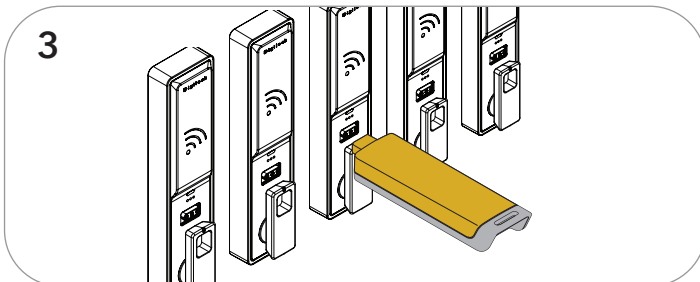

3 Insert the Programming Key to program each lock to operate with the same user and manager credentials. Two sets of two-tone beeps will be heard and the LED will flash once to indicate successful programming.

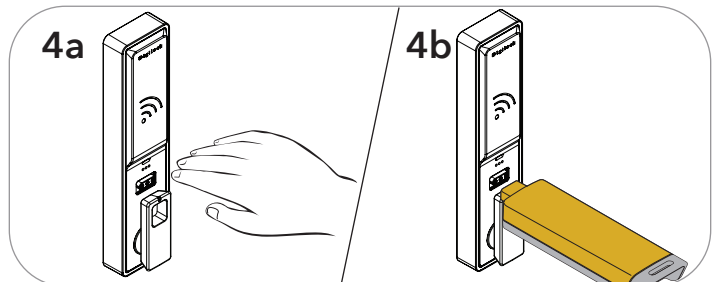

4a End express registration.*
Go to any programmed lock. Present hand to lock until a single beep is heard, then insert the Programming Key to operate the lock.

*The Programming Key will continue to function in express registration mode until it is used to operate a lock.

PROGRAMMING INSTRUCTIONS - IN ASSIGNED USE FUNCTIONALITY

Remove User Credentials (for assigned use functionality only)

Make sure the lock is in assigned use functionality (a green LED will flash when presenting hand to lock). The locks must be reprogrammed to remove user credentials from operating a lock.

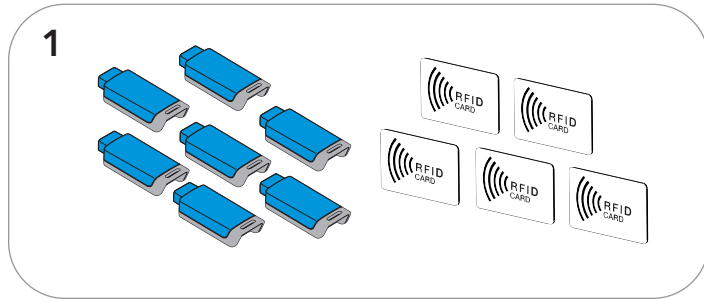

1 Collect all remaining and replacement user credentials

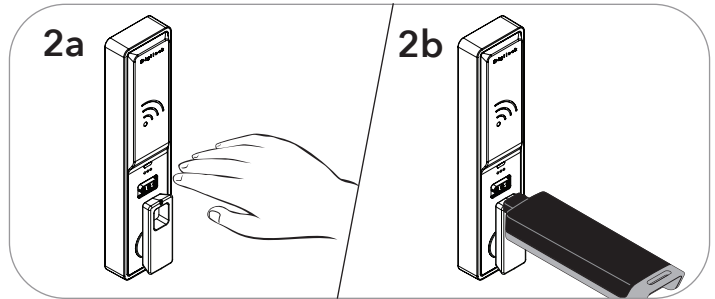

2a Present hand to wake up the lock.
 2b Insert Manager Key and hold for 5 seconds, a two-tone beep will be heard.
 The LED will turn on.

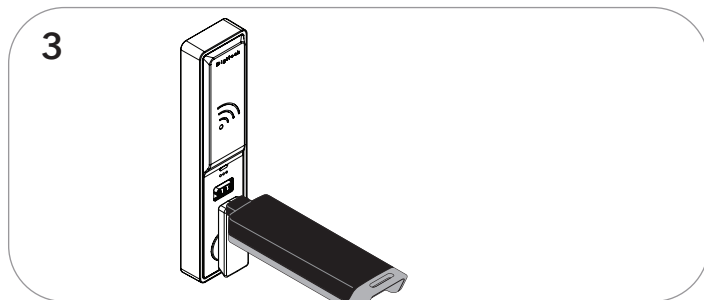

3 Remove and insert Manager Key again.
 Three sets of two-tone beeps will be heard and the LED will turn off.
 All previously assigned user credentials will be removed.

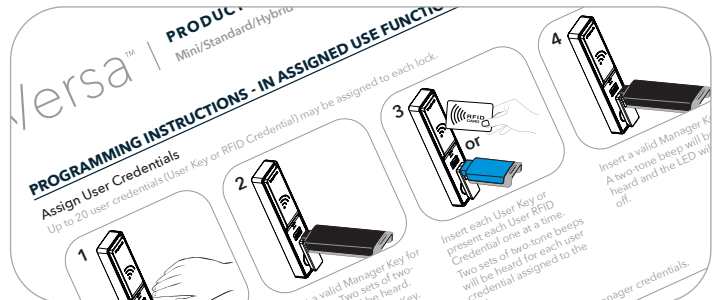

Follow [Assign User Credentials](#) instructions to assign the remaining and replacement user credentials to the locks.

OPERATING INSTRUCTIONS - IN SHARED USE FUNCTIONALITY

In shared use functionality, the user presents any User RFID Credential or inserts any User Key to lock and uses the same User RFID Credential or User Key to unlock. Once unlocked, the lock is available for a different user.

Operate with a User RFID Credential

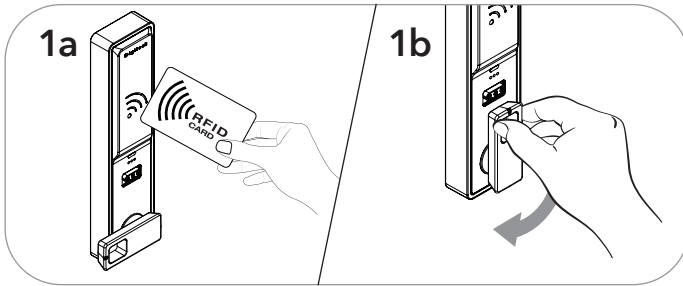

Lock: Close the door. Present any User RFID Credential, then turn the knob to the locked position.

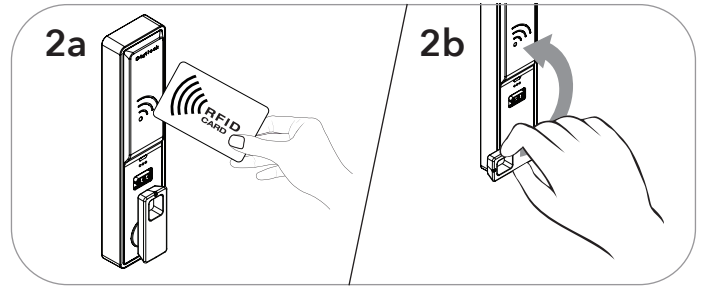

Unlock: Present the same User RFID Credential, then turn the knob to the unlocked position. Open the door.

Operate with a User Key

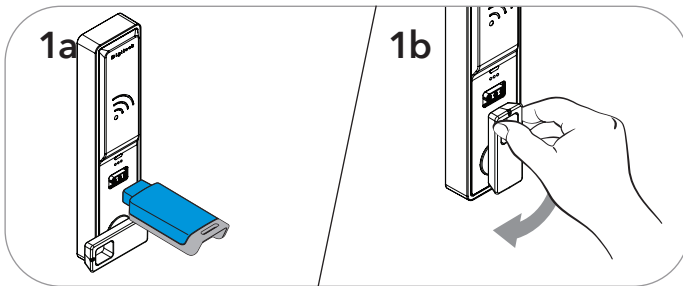

Lock: Close the door. Insert any User Key then turn the knob to the locked position.

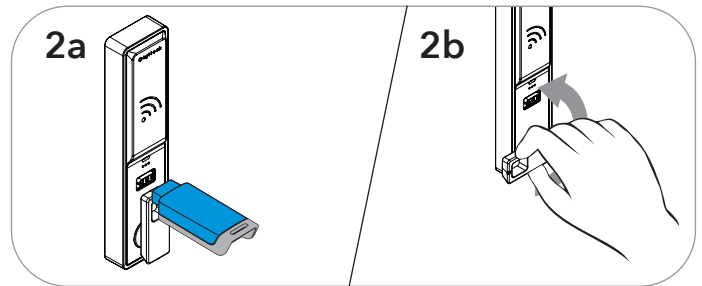

Unlock: Insert the same User Key then turn the knob to the unlocked position. Open the door.

Operate with a Manager Credential

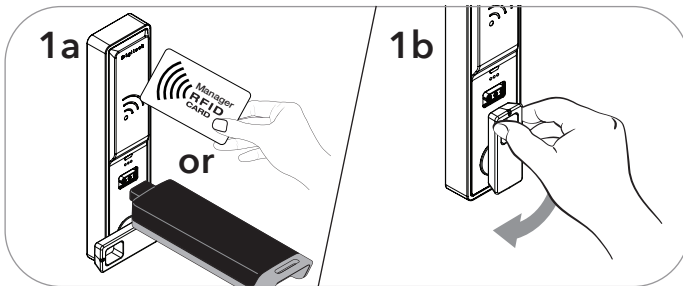

Lock: Close the door. Insert a valid Manager Key or present a valid Manager RFID credential then turn the knob to the locked position.

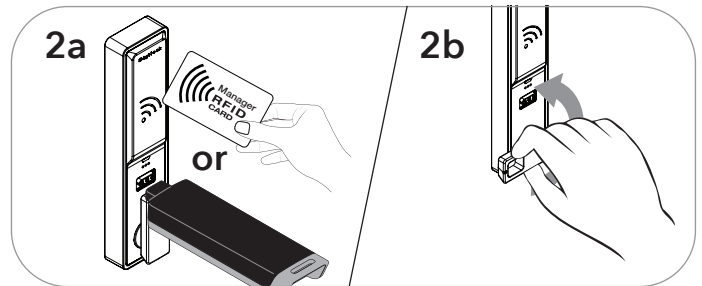

Unlock: Insert a valid Manager Key or present a valid Manager RFID credential then turn the knob to the unlocked position. Open the door.*

*If a valid Manager Credential is used to relock, the previous user credential will continue to operate the lock.

OPERATING INSTRUCTIONS - IN SHARED USE FUNCTIONALITY

Operate with a Programming Key

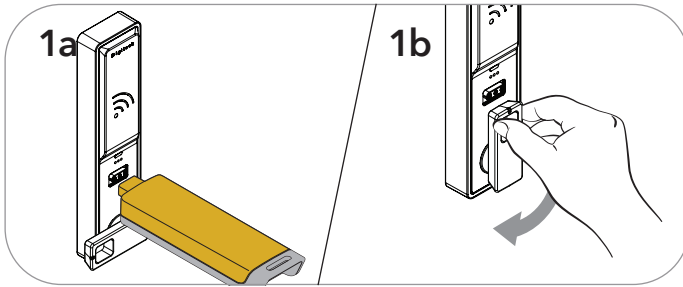

Lock: Close the door. Present hand to lock until a single beep is heard, then insert the programming key. Turn knob to the locked position.

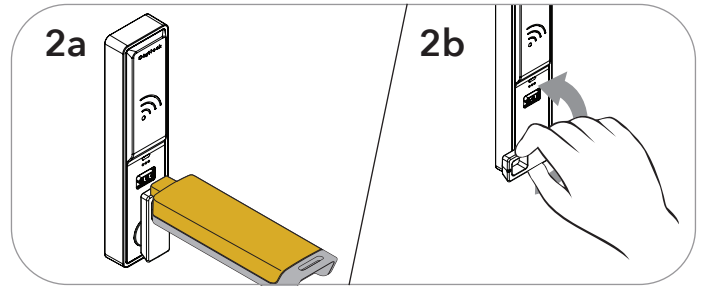

Unlock: Present hand to lock until a single beep is heard, then insert the programming key. Turn knob to the unlocked position. Open the door.*

*If a valid Manager Credential is used to relock, the previous user credential will continue to operate the lock.

OPERATING INSTRUCTIONS - IN ASSIGNED USE FUNCTIONALITY

In assigned use functionality, users operate the lock with their assigned user credential (either a User RFID Credential or a User Key).

Operate with an Assigned RFID Credential

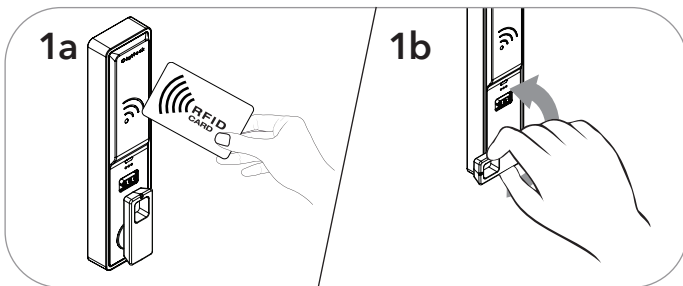

Unlock: Present an assigned User RFID Credential, then turn the knob to the unlocked position. Open the door.**

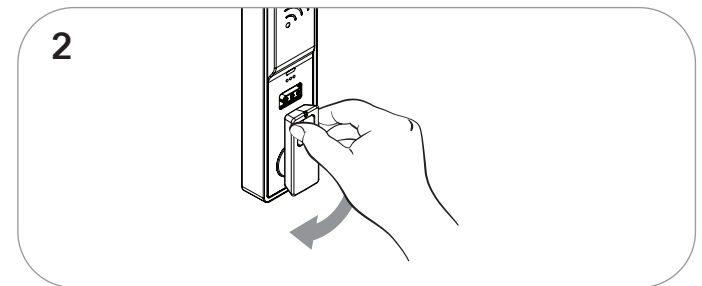

Relock: Close the door then turn the knob to the locked position.

Operate with an Assigned User Key

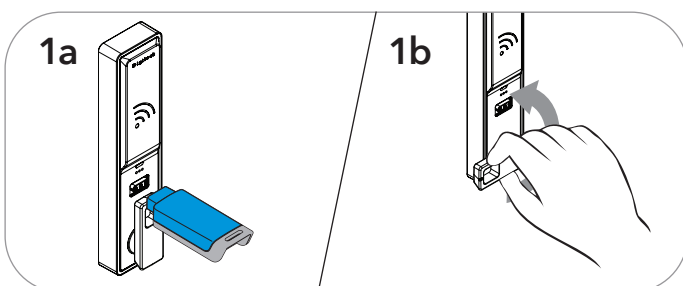

Unlock: Insert an assigned User Key then turn the knob to the unlocked position. Open the door.**

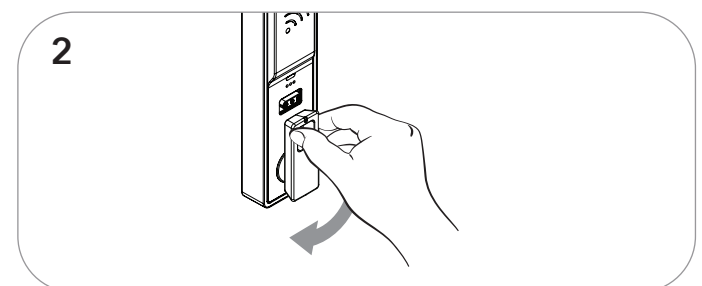

Relock: Close the door then turn the knob to the locked position.

OPERATING INSTRUCTIONS - IN ASSIGNED USE FUNCTIONALITY

Operate with a Manager Credential

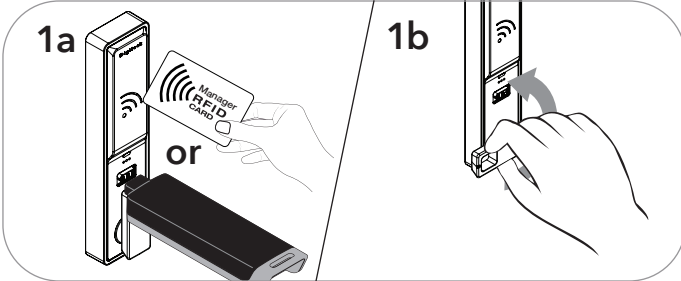

1a or **1b**
Unlock: Insert a valid Manager Key or present a valid Manager RFID Credential then turn the knob to the unlocked position. Open the door.**

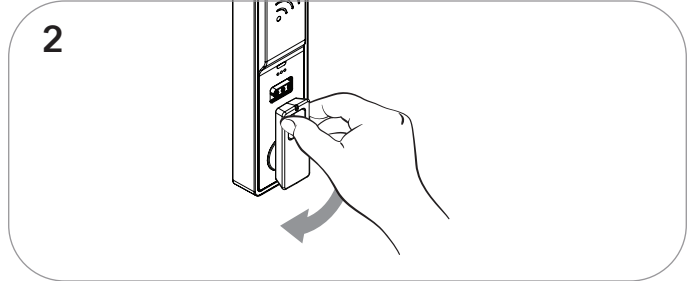

2
Relock: Close the door then turn the knob to the locked position.

Operate with a Programming Key

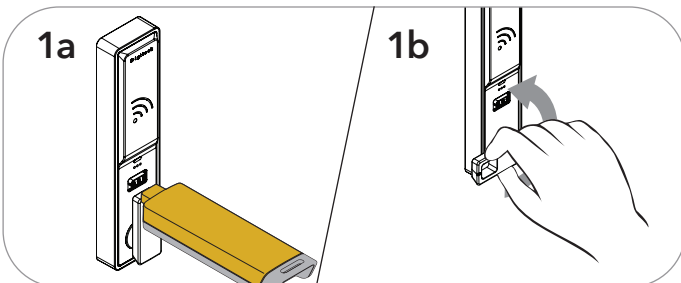

1a or **1b**
Unlock: Present hand to lock until a single beep is heard, then insert the programming key. Turn knob to the unlocked position. **

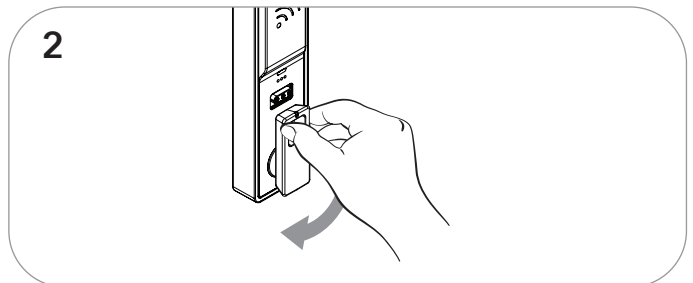

2
Relock: Close the door then turn the knob to the locked position.

**The lock will remain in the locked position if the knob is not turned within approximately 6 seconds.

SUPPORT

Low Battery Indicator

After locking or unlocking, the lock emits two sets of three beeps indicating that the batteries are low. Replace the batteries.

Does Not Unlock with the User RFID Credential or User Key

The lock does not recognize the User RFID Credential or User Key. For immediate access, operate with a valid Manager Credential. If in assigned use functionality, follow instructions to [Assign User Credentials](#) to assign a new User RFID Credential or User Key to the lock.

Does Not Operate with a Manager RFID Credential or Manager Key

The lock does not recognize the Manager Credential. Follow instructions to [Add Manager Credentials](#) to program the Manager Credential to the lock. For immediate access, operate with another valid Manager Credential.

Does Not Operate with the Programming Key

The lock does not recognize the Programming Key. If the Programming Key has been replaced, operate with the Replacement Programming Key. Contact Digilock support for additional assistance.

No Audible Feedback or LED when Hand is Presented to Lock

- The batteries may need to be replaced. For immediate access, operate with a valid Manager Key. If the error condition persists, replace the batteries.

BATTERY REPLACEMENT

It is not necessary to remove the lock from the door. In case of battery failure, operate with a valid Manager Key.

CAUTION: Risk of explosion or leakage if battery is replaced by an incorrect type, mixed with a different battery type, or inserted backwards. Replace all batteries of a set at the same time. Be sure to insert batteries with correct polarities. Remove exhausted batteries from product promptly and dispose of used batteries according to the battery manufacturer's instructions.

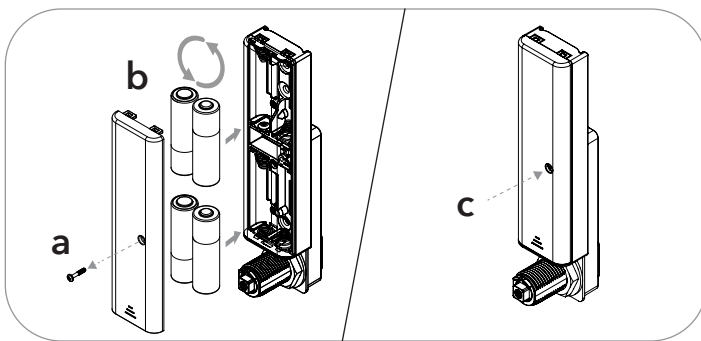

- Remove the screw and the battery cover.
- Replace the four premium AA batteries.
- Replace battery cover and screw.

FCC Statement:

This equipment has been tested and found to comply with the limits for a Class B digital device, pursuant to part 15 of the FCC Rules. These limits are designed to provide reasonable protection against harmful interference in a residential installation. This equipment generates, uses and can radiate radio frequency energy and, if not installed and used in accordance with the instructions, may cause harmful interference to radio communications. However, there is no guarantee that interference will not occur in a particular installation. If this equipment does cause harmful interference to radio or television reception, which can be determined by turning the equipment off and on, the user is encouraged to try to correct the interference by one or more of the following measures:

- 1) Reorient or relocate the receiving antenna.
- 2) Increase the separation between the equipment and receiver.
- 3) Connect the equipment into an outlet on a circuit different from that to which the receiver is connected.
- 4) Consult the dealer or an experienced radio/TV technician for help.

Caution: Any changes or modifications to this device not explicitly approved by manufacturer could void your authority to operate this equipment.

This device complies with part 15 of the FCC Rules. Operation is subject to the following two conditions:

(1) This device may not cause harmful interference, and (2) this device must accept any interference received, including interference that may cause undesired operation.

This equipment complies with FCC radiation exposure limits set forth for an uncontrolled environment. This equipment should be installed and operated with minimum distance 20cm between the radiator and your body.