



Electromagnetic Compatibility Test Report

Tests Performed on a goTenna, Inc.

goTenna Pro, Model 37337-X2

Radiometrics Document RP-9748A



<i>Product Detail:</i>		
FCC ID: 2ABVK373372 Equipment type: 150-479 MHz Transceiver		
<i>Test Standards:</i>		
US CFR Title 47, Chapter I, FCC Part 2 and 90 FCC Parts 2, 15, and 90 CFR Title 47: 2023 IC RSS-119 Issue 12 IC RSS-GEN Issue 5		
<i>Tests Performed For:</i>	<i>Test Facility:</i>	
goTenna, Inc. 81 Willoughby St. Brooklyn, NY 11201	Radiometrics Midwest Corporation 12 Devonwood Avenue Romeoville, IL 60446 Phone: (815) 293-0772	
<i>Test Date(s):</i>		
January 25 to February 20, 2023		
Document RP-9748A Revisions:		
Rev.	Issue Date	Revised By
0	March 6, 2023	



Table of Contents

1 ADMINISTRATIVE DATA	3
2 TEST SUMMARY AND RESULTS.....	3
3 EQUIPMENT UNDER TEST (EUT) DETAILS.....	4
3.1 EUT Description	4
4 TESTED SYSTEM DETAILS	4
4.1 Tested System Configuration.....	4
4.2 Special Accessories	4
4.3 Equipment Modifications.....	4
5 TEST SPECIFICATIONS AND RELATED DOCUMENTS.....	5
6 RADIOMETRICS' TEST FACILITIES.....	5
7 DEVIATIONS AND EXCLUSIONS FROM THE TEST SPECIFICATIONS	5
8 CERTIFICATION	6
9 TEST EQUIPMENT TABLE	6
10 TEST SECTIONS	7
10.1 Peak Output Power	7
10.2 Occupied Bandwidth; Emissions Masks.....	7
10.3 Occupied Bandwidth.....	23
10.4 Field Strength of Unwanted Spurious Radiation.....	31
10.4.1 Test Procedures.....	31
Figure 1. Drawing of Radiated Emissions Setup	32
10.4.2 Spurious Radiated Emissions Test Results	33
10.5 Frequency Stability	35
10.5.1 Frequency Stability Vs Temperature	35
10.5.2 Frequency Stability Vs Supply Voltage.....	35
10.5.3 Test Results for Frequency Stability	35
10.6 Transient Frequency Behavior.....	36
10.6.1 Test method.....	36
10.6.2 Limits of transient frequency.....	37
10.6.3 Test Results	37
10.6.4 Results for Time Periods t1 and t2	38
10.6.5 Results for Time Period t3.....	40
10.7 Radiated Emissions (Receive Mode)	41
10.7.1 Radiated Emissions Field Strength Sample Calculation	42
10.7.2 Spurious Radiated Emissions Test Results (Receive Mode)	42
11 MEASUREMENT INSTRUMENTATION UNCERTAINTY	43
12 REVISION HISTORY	44

Notice: This report must not be reproduced (except in full) without the written approval of Radiometrics Midwest Corporation.

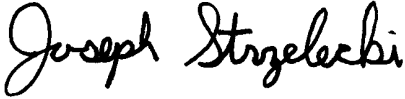

1.0 ADMINISTRATIVE DATA

<i>Equipment Under Test:</i> A goTenna, Inc. goTenna Pro Model: 37337-X2; Serial Numbers: 023 & 047 This will be referred to as the EUT in this Report	
<i>Date EUT Received at Radiometrics: (Month-Day-Year)</i> January 5, 2023	<i>Test Date(s): (Month-Day-Year)</i> January 25 to February 15, 2023
<i>Test Report Written and authorized By:</i> Joseph Strzelecki Senior EMC Engineer	<i>Test Witnessed By:</i> The tests were not witnessed by personnel from goTenna, Inc.
<i>Radiometrics' Personnel Responsible for Test:</i>  03/06/2023 Date Joseph Strzelecki Senior EMC Engineer NARTE EMC-000877-NE Richard L. Tichelaar EMC Technician	<i>Test Report Approved By</i> Chris W. Carlson Director of Engineering NARTE EMC-000921-NE

2.0 TEST SUMMARY AND RESULTS

The EUT (Equipment Under Test) is a goTenna Pro, Model 37337-X2, manufactured by goTenna, Inc. The detailed test results are presented in a separate section. The following is a summary of the test results.

Transmitter Requirements

Environmental Phenomena	Frequency Range	FCC Sections	RSS 119 Section	Test Result
RF Power Output	450-470 MHz	2.1046 & 90.205	5.4	Pass
Occupied Bandwidth Test; Emissions Masks	150-480 MHz	2.1049 & 90.209	5.5	Pass
Spurious RF Conducted Emissions	1-4800 MHz	2.1051 & 90.210	5.8	Pass
Field Strength of Spurious Radiation	30-4700 MHz	2.1053	5.3	Pass
Frequency Vs. Temperature	450-470 MHz	2.1055 & 90.213	5.3	Pass
Frequency Vs. Voltage	450-470 MHz	2.1055 & 90.213	5.3	Pass
Transient Frequency Behavior	450-470 MHz	90.214	5.9	Pass
Radiated Emissions Receive Mode	30-2000 MHz	FCC part 15	RSS-GEN	Pass



3.0 EQUIPMENT UNDER TEST (EUT) DETAILS

3.1 EUT Description

The EUT is a goTenna Pro, manufactured by goTenna, Inc. The RF communications link is encrypted in both directions. The EUT was in good working condition during the tests, with no known defects.

4.0 TESTED SYSTEM DETAILS

4.1 Tested System Configuration

The system was configured for testing in a typical fashion. The testing was performed in conditions as close as possible to installed conditions. The wiring was consistent with the manufacturer’s recommendations. The networking radio was tested as a stand-alone device. The identification for all equipment used in the tested system, is:

Tested System Configuration List

Item	Description	Type*	Manufacturer	Model Number	Serial Number(s)
1	goTenna Pro Mesh Networking Radio	E	goTenna, Inc.	37337-X2	023, & 047
2	USB power Supply	P	Apple	A1401	LPS 0012ADU00

* Type: E = EUT; P = Peripheral

Type of modulation including the bit rate	4GFSK; 9.6 & 19.2 kHz
Name and version of the test software used to exercise the device	“goTenna FCC Test App” V1.0.2
Power settings used for the purpose of exercising the device	“5 Watts”
Firmware number of the transmitter	128.0.68

4.2 Special Accessories

No special accessories were used during the tests in order to achieve compliance.

4.3 Equipment Modifications

No modifications were made to the EUT at Radiometrics' test facility in order to comply with the standards listed in this report.



5.0 TEST SPECIFICATIONS AND RELATED DOCUMENTS

Document	Date	Title
FCC CFR Title 47	2023	Code of Federal Regulations Title 47, Chapter 1, Federal Communications Commission, Part 15 & 90 - Radio Frequency Devices
ANSI C63.4-2014	2014	Methods of Measurement of Radio Noise Emissions from Low-Voltage Electrical and Electronic Equipment in the Range of 9 kHz to 40 GHz
ANSI C63.26	2015	American National Standard for Compliance Testing of Transmitters Used in Licensed Radio Services
TIA-603-E	2016	Land Mobile FM or PM Communications Equipment – Measurement and Performance Standards
IC RSS-Gen Issue 5	2018	General Requirements and Information for the Certification of Radiocommunication Equipment (RSS-Gen) + Amd 1 + Amd 2
IC RSS-119 Issue 12	2015	Radio Transmitters and Receivers Operating in the Land Mobile and Fixed Services in the Frequency Range 27.41-960 MHz + Amd 2022

6.0 RADIOMETRICS' TEST FACILITIES

The results of these tests were obtained at Radiometrics Midwest Corp. in Romeoville, Illinois, USA. Radiometrics is accredited by A2LA (American Association for Laboratory Accreditation) to conform to ISO/IEC 17025: 2017 "General Requirements for the Competence of Calibration and Testing Laboratories". Radiometrics' Lab Code is 121191 and Certification Number is 1495.01. A copy of the accreditation can be accessed on our web site (www.radiomet.com). Radiometrics accreditation status can be verified at A2LA's web site (www.a2la2.org).

The following is a list of shielded enclosures located in Romeoville, Illinois used during the tests:

Chamber A: Is an anechoic chamber that measures 24' L X 12' W X 12' H. The walls and ceiling are fully lined with ferrite absorber tiles. The floor has a 10' x 10' section of ferrite absorber tiles located in the center. Panashield of Rowayton, Connecticut manufactured the chamber. The enclosure is NAMAS certified.

Chamber B: Is a shielded enclosure that measures 20' L X 12' W X 8' H. Erik A. Lindgren & Associates of Chicago, Illinois manufactured the enclosure.

Chamber C: Is a shielded enclosure that measures 17' L X 10' W X 8' H. Lindgren RF Enclosures Inc. of Addison, Illinois manufactured the enclosure.

Chamber E: Is a custom made anechoic chamber that measures 52' L X 30' W X 18' H. The walls and ceiling are fully lined with RF absorbers. Pro-shield of Collinsville, Oklahoma manufactured the chamber.

A separate ten-foot long, brass plated, steel ground rod attached via a 6-inch copper braid grounds each of the above chambers. Each enclosure is also equipped with low-pass power line filters.

The FCC has accepted these sites as test site number US1065. The FCC test site Registration Number is 732175. Details of the site characteristics are on file with the Industry Canada as site number IC 3124A.

7.0 DEVIATIONS AND EXCLUSIONS FROM THE TEST SPECIFICATIONS

There were no deviations or exclusions from the test specifications.



8.0 CERTIFICATION

Radiometrics Midwest Corporation certifies that the data contained herein was taken under conditions that meet or exceed the requirements of the test specification. The results relate only to the EUT listed herein. Any modifications made to the EUT subsequent to the indicated test date will invalidate the data and void this certification.

9.0 TEST EQUIPMENT TABLE

RMC ID	Manufacturer	Description	Model No.	Serial No.	Frequency Range	Cal Period	Cal Date
AMP-05	RMC/Celeritek	Pre-amplifier	MW110G	1001	1.0-12GHz	12 Mo.	01/04/23
ANT-06	EMCO	Log-Periodic Ant.	3146	1248	200-1000MHz	24 Mo.	01/18/22
ANT-13	EMCO	Horn Antenna	3115	2502	1.0-18GHz	24 Mo.	02/14/23
ANT-42	EMCO	Bicon Antenna	3104C	9512-4713	25-300MHz	24 Mo.	12/15/22
ANT-66	ETS-Lindgren	Horn Antenna	3115	62580	1.0-18GHz	24 Mo.	03/11/21
ANT-68	EMCO	Log-Periodic Ant.	93146	9604-4456	200-1000MHz	24 Mo.	02/07/22
ANT-79	AH Systems	Bicon Antenna	SAS-540	793	20-330MHz	24 Mo.	01/26/23
ANT-80	AH Systems	Bicon Antenna	SAS-540	294	20-330MHz	24 Mo.	01/26/23
ATT-53	Weinschel	Attenuator (20 dB)	23-20-34	CG7857	DC-18 GHz	24 Mo	12/17/21
CDT-01	Wiltron	Crystal RF Detector	75N50	CDT-01	DC-18GHz	N/A	NCR
COM-01	Anaren	Coupler	10023-3	COM-01	250-1000MHz	N/A	NCR
DIR-19	Narda	Directional Coupler	3000-10	01174	200-500MHz	N/A	NCR
DMM-13	Keithley	DMM	2100	1424276	DC-300kHz	24 Mo	02/12/22
HPF-01	Solar	High Pass Filter	7930-100	HPF-1	0.15-30MHz	24 Mo.	03/07/22
LSN-01	Electrometrics	50 uH LISN	FCC/VDE 50/2	1001	0.01-30MHz	24 Mo.	08/23/21
PWM-01	Boonton	Power Meter	4230	22503	50kHz-18GHz	24 Mo.	02/12/22
REC-11	HP / Agilent	Spectrum Analyzer	E7405A	US39110103	9Hz-26.5GHz	24 Mo.	05/05/22
REC-20	HP / Agilent	Spectrum Analyzer	85460A/84562 A	33330A00135 3410A00178	30Hz-6GHz	24 Mo.	08/18/21
REC-44	Agilent	Spectrum Analyzer	E4440A	US40420673	3Hz-26.5GHz	24 Mo.	03/31/22
SCP-05	Tektronix	Oscilloscope	TDS320	B032608	DC-100 MHz	24 Mo.	02/04/22
SIG-31	Rohde Schwarz	Vector Signal Generator	SMJ 100A	101395	100kHz-6GHz	36 Mo.	09/08/20
TC-01	GS Blue M Electric	Temperature Chamber	ETC-04S-E	0003-ETC-201	-40 to 100 Deg C	24 Mo.	10/14/22
THM-03	Fluke	Temp/Humid Meter	971	95850465	N/A	24 Mo.	05/25/21

Note: All calibrated equipment is subject to periodic checks.

NCR – No Calibration Required. Device monitored by calibrated equipment. N/A: Not Applicable.

All Equipment calibration was current while it was being used for the tests.

Note: All calibrated equipment is subject to periodic checks.

Software Company	Test Software Name	Version	Applicable Tests
Radiometrics	EN550XX0	07.21.22	RF Conducted Emissions (FCC/CE)
Radiometrics	REREC11D	07.25.22	RF Radiated Emissions (FCC/CE)



10.0 TEST SECTIONS

10.1 Peak Output Power

The peak power was measured by connecting the EUT antenna port to the spectrum analyzer via a low loss coaxial cable and an appropriate power attenuator.

Model	37337-X2	Specification	FCC part 90.205
Serial Number	023	Test Date	January 31, 2023
Test Personnel	Joseph Strzelecki	Test Location	Chamber B
Test Equipment	Attenuator ATT-53; PWM-01		

TX Freq MHz	Reading dBm	Attenuator dB	Cable Loss dB	Total dBm	Peak Power Watts
150.0250	16.75	20.03	36.78	4.764	150.0250
162.0000	16.68	20.02	36.70	4.677	162.0000
173.2750	16.74	20.01	36.75	4.732	173.2750
450.0250	16.25	20.09	36.34	4.305	450.0250
460.0000	16.53	20.13	36.66	4.634	460.0000
469.9750	16.62	20.14	36.76	4.742	469.9750
479.0000	16.74	20.12	36.86	4.853	479.0000

Judgement: Pass

10.2 Occupied Bandwidth; Emissions Masks

Model	37337-X2	Specification	FCC Part 90.209 & 90.2105 RSS-119 Section 5.5
Test Date	February 3, 2021	Test Personnel	Joseph Strzelecki
Test Equipment	Spectrum Analyzer (REC-21)		

The spectrum analyzer was set to the MAX HOLD mode to record the worst case of the modulation. The EUT was transmitting at its maximum data rate. The trace was allowed to stabilize.

Emission Masks:

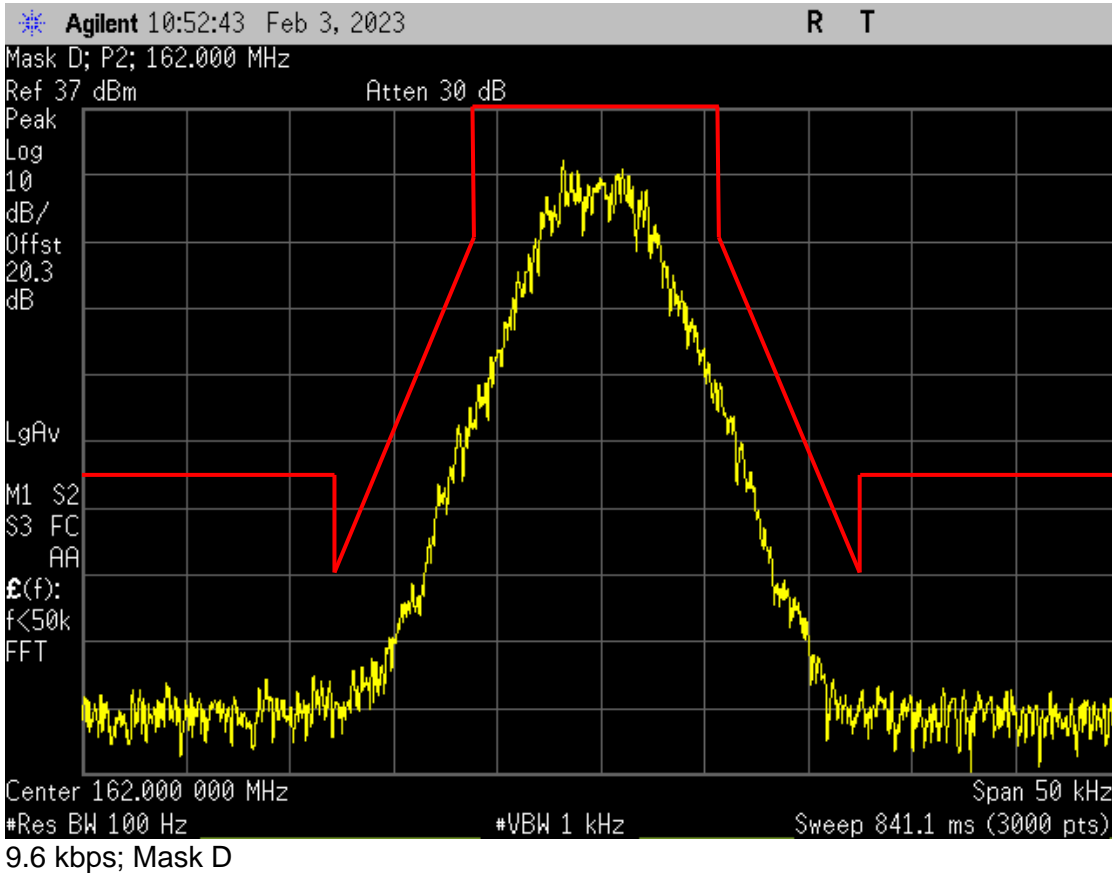
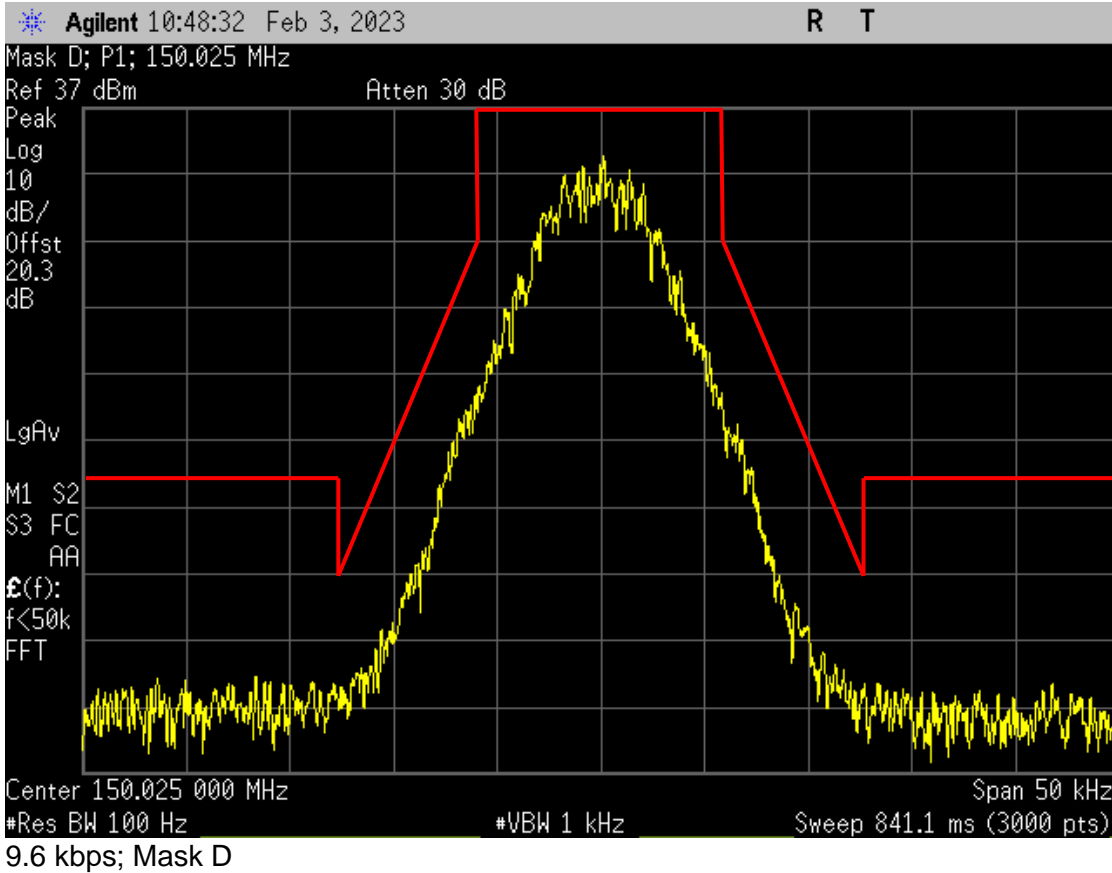

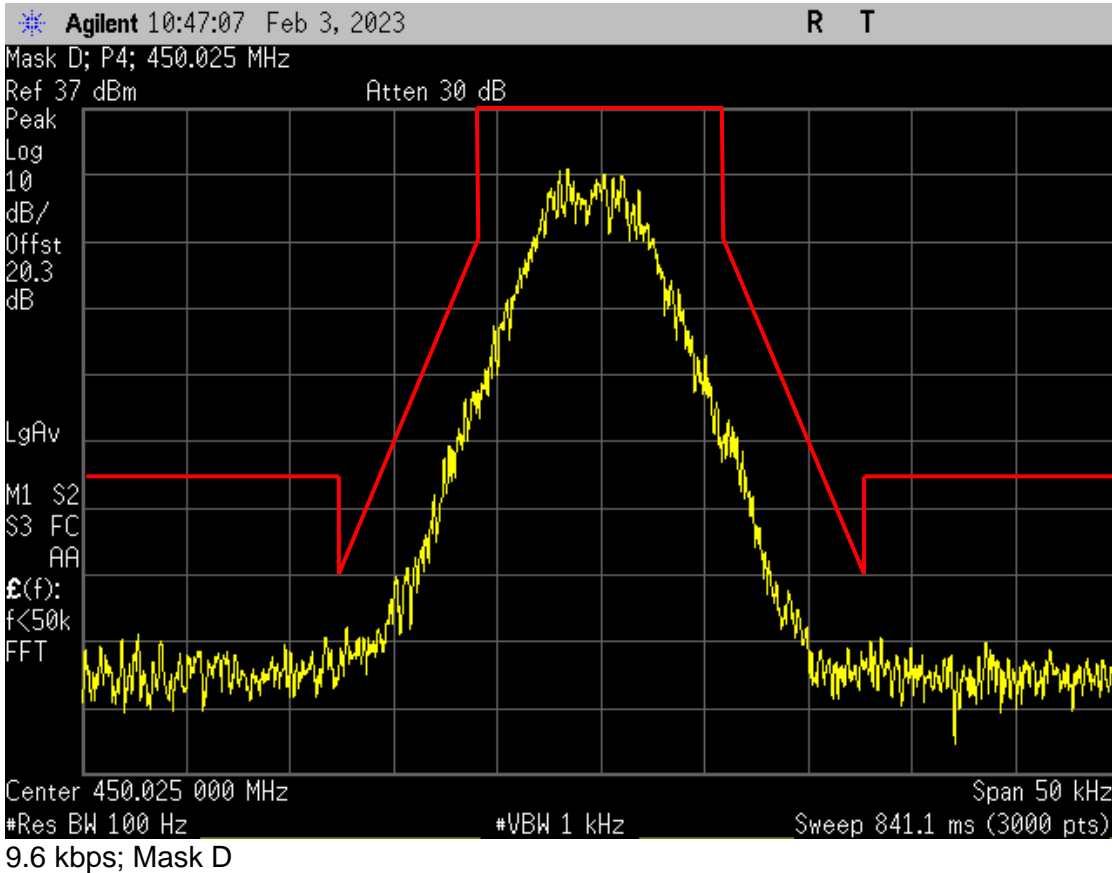
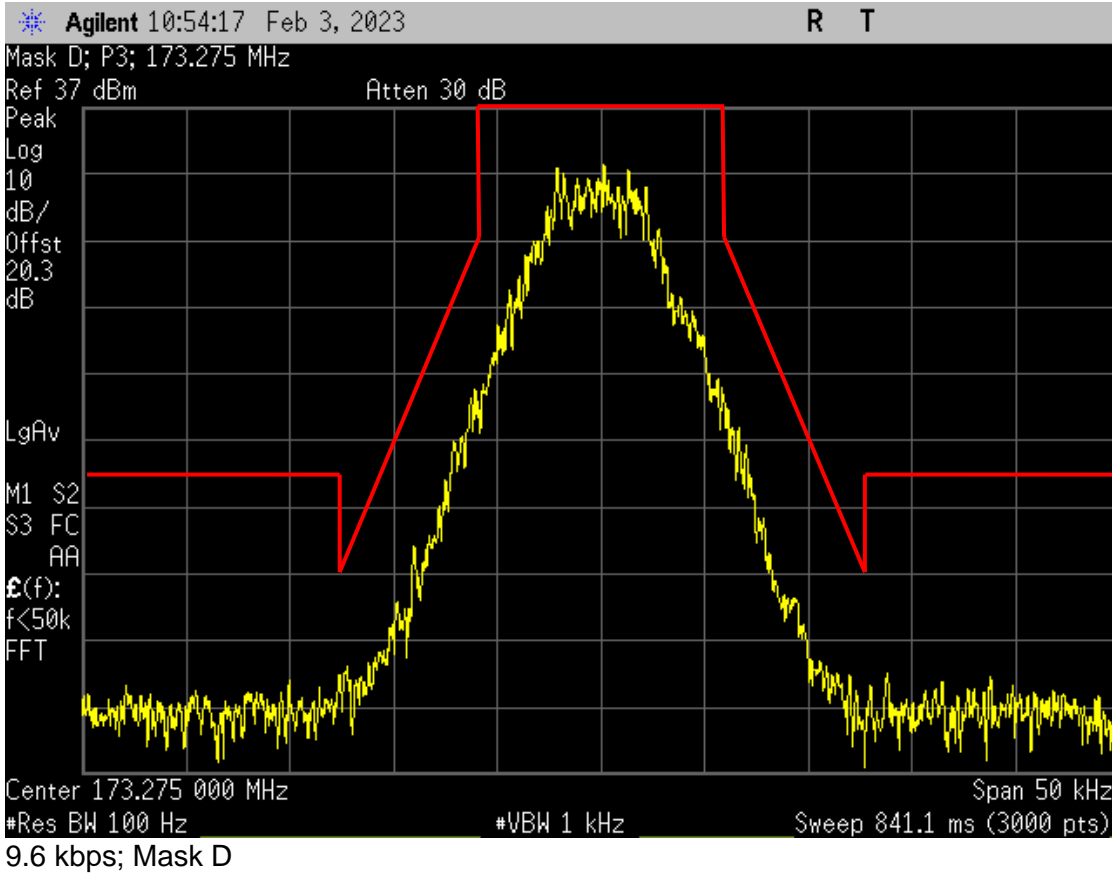

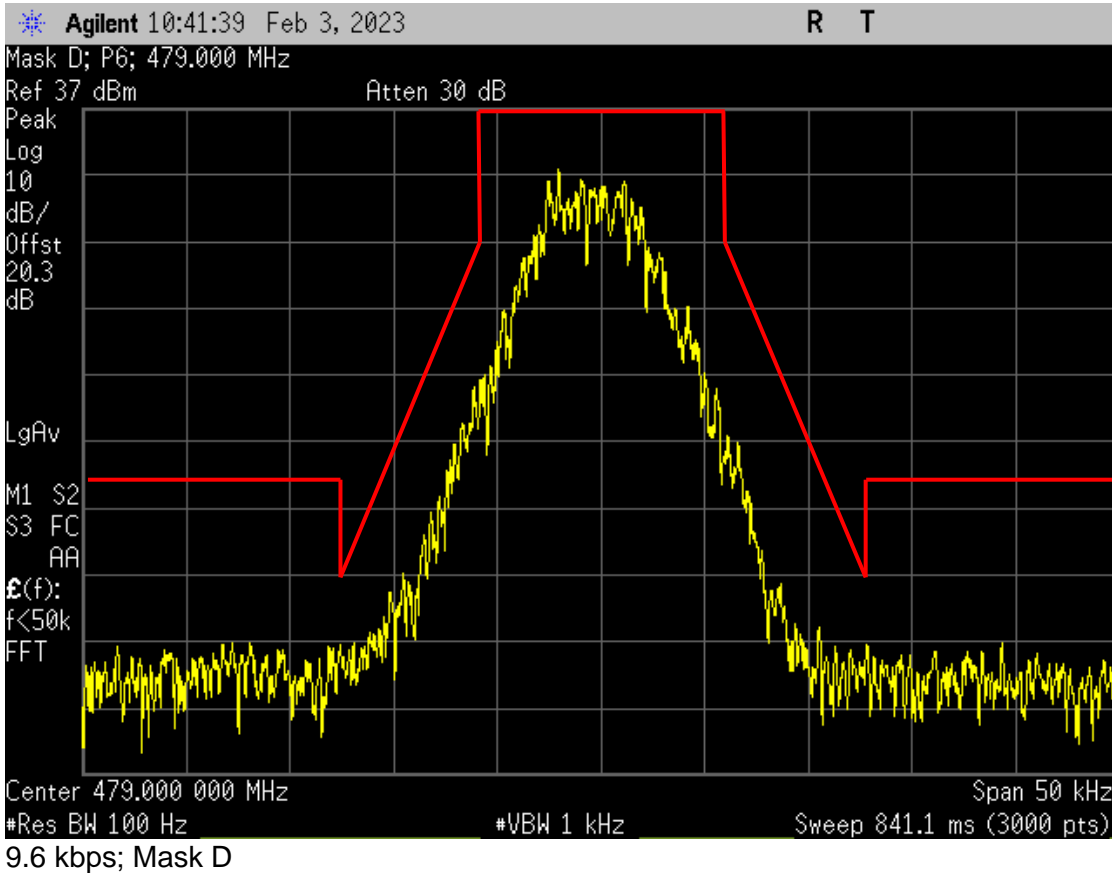
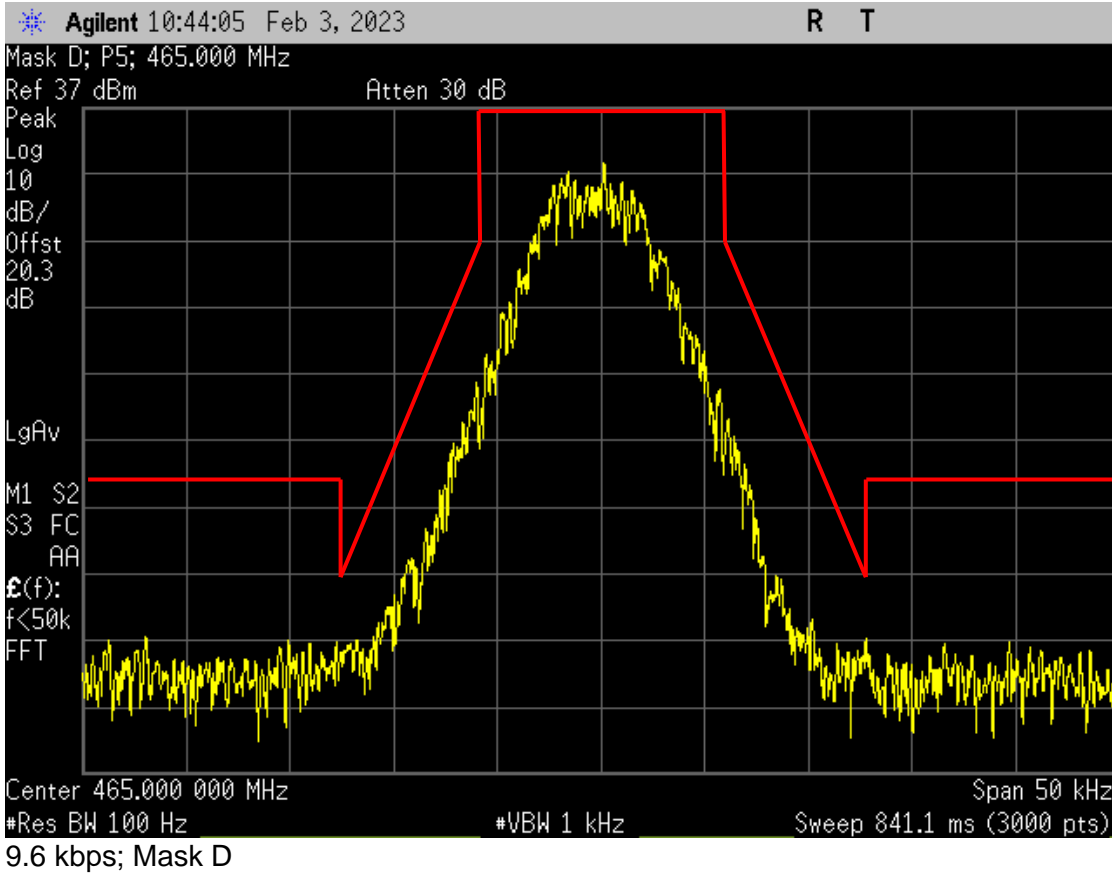

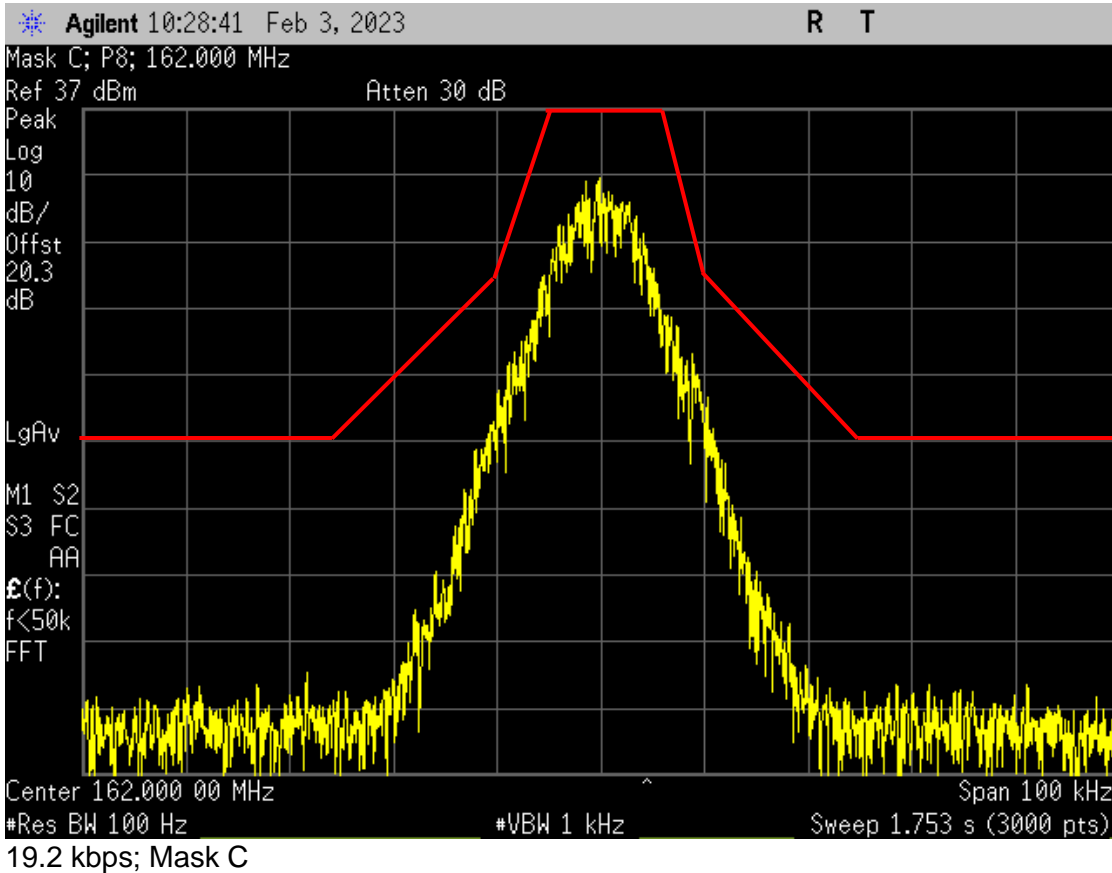
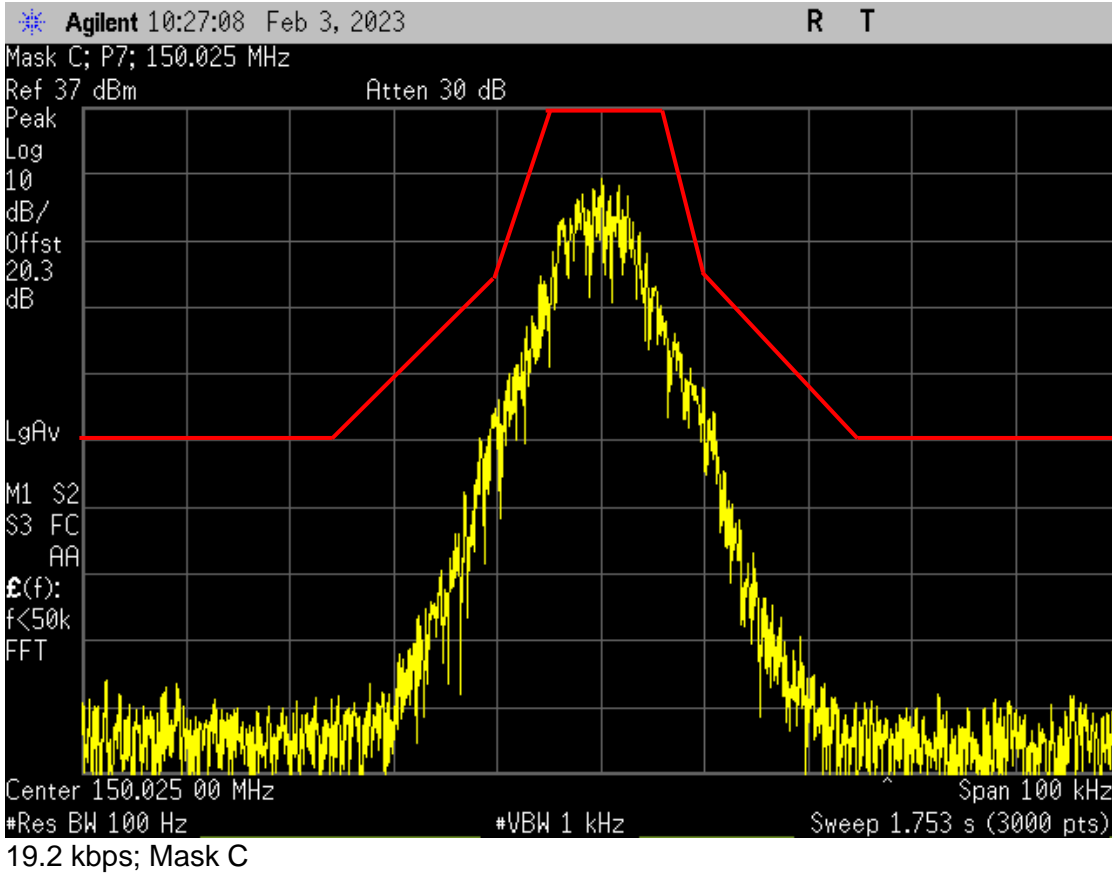

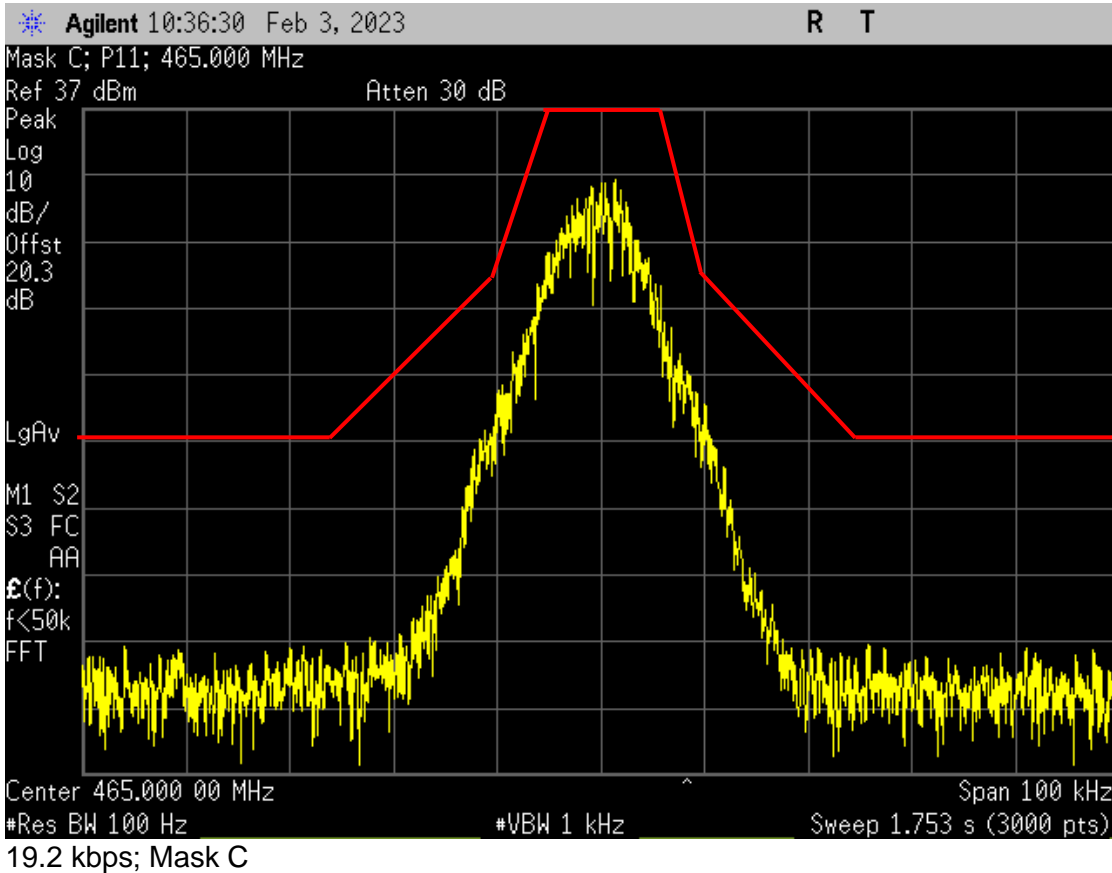
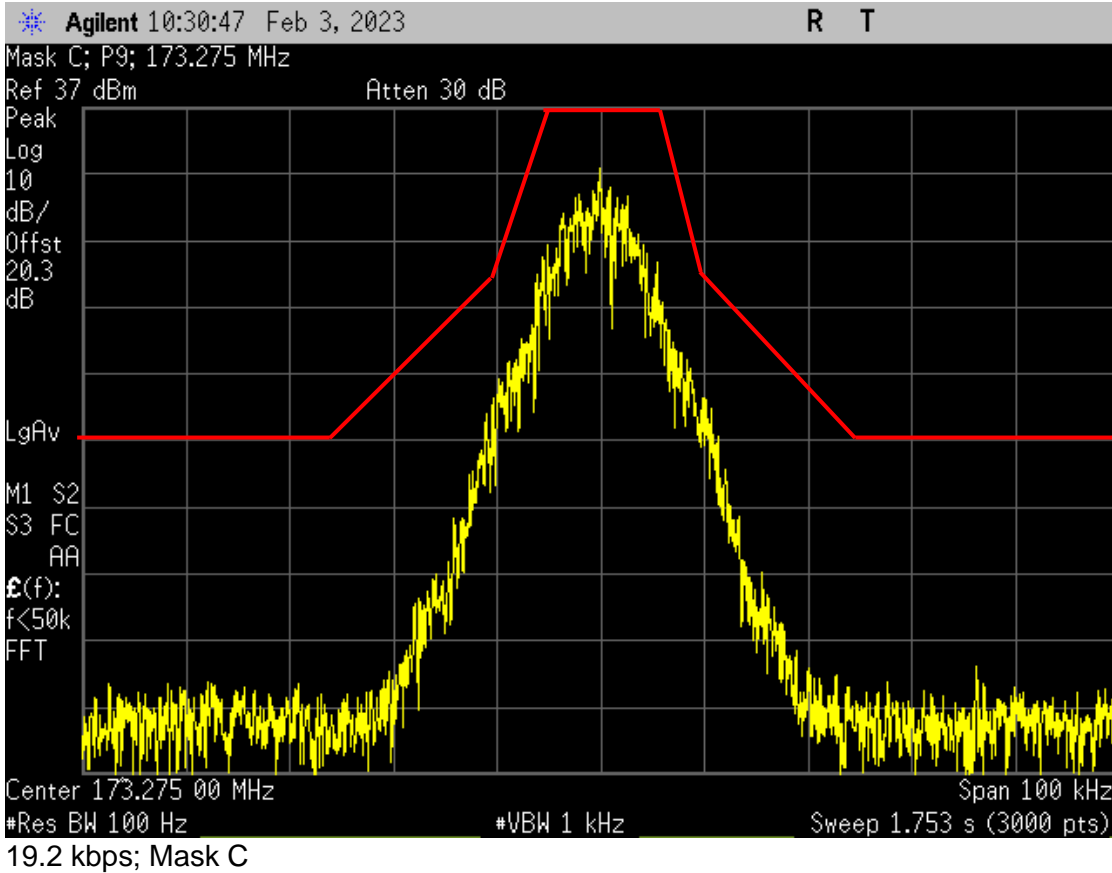

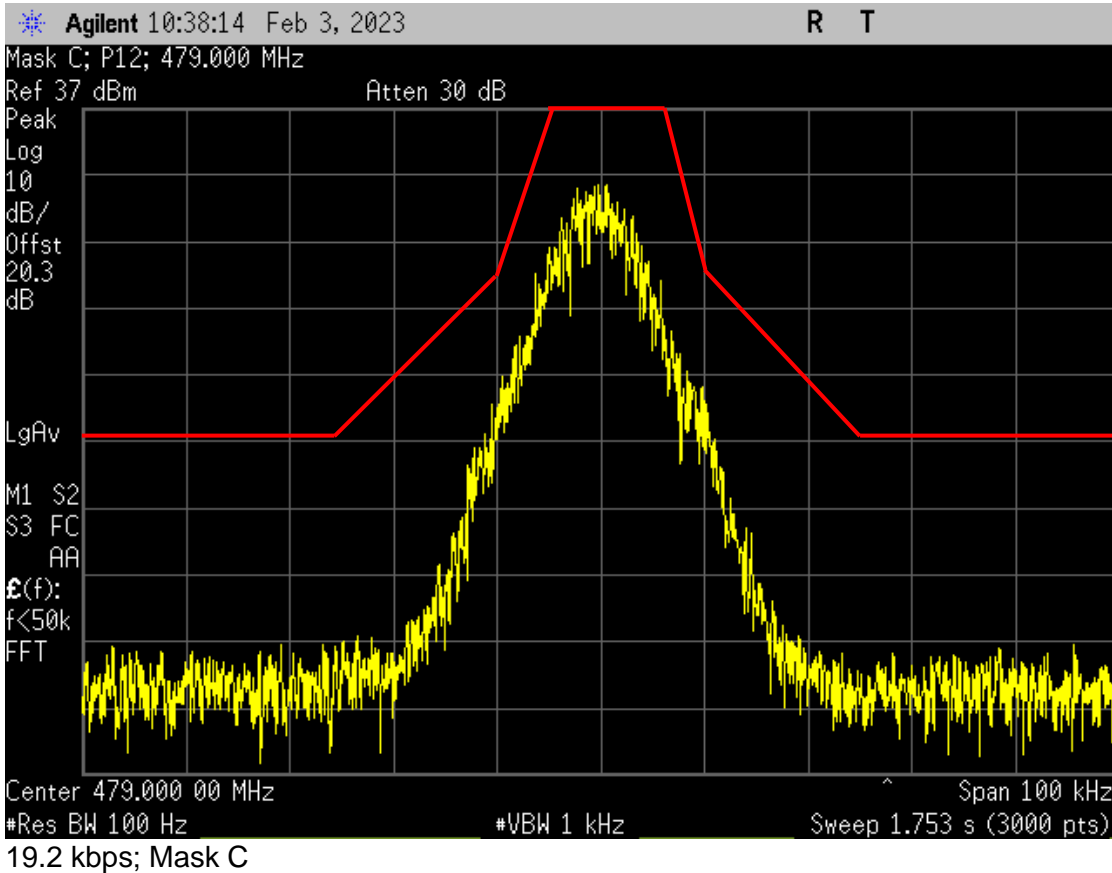
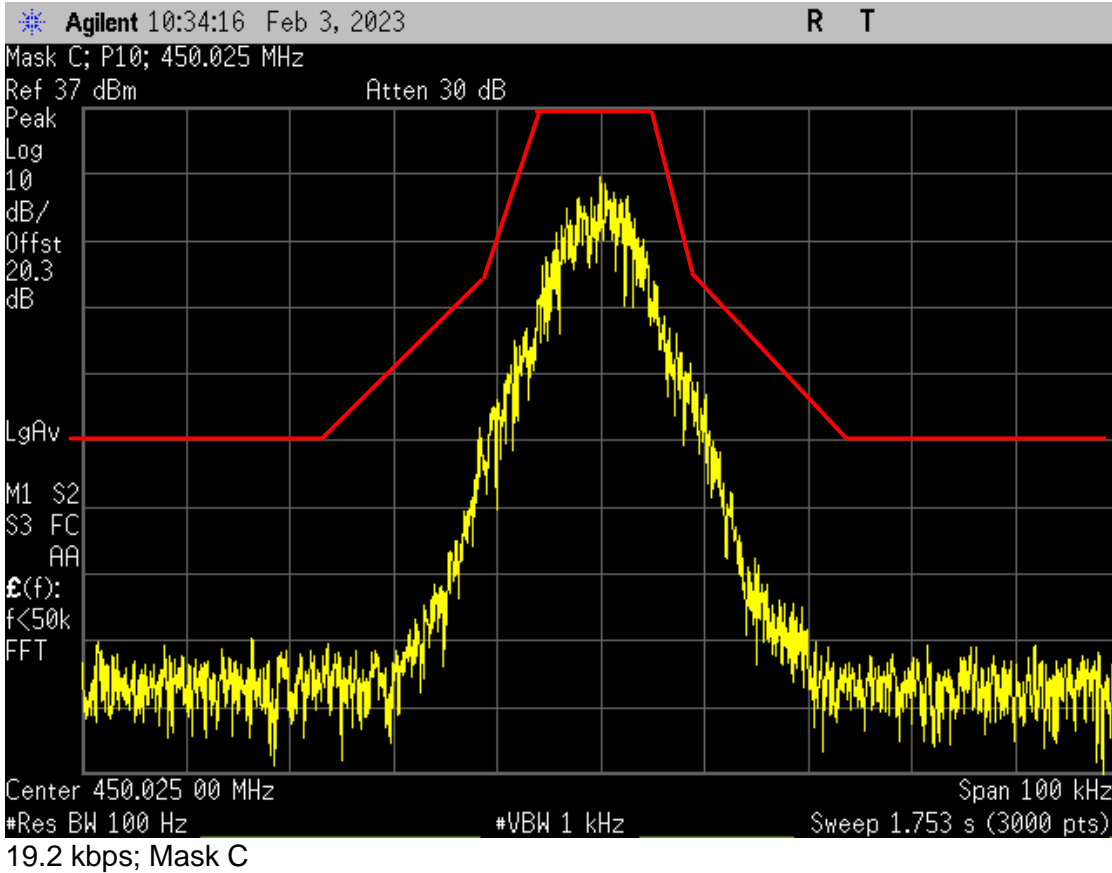

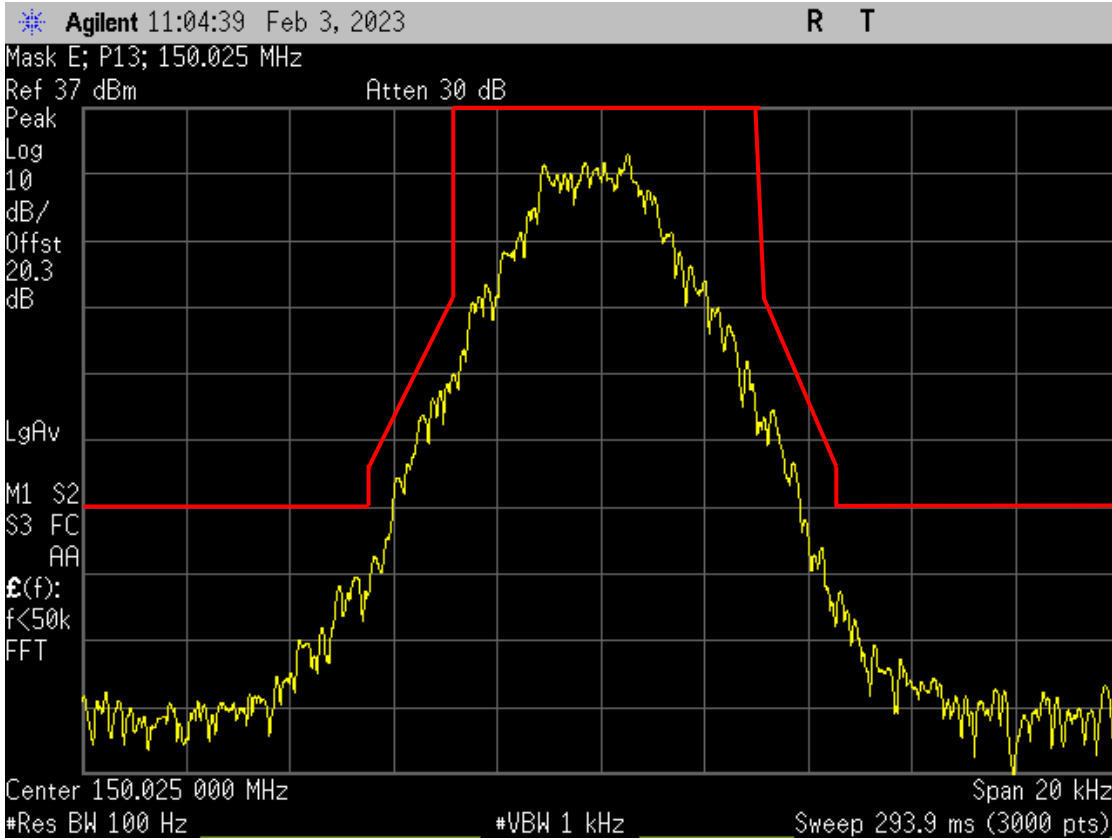

4.8 kbps; Mask E

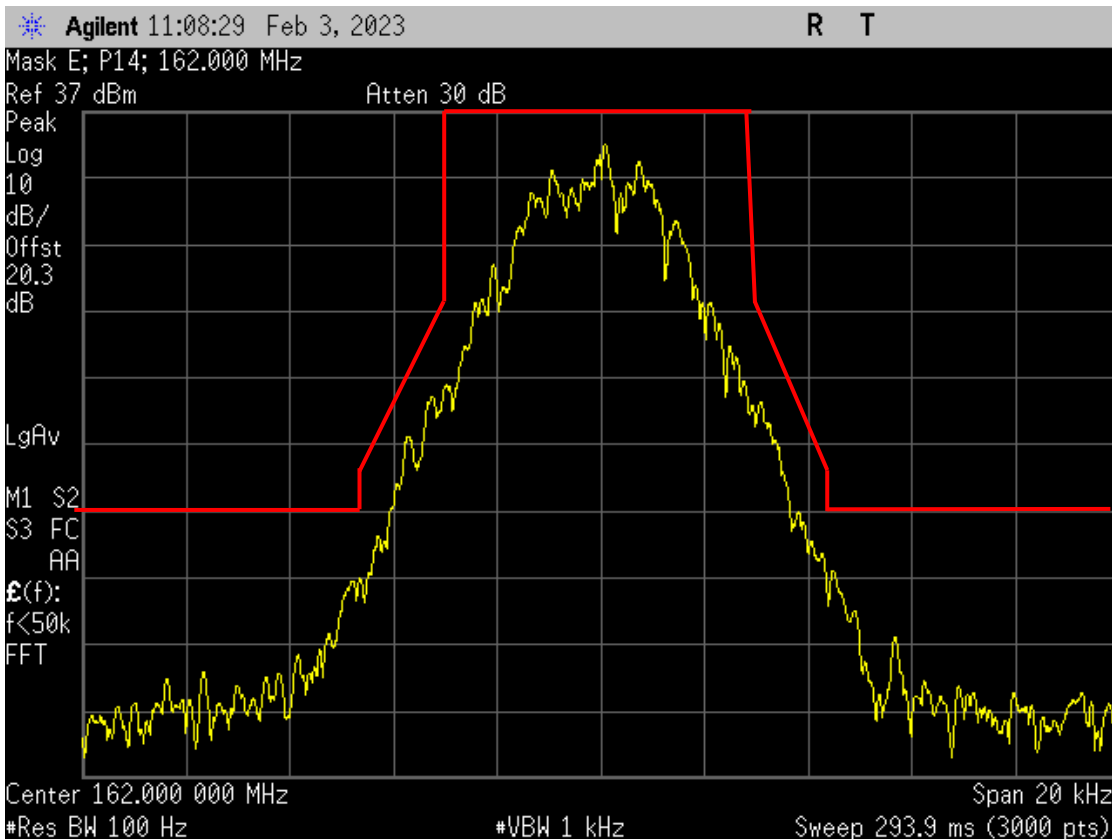

4.8 kbps; Mask E

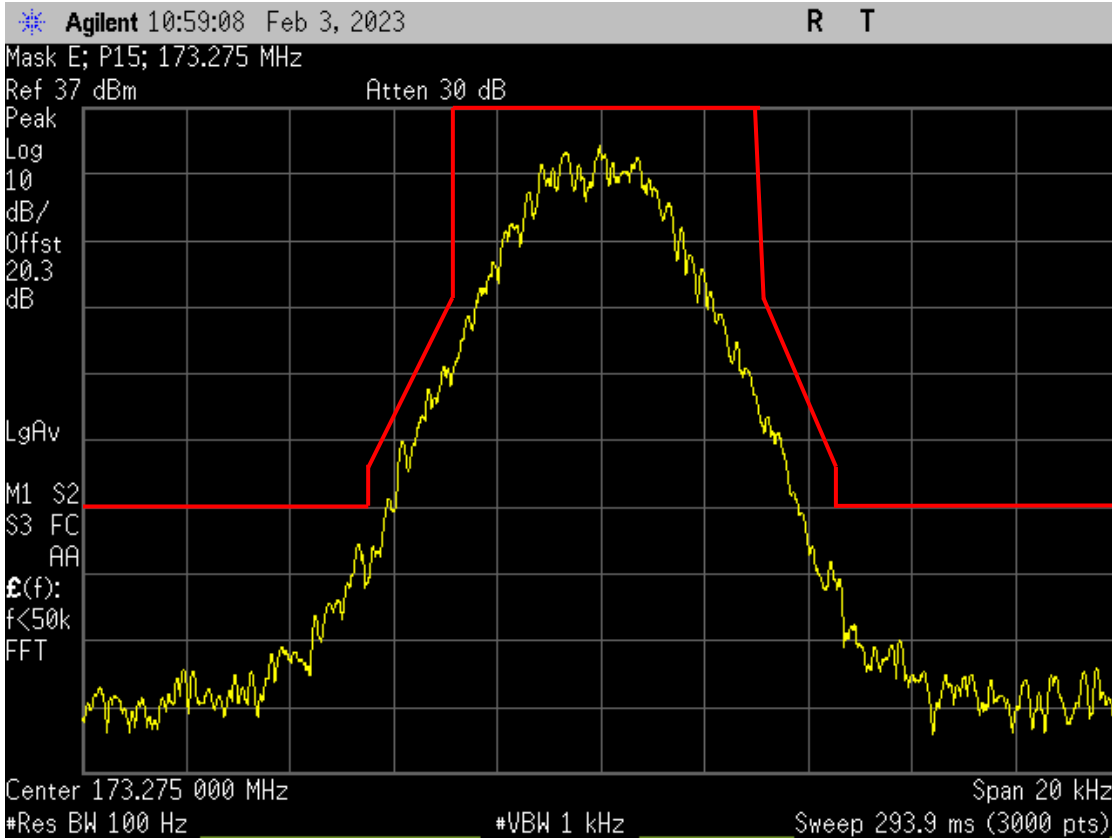

4.8 kbps; Mask E

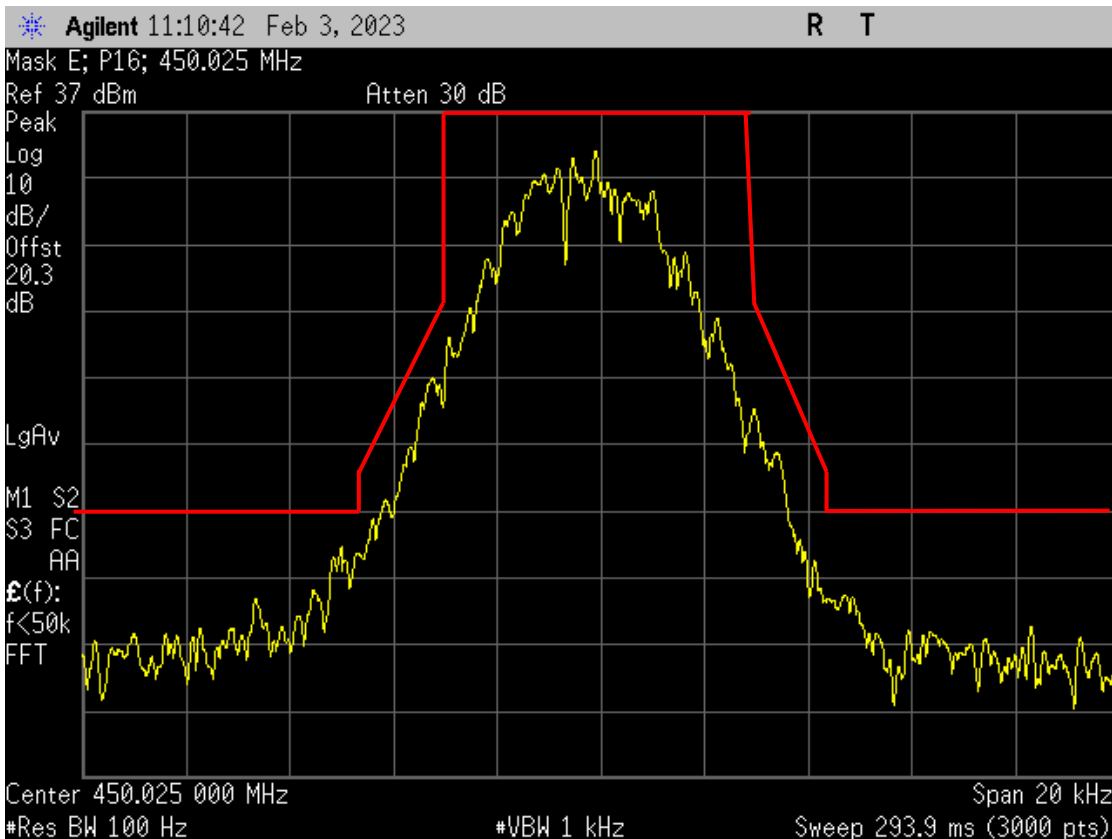

4.8 kbps; Mask E

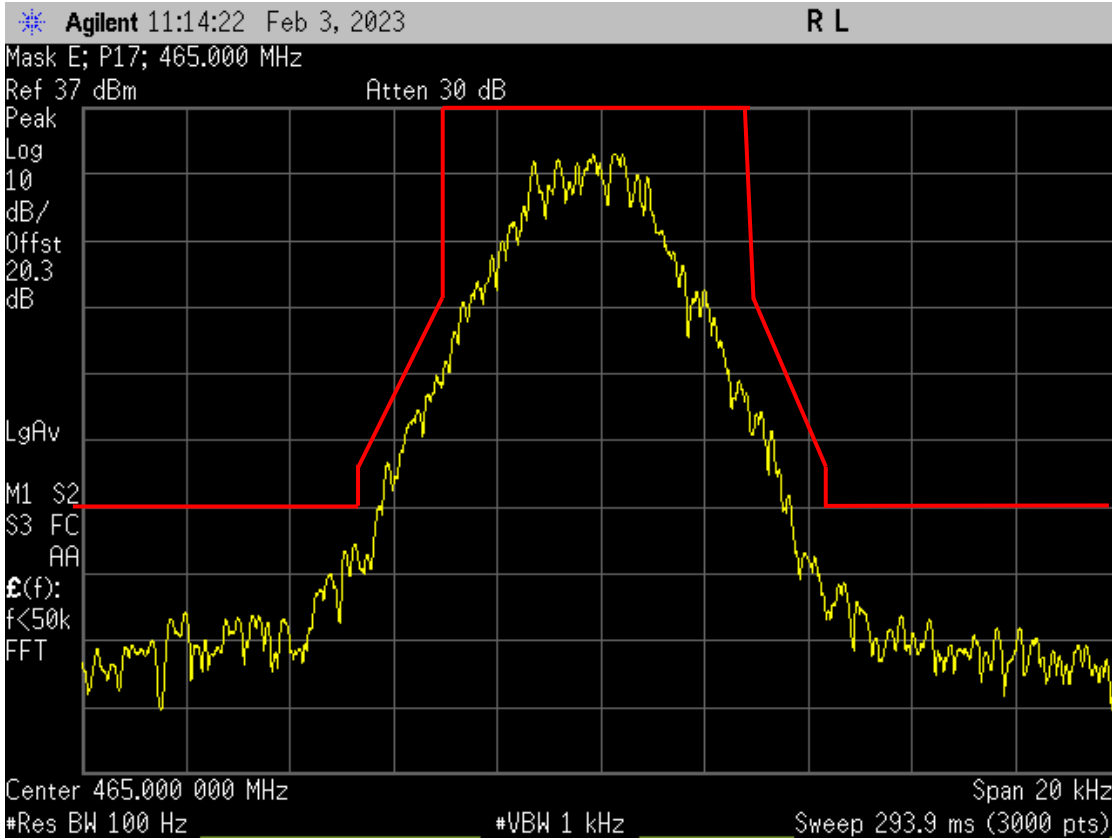

4.8 kbps; Mask E

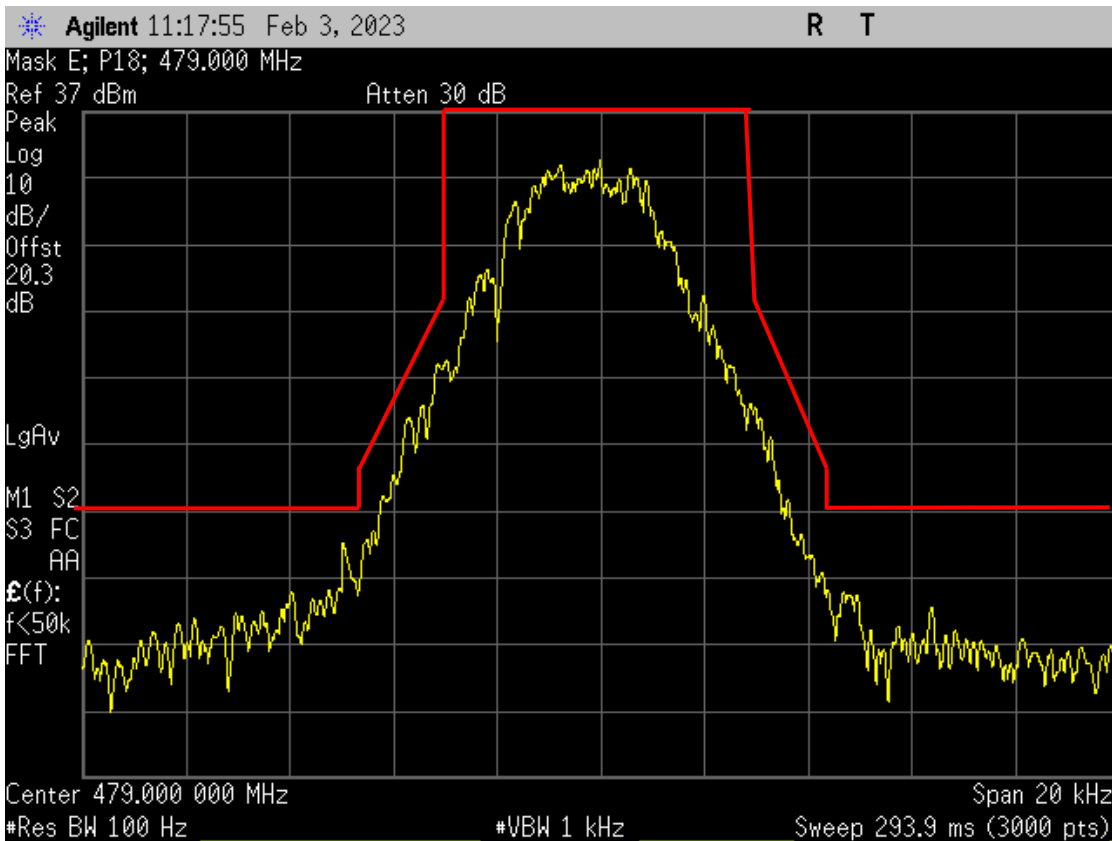

4.8 kbps; Mask E

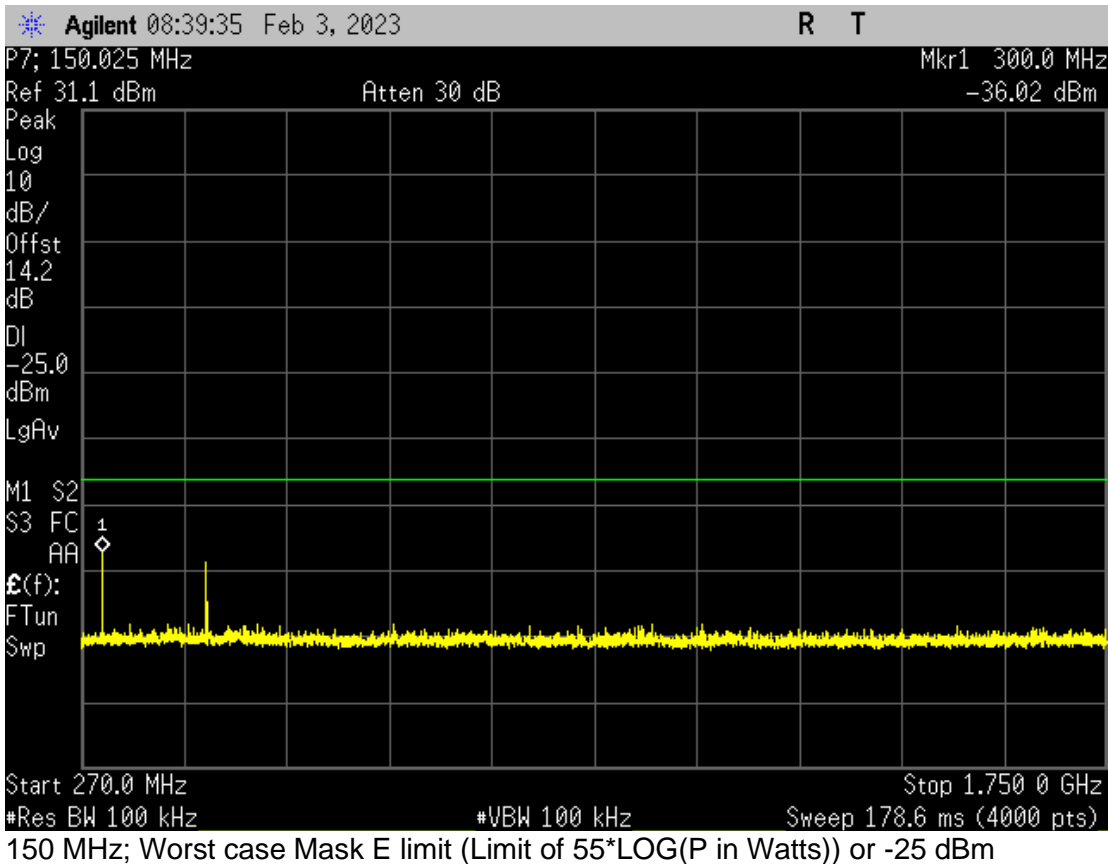
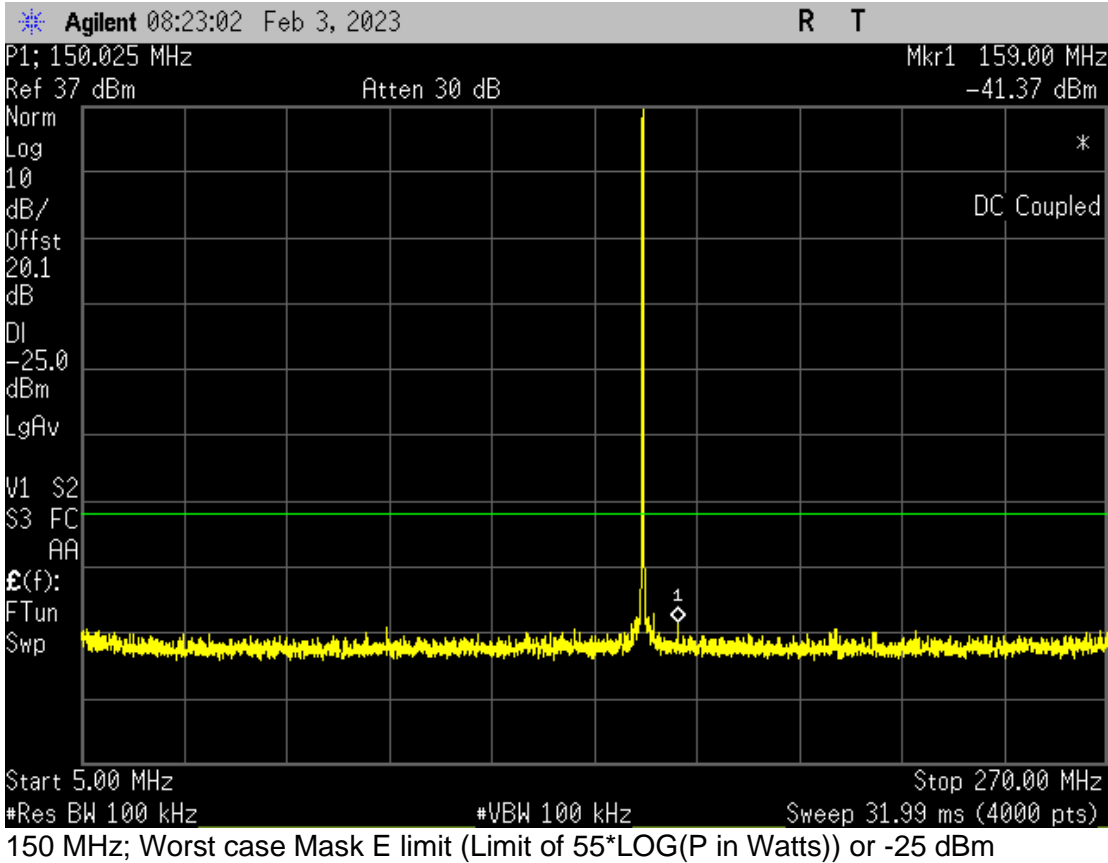

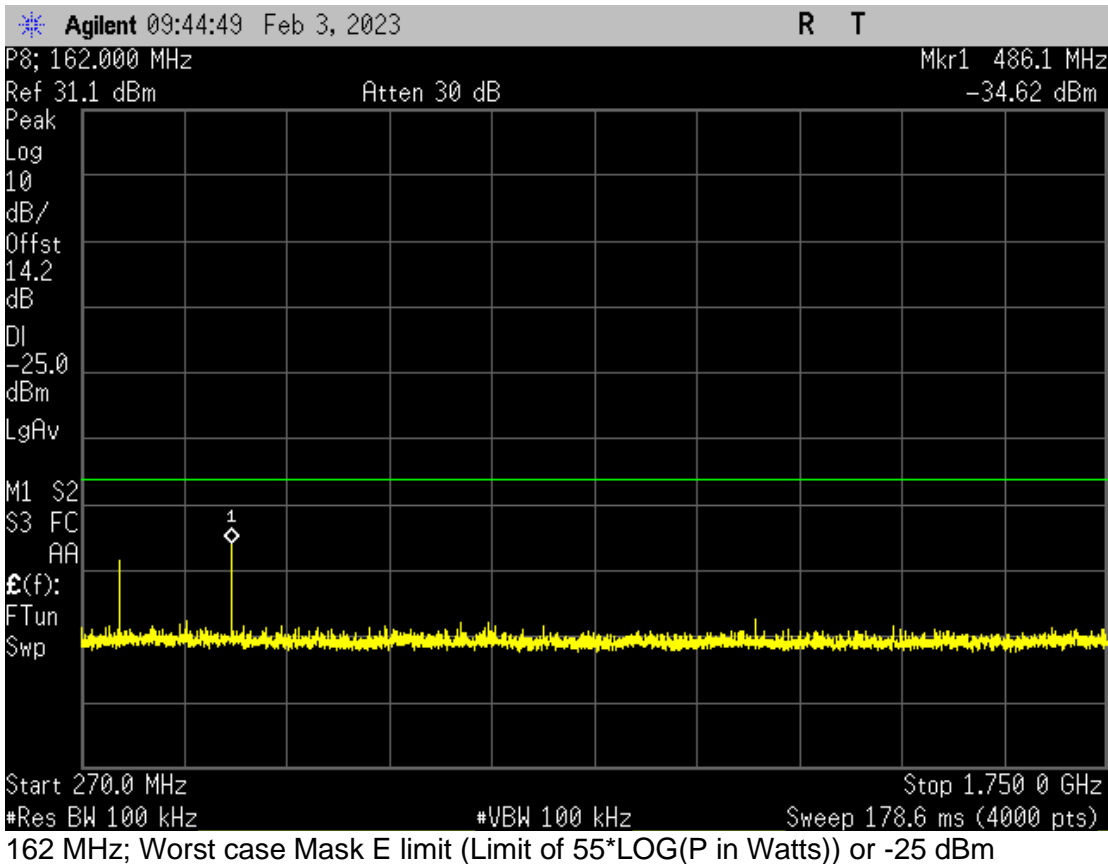
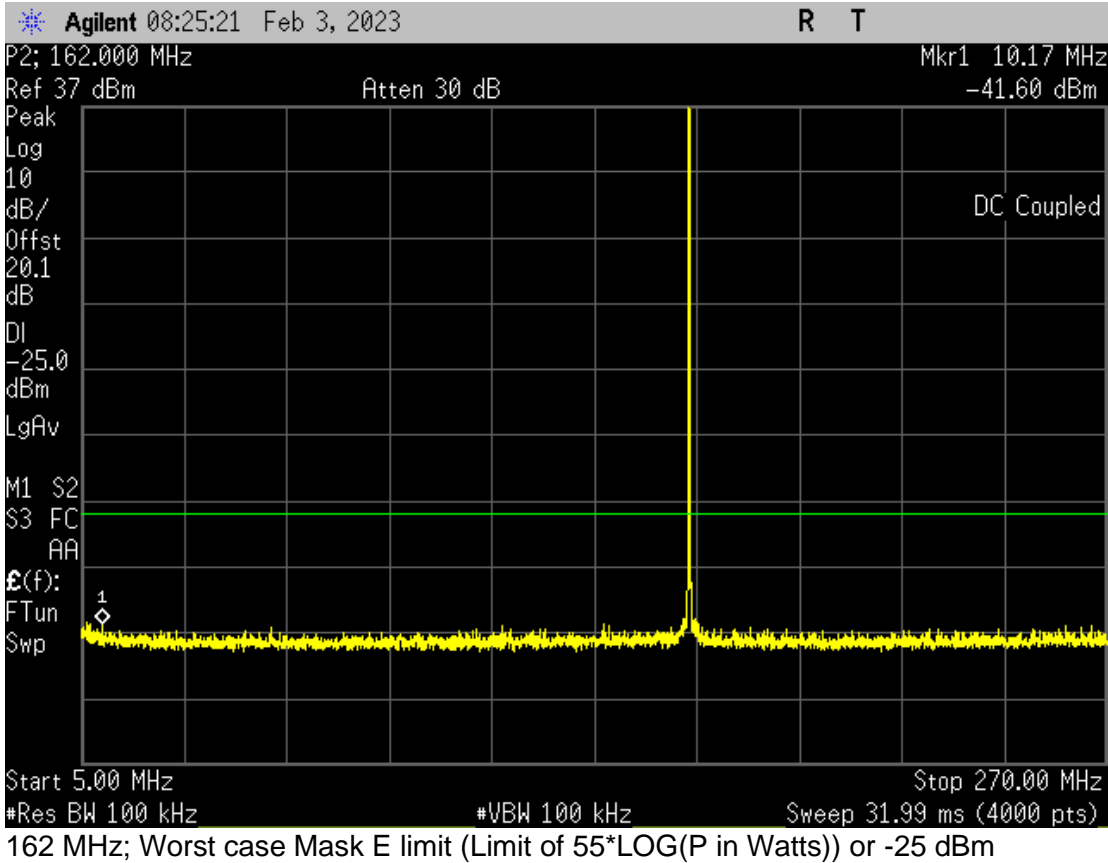

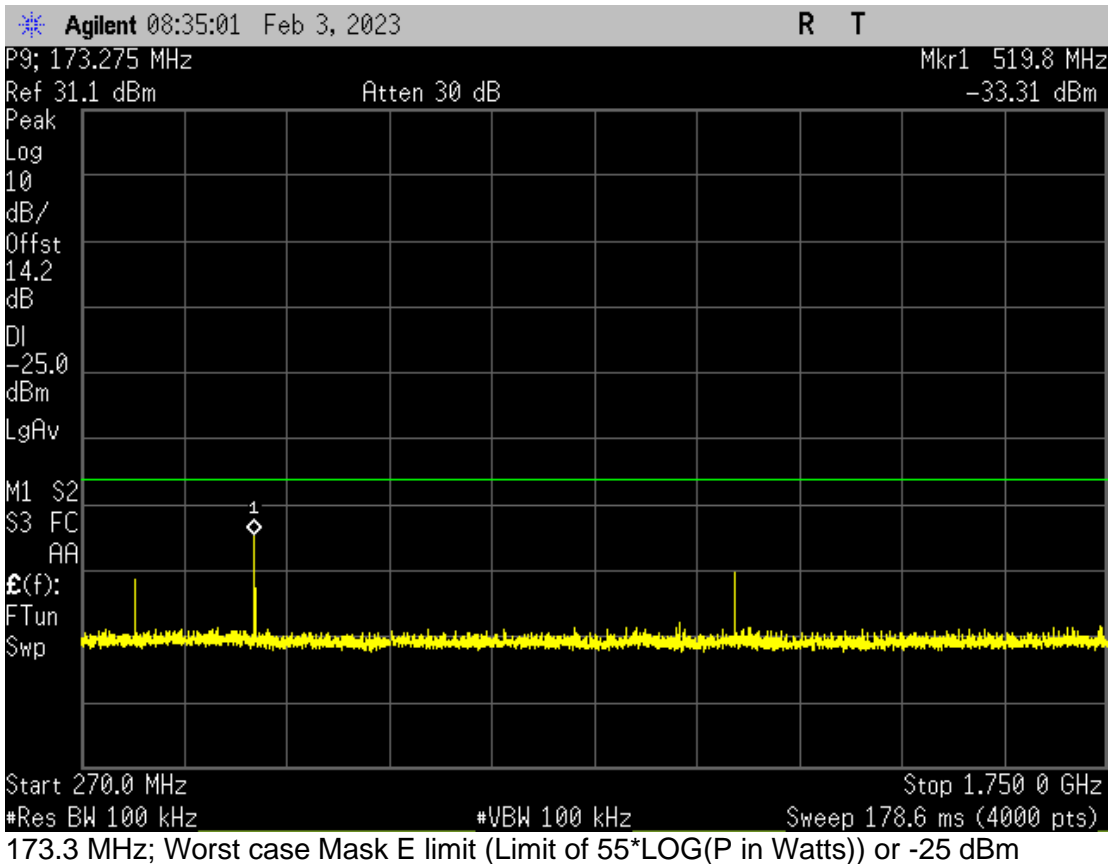
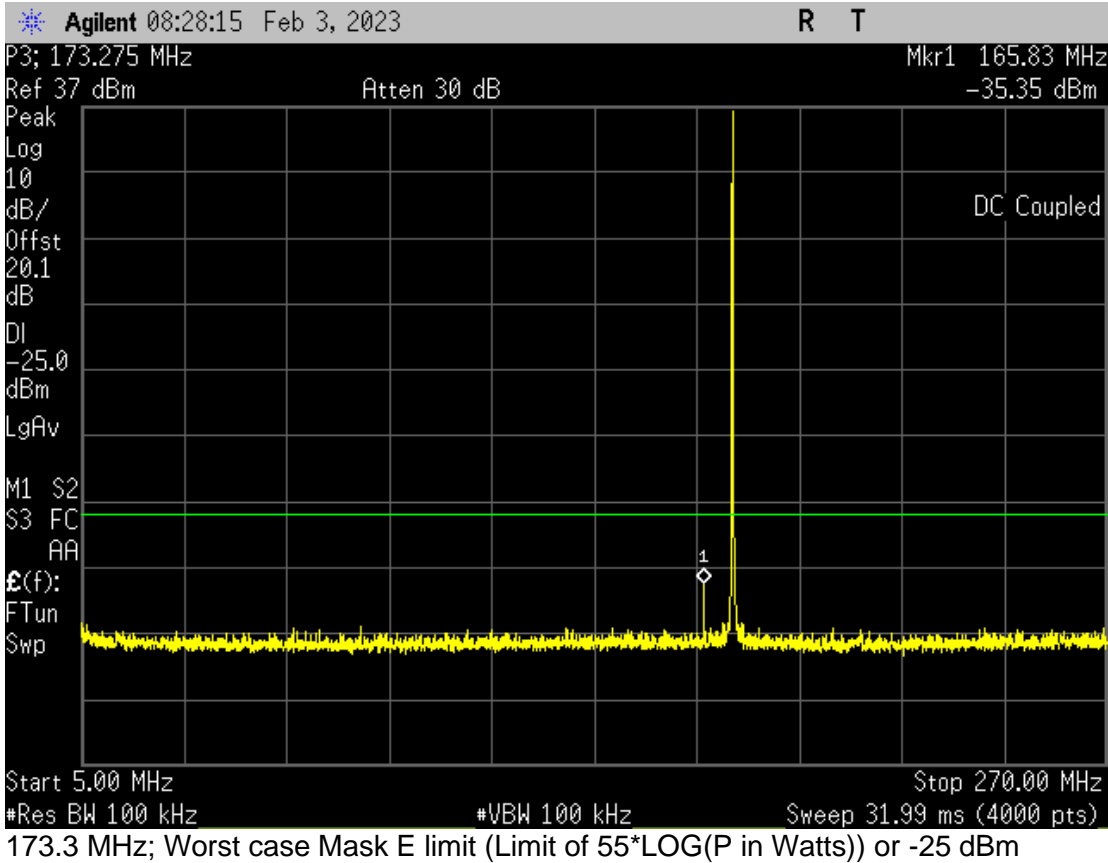

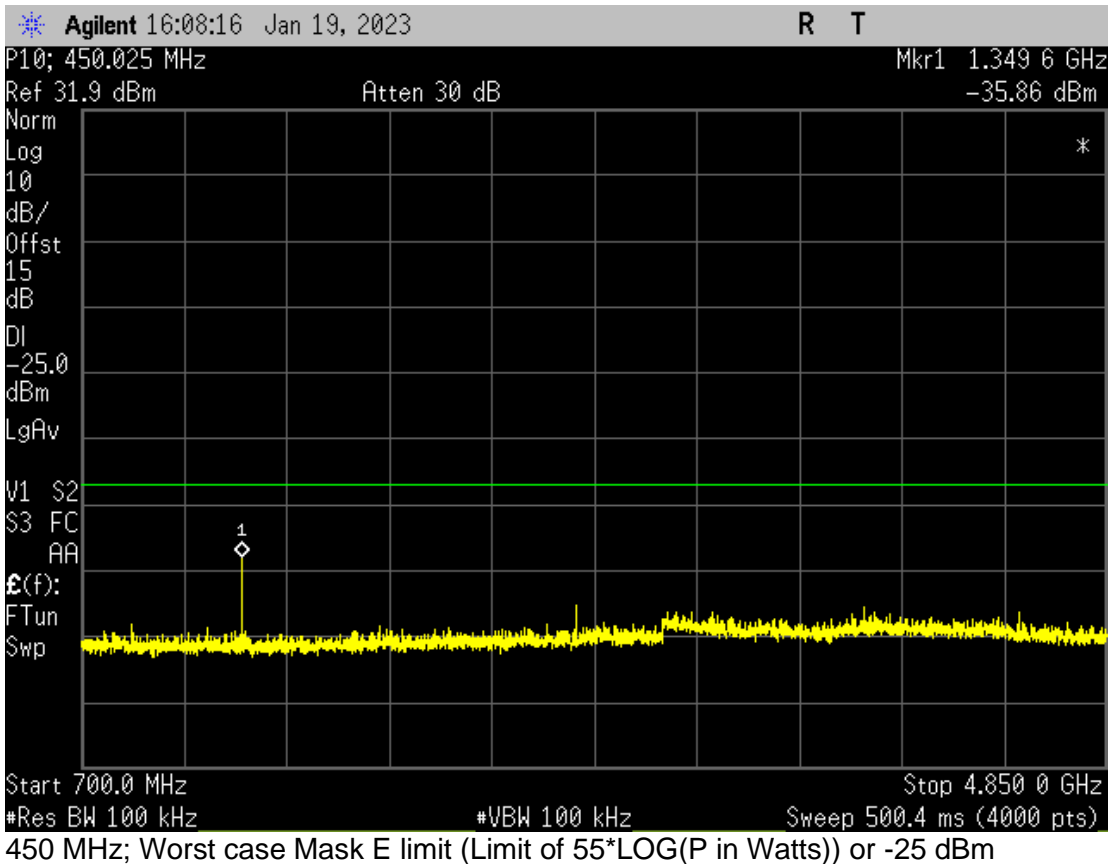
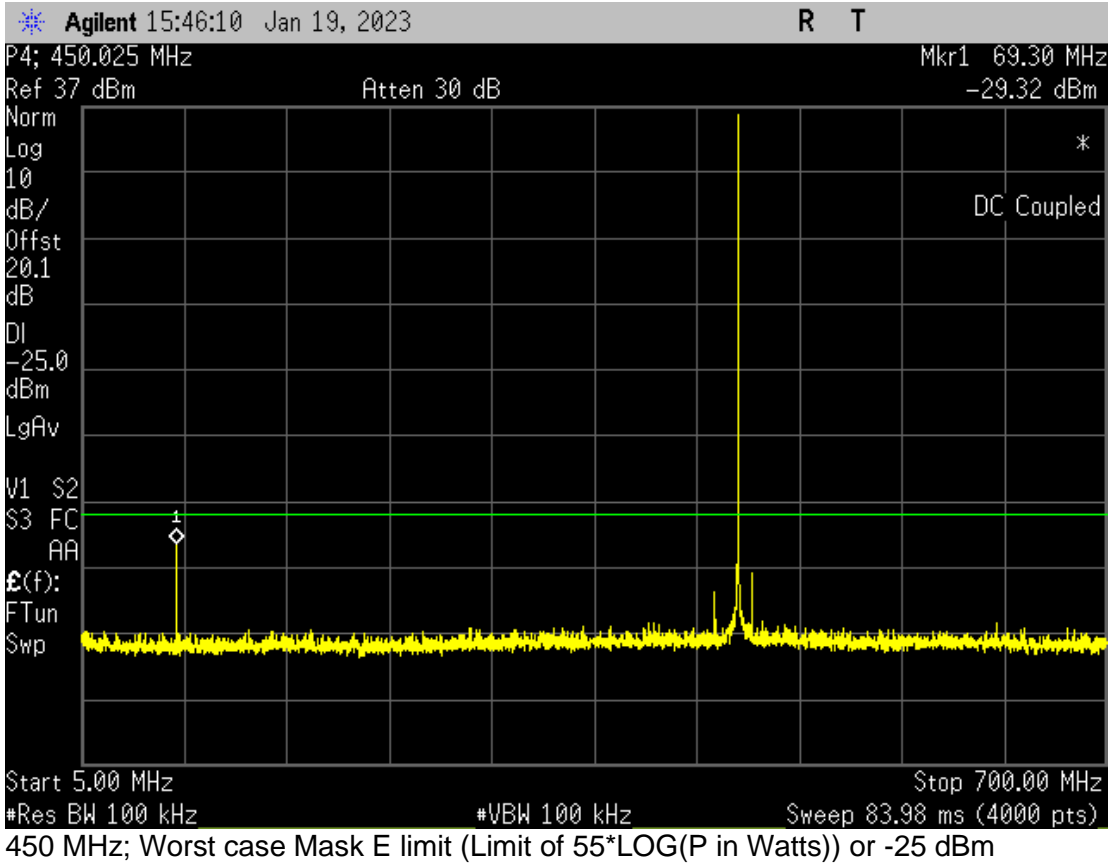

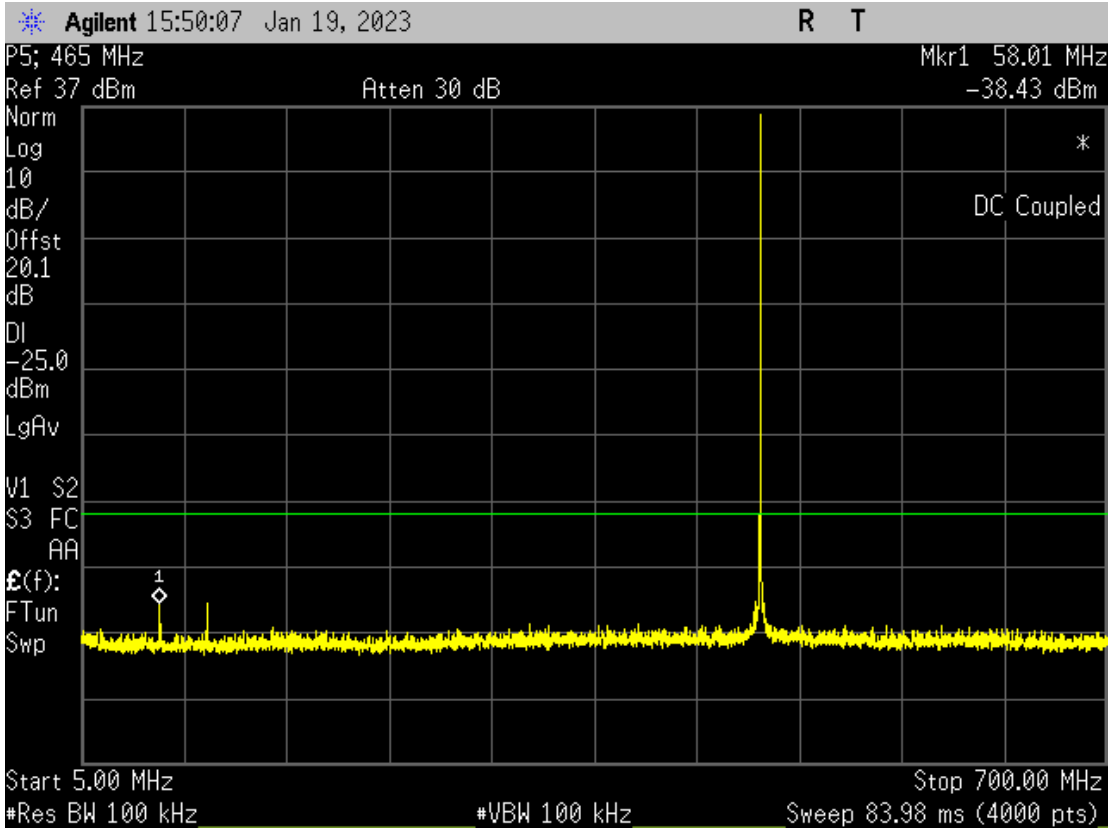

465 MHz; Worst case Mask E limit (Limit of $55 \cdot \text{LOG}(P \text{ in Watts})$) or -25 dBm

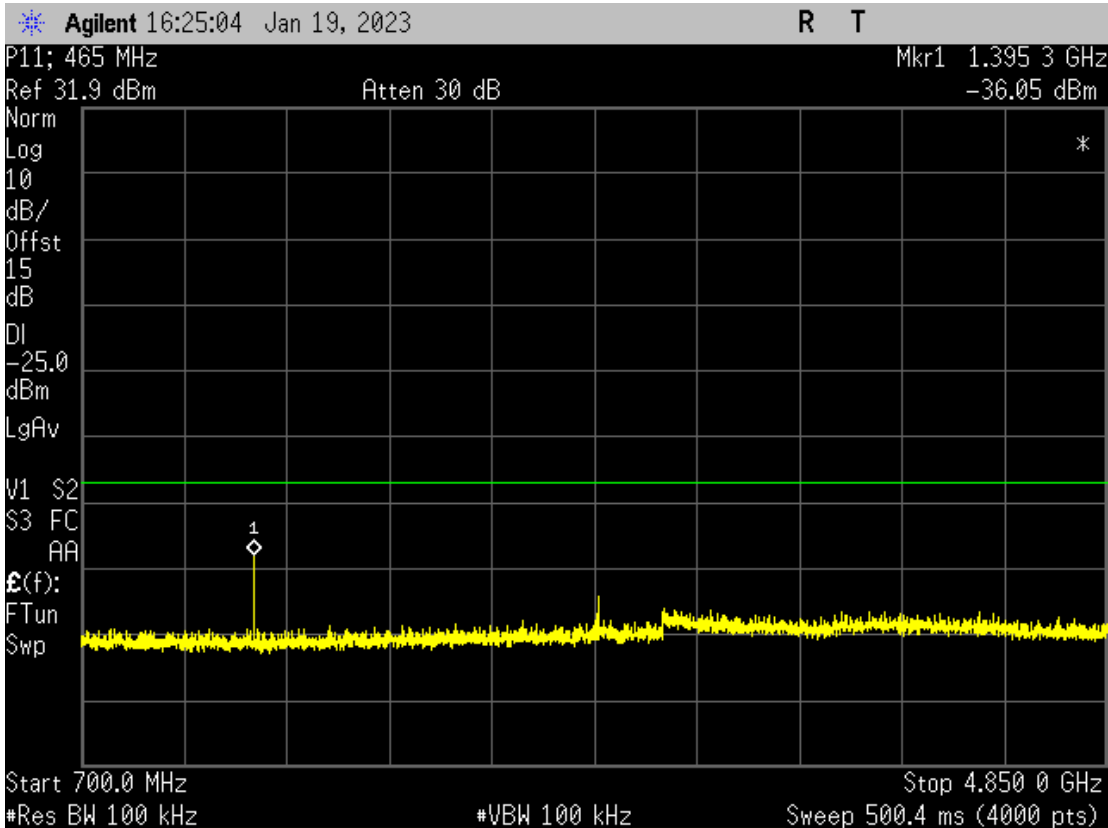

465 MHz; Worst case Mask E limit (Limit of $55 \cdot \text{LOG}(P \text{ in Watts})$) or -25 dBm

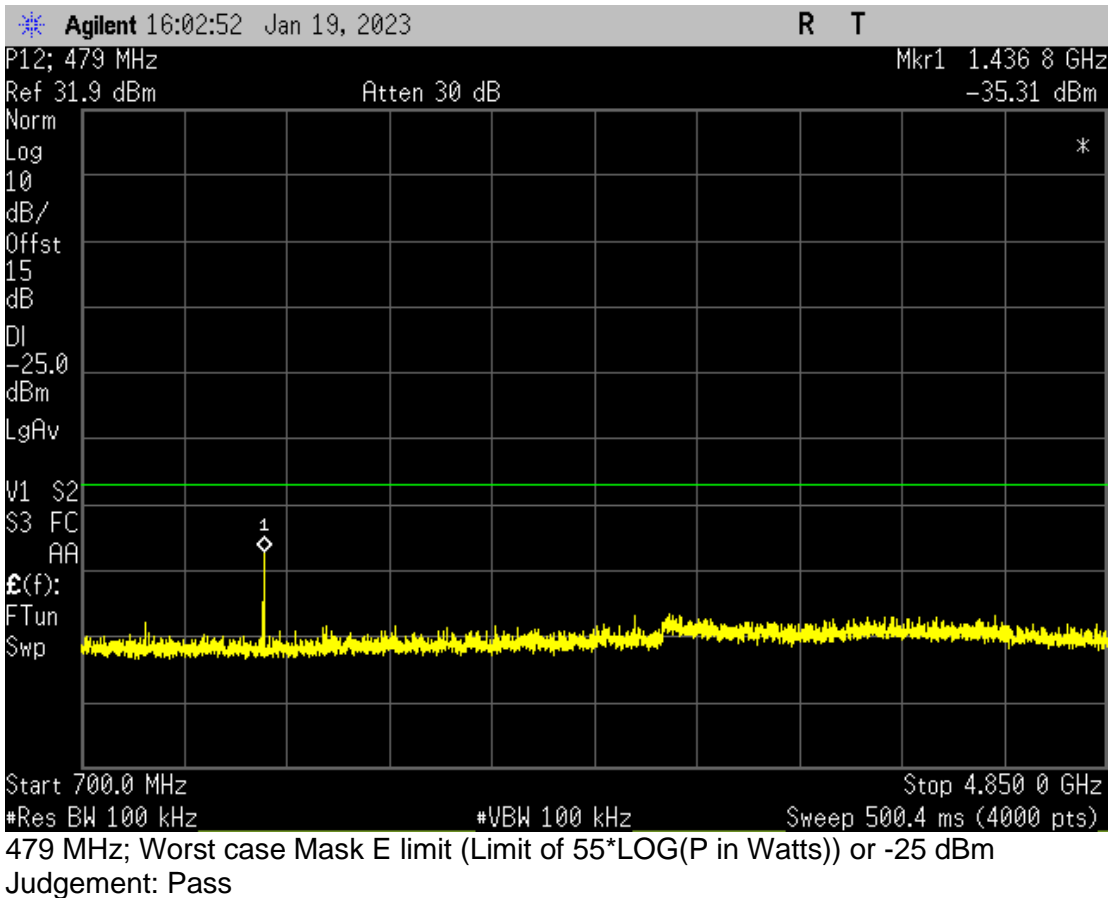
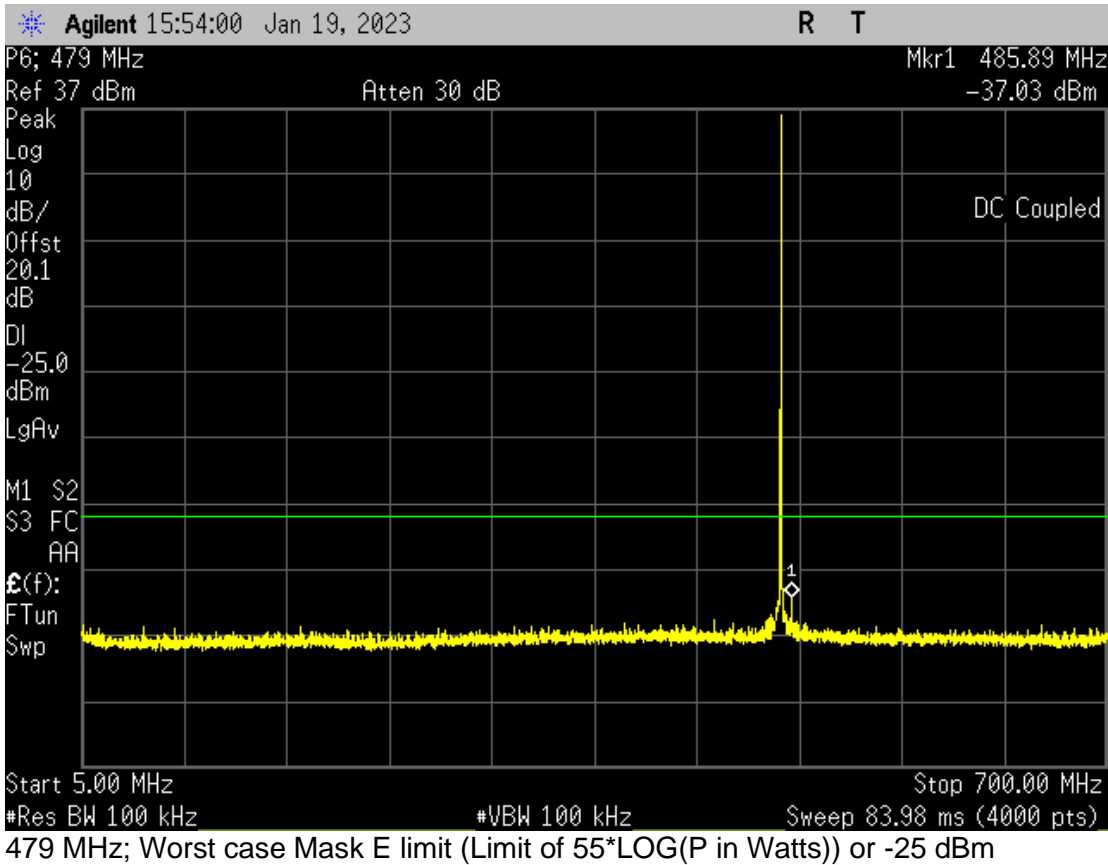



10.3 Occupied Bandwidth

Model	37337-X2	Specification	FCC part 90
Serial Number	023	Test Personnel	Joseph Strzelecki
Test Date	February 3, 2023	Test Location	Chamber B
Test Equipment	Spectrum Analyzer (REC-44)		

Channel MHz	12.5 kHz	25 kHz
	9.6 kbps	19.2 kbps
	99% OBW; All results in kHz	
150.025	7.2423	11.3861
162.000	7.1984	11.9148
173.300	7.4061	11.6212
450.0250	7.1369	11.3052
465.000	7.2444	11.8508
479.000	7.3438	11.7168

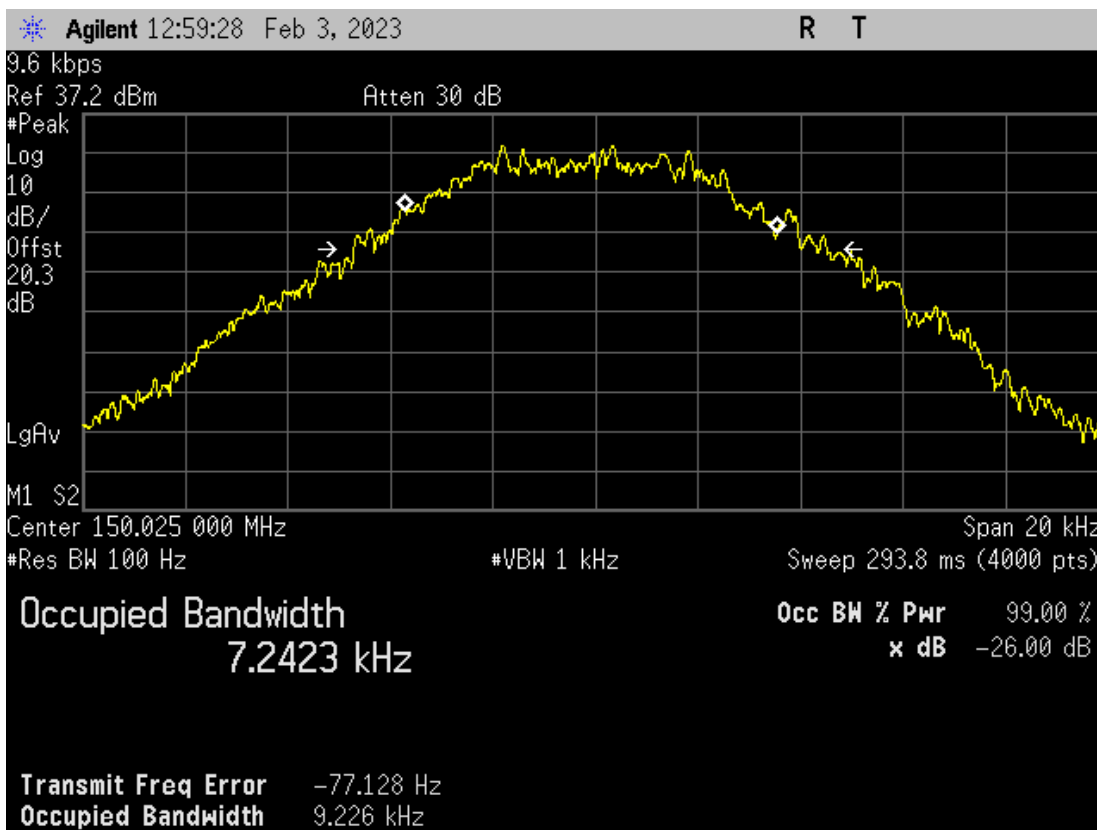

4GFSK; 9.6 kbps; 99% OBW

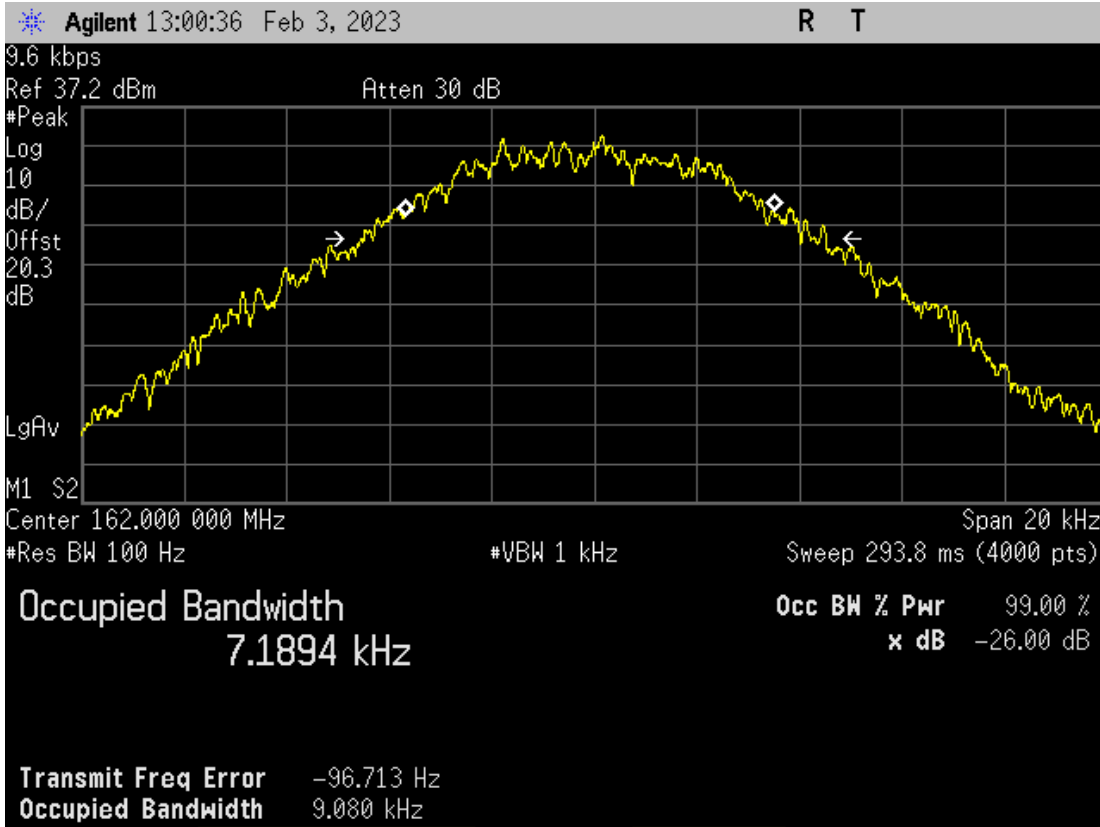

4GFSK; 9.6 kbps; 99% OBW

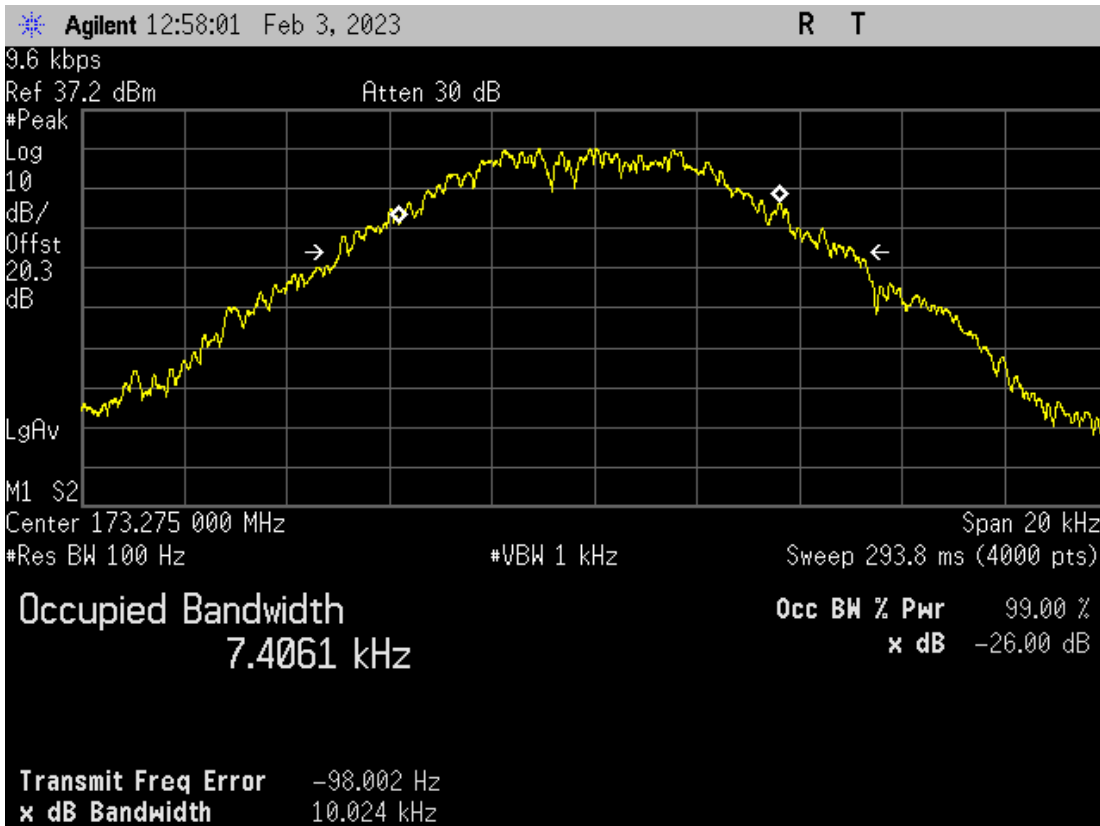

4GFSK; 9.6 kbps; 99% OBW

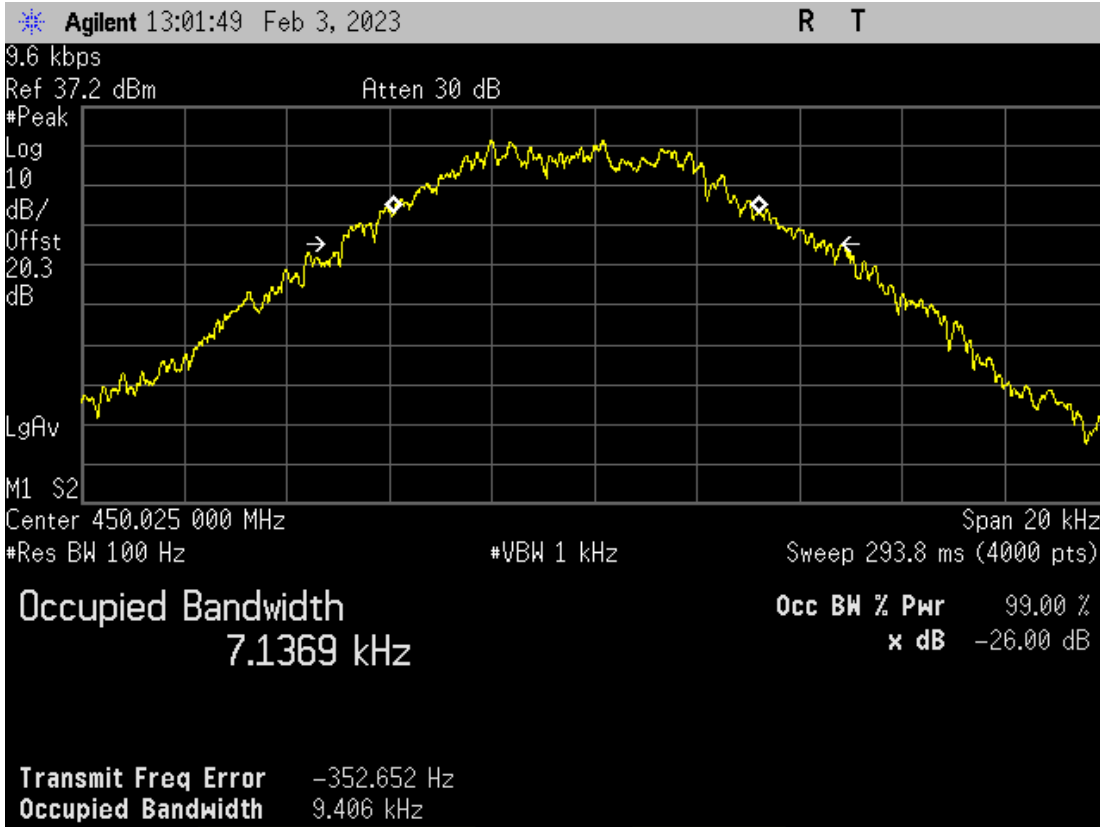

4GFSK; 9.6 kbps; 99% OBW

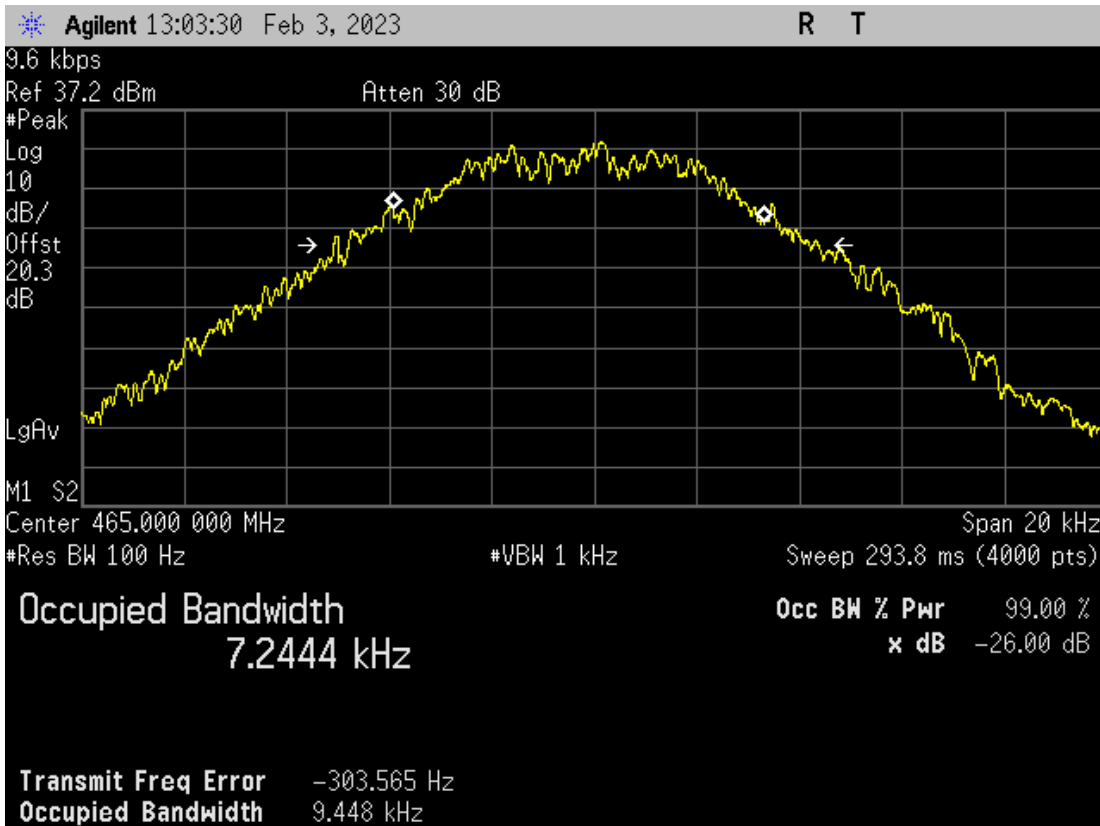

4GFSK; 9.6 kbps; 99% OBW

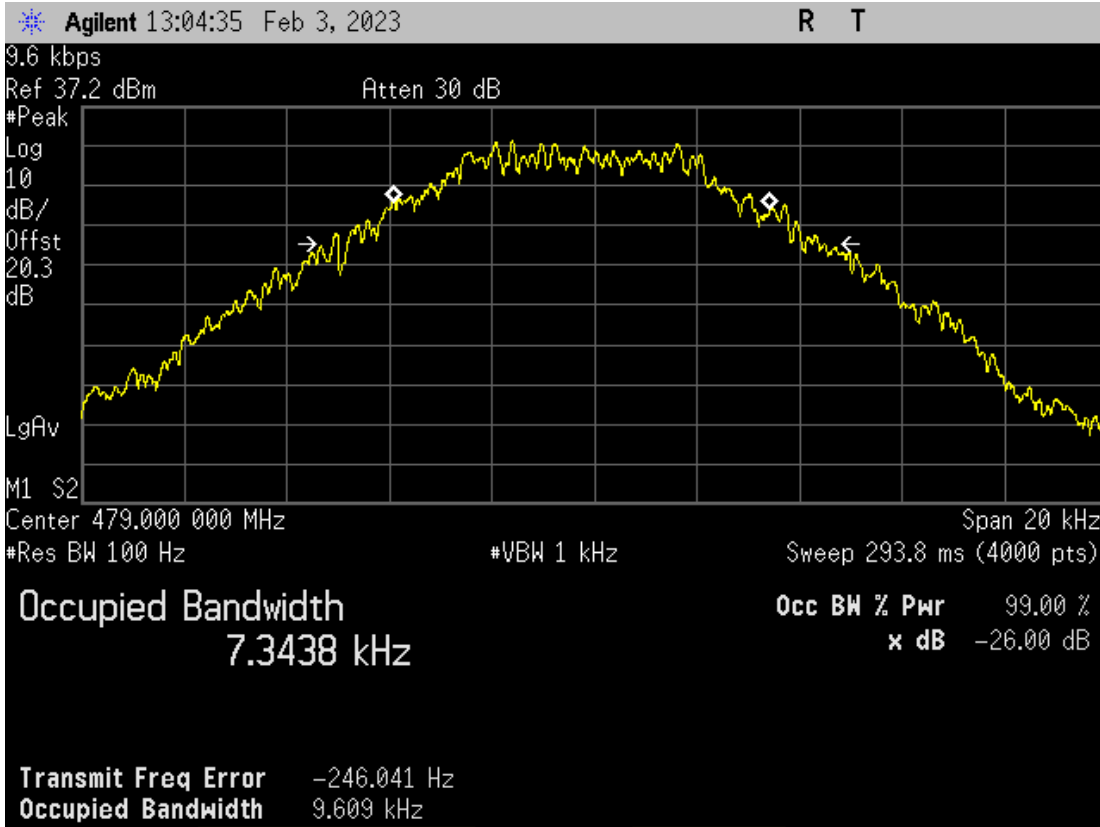

4GFSK; 9.6 kbps; 99% OBW

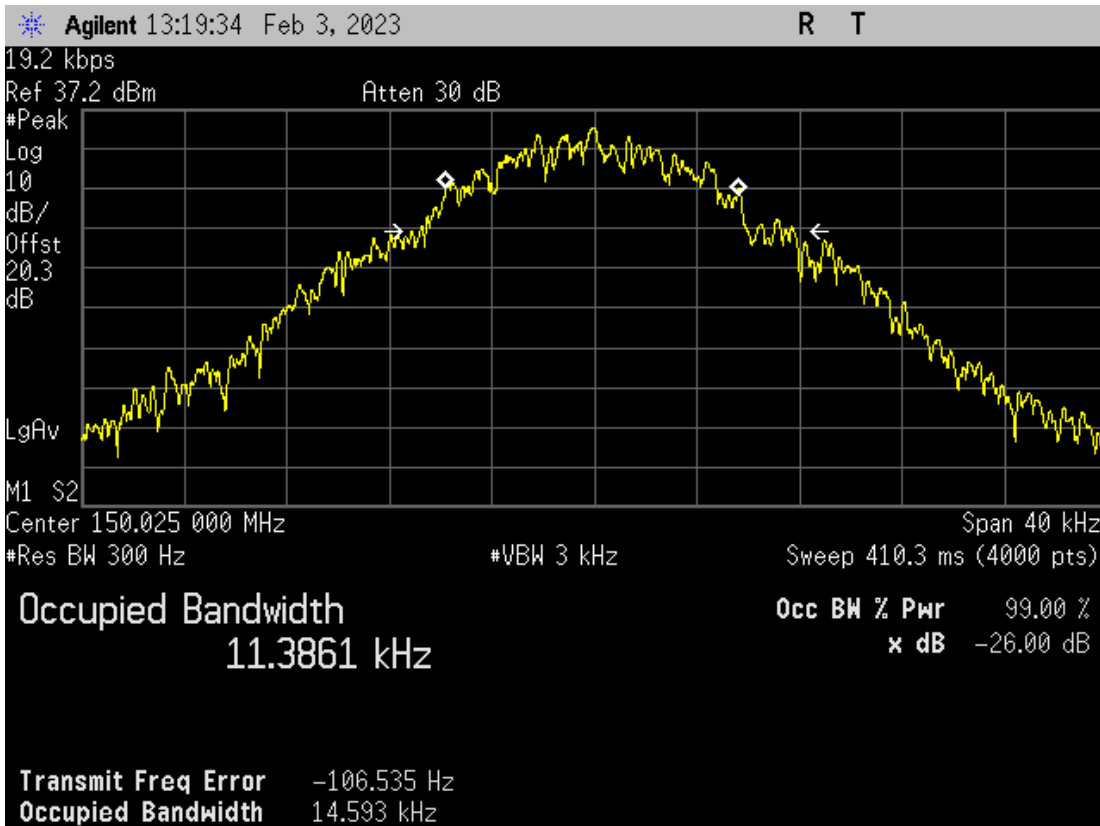

4GFSK; 19.2 kbps; 99% OBW



4GFSK; 19.2 kbps; 99% OBW

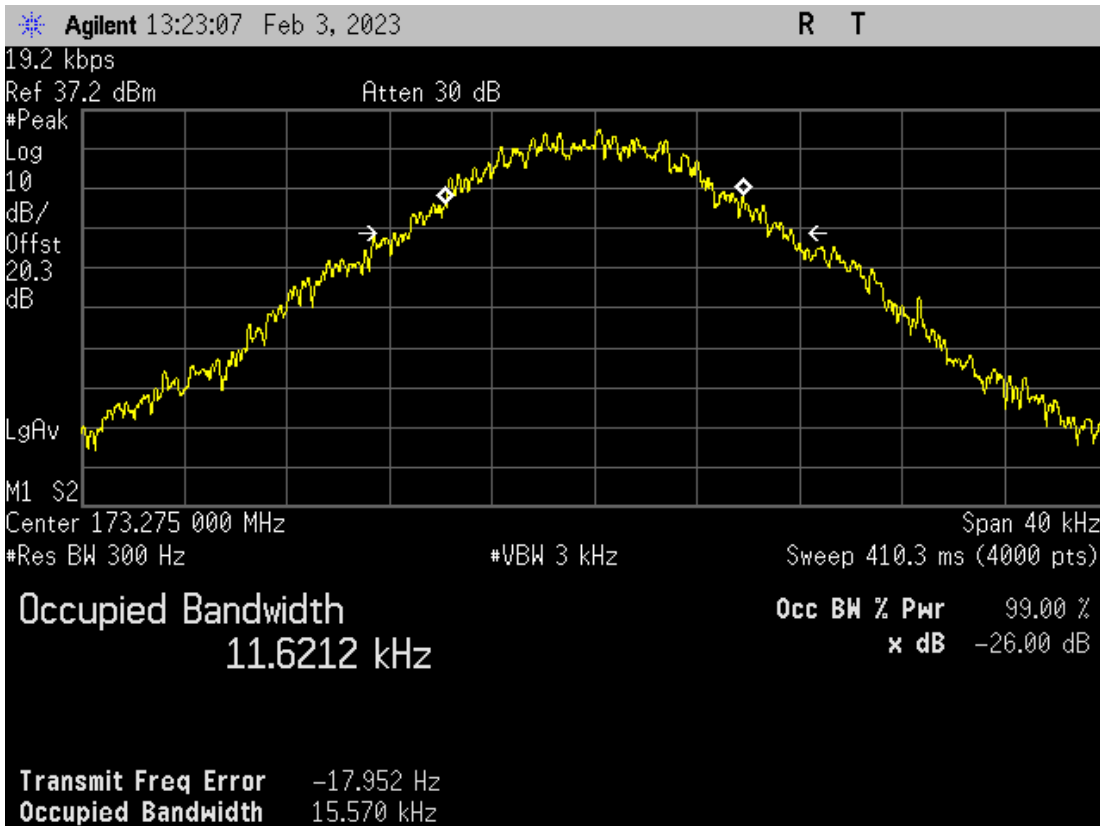

4GFSK; 19.2 kbps; 99% OBW

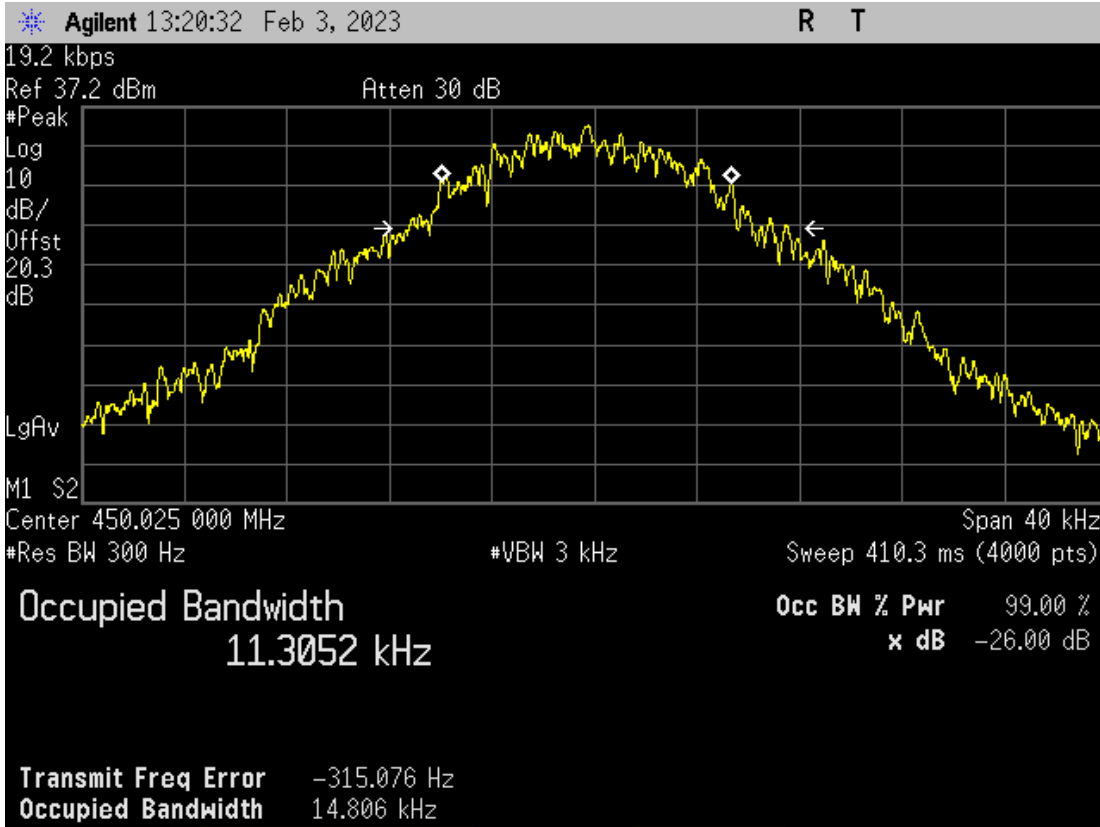

4GFSK; 19.2 kbps; 99% OBW #46

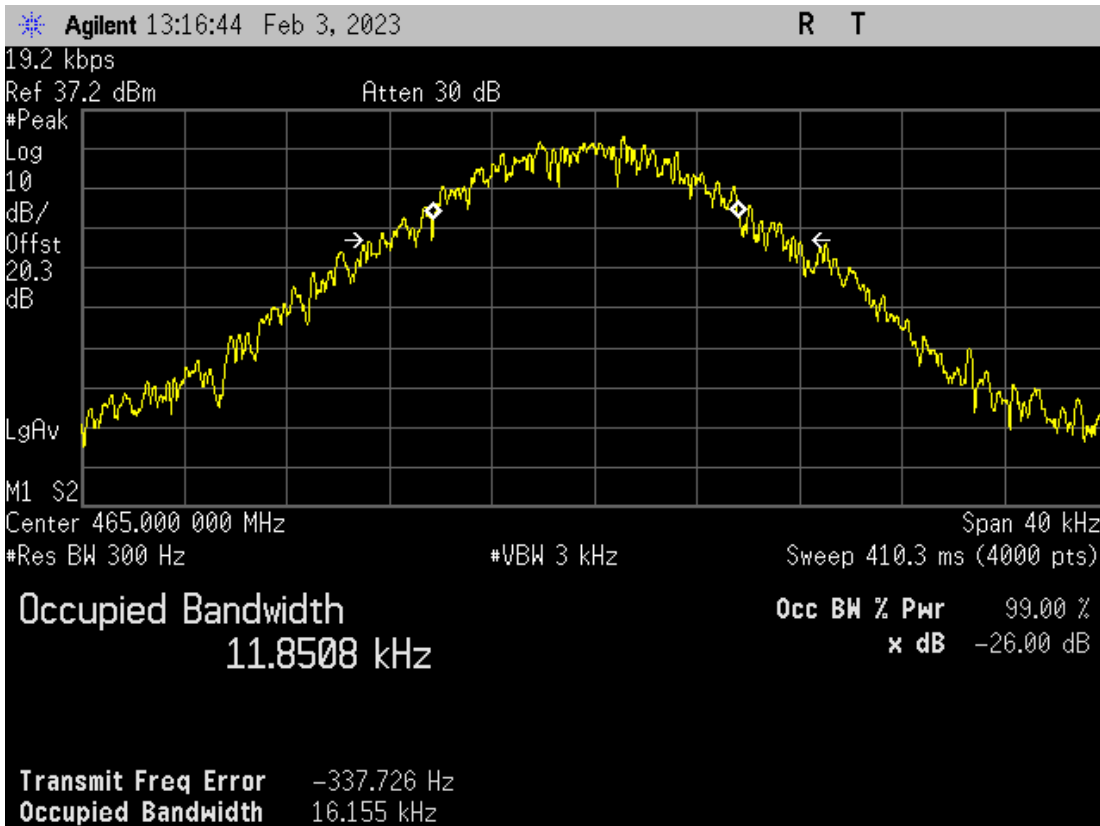

4GFSK; 19.2 kbps; 99% OBW

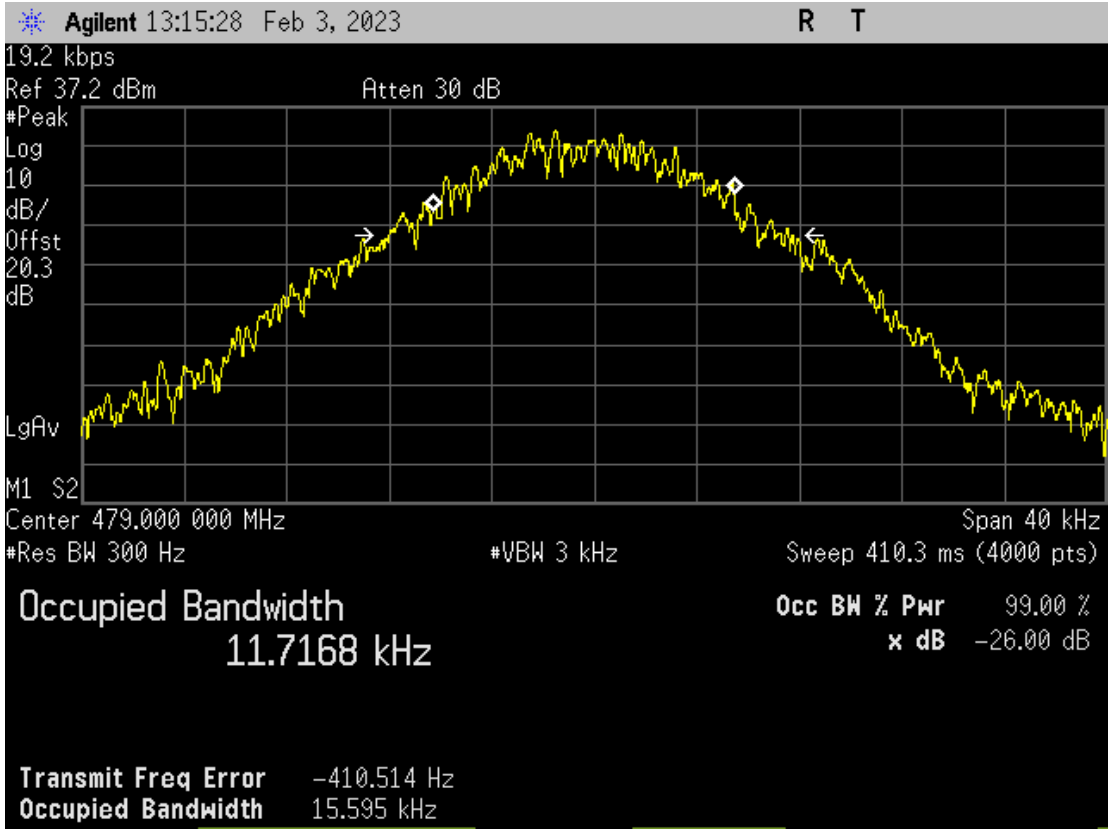

4GFSK; 19.2 kbps; 99% OBW



10.3.1 Conducted Spurious Emissions

Model	37337-X2	Specification	FCC Part 90.210 RSS-119 Section 5.8
Serial Number	047	Test Date	January 25, 2023
Test Personnel	Joseph Strzelecki	Test Location	Chamber B
Test Equipment	EMI Receiver (REC-44); Attenuator (ATT-53)		

This is a direct measurement from the Antenna port to the EMI Receiver

Freq. Tx	Harm	Tested Freq.	Rec Reading	HPF Attn. Factor	Ext. Atten. Factor	Cable Loss	Total Power	Power Limit	Margin Under Limit
MHz	#	MHz	dBm	dB	dB	dB	dBm	dBm	dB
150.0250	2	300.0500	-52.6	0.4	19.9	0.2	-32.1	-20.0	12.1
150.0250	3	450.0750	-56.6	0.4	19.9	0.2	-36.1	-20.0	16.1
150.0250	4	600.1000	-65.4	0.4	19.9	0.3	-44.8	-20.0	24.8
150.0250	5	750.1250	-70.0	0.5	19.9	0.3	-49.3	-20.0	29.3
150.0250	6	900.1500	-70.0	0.6	19.9	0.3	-49.2	-20.0	29.2
150.0250	7	1050.1750	-70.0	0.5	19.9	0.3	-49.3	-20.0	29.3
150.0250	8	1200.2000	-70.0	0.8	19.9	0.4	-48.9	-20.0	28.9
150.0250	9	1350.2250	-70.0	1.0	19.9	0.4	-48.7	-20.0	28.7
150.0250	10	1500.2500	-70.0	1.0	19.9	0.4	-48.7	-20.0	28.7
162.0000	2	324.0000	-52.2	0.4	19.9	0.2	-31.7	-20.0	11.7
162.0000	3	486.0000	-48.3	0.4	19.9	0.3	-27.7	-20.0	7.7
162.0000	4	648.0000	-63.5	0.4	19.9	0.3	-42.9	-20.0	22.9
162.0000	5	810.0000	-70.0	0.5	19.9	0.3	-49.3	-20.0	29.3
162.0000	6	972.0000	-70.0	0.6	19.9	0.3	-49.2	-20.0	29.2
162.0000	7	1134.0000	-70.0	0.5	19.9	0.4	-49.2	-20.0	29.2
162.0000	8	1296.0000	-70.0	0.8	19.9	0.4	-48.9	-20.0	28.9
162.0000	9	1458.0000	-70.0	1.0	19.9	0.4	-48.7	-20.0	28.7
162.0000	10	1620.0000	-70.0	1.0	19.9	0.4	-48.7	-20.0	28.7
173.2750	2	346.5500	-57.5	0.4	19.9	0.2	-37.0	-20.0	17.0
173.2750	3	519.8250	-48.4	0.4	19.9	0.3	-27.8	-20.0	7.8
173.2750	4	693.1000	-68.1	0.4	19.9	0.3	-47.5	-20.0	27.5
173.2750	5	866.3750	-66.5	0.5	19.9	0.3	-45.8	-20.0	25.8
173.2750	6	1039.6500	-55.9	0.6	19.9	0.3	-35.1	-20.0	15.1
173.2750	7	1212.9250	-61.8	0.5	19.9	0.4	-41.0	-20.0	21.0
173.2750	8	1386.2000	-63.2	0.8	19.9	0.4	-42.1	-20.0	22.1
173.2750	9	1559.4750	-66.4	1.0	19.9	0.4	-45.1	-20.0	25.1
173.2750	10	1732.7500	-68.4	1.0	19.9	0.5	-47.0	-20.0	27.0
450.0250	2	900.0500	-61.0	0.4	14.0	0.3	-46.3	-20.0	26.3
450.0250	3	1350.0750	-46.5	0.4	14.0	0.4	-31.7	-20.0	11.7
450.0250	4	1800.1000	-64.6	0.4	14.0	0.5	-49.7	-20.0	29.7
450.0250	5	2250.1250	-62.3	0.5	14.0	0.6	-47.2	-20.0	27.2
450.0250	6	2700.1500	-62.1	0.6	14.0	0.6	-46.9	-20.0	26.9
450.0250	7	3150.1750	-56.5	0.5	14.0	0.6	-41.4	-20.0	21.4
450.0250	8	3600.2000	-61.3	0.8	14.0	0.7	-45.8	-20.0	25.8
450.0250	9	4050.2250	-57.6	1.0	14.0	0.7	-41.9	-20.0	21.9
450.0250	10	4500.2500	-67.0	1.0	14.0	0.7	-51.3	-20.0	31.3
460.0000	2	920.0000	-60.6	0.4	14.0	0.3	-45.9	-20.0	25.9
460.0000	3	1380.0000	-47.1	0.4	14.0	0.4	-32.3	-20.0	12.3
460.0000	4	1840.0000	-64.1	0.4	14.0	0.5	-49.2	-20.0	29.2
460.0000	5	2300.0000	-59.3	0.5	14.0	0.5	-44.3	-20.0	24.3



Freq. Tx MHz	Harm #	Tested Freq. MHz	Rec Reading dBm	HPF Attn. Factor dB	Ext. Atten. Factor dB	Cable Loss dB	Total Power dBm	Power Limit dBm	Margin Under Limit dB
460.0000	6	2760.0000	-58.7	0.6	14.0	0.6	-43.5	-20.0	23.5
460.0000	7	3220.0000	-64.3	0.5	14.0	0.6	-49.2	-20.0	29.2
460.0000	8	3680.0000	-60.7	0.8	14.0	0.7	-45.2	-20.0	25.2
460.0000	9	4140.0000	-70.0	1.0	14.0	0.7	-54.3	-20.0	34.3
460.0000	10	4600.0000	-68.2	1.0	14.0	0.7	-52.5	-20.0	32.5
469.9750	2	939.9500	-59.4	0.4	14.0	0.3	-44.7	-20.0	24.7
469.9750	3	1409.9250	-47.3	0.4	14.0	0.4	-32.5	-20.0	12.5
469.9750	4	1879.9000	-63.0	0.4	14.0	0.5	-48.1	-20.0	28.1
469.9750	5	2349.8750	-59.5	0.5	14.0	0.5	-44.5	-20.0	24.5
469.9750	6	2819.8500	-65.5	0.6	14.0	0.6	-50.3	-20.0	30.3
469.9750	7	3289.8250	-60.1	0.5	14.0	0.6	-45.0	-20.0	25.0
469.9750	8	3759.8000	-60.9	0.8	14.0	0.7	-45.4	-20.0	25.4
469.9750	9	4229.7750	-66.8	1.0	14.0	0.8	-51.0	-20.0	31.0
469.9750	10	4699.7500	-69.4	1.0	14.0	0.7	-53.7	-20.0	33.7
479.0000	2	958.0000	-57.3	0.4	14.0	0.3	-42.6	-20.0	22.6
479.0000	3	1437.0000	-46.0	0.4	14.0	0.4	-31.2	-20.0	11.2
479.0000	4	1916.0000	-63.5	0.4	14.0	0.5	-48.6	-20.0	28.6
479.0000	5	2395.0000	-55.9	0.5	14.0	0.5	-40.9	-20.0	20.9
479.0000	6	2874.0000	-61.7	0.6	14.0	0.6	-46.5	-20.0	26.5
479.0000	7	3353.0000	-57.2	0.5	14.0	0.7	-42.0	-20.0	22.0
479.0000	8	3832.0000	-61.3	0.8	14.0	0.7	-45.8	-20.0	25.8
479.0000	9	4311.0000	-66.5	1.0	14.0	0.8	-50.7	-20.0	30.7
479.0000	10	4790.0000	-68.5	1.0	14.0	0.8	-52.7	-20.0	32.7

Judgment: Passed by at least 7.7 dB.

10.4 Field Strength of Unwanted Spurious Radiation

10.4.1 Test Procedures

Radiated emission measurements in the Restricted bands were performed with linearly polarized broadband antennas. The results obtained with these antennas can be correlated with results obtained with a tuned dipole antenna. A 10 dB linearity check is performed prior to start of testing in order to determine if an overload condition exists. From 30 to 4700 MHz, a spectrum analyzer with a preselector was used for measurement. Radiated emissions measurements were performed at the anechoic chamber at a test distance of 3 meters. The entire frequency range from 30 to 4700 MHz was slowly scanned and the emissions in the restricted frequency bands were recorded. Measurements were performed using the peak detector function.

The spectrum analyzer was adjusted for the following settings:

- 1) Resolution Bandwidth = 100 kHz for spurious emissions below 1 GHz, and 1 MHz for spurious emissions above 1GHz.
- 2) Video Bandwidth = 300 kHz for spurious emissions below 1 GHz, and 3 MHz for spurious emissions above 1 GHz.
- 3) Sweep Speed slow enough to maintain measurement calibration.
- 4) Detector Mode = Positive Peak.



The transmitter to be tested was placed on the turntable in the standard test site, or an FCC listed site compliant with ANSI C63.4. The transmitter is transmitting into a non-radiating load that is placed on the turntable. Measurements were made from the lowest radio frequency generated in the equipment to the tenth harmonic of the carrier. The transmitter was keyed during the tests.

For each spurious frequency, the test antenna was raised and lowered from 1 m to 4m to obtain a maximum reading on the spectrum analyzer with the test antenna at horizontal polarity. Then the turntable was rotated 360° to determine the maximum reading. This procedure was repeated to obtain the highest possible reading. This maximum reading was recorded.

Each measurement was repeated for each spurious frequency with the test antenna polarized vertically.

Figure 1. Drawing of Radiated Emissions Setup

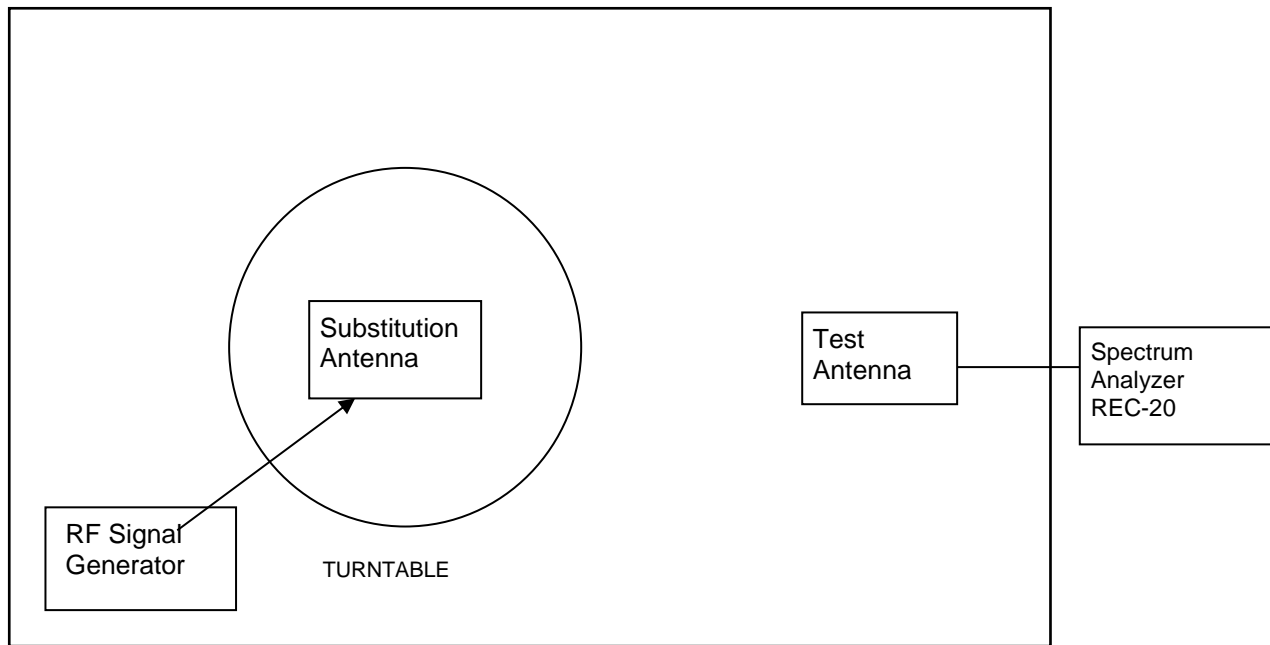

ANSI C63.4 Listed Test Site

- Notes:**
- Test Antenna height varied from 1 to 4 meters
 - Distance from antenna to tested system is 3 meters
 - Not to Scale

Frequency MHz	Test Antenna	Substitution Antenna	Receiver to Coupler	Signal Generator
30 - 200	ANT-79	ANT-80	REC-21	SIG-31
200 - 1000	ANT-06	ANT-68	REC-21	SIG-31
1000-5000	ANT-13	ANT-36	REC-21	SIG-31



The transmitter was removed and replaced with a broadband substitution antenna. The substitution antenna is calibrated so that the gain relative to a dipole is known. The center of the substitution antenna was approximately at the same location as the center of the transmitter.

The substitution antenna was fed at the transmitter end with a signal generator connected to the antenna by means of a non-radiating cable. With the antennas at both ends horizontally polarized, and with the signal generator tuned to a particular spurious frequency, the test antenna was raised and lowered to obtain a maximum reading at the spectrum analyzer. The level of the signal generator output was adjusted until the previously recorded maximum reading for this set of conditions was obtained.

The measurements were repeated with both antennas horizontally and vertically polarized for each spurious frequency.

The power in dBm into a reference ideal half-wave dipole antenna was calculated by reducing the readings obtained in steps k) and l) by the power loss in the cable between the generator and the antenna, and further corrected for the gain of the substitution antenna used relative to an ideal half-wave dipole antenna by the following formula:

$$Pd(\text{dBm}) = Pg(\text{dBm}) - \text{cable loss (dB)} + \text{antenna gain (dB)}$$

where:

Pd is the dipole equivalent power and

Pg is the generator output power into the substitution antenna.

The *Pd* levels recorded in step m) are the absolute levels of radiated spurious emissions in dBm.

Any emission must be attenuated below the power (P) of the highest emission contained within the authorized bandwidth as follows:

On any frequency removed from the center of the authorized bandwidth by a displacement frequency (fd in kHz) of more than 6.25 kHz: At least 55 + 10 log (P) dB.

Since by mathematical definition, P(dBm) – (55+10xLOG P(W)) = -25 dBm, the limit for spurious emissions was set to -25 dBm equivalent radiated power.

10.4.2 Spurious Radiated Emissions Test Results

Model	37337-X2	Specification	FCC Part 90.210 RSS-119 Section 5.8
Serial Number	047	Test Date	February 9, 10 & 20, 2023
Test Personnel	Chris Dalessio	Test Location	Chamber E
Test Distance	3 Meters	Notes	Transmit Mode

Harmonic #	Tx	Measured	Equivalent Radiated power		Limit dBm	Margin Under Limit	
	Freq MHz	Freq MHz	Vertical dBm	Horizontal dBm		Vertical dB	Horizontal dB
2	150.025	300.050	-57.5	-53.4	-20.0	37.5	33.4
3	150.025	450.075	-53.3	-54.3	-20.0	33.3	34.3
4	150.025	600.100	-54.2	-54.5	-20.0	34.2	34.5
5	150.025	750.125	-42.8	-37.2	-20.0	22.8	17.2
6	150.025	900.150	-43.5	-45.1	-20.0	23.5	25.1
7	150.025	1050.175	-48.4	-47.7	-20.0	28.4	27.7
8	150.025	1200.200	-45.5	-45.6	-20.0	25.5	25.6
9	150.025	1350.225	-42.9	-46.0	-20.0	22.9	26.0



Harmonic #	Tx	Measured	Equivalent Radiated power		Limit dBm	Margin Under Limit	
	Freq MHz	Freq MHz	Vertical dBm	Horizontal dBm		Vertical dB	Horizontal dB
10	150.025	1500.250	-41.3	-44.1	-20.0	21.3	24.1
2	162.000	324.000	-45.2	-48.9	-20.0	25.2	28.9
3	162.000	486.000	-45.7	-49.7	-20.0	25.7	29.7
4	162.000	648.000	-49.2	-43.9	-20.0	29.2	23.9
5	162.000	810.000	-35.3	-35.6	-20.0	15.3	15.6
6	162.000	972.000	-49.9	-48.5	-20.0	29.9	28.5
7	162.000	1134.000	-46.5	-46.2	-20.0	26.5	26.2
8	162.000	1296.000	-44.8	-44.8	-20.0	24.8	24.8
9	162.000	1458.000	-44.7	-44.6	-20.0	24.7	24.6
10	162.000	1620.000	-42.6	-42.5	-20.0	22.6	22.5
2	173.275	346.550	-46.7	-52.0	-20.0	26.7	32.0
3	173.275	519.825	-44.3	-48.3	-20.0	24.3	28.3
4	173.275	693.100	-42.2	-48.2	-20.0	22.2	28.2
5	173.275	866.375	-29.2	-40.5	-20.0	9.2	20.5
6	173.275	1039.650	-47.9	-48.6	-20.0	27.9	28.6
7	173.275	1212.925	-48.2	-47.4	-20.0	28.2	27.4
8	173.275	1386.200	-44.7	-47.4	-20.0	24.7	27.4
9	173.275	1559.475	-43.7	-45.6	-20.0	23.7	25.6
10	173.275	1732.750	-43.1	-43.3	-20.0	23.1	23.3
2	450.025	900.050	-22.6	-24.9	-20.0	2.6	4.9
3	450.025	1350.075	-27.0	-24.6	-20.0	7.0	4.6
4	450.025	1800.100	-27.0	-30.9	-20.0	7.0	10.9
5	450.025	2250.125	-27.6	-32.7	-20.0	7.6	12.7
6	450.025	2700.150	-27.6	-30.8	-20.0	7.6	10.8
7	450.025	3150.175	-29.4	-29.6	-20.0	9.4	9.6
8	450.025	3600.200	-36.7	-37.4	-20.0	16.7	17.4
9	450.025	4050.225	-38.2	-40.3	-20.0	18.2	20.3
10	450.025	4500.250	-37.8	-37.4	-20.0	17.8	17.4
2	465.000	930.000	-23.0	-33.4	-20.0	3.0	13.4
3	465.000	1395.000	-27.4	-28.7	-20.0	7.4	8.7
4	465.000	1860.000	-38.0	-39.1	-20.0	18.0	19.1
5	465.000	2325.000	-38.3	-37.5	-20.0	18.3	17.5
6	465.000	2790.000	-42.4	-43.1	-20.0	22.4	23.1
7	465.000	3255.000	-35.7	-42.3	-20.0	15.7	22.3
8	465.000	3720.000	-37.8	-38.6	-20.0	17.8	18.6
9	465.000	4185.000	-38.7	-38.6	-20.0	18.7	18.6
10	465.000	4650.000	-36.1	-37.0	-20.0	16.1	17.0
2	479.000	958.000	-26.4	-32.2	-20.0	6.4	12.2
3	479.000	1437.000	-28.9	-28.8	-20.0	8.9	8.8
4	479.000	1916.000	-32.6	-31.9	-20.0	12.6	11.9
5	479.000	2395.000	-32.2	-34.0	-20.0	12.2	14.0
6	479.000	2874.000	-32.8	-34.6	-20.0	12.8	14.6
7	479.000	3353.000	-29.6	-28.8	-20.0	9.6	8.8
8	479.000	3832.000	-37.9	-38.6	-20.0	17.9	18.6
9	479.000	4311.000	-36.8	-38.8	-20.0	16.8	18.8
10	479.000	4790.000	-37.4	-37.2	-20.0	17.4	17.2

Judgment: Passed by at least 2.6 dB.

No other spurious radiated emissions were detected within 10 dB of the limits from 30 MHz to 4.8 GHz.



10.5 Frequency Stability

10.5.1 Frequency Stability Vs Temperature

The chamber was then set to the lowest temperature. The transmitter was in the chamber and allowed to stabilize for 15 minutes. The transmitter was then keyed, and the frequency was recorded. The chamber was then incremented in 10°C steps with a minimum of 15 minute stabilization period for each temperature measurement. The transmitter was off during the temperature transitions.

10.5.2 Frequency Stability Vs Supply Voltage

The EUT was allowed to stabilize with the nominal primary power supply voltage applied. The primary input voltage was varied.

10.5.3 Test Results for Frequency Stability

Model	37337-X2	Specification	FCC Part 90.213 RSS-119 Section 5.3
Serial Number	023	Test Date	January 26, 2023
Test Personnel	Joseph Strzelecki	Test Location	Chamber B
Test Equipment	Spectrum Analyzer (REC-21); Temperature Chamber TC-01 Digital Multimeter (DMM-08)		
Notes	15 minutes at each Temperature; 1 min at each voltage		
Nominal Frequency	161.9999915 or 464.999792 MHz		

Volts	Freq. (MHz)	Deviation Hz	PPM
DC	161.9999945	3	0.02
6.8	161.9999935	2	0.01
7.0	161.9999930	1	0.01
7.2	161.9999910	0	0.00
7.4	161.9999910	0	0.00
7.6	161.9999915	0	0.00
7.8	161.9999910	0	0.00
8.0	161.9999910	0	0.00
8.2	161.9999910	0	0.00
8.4	161.9999890	-2	-0.02

Test Requirements: Limit is 2 ppm
Judgement: Pass

Temp Deg. C	Freq. (MHz)	Deviation Hz	PPM
50	161.999795	-150	-0.93
40	161.999860	-85	-0.52
30	161.999907	-38	-0.23
20	161.999945	0	0.00
10	161.999945	0	0.00
0	161.999917	-28	-0.17
-10	161.999962	17	0.10
-20	161.999920	-25	-0.15
-30	161.999982	37	0.23

Test Requirements: Limit is 2 ppm
Judgement: Pass



Volts	Freq.	Deviation	
DC	(MHz)	Hz	PPM
6.8	464.999842	50	0.11
7.0	464.999830	38	0.08
7.2	464.999822	30	0.06
7.4	464.999817	25	0.05
7.6	464.999812	20	0.04
7.8	464.999792	0	0.00
8.0	464.999800	8	0.02
8.2	464.999795	3	0.01
8.4	464.999787	-5	-0.01

Test Requirements: Limit is 1 ppm
Judgement: Pass

Temp	Freq.	Deviation	
Deg. C	(MHz)	Hz	PPM
50	464.999445	-367	-0.79
40	464.999702	-110	-0.24
30	464.999732	-80	-0.17
20	464.999812	0	0.00
10	464.999820	8	0.02
0	464.999885	73	0.16
-10	464.999902	90	0.19
-20	464.999907	95	0.20
-30	464.999987	175	0.38

Test Requirements: Limit is 1 ppm
Judgement: Pass

10.6 Transient Frequency Behavior

10.6.1 Test method

The test was performed in accordance with TIA-603-D Section 2.2.19.3 Alternate Method of Measurement (Using a Test Receiver). The equipment was connected as shown below.

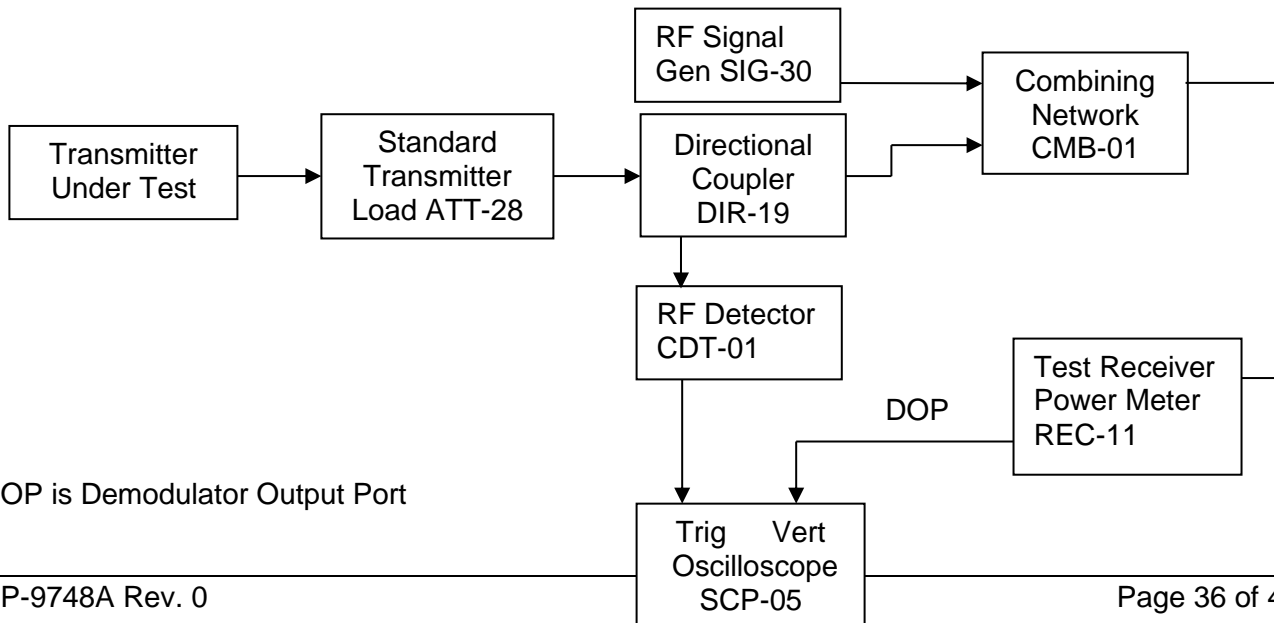

DOP is Demodulator Output Port



10.6.2 Limits of transient frequency

Time intervals ^{1,2}	Maximum Frequency Difference ³	150 to 174 MHz Equipment Operating on 6.25 kHz Channels	421 to 512 MHz Equipment Operating on 6.25 kHz Channels
t_1^4	± 6.25 kHz	5.0 mSec	10.0 mSec
t_2	± 3.125 kHz	20.0 mSec	25.0 mSec
t_3^4	± 6.25 kHz	5.0 mSec	10.0 mSec

¹ t_{on} is the instant when a 1 kHz test signal is completely suppressed, including any capture time due to phasing.

t_1 is the time period immediately following t_{on} .

t_2 is the time period immediately following t_1 .

t_3 is the time period from the instant when the transmitter is turned off until t_{off} .

t_{off} is the instant when the 1 kHz test signal starts to rise.

²During the time from the end of t_2 to the beginning of t_3 , the frequency difference must not exceed the limits specified in § 90.213.

³Difference between the actual transmitter frequency and the assigned transmitter frequency.

⁴If the transmitter carrier output power rating is 6 watts or less, the frequency difference during this time period may exceed the maximum frequency difference for this time period.

10.6.3 Test Results

Model	37337-X2	Specification	FCC part 90.214 RSS-119 Section 5.9
Serial Number	023	Test Date	February 2, 2023
Test Personnel	Joseph Strzelecki	Test Location	Chamber B

Time intervals ¹ ²	Maximum frequency difference ³	All equipment	
		150 to 174 MHz	421 to 512 MHz
Transient Frequency Behavior for Equipment Designed to Operate on 25 kHz Channels			
t_1^4	± 25.0 kHz	5.0 ms	10.0 ms
t_2	± 12.5 kHz	20.0 ms	25.0 ms
t_3^4	± 25.0 kHz	5.0 ms	10.0 ms
Transient Frequency Behavior for Equipment Designed to Operate on 12.5 kHz Channels			
t_1^4	± 12.5 kHz	5.0 ms	10.0 ms
t_2	± 6.25 kHz	20.0 ms	25.0 ms
t_3^4	± 12.5 kHz	5.0 ms	10.0 ms

¹ t_{on} is the instant when a 1 kHz test signal is completely suppressed, including any capture time due to phasing.

t_1 is the time period immediately following t_{on} .



t_2 is the time period immediately following t_1 .

t_3 is the time period from the instant when the transmitter is turned off until t_{off} .

t_{off} is the instant when the 1 kHz test signal starts to rise.

2 During the time from the end of t_2 to the beginning of t_3 , the frequency difference must not exceed the limits specified in § 90.213.

3 Difference between the actual transmitter frequency and the assigned transmitter frequency.

4 Since the transmitter carrier output power is less than 6 watts, the frequency difference during the t_3 time period may exceed the maximum frequency difference for this time period.

Judgement: Pass

10.6.4 Results for Time Periods t_1 and t_2

The following shows the off to on State.

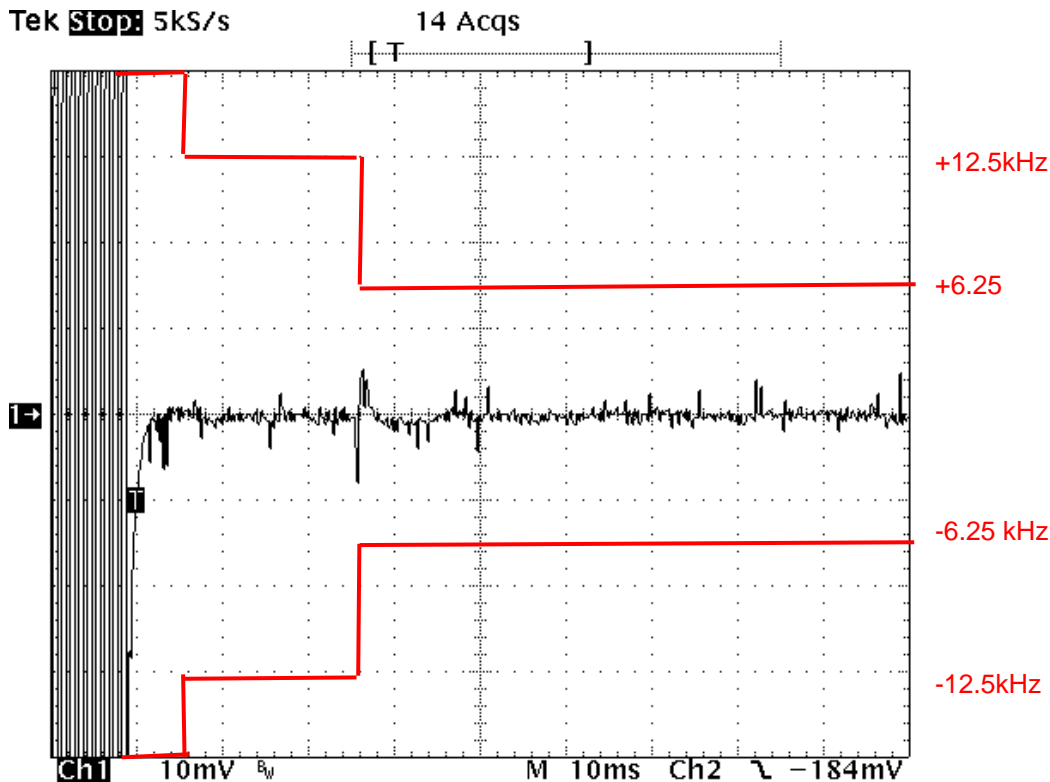

162 MHz; On; T1 and T2

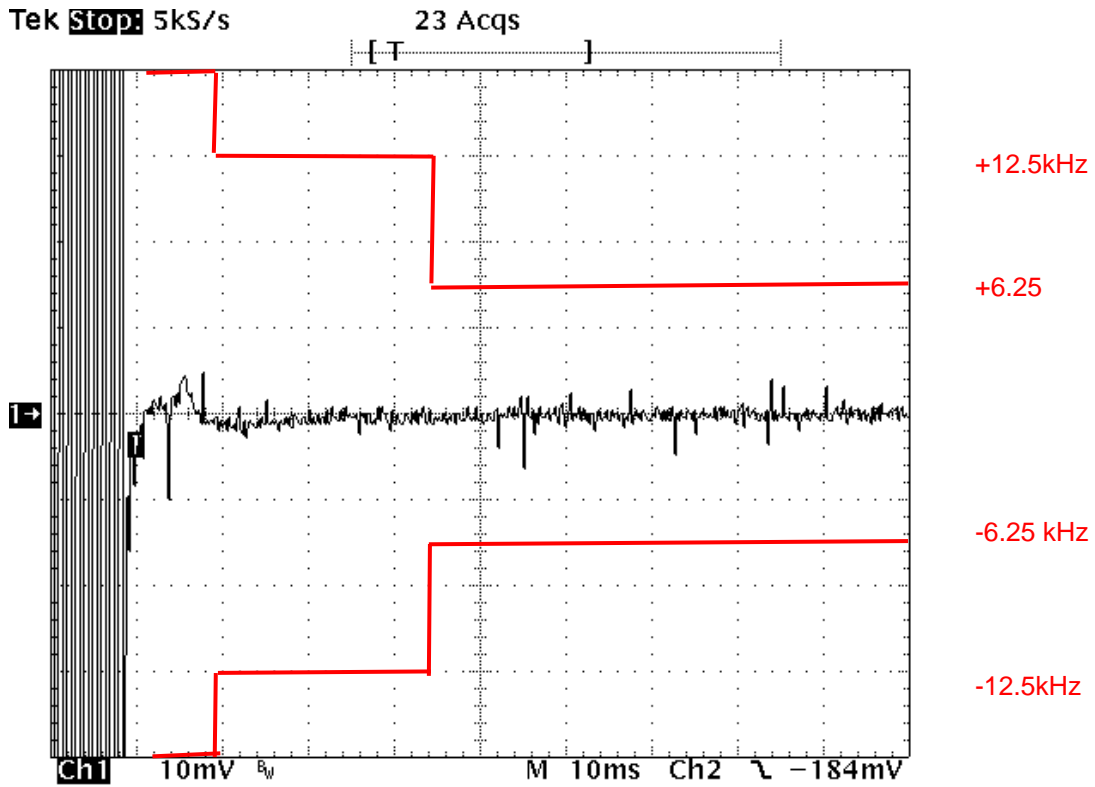

465 MHz; On; T1 and T2

It passed the limits for 12.5 kHz Channel devices, so the 25 kHz device limits are not shown.



10.6.5 Results for Time Period t3

Since the transmitter carrier output power is less than 6 watts, the frequency difference during the t3 time period may exceed the maximum frequency difference for this time period.

The following shows the off to on State.

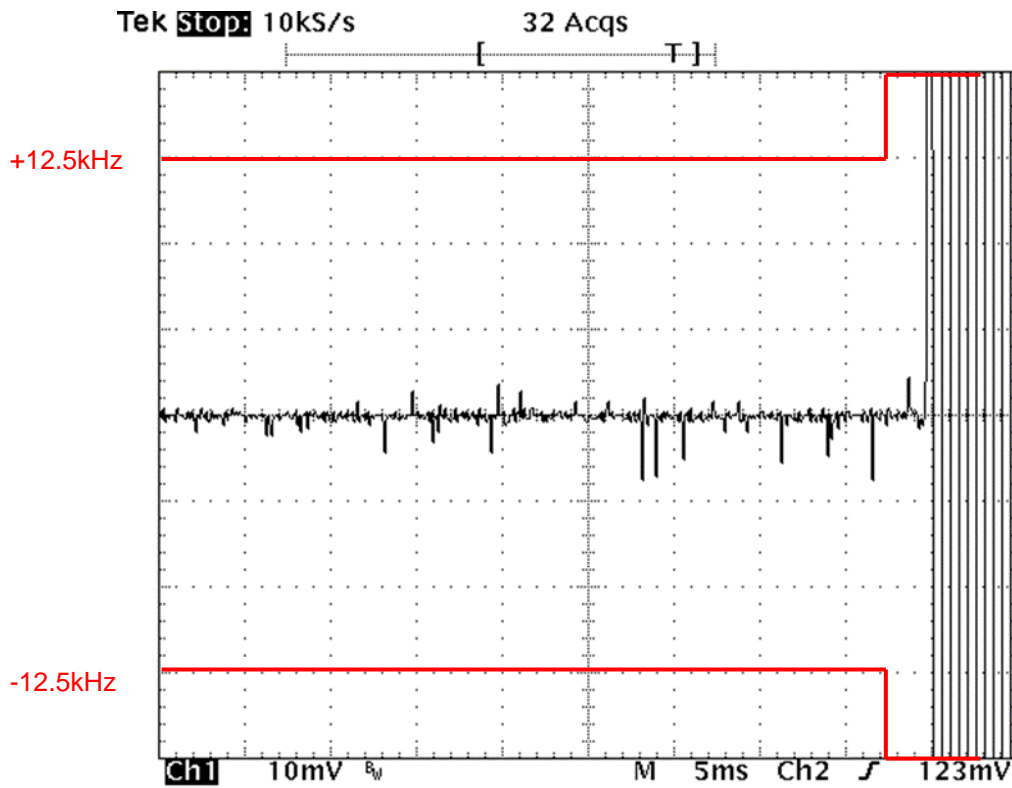

162 MHz T3

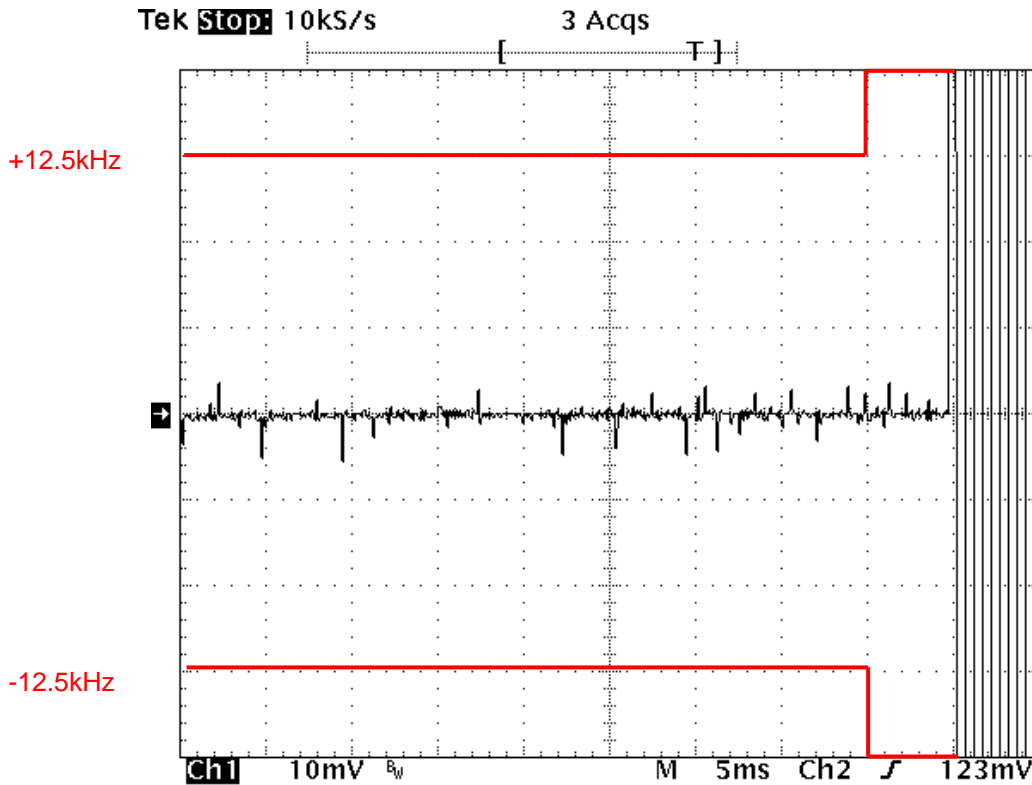

465 MHz T3
Judgement: Pass

10.7 Radiated Emissions (Receive Mode)

Radiated emission measurements were performed with linearly polarized broadband antennas. The results obtained with these antennas can be correlated with results obtained with a tuned dipole antenna. The radiated emission measurements were performed with a spectrum analyzer. The bandwidth used from 150 kHz to 30 MHz is 9 or 10 kHz and the bandwidth from 30 MHz to 1000 MHz is 100 or 120 kHz. Above 1 GHz, a 1 MHz bandwidth is used. A 10-dB linearity check is performed prior to the start of testing in order to determine if an overload condition exists.

From 30 to 2000 MHz, an Anritsu spectrum analyzer was used. Final radiated emissions measurements were performed inside of an anechoic chamber at a test distance of 3 meters. The anechoic chamber is designated as Chamber E. This Chamber meets the Site Attenuation requirements of ANSI C63.4 and CISPR 16-1. Chamber E is located at 12 East Devonwood Ave. Romeoville, Illinois EMI test lab.

The entire frequency range from 30 to 2000 MHz was slowly scanned with particular attention paid to those frequency ranges which appeared high. Measurements were performed using two antenna polarizations, (vertical and horizontal). The worst-case emissions were recorded. All measurements may be performed using either the peak, average or quasi-peak detector functions. If the peak detector data exceeds or is marginally close to the limits, the measurements are repeated using a quasi-peak detector or average function as required by the specification for final determination of compliance.



The detected emission levels were maximized by rotating the EUT, adjusting the positions of all cables, and by scanning the measurement antenna from 1 to 4 meters above the ground.

10.7.1 Radiated Emissions Field Strength Sample Calculation

The field strength is calculated by adding the Antenna Factor and Cable Loss, and by subtracting the Amplifier Gain from the measured reading. The basic equation is as follows:

FS = RA + AF + CF - AG

Where: FS = Field Strength

RA = Receiver Amplitude

AF = Antenna Factor

CF = Cable Attenuation Factor

AG = Amplifier Gain

10.7.2 Spurious Radiated Emissions Test Results (Receive Mode)

Table with 4 columns: Model, Serial Number, Tested by, Abbreviations, Notes, Configuration. Values include 37337-X2, 047, Chris D'Alessio, Pol = Antenna Polarization; V = Vertical; H = Horizontal; P = peak; Q = QP, Corr. Factors = Cable Loss - Preamp Gain; Internal preamp below 1 GHz, Receive Mode.

All emissions except fundamental and harmonics

Table with 11 columns: Freq. MHz, Meter Reading dBuV, Dect., Ant. Pol., Ant Factor, Cable & Amp Factors, Dist. Fact dB, EUT dBuV/m, Limit dBuV/m, Margin Under Limit dB, Note. Contains 25 rows of test data.



Freq. MHz	Meter Reading dBuV	Dect.	Ant. Pol.	Ant Factor	Cable & Amp Factors	Dist. Fact dB	EUT dBuV/m	Limit dBuV/m	Margin Under Limit dB	Note
35.5	16.3	P	V	12.2	0.6	0.0	29.1	40.0	10.9	
46.1	17.7	P	V	10.1	0.7	0.0	28.5	40.0	11.5	
49.9	16.0	P	V	9.7	0.7	0.0	26.4	40.0	13.6	
63.0	19.1	P	V	9.3	0.8	0.0	29.2	40.0	10.8	
77.3	11.9	P	V	9.3	0.9	0.0	22.1	40.0	17.9	
87.5	15.2	P	V	9.6	1.0	0.0	25.8	40.0	14.2	
97.3	11.0	P	V	10.1	1.1	0.0	22.2	43.5	21.3	
111.2	10.4	P	V	11.0	1.1	0.0	22.5	43.5	21.0	
123.8	11.6	P	V	11.8	1.2	0.0	24.6	43.5	18.9	
133.3	12.1	P	V	12.3	1.3	0.0	25.7	43.5	17.8	
146.6	11.3	P	V	12.7	1.3	0.0	25.3	43.5	18.2	
157.0	11.2	P	V	12.9	1.4	0.0	25.5	43.5	18.0	
170.0	12.4	P	V	13.2	1.4	0.0	27.0	43.5	16.5	
180.4	12.0	P	V	13.6	1.5	0.0	27.1	43.5	16.4	
193.0	11.7	P	V	14.0	1.5	0.0	27.2	43.5	16.3	
216.5	11.7	P	V	14.8	1.6	0.0	28.1	46.0	17.9	
232.2	11.9	P	V	15.0	1.7	0.0	28.6	46.0	17.4	
1079.1	40.6	P	V	24.4	-32.0	0.0	33.0	74.0	41.0	1
1659.7	39.4	P	V	25.4	-31.5	0.0	33.3	74.0	40.7	1
1952.0	39.2	P	V	27.6	-31.1	0.0	35.7	74.0	38.3	1
2031.0	41.4	P	V	27.6	-31.0	0.0	38.0	74.0	36.0	1
2421.4	41.2	P	V	28.3	-30.5	0.0	39.0	74.0	35.0	1
2585.6	40.1	P	V	28.7	-30.2	0.0	38.6	74.0	35.4	1
2918.9	39.8	P	V	29.4	-29.7	0.0	39.5	74.0	34.5	1
2962.0	40.2	P	V	29.8	-29.6	0.0	40.4	74.0	33.6	1

Note 1: Peak Reading under the Average limit, therefore no Average reading is required.
Judgment: Passed by at least 10.8 dB

11.0 MEASUREMENT INSTRUMENTATION UNCERTAINTY

Measurement	Uncertainty
Radiated Emissions, E-field, 3 meters, 30 to 200 MHz	4.7 dB
Radiated Emissions, E-field, 3 meters, 200 to 1000 MHz	6.2 dB
Radiated Emissions, E-field, 3 meters, 1 to 6 GHz	5.0 dB
99% Occupied Bandwidth using REC-43	1% of frequency span
Conducted power PWM-01 at 460 MHz	0.14 dB
Amplitude measurement 1-5000 MHz; REC-11	1.5 dB
Temperature THM-02	0.6 Deg. C

The uncertainties represent expanded uncertainties expressed at approximately the 95% confidence level using a coverage factor of k=2 in accordance with CISPR 16-4-2.



12.0 REVISION HISTORY

Document RP-9748A Revisions:			
Rev.	Affected Sections	Description	Rationale