



FCC RADIO TEST REPORT

FCC ID : 2ABVH-INARI8B2
Equipment : Tablet
Brand Name : AAVA
Model Name : INARI8B-LTG-1
Applicant : Aava Mobile Oy
NAHKATEHTAANKATU 2 90130 OULU FINLAND
Manufacturer : Aava Mobile Oy
NAHKATEHTAANKATU 2 90130 OULU FINLAND
Standard : 47 CFR Part 2, 22(H), 24(E), 27(L)

The product was received on Sep. 06, 2018 and testing was started from Oct. 06, 2018 and completed on Nov. 17, 2018. We, SPORTON INTERNATIONAL INC., would like to declare that the tested sample has been evaluated in accordance with the test procedures given in ANSI / TIA-603-E and has been in compliance with the applicable technical standards.

The report must not be used by the client to claim product certification, approval, or endorsement by TAF or any agency of government.

The test results in this report apply exclusively to the tested model / sample. Without written approval of SPORTON INTERNATIONAL INC. EMC & Wireless Communications Laboratory, the test report shall not be reproduced except in full.

Approved by: Joseph Lin

SPORTON INTERNATIONAL INC. EMC & Wireless Communications Laboratory

No. 52, Huaya 1st Rd., Guishan Dist., Taoyuan City, Taiwan (R.O.C.)



Table of Contents

History of this test report..... 3

Summary of Test Result..... 4

1 General Description 5

 1.1 Product Feature of Equipment Under Test 5

 1.2 Product Specification of Equipment Under Test 5

 1.3 Modification of EUT 6

 1.4 Maximum ERP/EIRP Power, Frequency Tolerance, and Emission Designator 6

 1.5 Testing Location 7

 1.6 Applicable Standards 8

2 Test Configuration of Equipment Under Test 9

 2.1 Test Mode..... 9

 2.2 Connection Diagram of Test System 9

 2.3 Support Unit used in test configuration 10

 2.4 Measurement Results Explanation Example 10

 2.5 Frequency List of Low/Middle/High Channels 10

3 Conducted Test Result 11

 3.1 Measuring Instruments 11

 3.2 Conducted Output Power and ERP/EIRP 12

 3.3 Peak-to-Average Ratio 13

 3.4 99% Occupied Bandwidth and 26dB Bandwidth Measurement..... 14

 3.5 Conducted Band Edge 15

 3.6 Conducted Spurious Emission 16

 3.7 Frequency Stability 17

4 Radiated Test Items 18

 4.1 Measuring Instruments 18

 4.2 Test Setup 18

 4.3 Test Result of Radiated Test 18

 4.4 Field Strength of Spurious Radiation Measurement 19

5 List of Measuring Equipment..... 20

6 Uncertainty of Evaluation 22

Appendix A. Test Results of Conducted Test

Appendix B. Test Results of ERP/EIRP and Radiated Test

Appendix C. Test Setup Photographs



Summary of Test Result

Report Clause	Ref Std. Clause	Test Items	Result (PASS/FAIL)	Remark
3.2	§2.1046	Conducted Output Power	Pass	-
	§22.913 (a)(2)	Effective Radiated Power		
	§24.232 (c)	Equivalent Isotropic Radiated Power		
	§27.50 (d)(4)	Equivalent Isotropic Radiated Power		
3.3	§24.232 (d)	Peak-to-Average Ratio	Pass	-
3.4	§2.1049 §22.917 (b) §24.238 (b) §27.53 (g)	Occupied Bandwidth	Pass	-
3.5	§2.1051 §22.917 (a) §24.238 (a) §27.53 (g)	Band Edge Measurement	Pass	-
3.6	§2.1051 §22.917 (a) §24.238 (a) §27.53 (g)	Conducted Emission	Pass	-
3.7	§2.1055 §22.355	Frequency Stability Temperature & Voltage	Pass	-
	§2.1055 §24.235 §27.54			-
4.4	§2.1053 §22.917 (a) §24.238 (a) §27.53 (h)	Field Strength of Spurious Radiation	Pass	Under limit 33.55 dB at 7410.000 MHz

Reviewed by: Wii Chang

Report Producer: Polly Tsai



1 General Description

1.1 Product Feature of Equipment Under Test

Product Feature	
Equipment	Tablet
Brand Name	AAVA
Model Name	INARI8B-LTG-1
FCC ID	2ABVH-INARI8B2
EUT supports Radios application	WCDMA/HSPA/LTE/NFC/GNSS WLAN 11a/b/g/n HT20/HT40 WLAN 11ac VHT20/VHT40/VHT80 Bluetooth BR/EDR/LE
HW Version	DV1
SW Version	Windows 10
EUT Stage	Identical Prototype

Remark: The above EUT's information was declared by manufacturer.

Specification of Accessories				
AC Adapter	Brand Name	PHIHONG	Model Name	AQ18A-59CFA
Battery	Brand Name	Aava	Model Name	AMME3735
USB Cable	Brand Name	PHIHONG	Model Name	UES-1001A160-R

1.2 Product Specification of Equipment Under Test

Standards-related Product Specification	
Tx Frequency	WCDMA: Band V: 826.4 MHz ~ 846.6 MHz Band II: 1852.4 MHz ~ 1907.6 MHz Band IV: 1712.4 MHz ~ 1752.6 MHz
Rx Frequency	WCDMA: Band V: 871.4 MHz ~ 891.6 MHz Band II: 1932.4 MHz ~ 1987.6 MHz Band IV: 2112.4 MHz ~ 2152.6 MHz
Maximum Output Power to Antenna	WCDMA: Band V: 23.84 dBm Band II: 23.66 dBm Band IV: 23.82 dBm
Antenna Type	Flexible Antenna
Antenna Gain	Cellular Band: 1.0 dBi PCS Band: 0.5 dBi AWS Band: 1.0 dBi
Type of Modulation	WCDMA: BPSK (Uplink) HSDPA: 64QAM (Downlink) HSUPA: QPSK (Uplink)



1.3 Modification of EUT

No modifications are made to the EUT during all test items.

1.4 Maximum ERP/EIRP Power, Frequency Tolerance, and Emission Designator

FCC Rule	Frequency Range (MHz)	System	Type of Modulation	Maximum ERP/EIRP (W)	Frequency Tolerance (ppm)	Emission Designator
Part 22	826.4 ~846.6	WCDMA Band V RMC 12.2Kbps	BPSK	0.1856	0.0167 ppm	4M17F9W
Part 24	1852.4 ~ 1907.6	WCDMA Band II RMC 12.2Kbps	BPSK	0.2606	0.0069 ppm	4M15F9W
Part 27	1712.4 ~ 1752.6	WCDMA Band IV RMC 12.2Kbps	BPSK	0.3033	0.0248 ppm	4M14F9W



1.5 Testing Location

Sporton Lab is accredited to ISO 17025 by Taiwan Accreditation Foundation (TAF code : 1190) and the FCC designation No. TW1190 and TW0007 under the FCC 2.948(e) by Mutual Recognition Agreement (MRA) in FCC Test.

Test Site	SPORTON INTERNATIONAL INC.
Test Site Location	No.52, Huaya 1st Rd., Guishan Dist., Taoyuan City, Taiwan (R.O.C.) TEL: +886-3-327-3456 FAX: +886-3-328-4978
Test Site No.	Sporton Site No. TH03-HY
Temperature	21~24°C
Relative Humidity	51~55%
Test Engineer	Louis Chung

Note: The test site complies with ANSI C63.4 2014 requirement.

Test Site	SPORTON INTERNATIONAL INC.
Test Site Location	No.58, Aly. 75, Ln. 564, Wenhua 3rd, Rd., Guishan Dist., Taoyuan City, Taiwan (R.O.C.) TEL: +886-3-327-0868 FAX: +886-3-327-0855
Test Site No.	Sporton Site No. 03CH12-HY
Temperature	22~26°C
Relative Humidity	56~67%
Test Engineer	Jack Cheng, Lance Chiang, and Peter Liao

Note: The test site complies with ANSI C63.4 2014 requirement.



1.6 Applicable Standards

According to the specifications of the manufacturer, the EUT must comply with the requirements of the following standards:

- ♦ ANSI C63.26-2015
- ♦ ANSI / TIA-603-E
- ♦ 47 CFR Part 2, 22(H), 24(E), 27(L)
- ♦ FCC KDB 971168 D01 Power Meas. License Digital Systems v03r01
- ♦ FCC KDB 412172 D01 Determining ERP and EIRP v01r01

Remark:

1. All test items were verified and recorded according to the standards and without any deviation during the test.
2. This EUT has also been tested and complied with the requirements of FCC Part 15, Subpart B, recorded in a separate test report.

2 Test Configuration of Equipment Under Test

2.1 Test Mode

Antenna port conducted and radiated test items were performed according to KDB 971168 D01 Power Meas. License Digital Systems v03r01 with maximum output power.

For radiated measurement, pre-scanned in three orthogonal panels, X, Y, Z. The worst cases (X plane for AWS Band, Y plane for Cellular Band, and Z plane for PCS Band) were recorded in this report.

Radiated emissions were investigated as following frequency range:

1. 30 MHz to 9000 MHz for WCDMA Band V.
2. 30 MHz to 18000 MHz for WCDMA Band IV.
3. 30 MHz to 19100 MHz for WCDMA Band II.

All modes and data rates and positions were investigated.

Test modes are chosen to be reported as the worst case configuration below:

Test Modes		
Band	Radiated TCs	Conducted TCs
WCDMA Band V	■ RMC 12.2Kbps Link	■ RMC 12.2Kbps Link
WCDMA Band II	■ RMC 12.2Kbps Link	■ RMC 12.2Kbps Link
WCDMA Band IV	■ RMC 12.2Kbps Link	■ RMC 12.2Kbps Link

2.2 Connection Diagram of Test System

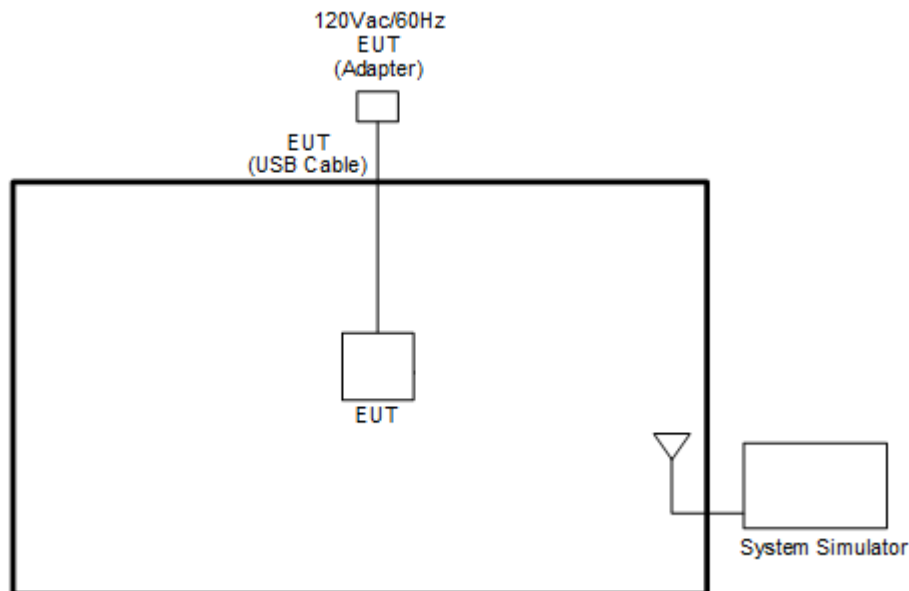



2.3 Support Unit used in test configuration

Item	Equipment	Trade Name	Model No.	FCC ID	Data Cable	Power Cord
1.	System Simulator	R&S	CMU 200	N/A	N/A	Unshielded, 1.8 m

2.4 Measurement Results Explanation Example

For all conducted test items:

The offset level is set in the spectrum analyzer to compensate the RF cable loss and attenuator factor between RF conducted output port and spectrum analyzer. With the offset compensation, the spectrum analyzer reading level will be exactly the RF output level.

The spectrum analyzer offset is derived from RF cable loss and attenuator factor.

$$\text{Offset} = \text{RF cable loss} + \text{attenuator factor}.$$

The following shows an offset computation example with RF cable loss 4.2 dB and a 10dB attenuator.

Example:

$$\begin{aligned} \text{Offset(dB)} &= \text{RF cable loss(dB)} + \text{attenuator factor(dB)}. \\ &= 4.2 + 10 = 14.2 \text{ (dB)} \end{aligned}$$

2.5 Frequency List of Low/Middle/High Channels

Frequency List				
Band	Channel/Frequency(MHz)	Lowest	Middle	Highest
WCDMA Band V	Channel	4132	4182	4233
	Frequency	826.4	836.4	846.6
WCDMA Band II	Channel	9262	9400	9538
	Frequency	1852.4	1880.0	1907.6
WCDMA Band IV	Channel	1312	1413	1513
	Frequency	1712.4	1732.6	1752.6

3 Conducted Test Result

3.1 Measuring Instruments

See list of measuring instruments of this test report.

3.1.1 Test Setup

3.1.2 Conducted Output Power

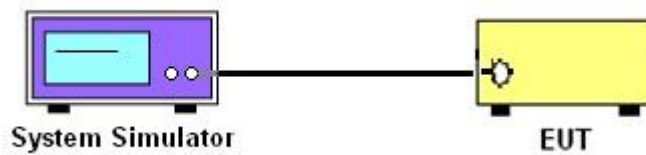

3.1.3 Peak-to-Average Ratio, Occupied Bandwidth, Conducted Band-Edge and Conducted Spurious Emission

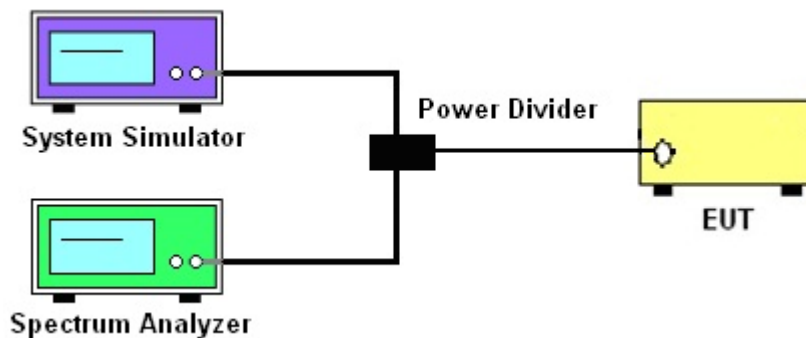

3.1.4 Frequency Stability

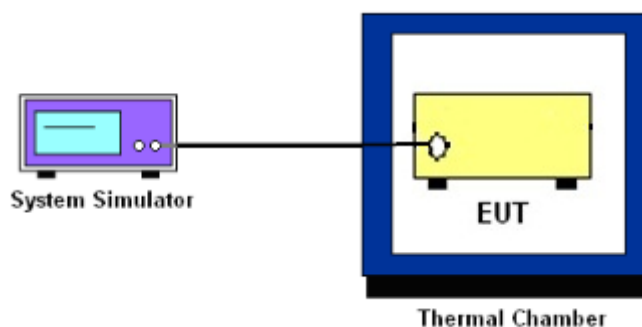

3.1.5 Test Result of Conducted Test

Please refer to Appendix A.



3.2 Conducted Output Power and ERP/EIRP

3.2.1 Description of the Conducted Output Power and ERP/EIRP

A system simulator was used to establish communication with the EUT. Its parameters were set to enforce EUT transmitting at the maximum power. The measured power in the radio frequency on the transmitter output terminals shall be reported.

The ERP of mobile transmitters must not exceed 7 Watts for WCDMA Band V.

The EIRP of mobile transmitters must not exceed 2 Watts for WCDMA Band II.

The EIRP of mobile transmitters must not exceed 1 Watts for WCDMA Band IV.

According to KDB 412172 D01 Power Approach,

$EIRP = P_T + G_T - L_C$, $ERP = EIRP - 2.15$, where

P_T = transmitter output power in dBm

G_T = gain of the transmitting antenna in dBi

L_C = signal attenuation in the connecting cable between the transmitter and antenna in dB

3.2.2 Test Procedures

1. The transmitter output port was connected to the system simulator.
2. Set EUT at maximum power through system simulator.
3. Select lowest, middle, and highest channels for each band and different modulation.
4. Measure the maximum burst average power for GSM and maximum average power for other modulation signal.



3.3 Peak-to-Average Ratio

3.3.1 Description of the PAR Measurement

The peak-to-average ratio (PAR) of the transmission may not exceed 13 dB.

3.3.2 Test Procedures

The testing follows FCC KDB 971168 D01 v03r01 Section 5.7.1

1. The EUT was connected to spectrum analyzer and system simulator via a power divider.
2. Set EUT to transmit at maximum output power.
3. When the duty cycle is less than 98%, then signal gating will be implemented on the spectrum analyzer by triggering from the system simulator.
4. Set the CCDF (Complementary Cumulative Distribution Function) option of the spectrum analyzer.
5. Record the maximum PAPR level associated with a probability of 0.1%.



3.4 99% Occupied Bandwidth and 26dB Bandwidth Measurement

3.4.1 Description of 99% Occupied Bandwidth and 26dB Bandwidth Measurement

The occupied bandwidth is the width of a frequency band such that, below the lower and above the upper frequency limits, the mean powers emitted are each equal to a specified percentage 0.5% of the total mean transmitted power.

The 26 dB emission bandwidth is defined as the frequency range between two points, one above and one below the carrier frequency, at which the spectral density of the emission is attenuated 26 dB below the maximum in-band spectral density of the modulated signal. Spectral density (power per unit bandwidth) is to be measured with a detector of resolution bandwidth equal to approximately 1.0% of the emission bandwidth.

3.4.2 Test Procedures

The testing follows FCC KDB 971168 D01 v03r01 Section 4.2

1. The EUT was connected to spectrum analyzer and system simulator via a power divider.
2. The spectrum analyzer center frequency is set to the nominal EUT channel center frequency. The span range for the spectrum analyzer shall be between two and five times the anticipated OBW.
3. The nominal resolution bandwidth (RBW) shall be in the range of 1 to 5 % of the anticipated OBW, and the VBW shall be at least 3 times the RBW.
4. Set the detection mode to peak, and the trace mode to max hold.
5. Determine the reference value: Set the EUT to transmit a modulated signal. Allow the trace to stabilize. Set the spectrum analyzer marker to the highest level of the displayed trace.
(this is the reference value)
6. Determine the “-26 dB down amplitude” as equal to (Reference Value – X).
7. Place two markers, one at the lowest and the other at the highest frequency of the envelope of the spectral display such that each marker is at or slightly below the “-X dB down amplitude” determined in step 6. If a marker is below this “-X dB down amplitude” value it shall be placed as close as possible to this value. The OBW is the positive frequency difference between the two markers.
8. Use the 99 % power bandwidth function of the spectrum analyzer and report the measured bandwidth.



3.5 Conducted Band Edge

3.5.1 Description of Conducted Band Edge Measurement

The power of any emission outside of the authorized operating frequency ranges must be lower than the transmitter power (P) by a factor of at least $43 + 10 \log (P)$ dB.

3.5.2 Test Procedures

The testing follows FCC KDB 971168 D01 v03r01 Section 6.0.

1. The EUT was connected to the spectrum analyzer and system simulator via a power divider.
2. The RF output of EUT was connected to the spectrum analyzer by an RF cable and attenuator. The path loss was compensated to the results for each measurement.
3. The band edges of low and high channels for the highest RF powers were measured.
4. The RF fundamental frequency should be excluded against the limit line in the operating frequency band.
5. The limit line is derived from $43 + 10\log(P)$ dB below the transmitter power P(Watts)



3.6 Conducted Spurious Emission

3.6.1 Description of Conducted Spurious Emission Measurement

The power of any emission outside of the authorized operating frequency ranges must be lower than the transmitter power (P) by a factor of at least $43 + 10 \log (P)$ dB.

It is measured by means of a calibrated spectrum analyzer and scanned from 30 MHz up to a frequency including its 10th harmonic.

3.6.2 Test Procedures

The testing follows FCC KDB 971168 D01 v03r01 Section 6.0.

1. The EUT was connected to the spectrum analyzer and system simulator via a power divider.
2. The RF output of EUT was connected to the spectrum analyzer by an RF cable and attenuator.
The path loss was compensated to the results for each measurement.
3. The middle channel for the highest RF power within the transmitting frequency was measured.
4. The conducted spurious emission for the whole frequency range was taken.
5. The RF fundamental frequency should be excluded against the limit line in the operating frequency band.
6. The limit line is derived from $43 + 10\log(P)$ dB below the transmitter power P(Watts)



3.7 Frequency Stability

3.7.1 Description of Frequency Stability Measurement

22.355

The frequency stability shall be measured by variation of ambient temperature and variation of primary supply voltage to ensure that the fundamental emission stays within the authorized frequency block. The frequency stability of the transmitter shall be maintained within $\pm 0.00025\%$ ($\pm 2.5\text{ppm}$) of the center frequency.

24.235 & 27.54

The frequency stability shall be sufficient to ensure that the fundamental emission stays within the authorized frequency block.

3.7.2 Test Procedures for Temperature Variation

The testing follows FCC KDB 971168 D01 v03r01 Section 9.0.

1. The EUT was set up in the thermal chamber and connected with the system simulator.
2. With power OFF, the temperature was decreased to -30°C and the EUT was stabilized before testing. Power was applied and the maximum change in frequency was recorded within one minute.
3. With power OFF, the temperature was raised in 10°C steps up to 50°C . The EUT was stabilized at each step for at least half an hour. Power was applied and the maximum frequency change was recorded within one minute.

3.7.3 Test Procedures for Voltage Variation

The testing follows FCC KDB 971168 D01 v03r01 Section 9.0.

1. The EUT was placed in a temperature chamber at $20\pm 5^{\circ}\text{C}$ and connected with the system simulator.
2. The power supply voltage to the EUT was varied from 85% to 115% of the nominal value measured at the input to the EUT.
3. The variation in frequency was measured for the worst case.

4 Radiated Test Items

4.1 Measuring Instruments

See list of measuring instruments of this test report.

4.2 Test Setup

For radiated test from 30MHz to 1GHz

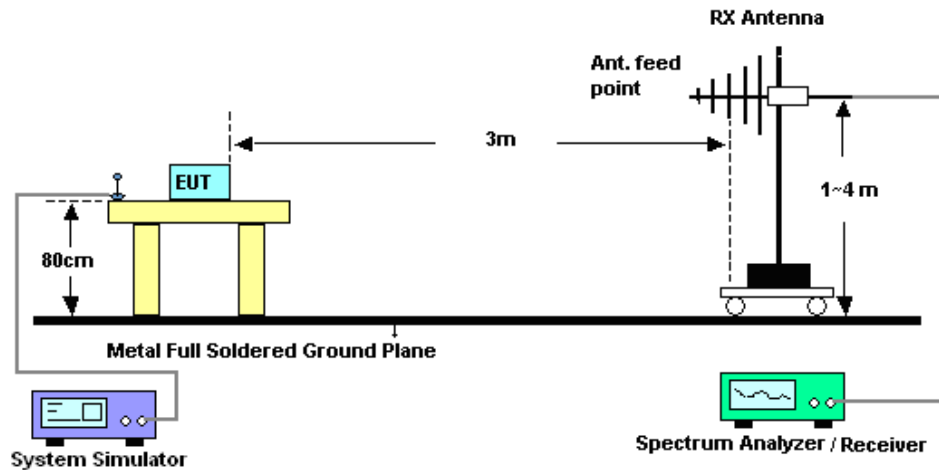

For radiated test above 1GHz

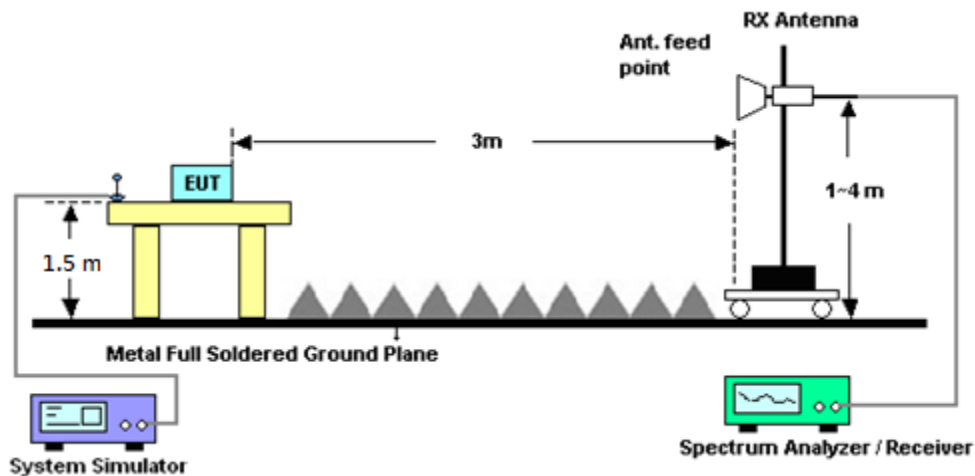

4.3 Test Result of Radiated Test

Please refer to Appendix B.



4.4 Field Strength of Spurious Radiation Measurement

4.4.1 Description of Field Strength of Spurious Radiated Measurement

The power of any emission outside of the authorized operating frequency ranges must be attenuated below the transmitter power (P) by a factor of at least $43 + 10 \log (P)$ dB. The spectrum is scanned from 30 MHz up to a frequency including its 10th harmonic.

4.4.2 Test Procedures

The testing follows FCC KDB 971168 D01 v03r01 Section 5.8 and ANSI / TIA-603-E Section 2.2.12.

1. The EUT was placed on a rotatable wooden table 0.8 meters for frequency below 1GHz and 1.5 meter for frequency above 1GHz above the ground.
2. The EUT was set 3 meters from the receiving antenna, which was mounted on the antenna tower.
3. The table was rotated 360 degrees to determine the position of the highest spurious emission.
4. The height of the receiving antenna is varied between one meter and four meters to search for the maximum spurious emission for both horizontal and vertical polarizations.
5. Make the measurement with the spectrum analyzer's RBW = 1MHz, VBW = 3MHz, taking record of maximum spurious emission.
6. A horn antenna was substituted in place of the EUT and was driven by a signal generator.
7. Tune the output power of signal generator to the same emission level with EUT maximum spurious emission.
8. Taking the record of output power at antenna port.
9. Repeat step 7 to step 8 for another polarization.
10. $EIRP \text{ (dBm)} = S.G. \text{ Power} - Tx \text{ Cable Loss} + Tx \text{ Antenna Gain}$
11. $ERP \text{ (dBm)} = EIRP - 2.15$
12. The RF fundamental frequency should be excluded against the limit line in the operating frequency band.
13. The limit line is derived from $43 + 10\log(P)$ dB below the transmitter power P(Watts)



5 List of Measuring Equipment

Instrument	Manufacturer	Model No.	Serial No.	Characteristics	Calibration Date	Test Date	Due Date	Remark
Spectrum Analyzer	Rohde & Schwarz	FSP30	101329	9kHz~30GHz	Jun. 29, 2018	Oct. 07, 2018~ Oct. 11, 2018	Jun. 28, 2019	Conducted (TH03-HY)
Temperature Chamber	ESPEC	SU-641	92013721	-30°C ~70°C	Dec. 06, 2017	Oct. 07, 2018~ Oct. 11, 2018	Dec. 05, 2019	Conducted (TH03-HY)
Programmable Power Supply	GW Instek	PSS-2005	EL883644	Voltage:0~20V; Current:0~5A	Dec. 06, 2017	Oct. 07, 2018~ Oct. 11, 2018	Dec. 05, 2019	Conducted (TH03-HY)
Base Station (Measure)	Rohde & Schwarz	CMU200	117995	GSM / GPRS / WCDMA / CDMA	Aug. 10, 2018	Oct. 07, 2018~ Oct. 11, 2018	Aug. 09, 2019	Conducted (TH03-HY)
Loop Antenna	Rohde & Schwarz	HFH2-Z2	100488	9 kHz~30 MHz	Nov. 23, 2017	Oct. 06, 2018~ Nov. 17, 2018	Nov. 22, 2018	Radiation (03CH12-HY)
Bilog Antenna	TESEQ	CBL 6111D&00802 N1D01N-06	47020&06	30MHz to 1GHz	Nov. 20, 2017	Oct. 06, 2018~ Nov. 17, 2018	Nov. 19, 2018	Radiation (03CH12-HY)
Horn Antenna	SCHWARZBE CK	BBHA 9120D	9120D-121 2	1GHz ~ 18GHz	May 10, 2018	Oct. 06, 2018~ Nov. 17, 2018	May 09, 2019	Radiation (03CH12-HY)
SHF-EHF Horn Antenna	SCHWARZBE CK	BBHA 9170	BBHA9170 584	18GHz ~ 40GHz	Nov. 27, 2017	Oct. 06, 2018~ Nov. 17, 2018	Nov. 26, 2018	Radiation (03CH12-HY)
Preamplifier	COM-POWER	PA-103	161075	10MHz~1GHz	Mar. 26, 2018	Oct. 06, 2018~ Nov. 17, 2018	Mar. 25, 2019	Radiation (03CH12-HY)
Preamplifier	Keysight	83017A	MY532701 48	1GHz~26.5GHz	Jan. 15, 2018	Oct. 06, 2018~ Nov. 17, 2018	Jan. 14, 2019	Radiation (03CH12-HY)
Preamplifier	MITEQ	AMF-7D-0010 1800-30-10P	1590074	1GHz~18GHz	May 21, 2018	Oct. 06, 2018~ Nov. 17, 2018	May 20, 2019	Radiation (03CH12-HY)
Preamplifier	EMEC	EM18G40G	060715	18GHz ~ 40GHz	Dec. 05, 2017	Oct. 06, 2018~ Nov. 17, 2018	Dec. 04, 2018	Radiation (03CH12-HY)
EMI Test Receiver	Rohde & Schwarz	ESU26	100390	20Hz~26.5GHz	Dec. 25, 2017	Oct. 06, 2018~ Nov. 17, 2018	Dec. 24, 2018	Radiation (03CH12-HY)
Spectrum Analyzer	Keysight	N9010A	MY553705 26	10Hz~44GHz	Mar. 15, 2018	Oct. 06, 2018~ Nov. 17, 2018	Mar. 14, 2019	Radiation (03CH12-HY)
Horn Antenna	SCHWARZBE CK	BBHA 9120D	9120D-152 2	1GHz ~ 18GHz	May 10, 2018	Oct. 06, 2018~ Nov. 17, 2018	May 09, 2019	Radiation (03CH12-HY)
Signal Generator	Rohde & Schwarz	SMF100A	101107	100kHz~40GHz	May 21, 2018	Oct. 06, 2018~ Nov. 17, 2018	May 20, 2019	Radiation (03CH12-HY)
Base Station	Rohde & Schwarz	CMU200	114256	GSM / GPRS /WCDMA / CDMA	Oct. 06, 2018	Oct. 06, 2018~ Nov. 17, 2018	Oct. 05, 2020	Radiation (03CH12-HY)
Base Station	Anritsu	MT8821C	620143281 6	GSM / GPRS /WCDMA / LTE FDD/TDD with 44) /LTE-3CC DLCA,2CC ULCA	May 02, 2017	Oct. 06, 2018~ Nov. 17, 2018	May 01, 2019	Radiation (03CH12-HY)
Filter	Wainwright	WLKS1200-1 2SS	SN2	1.2GHz Low Pass	Mar. 21, 2018	Oct. 06, 2018~ Nov. 17, 2018	Mar. 20, 2019	Radiation (03CH12-HY)
Notch Filter	Wainwright	WRCD1800/2 000-20/40-10 SSK	SN1	LTE Band 25	Aug. 23, 2018	Oct. 06, 2018~ Nov. 17, 2018	Aug. 22, 2019	Radiation (03CH12-HY)



Instrument	Manufacturer	Model No.	Serial No.	Characteristics	Calibration Date	Test Date	Due Date	Remark
Notch Filter	Wainwright	WTRCD10-17 10-1785-20-4 0-40SSK	SN1	1710-1785	May 22, 2018	Oct. 06, 2018~ Nov. 17, 2018	May 21, 2019	Radiation (03CH12-HY)
Notch Filter	Wainwright	WRCT/800/96 0-0.2/40-8SS K	SN11	GSM850	Aug. 23, 2018	Oct. 06, 2018~ Nov. 17, 2018	Aug. 22, 2019	Radiation (03CH12-HY)
Notch Filter	Wainwright	WRCT2300/2 500-20/40-10 SSK	SN1	2300/2500	May 23, 2018	Oct. 06, 2018~ Nov. 17, 2018	May 22, 2019	Radiation (03CH12-HY)
Notch Filter	Wainwright	WRCT698/79 8-10/40 8SSK	SN1	AWS Band	Nov. 08, 2017	Oct. 06, 2018~ Nov. 06, 2018	Nov. 07, 2018	Radiation (03CH12-HY)
Notch Filter	Wainwright	WRCT698/79 8-10/40 8SSK	SN1	AWS Band	Nov. 07, 2018	Nov. 08, 2018~ Nov. 17, 2018	Nov. 06, 2019	Radiation (03CH12-HY)
RF Cable	HUBER + SUHNER	SUCOFLEX 126E	0058/126E	30M-18G	Mar. 14, 2018	Oct. 06, 2018~ Nov. 17, 2018	Mar. 13, 2019	Radiation (03CH12-HY)
RF Cable	HUBER + SUHNER	SUCOFLEX 102	505134/2	30M~40GHz	Oct. 06, 2018	Oct. 06, 2018~ Nov. 17, 2018	Oct. 05, 2019	Radiation (03CH12-HY)
RF Cable	HUBER + SUHNER	SUCOFLEX 102	800740/2	30M~40GHz	Oct. 06, 2018	Oct. 06, 2018~ Nov. 17, 2018	Oct. 05, 2019	Radiation (03CH12-HY)
Antenna Mast	EMEC	AM-BS-4500- B	N/A	1m~4m	N/A	Oct. 06, 2018~ Nov. 17, 2018	N/A	Radiation (03CH12-HY)
Turn Table	EMEC	TT2000	N/A	0~360 Degree	N/A	Oct. 06, 2018~ Nov. 17, 2018	N/A	Radiation (03CH12-HY)
Software	Audix	E3 6.2009-8-24	RK-00098 9	N/A	N/A	Oct. 06, 2018~ Nov. 17, 2018	N/A	Radiation (03CH12-HY)



6 Uncertainty of Evaluation

Uncertainty of Radiated Emission Measurement (30 MHz ~ 1000 MHz)

Measuring Uncertainty for a Level of Confidence of 95% ($U = 2Uc(y)$)	3.36
---	------

Uncertainty of Radiated Emission Measurement (1 GHz ~ 18 GHz)

Measuring Uncertainty for a Level of Confidence of 95% ($U = 2Uc(y)$)	3.70
---	------

Uncertainty of Radiated Emission Measurement (18 GHz ~ 40 GHz)

Measuring Uncertainty for a Level of Confidence of 95% ($U = 2Uc(y)$)	3.98
---	------



Appendix A. Test Results of Conducted Test

Conducted Output Power(Average power)

Conducted Power (*Unit: dBm)						
Band	WCDMA Band V			WCDMA Band II		
Channel	4132	4182	4233	9262	9400	9538
Frequency	826.4	836.4	846.6	1852.4	1880	1907.6
RMC 12.2K	23.57	23.84	23.30	23.47	23.66	23.58
HSDPA Subtest-1	22.84	22.98	22.47	22.44	22.64	23.54
HSDPA Subtest-2	22.81	22.94	22.58	22.49	22.63	23.51
HSDPA Subtest-3	22.26	22.52	22.07	21.97	22.17	21.89
HSDPA Subtest-4	22.32	22.48	22.09	21.98	22.16	21.88
HSUPA Subtest-1	22.67	22.99	22.36	22.47	22.63	22.42
HSUPA Subtest-2	20.69	20.99	20.38	20.49	20.65	20.45
HSUPA Subtest-3	21.49	21.76	21.18	21.48	21.65	21.44
HSUPA Subtest-4	20.65	20.95	20.34	20.50	20.66	20.52
HSUPA Subtest-5	22.71	23.01	22.37	22.48	22.66	22.51

Conducted Power (*Unit: dBm)			
Band	WCDMA Band IV		
Channel	1312	1413	1513
Frequency	1712.4	1732.6	1752.6
RMC 12.2K	23.59	23.75	23.82
HSDPA Subtest-1	22.69	22.81	22.88
HSDPA Subtest-2	22.68	22.95	22.90
HSDPA Subtest-3	22.23	22.50	22.45
HSDPA Subtest-4	22.21	22.52	22.36
HSUPA Subtest-1	22.70	23.19	22.89
HSUPA Subtest-2	20.72	21.20	20.01
HSUPA Subtest-3	21.70	22.17	21.08
HSUPA Subtest-4	20.69	21.18	20.07
HSUPA Subtest-5	22.73	23.13	22.93



A2. WCDMA

Peak-to-Average Ratio

Mode	WCDMA Band V	WCDMA Band II	WCDMA Band IV	Limit: 13dB
Mod.	RMC 12.2Kbps	RMC 12.2Kbps	RMC 12.2Kbps	Result
Lowest CH	2.20	2.88	3.16	PASS
Middle CH	2.40	3.04	2.88	
Highest CH	2.36	2.88	3.20	

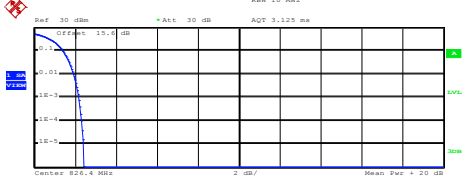
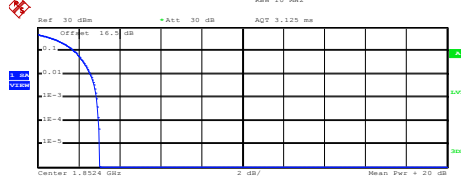
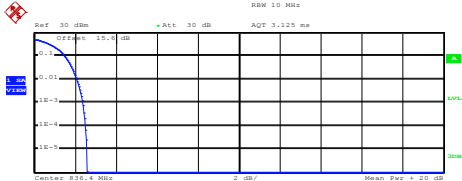
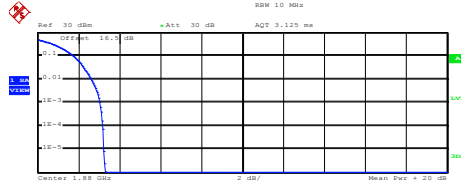
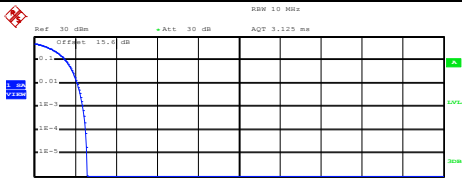
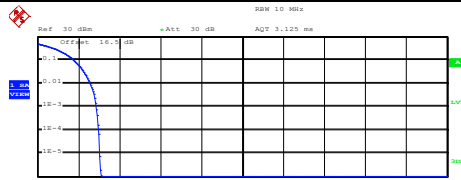

WCDMA Band V (RMC 12.2Kbps)	WCDMA Band II (RMC 12.2Kbps)																
<p align="center">Lowest Channel</p>  <p>Center 826.4 MHz 2 dB/ Mean Pwr + 20 dB</p> <p>Complementary Cumulative Distribution Function (100000 samples) Trace 1 Mean 23.52 dBm Peak 25.95 dBm Crest 2.42 dB</p> <table border="1"> <tr><td>10 %</td><td>1.40 dB</td></tr> <tr><td>1 %</td><td>1.92 dB</td></tr> <tr><td>.1 %</td><td>2.20 dB</td></tr> <tr><td>.01 %</td><td>2.32 dB</td></tr> </table> <p>Date: 7.OCT.2018 08:49:28</p>	10 %	1.40 dB	1 %	1.92 dB	.1 %	2.20 dB	.01 %	2.32 dB	<p align="center">Lowest Channel</p>  <p>Center 1.8524 GHz 2 dB/ Mean Pwr + 20 dB</p> <p>Complementary Cumulative Distribution Function (100000 samples) Trace 1 Mean 22.63 dBm Peak 25.67 dBm Crest 3.03 dB</p> <table border="1"> <tr><td>10 %</td><td>1.76 dB</td></tr> <tr><td>1 %</td><td>2.56 dB</td></tr> <tr><td>.1 %</td><td>2.88 dB</td></tr> <tr><td>.01 %</td><td>2.96 dB</td></tr> </table> <p>Date: 7.OCT.2018 07:50:33</p>	10 %	1.76 dB	1 %	2.56 dB	.1 %	2.88 dB	.01 %	2.96 dB
10 %	1.40 dB																
1 %	1.92 dB																
.1 %	2.20 dB																
.01 %	2.32 dB																
10 %	1.76 dB																
1 %	2.56 dB																
.1 %	2.88 dB																
.01 %	2.96 dB																
<p align="center">Middle Channel</p>  <p>Center 836.4 MHz 2 dB/ Mean Pwr + 20 dB</p> <p>Complementary Cumulative Distribution Function (100000 samples) Trace 1 Mean 23.58 dBm Peak 26.16 dBm Crest 2.58 dB</p> <table border="1"> <tr><td>10 %</td><td>1.48 dB</td></tr> <tr><td>1 %</td><td>2.08 dB</td></tr> <tr><td>.1 %</td><td>2.40 dB</td></tr> <tr><td>.01 %</td><td>2.52 dB</td></tr> </table> <p>Date: 7.OCT.2018 08:49:38</p>	10 %	1.48 dB	1 %	2.08 dB	.1 %	2.40 dB	.01 %	2.52 dB	<p align="center">Middle Channel</p>  <p>Center 1.88 GHz 2 dB/ Mean Pwr + 20 dB</p> <p>Complementary Cumulative Distribution Function (100000 samples) Trace 1 Mean 22.87 dBm Peak 26.16 dBm Crest 3.29 dB</p> <table border="1"> <tr><td>10 %</td><td>1.76 dB</td></tr> <tr><td>1 %</td><td>2.64 dB</td></tr> <tr><td>.1 %</td><td>3.04 dB</td></tr> <tr><td>.01 %</td><td>3.20 dB</td></tr> </table> <p>Date: 7.OCT.2018 07:50:45</p>	10 %	1.76 dB	1 %	2.64 dB	.1 %	3.04 dB	.01 %	3.20 dB
10 %	1.48 dB																
1 %	2.08 dB																
.1 %	2.40 dB																
.01 %	2.52 dB																
10 %	1.76 dB																
1 %	2.64 dB																
.1 %	3.04 dB																
.01 %	3.20 dB																
<p align="center">Highest Channel</p>  <p>Center 846.6 MHz 2 dB/ Mean Pwr + 20 dB</p> <p>Complementary Cumulative Distribution Function (100000 samples) Trace 1 Mean 23.31 dBm Peak 25.88 dBm Crest 2.57 dB</p> <table border="1"> <tr><td>10 %</td><td>1.52 dB</td></tr> <tr><td>1 %</td><td>2.12 dB</td></tr> <tr><td>.1 %</td><td>2.36 dB</td></tr> <tr><td>.01 %</td><td>2.52 dB</td></tr> </table> <p>Date: 7.OCT.2018 08:49:48</p>	10 %	1.52 dB	1 %	2.12 dB	.1 %	2.36 dB	.01 %	2.52 dB	<p align="center">Highest Channel</p>  <p>Center 1.9076 GHz 2 dB/ Mean Pwr + 20 dB</p> <p>Complementary Cumulative Distribution Function (100000 samples) Trace 1 Mean 22.23 dBm Peak 25.31 dBm Crest 3.09 dB</p> <table border="1"> <tr><td>10 %</td><td>1.76 dB</td></tr> <tr><td>1 %</td><td>2.56 dB</td></tr> <tr><td>.1 %</td><td>2.88 dB</td></tr> <tr><td>.01 %</td><td>3.00 dB</td></tr> </table> <p>Date: 7.OCT.2018 07:50:57</p>	10 %	1.76 dB	1 %	2.56 dB	.1 %	2.88 dB	.01 %	3.00 dB
10 %	1.52 dB																
1 %	2.12 dB																
.1 %	2.36 dB																
.01 %	2.52 dB																
10 %	1.76 dB																
1 %	2.56 dB																
.1 %	2.88 dB																
.01 %	3.00 dB																



WCDMA Band IV (RMC 12.2Kbps)

Lowest Channel

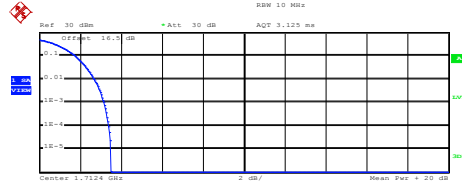

Center 1.7124 GHz 2 dB/ Mean Pwr + 20 dB

Complementary Cumulative Distribution Function (100000 samples)

Trace 1

Mean	22.58 dBm
Peak	26.09 dBm
Crest	3.51 dB
10 %	1.76 dB
1 %	2.68 dB
.1 %	3.16 dB
.01 %	3.40 dB

Date: 7.OCT.2018 08:09:56

Middle Channel

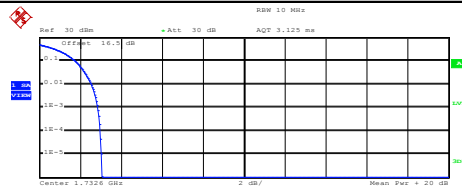

Center 1.7326 GHz 2 dB/ Mean Pwr + 20 dB

Complementary Cumulative Distribution Function (100000 samples)

Trace 1

Mean	22.74 dBm
Peak	25.81 dBm
Crest	3.07 dB
10 %	1.76 dB
1 %	2.56 dB
.1 %	2.88 dB
.01 %	3.00 dB

Date: 7.OCT.2018 08:10:34

Highest Channel

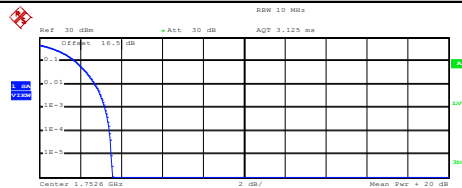

Center 1.7528 GHz 2 dB/ Mean Pwr + 20 dB

Complementary Cumulative Distribution Function (100000 samples)

Trace 1

Mean	23.29 dBm
Peak	26.87 dBm
Crest	3.58 dB
10 %	1.76 dB
1 %	2.72 dB
.1 %	3.20 dB
.01 %	3.44 dB

Date: 7.OCT.2018 08:10:55



26dB Bandwidth

Mode	WCDMA Band V	WCDMA Band II	WCDMA Band IV
Mod.	RMC 12.2Kbps	RMC 12.2Kbps	RMC 12.2Kbps
Lowest CH	4.77	4.72	4.72
Middle CH	4.76	4.72	4.71
Highest CH	4.76	4.71	4.71



WCDMA Band V (RMC 12.2Kbps)

WCDMA Band II (RMC 12.2Kbps)

Lowest Channel

Lowest Channel

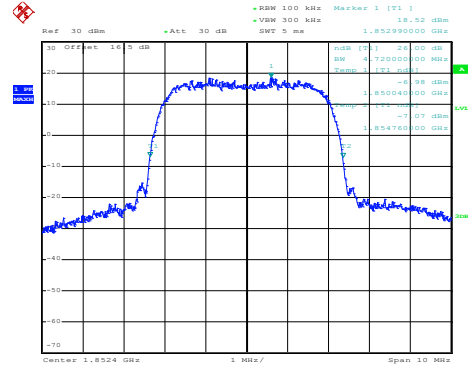
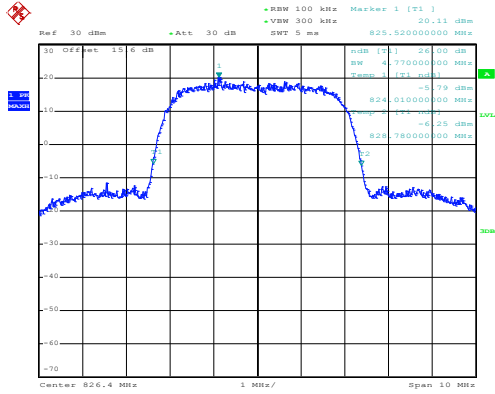

Date: 7.OCT.2018 08:43:48

Date: 7.OCT.2018 07:44:45

Middle Channel

Middle Channel

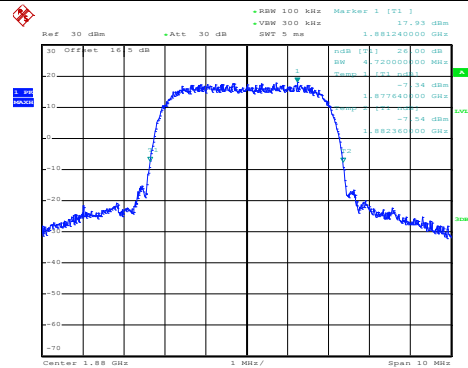
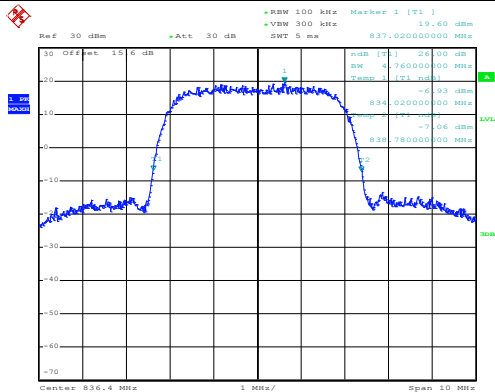

Date: 7.OCT.2018 08:44:20

Date: 7.OCT.2018 07:45:16

Highest Channel

Highest Channel

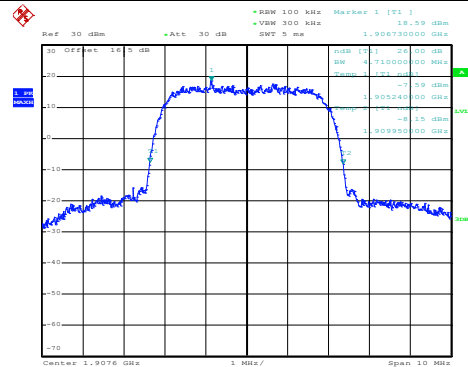
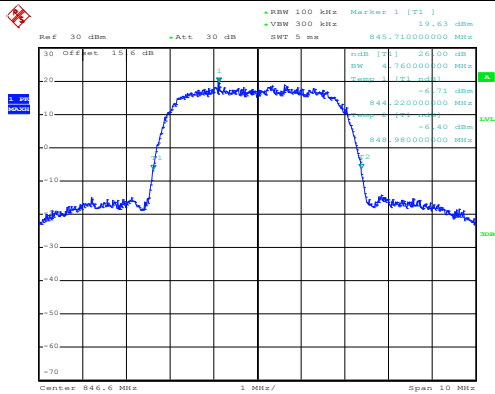

Date: 7.OCT.2018 08:44:54

Date: 7.OCT.2018 07:45:50



WCDMA Band IV (RMC 12.2Kbps)

Lowest Channel

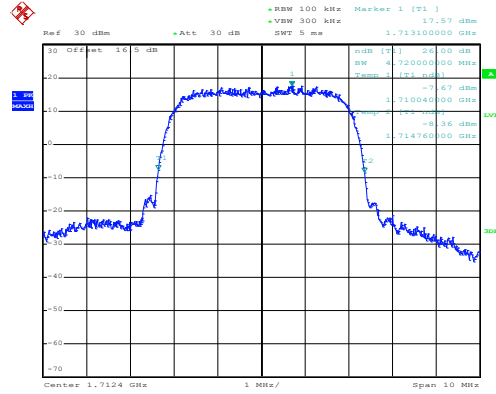

Date: 7.OCT.2018 08:03:14

Middle Channel

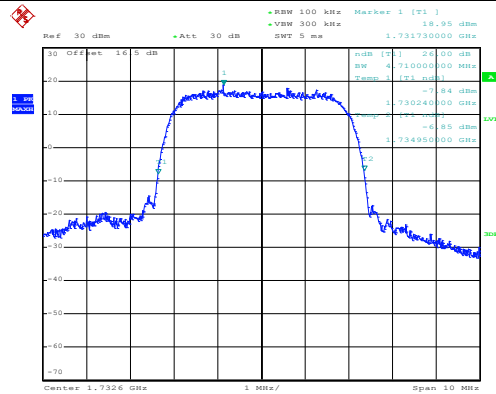

Date: 7.OCT.2018 08:03:48

Highest Channel

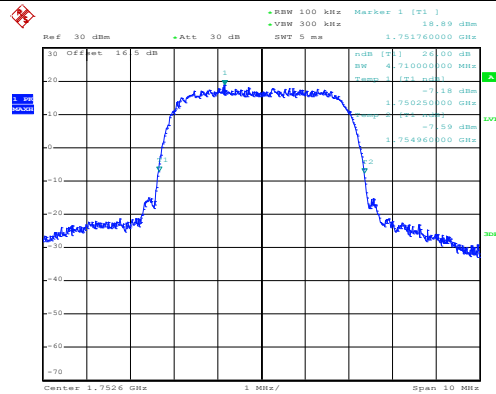

Date: 7.OCT.2018 08:04:22



Occupied Bandwidth

Mode	WCDMA Band V	WCDMA Band II	WCDMA Band IV
Mod.	RMC 12.2Kbps	RMC 12.2Kbps	RMC 12.2Kbps
Lowest CH	4.17	4.15	4.13
Middle CH	4.15	4.15	4.14
Highest CH	4.16	4.14	4.14

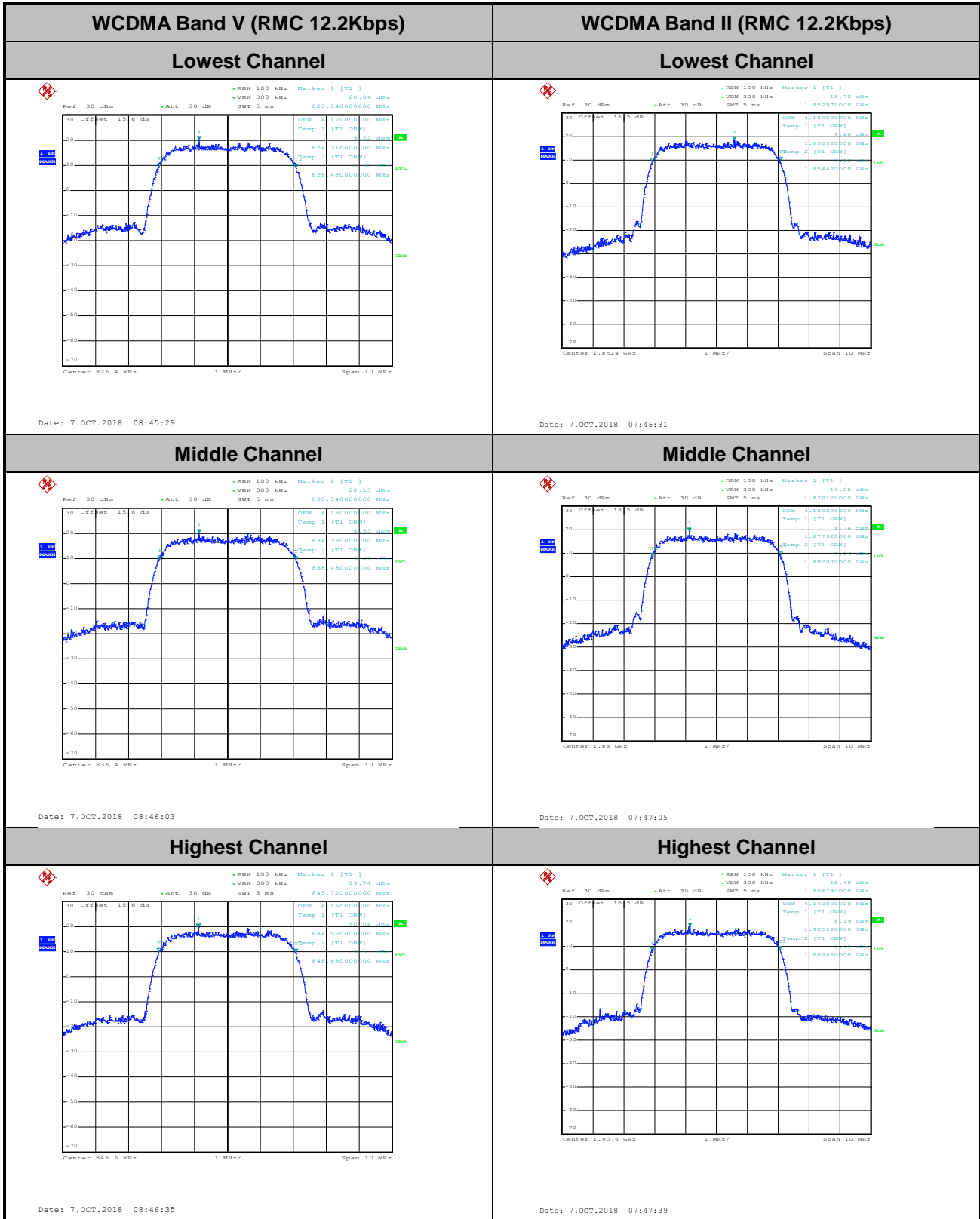



WCDMA Band IV (RMC 12.2Kbps)

Lowest Channel

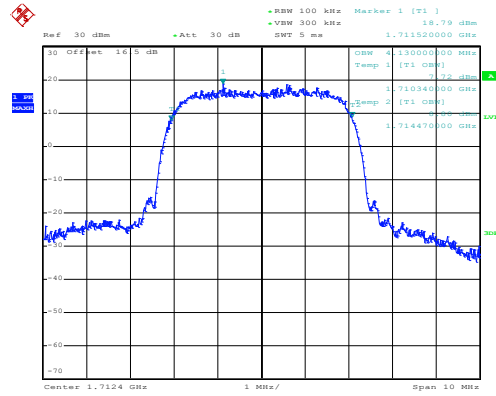

Date: 7.OCT.2018 08:05:06

Middle Channel

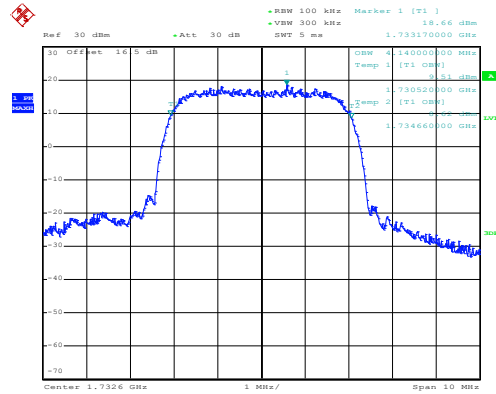

Date: 7.OCT.2018 08:05:44

Highest Channel

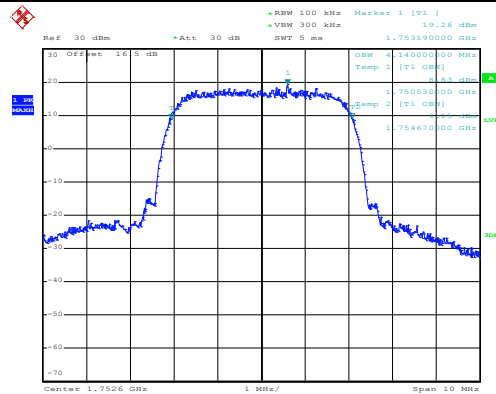

Date: 7.OCT.2018 08:06:33



Conducted Band Edge

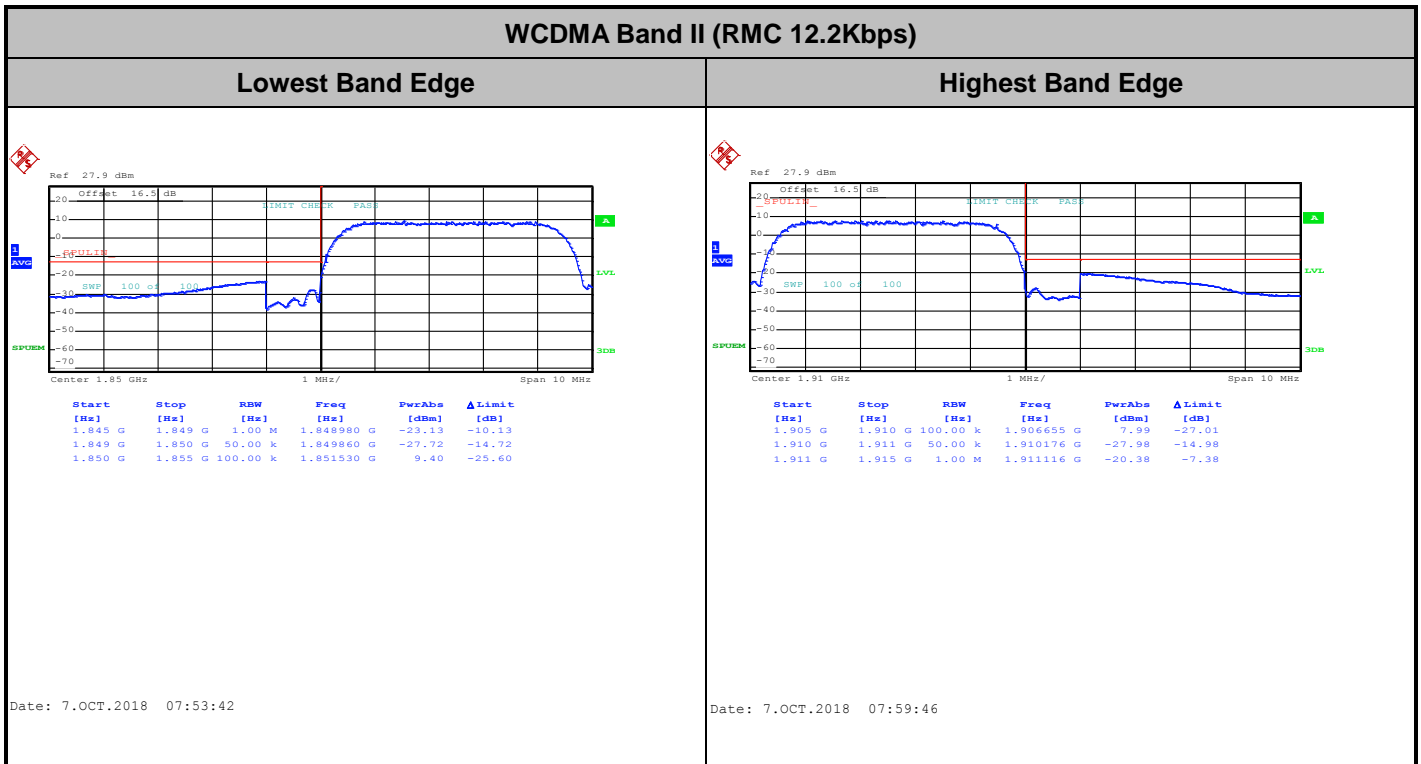
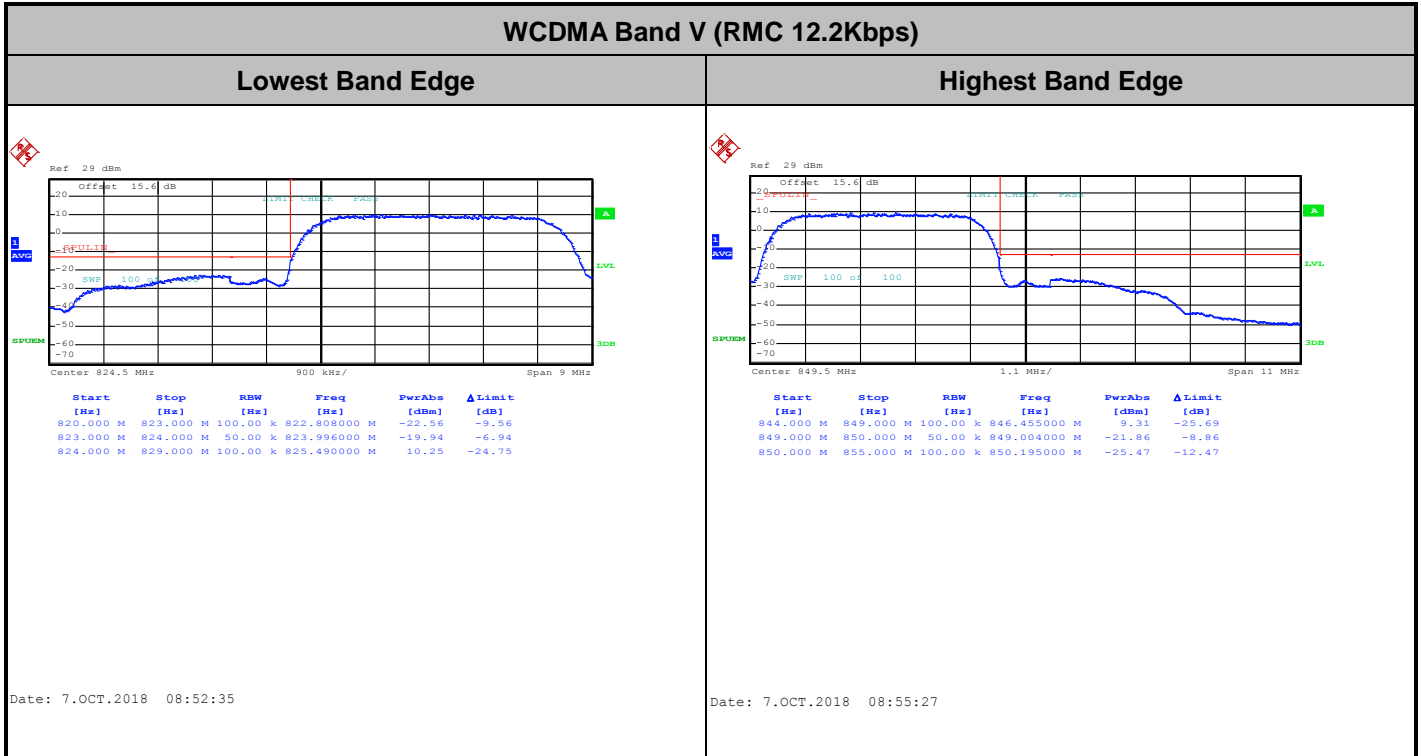



WCDMA Band IV (RMC 12.2Kbps)

Lowest Band Edge

Highest Band Edge

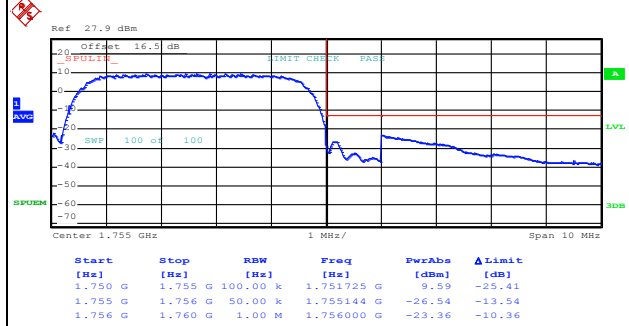
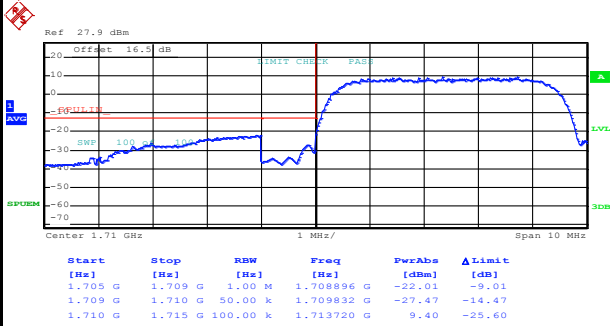

Date: 7.OCT.2018 08:14:26

Date: 7.OCT.2018 08:17:14

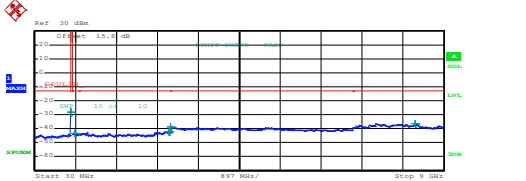
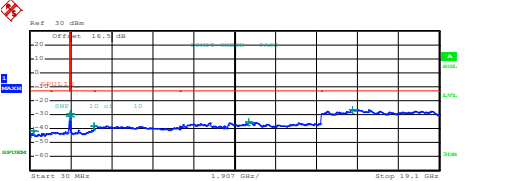
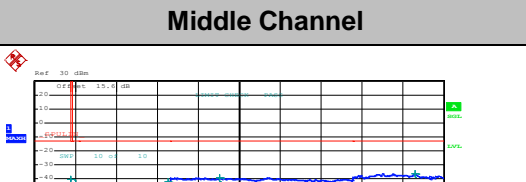
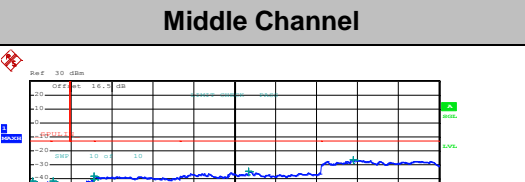
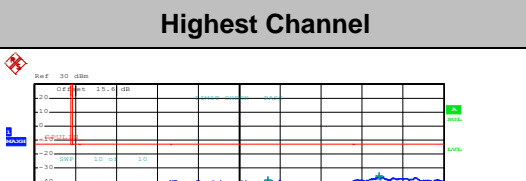
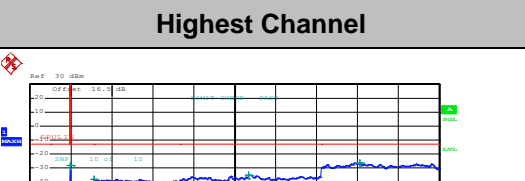

Conducted Spurious Emission

WCDMA Band V (RMC 12.2Kbps)	WCDMA Band II (RMC 12.2Kbps)																																																																																										
Lowest Channel	Lowest Channel																																																																																										
 <table border="1" data-bbox="239 660 766 739"> <thead> <tr> <th>Start</th> <th>Stop</th> <th>RBW</th> <th>Freq</th> <th>PwrAve</th> <th>ΔLimit</th> </tr> <tr> <th>[Hz]</th> <th>[Hz]</th> <th>[Hz]</th> <th>[Hz]</th> <th>[dBm]</th> <th>[dB]</th> </tr> </thead> <tbody> <tr> <td>30.000 M</td> <td>820.000 M</td> <td>1.00 M</td> <td>816.802500 M</td> <td>-28.97</td> <td>-25.97</td> </tr> <tr> <td>855.000 M</td> <td>1.000 G</td> <td>1.00 M</td> <td>912.130000 M</td> <td>-43.34</td> <td>-30.34</td> </tr> <tr> <td>1.000 G</td> <td>3.000 G</td> <td>1.00 M</td> <td>2.9795000 G</td> <td>-42.00</td> <td>-29.00</td> </tr> <tr> <td>3.000 G</td> <td>7.000 G</td> <td>1.00 M</td> <td>3.0080000 G</td> <td>-38.95</td> <td>-25.95</td> </tr> <tr> <td>7.000 G</td> <td>9.000 G</td> <td>1.00 M</td> <td>8.3715000 G</td> <td>-36.46</td> <td>-23.46</td> </tr> </tbody> </table> <p>Date: 7.OCT.2018 08:47:31</p>	Start	Stop	RBW	Freq	PwrAve	ΔLimit	[Hz]	[Hz]	[Hz]	[Hz]	[dBm]	[dB]	30.000 M	820.000 M	1.00 M	816.802500 M	-28.97	-25.97	855.000 M	1.000 G	1.00 M	912.130000 M	-43.34	-30.34	1.000 G	3.000 G	1.00 M	2.9795000 G	-42.00	-29.00	3.000 G	7.000 G	1.00 M	3.0080000 G	-38.95	-25.95	7.000 G	9.000 G	1.00 M	8.3715000 G	-36.46	-23.46	 <table border="1" data-bbox="893 660 1420 739"> <thead> <tr> <th>Start</th> <th>Stop</th> <th>RBW</th> <th>Freq</th> <th>PwrAve</th> <th>ΔLimit</th> </tr> <tr> <th>[Hz]</th> <th>[Hz]</th> <th>[Hz]</th> <th>[Hz]</th> <th>[dBm]</th> <th>[dB]</th> </tr> </thead> <tbody> <tr> <td>30.000 M</td> <td>1.000 G</td> <td>1.00 M</td> <td>168.467500 M</td> <td>-41.77</td> <td>-28.77</td> </tr> <tr> <td>1.000 G</td> <td>3.000 G</td> <td>1.00 M</td> <td>1.844578 G</td> <td>-31.33</td> <td>-18.33</td> </tr> <tr> <td>3.000 G</td> <td>7.000 G</td> <td>1.00 M</td> <td>1.932371 G</td> <td>-29.97</td> <td>-16.97</td> </tr> <tr> <td>7.000 G</td> <td>13.600 G</td> <td>1.00 M</td> <td>10.212590 G</td> <td>-35.02</td> <td>-22.02</td> </tr> <tr> <td>13.600 G</td> <td>19.100 G</td> <td>1.00 M</td> <td>15.047875 G</td> <td>-26.20</td> <td>-13.20</td> </tr> </tbody> </table> <p>Date: 7.OCT.2018 07:48:34</p>	Start	Stop	RBW	Freq	PwrAve	ΔLimit	[Hz]	[Hz]	[Hz]	[Hz]	[dBm]	[dB]	30.000 M	1.000 G	1.00 M	168.467500 M	-41.77	-28.77	1.000 G	3.000 G	1.00 M	1.844578 G	-31.33	-18.33	3.000 G	7.000 G	1.00 M	1.932371 G	-29.97	-16.97	7.000 G	13.600 G	1.00 M	10.212590 G	-35.02	-22.02	13.600 G	19.100 G	1.00 M	15.047875 G	-26.20	-13.20						
Start	Stop	RBW	Freq	PwrAve	ΔLimit																																																																																						
[Hz]	[Hz]	[Hz]	[Hz]	[dBm]	[dB]																																																																																						
30.000 M	820.000 M	1.00 M	816.802500 M	-28.97	-25.97																																																																																						
855.000 M	1.000 G	1.00 M	912.130000 M	-43.34	-30.34																																																																																						
1.000 G	3.000 G	1.00 M	2.9795000 G	-42.00	-29.00																																																																																						
3.000 G	7.000 G	1.00 M	3.0080000 G	-38.95	-25.95																																																																																						
7.000 G	9.000 G	1.00 M	8.3715000 G	-36.46	-23.46																																																																																						
Start	Stop	RBW	Freq	PwrAve	ΔLimit																																																																																						
[Hz]	[Hz]	[Hz]	[Hz]	[dBm]	[dB]																																																																																						
30.000 M	1.000 G	1.00 M	168.467500 M	-41.77	-28.77																																																																																						
1.000 G	3.000 G	1.00 M	1.844578 G	-31.33	-18.33																																																																																						
3.000 G	7.000 G	1.00 M	1.932371 G	-29.97	-16.97																																																																																						
7.000 G	13.600 G	1.00 M	10.212590 G	-35.02	-22.02																																																																																						
13.600 G	19.100 G	1.00 M	15.047875 G	-26.20	-13.20																																																																																						
<p>Middle Channel</p>  <table border="1" data-bbox="239 1131 766 1209"> <thead> <tr> <th>Start</th> <th>Stop</th> <th>RBW</th> <th>Freq</th> <th>PwrAve</th> <th>ΔLimit</th> </tr> <tr> <th>[Hz]</th> <th>[Hz]</th> <th>[Hz]</th> <th>[Hz]</th> <th>[dBm]</th> <th>[dB]</th> </tr> </thead> <tbody> <tr> <td>30.000 M</td> <td>820.000 M</td> <td>1.00 M</td> <td>819.210000 M</td> <td>-40.54</td> <td>-27.54</td> </tr> <tr> <td>855.000 M</td> <td>1.000 G</td> <td>1.00 M</td> <td>927.210000 M</td> <td>-43.60</td> <td>-30.60</td> </tr> <tr> <td>1.000 G</td> <td>3.000 G</td> <td>1.00 M</td> <td>2.9615000 G</td> <td>-42.46</td> <td>-29.46</td> </tr> <tr> <td>3.000 G</td> <td>7.000 G</td> <td>1.00 M</td> <td>4.0880000 G</td> <td>-39.19</td> <td>-26.19</td> </tr> <tr> <td>7.000 G</td> <td>9.000 G</td> <td>1.00 M</td> <td>8.3670000 G</td> <td>-36.33</td> <td>-23.33</td> </tr> </tbody> </table> <p>Date: 7.OCT.2018 08:48:21</p>	Start	Stop	RBW	Freq	PwrAve	ΔLimit	[Hz]	[Hz]	[Hz]	[Hz]	[dBm]	[dB]	30.000 M	820.000 M	1.00 M	819.210000 M	-40.54	-27.54	855.000 M	1.000 G	1.00 M	927.210000 M	-43.60	-30.60	1.000 G	3.000 G	1.00 M	2.9615000 G	-42.46	-29.46	3.000 G	7.000 G	1.00 M	4.0880000 G	-39.19	-26.19	7.000 G	9.000 G	1.00 M	8.3670000 G	-36.33	-23.33	<p>Middle Channel</p>  <table border="1" data-bbox="893 1131 1420 1209"> <thead> <tr> <th>Start</th> <th>Stop</th> <th>RBW</th> <th>Freq</th> <th>PwrAve</th> <th>ΔLimit</th> </tr> <tr> <th>[Hz]</th> <th>[Hz]</th> <th>[Hz]</th> <th>[Hz]</th> <th>[dBm]</th> <th>[dB]</th> </tr> </thead> <tbody> <tr> <td>30.000 M</td> <td>1.000 G</td> <td>1.00 M</td> <td>142.762500 M</td> <td>-41.77</td> <td>-28.77</td> </tr> <tr> <td>1.000 G</td> <td>3.000 G</td> <td>1.00 M</td> <td>1.808615 G</td> <td>-41.51</td> <td>-28.51</td> </tr> <tr> <td>1.915 G</td> <td>3.000 G</td> <td>1.00 M</td> <td>2.994846 G</td> <td>-40.55</td> <td>-27.55</td> </tr> <tr> <td>3.000 G</td> <td>7.000 G</td> <td>1.00 M</td> <td>3.034000 G</td> <td>-38.20</td> <td>-25.20</td> </tr> <tr> <td>7.000 G</td> <td>13.600 G</td> <td>1.00 M</td> <td>10.229000 G</td> <td>-34.66</td> <td>-21.66</td> </tr> <tr> <td>13.600 G</td> <td>19.100 G</td> <td>1.00 M</td> <td>15.085688 G</td> <td>-26.60</td> <td>-13.60</td> </tr> </tbody> </table> <p>Date: 7.OCT.2018 07:49:24</p>	Start	Stop	RBW	Freq	PwrAve	ΔLimit	[Hz]	[Hz]	[Hz]	[Hz]	[dBm]	[dB]	30.000 M	1.000 G	1.00 M	142.762500 M	-41.77	-28.77	1.000 G	3.000 G	1.00 M	1.808615 G	-41.51	-28.51	1.915 G	3.000 G	1.00 M	2.994846 G	-40.55	-27.55	3.000 G	7.000 G	1.00 M	3.034000 G	-38.20	-25.20	7.000 G	13.600 G	1.00 M	10.229000 G	-34.66	-21.66	13.600 G	19.100 G	1.00 M	15.085688 G	-26.60	-13.60
Start	Stop	RBW	Freq	PwrAve	ΔLimit																																																																																						
[Hz]	[Hz]	[Hz]	[Hz]	[dBm]	[dB]																																																																																						
30.000 M	820.000 M	1.00 M	819.210000 M	-40.54	-27.54																																																																																						
855.000 M	1.000 G	1.00 M	927.210000 M	-43.60	-30.60																																																																																						
1.000 G	3.000 G	1.00 M	2.9615000 G	-42.46	-29.46																																																																																						
3.000 G	7.000 G	1.00 M	4.0880000 G	-39.19	-26.19																																																																																						
7.000 G	9.000 G	1.00 M	8.3670000 G	-36.33	-23.33																																																																																						
Start	Stop	RBW	Freq	PwrAve	ΔLimit																																																																																						
[Hz]	[Hz]	[Hz]	[Hz]	[dBm]	[dB]																																																																																						
30.000 M	1.000 G	1.00 M	142.762500 M	-41.77	-28.77																																																																																						
1.000 G	3.000 G	1.00 M	1.808615 G	-41.51	-28.51																																																																																						
1.915 G	3.000 G	1.00 M	2.994846 G	-40.55	-27.55																																																																																						
3.000 G	7.000 G	1.00 M	3.034000 G	-38.20	-25.20																																																																																						
7.000 G	13.600 G	1.00 M	10.229000 G	-34.66	-21.66																																																																																						
13.600 G	19.100 G	1.00 M	15.085688 G	-26.60	-13.60																																																																																						
<p>Highest Channel</p>  <table border="1" data-bbox="239 1646 766 1724"> <thead> <tr> <th>Start</th> <th>Stop</th> <th>RBW</th> <th>Freq</th> <th>PwrAve</th> <th>ΔLimit</th> </tr> <tr> <th>[Hz]</th> <th>[Hz]</th> <th>[Hz]</th> <th>[Hz]</th> <th>[dBm]</th> <th>[dB]</th> </tr> </thead> <tbody> <tr> <td>30.000 M</td> <td>820.000 M</td> <td>1.00 M</td> <td>447.510000 M</td> <td>-43.95</td> <td>-30.95</td> </tr> <tr> <td>855.000 M</td> <td>1.000 G</td> <td>1.00 M</td> <td>873.560001 M</td> <td>-42.89</td> <td>-29.89</td> </tr> <tr> <td>1.000 G</td> <td>3.000 G</td> <td>1.00 M</td> <td>2.9825000 G</td> <td>-42.54</td> <td>-29.54</td> </tr> <tr> <td>3.000 G</td> <td>7.000 G</td> <td>1.00 M</td> <td>5.1380000 G</td> <td>-38.88</td> <td>-25.88</td> </tr> <tr> <td>7.000 G</td> <td>9.000 G</td> <td>1.00 M</td> <td>7.5740000 G</td> <td>-36.02</td> <td>-23.02</td> </tr> </tbody> </table> <p>Date: 7.OCT.2018 08:49:13</p>	Start	Stop	RBW	Freq	PwrAve	ΔLimit	[Hz]	[Hz]	[Hz]	[Hz]	[dBm]	[dB]	30.000 M	820.000 M	1.00 M	447.510000 M	-43.95	-30.95	855.000 M	1.000 G	1.00 M	873.560001 M	-42.89	-29.89	1.000 G	3.000 G	1.00 M	2.9825000 G	-42.54	-29.54	3.000 G	7.000 G	1.00 M	5.1380000 G	-38.88	-25.88	7.000 G	9.000 G	1.00 M	7.5740000 G	-36.02	-23.02	<p>Highest Channel</p>  <table border="1" data-bbox="893 1646 1420 1724"> <thead> <tr> <th>Start</th> <th>Stop</th> <th>RBW</th> <th>Freq</th> <th>PwrAve</th> <th>ΔLimit</th> </tr> <tr> <th>[Hz]</th> <th>[Hz]</th> <th>[Hz]</th> <th>[Hz]</th> <th>[dBm]</th> <th>[dB]</th> </tr> </thead> <tbody> <tr> <td>30.000 M</td> <td>1.000 G</td> <td>1.00 M</td> <td>168.467500 M</td> <td>-43.09</td> <td>-30.09</td> </tr> <tr> <td>1.000 G</td> <td>3.000 G</td> <td>1.00 M</td> <td>1.247363 G</td> <td>-42.42</td> <td>-29.42</td> </tr> <tr> <td>3.000 G</td> <td>7.000 G</td> <td>1.00 M</td> <td>1.932371 G</td> <td>-29.09</td> <td>-16.09</td> </tr> <tr> <td>7.000 G</td> <td>13.600 G</td> <td>1.00 M</td> <td>3.004000 G</td> <td>-38.15</td> <td>-25.15</td> </tr> <tr> <td>13.600 G</td> <td>19.100 G</td> <td>1.00 M</td> <td>10.210075 G</td> <td>-34.92</td> <td>-21.92</td> </tr> <tr> <td>19.100 G</td> <td>19.100 G</td> <td>1.00 M</td> <td>19.430000 G</td> <td>-26.56</td> <td>-13.56</td> </tr> </tbody> </table> <p>Date: 7.OCT.2018 07:50:15</p>	Start	Stop	RBW	Freq	PwrAve	ΔLimit	[Hz]	[Hz]	[Hz]	[Hz]	[dBm]	[dB]	30.000 M	1.000 G	1.00 M	168.467500 M	-43.09	-30.09	1.000 G	3.000 G	1.00 M	1.247363 G	-42.42	-29.42	3.000 G	7.000 G	1.00 M	1.932371 G	-29.09	-16.09	7.000 G	13.600 G	1.00 M	3.004000 G	-38.15	-25.15	13.600 G	19.100 G	1.00 M	10.210075 G	-34.92	-21.92	19.100 G	19.100 G	1.00 M	19.430000 G	-26.56	-13.56
Start	Stop	RBW	Freq	PwrAve	ΔLimit																																																																																						
[Hz]	[Hz]	[Hz]	[Hz]	[dBm]	[dB]																																																																																						
30.000 M	820.000 M	1.00 M	447.510000 M	-43.95	-30.95																																																																																						
855.000 M	1.000 G	1.00 M	873.560001 M	-42.89	-29.89																																																																																						
1.000 G	3.000 G	1.00 M	2.9825000 G	-42.54	-29.54																																																																																						
3.000 G	7.000 G	1.00 M	5.1380000 G	-38.88	-25.88																																																																																						
7.000 G	9.000 G	1.00 M	7.5740000 G	-36.02	-23.02																																																																																						
Start	Stop	RBW	Freq	PwrAve	ΔLimit																																																																																						
[Hz]	[Hz]	[Hz]	[Hz]	[dBm]	[dB]																																																																																						
30.000 M	1.000 G	1.00 M	168.467500 M	-43.09	-30.09																																																																																						
1.000 G	3.000 G	1.00 M	1.247363 G	-42.42	-29.42																																																																																						
3.000 G	7.000 G	1.00 M	1.932371 G	-29.09	-16.09																																																																																						
7.000 G	13.600 G	1.00 M	3.004000 G	-38.15	-25.15																																																																																						
13.600 G	19.100 G	1.00 M	10.210075 G	-34.92	-21.92																																																																																						
19.100 G	19.100 G	1.00 M	19.430000 G	-26.56	-13.56																																																																																						



WCDMA Band IV (RMC 12.2Kbps)

Lowest Channel

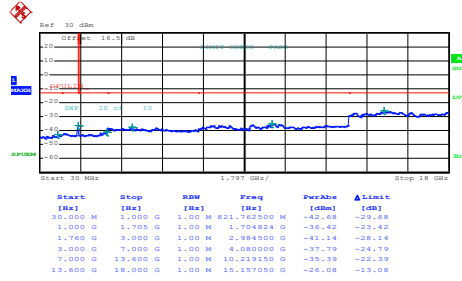

Date: 7.OCT.2018 08:07:51

Middle Channel

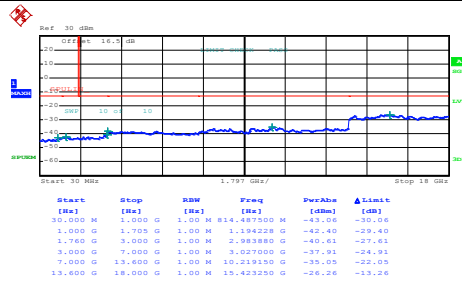

Date: 7.OCT.2018 08:08:45

Highest Channel

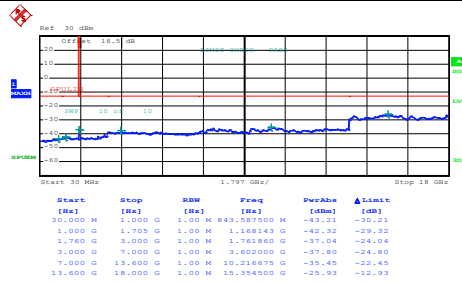

Date: 7.OCT.2018 08:09:39



Frequency Stability

Test Conditions	Middle Channel	WCDMA Band V (RMC 12.2Kbps)	Limit 2.5ppm
Temperature (°C)	Voltage (Volt)	Deviation (ppm)	Result
50	Normal Voltage	0.0012	PASS
40	Normal Voltage	0.0012	
30	Normal Voltage	0.0000	
20(Ref.)	Normal Voltage	0.0000	
10	Normal Voltage	0.0155	
0	Normal Voltage	0.0120	
-10	Normal Voltage	0.0143	
-20	Normal Voltage	0.0167	
-30	Normal Voltage	0.0167	
20	Maximum Voltage	0.0012	
20	Normal Voltage	0.0000	
20	Battery End Point	0.0120	

Test Conditions	Middle Channel	WCDMA Band II (RMC 12.2Kbps)	Limit Note 2.
Temperature (°C)	Voltage (Volt)	Deviation (ppm)	Result
50	Normal Voltage	0.0064	PASS
40	Normal Voltage	0.0059	
30	Normal Voltage	0.0069	
20(Ref.)	Normal Voltage	0.0000	
10	Normal Voltage	0.0011	
0	Normal Voltage	0.0027	
-10	Normal Voltage	0.0032	
-20	Normal Voltage	0.0037	
-30	Normal Voltage	0.0048	
20	Maximum Voltage	0.0011	
20	Normal Voltage	0.0000	
20	Battery End Point	0.0037	



Test Conditions	Middle Channel	WCDMA Band IV (RMC 12.2Kbps)	Limit Note 2.
Temperature (°C)	Voltage (Volt)	Deviation (ppm)	Result
50	Normal Voltage	0.0029	PASS
40	Normal Voltage	0.0029	
30	Normal Voltage	0.0029	
20(Ref.)	Normal Voltage	0.0000	
10	Normal Voltage	0.0150	
0	Normal Voltage	0.0185	
-10	Normal Voltage	0.0248	
-20	Normal Voltage	0.0242	
-30	Normal Voltage	0.0242	
20	Maximum Voltage	0.0127	
20	Normal Voltage	0.0000	
20	Battery End Point	0.0150	

Note:

- 1. Normal Voltage = 7.6V. ; Battery End Point (BEP) = 6.8 V. ; Maximum Voltage =8.7 V
- 2. The frequency fundamental emissions stay within the authorized frequency block.



Appendix B. Test Results of ERP/EIRP and Radiated Test

ERP/EIRP

Channel	Mode	Conducted		ERP	
		Power (dBm)	Power (Watts)	ERP(dBm)	ERP(W)
Lowest	WCDMA Band V	23.57	0.2272	22.42	0.1744
Middle	RMC 12.2Kbps	23.84	0.2418	22.69	0.1856
Highest	(GT - LC = 1 dB)	23.30	0.2136	22.15	0.1639
Limit	ERP < 7W	Result		PASS	

Channel	Mode	Conducted		EIRP	
		Power (dBm)	Power (Watts)	EIRP(dBm)	EIRP(W)
Lowest	WCDMA Band II	23.47	0.2223	23.97	0.2495
Middle	RMC 12.2Kbps	23.66	0.2323	24.16	0.2606
Highest	(GT - LC = 0.5 dB)	23.58	0.2280	24.08	0.2559
Limit	EIRP < 2W	Result		PASS	

Channel	Mode	Conducted		EIRP	
		Power (dBm)	Power (Watts)	EIRP(dBm)	EIRP(W)
Lowest	WCDMA Band IV	23.59	0.2285	24.59	0.2877
Middle	RMC 12.2Kbps	23.75	0.2371	24.75	0.2985
Highest	(GT - LC = 1 dB)	23.82	0.2409	24.82	0.3033
Limit	EIRP < 1W	Result		PASS	



Radiated Spurious Emission

WCDMA 850

WCDMA 850									
Channel	Frequency (MHz)	ERP (dBm)	Limit (dBm)	Over Limit (dB)	SPA Reading (dBm)	S.G. Power (dBm)	TX Cable loss (dB)	TX Antenna Gain (dBi)	Polarization (H/V)
Lowest	1653	-62.45	-13	-49.45	-73.71	-68.06	0.92	8.68	H
	2480	-58.11	-13	-45.11	-74.13	-65.49	1.15	10.67	H
	3306	-56.88	-13	-43.88	-74.56	-65.44	1.33	12.03	H
									H
									H
									H
									H
	1653	-62.96	-13	-49.96	-73.69	-68.57	0.92	8.68	V
	2480	-53.71	-13	-40.71	-69.92	-61.09	1.15	10.67	V
	3306	-56.47	-13	-43.47	-74.64	-65.03	1.33	12.03	V
									V
									V
									V
									V



Middle	1672	-61.60	-13	-48.60	-72.91	-67.07	1.24	8.85	H
	2512	-57.96	-13	-44.96	-74	-64.88	1.44	10.51	H
	3344	-56.70	-13	-43.70	-74.31	-64.74	1.74	11.93	H
									H
									H
									H
									H
	1672	-62.37	-13	-49.37	-73.02	-67.84	1.24	8.85	V
	2512	-54.15	-13	-41.15	-70.37	-61.07	1.44	10.51	V
	3344	-56.17	-13	-43.17	-74.23	-64.21	1.74	11.93	V
									V
									V
									V
									V
Highest	1693	-62.15	-13	-49.15	-73.52	-67.90	0.94	8.83	H
	2540	-57.38	-13	-44.38	-73.42	-64.82	1.16	10.75	H
	3386	-56.80	-13	-43.80	-74.31	-65.54	1.34	12.23	H
									H
									H
									H
									H
	1693	-62.28	-13	-49.28	-72.91	-68.03	0.94	8.83	V
	2540	-52.26	-13	-39.26	-68.39	-59.70	1.16	10.75	V
	3386	-56.39	-13	-43.39	-74.34	-65.13	1.34	12.23	V
									V
									V
									V
									V
								V	

Remark: Spurious emissions within 30-1000MHz were found more than 20dB below limit line.



WCDMA 1900

WCDMA 1900									
Channel	Frequency (MHz)	EIRP (dBm)	Limit (dBm)	Over Limit (dB)	SPA Reading (dBm)	S.G. Power (dBm)	TX Cable loss (dB)	TX Antenna Gain (dBi)	Polarization (H/V)
Lowest	3707	-54.98	-13	-41.98	-75.17	-66.19	1.41	12.62	H
	5555	-50.76	-13	-37.76	-76.01	-62.32	1.74	13.30	H
	7410	-46.60	-13	-33.60	-74.94	-55.90	1.94	11.24	H
									H
									H
									H
									H
	3707	-54.81	-13	-41.81	-75.14	-66.02	1.41	12.62	V
	5555	-51.24	-13	-38.24	-76.01	-62.80	1.74	13.30	V
	7410	-46.55	-13	-33.55	-74.75	-55.85	1.94	11.24	V
									V
									V
									V
									V
Middle	3763	-54.37	-13	-41.37	-74.82	-64.61	2.01	12.24	H
	5640	-50.82	-13	-37.82	-76.08	-61.09	2.12	12.40	H
	7520	-46.76	-13	-33.76	-74.59	-54.72	2.11	10.07	H
									H
									H
									H
									H
	3763	-54.09	-13	-41.09	-74.76	-64.33	2.01	12.24	V
	5640	-51.08	-13	-38.08	-75.94	-61.35	2.12	12.40	V
	7520	-46.64	-13	-33.64	-74.43	-54.60	2.11	10.07	V
									V
									V
									V
									V



Highest	3812	-54.94	-13	-41.94	-75.52	-66.19	1.44	12.69	H
	5723	-50.42	-13	-37.42	-76.08	-61.99	1.73	13.30	H
	7630	-47.56	-13	-34.56	-75.06	-56.68	2.01	11.13	H
									H
									H
									H
									H
	3812	-54.65	-13	-41.65	-75.5	-65.90	1.44	12.69	V
	7523	-50.92	-13	-37.92	-78.72	-60.03	1.99	11.10	V
	7630	-47.66	-13	-34.66	-75.07	-56.78	2.01	11.13	V
									V
									V
									V
									V

Remark: Spurious emissions within 30-1000MHz were found more than 20dB below limit line.



WCDMA 1700

WCDMA 1700									
Channel	Frequency (MHz)	EIRP (dBm)	Limit (dBm)	Over Limit (dB)	SPA Reading (dBm)	S.G. Power (dBm)	TX Cable loss (dB)	TX Antenna Gain (dBi)	Polarization (H/V)
Lowest	3427	-56.15	-13	-43.15	-74.56	-67.13	1.35	12.32	H
	5137	-51.95	-13	-38.95	-75.98	-63.10	1.65	12.79	H
	6850	-48.27	-13	-35.27	-75.48	-58.64	1.74	12.11	H
									H
									H
									H
									H
	3427	-54.94	-13	-41.94	-73.76	-65.92	1.35	12.32	V
	5137	-52.60	-13	-39.60	-76.38	-63.75	1.65	12.79	V
	6850	-48.51	-13	-35.51	-75.31	-58.88	1.74	12.11	V
									V
									V
									V
									V
Middle	3462	-55.77	-13	-42.77	-74.5	-66.83	1.35	12.41	H
	5198	-51.93	-13	-38.93	-75.98	-63.15	1.66	12.88	H
	6927	-47.63	-13	-34.63	-75.25	-57.90	1.73	12.00	H
									H
									H
									H
									H
	3462	-54.67	-13	-41.67	-73.78	-65.73	1.35	12.41	V
	5198	-52.03	-13	-39.03	-75.92	-63.25	1.66	12.88	V
	6927	-48.37	-13	-35.37	-75.53	-58.64	1.73	12.00	V
									V
									V
									V
									V



Highest	3504	-54.91	-13	-41.91	-73.93	-66.05	1.36	12.50	H
	5257	-51.66	-13	-38.66	-75.87	-62.94	1.68	12.96	H
	7011	-46.81	-13	-33.81	-74.77	-56.97	1.73	11.88	H
									H
									H
									H
									H
	3504	-54.59	-13	-41.59	-73.97	-65.73	1.36	12.50	V
	5257	-52.25	-13	-39.25	-76.23	-63.53	1.68	12.96	V
	7011	-47.21	-13	-34.21	-74.69	-57.37	1.73	11.88	V
									V
									V
									V
									V

Remark: Spurious emissions within 30-1000MHz were found more than 20dB below limit line.