



FCC RADIO TEST REPORT

FCC ID : 2ABVH-INARI10B2
Equipment : Tablet
Brand Name : AAVA
Model Name : INARI10B-LTG-1
Applicant : Aava Mobile Oy
NAHKATEHTAANKATU 2 90130 OULU FINLAND
Manufacturer : Aava Mobile Oy
NAHKATEHTAANKATU 2 90130 OULU FINLAND
Standard : FCC Part 15 Subpart C §15.225

The product was received on Jun. 06, 2019 and testing was started from Jun. 19, 2019 and completed on Jun. 25, 2019. We, SPORTON INTERNATIONAL INC., EMC & Wireless Communications Laboratory, would like to declare that the tested sample has been evaluated in accordance with the test procedures and has been in compliance with the applicable technical standards.

The report must not be used by the client to claim product certification, approval, or endorsement by TAF or any agency of government.

The test results in this variant report apply exclusively to the tested model / sample. Without written approval of SPORTON INTERNATIONAL INC. EMC & Wireless Communications Laboratory, the test report shall not be reproduced except in full.

Reviewed by: Jones Tsai

SPORTON INTERNATIONAL INC. EMC & Wireless Communications Laboratory
No. 52, Huaya 1st Rd., Guishan Dist., Taoyuan City, Taiwan (R.O.C.)



Table of Contents

| | |
|---|-----------|
| History of this test report..... | 3 |
| Summary of Test Result..... | 4 |
| 1. General Description | 5 |
| 1.1 Product Feature of Equipment Under Test | 5 |
| 1.2 Product Specification of Equipment Under Test | 5 |
| 1.3 Modification of EUT | 5 |
| 1.4 Testing Location | 6 |
| 1.5 Applicable Standards..... | 6 |
| 2. Test Configuration of Equipment Under Test..... | 7 |
| 2.1 Descriptions of Test Mode | 7 |
| 2.2 Connection Diagram of Test System | 7 |
| 2.3 Table for Supporting Units | 7 |
| 2.4 EUT Operation Test Setup | 7 |
| 3. Test Results | 8 |
| 3.1 20dB and 99% OBW Spectrum Bandwidth Measurement..... | 8 |
| 3.2 Frequency Stability Measurement | 9 |
| 3.3 Field Strength of Fundamental Emissions and Mask Measurement..... | 10 |
| 3.4 Radiated Emissions Measurement | 12 |
| 3.5 Antenna Requirements..... | 15 |
| 4. List of Measuring Equipment | 16 |
| 5. Uncertainty of Evaluation | 17 |
| Appendix A. Test Results of Conducted Test Items | |
| A1. Test Result of 20dB Spectrum Bandwidth | |
| A2. Test Result of Frequency Stability | |
| Appendix B. Test Results of Radiated Test Items | |
| B1. Test Result of Field Strength of Fundamental Emissions | |
| B2. Results of Radiated Emissions (9 kHz~30MHz) | |
| B3. Results of Radiated Emissions (30MHz~1GHz) | |
| Appendix C. Setup Photographs | |
| Appendix D. Original Report | |



Summary of Test Result

| Report Clause | Ref Std. Clause | Test Items | Result (PASS/FAIL) | Remark |
|---------------|---------------------|---|--------------------|--------------------------------------|
| - | 15.207 | AC Power Line Conducted Emissions | Not Required | - |
| 3.1 | 15.215(c) | 20dB Spectrum Bandwidth | Pass | - |
| | 2.1049 | 99% OBW Spectrum Bandwidth | Reporting only | - |
| 3.2 | 15.225(e) | Frequency Stability | Pass | - |
| 3.3 | 15.225(a)(b)(c) | Field Strength of Fundamental Emissions | Pass | Max level 21.77 dBµV/m at 13.560 MHz |
| 3.4 | 15.225(d) 15.209 | Radiated Spurious Emissions | Pass | Under limit 6.81 dB at 40.680MHz |
| 3.5 | 15.203 | Antenna Requirements | Pass | - |

Remark:

1. Not required means after assessing, test items are not necessary to carry out.
2. This is a variant report by adding WWAN module. All the test cases were performed on original report which can be referred to Sporton Report Number FR912012D as appendix D. Based on the original report, the test cases were verified.

Declaration of Conformity:

The test results with all measurement uncertainty excluded are presented in accordance with the regulation limits or requirements declared by manufacturers.

Comments and Explanations:

The declared of product specification for EUT presented in the report are provided by the manufacturer, and the manufacturer takes all the responsibilities for the accuracy of product specification.

Reviewed by: Wii Chang

Report Producer: Ann Lee

1. General Description

1.1 Product Feature of Equipment Under Test

| Product Feature | |
|--|---|
| Equipment | Tablet |
| Brand Name | AAVA |
| Model Name | INARI10B-LTG-1 |
| FCC ID | 2ABVH-INARI10B2 |
| EUT supports Radios application | WCDMA/HSPA/LTE/NFC/GNSS WLAN 11a/b/g/n HT20/HT40 WLAN 11ac VHT20/VHT40/VHT80 Bluetooth BR/EDR/LE |
| HW Version | RU |
| SW Version | Windows 10 |
| EUT Stage | Identical Prototype |

Remark: The above EUT's information was declared by manufacturer.

| Specification of Accessories | | | | |
|------------------------------|-------------------|---------------|-------------------|----------------|
| AC Adapter | Brand Name | PHIHONG | Model Name | AQ18A-59CFA |
| Battery | Brand Name | Etica Battery | Model Name | AMME3950 |
| USB Cable | Brand Name | PHIHONG | Model Name | UES-1001A160-R |

1.2 Product Specification of Equipment Under Test

| Standards-related Product Specification | |
|---|-----------------------------|
| Tx/Rx Frequency Range | 13.553 ~ 13.567MHz |
| Channel Number | 1 |
| 20dBW | 2.64 KHz |
| 99%OBW | 2.24 KHz |
| Antenna Type | Ferrite-Backed Loop Antenna |
| Type of Modulation | ASK |

Remark: The above EUT's information was declared by manufacturer.

1.3 Modification of EUT

No modifications are made to the EUT during all test items.



1.4 Testing Location

| | |
|---------------------------|---|
| Test Site | SPORTON INTERNATIONAL INC. EMC & Wireless Communications Laboratory |
| Test Site Location | No.52, Huaya 1st Rd., Guishan Dist., Taoyuan City, Taiwan (R.O.C.) TEL: +886-3-327-3456 FAX: +886-3-328-4978 |
| Test Site No. | Sporton Site No. TH03-HY |
| Test Engineer | Benjamin Lin |
| Temperature | 22~24°C |
| Relative Humidity | 53~55% |

Note: The test site complies with ANSI C63.4 2014 requirement.

| | |
|---------------------------|---|
| Test Site | SPORTON INTERNATIONAL INC. EMC & Wireless Communications Laboratory |
| Test Site Location | No.58, Aly. 75, Ln. 564, Wenhua 3rd, Rd., Guishan Dist., Taoyuan City, Taiwan (R.O.C.) TEL: +886-3-327-0868 FAX: +886-3-327-0855 |
| Test Site No. | Sporton Site No. 03CH11-HY |
| Test Engineer | Hao Shu |
| Temperature | 21~26°C |
| Relative Humidity | 51~56% |

Note: The test site complies with ANSI C63.4 2014 requirement.

FCC designation No.: TW1190 and TW0007

1.5 Applicable Standards

According to the specifications of the manufacturer, the EUT must comply with the requirements of the following standards:

- ♦ FCC Part 15 Subpart C §15.225
- ♦ FCC KDB 414788 D01 Radiated Test Site v01r01
- ♦ ANSI C63.10-2013

2. Test Configuration of Equipment Under Test

2.1 Descriptions of Test Mode

Investigation has been done on all the possible configurations.

The following table is a list of the test modes shown in this test report.

| Test Items | |
|-------------------------------|---|
| 20dB Spectrum Bandwidth | Field Strength of Fundamental Emissions |
| Radiated Emissions 9kHz~30MHz | Frequency Stability |
| Radiated Emissions 30MHz~1GHz | |

The EUT pre-scanned in four NFC type, A, B, F, V. The worst type (type F) was recorded in this report. Pre-scanned tests, X, Y, Z in three orthogonal panels to determine the final configuration (Y plane as worst plane) from all possible combinations.

2.2 Connection Diagram of Test System

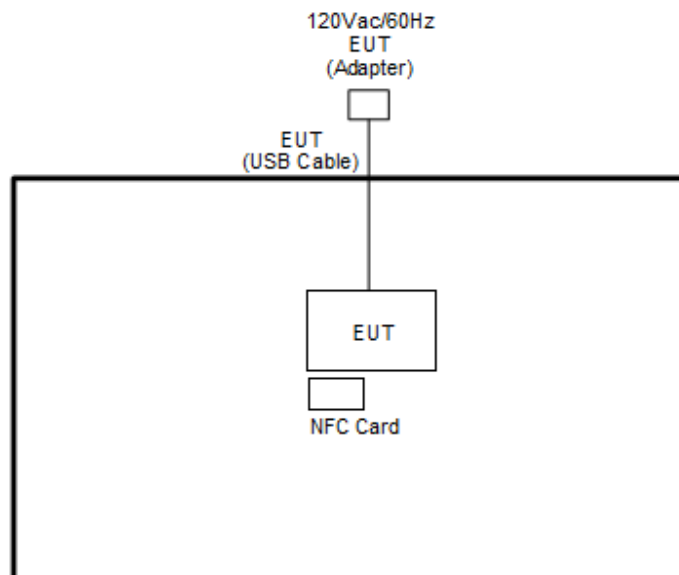

2.3 Table for Supporting Units

| Item | Equipment | Trade Name | Model Name | FCC ID | Data Cable | Power Cord |
|------|-----------|------------|------------|--------|------------|------------|
| 1. | NFC Card | N/A | N/A | N/A | N/A | N/A |

2.4 EUT Operation Test Setup

The EUT was programmed to be in continuously transmitting mode.

The ancillary equipment, NFC card, is used to make the EUT (NFC) continuously transmit at 13.56MHz and is placed around 1 cm gap to the EUT.

3. Test Results

3.1 20dB and 99% OBW Spectrum Bandwidth Measurement

3.1.1 Limit

Intentional radiators must be designed to ensure that the 20dB and 99% emission bandwidth in the specific band 13.553~13.567MHz.

3.1.2 Measuring Instruments

See list of measuring instruments of this test report.

3.1.3 Test Procedures

1. The spectrum analyzer connected via a receive antenna placed near the EUT in peak Max hold mode.
2. The resolution bandwidth of 1 kHz and the video bandwidth of 3 kHz were used.
3. Measured the spectrum width with power higher than 20dB below carrier.
4. Measured the 99% OBW.

3.1.4 Test Setup

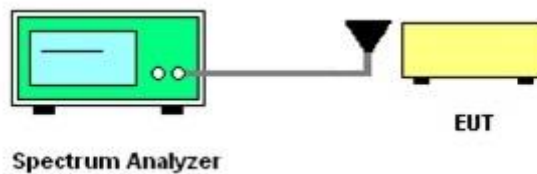

3.1.5 Test Result of Conducted Test Items

Please refer to Appendix A.

3.2 Frequency Stability Measurement

3.2.1 Limit

The frequency tolerance of the carrier signal shall be maintained within +/- 0.01% (100ppm) of the operating frequency over a temperature variation of -20 degrees to +50 degrees C at normal supply voltage, and for a variation in the primary supply voltage from 85% to 115% of the rated supply voltage at a temperature of 20 degrees C. For battery operated equipment, the equipment tests shall be performed using a new battery.

3.2.2 Measuring Instruments

See list of measuring instruments of this test report.

3.2.3 Test Procedures

1. The spectrum analyzer connected via a receive antenna placed near the EUT.
2. EUT have transmitted signal and fixed channelize.
3. Set the spectrum analyzer span to view the entire emissions bandwidth.
4. Set RBW = 1 kHz, VBW = 3 kHz with peak detector and maxhold settings.
5. The f_c is declaring of channel frequency. Then the frequency error formula is $(f_c - f) / f_c \times 10^6$ ppm and the limit is less than ± 100 ppm.
6. Extreme temperature rule is -20°C~50°C.

3.2.4 Test Setup

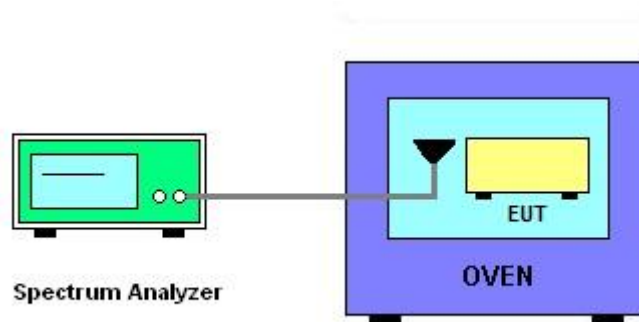

3.2.5 Test Result of Conducted Test Items

Please refer to Appendix A.



3.3 Field Strength of Fundamental Emissions and Mask Measurement

3.3.1 Limit

| Rules and specifications | FCC CFR 47 Part 15 section 15.225 | | | |
|--------------------------|---|--|--|---|
| Description | Compliance with the spectrum mask is tested with RBW set to 9kHz. | | | |
| Freq. of Emission (MHz) | Field Strength ($\mu\text{V/m}$) at 30m | Field Strength ($\text{dB}\mu\text{V/m}$) at 30m | Field Strength ($\text{dB}\mu\text{V/m}$) at 10m | Field Strength ($\text{dB}\mu\text{V/m}$) at 3m |
| 1.705~13.110 | 30 | 29.5 | 48.58 | 69.5 |
| 13.110~13.410 | 106 | 40.5 | 59.58 | 80.5 |
| 13.410~13.553 | 334 | 50.5 | 69.58 | 90.5 |
| 13.553~13.567 | 15848 | 84.0 | 103.08 | 124.0 |
| 13.567~13.710 | 334 | 50.5 | 69.58 | 90.5 |
| 13.710~14.010 | 106 | 40.5 | 59.58 | 80.5 |
| 14.010~30.000 | 30 | 29.5 | 48.58 | 69.5 |

3.3.2 Measuring Instruments

See list of measuring instruments of this test report.

3.3.3 Test Procedures

1. Configure the EUT according to ANSI C63.10. The EUT was placed on the top of the turntable 0.8 meter above ground. The phase center of the loop receiving antenna mounted antenna tower was placed 3 meters far away from the turntable.
 2. Power on the EUT and all the supporting units. The turntable was rotated by 360 degrees to determine the position of the highest radiation.
 3. The height of the receiving antenna was fixed at one meter above ground to find the maximum emissions field strength.
 4. For Fundamental emissions, use the receiver to measure QP reading.
 5. When the radiated emissions limits are expressed in terms of the average value of the emissions, and pulsed operation is employed, the measurement field strength shall be determined by averaging over one complete pulse train, including blanking intervals, as long as the pulse train does not exceed 0.1 seconds. As an alternative (provided the transmitter operates for longer than 0.1 seconds) or in cases where the pulse train exceeds 0.1 seconds, the measured field strength shall be determined from the average absolute voltage during a 0.1 second interval during which the field strength is at its maximum value.
 6. Compliance with the spectrum mask is tested with RBW set to 9kHz.
- Note: Emission level (dB μ V/m) = 20 log Emission level (μ V/m).

3.3.4 Test Setup

For radiated emissions below 30MHz

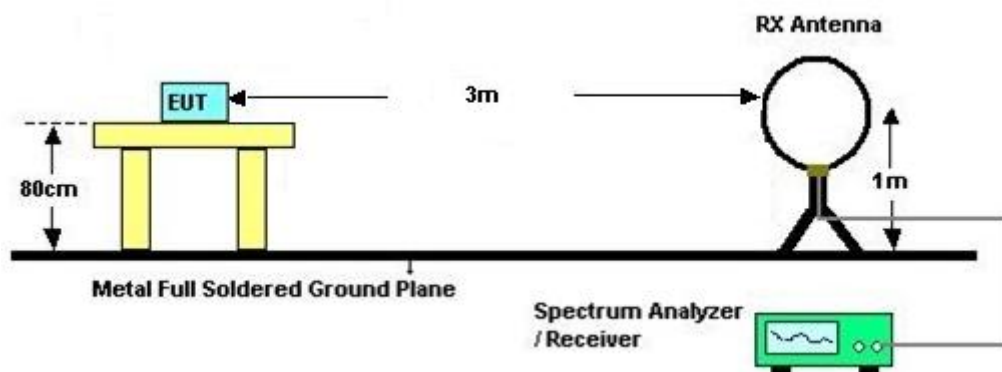

3.3.5 Test Result of Field Strength of Fundamental Emissions and Mask

Please refer to Appendix B.



3.4 Radiated Emissions Measurement

3.4.1 Limit

The field strength of any emissions which appear outside of 13.110 ~14.010MHz band shall not exceed the general radiated emissions limits.

| Frequencies (MHz) | Field Strength (µV/m) | Measurement Distance (meters) |
|-------------------|-----------------------|-------------------------------|
| 0.009~0.490 | 2400/F(kHz) | 300 |
| 0.490~1.705 | 24000/F(kHz) | 30 |
| 1.705~30.0 | 30 | 30 |
| 30~88 | 100 | 3 |
| 88~216 | 150 | 3 |
| 216~960 | 200 | 3 |
| Above 960 | 500 | 3 |

3.4.2 Measuring Instruments

See list of measuring instruments of this test report.

3.4.3 Measuring Instrument Setting

The following table is the setting of receiver:

| Receiver Parameter | Setting |
|--------------------------------|---------------------|
| Attenuation | Auto |
| Frequency Range: 9kHz~150kHz | RBW 200Hz for QP |
| Frequency Range: 150kHz~30MHz | RBW 9kHz for QP |
| Frequency Range: 30MHz~1000MHz | RBW 120kHz for Peak |

Note: The emission limits shown in the above table are based on measurements employing a CISPR quasi-peak detector except for the frequency bands 9-90 kHz and 110-490 kHz. Radiated emission limits in these two bands are based on measurements employing an average detector.



3.4.4 Test Procedures

1. Configure the EUT according to ANSI C63.10. The EUT was placed on the top of the turntable 0.8 meter above ground. The phase center of the receiving antenna mounted on the top of a height-variable antenna tower was placed 3 meters far away from the turntable.
2. Power on the EUT and all the supporting units. The turntable was rotated by 360 degrees to determine the position of the highest radiation.
3. The height of the broadband receiving antenna was varied between one meter and four meters above ground to find the maximum emissions field strength of both horizontal and vertical polarization.
4. For each suspected emissions, the antenna tower was scan (from 1 M to 4 M) and then the turntable was rotated (from 0 degree to 360 degrees) to find the maximum reading.
5. Set the test-receiver system to Peak or CISPR quasi-peak Detect Function with specified bandwidth under Maximum Hold Mode.
6. When the radiated emissions limits are expressed in terms of the average value of the emissions, and pulsed operation is employed, the measurement field strength shall be determined by averaging over one complete pulse train, including blanking intervals, as long as the pulse train does not exceed 0.1 seconds. As an alternative (provided the transmitter operates for longer than 0.1 seconds) or in cases where the pulse train exceeds 0.1 seconds, the measured field strength shall be determined from the average absolute voltage during a 0.1 second interval during which the field strength is at its maximum value.
7. In case the emission is lower than 30MHz, loop antenna has to be used for measurement and the recorded data should be QP measured by receiver.

3.4.5 Test Setup

For radiated emissions below 30MHz

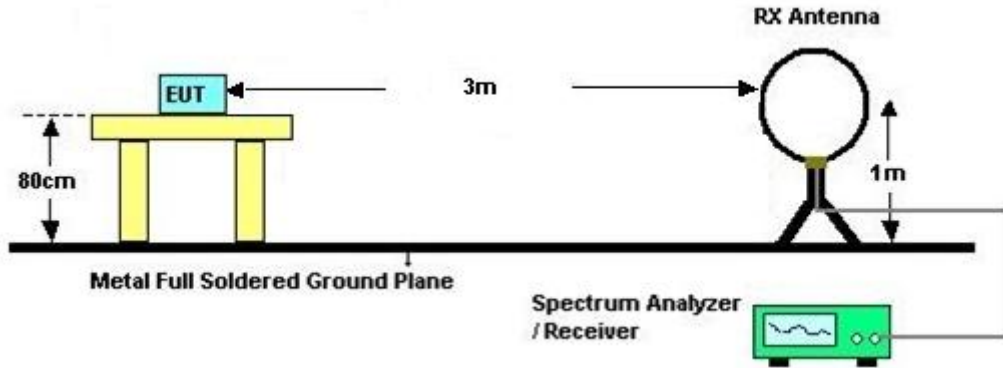

For radiated emissions above 30MHz

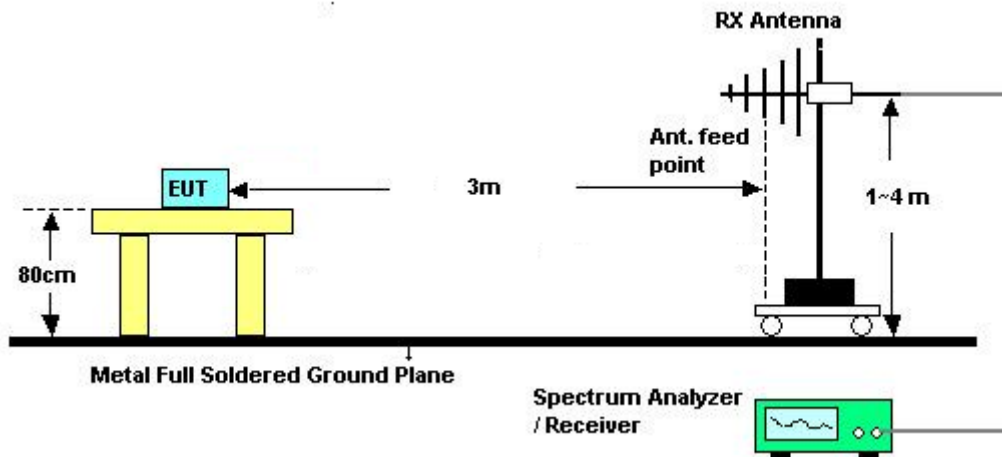

3.4.6 Test Result of Radiated Emissions Measurement

Please refer to Appendix B.

Remark: There is a comparison data of both open-field test site and alternative test site - semi-Anechoic chamber according to 414788 D01 Radiated Test Site v01r01, and the result came out very similar.



3.5 Antenna Requirements

3.5.1 Standard Applicable

Except for special regulations, the Low-power Radio-frequency Devices must not be equipped with any jacket for installing an antenna with extension cable. An intentional radiator shall be designed to ensure that no antenna other than that furnished by the responsible party shall be used with the device. The use of a permanently attached antenna or of an antenna that uses a unique coupling to the intentional radiator shall be considered sufficient to comply with the provisions of this Section. The manufacturer may design the unit so that the user can replace a broken antenna, but the use of a standard antenna jack or electrical connector is prohibited.

The use of a permanently attached antenna or of an antenna that uses a unique coupling to the intentional radiator shall be considered sufficient to comply with the rule.

3.5.2 Antenna Anti-Replacement Construction

An embedded-in antenna design is used.



4. List of Measuring Equipment

| Instrument | Manufacturer | Model No. | Serial No. | Characteristics | Calibration Date | Test Date | Due Date | Remark |
|---------------------|--------------------|-------------------------|--------------------|-----------------|------------------|----------------|---------------|--------------------------|
| Software | Audix | E3 6.2009-8-24 | RK-00104 2 | N/A | N/A | Jun. 19, 2019 | N/A | Radiation (03CH11-HY) |
| Amplifier | SONOMA | 310N | 187312 | 9kHz~1GHz | Dec. 04, 2018 | Jun. 19, 2019 | Dec. 03, 2019 | Radiation (03CH11-HY) |
| Bilog Antenna | TESEQ | CBL 6111D&N-6-0 6 | 35414&AT- N0602 | 30MHz~1GHz | Oct. 13, 2018 | Jun. 19, 2019 | Oct. 12, 2019 | Radiation (03CH11-HY) |
| Spectrum Analyzer | Keysight | N9010A | MY542004 86 | 10Hz ~ 44GHz | Oct. 19, 2018 | Jun. 19, 2019 | Oct. 18, 2019 | Radiation (03CH11-HY) |
| Antenna Mast | EMEC | AM-BS-4500- B | N/A | 1~4m | N/A | Jun. 19, 2019 | N/A | Radiation (03CH11-HY) |
| Turn Table | EMEC | TT 2000 | N/A | 0~360 Degree | N/A | Jun. 19, 2019 | N/A | Radiation (03CH11-HY) |
| EMI Test Receiver | Keysight | N9038A(MXE) | MY532900 45 | N/A | Jan. 19, 2019 | Jun. 19, 2019 | Jan. 18, 2020 | Radiation (03CH11-HY) |
| Filter | Wainwright | WHK20/1000 C7/40SS | SN2 | 20M High Pass | Sep. 16, 2018 | Jun. 19, 2019 | Sep. 15, 2019 | Radiation (03CH11-HY) |
| RF Cable | HUBER + SUHNER | SUCOFLEX 104 | MY9837/4 PE | 9kHz-30MHz | Mar. 14, 2018 | Jun. 19, 2019 | Mar. 12, 2020 | Radiation (03CH11-HY) |
| RF Cable | HUBER + SUHNER | SUCOFLEX 104 | MY9837/4 PE | 30M-18G | Mar. 14, 2018 | Jun. 19, 2019 | Mar. 12, 2020 | Radiation (03CH11-HY) |
| RF Cable | HUBER + SUHNER | SUCOFLEX 102 | MY2859/2 | 30MHz-40GHz | Mar. 14, 2018 | Jun. 19, 2019 | Mar. 12, 2020 | Radiation (03CH11-HY) |
| Loop Antenna | Rohde & Schwarz | HFH2-Z2 | 100488 | 9 kHz~30 MHz | Jan. 07, 2019 | Jun. 19, 2019 | Jan. 06, 2020 | Radiation (03CH11-HY) |
| AC Power Source | AC POWER | AFC-500W | F10407001 1 | 50Hz~60Hz | Apr. 12, 2019 | Jun. 25 , 2019 | Apr. 11, 2020 | Conducted (TH03-HY) |
| Spectrum Analyzer | Rohde & Schwarz | FSP30 | 101329 | 9kHz~30GHz | Jun. 29, 2018 | Jun. 25 , 2019 | Jun. 28, 2019 | Conducted (TH03-HY) |
| Temperature Chamber | ESPEC | SU-641 | 92013721 | -30°C ~70°C | Nov. 28, 2018 | Jun. 25 , 2019 | Nov. 27, 2019 | Conducted (TH03-HY) |



5. Uncertainty of Evaluation

Uncertainty of Radiated Emission Measurement (9 kHz ~ 30 MHz)

| | |
|---|------|
| Measuring Uncertainty for a Level of Confidence of 95% ($U = 2Uc(y)$) | 3.45 |
|---|------|

Uncertainty of Radiated Emission Measurement (30 MHz ~ 1000 MHz)

| | |
|---|------|
| Measuring Uncertainty for a Level of Confidence of 95% ($U = 2Uc(y)$) | 5.20 |
|---|------|



Appendix A. Test Results of Conducted Test Items

A1. Test Result of 20dB Spectrum Bandwidth

| Test mode | NFC Tx | Test Frequency (MHz) | 13.56 |
|------------------------------|----------------|----------------------------|--------------------|
| | | | |
| Date: 25.JUN.2019 12:01:11 | | Date: 25.JUN.2019 12:01:27 | |
| 20dB Bandwidth (kHz) | 2.640 | 99% OccupiedBW(kHz) | 2.240 |
| Frequency range (MHz) | $f_L > 13.553$ | 13.55902 | Test Result |
| | $f_H < 13.567$ | 13.56166 | Complies |

Remark: Because the measured signal is CW adjusting the RBW per C63.10 would not be practical since measured bandwidth will always follow the RBW and the result will be approximately twice the RBW.



A2. Test Result of Frequency Stability

| A3. Voltage vs. Frequency Stability | | Temperature vs. Frequency Stability | | |
|-------------------------------------|-----------------------------|-------------------------------------|------|-----------------------------|
| Voltage (Vac) | Measurement Frequency (MHz) | Temperature (°C) | Time | Measurement Frequency (MHz) |
| 120 | 13.560320 | -20 | 0 | 13.560340 |
| | | | 2 | 13.560340 |
| | | | 5 | 13.560340 |
| | | | 10 | 13.560340 |
| 102 | 13.560330 | -10 | 0 | 13.560340 |
| | | | 2 | 13.560340 |
| | | | 5 | 13.560340 |
| | | | 10 | 13.560340 |
| 138 | 13.560330 | 0 | 0 | 13.560340 |
| | | | 2 | 13.560340 |
| | | | 5 | 13.560340 |
| | | | 10 | 13.560340 |
| | | 10 | 0 | 13.560340 |
| | | | 2 | 13.560340 |
| | | | 5 | 13.560340 |
| | | | 10 | 13.560340 |
| | | 20 | 0 | 13.560340 |
| | | | 2 | 13.560340 |
| | | | 5 | 13.560340 |
| | | | 10 | 13.560340 |
| | | 30 | 0 | 13.560340 |
| | | | 2 | 13.560340 |
| | | | 5 | 13.560340 |
| | | | 10 | 13.560340 |
| | | 40 | 0 | 13.560340 |
| | | | 2 | 13.560340 |
| | | | 5 | 13.560340 |
| | | | 10 | 13.560340 |



| Voltage vs. Frequency Stability | | Temperature vs. Frequency Stability | | |
|---------------------------------|-----------------------------|-------------------------------------|------|-----------------------------|
| Voltage (Vac) | Measurement Frequency (MHz) | Temperature (°C) | Time | Measurement Frequency (MHz) |
| | | 50 | 0 | 13.560340 |
| | | | 2 | 13.560340 |
| | | | 5 | 13.560340 |
| | | | 10 | 13.560330 |
| Max.Deviation (MHz) | 0.000330 | Max.Deviation (MHz) | | 0.000340 |
| Max.Deviation (ppm) | 24.3363 | Max.Deviation (ppm) | | 25.0737 |
| Limit | FS < ±100 ppm | Limit | | FS < ±100 ppm |
| Test Result | PASS | Test Result | | PASS |



Appendix B. Test Results of Radiated Test Items

B1. Test Result of Field Strength of Fundamental Emissions

| Test Mode : | NFC Tx | Test Frequency (MHz) | 13.56 | | | | | | |
|-------------|--------------------------------------|----------------------|-------------|--------|--------|-------|--------|-----|--------|
| | | | | | | | | | |
| Site | : 03CH11-HY | | | | | | | | |
| Condition | : 15.225 3m LOOP_ANT(H) HORIZONTAL | | | | | | | | |
| | : RBW:9.000KHz VBW:9.000KHz SWT:Auto | | | | | | | | |
| Project | : 960640 | | | | | | | | |
| | Over | Limit | ReadAntenna | Cable | A/Pos | T/Pos | Remark | | |
| | Freq | Level | Line | Level | Factor | Loss | | | |
| | MHz | dBuV/m | dB | dBuV/m | dBuV | dB/m | dB | cm | deg |
| 1 | 13.56 | 21.77 | -62.23 | 84.00 | 40.45 | 21.18 | 0.14 | 100 | 0 QP |
| | | | | | | | | | |
| Site | : 03CH11-HY | | | | | | | | |
| Condition | : 15.225 3m LOOP_ANT(V) VERTICAL | | | | | | | | |
| | : RBW:9.000KHz VBW:9.000KHz SWT:Auto | | | | | | | | |
| Project | : 960640 | | | | | | | | |
| | Over | Limit | ReadAntenna | Cable | A/Pos | T/Pos | Remark | | |
| | Freq | Level | Line | Level | Factor | Loss | | | |
| | MHz | dBuV/m | dB | dBuV/m | dBuV | dB/m | dB | cm | deg |
| 1 | 13.56 | 18.12 | -65.88 | 84.00 | 36.80 | 21.18 | 0.14 | 100 | 279 QP |



B2. Results of Radiated Spurious Emissions (9 kHz~30MHz)

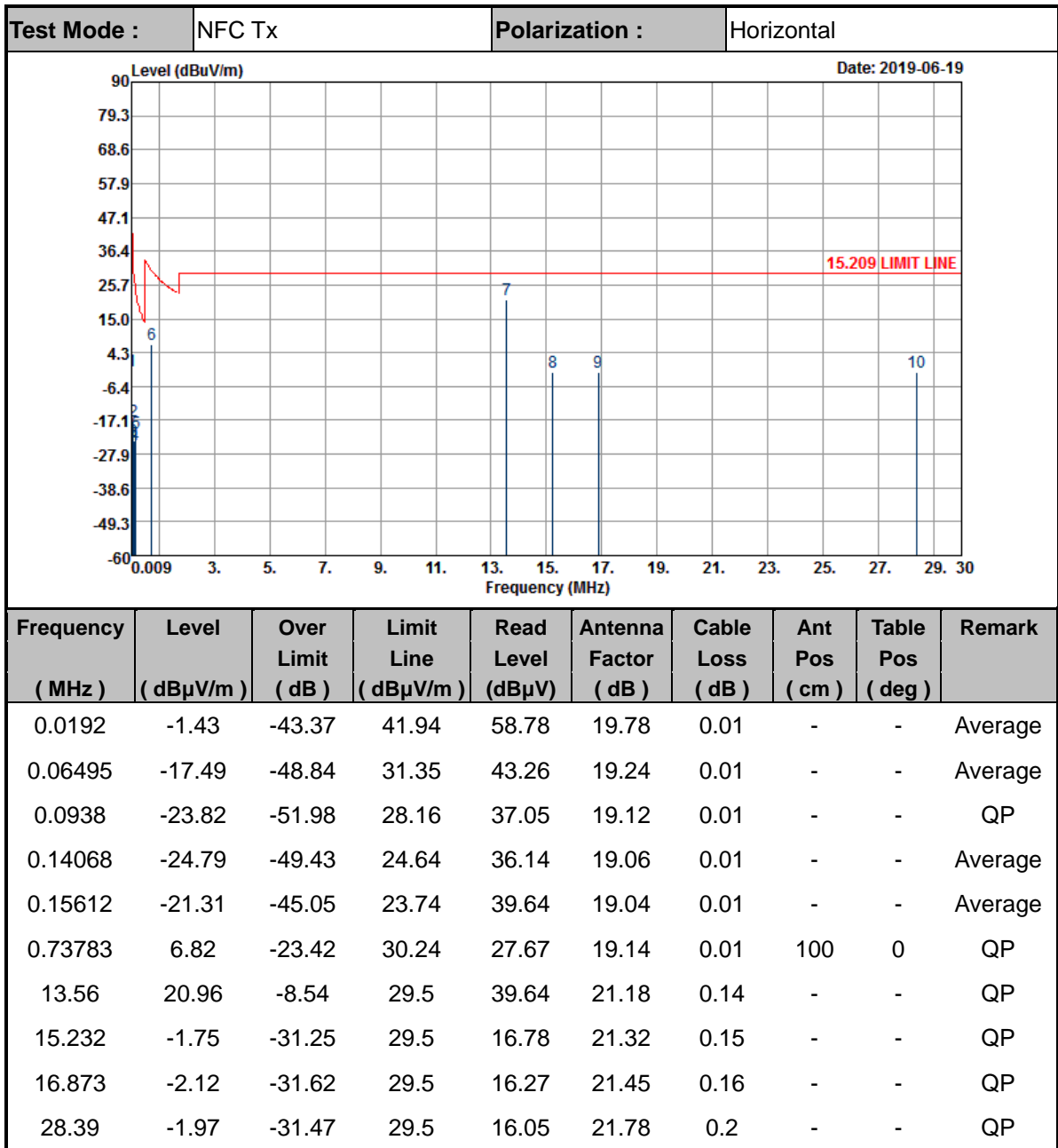

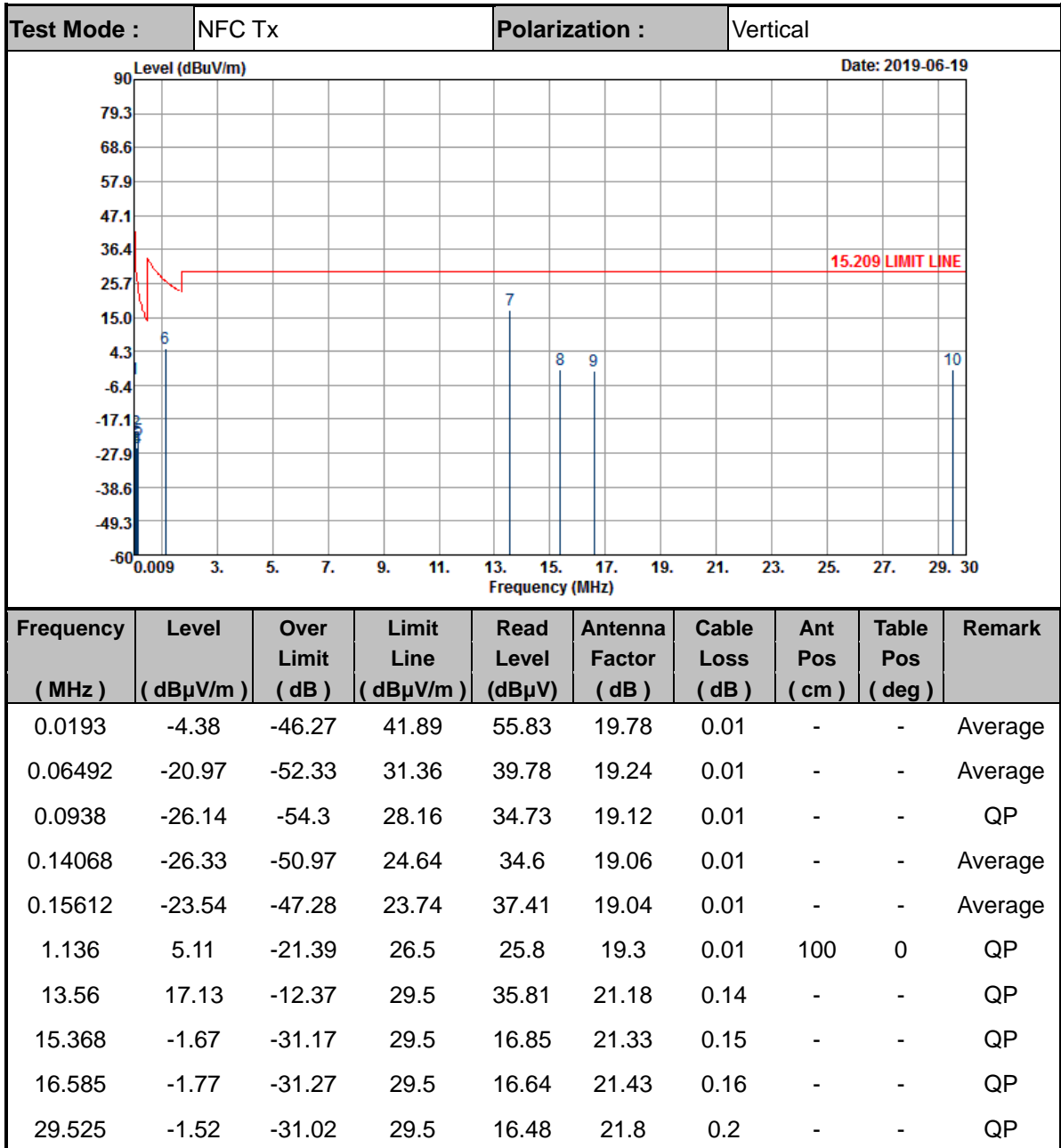

Note:

1. 13.56 MHz is fundamental signal which can be ignored.
2. The amplitude of spurious emissions which are attenuated by more than 20dB below the permissible value has no need to be reported.
3. Distance extrapolation factor = 40 log (specific distance / test distance) (dB);
4. Limit line = specific limits (dBuV) + distance extrapolation factor.



B3. Results of Radiated Spurious Emissions (30MHz~1GHz)

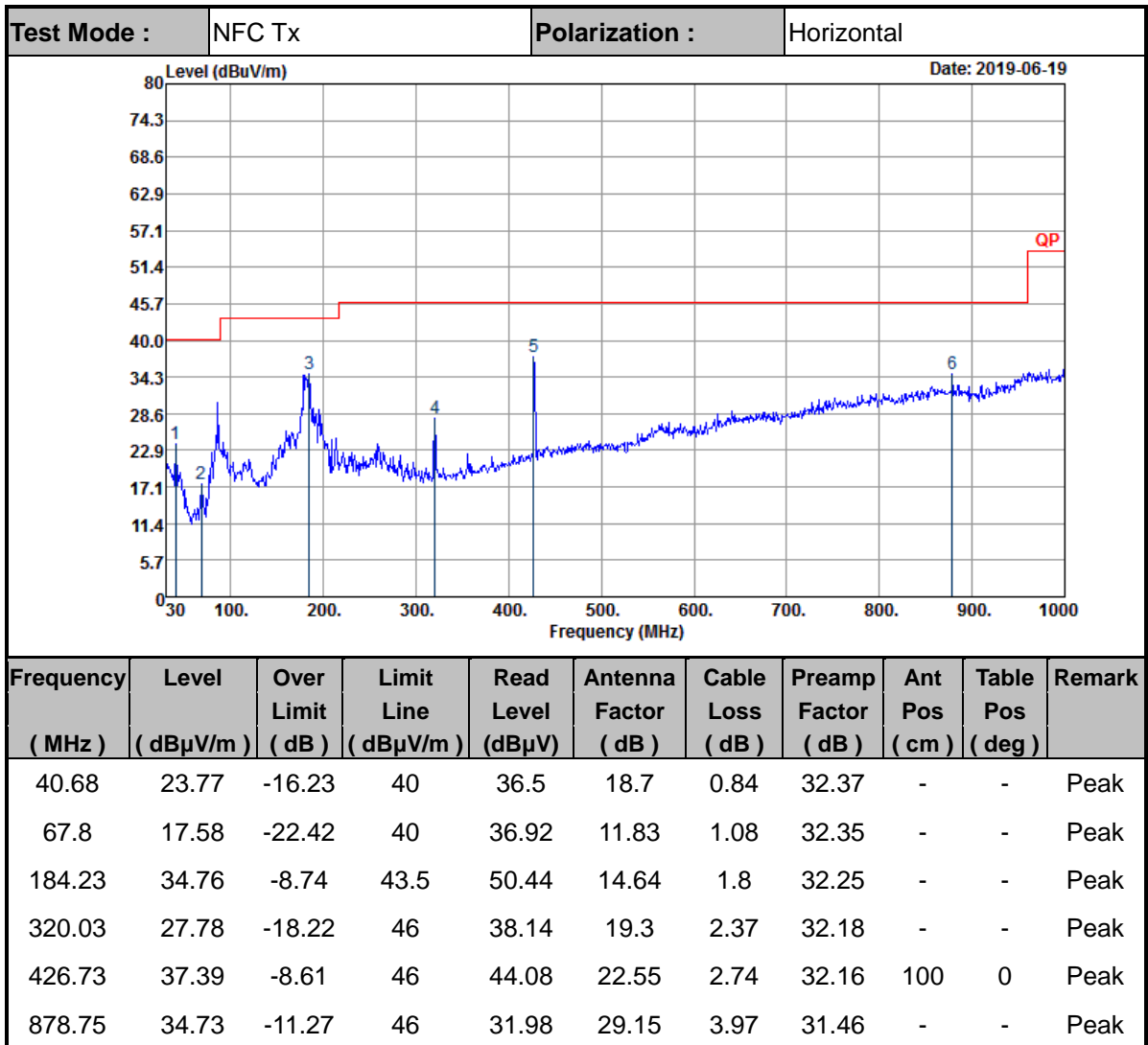

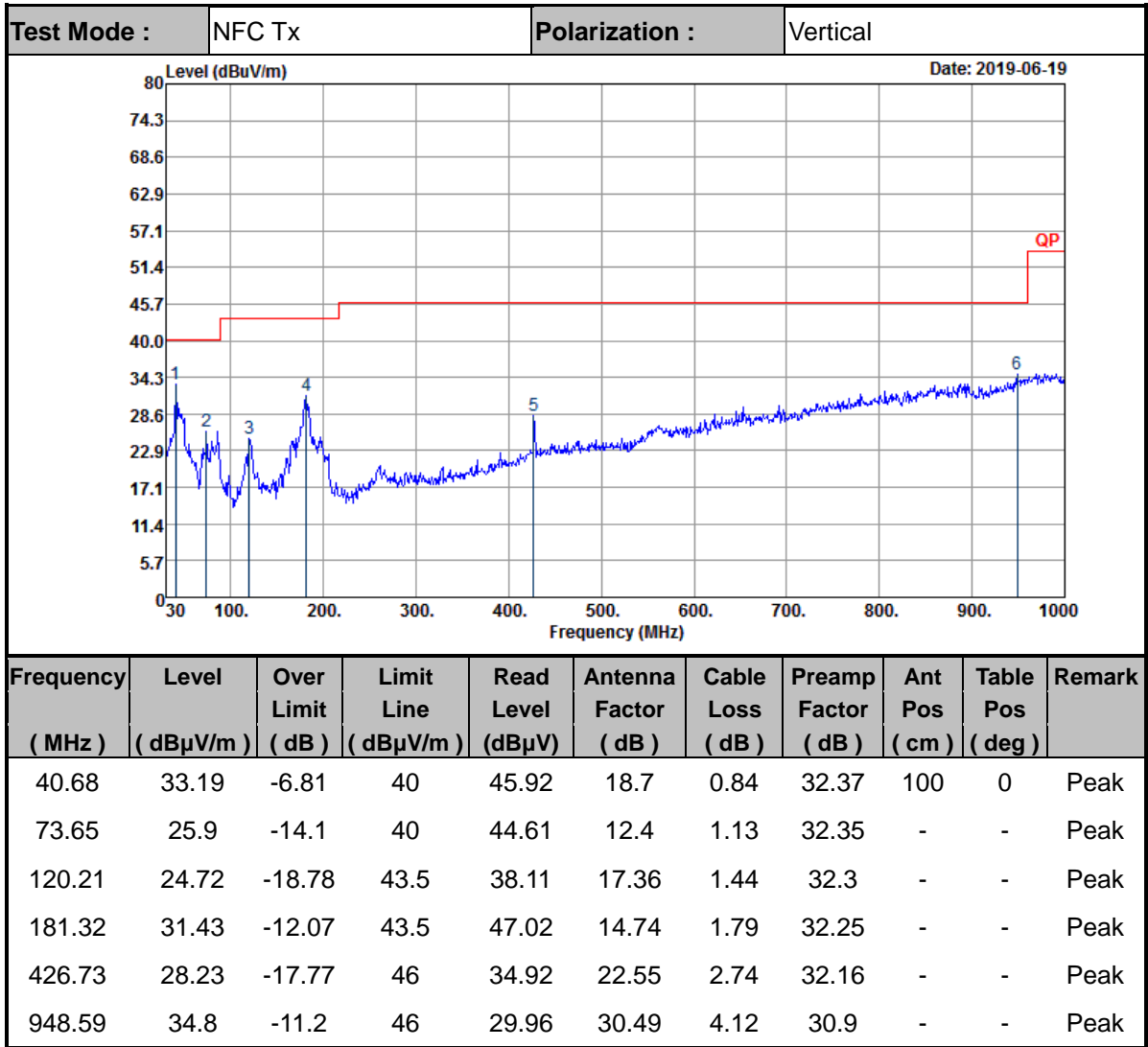

Note:

1. The amplitude of spurious emissions which are attenuated by more than 20dB below the permissible value has no need to be reported.
2. Emission level (dBμV/m) = 20 log Emission level (μV/m).
3. Corrected Reading: Antenna Factor + Cable Loss + Read Level - Preamp Factor= Level.



Appendix D. Original Report

Please refer to Sporton report number FR910212D as below.



FCC RADIO TEST REPORT

FCC ID : 2ABVH-INARI10B1
Equipment : Tablet
Brand Name : AAVA
Model Name : INARI10B-WIG-1
Applicant : Aava Mobile Oy
NAHKATEHTAANKATU 2 90130 OULU FINLAND
Manufacturer : Aava Mobile Oy
NAHKATEHTAANKATU 2 90130 OULU FINLAND
Standard : FCC Part 15 Subpart C §15.225

The product was received on Dec. 24, 2018 and testing was started from Jan. 14, 2019 and completed on Jan. 18, 2019. We, SPORTON INTERNATIONAL INC. EMC & Wireless Communications Laboratory, would like to declare that the tested sample has been evaluated in accordance with the test procedures and has been in compliance with the applicable technical standards.

The report must not be used by the client to claim product certification, approval, or endorsement by TAF or any agency of government.

The test results in this report apply exclusively to the tested model / sample. Without written approval of SPORTON INTERNATIONAL INC. EMC & Wireless Communications Laboratory, the test report shall not be reproduced except in full.

Approved by: Jones Tsai

SPORTON INTERNATIONAL INC. EMC & Wireless Communications Laboratory
No. 52, Huaya 1st Rd., Guishan Dist., Taoyuan City, Taiwan (R.O.C.)



Table of Contents

| | |
|---|-----------|
| History of this test report..... | 3 |
| Summary of Test Result..... | 4 |
| 1. General Description | 5 |
| 1.1 Product Feature of Equipment Under Test | 5 |
| 1.2 Product Specification of Equipment Under Test | 5 |
| 1.3 Modification of EUT | 5 |
| 1.4 Testing Location | 6 |
| 1.5 Applicable Standards..... | 6 |
| 2. Test Configuration of Equipment Under Test..... | 7 |
| 2.1 Descriptions of Test Mode | 7 |
| 2.2 Connection Diagram of Test System | 8 |
| 2.3 Table for Supporting Units | 9 |
| 2.4 EUT Operation Test Setup | 9 |
| 3. Test Results | 10 |
| 3.1 AC Power Line Conducted Emissions Measurement | 10 |
| 3.2 20dB and 99% OBW Spectrum Bandwidth Measurement..... | 12 |
| 3.3 Frequency Stability Measurement | 13 |
| 3.4 Field Strength of Fundamental Emissions and Mask Measurement..... | 14 |
| 3.5 Radiated Emissions Measurement | 16 |
| 3.6 Antenna Requirements..... | 19 |
| 4. List of Measuring Equipment | 20 |
| 5. Uncertainty of Evaluation | 21 |
| Appendix A. Test Results of Conducted Emission Test | |
| Appendix B. Test Results of Conducted Test Items | |
| B1. Test Result of 20dB Spectrum Bandwidth | |
| B2. Test Result of Frequency Stability | |
| Appendix C. Test Results of Radiated Test Items | |
| C1. Test Result of Field Strength of Fundamental Emissions | |
| C2. Results of Radiated Emissions (9 kHz~30MHz) | |
| C3. Results of Radiated Emissions (30MHz~1GHz) | |
| Appendix D. Setup Photographs | |



History of this test report

| Report No. | Version | Description | Issued Date |
|------------|---------|-------------------------|---------------|
| FR910212D | 01 | Initial issue of report | Feb. 26, 2019 |
| | | | |
| | | | |
| | | | |
| | | | |
| | | | |
| | | | |
| | | | |
| | | | |
| | | | |
| | | | |
| | | | |
| | | | |
| | | | |
| | | | |
| | | | |



Summary of Test Result

| Report Clause | Ref Std. Clause | Test Items | Result (PASS/FAIL) | Remark |
|---------------|---------------------|---|--------------------|---|
| 3.1 | 15.207 | AC Power Line Conducted Emissions | Pass | Under limit 8.65 dB at 13.560MHz |
| 3.2 | 15.215(c) | 20dB Spectrum Bandwidth | Pass | - |
| | 2.1049 | 99% OBW Spectrum Bandwidth | Reporting only | - |
| 3.3 | 15.225(e) | Frequency Stability | Pass | - |
| 3.4 | 15.225(a)(b)(c) | Field Strength of Fundamental Emissions | Pass | Max level 62.950 dB μ V/m at 13.560 MHz |
| 3.5 | 15.225(d) 15.209 | Radiated Spurious Emissions | Pass | Under limit 3.26 dB at 184.440MHz |
| 3.6 | 15.203 | Antenna Requirements | Pass | - |

Declaration of Conformity:

The test results with all measurement uncertainty excluded are presented in accordance with the regulation limits or requirements declared by manufacturers.

Comments and Explanations:

The declared of product specification for EUT presented in the report are provided by the manufacturer, and the manufacturer takes all the responsibilities for the accuracy of product specification.

Reviewed by: Wii Chang

Report Producer: Yimin Ho



1. General Description

1.1 Product Feature of Equipment Under Test

| Product Feature | |
|---------------------------------|--|
| Equipment | Tablet |
| Brand Name | AAVA |
| Model Name | INARI10B-WIG-1 |
| FCC ID | 2ABVH-INARI10B1 |
| EUT supports Radios application | NFC/GNSS WLAN 11a/b/g/n HT20/HT40 WLAN 11ac VHT20/VHT40/VHT80 Bluetooth BR/EDR/LE |
| HW Version | DV1 |
| SW Version | Windows 10 |
| EUT Stage | Identical Prototype |

Remark: The above EUT's information was declared by manufacturer.

| Specification of Accessories | | | | |
|------------------------------|------------|---------------|------------|----------------|
| AC Adapter | Brand Name | PHIHONG | Model Name | AQ18A-59CFA |
| Battery | Brand Name | Etica Battery | Model Name | AMME3950 |
| USB Cable | Brand Name | PHIHONG | Model Name | UES-1001A160-R |

1.2 Product Specification of Equipment Under Test

| Standards-related Product Specification | |
|---|-----------------------------|
| Tx/Rx Frequency Range | 13.553 ~ 13.567MHz |
| Channel Number | 1 |
| 20dBW | 2.62 KHz |
| 99%OBW | 2.24 KHz |
| Antenna Type | Ferrite-backed Loop Antenna |
| Type of Modulation | ASK |

Remark: The above EUT's information was declared by manufacturer.

1.3 Modification of EUT

No modifications are made to the EUT during all test items.



1.4 Testing Location

| | | |
|---------------------------|---|----------|
| Test Site | SPORTON INTERNATIONAL INC. | |
| Test Site Location | No.52, Huaya 1st Rd., Guishan Dist., Taoyuan City, Taiwan (R.O.C.) TEL: +886-3-327-3456 FAX: +886-3-328-4978 | |
| Test Site No. | Sporton Site No. | |
| | TH03-HY | CO05-HY |
| Test Engineer | George Chen | Rick Lin |
| Temperature | 22~24°C | 23~24°C |
| Relative Humidity | 53~55% | 55~56% |

Note: The test site complies with ANSI C63.4 2014 requirement.

| | | |
|---------------------------|---|--|
| Test Site | SPORTON INTERNATIONAL INC. | |
| Test Site Location | No.58, Aly. 75, Ln. 564, Wenhua 3rd, Rd., Guishan Dist., Taoyuan City, Taiwan (R.O.C.) TEL: +886-3-327-0868 FAX: +886-3-327-0855 | |
| Test Site No. | Sporton Site No. | |
| | 03CH11-HY | |
| Test Engineer | Hao Hsu and Chuan Zhu | |
| Temperature | 21~25°C | |
| Relative Humidity | 52~57% | |

Note: The test site complies with ANSI C63.4 2014 requirement.

FCC Designation No. TW1190 and TW0007

1.5 Applicable Standards

According to the specifications of the manufacturer, the EUT must comply with the requirements of the following standards:

- ♦ FCC Part 15 Subpart C §15.225
- ♦ FCC KDB 414788 D01 Radiated Test Site v01r01
- ♦ ANSI C63.10-2013



2. Test Configuration of Equipment Under Test

2.1 Descriptions of Test Mode

Investigation has been done on all the possible configurations.

The following table is a list of the test modes shown in this test report.

| Test Items | |
|-----------------------------------|---|
| AC Power Line Conducted Emissions | Field Strength of Fundamental Emissions |
| 20dB Spectrum Bandwidth | Frequency Stability |
| Radiated Emissions 9kHz~30MHz | Radiated Emissions 30MHz~1GHz |

The EUT pre-scanned in four NFC type, A, B, F, V. The worst type (type F) was recorded in this report. Pre-scanned tests, X, Y, Z in three orthogonal panels to determine the final configuration (Z plane as worst plane) from all possible combinations.

| Test Cases | |
|------------------------------|--|
| AC Conducted Emission | Mode 1: WLAN (2.4GHz) Link + Bluetooth Link + USB Cable (Type C) + Adapter + GPS Rx + NFC Tx |

2.2 Connection Diagram of Test System

<Radiated Emission Mode>

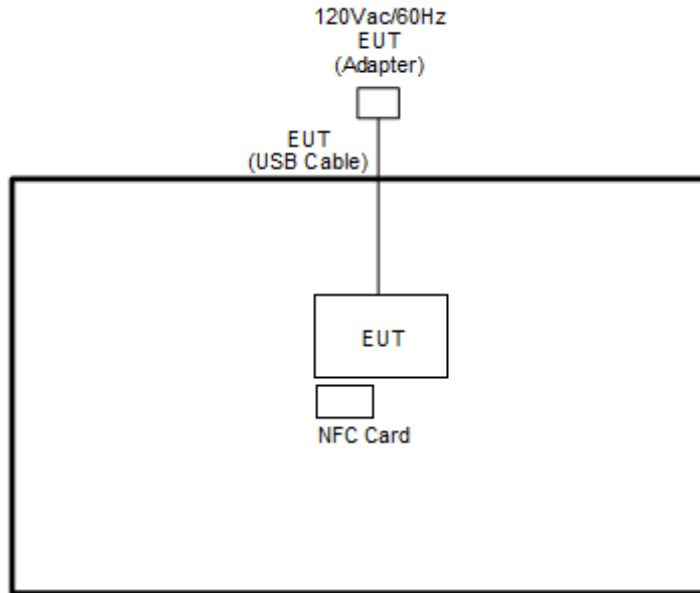

<AC Conducted Emission Mode>

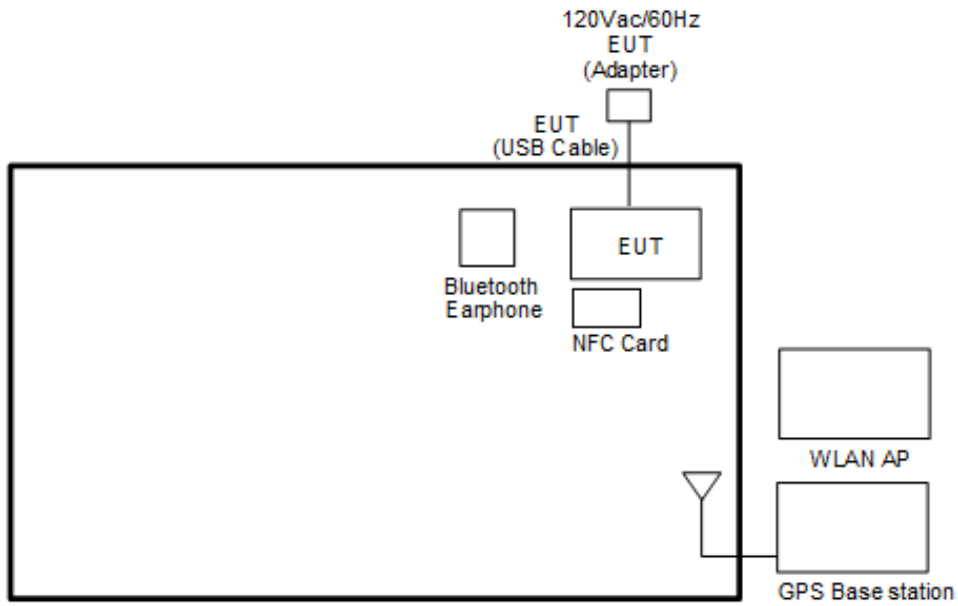



2.3 Table for Supporting Units

| Item | Equipment | Trade Name | Model Name | FCC ID | Data Cable | Power Cord |
|------|--------------------|---------------|------------|-------------|------------|-------------------|
| 1. | GPS Station | Pendulum | GSG-54 | N/A | N/A | Unshielded, 1.8 m |
| 2. | WLAN AP | ASUS | RT-AC66U | MSQ-RTAC66U | N/A | Unshielded, 1.8 m |
| 3. | Bluetooth Earphone | Sony Ericsson | MW600 | PY7DDA-2029 | N/A | N/A |
| 4. | SD Card | SanDisk | MicroSD HC | FCC DoC | N/A | N/A |
| 5. | NFC Card | Metro Taipei | Easy Card | N/A | N/A | N/A |

2.4 EUT Operation Test Setup

The EUT was programmed to be in continuously transmitting mode.

The ancillary equipment, NFC card, is used to make the EUT (NFC) continuously transmit at 13.56MHz and is placed around 1 cm gap to the EUT.



3. Test Results

3.1 AC Power Line Conducted Emissions Measurement

3.1.1 Limit of AC Conducted Emission

For equipment that is designed to be connected to the public utility (AC) power line, the radio frequency voltage that is conducted back onto the AC power line on any frequency or frequencies within the band 150 kHz to 30 MHz shall not exceed the limits in the following table.

| Frequency of Emission (MHz) | Conducted Limit (dB μ V) | |
|--------------------------------|------------------------------|-----------|
| | Quasi-Peak | Average |
| 0.15-0.5 | 66 to 56* | 56 to 46* |
| 0.5-5 | 56 | 46 |
| 5-30 | 60 | 50 |

*Decreases with the logarithm of the frequency.

3.1.2 Measuring Instruments

See list of measuring equipment of this test report.

3.1.3 Test Procedures

1. The EUT was placed 0.4 meter from the conducting wall of the shielding room, and it was kept at least 80 centimeters from any other grounded conducting surface.
2. Connect EUT to the power mains through a line impedance stabilization network (LISN).
3. All the support units are connecting to the other LISN.
4. The LISN provides 50 ohm coupling impedance for the measuring instrument.
5. The FCC states that a 50 ohm, 50 microhenry LISN should be used.
6. Both sides of AC line were checked for maximum conducted interference.
7. The frequency range from 150 kHz to 30 MHz was searched.
8. Set the test-receiver system to Peak Detect Function and specified bandwidth (IF Bandwidth = 9kHz) with Maximum Hold Mode. Then measurement is also conducted by Average Detector and Quasi-Peak Detector Function respectively.

3.1.4 Test setup

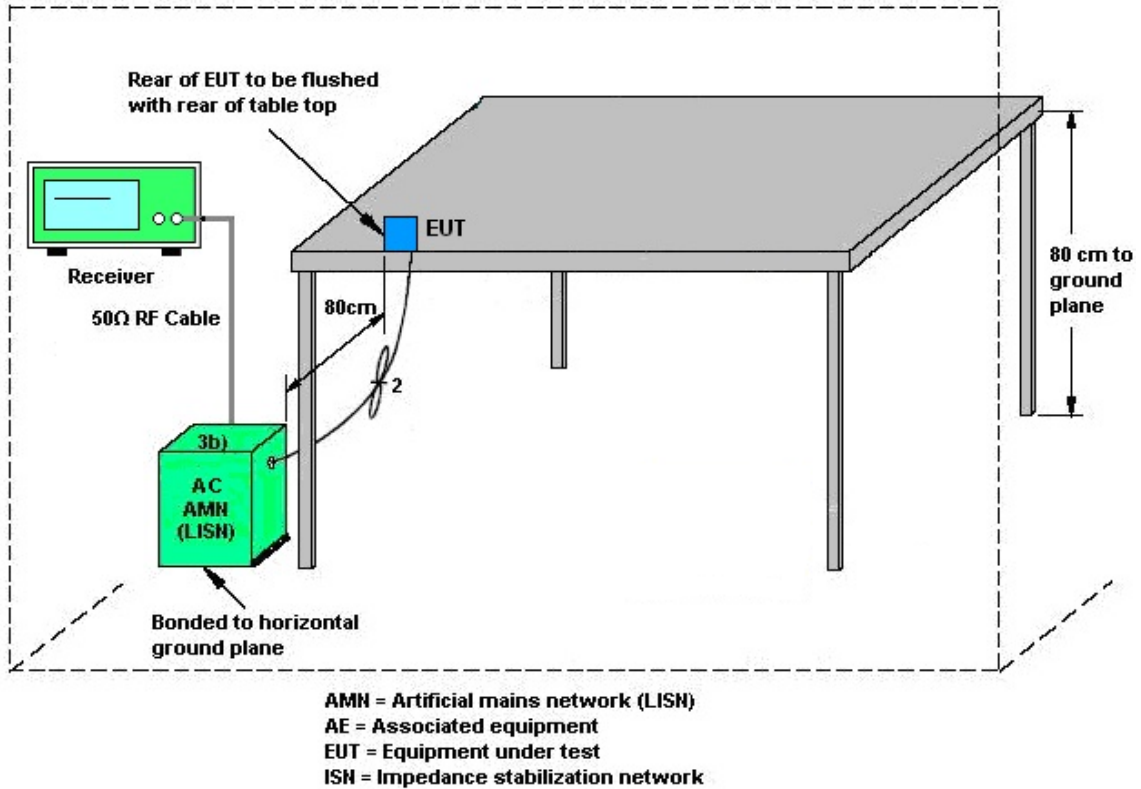

3.1.5 Test Result of AC Conducted Emission

Please refer to Appendix A.

3.2 20dB and 99% OBW Spectrum Bandwidth Measurement

3.2.1 Limit

Intentional radiators must be designed to ensure that the 20dB and 99% emission bandwidth in the specific band 13.553~13.567MHz.

3.2.2 Measuring Instruments

See list of measuring instruments of this test report.

3.2.3 Test Procedures

1. The spectrum analyzer connected via a receive antenna placed near the EUT in peak Max hold mode.
2. The resolution bandwidth of 1 kHz and the video bandwidth of 3 kHz were used.
3. Measured the spectrum width with power higher than 20dB below carrier.
4. Measured the 99% OBW.

3.2.4 Test Setup

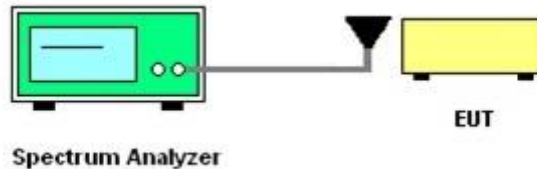

3.2.5 Test Result of Conducted Test Items

Please refer to Appendix B.

3.3 Frequency Stability Measurement

3.3.1 Limit

The frequency tolerance of the carrier signal shall be maintained within +/- 0.01% (100ppm) of the operating frequency over a temperature variation of -20 degrees to +50 degrees C at normal supply voltage, and for a variation in the primary supply voltage from 85% to 115% of the rated supply voltage at a temperature of 20 degrees C. For battery operated equipment, the equipment tests shall be performed using a new battery.

3.3.2 Measuring Instruments

See list of measuring instruments of this test report.

3.3.3 Test Procedures

1. The spectrum analyzer connected via a receive antenna placed near the EUT.
2. EUT have transmitted signal and fixed channelize.
3. Set the spectrum analyzer span to view the entire emissions bandwidth.
4. Set RBW = 1 kHz, VBW = 3 kHz with peak detector and maxhold settings.
5. The f_c is declaring of channel frequency. Then the frequency error formula is $(f_c - f) / f_c \times 10^6$ ppm and the limit is less than ± 100 ppm.
6. Extreme temperature rule is -20°C~50°C.

3.3.4 Test Setup

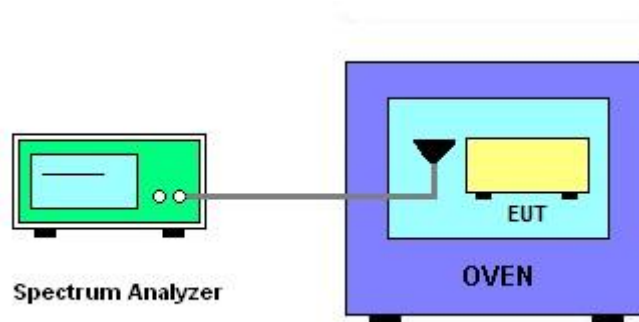

3.3.5 Test Result of Conducted Test Items

Please refer to Appendix B.



3.4 Field Strength of Fundamental Emissions and Mask Measurement

3.4.1 Limit

| Rules and specifications | FCC CFR 47 Part 15 section 15.225 | | | |
|--------------------------|---|--|--|---|
| Description | Compliance with the spectrum mask is tested with RBW set to 9kHz. | | | |
| Freq. of Emission (MHz) | Field Strength ($\mu\text{V/m}$) at 30m | Field Strength ($\text{dB}\mu\text{V/m}$) at 30m | Field Strength ($\text{dB}\mu\text{V/m}$) at 10m | Field Strength ($\text{dB}\mu\text{V/m}$) at 3m |
| 1.705~13.110 | 30 | 29.5 | 48.58 | 69.5 |
| 13.110~13.410 | 106 | 40.5 | 59.58 | 80.5 |
| 13.410~13.553 | 334 | 50.5 | 69.58 | 90.5 |
| 13.553~13.567 | 15848 | 84.0 | 103.08 | 124.0 |
| 13.567~13.710 | 334 | 50.5 | 69.58 | 90.5 |
| 13.710~14.010 | 106 | 40.5 | 59.58 | 80.5 |
| 14.010~30.000 | 30 | 29.5 | 48.58 | 69.5 |

3.4.2 Measuring Instruments

See list of measuring instruments of this test report.

3.4.3 Test Procedures

1. Configure the EUT according to ANSI C63.10. The EUT was placed on the top of the turntable 0.8 meter above ground. The phase center of the loop receiving antenna mounted antenna tower was placed 3 meters far away from the turntable.
2. Power on the EUT and all the supporting units. The turntable was rotated by 360 degrees to determine the position of the highest radiation.
3. The height of the receiving antenna was fixed at one meter above ground to find the maximum emissions field strength.
4. For Fundamental emissions, use the receiver to measure QP reading.
5. When the radiated emissions limits are expressed in terms of the average value of the emissions, and pulsed operation is employed, the measurement field strength shall be determined by averaging over one complete pulse train, including blanking intervals, as long as the pulse train does not exceed 0.1 seconds. As an alternative (provided the transmitter operates for longer than 0.1 seconds) or in cases where the pulse train exceeds 0.1 seconds, the measured field strength shall be determined from the average absolute voltage during a 0.1 second interval during which the field strength is at its maximum value.
6. Compliance with the spectrum mask is tested with RBW set to 9kHz.

Note: Emission level (dB μ V/m) = 20 log Emission level (μ V/m).

3.4.4 Test Setup

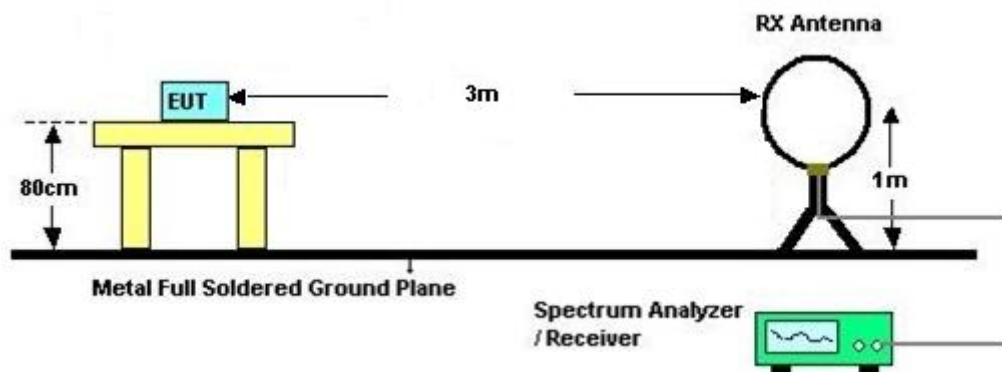

3.4.5 Test Result of Field Strength of Fundamental Emissions and Mask

Please refer to Appendix C.



3.5 Radiated Emissions Measurement

3.5.1 Limit

The field strength of any emissions which appear outside of 13.110 ~14.010MHz band shall not exceed the general radiated emissions limits.

| Frequencies (MHz) | Field Strength (µV/m) | Measurement Distance (meters) |
|-------------------|-----------------------|-------------------------------|
| 0.009~0.490 | 2400/F(kHz) | 300 |
| 0.490~1.705 | 24000/F(kHz) | 30 |
| 1.705~30.0 | 30 | 30 |
| 30~88 | 100 | 3 |
| 88~216 | 150 | 3 |
| 216~960 | 200 | 3 |
| Above 960 | 500 | 3 |

3.5.2 Measuring Instruments

See list of measuring instruments of this test report.

3.5.3 Measuring Instrument Setting

The following table is the setting of receiver:

| Receiver Parameter | Setting |
|--------------------------------|---------------------|
| Attenuation | Auto |
| Frequency Range: 9kHz~150kHz | RBW 200Hz for QP |
| Frequency Range: 150kHz~30MHz | RBW 9kHz for QP |
| Frequency Range: 30MHz~1000MHz | RBW 120kHz for Peak |

Note: The emission limits shown in the above table are based on measurements employing a CISPR quasi-peak detector except for the frequency bands 9-90 kHz and 110-490 kHz. Radiated emission limits in these two bands are based on measurements employing an average detector.



3.5.4 Test Procedures

1. Configure the EUT according to ANSI C63.10. The EUT was placed on the top of the turntable 0.8 meter above ground. The phase center of the receiving antenna mounted on the top of a height-variable antenna tower was placed 3 meters far away from the turntable.
2. Power on the EUT and all the supporting units. The turntable was rotated by 360 degrees to determine the position of the highest radiation.
3. The height of the broadband receiving antenna was varied between one meter and four meters above ground to find the maximum emissions field strength of both horizontal and vertical polarization.
4. For each suspected emissions, the antenna tower was scan (from 1 M to 4 M) and then the turntable was rotated (from 0 degree to 360 degrees) to find the maximum reading.
5. Set the test-receiver system to Peak or CISPR quasi-peak Detect Function with specified bandwidth under Maximum Hold Mode.
6. When the radiated emissions limits are expressed in terms of the average value of the emissions, and pulsed operation is employed, the measurement field strength shall be determined by averaging over one complete pulse train, including blanking intervals, as long as the pulse train does not exceed 0.1 seconds. As an alternative (provided the transmitter operates for longer than 0.1 seconds) or in cases where the pulse train exceeds 0.1 seconds, the measured field strength shall be determined from the average absolute voltage during a 0.1 second interval during which the field strength is at its maximum value.
7. In case the emission is lower than 30MHz, loop antenna has to be used for measurement and the recorded data should be QP measured by receiver.

3.5.5 Test Setup

For radiated emissions below 30MHz

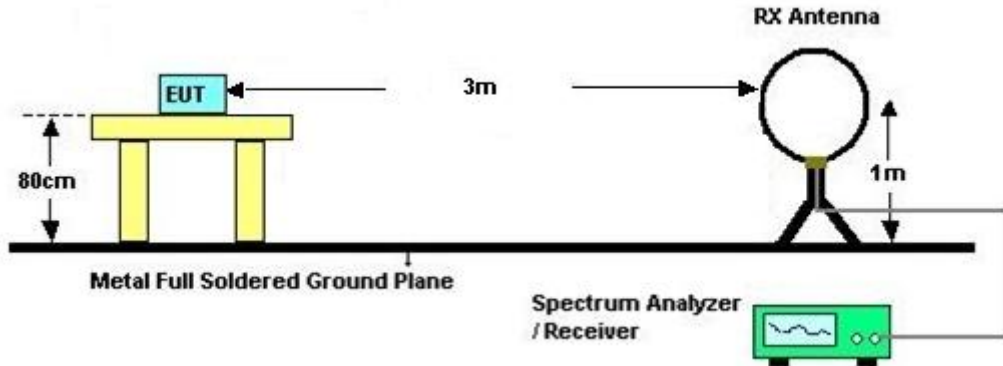

For radiated emissions above 30MHz

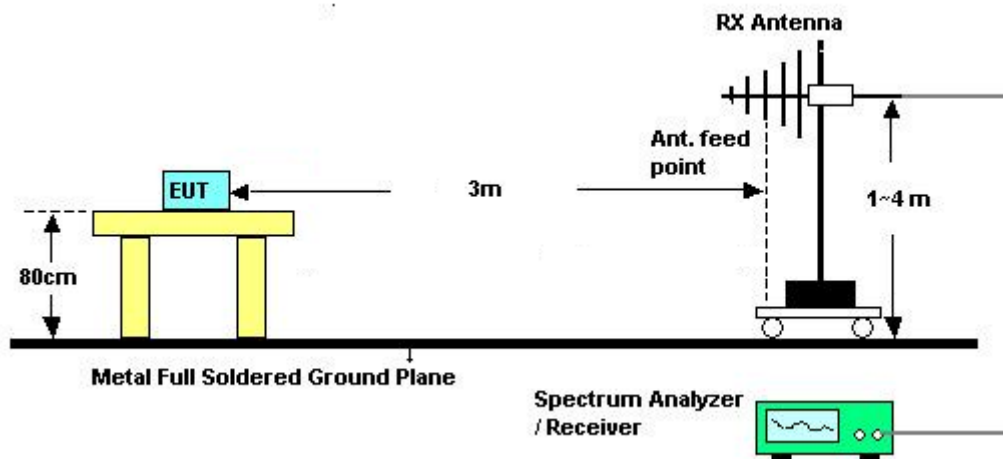

3.5.6 Test Result of Radiated Emissions Measurement

Please refer to Appendix C.

Remark: There is a comparison data of both open-field test site and alternative test site - semi-Anechoic chamber according to 414788 D01 Radiated Test Site v01r01, and the result came out very similar.



3.6 Antenna Requirements

3.6.1 Standard Applicable

Except for special regulations, the Low-power Radio-frequency Devices must not be equipped with any jacket for installing an antenna with extension cable. An intentional radiator shall be designed to ensure that no antenna other than that furnished by the responsible party shall be used with the device. The use of a permanently attached antenna or of an antenna that uses a unique coupling to the intentional radiator shall be considered sufficient to comply with the provisions of this Section. The manufacturer may design the unit so that the user can replace a broken antenna, but the use of a standard antenna jack or electrical connector is prohibited.

The use of a permanently attached antenna or of an antenna that uses a unique coupling to the intentional radiator shall be considered sufficient to comply with the rule.

3.6.2 Antenna Anti-Replacement Construction

An embedded-in antenna design is used.



4. List of Measuring Equipment

| Instrument | Manufacturer | Model No. | Serial No. | Characteristics | Calibration Date | Test Date | Due Date | Remark |
|---------------------|-----------------|-------------------------|--------------------|-----------------|------------------|---------------|---------------|--------------------------|
| AC Power Source | AC POWER | AFC-500W | F10407001 1 | 50Hz~60Hz | Mar. 21, 2018 | Jan. 16, 2019 | Mar. 20, 2019 | Conducted (TH03-HY) |
| Spectrum Analyzer | Rohde & Schwarz | FSP30 | 101329 | 9kHz~30GHz | Jun. 29, 2018 | Jan. 16, 2019 | Jun. 28, 2019 | Conducted (TH03-HY) |
| Temperature Chamber | ESPEC | SU-641 | 92013721 | -30°C ~70°C | Dec. 06, 2017 | Jan. 16, 2019 | Dec. 05, 2019 | Conducted (TH03-HY) |
| AC Power Source | ChainTek | APC-1000W | N/A | N/A | N/A | Jan. 18, 2019 | N/A | Conduction (CO05-HY) |
| EMI Test Receiver | Rohde & Schwarz | ESR3 | 102388 | 9KHz~3.6GHz | Nov. 12, 2018 | Jan. 18, 2019 | Nov. 11, 2019 | Conduction (CO05-HY) |
| LISN | Rohde & Schwarz | ENV216 | 100080 | 9kHz~30MHz | Nov. 14, 2018 | Jan. 18, 2019 | Nov. 13, 2019 | Conduction (CO05-HY) |
| Software | Rohde & Schwarz | EMC32 V10.30 | N/A | N/A | N/A | Jan. 18, 2019 | N/A | Conduction (CO05-HY) |
| LF Cable | HUBER + SUHNER | RG-214/U | LF01 | N/A | Dec. 31, 2018 | Jan. 18, 2019 | Dec. 30, 2019 | Conduction (CO05-HY) |
| Pulse Limiter | Rohde & Schwarz | ESH3-Z2 | 100851 | N/A | Dec. 31, 2018 | Jan. 18, 2019 | Dec. 30, 2019 | Conduction (CO05-HY) |
| Software | Audix | E3 6.2009-8-24 | RK-00104 2 | N/A | N/A | Jan. 14, 2019 | N/A | Radiation (03CH11-HY) |
| Amplifier | SONOMA | 310N | 187312 | 9kHz~1GHz | Dec. 04, 2018 | Jan. 14, 2019 | Dec. 03, 2019 | Radiation (03CH11-HY) |
| Bilog Antenna | TESEQ | CBL 6111D&N-6-0 6 | 35414&AT- N0602 | 30MHz~1GHz | Oct. 13, 2018 | Jan. 14, 2019 | Oct. 12, 2019 | Radiation (03CH11-HY) |
| Spectrum Analyzer | Keysight | N9010A | MY542004 86 | 10Hz ~ 44GHz | Oct. 19, 2018 | Jan. 14, 2019 | Oct. 18, 2019 | Radiation (03CH11-HY) |
| Antenna Mast | EMEC | AM-BS-4500- B | N/A | 1~4m | N/A | Jan. 14, 2019 | N/A | Radiation (03CH11-HY) |
| Turn Table | EMEC | TT 2000 | N/A | 0~360 Degree | N/A | Jan. 14, 2019 | N/A | Radiation (03CH11-HY) |
| EMI Test Receiver | Keysight | N9038A (MXE) | MY554201 70 | N/A | Mar. 06, 2018 | Jan. 14, 2019 | Mar. 05, 2019 | Radiation (03CH11-HY) |
| Filter | Wainwright | WHK20/1000 C7/40SS | SN2 | 20M High Pass | Sep. 16, 2018 | Jan. 14, 2019 | Sep. 15, 2019 | Radiation (03CH11-HY) |
| RF Cable | HUBER + SUHNER | SUCOFLEX 104 | MY9837/4 PE | 9kHz-30MHz | Mar. 14, 2018 | Jan. 14, 2019 | Mar. 13, 2019 | Radiation (03CH11-HY) |
| RF Cable | HUBER + SUHNER | SUCOFLEX 104 | MY9837/4 PE | 30M-18G | Mar. 14, 2018 | Jan. 14, 2019 | Mar. 13, 2019 | Radiation (03CH11-HY) |
| RF Cable | HUBER + SUHNER | SUCOFLEX 102 | MY2859/2 | 30MHz-40GHz | Mar. 14, 2018 | Jan. 14, 2019 | Mar. 13, 2019 | Radiation (03CH11-HY) |
| Loop Antenna | Rohde & Schwarz | HFH2-Z2 | 100488 | 9 kHz~30 MHz | Jan. 07, 2019 | Jan. 14, 2019 | Jan. 06, 2020 | Radiation (03CH11-HY) |



5. Uncertainty of Evaluation

Uncertainty of Conducted Emission Measurement (150 kHz ~ 30 MHz)

| | |
|---|-----|
| Measuring Uncertainty for a Level of Confidence of 95% ($U = 2Uc(y)$) | 2.2 |
|---|-----|

Uncertainty of Radiated Emission Measurement (9 kHz ~ 30 MHz)

| | |
|---|------|
| Measuring Uncertainty for a Level of Confidence of 95% ($U = 2Uc(y)$) | 3.45 |
|---|------|

Uncertainty of Radiated Emission Measurement (30 MHz ~ 1000 MHz)

| | |
|---|-----|
| Measuring Uncertainty for a Level of Confidence of 95% ($U = 2Uc(y)$) | 5.2 |
|---|-----|



Appendix A. Test Results of Conducted Emission Test

| | | | |
|-----------------|---------------|---------------------|---------|
| Test Engineer : | Rick Lin | Temperature : | 23~24°C |
| | | Relative Humidity : | 55~56% |
| Test Voltage : | 120Vac / 60Hz | Phase : | Line |

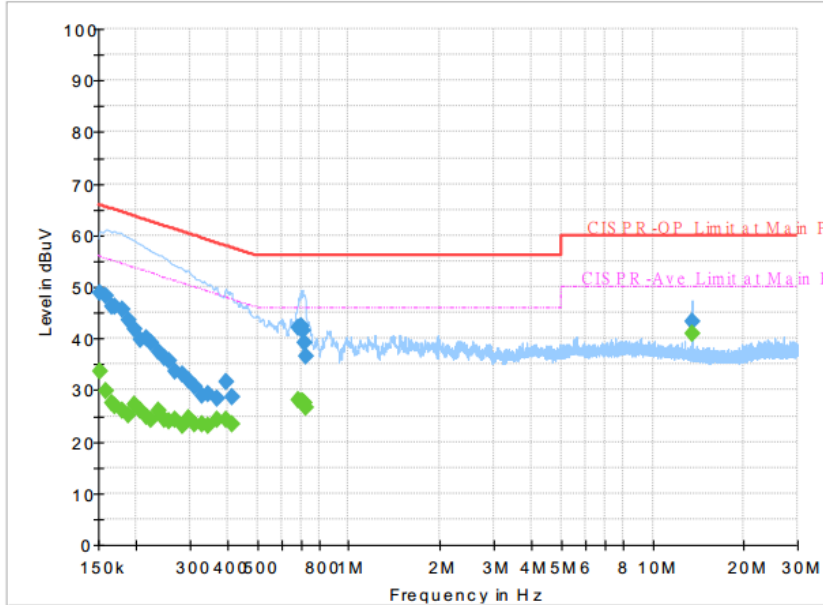

| Frequency (MHz) | QuasiPeak (dBuV) | CAverage (dBuV) | Limit (dBuV) | Margin (dB) | Line | Filter | Corr. (dB) |
|-----------------|------------------|-----------------|--------------|-------------|------|--------|------------|
| 0.152250 | --- | 33.64 | 55.88 | 22.24 | L1 | OFF | 19.5 |
| 0.152250 | 48.95 | --- | 65.88 | 16.93 | L1 | OFF | 19.5 |
| 0.159000 | --- | 29.87 | 55.52 | 25.65 | L1 | OFF | 19.5 |
| 0.159000 | 48.26 | --- | 65.52 | 17.26 | L1 | OFF | 19.5 |
| 0.165750 | --- | 27.38 | 55.17 | 27.79 | L1 | OFF | 19.5 |
| 0.165750 | 46.11 | --- | 65.17 | 19.06 | L1 | OFF | 19.5 |
| 0.170250 | --- | 26.76 | 54.95 | 28.19 | L1 | OFF | 19.5 |
| 0.170250 | 46.20 | --- | 64.95 | 18.75 | L1 | OFF | 19.5 |
| 0.179250 | --- | 25.98 | 54.52 | 28.54 | L1 | OFF | 19.5 |
| 0.179250 | 45.66 | --- | 64.52 | 18.86 | L1 | OFF | 19.5 |
| 0.188250 | --- | 25.26 | 54.11 | 28.85 | L1 | OFF | 19.5 |
| 0.188250 | 43.64 | --- | 64.11 | 20.47 | L1 | OFF | 19.5 |
| 0.197250 | --- | 27.09 | 53.73 | 26.64 | L1 | OFF | 19.5 |
| 0.197250 | 41.80 | --- | 63.73 | 21.93 | L1 | OFF | 19.5 |
| 0.206250 | --- | 25.95 | 53.36 | 27.41 | L1 | OFF | 19.5 |
| 0.206250 | 39.91 | --- | 63.36 | 23.45 | L1 | OFF | 19.5 |
| 0.215250 | --- | 24.77 | 53.00 | 28.23 | L1 | OFF | 19.5 |
| 0.215250 | 39.96 | --- | 63.00 | 23.04 | L1 | OFF | 19.5 |
| 0.224250 | --- | 24.41 | 52.66 | 28.25 | L1 | OFF | 19.5 |
| 0.224250 | 39.29 | --- | 62.66 | 23.37 | L1 | OFF | 19.5 |
| 0.235500 | --- | 26.09 | 52.25 | 26.16 | L1 | OFF | 19.5 |
| 0.235500 | 37.49 | --- | 62.25 | 24.76 | L1 | OFF | 19.5 |



| | | | |
|-----------------|---------------|---------------------|---------|
| Test Engineer : | Rick Lin | Temperature : | 23~24°C |
| | | Relative Humidity : | 55~56% |
| Test Voltage : | 120Vac / 60Hz | Phase : | Line |

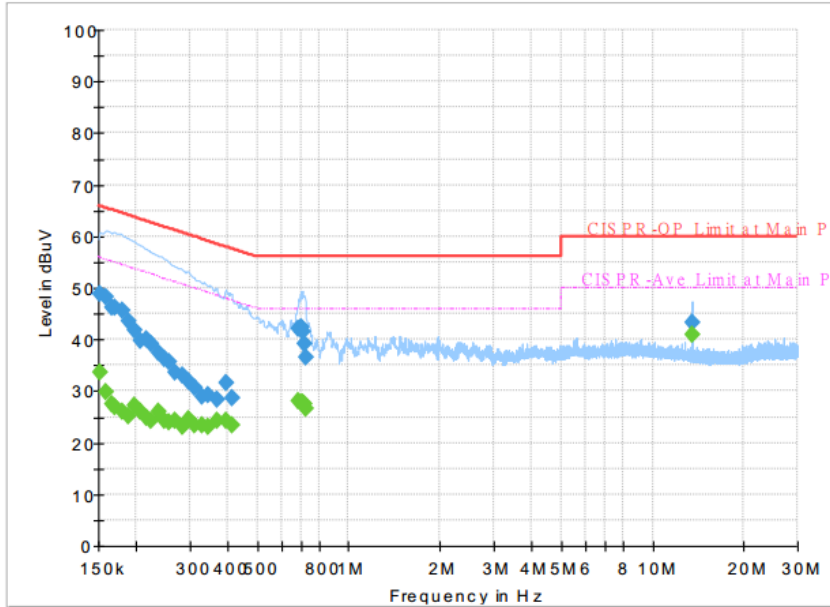

| Frequency (MHz) | QuasiPeak (dBuV) | CAverage (dBuV) | Limit (dBuV) | Margin (dB) | Line | Filter | Corr. (dB) |
|-----------------|------------------|-----------------|--------------|-------------|------|--------|------------|
| 0.246750 | --- | 24.13 | 51.87 | 27.74 | L1 | OFF | 19.5 |
| 0.246750 | 36.26 | --- | 61.87 | 25.61 | L1 | OFF | 19.5 |
| 0.255750 | --- | 24.02 | 51.57 | 27.55 | L1 | OFF | 19.5 |
| 0.255750 | 35.64 | --- | 61.57 | 25.93 | L1 | OFF | 19.5 |
| 0.269250 | --- | 24.24 | 51.14 | 26.90 | L1 | OFF | 19.5 |
| 0.269250 | 33.69 | --- | 61.14 | 27.45 | L1 | OFF | 19.5 |
| 0.285000 | --- | 23.21 | 50.67 | 27.46 | L1 | OFF | 19.5 |
| 0.285000 | 32.91 | --- | 60.67 | 27.76 | L1 | OFF | 19.5 |
| 0.298500 | --- | 24.59 | 50.28 | 25.69 | L1 | OFF | 19.5 |
| 0.298500 | 31.88 | --- | 60.28 | 28.40 | L1 | OFF | 19.5 |
| 0.309750 | --- | 23.47 | 49.98 | 26.51 | L1 | OFF | 19.5 |
| 0.309750 | 30.83 | --- | 59.98 | 29.15 | L1 | OFF | 19.5 |
| 0.327750 | --- | 23.27 | 49.51 | 26.24 | L1 | OFF | 19.5 |
| 0.327750 | 28.96 | --- | 59.51 | 30.55 | L1 | OFF | 19.5 |
| 0.345750 | --- | 23.24 | 49.06 | 25.82 | L1 | OFF | 19.5 |
| 0.345750 | 29.38 | --- | 59.06 | 29.68 | L1 | OFF | 19.5 |
| 0.368250 | --- | 24.14 | 48.54 | 24.40 | L1 | OFF | 19.5 |
| 0.368250 | 28.44 | --- | 58.54 | 30.10 | L1 | OFF | 19.5 |
| 0.393000 | --- | 24.23 | 48.00 | 23.77 | L1 | OFF | 19.5 |
| 0.393000 | 31.48 | --- | 58.00 | 26.52 | L1 | OFF | 19.5 |
| 0.413250 | --- | 23.43 | 47.58 | 24.15 | L1 | OFF | 19.5 |
| 0.413250 | 28.73 | --- | 57.58 | 28.85 | L1 | OFF | 19.5 |
| 0.685500 | --- | 27.96 | 46.00 | 18.04 | L1 | OFF | 19.6 |
| 0.685500 | 42.15 | --- | 56.00 | 13.85 | L1 | OFF | 19.6 |



| | | | |
|-----------------|---------------|---------------------|---------|
| Test Engineer : | Rick Lin | Temperature : | 23~24°C |
| | | Relative Humidity : | 55~56% |
| Test Voltage : | 120Vac / 60Hz | Phase : | Line |

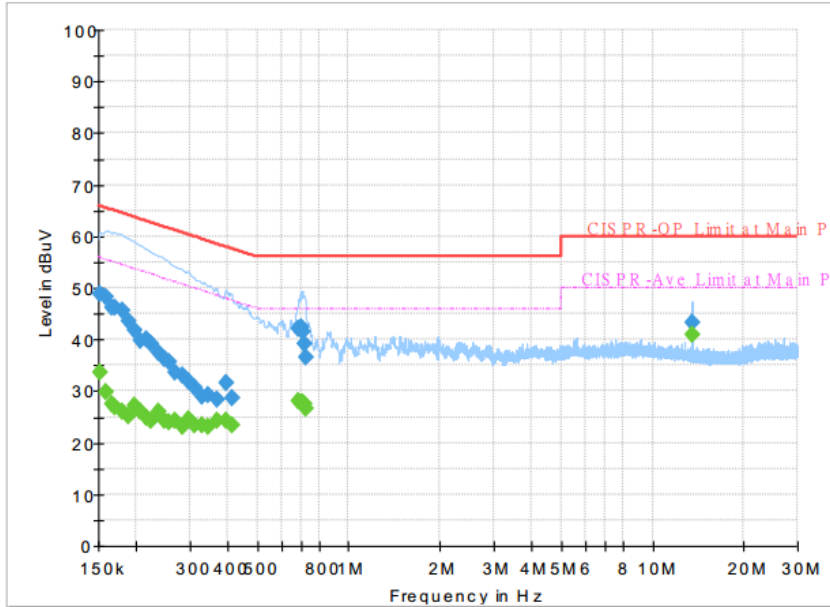

| Frequency (MHz) | QuasiPeak (dBuV) | CAverage (dBuV) | Limit (dBuV) | Margin (dB) | Line | Filter | Corr. (dB) |
|-----------------|------------------|-----------------|--------------|-------------|------|--------|------------|
| 0.694500 | --- | 27.87 | 46.00 | 18.13 | L1 | OFF | 19.6 |
| 0.694500 | 42.43 | --- | 56.00 | 13.57 | L1 | OFF | 19.6 |
| 0.703500 | --- | 27.87 | 46.00 | 18.13 | L1 | OFF | 19.6 |
| 0.703500 | 41.66 | --- | 56.00 | 14.34 | L1 | OFF | 19.6 |
| 0.717000 | --- | 27.38 | 46.00 | 18.62 | L1 | OFF | 19.6 |
| 0.717000 | 39.31 | --- | 56.00 | 16.69 | L1 | OFF | 19.6 |
| 0.721500 | --- | 26.50 | 46.00 | 19.50 | L1 | OFF | 19.6 |
| 0.721500 | 36.63 | --- | 56.00 | 19.37 | L1 | OFF | 19.6 |
| 13.560000 | --- | 40.85 | 50.00 | 9.15 | L1 | OFF | 20.0 |
| 13.560000 | 43.41 | --- | 60.00 | 16.59 | L1 | OFF | 20.0 |



| | | | |
|-----------------|---------------|---------------------|---------|
| Test Engineer : | Rick Lin | Temperature : | 23~24°C |
| | | Relative Humidity : | 55~56% |
| Test Voltage : | 120Vac / 60Hz | Phase : | Neutral |

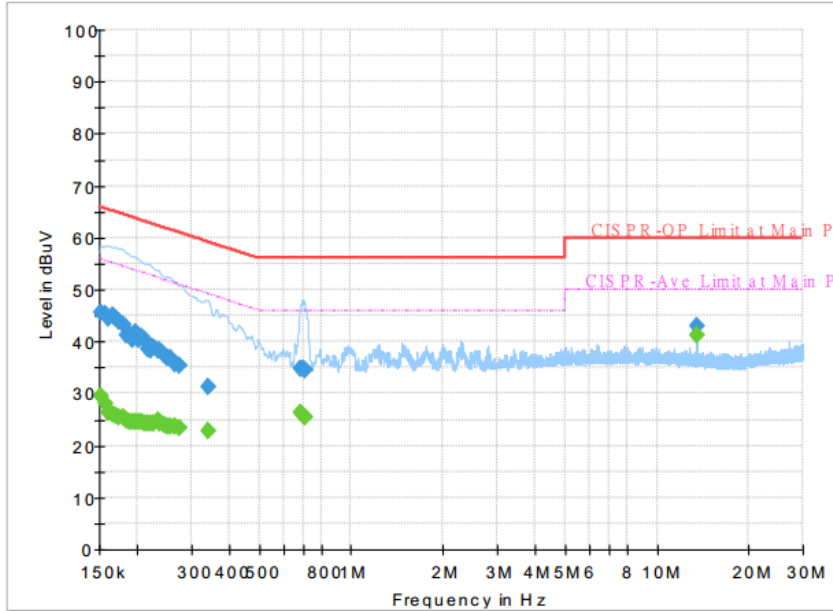

| Frequency (MHz) | QuasiPeak (dBuV) | CAverage (dBuV) | Limit (dBuV) | Margin (dB) | Line | Filter | Corr. (dB) |
|-----------------|------------------|-----------------|--------------|-------------|------|--------|------------|
| 0.152250 | --- | 29.65 | 55.88 | 26.23 | N | OFF | 19.5 |
| 0.152250 | 45.51 | --- | 65.88 | 20.37 | N | OFF | 19.5 |
| 0.156750 | --- | 28.08 | 55.63 | 27.55 | N | OFF | 19.5 |
| 0.156750 | 45.29 | --- | 65.63 | 20.34 | N | OFF | 19.5 |
| 0.161250 | --- | 26.19 | 55.40 | 29.21 | N | OFF | 19.5 |
| 0.161250 | 44.46 | --- | 65.40 | 20.94 | N | OFF | 19.5 |
| 0.165750 | --- | 26.16 | 55.17 | 29.01 | N | OFF | 19.5 |
| 0.165750 | 44.92 | --- | 65.17 | 20.25 | N | OFF | 19.5 |
| 0.170250 | --- | 25.71 | 54.95 | 29.24 | N | OFF | 19.5 |
| 0.170250 | 44.31 | --- | 64.95 | 20.64 | N | OFF | 19.5 |
| 0.174750 | --- | 25.39 | 54.73 | 29.34 | N | OFF | 19.5 |
| 0.174750 | 43.90 | --- | 64.73 | 20.83 | N | OFF | 19.5 |
| 0.179250 | --- | 25.32 | 54.52 | 29.20 | N | OFF | 19.5 |
| 0.179250 | 43.20 | --- | 64.52 | 21.32 | N | OFF | 19.5 |
| 0.183750 | --- | 24.76 | 54.31 | 29.55 | N | OFF | 19.5 |
| 0.183750 | 41.31 | --- | 64.31 | 23.00 | N | OFF | 19.5 |
| 0.188250 | --- | 24.66 | 54.11 | 29.45 | N | OFF | 19.5 |
| 0.188250 | 41.59 | --- | 64.11 | 22.52 | N | OFF | 19.5 |
| 0.192750 | --- | 24.70 | 53.92 | 29.22 | N | OFF | 19.5 |
| 0.192750 | 40.41 | --- | 63.92 | 23.51 | N | OFF | 19.5 |
| 0.197250 | --- | 24.68 | 53.73 | 29.05 | N | OFF | 19.5 |
| 0.197250 | 41.83 | --- | 63.73 | 21.90 | N | OFF | 19.5 |



| | | | |
|-----------------|---------------|---------------------|---------|
| Test Engineer : | Rick Lin | Temperature : | 23~24°C |
| | | Relative Humidity : | 55~56% |
| Test Voltage : | 120Vac / 60Hz | Phase : | Neutral |

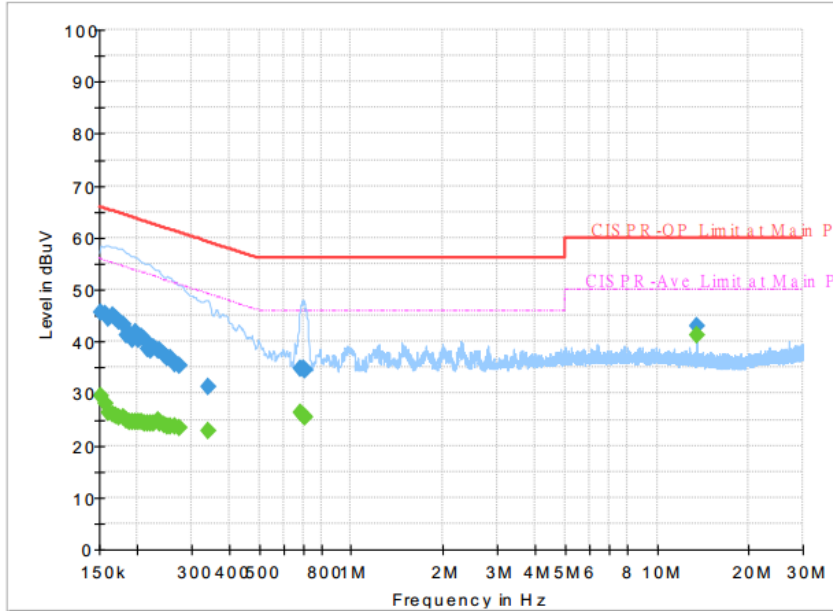

| Frequency (MHz) | QuasiPeak (dBuV) | CAverage (dBuV) | Limit (dBuV) | Margin (dB) | Line | Filter | Corr. (dB) |
|-----------------|------------------|-----------------|--------------|-------------|------|--------|------------|
| 0.201750 | --- | 24.59 | 53.54 | 28.95 | N | OFF | 19.5 |
| 0.201750 | 40.36 | --- | 63.54 | 23.18 | N | OFF | 19.5 |
| 0.206250 | --- | 24.53 | 53.36 | 28.83 | N | OFF | 19.5 |
| 0.206250 | 40.81 | --- | 63.36 | 22.55 | N | OFF | 19.5 |
| 0.210750 | --- | 24.25 | 53.18 | 28.93 | N | OFF | 19.5 |
| 0.210750 | 40.39 | --- | 63.18 | 22.79 | N | OFF | 19.5 |
| 0.215250 | --- | 24.38 | 53.00 | 28.62 | N | OFF | 19.5 |
| 0.215250 | 38.54 | --- | 63.00 | 24.46 | N | OFF | 19.5 |
| 0.222000 | --- | 24.17 | 52.74 | 28.57 | N | OFF | 19.5 |
| 0.222000 | 38.30 | --- | 62.74 | 24.44 | N | OFF | 19.5 |
| 0.226500 | --- | 24.22 | 52.58 | 28.36 | N | OFF | 19.5 |
| 0.226500 | 38.90 | --- | 62.58 | 23.68 | N | OFF | 19.5 |
| 0.233250 | --- | 24.72 | 52.33 | 27.61 | N | OFF | 19.5 |
| 0.233250 | 38.29 | --- | 62.33 | 24.04 | N | OFF | 19.5 |
| 0.237750 | --- | 24.13 | 52.17 | 28.04 | N | OFF | 19.5 |
| 0.237750 | 38.16 | --- | 62.17 | 24.01 | N | OFF | 19.5 |
| 0.244500 | --- | 23.87 | 51.94 | 28.07 | N | OFF | 19.5 |
| 0.244500 | 37.46 | --- | 61.94 | 24.48 | N | OFF | 19.5 |
| 0.251250 | --- | 23.71 | 51.72 | 28.01 | N | OFF | 19.5 |
| 0.251250 | 36.85 | --- | 61.72 | 24.87 | N | OFF | 19.5 |
| 0.255750 | --- | 23.78 | 51.57 | 27.79 | N | OFF | 19.5 |
| 0.255750 | 36.77 | --- | 61.57 | 24.80 | N | OFF | 19.5 |
| 0.264750 | --- | 23.65 | 51.28 | 27.63 | N | OFF | 19.5 |
| 0.264750 | 35.77 | --- | 61.28 | 25.51 | N | OFF | 19.5 |



| | | | |
|-----------------|---------------|---------------------|---------|
| Test Engineer : | Rick Lin | Temperature : | 23~24°C |
| | | Relative Humidity : | 55~56% |
| Test Voltage : | 120Vac / 60Hz | Phase : | Neutral |

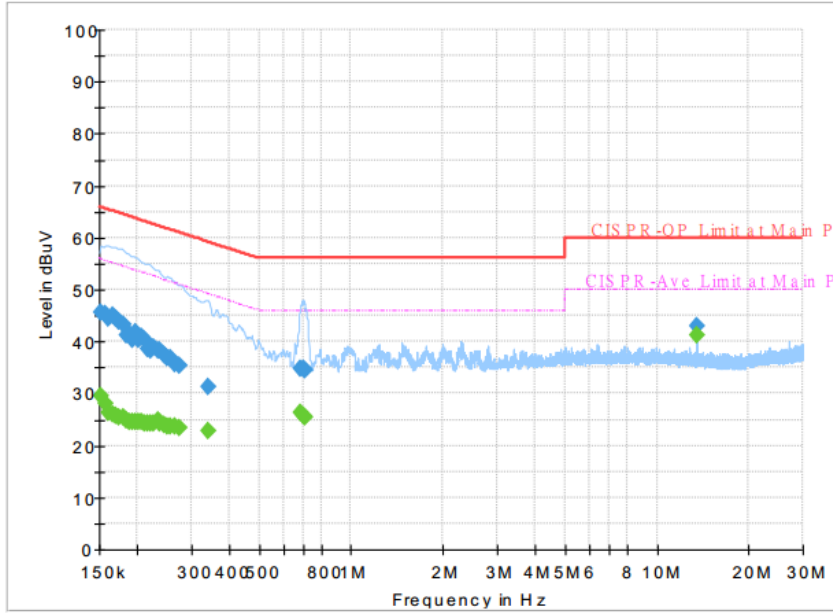

| Frequency (MHz) | QuasiPeak (dBuV) | CAverage (dBuV) | Limit (dBuV) | Margin (dB) | Line | Filter | Corr. (dB) |
|-----------------|------------------|-----------------|--------------|-------------|------|--------|------------|
| 0.273750 | --- | 23.53 | 51.00 | 27.47 | N | OFF | 19.5 |
| 0.273750 | 35.25 | --- | 61.00 | 25.75 | N | OFF | 19.5 |
| 0.339000 | --- | 22.75 | 49.23 | 26.48 | N | OFF | 19.5 |
| 0.339000 | 31.20 | --- | 59.23 | 28.03 | N | OFF | 19.5 |
| 0.685500 | --- | 26.31 | 46.00 | 19.69 | N | OFF | 19.6 |
| 0.685500 | 34.91 | --- | 56.00 | 21.09 | N | OFF | 19.6 |
| 0.696750 | --- | 25.78 | 46.00 | 20.22 | N | OFF | 19.6 |
| 0.696750 | 34.83 | --- | 56.00 | 21.17 | N | OFF | 19.6 |
| 0.703500 | --- | 25.50 | 46.00 | 20.50 | N | OFF | 19.6 |
| 0.703500 | 34.61 | --- | 56.00 | 21.39 | N | OFF | 19.6 |
| 13.560000 | --- | 41.35 | 50.00 | 8.65 | N | OFF | 20.1 |
| 13.560000 | 42.85 | --- | 60.00 | 17.15 | N | OFF | 20.1 |



Appendix B. Test Results of Conducted Test Items

B1. Test Result of 20dB Spectrum Bandwidth

| Test mode | NFC Tx | Test Frequency (MHz) | 13.56 |
|------------------------------|----------------|----------------------------|--------------------|
| | | | |
| 20dB Bandwidth (kHz) | 2.620 | 99% OccupiedBW(kHz) | 2.240 |
| Frequency range (MHz) | $f_L > 13.553$ | 13.55892 | Test Result |
| | $f_H < 13.567$ | 13.56154 | Complies |

Remark: Because the measured signal is CW adjusting the RBW per C63.10 would not be practical since measured bandwidth will always follow the RBW and the result will be approximately twice the RBW.



B2. Test Result of Frequency Stability

| B3. Voltage vs. Frequency Stability | | Temperature vs. Frequency Stability | | |
|-------------------------------------|-----------------------------|-------------------------------------|-----------|-----------------------------|
| Voltage (Vac) | Measurement Frequency (MHz) | Temperature (°C) | Time | Measurement Frequency (MHz) |
| 120 | 13.560240 | -20 | 0 | 13.560250 |
| | | | 2 | 13.560240 |
| | | | 5 | 13.560250 |
| | | | 10 | 13.560250 |
| | | -10 | 0 | 13.560250 |
| | | | 2 | 13.560250 |
| | | | 5 | 13.560260 |
| | | | 10 | 13.560250 |
| | | 0 | 0 | 13.560260 |
| | | | 2 | 13.560250 |
| | | | 5 | 13.560260 |
| | | | 10 | 13.560260 |
| | | 10 | 0 | 13.560300 |
| | | | 2 | 13.560260 |
| | | | 5 | 13.560260 |
| | | | 10 | 13.560260 |
| | | 20 | 0 | 13.560230 |
| | | | 2 | 13.560240 |
| | | | 5 | 13.560220 |
| | | | 10 | 13.560240 |
| | | 30 | 0 | 13.560220 |
| | | | 2 | 13.560220 |
| | | | 5 | 13.560220 |
| | | | 10 | 13.560220 |
| | | 40 | 0 | 13.560220 |
| | | | 2 | 13.560220 |
| | | | 5 | 13.560220 |
| | | | 10 | 13.560220 |



| Voltage vs. Frequency Stability | | Temperature vs. Frequency Stability | | |
|---------------------------------|-----------------------------|-------------------------------------|---------------|-----------------------------|
| Voltage (Vac) | Measurement Frequency (MHz) | Temperature (°C) | Time | Measurement Frequency (MHz) |
| | | 50 | 0 | 13.560200 |
| | | | 2 | 13.560200 |
| | | | 5 | 13.560200 |
| | | | 10 | 13.560210 |
| Max.Deviation (MHz) | 0.000240 | Max.Deviation (MHz) | | 0.000300 |
| Max.Deviation (ppm) | 17.6991 | Max.Deviation (ppm) | | 22.1239 |
| Limit | FS < ±100 ppm | Limit | FS < ±100 ppm | |
| Test Result | PASS | Test Result | PASS | |



Appendix C. Test Results of Radiated Test Items

C1. Test Result of Field Strength of Fundamental Emissions

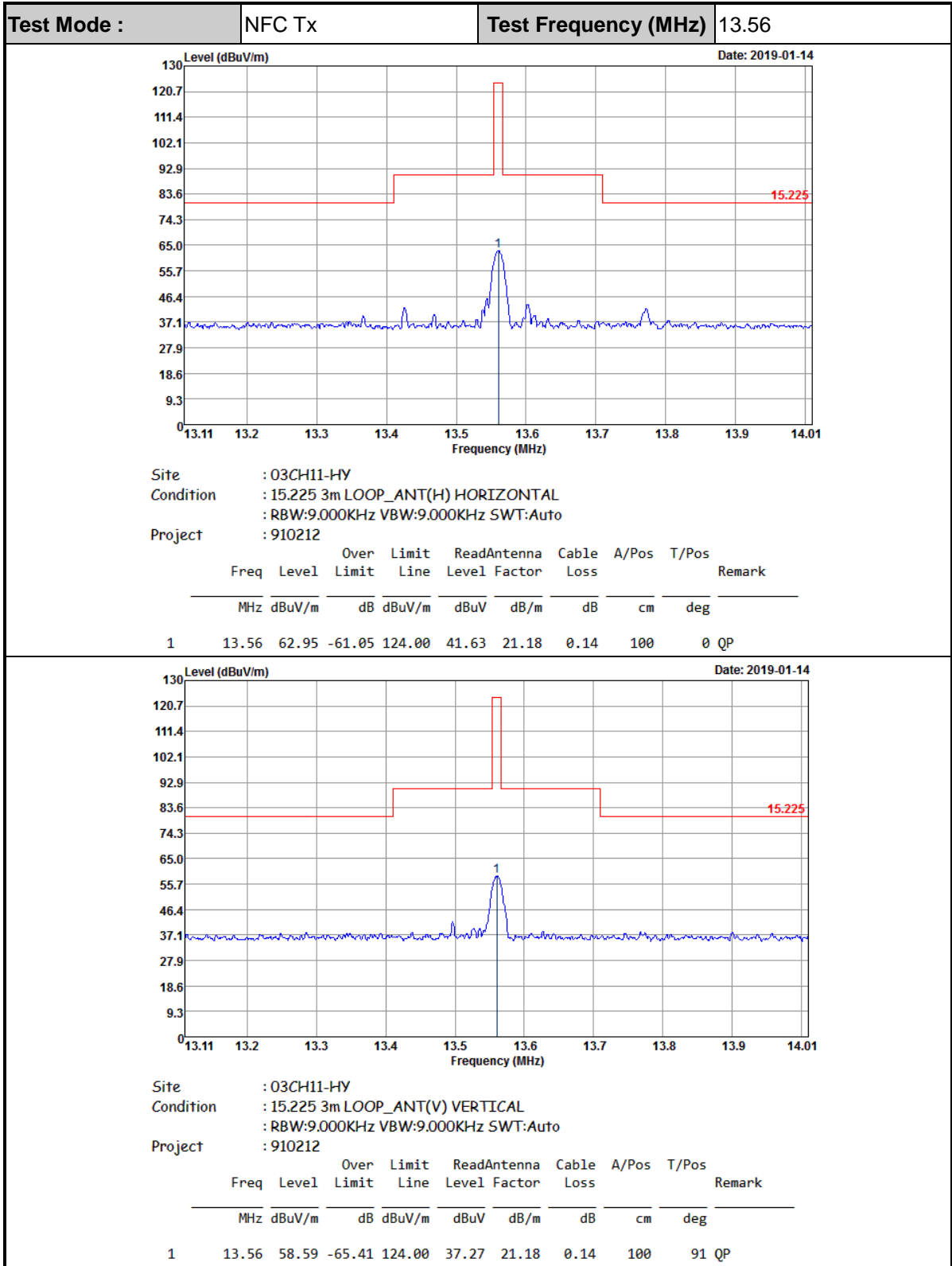



C2. Results of Radiated Spurious Emissions (9 kHz~30MHz)

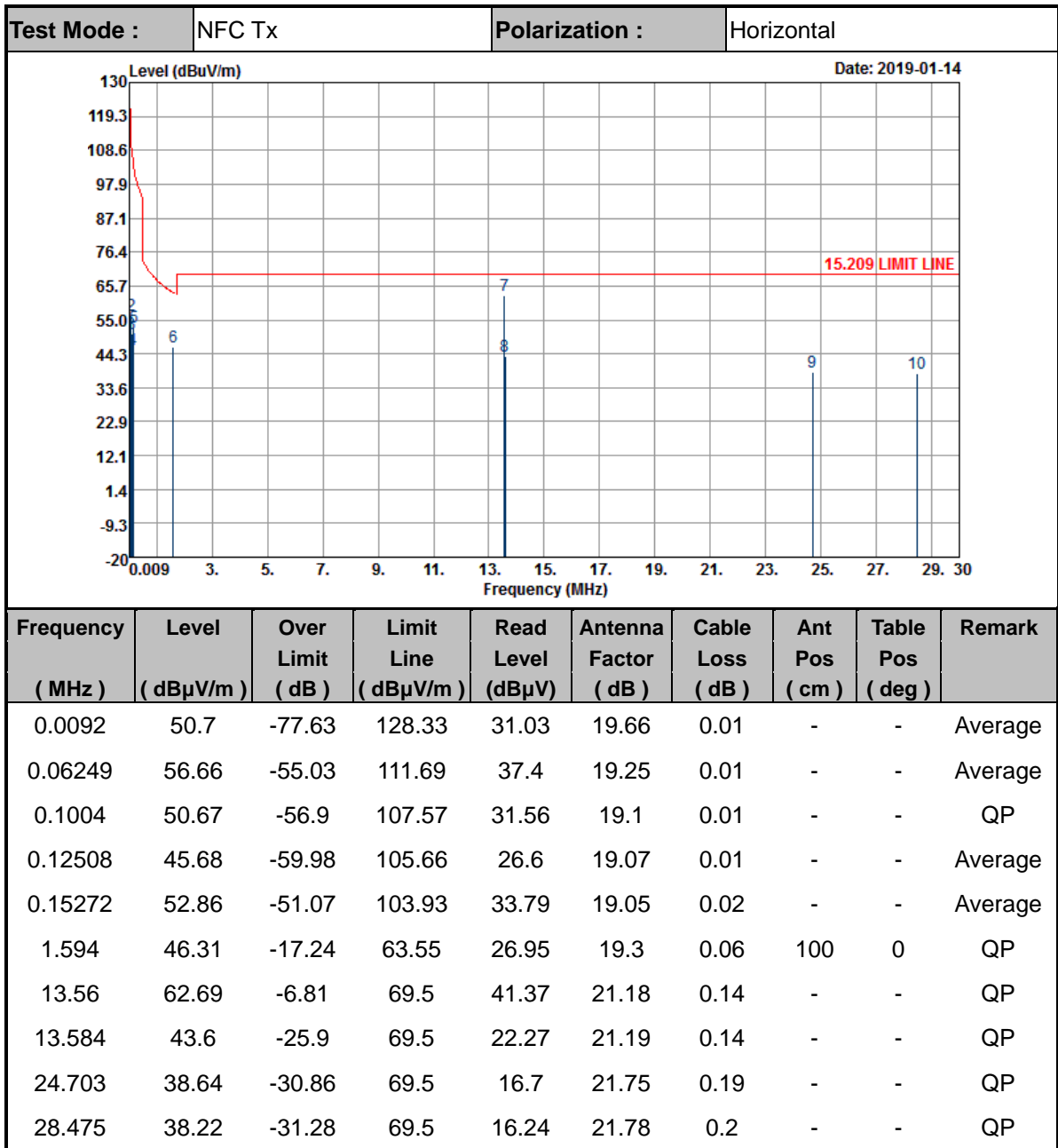

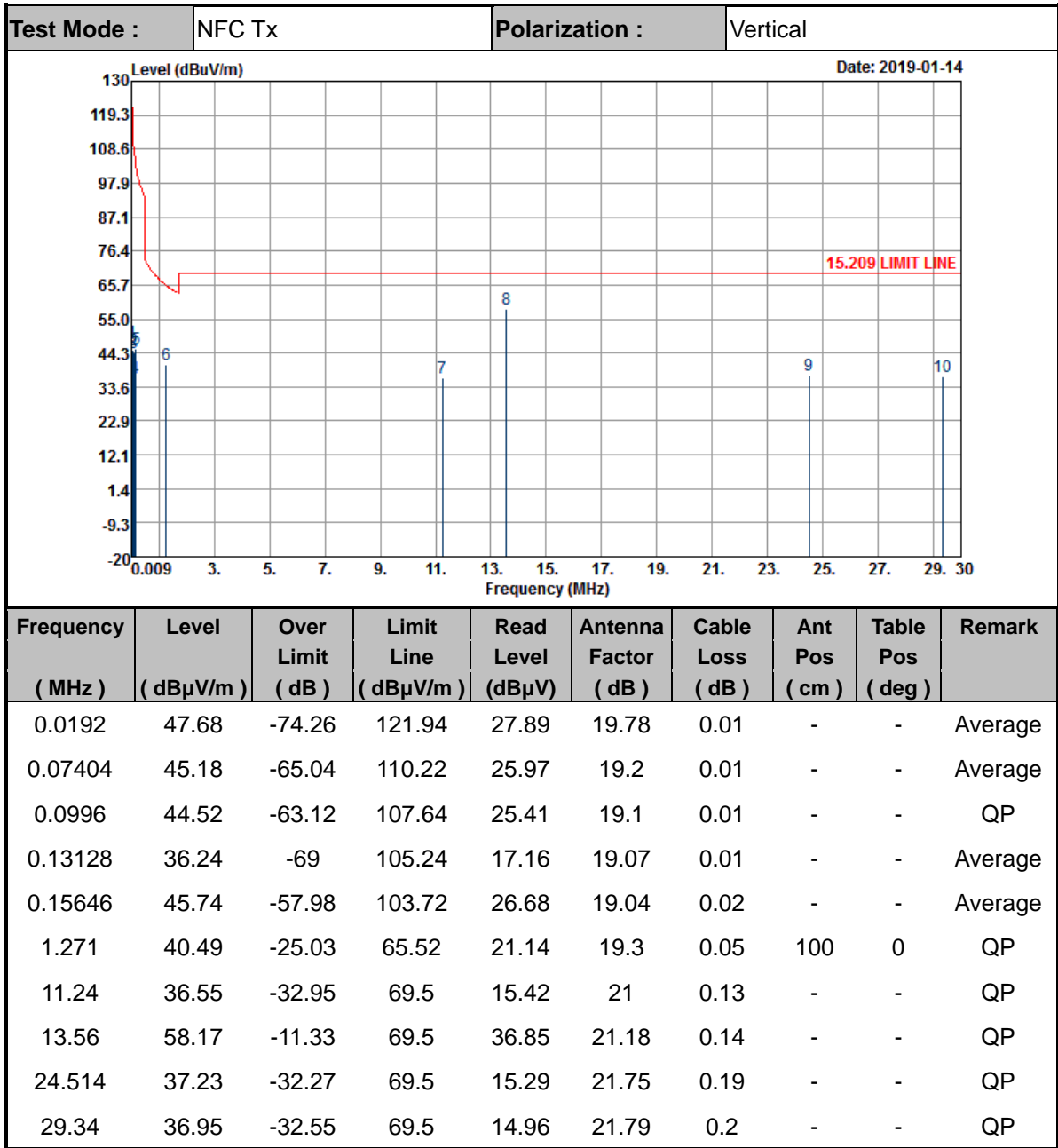

Note:

1. 13.56 MHz is fundamental signal which can be ignored.
2. The amplitude of spurious emissions which are attenuated by more than 20dB below the permissible value has no need to be reported.
3. Distance extrapolation factor = 40 log (specific distance / test distance) (dB);
4. Limit line = specific limits (dBuV) + distance extrapolation factor.



C3. Results of Radiated Spurious Emissions (30MHz~1GHz)

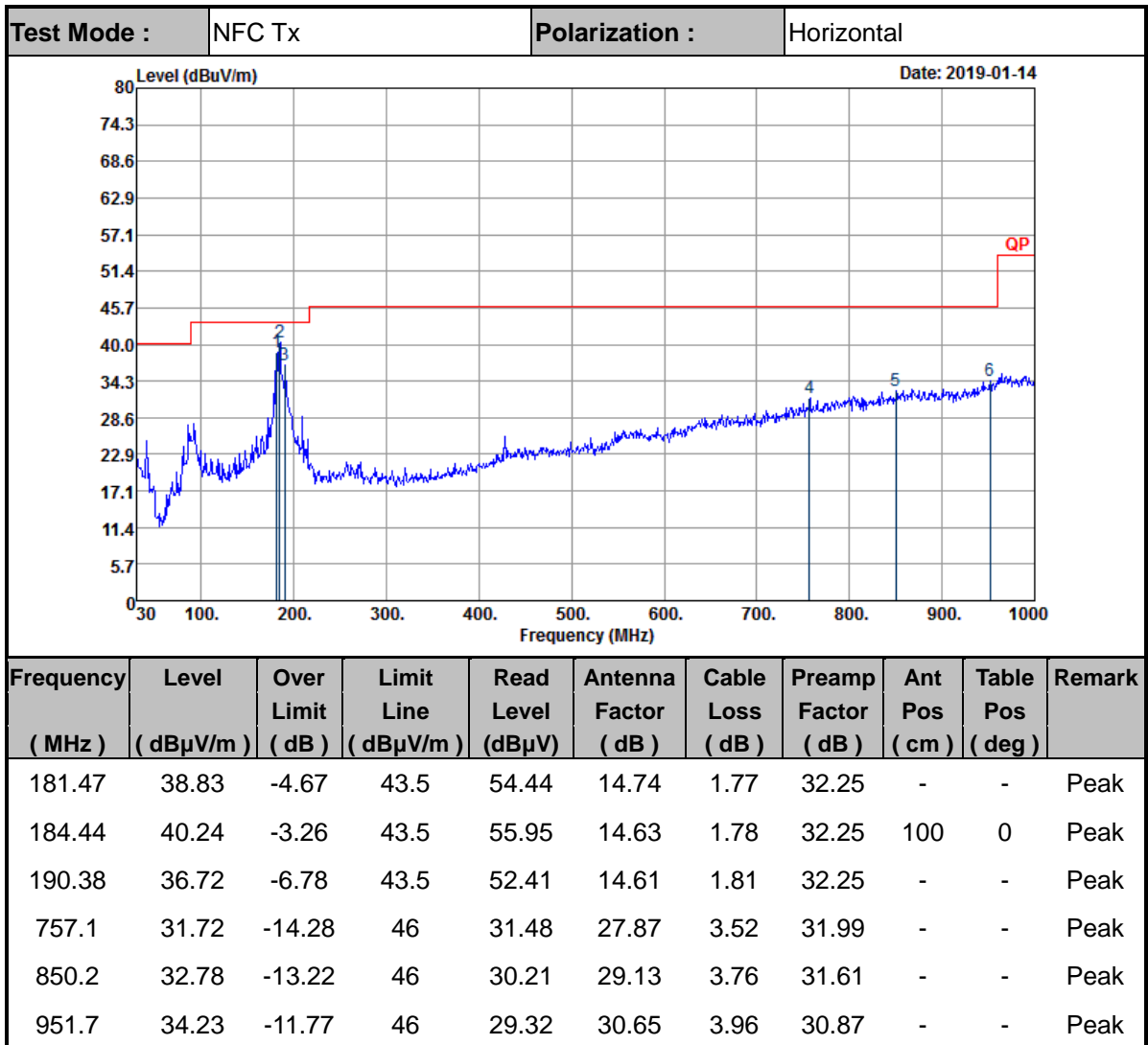

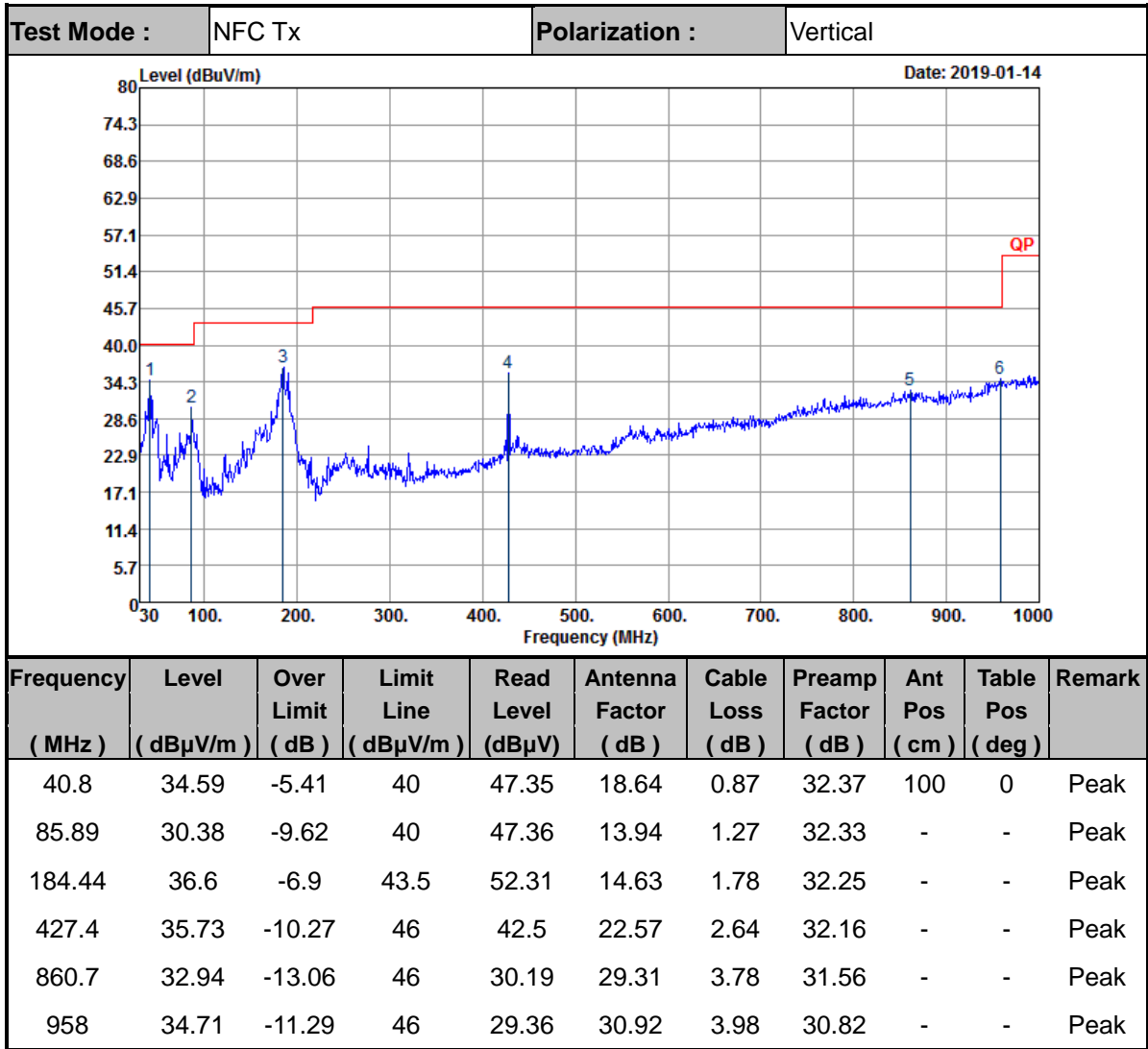

Note:

1. The amplitude of spurious emissions which are attenuated by more than 20dB below the permissible value has no need to be reported.
2. Emission level (dBμV/m) = 20 log Emission level (μV/m).
3. Corrected Reading: Antenna Factor + Cable Loss + Read Level - Preamp Factor= Level.