



FCC RADIO TEST REPORT

FCC ID : 2ABVH-INARI10B2
Equipment : Tablet
Brand Name : AAVA
Model Name : INARI10B-LTG-1
Applicant : Aava Mobile Oy
NAHKATEHTAANKATU 2 90130
OULU FINLAND
Manufacturer : Aava Mobile Oy
NAHKATEHTAANKATU 2 90130
OULU FINLAND
Standard : FCC Part 15 Subpart C §15.247

The product was received on Jun. 06, 2019 and testing was started from Jul. 09, 2019 and completed on Jul. 16, 2019. We, SPORTON INTERNATIONAL INC., EMC & Wireless Communications Laboratory, would like to declare that the tested sample has been evaluated in accordance with the test procedures and has been in compliance with the applicable technical standards.

The report must not be used by the client to claim product certification, approval, or endorsement by TAF or any agency of government.

The test results in this variant report apply exclusively to the tested model / sample. Without written approval of SPORTON INTERNATIONAL INC. EMC & Wireless Communications Laboratory, the test report shall not be reproduced except in full.

Reviewed by: Jones Tsai

SPORTON INTERNATIONAL INC. EMC & Wireless Communications Laboratory

No. 52, Huaya 1st Rd., Guishan Dist., Taoyuan City, Taiwan (R.O.C.)



Table of Contents

History of this test report.....	3
Summary of Test Result.....	4
1 General Description.....	5
1.1 Product Feature of Equipment Under Test.....	5
1.2 Product Specification of Equipment Under Test.....	5
1.3 Modification of EUT	5
1.4 Testing Location	6
1.5 Applicable Standards.....	6
2 Test Configuration of Equipment Under Test.....	7
2.1 Carrier Frequency Channel	7
2.2 Test Mode.....	8
2.3 Connection Diagram of Test System.....	11
2.4 Support Unit used in test configuration and system	11
2.5 EUT Operation Test Setup	12
3 Test Result.....	13
3.1 Output Power Measurement.....	13
3.2 Radiated Band Edges and Spurious Emission Measurement	15
3.3 Antenna Requirements	18
4 List of Measuring Equipment	19
5 Uncertainty of Evaluation.....	21
Appendix A. Radiated Spurious Emission	
Appendix B. Radiated Spurious Emission Plots	
Appendix C. Duty Cycle Plots	
Appendix D. Setup Photographs	
Appendix E. Original Report	



History of this test report

Report No.	Version	Description	Issued Date
FR960640A	01	Initial issue of report	Jul. 30, 2019



Summary of Test Result

Report Clause	Ref Std. Clause	Test Items	Result (PASS/FAIL)	Remark
-	15.247(a)(1)	Number of Channels	Not Required	-
-	15.247(a)(1)	Hopping Channel Separation	Not Required	-
-	15.247(a)(1)	Dwell Time of Each Channel	Not Required	-
-	15.247(a)(1)	20dB Bandwidth	Not Required	-
-	2.1049	99% Occupied Bandwidth	Not Required	-
3.1	15.247(b)(1)	Peak Output Power	Pass	-
-	15.247(d)	Conducted Band Edges	Not Required	-
-	15.247(d)	Conducted Spurious Emission	Not Required	-
3.2	15.247(d)	Radiated Band Edges and Radiated Spurious Emission	Pass	Under limit 15.85 dB at 2490.080 MHz
-	15.207	AC Conducted Emission	Not Required	-
3.3	15.203 & 15.247(b)	Antenna Requirement	Pass	-

Remark:

1. Not required means after assessing, test items are not necessary to carry out.
2. This is a variant report by adding WWAN module. All the test cases were performed on original report which can be referred to Sporton Report Number FR910212A as appendix E. Based on the original report, the test cases were verified.

Declaration of Conformity:

The test results with all measurement uncertainty excluded are presented in accordance with the regulation limits or requirements declared by manufacturers.

Comments and Explanations:

The declared of product specification for EUT presented in the report are provided by the manufacturer, and the manufacturer takes all the responsibilities for the accuracy of product specification.

Reviewed by: Wii Chang

Report Producer: Ann Lee

1 General Description

1.1 Product Feature of Equipment Under Test

Product Feature	
Equipment	Tablet
Brand Name	AAVA
Model Name	INARI10B-LTG-1
FCC ID	2ABVH-INARI10B2
EUT supports Radios application	WCDMA/HSPA/LTE/NFC/GNSS WLAN 11a/b/g/n HT20/HT40 WLAN 11ac VHT20/VHT40/VHT80 Bluetooth BR/EDR/LE
HW Version	RU
SW Version	Windows 10
EUT Stage	Identical Prototype

Remark: The above EUT's information was declared by manufacturer.

Specification of Accessories				
AC Adapter	Brand Name	PHIHONG	Model Name	AQ18A-59CFA
Battery	Brand Name	Etica Battery	Model Name	AMME3950
USB Cable	Brand Name	PHIHONG	Model Name	UES-1001A160-R

1.2 Product Specification of Equipment Under Test

Standards-related Product Specification	
Tx/Rx Frequency Range	2402 MHz ~ 2480 MHz
Number of Channels	79
Carrier Frequency of Each Channel	2402+n*1 MHz; n=0~78
Maximum Output Power to Antenna	Bluetooth BR(1Mbps) : 10.40 dBm (0.0110 W) Bluetooth EDR (2Mbps) : 8.34 dBm (0.0068 W) Bluetooth EDR (3Mbps) : 7.80 dBm (0.0061 W)
Antenna Type / Gain	Ceramic Antenna with gain 1.0 dBi
Type of Modulation	Bluetooth BR (1Mbps) : GFSK Bluetooth EDR (2Mbps) : $\pi/4$ -DQPSK Bluetooth EDR (3Mbps) : 8-DPSK

1.3 Modification of EUT

No modifications are made to the EUT during all test items.



1.4 Testing Location

Test Site	SPORTON INTERNATIONAL INC. EMC & Wireless Communications Laboratory	
Test Site Location	No.52, Huaya 1st Rd., Guishan Dist., Taoyuan City, Taiwan (R.O.C.) TEL: +886-3-327-3456 FAX: +886-3-328-4978	
Test Site No.	Sporton Site No.	
	TH05-HY	03CH07-HY

Note: The test site complies with ANSI C63.4 2014 requirement.

FCC designation No.: TW1190

1.5 Applicable Standards

According to the specifications of the manufacturer, the EUT must comply with the requirements of the following standards:

- ♦ FCC Part 15 Subpart C §15.247
- ♦ FCC KDB Publication No. 558074 D01 DTS Meas. Guidance v05r02
- ♦ FCC KDB 414788 D01 Radiated Test Site v01r01
- ♦ ANSI C63.10-2013

Remark:

1. All test items were verified and recorded according to the standards and without any deviation during the test.
2. This EUT has also been tested and complied with the requirements of FCC Part 15, Subpart B, recorded in a separate test report.



2 Test Configuration of Equipment Under Test

2.1 Carrier Frequency Channel

Frequency Band	Channel	Freq. (MHz)	Channel	Freq. (MHz)	Channel	Freq. (MHz)
2400-2483.5 MHz	0	2402	27	2429	54	2456
	1	2403	28	2430	55	2457
	2	2404	29	2431	56	2458
	3	2405	30	2432	57	2459
	4	2406	31	2433	58	2460
	5	2407	32	2434	59	2461
	6	2408	33	2435	60	2462
	7	2409	34	2436	61	2463
	8	2410	35	2437	62	2464
	9	2411	36	2438	63	2465
	10	2412	37	2439	64	2466
	11	2413	38	2440	65	2467
	12	2414	39	2441	66	2468
	13	2415	40	2442	67	2469
	14	2416	41	2443	68	2470
	15	2417	42	2444	69	2471
	16	2418	43	2445	70	2472
	17	2419	44	2446	71	2473
	18	2420	45	2447	72	2474
	19	2421	46	2448	73	2475
	20	2422	47	2449	74	2476
	21	2423	48	2450	75	2477
	22	2424	49	2451	76	2478
	23	2425	50	2452	77	2479
	24	2426	51	2453	78	2480
	25	2427	52	2454	-	-
	26	2428	53	2455	-	-



2.2 Test Mode

Channel	Frequency	Bluetooth Average Output Power		
		GFSK / 1Mbps		
		DH1	DH3	DH5
Ch00	2402MHz	8.76 dBm	8.73 dBm	8.59 dBm
Ch39	2441MHz	10.37 dBm	10.20 dBm	10.31 dBm
Ch78	2480MHz	9.11 dBm	9.04 dBm	9.02 dBm

Channel	Frequency	Bluetooth Average Output Power		
		$\pi/4$ -DQPSK / 2Mbps		
		2DH1	2DH3	2DH5
Ch00	2402MHz	5.25 dBm	5.23 dBm	5.24 dBm
Ch39	2441MHz	6.28 dBm	6.26 dBm	6.30 dBm
Ch78	2480MHz	4.60 dBm	4.74 dBm	4.69 dBm

Channel	Frequency	Bluetooth Average Output Power		
		8-DPSK / 3Mbps		
		3DH1	3DH3	3DH5
Ch00	2402MHz	4.34 dBm	4.34 dBm	4.37 dBm
Ch39	2441MHz	5.37 dBm	5.35 dBm	5.46 dBm
Ch78	2480MHz	3.90 dBm	4.09 dBm	4.07 dBm



Channel	Frequency	Bluetooth Peak Output Power		
		GFSK / 1Mbps		
		DH1	DH3	DH5
Ch00	2402MHz	8.80 dBm	8.90 dBm	8.80 dBm
Ch39	2441MHz	10.37 dBm	10.38 dBm	10.40 dBm
Ch78	2480MHz	9.09 dBm	9.10 dBm	9.11 dBm

Channel	Frequency	Bluetooth Peak Output Power		
		$\pi/4$ -DQPSK / 2Mbps		
		2DH1	2DH3	2DH5
Ch00	2402MHz	7.35 dBm	7.31 dBm	7.31 dBm
Ch39	2441MHz	8.31 dBm	8.32 dBm	8.34 dBm
Ch78	2480MHz	6.83 dBm	6.84 dBm	6.85 dBm

Channel	Frequency	Bluetooth Peak Output Power		
		8-DPSK / 3Mbps		
		3DH1	3DH3	3DH5
Ch00	2402MHz	6.81 dBm	6.79 dBm	6.73 dBm
Ch39	2441MHz	7.75 dBm	7.79 dBm	7.80 dBm
Ch78	2480MHz	6.46 dBm	6.45 dBm	6.47 dBm

Remark:The data rate was set in 1Mbps for all the test items due to the highest RF output power.



- a. The EUT has been associated with peripherals and configuration operated in a manner tended to maximize its emission characteristics in a typical application. Frequency range investigated:, radiation emission (9 kHz to the 10th harmonic of the highest fundamental frequency or to 40 GHz, whichever is lower). For radiated measurement, pre-scanned in three orthogonal panels, X, Y, Z. The worst cases (Z plane) were recorded in this report, and the worst mode of radiated spurious emissions is Bluetooth 1Mbps mode, and recorded in this report.

The following summary table is showing all test modes to demonstrate in compliance with the standard.

Summary table of Test Cases			
Test Item	Data Rate / Modulation		
	Bluetooth BR 1Mbps GFSK	Bluetooth EDR 2Mbps $\pi/4$ -DQPSK	Bluetooth EDR 3Mbps 8-DPSK
Conducted Test Cases	Mode 1: CH00_2402 MHz	Mode 4: CH00_2402 MHz	Mode 7: CH00_2402 MHz
	Mode 2: CH39_2441 MHz	Mode 5: CH39_2441 MHz	Mode 8: CH39_2441 MHz
	Mode 3: CH78_2480 MHz	Mode 6: CH78_2480 MHz	Mode 9: CH78_2480 MHz
Radiated Test Cases	Bluetooth BR 1Mbps GFSK		
	Mode 1: CH00_2402 MHz		
	Mode 2: CH39_2441 MHz		
	Mode 3: CH78_2480 MHz		
Remark: For radiated test cases, the worst mode data rate 1Mbps was reported only since the highest RF output power in the preliminary tests.			

2.3 Connection Diagram of Test System

<Bluetooth Tx Mode>

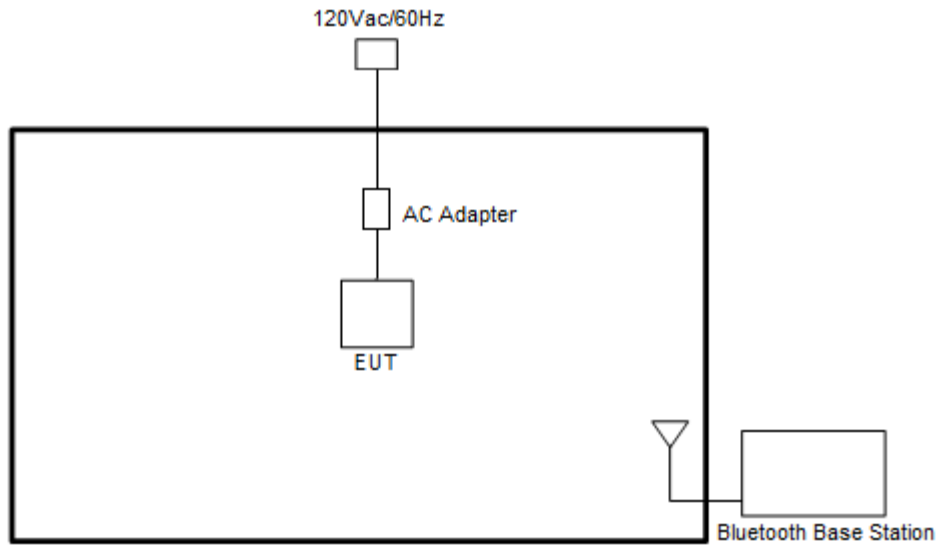

2.4 Support Unit used in test configuration and system

Item	Equipment	Trade Name	Model Name	FCC ID	Data Cable	Power Cord
1.	Bluetooth Base Station	R&S	CBT32	N/A	N/A	Unshielded, 1.8 m



2.5 EUT Operation Test Setup

The RF test items, utility “DRTU version 11.1803.0-06808” was installed in EUT which was programmed in order to make the EUT get into the engineering modes to contact with base station to provide channel selection, power level, data rate and the application type and for continuous transmitting signals.

3 Test Result

3.1 Output Power Measurement

3.1.1 Limit of Output Power

The maximum peak conducted output power of the intentional radiator shall not exceed the following:
For frequency hopping systems operating in the 2400-2483.5 MHz band employing at least 75 non-overlapping hopping channels, and all frequency hopping systems in the 5725-5850 MHz band: 1 watt. For all other frequency hopping systems in the 2400-2483.5 MHz band 0.125 watts. The power limit for 1Mbps, 2Mbps, 3Mbps and AFH modes are 0.125 watts.

3.1.2 Measuring Instruments

See list of measuring equipment of this test report.

3.1.3 Test Procedures

1. The testing follows ANSI C63.10-2013 clause 7.8.5.
1. The RF output of EUT was connected to the power meter by RF cable and attenuator. The path loss was compensated to the results for each measurement.
2. Set to the maximum power setting and enable the EUT transmit continuously.
3. Measure the conducted output power with cable loss and record the results in the test report.
4. Measure and record the results in the test report.

3.1.4 Test Setup

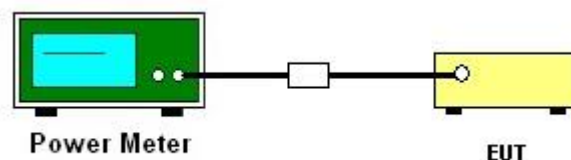



3.1.5 Test Result of Peak Output Power

Test Engineer :		CreedWu		Temperature :	21~25°C
				Relative Humidity :	51~54%

DH	CH.	N _{TX}	Peak Power (dBm)	Power Limit (dBm)	Test Result
DH5	0	1	8.80	20.97	Pass
	39	1	10.40	20.97	Pass
	78	1	9.11	20.97	Pass

2DH	CH.	N _{TX}	Peak Power (dBm)	Power Limit (dBm)	Test Result
2DH5	0	1	7.31	20.97	Pass
	39	1	8.34	20.97	Pass
	78	1	6.85	20.97	Pass

3DH	CH.	N _{TX}	Peak Power (dBm)	Power Limit (dBm)	Test Result
3DH5	0	1	6.73	20.97	Pass
	39	1	7.80	20.97	Pass
	78	1	6.47	20.97	Pass

3.1.6 Test Result of Average Output Power (Reporting Only)

Test Engineer :		CreedWu		Temperature :	21~25°C
				Relative Humidity :	51~54%

DH	CH.	N _{TX}	Average Power (dBm)	Duty Factor (dB)
DH5	0	1	8.76	5.16
	39	1	10.37	5.16
	78	1	9.11	5.16

2DH	CH.	N _{TX}	Average Power (dBm)	Duty Factor (dB)
2DH5	0	1	5.24	1.13
	39	1	6.30	1.13
	78	1	4.69	1.13

3DH	CH.	N _{TX}	Average Power (dBm)	Duty Factor (dB)
3DH5	0	1	4.37	1.16
	39	1	5.46	1.16
	78	1	4.07	1.16



3.2 Radiated Band Edges and Spurious Emission Measurement

3.2.1 Limit of Radiated Band Edges and Spurious Emission

In any 100 kHz bandwidth outside the intentional radiator frequency band, all harmonics/spurious must be at least 20 dB below the highest emission level within the authorized band. In addition, radiated emissions which fall in the restricted bands must also comply with the limits as below.

Frequency (MHz)	Field Strength (microvolts/meter)	Measurement Distance (meters)
0.009 – 0.490	2400/F(kHz)	300
0.490 – 1.705	24000/F(kHz)	30
1.705 – 30.0	30	30
30 – 88	100	3
88 – 216	150	3
216 - 960	200	3
Above 960	500	3

3.2.2 Measuring Instruments

See list of measuring equipment of this test report.

**3.2.3 Test Procedures**

1. The EUT was placed on a turntable with 1.5 meter for frequency above 1GHz respectively above ground.
2. The EUT was set 3 meters from the interference receiving antenna, which was mounted on the top of a variable height antenna tower.
3. For each suspected emission, the EUT was arranged to its worst case and then tune the Antenna tower (from 1 m to 4 m) and turntable (from 0 degree to 360 degrees) to find the maximum reading. A pre-amp and a high pass filter are used for the test in order to get better signal level to comply with the guidelines.
4. Set to the maximum power setting and enable the EUT transmit continuously.
5. Use the following spectrum analyzer settings:
 - (1) Span shall wide enough to fully capture the emission being measured;
 - (2) Set RBW=1MHz for $f > 1\text{GHz}$; $\text{VBW} \geq \text{RBW}$; Sweep = auto; Detector function = peak; Trace = max hold for peak
 - (3) For average measurement: use duty cycle correction factor method per 15.35(c).
Duty cycle = On time/100 milliseconds
On time = $N_1 * L_1 + N_2 * L_2 + \dots + N_{n-1} * L_{n-1} + N_n * L_n$
Where N_1 is number of type 1 pulses, L_1 is length of type 1 pulses, etc.
Average Emission Level = Peak Emission Level + $20 * \log(\text{Duty cycle})$
6. Corrected Reading: Antenna Factor + Cable Loss + Read Level - Preamp Factor = Level
7. For testing above 1GHz, the emission level of the EUT in peak mode was 20dB lower than average limit (that means the emission level in average mode also complies with the limit in average mode), then peak values of EUT will be reported, otherwise, the emissions will be measured in average mode again and reported.

Note: The average levels were calculated from the peak level corrected with duty cycle correction factor (-24.79dB) derived from $20 \log(\text{dwell time}/100\text{ms})$. This correction is only for signals that hop with the fundamental signal, such as band-edge and harmonic. Other spurious signals that are independent of the hopping signal would not use this correction.

3.2.4 Test Setup

For radiated emissions above 1GHz

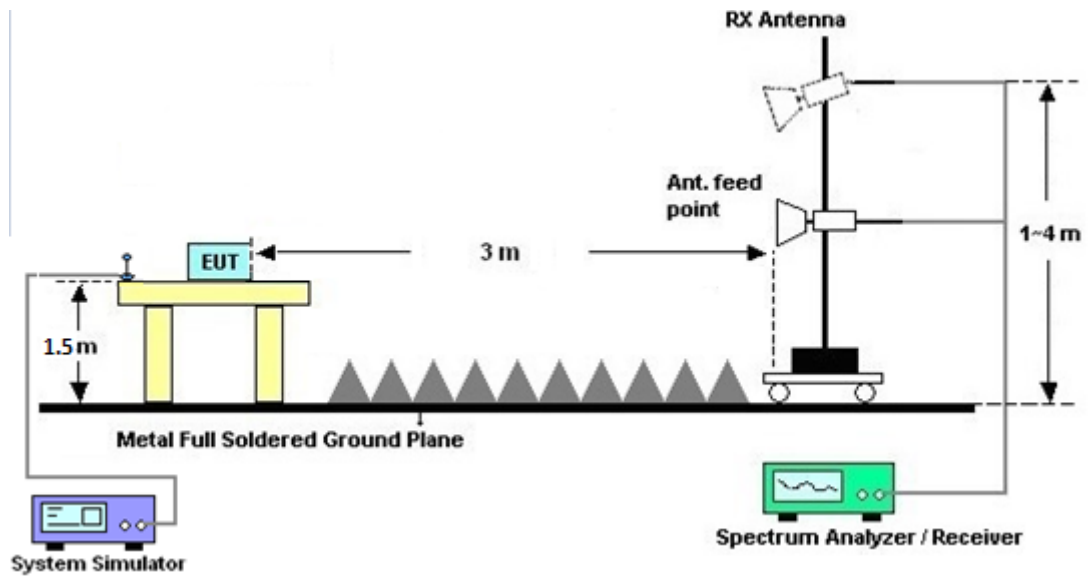

3.2.5 Test Result of Radiated Spurious at Band Edges

Please refer to Appendix A and B.

3.2.6 Duty Cycle

Please refer to Appendix C.

3.2.7 Test Result of Radiated Spurious Emission (Harmonic)

Please refer to Appendix A and B.



3.3 Antenna Requirements

3.3.1 Standard Applicable

If directional gain of transmitting antennas is greater than 6dBi, the power shall be reduced by the same level in dB comparing to gain minus 6dBi. The use of a permanently attached antenna or of an antenna that uses a unique coupling to the intentional radiator shall be considered sufficient to comply with the rule.

3.3.2 Antenna Anti-Replacement Construction

An embedded-in antenna design is used.

3.3.3 Antenna Gain

The antenna peak gain of EUT is less than 6 dBi. Therefore, it is not necessary to reduce maximum peak output power limit.



4 List of Measuring Equipment

Instrument	Manufacturer	Model No.	Serial No.	Characteristics	Calibration Date	Test Date	Due Date	Remark
Power Meter	Agilent	E4416A	GB412923 44	N/A	Dec. 27, 2018	Jul. 09, 2019	Dec. 26, 2019	Conducted (TH05-HY)
Power Sensor	Agilent	E9327A	US404415 48	50MHz~18GHz	Dec. 27, 2018	Jul. 09, 2019	Dec. 26, 2019	Conducted (TH05-HY)
Spectrum Analyzer	Rohde & Schwarz	FSP40	100057	9kHz-40GHz	Nov. 21, 2018	Jul. 09, 2019	Nov. 20, 2019	Conducted (TH05-HY)
Spectrum Analyzer	Rohde & Schwarz	FSV 40	101408	10Hz~40GHz	Jul. 30, 2018	Jul. 09, 2019	Jul. 29, 2019	Conducted (TH05-HY)
BT Base Station (Measure)	Rohde & Schwarz	CBT	101136	BT 3.0	Sep. 26, 2018	Jul. 09, 2019	Sep. 25, 2019	Conducted (TH05-HY)
Switch Box & RF Cable	Burgeon	ETF-058	EC120838 2	N/A	Mar. 27, 2019	Jul. 09, 2019	Mar. 26, 2020	Conducted (TH05-HY)
Bilog Antenna	TESEQ	CBL 6111D & 00800N1D01 N-06	35419 & 03	30MHz~1GHz	Apr. 30, 2019	Jul. 15, 2019 ~ Jul. 16, 2019	Apr. 29, 2020	Radiation (03CH07-HY)
Double Ridge Horn Antenna	ESCO	3117	00075962	1GHz ~ 18GHz	Dec. 02, 2018	Jul. 15, 2019 ~ Jul. 16, 2019	Dec. 03, 2019	Radiation (03CH07-HY)
EMI Test Receiver	Agilent	N9038A(MXE)	MY532900 53	20Hz~26.5GHz	Jan. 23, 2019	Jul. 15, 2019 ~ Jul. 16, 2019	Jan. 22, 2020	Radiation (03CH07-HY)
Loop Antenna	Rohde & Schwarz	HFH2-Z2	100315	9 kHz~30 MHz	Jan. 11, 2019	Jul. 15, 2019 ~ Jul. 16, 2019	Jan. 10, 2020	Radiation (03CH07-HY)
Preamplifier	MITEQ	AMF-7D-0010 1800-30-10P	1590075	1GHz~18GHz	Apr. 24, 2019	Jul. 15, 2019 ~ Jul. 16, 2019	Apr. 23, 2020	Radiation (03CH07-HY)
Preamplifier	COM-POWER	PA-103A	161241	10MHz~1GHz	May 20, 2019	Jul. 15, 2019 ~ Jul. 16, 2019	May 19, 2020	Radiation (03CH07-HY)
Preamplifier	Agilent	8449B	3008A023 62	1GHz~26.5GHz	Nov. 02, 2018	Jul. 15, 2019 ~ Jul. 16, 2019	Nov. 01, 2019	Radiation (03CH07-HY)
Filter	Microwave	H1G013G1	SN477215	1GHz High Pass Filter	Nov. 02, 2018	Jul. 15, 2019 ~ Jul. 16, 2019	Nov. 01, 2019	Radiation (03CH07-HY)
Filter	Wainwright	WLKS1200-8 SS	SN3	1.2GHz Low Pass Filter	Nov. 02, 2018	Jul. 15, 2019 ~ Jul. 16, 2019	Nov. 01, 2019	Radiation (03CH07-HY)
Filter	Microwave	H3G018G1	SN477220	3GHz High Pass Filter	Nov. 02, 2018	Jul. 15, 2019 ~ Jul. 16, 2019	Nov. 01, 2019	Radiation (03CH07-HY)



Instrument	Manufacturer	Model No.	Serial No.	Characteristics	Calibration Date	Test Date	Due Date	Remark
RF Cable	HUBER + SUHNER	SUCOFLEX 104	MY24971/4, MY28655/4	9kHz~30MHz	Feb. 26, 2019	Jul. 15, 2019 ~ Jul. 16, 2019	Feb. 25, 2020	Radiation (03CH07-HY)
RF Cable	HUBER + SUHNER	SUCOFLEX 104	MY28655/4, MY24971/4, MY15682/4	30MHz~1GHz	Feb. 26, 2019	Jul. 15, 2019 ~ Jul. 16, 2019	Feb. 25, 2020	Radiation (03CH07-HY)
RF Cable	HUBER + SUHNER	SUCOFLEX 104	MY28655/4, MY24971/4, MY15682/4	1GHz~18GHz	Feb. 26, 2019	Jul. 15, 2019 ~ Jul. 16, 2019	Feb. 25, 2020	Radiation (03CH07-HY)
RF Cable	HUBER + SUHNER	SUCOFLEX 102	MY2858/2	18GHz~40GHz	Feb. 26, 2019	Jul. 15, 2019 ~ Jul. 16, 2019	Feb. 25, 2020	Radiation (03CH07-HY)
Antenna Mast	Max-Full	MFA520BS	N/A	1m~4m	N/A	Jul. 15, 2019 ~ Jul. 16, 2019	N/A	Radiation (03CH07-HY)
Turn Table	ChainTek	Chaintek 3000	N/A	0~360 Degree	N/A	Jul. 15, 2019 ~ Jul. 16, 2019	N/A	Radiation (03CH07-HY)
Preamplifier	MITEQ	TTA1840-35-HG	1871923	18GHz~40GHz, VSWR : 2.5:1 max	N/A	Jul. 15, 2019 ~ Jul. 16, 2019	N/A	Radiation (03CH07-HY)
SHF-EHF Horn Antenna	SCHWARZBECK	BBHA 9170	BBHA917025 1	18GHz~40GHz	Nov. 20, 2018	Jul. 15, 2019 ~ Jul. 16, 2019	Nov. 19, 2019	Radiation (03CH07-HY)
Spectrum Analyzer	Agilent	N9010A	MY53470118	10Hz~44GHz	Apr. 18, 2019	Jul. 15, 2019 ~ Jul. 16, 2019	Apr. 17, 2020	Radiation (03CH07-HY)
Software	Audix	E3 6.2009-8-24	80504004656 H	N/A	N/A		N/A	Radiation (03CH07-HY)



5 Uncertainty of Evaluation

Uncertainty of Radiated Emission Measurement (30 MHz ~ 1000 MHz)

Measuring Uncertainty for a Level of Confidence of 95% ($U = 2Uc(y)$)	5.7
---	-----

Uncertainty of Radiated Emission Measurement (1000 MHz ~ 18000 MHz)

Measuring Uncertainty for a Level of Confidence of 95% ($U = 2Uc(y)$)	5.5
---	-----

Uncertainty of Radiated Emission Measurement (18000 MHz ~ 40000 MHz)

Measuring Uncertainty for a Level of Confidence of 95% ($U = 2Uc(y)$)	5.2
---	-----



Appendix A. Radiated Spurious Emission

Test Engineer :	Stan Hsieh and KenWu	Temperature :	28.2~28.3°C
		Relative Humidity :	50~53%

2.4GHz 2400~2483.5MHz

BT (Band Edge @ 3m)

BT	Note	Frequency (MHz)	Level (dBμV/m)	Over Limit (dB)	Limit Line (dBμV/m)	Read Level (dBμV)	Antenna Factor (dB/m)	Path Loss (dB)	Preamp Factor (dB)	Ant Pos (cm)	Table Pos (deg)	Peak Avg. (P/A)	Pol. (H/V)	
BT CH 78 2480MHz	*	2480	106.27	-	-	101.2	32.2	7.84	34.97	360	308	P	H	
	*	2480	81.48	-	-	-	-	-	-	-	-	A	H	
		2490.08	58.15	-15.85	74	53.08	32.2	7.84	34.97	360	308	P	H	
		2490.08	33.36	-20.64	54	-	-	-	-	-	-	A	H	
													H	
														H
	*	2480	104.32	-	-	99.25	32.2	7.84	34.97	100	278	P	V	
	*	2480	79.53	-	-	-	-	-	-	-	-	-	A	V
		2489.92	56.88	-17.12	74	51.81	32.2	7.84	34.97	100	278	P	V	
		2489.92	32.09	-21.91	54	-	-	-	-	-	-	A	V	
														V
													V	
Remark	1. No other spurious found. 2. All results are PASS against Peak and Average limit line.													



2.4GHz 2400~2483.5MHz

BT (Harmonic @ 3m)

BT	Note	Frequency (MHz)	Level (dBµV/m)	Over Limit (dB)	Limit Line (dBµV/m)	Read Level (dBµV)	Antenna Factor (dB/m)	Path Loss (dB)	Preamp Factor (dB)	Ant Pos (cm)	Table Pos (deg)	Peak Avg. (P/A)	Pol. (H/V)
BT CH 78 2480MHz		4960	42.01	-31.99	74	55.14	34.13	11.48	58.74	100	0	P	H
		4960	17.22	-36.78	54	-	-	-	-	-	-	A	H
		7440	43.95	-30.05	74	52.74	35.5	14.09	58.38	100	0	P	H
		7440	19.16	-34.84	54	-	-	-	-	-	-	A	H
		4960	41.94	-32.06	74	55.07	34.13	11.48	58.74	100	0	P	V
		4960	17.15	-36.85	54	-	-	-	-	-	-	A	V
		7440	44.58	-29.42	74	53.37	35.5	14.09	58.38	100	0	P	V
		7440	19.79	-34.21	54	-	-	-	-	-	-	A	V
Remark	1. No other spurious found. 2. All results are PASS against Peak and Average limit line.												



Note symbol

*	Fundamental Frequency which can be ignored. However, the level of any unwanted emissions shall not exceed the level of the fundamental frequency.
!	Test result is over limit line.
P/A	Peak or Average
H/V	Horizontal or Vertical



A calculation example for radiated spurious emission is shown as below:

BT	Note	Frequency	Level	Over	Limit	Read	Antenna	Path	Preamp	Ant	Table	Peak	Pol.
		(MHz)	(dBμV/m)	(dB)	Limit Line	Level	Factor	Loss	Factor	Pos	Pos	Avg.	
					(dBμV/m)	(dBμV)	(dB/m)	(dB)	(dB)	(cm)	(deg)	(P/A)	(H/V)
BT		2390	55.45	-18.55	74	54.51	32.22	4.58	35.86	103	308	P	H
CH 00		2390	43.54	-10.46	54	42.6	32.22	4.58	35.86	103	308	A	H
2402MHz													

1. Path Loss(dB) = Cable loss(dB) + Filter loss(dB) + Attenuator loss(dB)
2. Level(dBμV/m) =
Antenna Factor(dB/m) + Path Loss(dB) + Read Level(dBμV) - Preamp Factor(dB)
3. Over Limit(dB) = Level(dBμV/m) – Limit Line(dBμV/m)

For Peak Limit @ 2390MHz:

1. Level(dBμV/m)
= Antenna Factor(dB/m) + Path Loss(dB) + Read Level(dBμV) - Preamp Factor(dB)
= 32.22(dB/m) + 4.58(dB) + 54.51(dBμV) – 35.86 (dB)
= 55.45 (dBμV/m)
2. Over Limit(dB)
= Level(dBμV/m) – Limit Line(dBμV/m)
= 55.45(dBμV/m) – 74(dBμV/m)
= -18.55(dB)

For Average Limit @ 2390MHz:

1. Level(dBμV/m)
= Antenna Factor(dB/m) + Path Loss(dB) + Read Level(dBμV) - Preamp Factor(dB)
= 32.22(dB/m) + 4.58(dB) + 42.6(dBμV) – 35.86 (dB)
= 43.54 (dBμV/m)
2. Over Limit(dB)
= Level(dBμV/m) – Limit Line(dBμV/m)
= 43.54(dBμV/m) – 54(dBμV/m)
= -10.46(dB)

Both peak and average measured complies with the limit line, so test result is “PASS”.



Appendix B. Radiated Spurious Emission Plots

Test Engineer :	Stan Hsieh and KenWu	Temperature :	28.2~28.3°C
		Relative Humidity :	50~53%

Note symbol

-L	Low channel location
-R	High channel location



2.4GHz 2400~2483.5MHz

BT (Band Edge @ 3m)

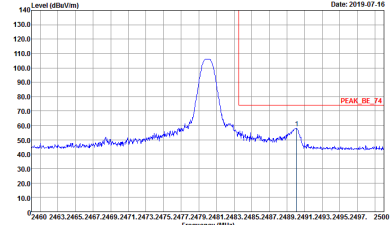
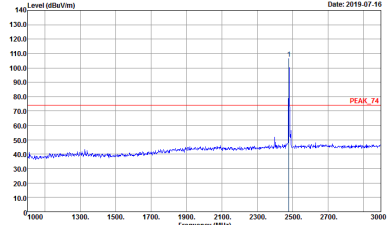
BT	2.4GHz 2400~2483.5MHz Band Edge @ 3m	
BT CH78 2480MHz		
Horizontal		Fundamental
Peak	 <p>Date: 2019-07-16</p> <p>Site : 03CH07-HY Condition : PEAK_BE_74 3m HF_ANT_00075962 HORIZONTAL RBW:1000.000KHz VBW:3000.000KHz SWT:Auto Detector : Peak Project : 962046 Mode : 1</p>	 <p>Date: 2019-07-16</p> <p>Site : 03CH07-HY Condition : PEAK_74 3m HE_ANT_00075962 HORIZONTAL RBW:1000.000KHz VBW:3000.000KHz SWT:Auto Detector : Peak Project : 962046 Mode : 1</p>

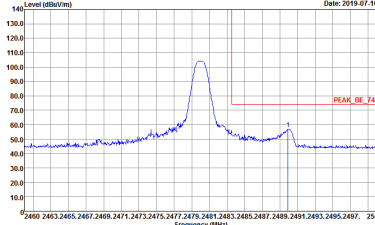
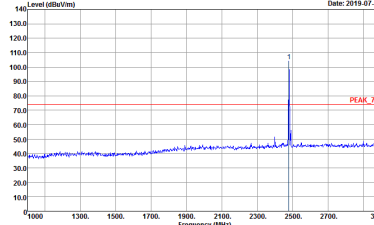

BT	2.4GHz 2400~2483.5MHz Band Edge @ 3m	
BT CH78 2480MHz		
	Vertical	Fundamental
Peak	 <p>Date: 2019-07-16</p> <p>PEAK_BE_74</p> <p>Site : 03CH07-HY Condition : PEAK_BE_74 3m HF_ANT_00075962 VERTICAL Detector : Peak Project : 962046 Mode : 1</p>	 <p>Date: 2019-07-16</p> <p>PEAK_74</p> <p>Site : 03CH07-HY Condition : PEAK_74 3m HF_ANT_00075962 VERTICAL Detector : Peak Project : 962046 Mode : 1</p>



2.4GHz 2400~2483.5MHz

BT (Harmonic @ 3m)

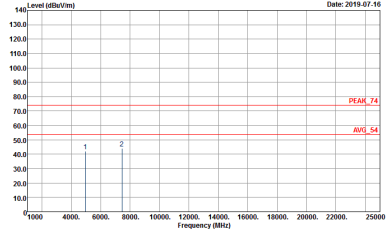
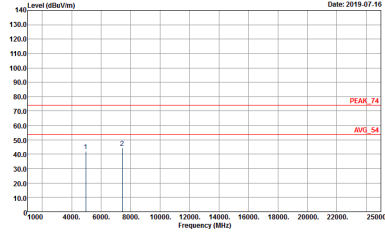
BT	2.4GHz 2400~2483.5MHz Harmonic @ 3m	
	BT CH78 2480MHz	
	Horizontal	Vertical
Peak Avg.	 <p>Site : 03CH07-HY Condition : PEAK_74 3m SHF-EHF_131029 HORIZONTAL Detector : Peak Project : 962046 Mode : 1</p>	 <p>Site : 03CH07-HY Condition : PEAK_74 3m SHF-EHF_131029 VERTICAL Detector : Peak Project : 962046 Mode : 1</p>

Appendix C. Duty Cycle Plots

DH5 on time (One Pulse) Plot on Channel 39

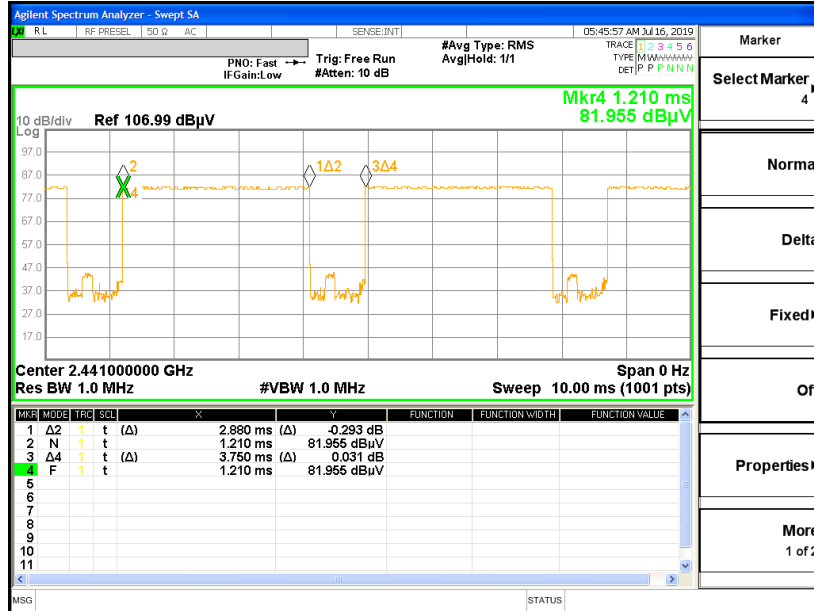

on time (Count Pulses) Plot on Channel 39

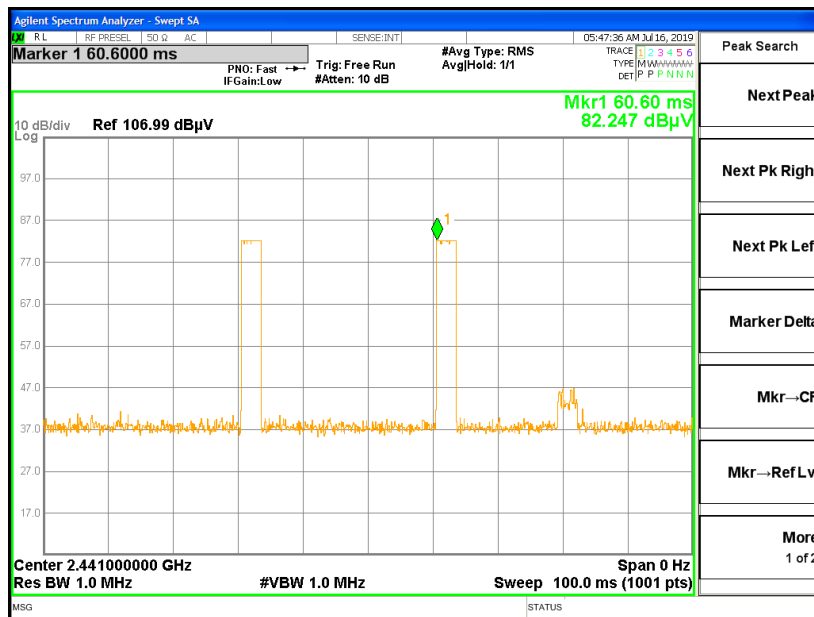

Note:

1. Worst case Duty cycle = on time/100 milliseconds = $2 * 2.88 / 100 = 5.76 \%$
2. Worst case Duty cycle correction factor = $20 * \log(\text{Duty cycle}) = -24.79 \text{ dB}$
3. **DH5** has the highest duty cycle worst case and is reported.



Duty Cycle Correction Factor Consideration for AFH mode:

Bluetooth normal hopping rate is 1600Hz and reduced to 800Hz in AFH mode; due to the reduced number of hopping frequencies, with the same packet configuration the dwell time in each channel frequency within 100msec period is longer in AFH mode than normal mode.

In AFH mode, the minimum hopping frequencies are 20, to get the longest dwell time DH5 packet is observed; the period to have DH5 packet completing one hopping sequence is

$$2.88 \text{ ms} \times 20 \text{ channels} = 57.6 \text{ ms}$$

There cannot be 2 complete hopping sequences within 100ms period, considering the random hopping behavior, maximum 2 hops can be possibly observed within the period. $[100\text{ms} / 57.6\text{ms}] = 2$ hops

Thus, the maximum possible ON time:

$$2.88 \text{ ms} \times 2 = 5.76 \text{ ms}$$

Worst case Duty Cycle Correction factor, which is derived from the maximum possible ON time,

$$20 \times \log(5.76 \text{ ms}/100\text{ms}) = -24.79 \text{ dB}$$



Appendix E. Original Report

Please refer to Sporton report number FR910212A as below.



FCC RADIO TEST REPORT

FCC ID : 2ABVH-INARI10B1
Equipment : Tablet
Brand Name : AAVA
Model Name : INARI10B-WIG-1
Applicant : Aava Mobile Oy
NAHKATEHTAANKATU 2 90130 OULU FINLAND
Manufacturer : Aava Mobile Oy
NAHKATEHTAANKATU 2 90130 OULU FINLAND
Standard : FCC Part 15 Subpart C §15.247

The product was received on Dec. 24, 2018 and testing was started from Jan. 10, 2019 and completed on Jan. 21, 2019. We, SPORTON INTERNATIONAL INC. EMC & Wireless Communications Laboratory, would like to declare that the tested sample has been evaluated in accordance with the test procedures and has been in compliance with the applicable technical standards.

The report must not be used by the client to claim product certification, approval, or endorsement by TAF or any agency of government.

The test results in this report apply exclusively to the tested model / sample. Without written approval of SPORTON INTERNATIONAL INC. EMC & Wireless Communications Laboratory, the test report shall not be reproduced except in full.

Reviewed by: Jones Tsai

SPORTON INTERNATIONAL INC. EMC & Wireless Communications Laboratory

No. 52, Huaya 1st Rd., Guishan Dist., Taoyuan City, Taiwan (R.O.C.)



Table of Contents

History of this test report.....	3
Summary of Test Result.....	4
1 General Description.....	5
1.1 Product Feature of Equipment Under Test.....	5
1.2 Product Specification of Equipment Under Test.....	5
1.3 Modification of EUT	5
1.4 Testing Location	6
1.5 Applicable Standards.....	6
2 Test Configuration of Equipment Under Test.....	7
2.1 Carrier Frequency Channel	7
2.2 Test Mode.....	8
2.3 Connection Diagram of Test System.....	11
2.4 Support Unit used in test configuration and system	12
2.5 EUT Operation Test Setup	12
2.6 Measurement Results Explanation Example.....	12
3 Test Result.....	13
3.1 Number of Channel Measurement	13
3.2 Hopping Channel Separation Measurement	15
3.3 Dwell Time Measurement.....	21
3.4 20dB and 99% Bandwidth Measurement	23
3.5 Output Power Measurement.....	34
3.6 Conducted Band Edges Measurement.....	36
3.7 Conducted Spurious Emission Measurement	43
3.8 Radiated Band Edges and Spurious Emission Measurement	53
3.9 AC Conducted Emission Measurement.....	57
3.10 Antenna Requirements.....	59
4 List of Measuring Equipment	60
5 Uncertainty of Evaluation.....	61
Appendix A. AC Conducted Emission Test Result	
Appendix B. Radiated Spurious Emission	
Appendix C. Radiated Spurious Emission Plots	
Appendix D. Duty Cycle Plots	
Appendix E. Setup Photographs	



History of this test report

Report No.	Version	Description	Issued Date
FR910212A	01	Initial issue of report	Feb. 25, 2019



Summary of Test Result

Report Clause	Ref Std. Clause	Test Items	Result (PASS/FAIL)	Remark
3.1	15.247(a)(1)	Number of Channels	Pass	-
3.2	15.247(a)(1)	Hopping Channel Separation	Pass	-
3.3	15.247(a)(1)	Dwell Time of Each Channel	Pass	-
3.4	15.247(a)(1)	20dB Bandwidth	Pass	-
3.4	2.1049	99% Occupied Bandwidth	Reporting only	-
3.5	15.247(b)(1)	Peak Output Power	Pass	-
3.6	15.247(d)	Conducted Band Edges	Pass	-
3.7	15.247(d)	Conducted Spurious Emission	Pass	-
3.8	15.247(d)	Radiated Band Edges and Radiated Spurious Emission	Pass	Under limit 12.37 dB at 39.180 MHz
3.9	15.207	AC Conducted Emission	Pass	Under limit 14.08 dB at 0.701 MHz
3.10	15.203 & 15.247(b)	Antenna Requirement	Pass	-

Declaration of Conformity:

The test results with all measurement uncertainty excluded are presented in accordance with the regulation limits or requirements declared by manufacturers.

Comments and Explanations:

The declared of product specification for EUT presented in the report are provided by the manufacturer, and the manufacturer takes all the responsibilities for the accuracy of product specification.

Reviewed by: Wii Chang

Report Producer: Polly Tsai



1 General Description

1.1 Product Feature of Equipment Under Test

Product Feature	
Equipment	Tablet
Brand Name	AAVA
Model Name	INARI10B-WIG-1
FCC ID	2ABVH-INARI10B1
EUT supports Radios application	NFC/GNSS WLAN 11a/b/g/n HT20/HT40 WLAN 11ac VHT20/VHT40/VHT80 Bluetooth BR/EDR/LE
HW Version	DV1
SW Version	Windows 10
EUT Stage	Identical Prototype

Remark: The above EUT's information was declared by manufacturer.

Specification of Accessories				
AC Adapter	Brand Name	PHIHONG	Model Name	AQ18A-59CFA
Battery	Brand Name	Etica Battery	Model Name	AMME3950
USB Cable	Brand Name	PHIHONG	Model Name	UES-1001A160-R

1.2 Product Specification of Equipment Under Test

Standards-related Product Specification	
Tx/Rx Frequency Range	2402 MHz ~ 2480 MHz
Number of Channels	79
Carrier Frequency of Each Channel	2402+n*1 MHz; n=0~78
Maximum Output Power to Antenna	Bluetooth BR(1Mbps) : 10.24 dBm (0.0106 W) Bluetooth EDR (2Mbps) : 8.63 dBm (0.0073 W) Bluetooth EDR (3Mbps) : 8.09 dBm (0.0064 W)
99% Occupied Bandwidth	Bluetooth BR(1Mbps) : 0.844MHz Bluetooth EDR (2Mbps) : 1.336MHz Bluetooth EDR (3Mbps) : 1.340MHz
Antenna Type / Gain	Ceramic Antenna type with gain 1.00 dBi
Type of Modulation	Bluetooth BR (1Mbps) : GFSK Bluetooth EDR (2Mbps) : π /4-DQPSK Bluetooth EDR (3Mbps) : 8-DPSK

1.3 Modification of EUT

No modifications are made to the EUT during all test items.



1.4 Testing Location

Test Site	SPORTON INTERNATIONAL INC.	
Test Site Location	No.52, Huaya 1st Rd., Guishan Dist., Taoyuan City, Taiwan (R.O.C.) TEL: +886-3-327-3456 FAX: +886-3-328-4978	
Test Site No.	Sporton Site No.	
	TH05-HY	CO05-HY

Note: The test site complies with ANSI C63.4 2014 requirement.

Test Site	SPORTON INTERNATIONAL INC.	
Test Site Location	No.58, Aly. 75, Ln. 564, Wenhua 3rd, Rd., Guishan Dist., Taoyuan City, Taiwan (R.O.C.) TEL: +886-3-327-0868 FAX: +886-3-327-0855	
Test Site No.	Sporton Site No.	
	03CH16-HY	

Note: The test site complies with ANSI C63.4 2014 requirement.

FCC Designation No. TW1190 and TW0007

1.5 Applicable Standards

According to the specifications of the manufacturer, the EUT must comply with the requirements of the following standards:

- ♦ FCC Part 15 Subpart C §15.247
- ♦ FCC KDB Publication No. 558074 D01 DTS Meas. Guidance v05
- ♦ FCC KDB 414788 D01 Radiated Test Site v01r01.
- ♦ ANSI C63.10-2013

Remark:

1. All test items were verified and recorded according to the standards and without any deviation during the test.
2. This EUT has also been tested and complied with the requirements of FCC Part 15, Subpart B, recorded in a separate test report.



2 Test Configuration of Equipment Under Test

2.1 Carrier Frequency Channel

Frequency Band	Channel	Freq. (MHz)	Channel	Freq. (MHz)	Channel	Freq. (MHz)
2400-2483.5 MHz	0	2402	27	2429	54	2456
	1	2403	28	2430	55	2457
	2	2404	29	2431	56	2458
	3	2405	30	2432	57	2459
	4	2406	31	2433	58	2460
	5	2407	32	2434	59	2461
	6	2408	33	2435	60	2462
	7	2409	34	2436	61	2463
	8	2410	35	2437	62	2464
	9	2411	36	2438	63	2465
	10	2412	37	2439	64	2466
	11	2413	38	2440	65	2467
	12	2414	39	2441	66	2468
	13	2415	40	2442	67	2469
	14	2416	41	2443	68	2470
	15	2417	42	2444	69	2471
	16	2418	43	2445	70	2472
	17	2419	44	2446	71	2473
	18	2420	45	2447	72	2474
	19	2421	46	2448	73	2475
	20	2422	47	2449	74	2476
	21	2423	48	2450	75	2477
	22	2424	49	2451	76	2478
	23	2425	50	2452	77	2479
	24	2426	51	2453	78	2480
	25	2427	52	2454	-	-
	26	2428	53	2455	-	-



2.2 Test Mode

Channel	Frequency	Bluetooth Average Output Power		
		GFSK / 1Mbps		
		DH1	DH3	DH5
Ch00	2402MHz	9.71 dBm	9.70 dBm	9.57 dBm
Ch39	2441MHz	10.18 dBm	10.16 dBm	10.12 dBm
Ch78	2480MHz	8.80 dBm	8.74 dBm	8.72 dBm

Channel	Frequency	Bluetooth Average Output Power		
		$\pi/4$ -DQPSK / 2Mbps		
		2DH1	2DH3	2DH5
Ch00	2402MHz	6.22 dBm	6.20 dBm	6.18 dBm
Ch39	2441MHz	6.59 dBm	6.57 dBm	6.55 dBm
Ch78	2480MHz	5.02 dBm	5.01 dBm	4.99 dBm

Channel	Frequency	Bluetooth Average Output Power		
		8-DPSK / 3Mbps		
		3DH1	3DH3	3DH5
Ch00	2402MHz	5.32 dBm	5.29 dBm	5.26 dBm
Ch39	2441MHz	5.70 dBm	5.69 dBm	5.68 dBm
Ch78	2480MHz	4.15 dBm	4.14 dBm	4.11 dBm

Channel	Frequency	Bluetooth Peak Output Power		
		GFSK / 1Mbps		
		DH1	DH3	DH5
Ch00	2402MHz	9.78 dBm	9.77 dBm	9.76 dBm
Ch39	2441MHz	10.24 dBm	10.22 dBm	10.21 dBm
Ch78	2480MHz	8.87 dBm	8.85 dBm	8.84 dBm

Channel	Frequency	Bluetooth Peak Output Power		
		$\pi/4$ -DQPSK / 2Mbps		
		2DH1	2DH3	2DH5
Ch00	2402MHz	8.27 dBm	8.26 dBm	8.18 dBm
Ch39	2441MHz	8.63 dBm	8.62 dBm	8.60 dBm
Ch78	2480MHz	7.17 dBm	7.16 dBm	7.15 dBm

Channel	Frequency	Bluetooth Peak Output Power		
		8-DPSK / 3Mbps		
		3DH1	3DH3	3DH5
Ch00	2402MHz	7.70 dBm	7.68 dBm	7.65 dBm
Ch39	2441MHz	8.09 dBm	8.08 dBm	8.05 dBm
Ch78	2480MHz	6.65 dBm	6.63 dBm	6.30 dBm

Remark:The data rate was set in 1Mbps for all the test items due to the highest RF output power.

- a. The EUT has been associated with peripherals and configuration operated in a manner tended to maximize its emission characteristics in a typical application. Frequency range investigated: conduction emission (150 kHz to 30 MHz), radiation emission (9 kHz to the 10th harmonic of the highest fundamental frequency or to 40 GHz, whichever is lower). For radiated measurement, pre-scanned in three orthogonal panels, X, Y, Z. The worst cases (X plane) were recorded in this report, and the worst mode of radiated spurious emissions is Bluetooth 1Mbps mode, and recorded in this report.
- b. AC power line Conducted Emission was tested under maximum output power.



The following summary table is showing all test modes to demonstrate in compliance with the standard.

Summary table of Test Cases			
Test Item	Data Rate / Modulation		
	Bluetooth BR 1Mbps GFSK	Bluetooth EDR 2Mbps $\pi/4$ -DQPSK	Bluetooth EDR 3Mbps 8-DPSK
Conducted Test Cases	Mode 1: CH00_2402 MHz Mode 2: CH39_2441 MHz Mode 3: CH78_2480 MHz	Mode 4: CH00_2402 MHz Mode 5: CH39_2441 MHz Mode 6: CH78_2480 MHz	Mode 7: CH00_2402 MHz Mode 8: CH39_2441 MHz Mode 9: CH78_2480 MHz
Radiated Test Cases	Bluetooth BR 1Mbps GFSK		
	Mode 1: CH00_2402 MHz Mode 2: CH39_2441 MHz Mode 3: CH78_2480 MHz		
AC Conducted Emission	Mode 1: WLAN (2.4GHz) Link + Bluetooth Link + USB Cable (Type C) + Adapter + GPS Rx + NFC On		
Remark: For radiated test cases, the worst mode data rate 1Mbps was reported only since the highest RF output power in the preliminary tests. The conducted spurious emissions and conducted band edge measurement for other data rates were not worse than 1Mbps, and no other significantly frequencies found in conducted spurious emission.			

2.3 Connection Diagram of Test System

<Bluetooth Tx Mode>

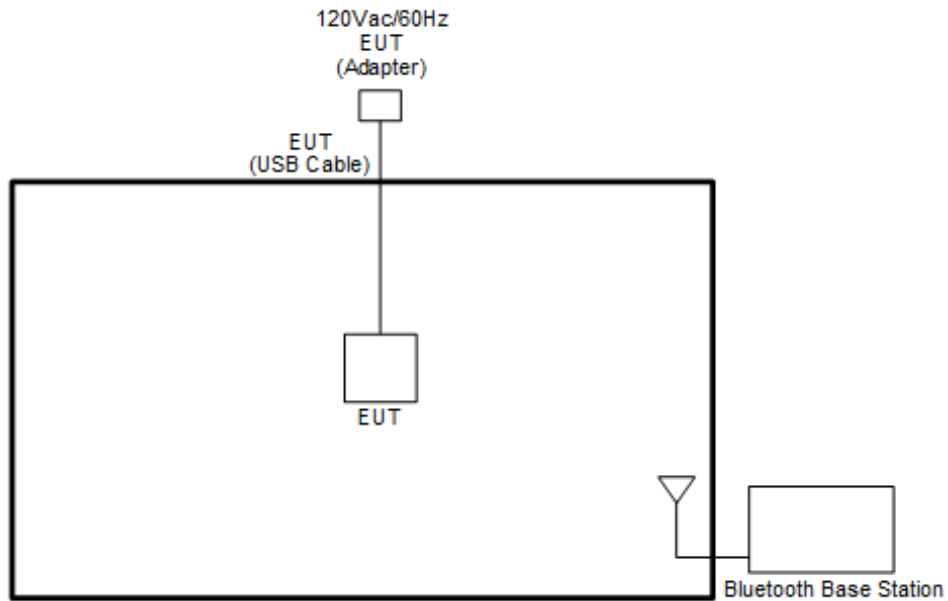

<AC Conducted Emission Mode>

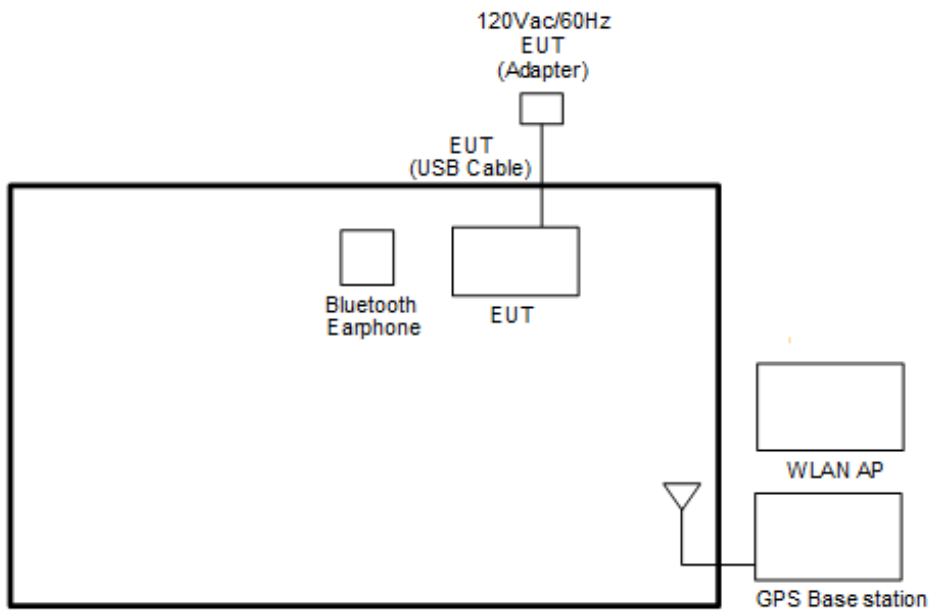

2.4 Support Unit used in test configuration and system

Item	Equipment	Trade Name	Model Name	FCC ID	Data Cable	Power Cord
1.	Bluetooth Base Station	R&S	CBT32	N/A	N/A	Unshielded, 1.8 m
2.	GPS Station	Pendulum	GSG-54	N/A	N/A	Unshielded, 1.8 m
3.	WLAN AP	ASUS	RT-AC66U	MSQ-RTAC66U	N/A	Unshielded, 1.8 m
4.	Bluetooth Earphone	Sony Ericsson	MW600	PY7DDA-2029	N/A	N/A
5.	SD Card	SanDisk	MicroSD HC	FCC DoC	N/A	N/A

2.5 EUT Operation Test Setup

The RF test items, utility “DRTU” was installed in EUT which was programmed in order to make the EUT get into the engineering modes to contact with base station to provide channel selection, power level, data rate and the application type and for continuous transmitting signals.

2.6 Measurement Results Explanation Example

For all conducted test items:

The offset level is set in the spectrum analyzer to compensate the RF cable loss and attenuator factor between EUT conducted output port and spectrum analyzer. With the offset compensation, the spectrum analyzer reading level is exactly the EUT RF output level.

Example:

The spectrum analyzer offset is derived from RF cable loss and attenuator factor.

Offset = RF cable loss + attenuator factor.

Following shows an offset computation example with cable loss 4.2 dB and 10dB attenuator.

$$\begin{aligned}
 \text{Offset(dB)} &= \text{RF cable loss(dB)} + \text{attenuator factor(dB)}. \\
 &= 4.2 + 10 = 14.2 \text{ (dB)}
 \end{aligned}$$

3 Test Result

3.1 Number of Channel Measurement

3.1.1 Limits of Number of Hopping Frequency

Frequency hopping systems in the 2400-2483.5 MHz band shall use at least 15 channels.

3.1.2 Measuring Instruments

See list of measuring equipment of this test report.

3.1.3 Test Procedure

1. The testing follows ANSI C63.10-2013 clause 7.8.3.
2. The RF output of EUT was connected to the spectrum analyzer by RF cable and attenuator. The path loss was compensated to the results for each measurement.
3. Set to the maximum power setting and enable the EUT transmit continuously.
4. Enable the EUT hopping function.
5. Use the following spectrum analyzer settings: Span = the frequency band of operation; RBW = 300kHz; VBW \geq RBW; Sweep = auto; Detector function = peak; Trace = max hold.
6. The number of hopping frequency used is defined as the number of total channel.
7. Record the measurement data derived from spectrum analyzer.

3.1.4 Test Setup

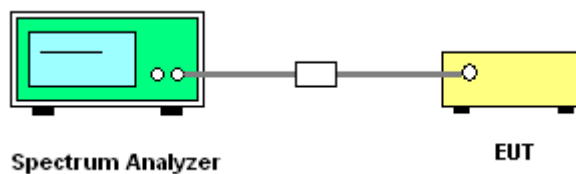



3.1.5 Test Result of Number of Hopping Frequency

Test Engineer :	Allen Lin	Temperature :	21~25°C
		Relative Humidity :	51~54%

Number of Hopping (Channel)	Adaptive Frequency Hopping (Channel)	Limits (Channel)	Pass/Fail
79	20	> 15	Pass

Number of Hopping Channel Plot on Channel 00 - 78

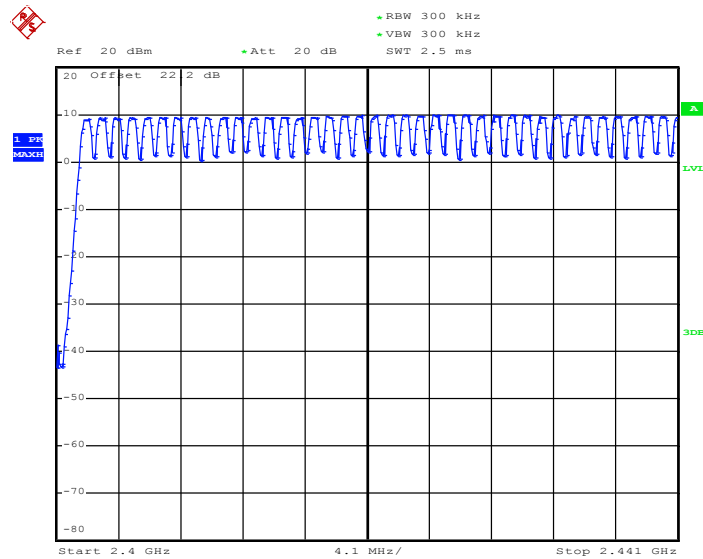

Date: 14.JAN.2019 14:13:19

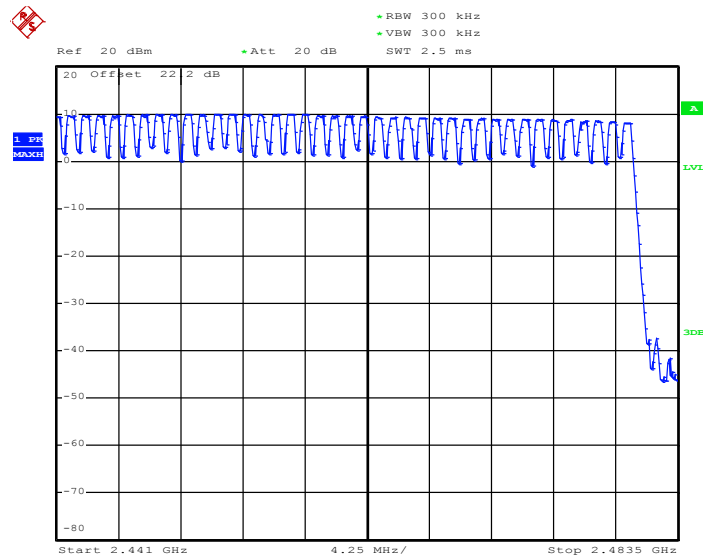

Date: 14.JAN.2019 14:14:42

3.2 Hopping Channel Separation Measurement

3.2.1 Limit of Hopping Channel Separation

Frequency hopping systems operating in the 2400-2483.5 MHz band may have hopping channel carrier frequencies that are separated by 25 kHz or two-thirds of the 20 dB bandwidth of the hopping channel, whichever is greater.

3.2.2 Measuring Instruments

See list of measuring equipment of this test report.

3.2.3 Test Procedures

1. The testing follows ANSI C63.10-2013 clause 7.8.2.
2. The RF output of EUT was connected to the spectrum analyzer by RF cable and attenuator. The path loss was compensated to the results for each measurement.
3. Set to the maximum power setting and enable the EUT transmit continuously.
4. Enable the EUT hopping function.
5. Use the following spectrum analyzer settings:
Span = wide enough to capture the peaks of two adjacent channels;
RBW = 300kHz; VBW \geq RBW; Sweep = auto; Detector function = peak; Trace = max hold.
6. Measure and record the results in the test report.

3.2.4 Test Setup





3.2.5 Test Result of Hopping Channel Separation

Test Engineer :	Allen Lin	Temperature :	21~25°C
		Relative Humidity :	51~54%

Mod.	Data Rate	N _{TX}	CH.	Freq. (MHz)	Hopping Channel Separation Measurement (MHz)	Hopping Channel Separation Measurement Limit (MHz)	Pass/Fail
DH	1Mbps	1	0	2402	1.146	0.5920	Pass
DH	1Mbps	1	39	2441	1.002	0.5920	Pass
DH	1Mbps	1	78	2480	1.002	0.5947	Pass
2DH	2Mbps	1	0	2402	1.008	0.9240	Pass
2DH	2Mbps	1	39	2441	1.002	0.9240	Pass
2DH	2Mbps	1	78	2480	1.008	0.9280	Pass
3DH	3Mbps	1	0	2402	1.002	0.9720	Pass
3DH	3Mbps	1	39	2441	1.014	0.9680	Pass
3DH	3Mbps	1	78	2480	1.008	0.9760	Pass

<1Mbps>

Channel Separation Plot on Channel 00 - 01

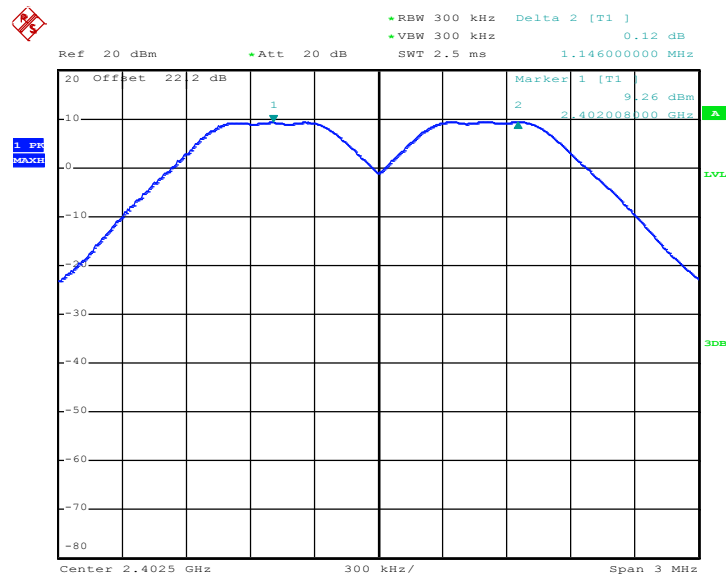

Date: 14.JAN.2019 13:54:43



Channel Separation Plot on Channel 39 - 40

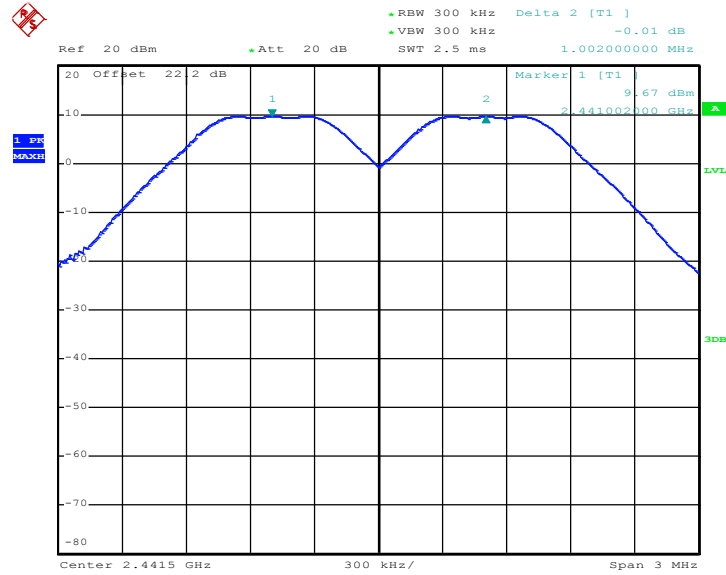

Date: 14.JAN.2019 14:02:16

Channel Separation Plot on Channel 77 - 78

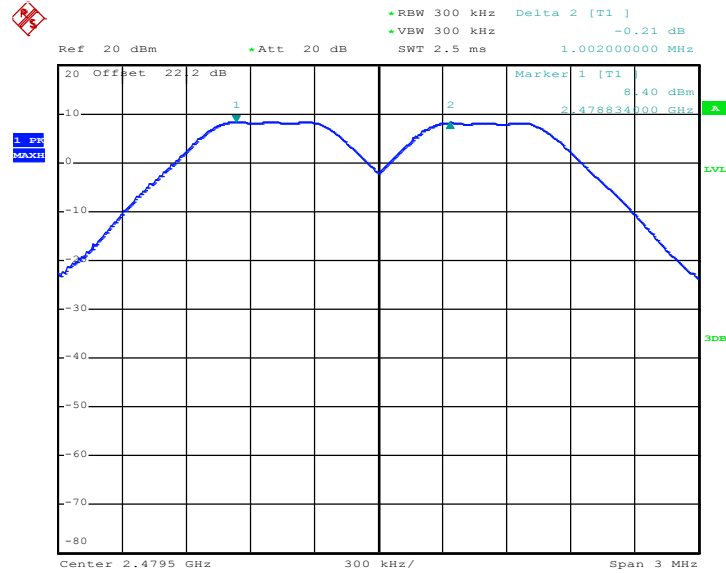

Date: 14.JAN.2019 14:09:08



<2Mbps>

Channel Separation Plot on Channel 00 - 01

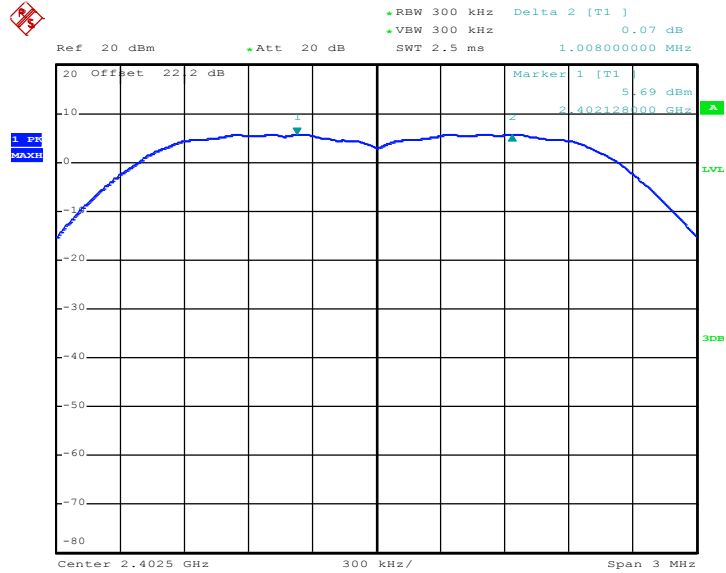

Date: 14.JAN.2019 14:40:00

Channel Separation Plot on Channel 39 - 40

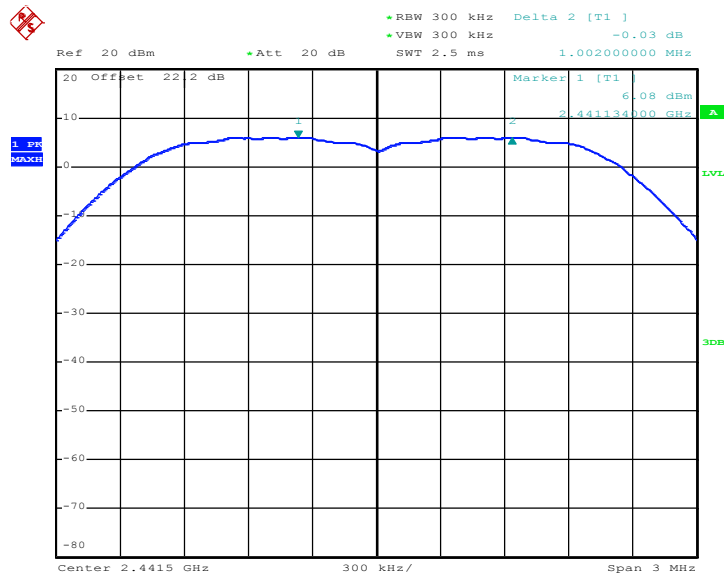

Date: 14.JAN.2019 14:46:39



Channel Separation Plot on Channel 77 - 78

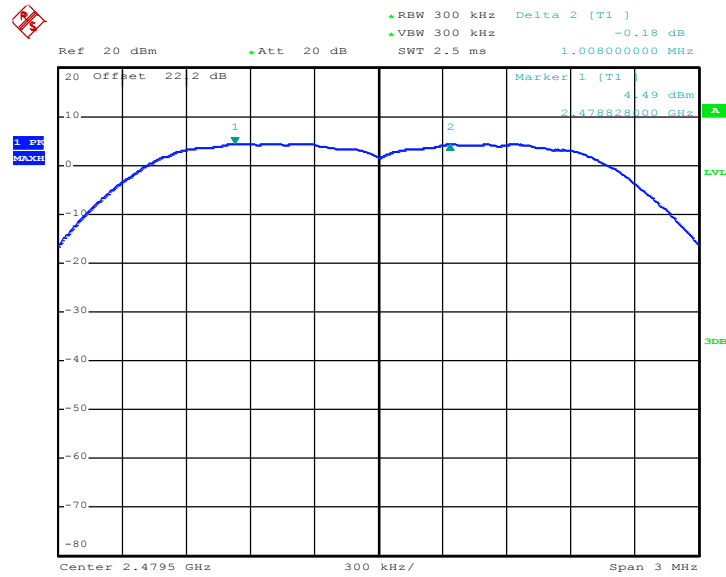

Date: 14.JAN.2019 14:47:43

<3Mbps>

Channel Separation Plot on Channel 00 - 01

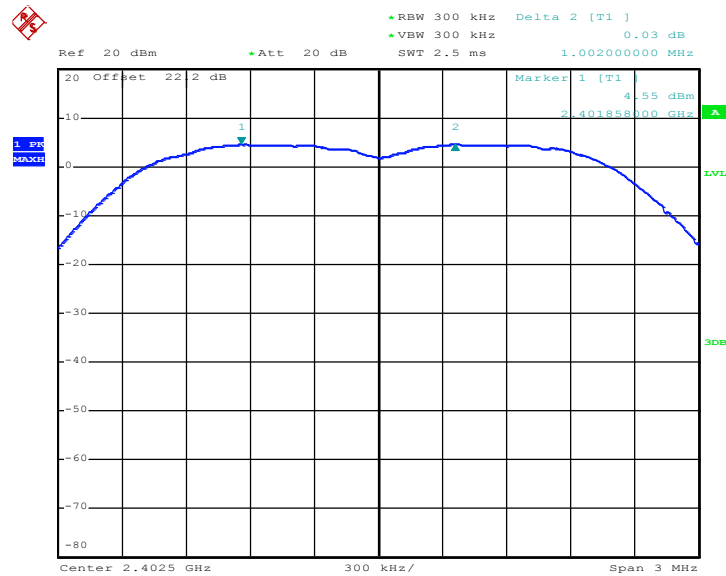

Date: 14.JAN.2019 14:59:56



Channel Separation Plot on Channel 39 - 40

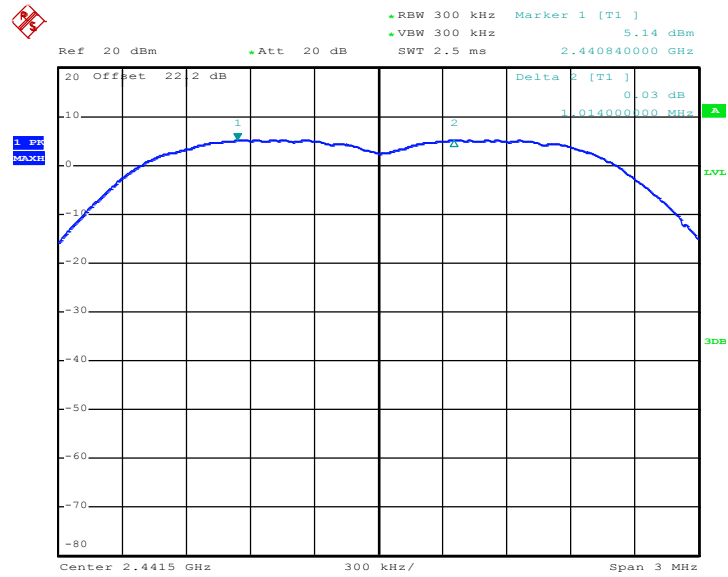

Date: 14.JAN.2019 15:14:59

Channel Separation Plot on Channel 77 - 78

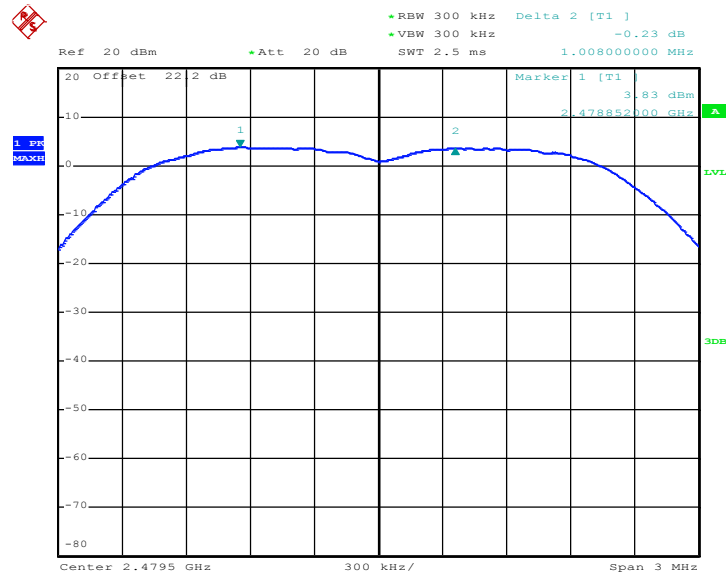

Date: 14.JAN.2019 15:03:34

3.3 Dwell Time Measurement

3.3.1 Limit of Dwell Time

The average time of occupancy on any channel shall not be greater than 0.4 seconds within a period of 0.4 seconds multiplied by the number of hopping channels employed.

3.3.2 Measuring Instruments

See list of measuring equipment of this test report.

3.3.3 Test Procedures

1. The testing follows ANSI C63.10-2013 clause 7.8.4.
2. The RF output of EUT was connected to the spectrum analyzer by RF cable and attenuator. The path loss was compensated to the results for each measurement.
3. Set to the maximum power setting and enable the EUT transmit continuously.
4. Enable the EUT hopping function.
5. Use the following spectrum analyzer settings: Span = zero span, centered on a hopping channel; RBW = 1 MHz; VBW \geq RBW; Sweep = as necessary to capture the entire dwell time per hopping channel; Detector function = peak; Trace = max hold.
6. Measure and record the results in the test report.

3.3.4 Test Setup





3.3.5 Test Result of Dwell Time

Test Engineer :	Allen Lin	Temperature :	21~25°C
		Relative Humidity :	51~54%

Mod.	Hopping Channel Number Rate	Hops Over Occupancy Time(hops)	Package Transfer Time (msec) (MHz)	Dwell Time (sec)	Limits (sec)	Pass/Fail
Nomal	79	106.67	2.90	0.31	0.4	Pass
AFH	20	53.33	2.90	0.15	0.4	Pass

Package Transfer Time Plot

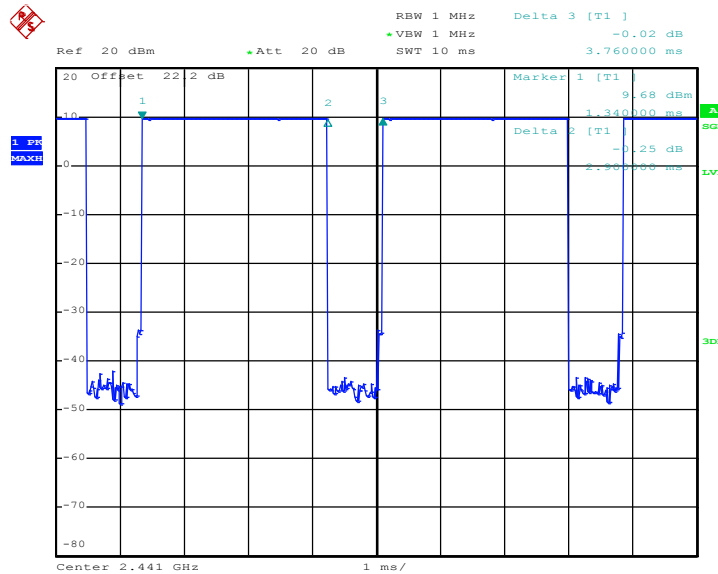

Date: 10.JAN.2019 16:56:44

Remark:

- In normal mode, hopping rate is 1600 hops/s with 6 slots in 79 hopping channels. With channel hopping rate (1600 / 6 / 79) in Occupancy Time Limit (0.4 x 79) (s), Hops Over Occupancy Time comes to (1600 / 6 / 79) x (0.4 x 79) = 106.67 hops.
- In AFH mode, hopping rate is 800 hops/s with 6 slots in 20 hopping channels. With channel hopping rate (800 / 6 / 20) in Occupancy Time Limit (0.4 x 20) (s), Hops Over Occupancy Time comes to (800 / 6 / 20) x (0.4 x 20) = 53.33 hops.
- Dwell Time(s) = Hops Over Occupancy Time (hops) x Package Transfer Time

3.4 20dB and 99% Bandwidth Measurement

3.4.1 Limit of 20dB and 99% Bandwidth

Reporting only

3.4.2 Measuring Instruments

See list of measuring equipment of this test report.

3.4.3 Test Procedures

1. The testing follows ANSI C63.10-2013 clause 6.9.2 and 6.9.3.
2. The RF output of EUT was connected to the spectrum analyzer by RF cable and attenuator. The path loss was compensated to the results for each measurement.
3. Set to the maximum power setting and enable the EUT transmit continuously.
4. Use the following spectrum analyzer settings for 20dB Bandwidth measurement.
Span = approximately 2 to 5 times the 20 dB bandwidth, centered on a hopping channel;
RBW \geq 1-5% of the OBW; VBW \geq RBW; Sweep = auto; Detector function = peak;
Trace = max hold.
5. Use the following spectrum analyzer settings for 99 % Bandwidth measurement.
Span = approximately 1.5 to 5 times the 99% bandwidth, centered on a hopping channel;
RBW \geq 1-5% of the 99% bandwidth; VBW \geq 3 * RBW; Sweep = auto; Detector function = peak;
Trace = max hold.
6. Measure and record the results in the test report.

3.4.4 Test Setup

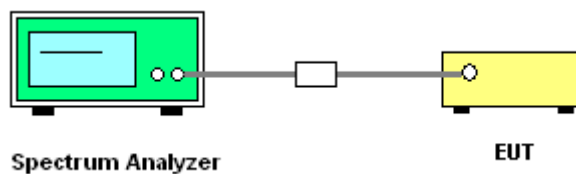



3.4.5 Test Result of 20dB Bandwidth

Test Engineer :	Allen Lin			Temperature :	21~25°C	
				Relative Humidity :	51~54%	
Mod.	Data Rate	N _{TX}	CH.	Freq. (MHz)	20db BW (MHz)	Pass/Fail
DH	1Mbps	1	0	2402	0.888	Pass
DH	1Mbps	1	39	2441	0.888	Pass
DH	1Mbps	1	78	2480	0.892	Pass
2DH	2Mbps	1	0	2402	1.386	Pass
2DH	2Mbps	1	39	2441	1.386	Pass
2DH	2Mbps	1	78	2480	1.392	Pass
3DH	3Mbps	1	0	2402	1.458	Pass
3DH	3Mbps	1	39	2441	1.452	Pass
3DH	3Mbps	1	78	2480	1.464	Pass

<1Mbps>

20 dB Bandwidth Plot on Channel 00

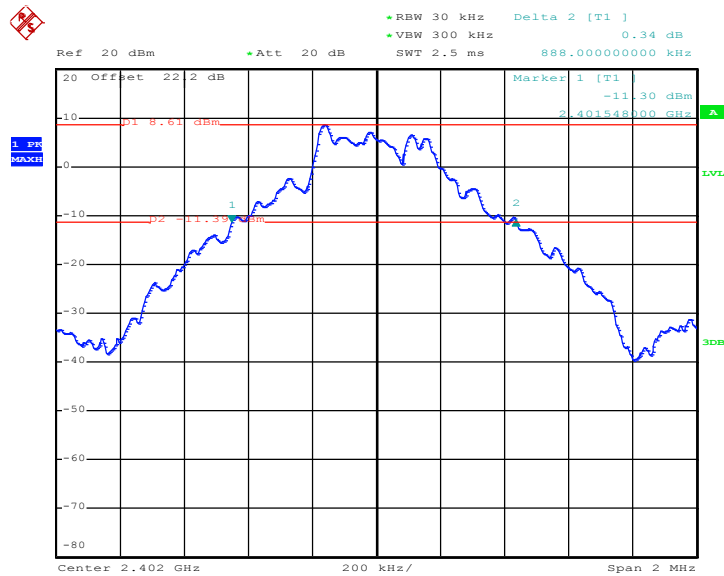

Date: 14.JAN.2019 13:43:37



20 dB Bandwidth Plot on Channel 39

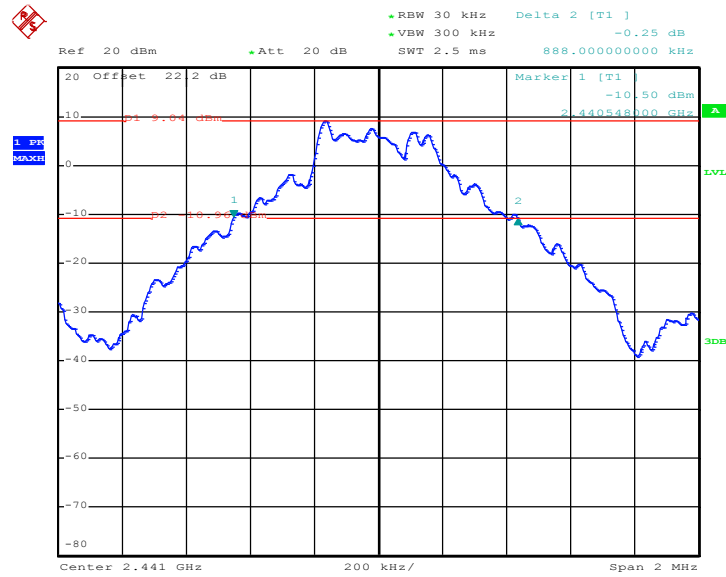

Date: 14.JAN.2019 13:56:58

20 dB Bandwidth Plot on Channel 78

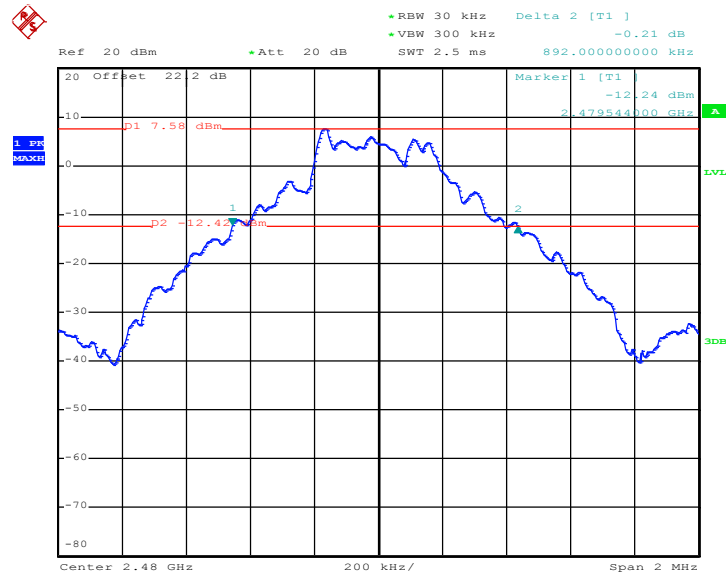

Date: 14.JAN.2019 14:03:58



<2Mbps>

20 dB Bandwidth Plot on Channel 00

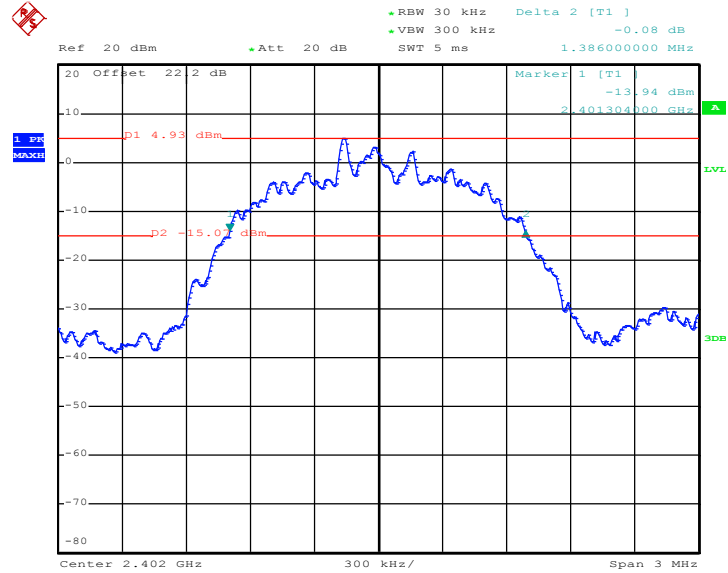

Date: 14.JAN.2019 14:29:34

20 dB Bandwidth Plot on Channel 39

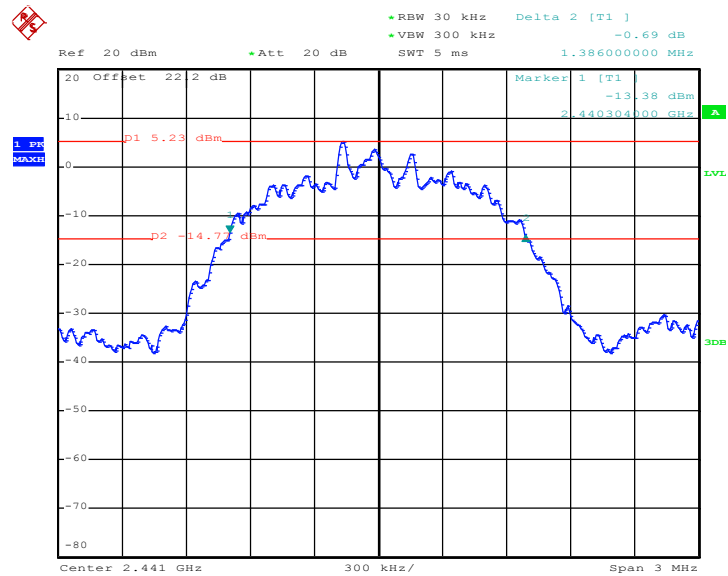

Date: 14.JAN.2019 14:42:14



20 dB Bandwidth Plot on Channel 78

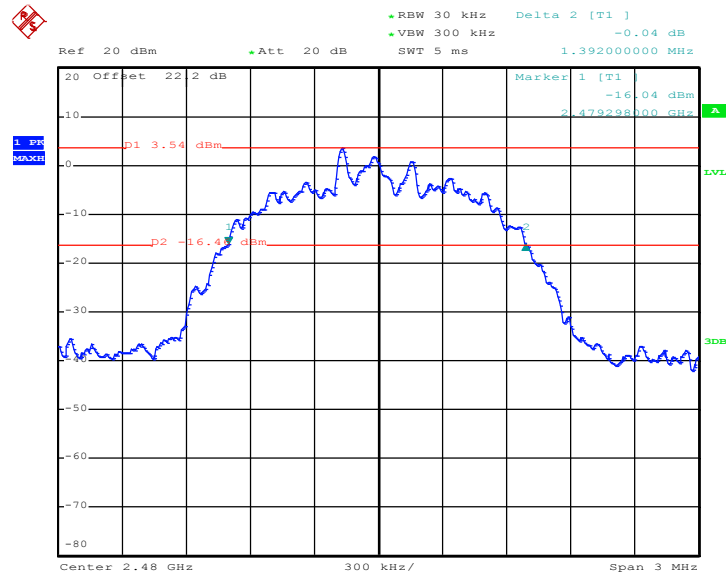

Date: 14.JAN.2019 14:48:51

<3Mbps>

20 dB Bandwidth Plot on Channel 00

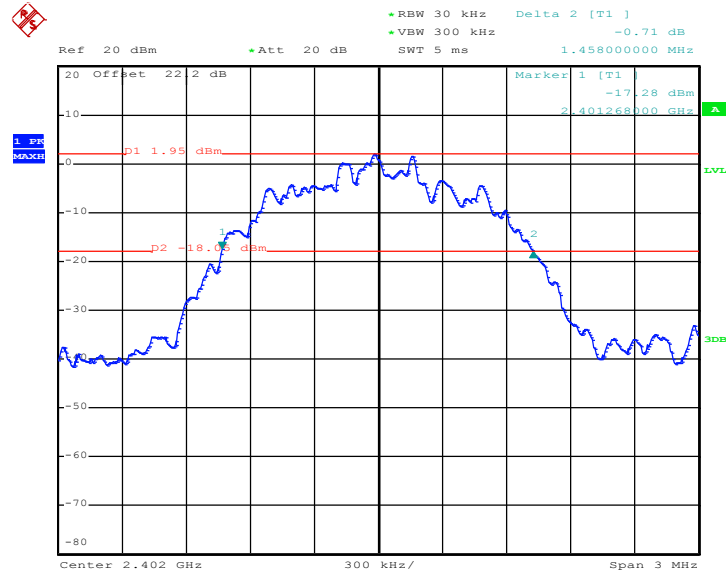

Date: 14.JAN.2019 14:56:57



20 dB Bandwidth Plot on Channel 39

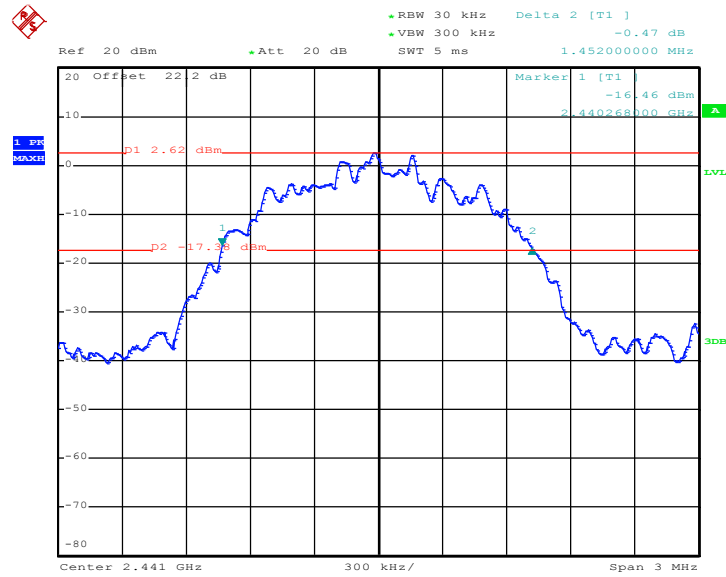

Date: 14.JAN.2019 15:00:58

20 dB Bandwidth Plot on Channel 78

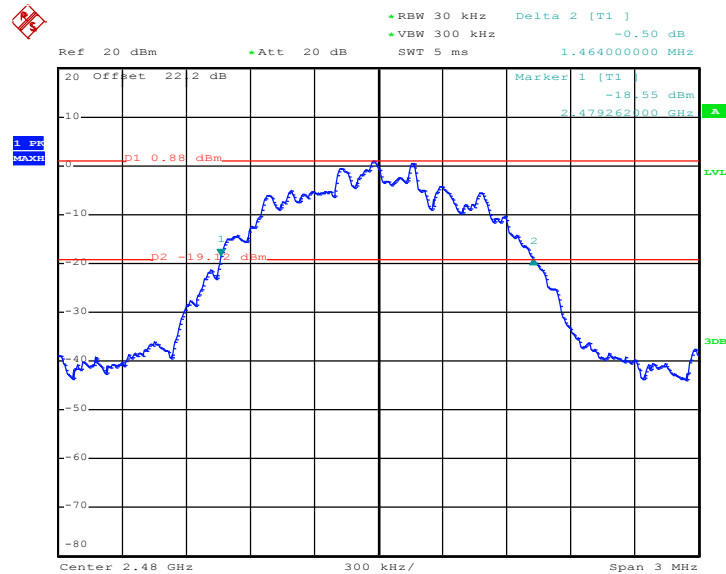

Date: 14.JAN.2019 15:04:38



3.4.6 Test Result of 99% Occupied Bandwidth

Test Engineer :	Allen Lin	Temperature :	21~25°C
		Relative Humidity :	51~54%

Mod.	Data Rate	N _{TX}	CH.	Freq. (MHz)	99% Bandwidth (MHz)	Pass/Fail
DH	1Mbps	1	0	2402	0.840	Pass
DH	1Mbps	1	39	2441	0.844	Pass
DH	1Mbps	1	78	2480	0.844	Pass
2DH	2Mbps	1	0	2402	1.332	Pass
2DH	2Mbps	1	39	2441	1.336	Pass
2DH	2Mbps	1	78	2480	1.336	Pass
3DH	3Mbps	1	0	2402	1.336	Pass
3DH	3Mbps	1	39	2441	1.340	Pass
3DH	3Mbps	1	78	2480	1.340	Pass

<1Mbps>

99% Occupied Bandwidth Plot on Channel 00

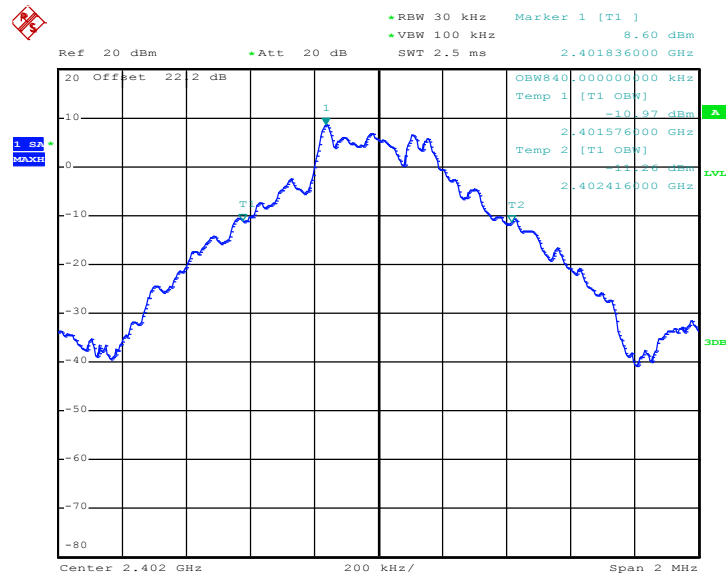

Date: 14.JAN.2019 13:45:03



99% Occupied Bandwidth Plot on Channel 39

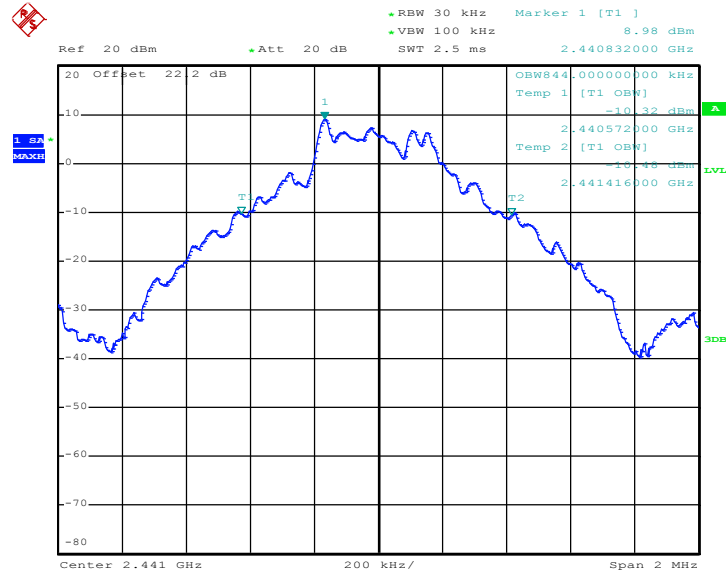

Date: 14.JAN.2019 13:58:45

99% Occupied Bandwidth Plot on Channel 78

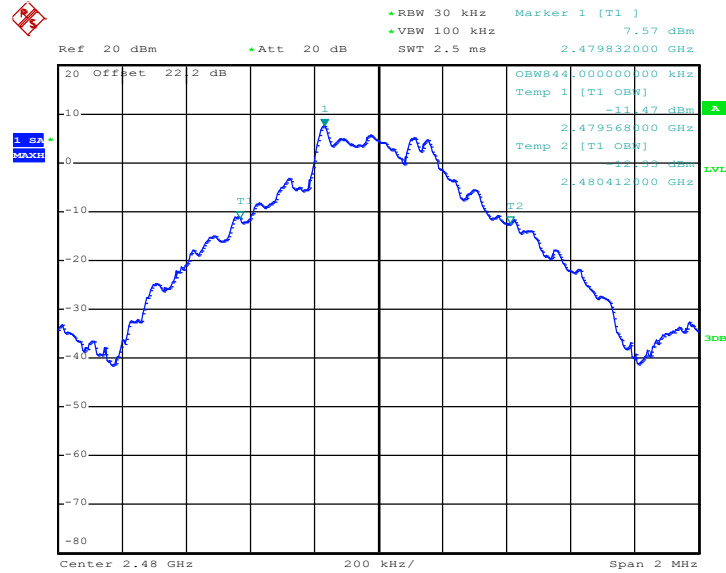

Date: 14.JAN.2019 14:04:57



<2Mbps>

99% Occupied Bandwidth Plot on Channel 00

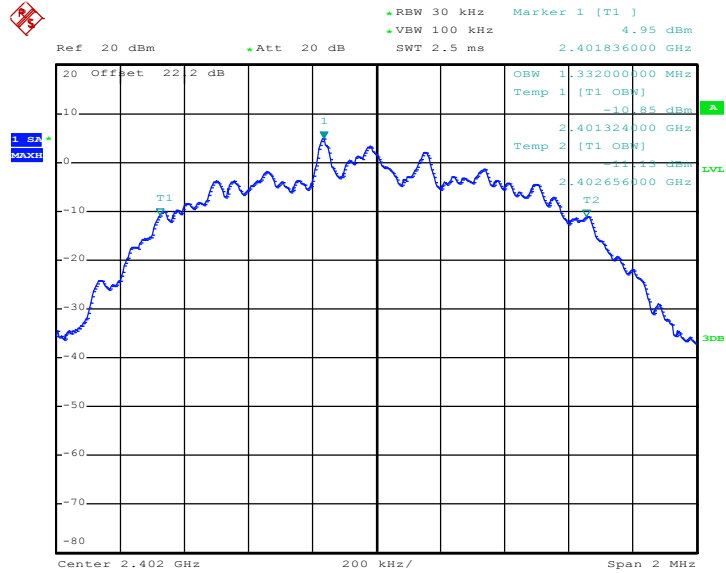

Date: 14.JAN.2019 14:30:54

99% Occupied Bandwidth Plot on Channel 39

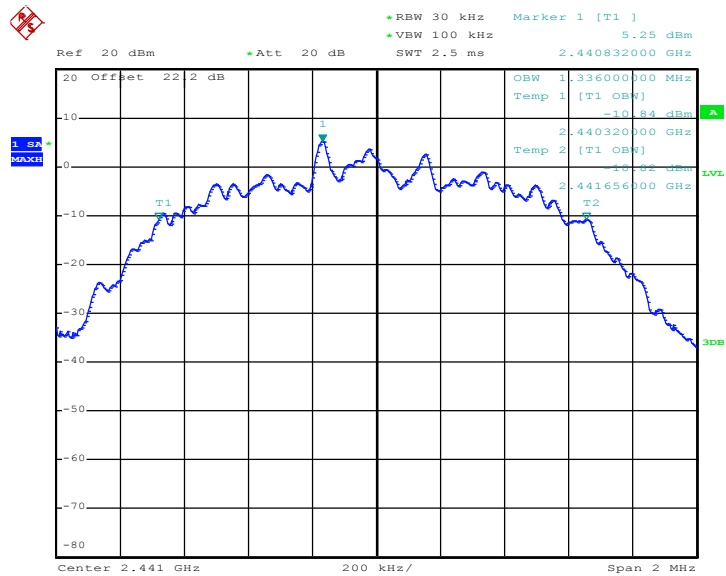

Date: 14.JAN.2019 14:42:59



99% Occupied Bandwidth Plot on Channel 78

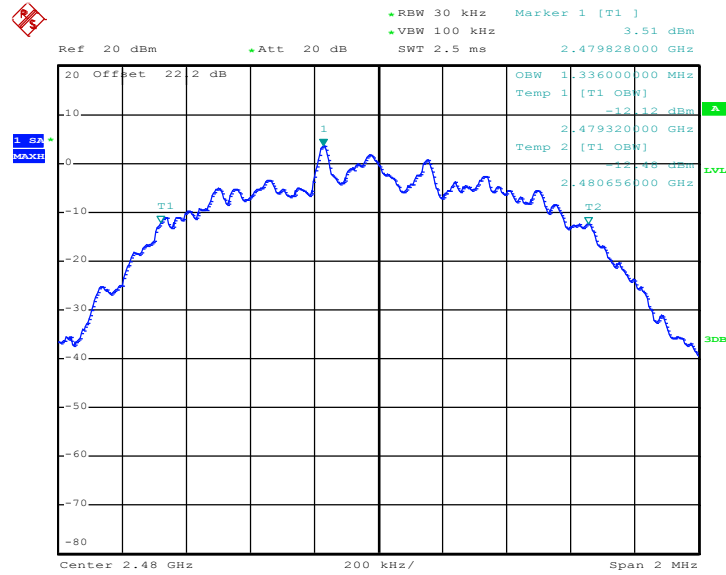

Date: 14.JAN.2019 14:49:51

<3Mbps>

99% Occupied Bandwidth Plot on Channel 00

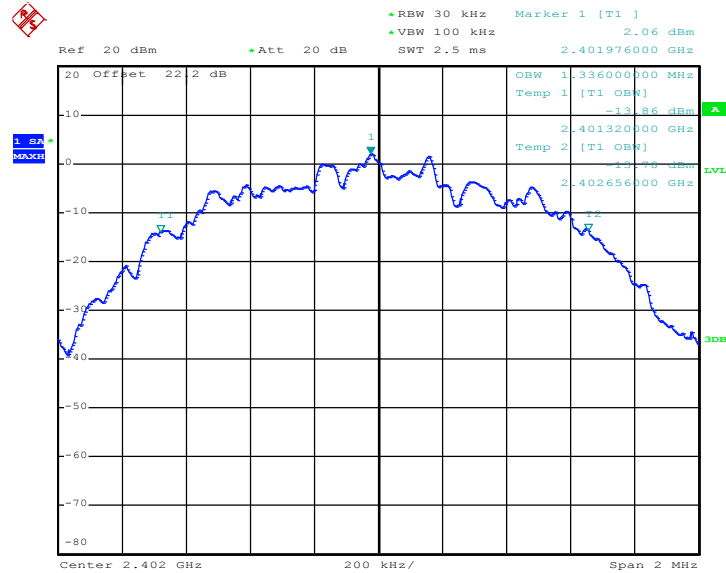

Date: 14.JAN.2019 14:57:52



99% Occupied Bandwidth Plot on Channel 39

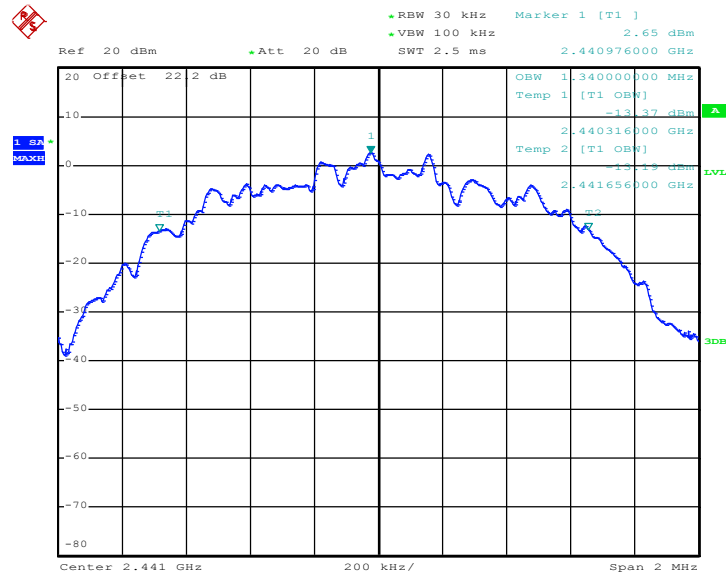

Date: 14.JAN.2019 15:01:38

99% Occupied Bandwidth Plot on Channel 78

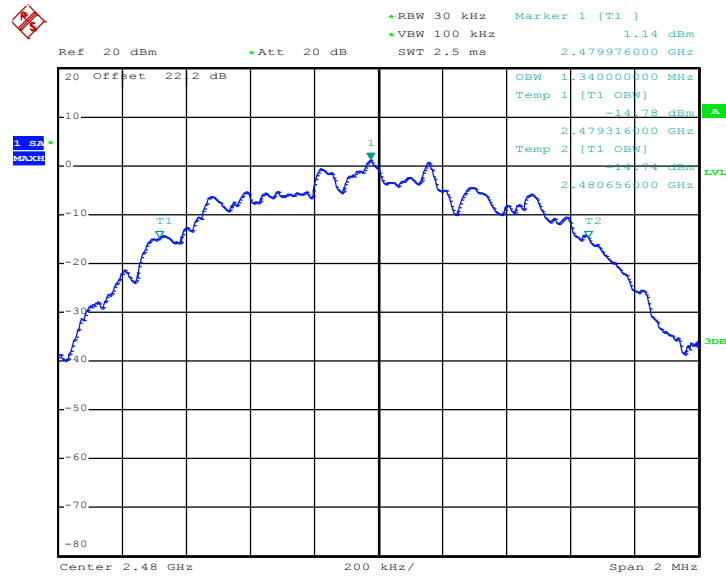

Date: 14.JAN.2019 15:05:29

Note: The occupied channel bandwidth is maintained within the band of operation for all of the modulations.

3.5 Output Power Measurement

3.5.1 Limit of Output Power

The maximum peak conducted output power of the intentional radiator shall not exceed the following:

(1) For frequency hopping systems operating in the 2400-2483.5 MHz band employing at least 75 non-overlapping hopping channels, and all frequency hopping systems in the 5725-5850 MHz band: 1 watt. For all other frequency hopping systems in the 2400-2483.5 MHz band 0.125 watts. The power limit for 1Mbps, 2Mbps, 3Mbps and AFH modes are 0.125 watts.

3.5.2 Measuring Instruments

See list of measuring equipment of this test report.

3.5.3 Test Procedures

1. The testing follows ANSI C63.10-2013 clause 7.8.5.
2. The RF output of EUT was connected to the power meter by RF cable and attenuator. The path loss was compensated to the results for each measurement.
3. Set to the maximum power setting and enable the EUT transmit continuously.
4. Measure the conducted output power with cable loss and record the results in the test report.
5. Measure and record the results in the test report.

3.5.4 Test Setup

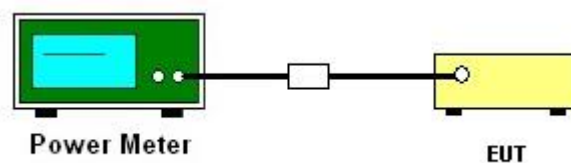



3.5.5 Test Result of Peak Output Power

Test Engineer :		Allen Lin		Temperature :	21~25°C
				Relative Humidity :	51~54%

DH	CH.	N _{TX}	Peak Power (dBm)	Power Limit (dBm)	Test Result
DH1	0	1	9.78	20.97	Pass
	39	1	10.24	20.97	Pass
	78	1	8.87	20.97	Pass

2DH	CH.	N _{TX}	Peak Power (dBm)	Power Limit (dBm)	Test Result
2DH1	0	1	8.27	20.97	Pass
	39	1	8.63	20.97	Pass
	78	1	7.17	20.97	Pass

3DH	CH.	N _{TX}	Peak Power (dBm)	Power Limit (dBm)	Test Result
3DH1	0	1	7.70	20.97	Pass
	39	1	8.09	20.97	Pass
	78	1	6.65	20.97	Pass

3.5.6 Test Result of Average Output Power (Reporting Only)

Test Engineer :		Allen Lin		Temperature :	21~25°C
				Relative Humidity :	51~54%

DH	CH.	N _{TX}	Average Power (dBm)	Duty Factor (dB)
DH1	0	1	9.71	5.16
	39	1	10.18	5.16
	78	1	8.80	5.16

2DH	CH.	N _{TX}	Average Power (dBm)	Duty Factor (dB)
2DH1	0	1	6.22	5.07
	39	1	6.59	5.07
	78	1	5.02	5.07

3DH	CH.	N _{TX}	Average Power (dBm)	Duty Factor (dB)
3DH1	0	1	5.32	5.07
	39	1	5.70	5.07
	78	1	4.15	5.07

3.6 Conducted Band Edges Measurement

3.6.1 Limit of Band Edges

In any 100 kHz bandwidth outside the intentional radiation frequency band, the radio frequency power shall be at least 20 dB below the highest level of the radiated power. In addition, radiated emissions which fall in the restricted bands must also comply with the radiated emission limits.

3.6.2 Measuring Instruments

See list of measuring equipment of this test report.

3.6.3 Test Procedures

1. The testing follows ANSI C63.10-2013 clause 7.8.6.
2. Set to the maximum power setting and enable the EUT transmit continuously.
3. Set RBW = 100kHz, VBW = 300kHz. Band edge emissions must be at least 20 dB down from the highest emission level within the authorized band as measured with a 100kHz RBW. The attenuation shall be 30 dB instead of 20 dB when RMS conducted output power procedure is used.
4. Enable hopping function of the EUT and then repeat step 2. and 3.
5. Measure and record the results in the test report.

3.6.4 Test Setup





3.6.5 Test Result of Conducted Band Edges

Test Engineer :	Allen Lin	Temperature :	21~25°C
		Relative Humidity :	51~54%

<1Mbps>

Low Band Edge Plot on Channel 00

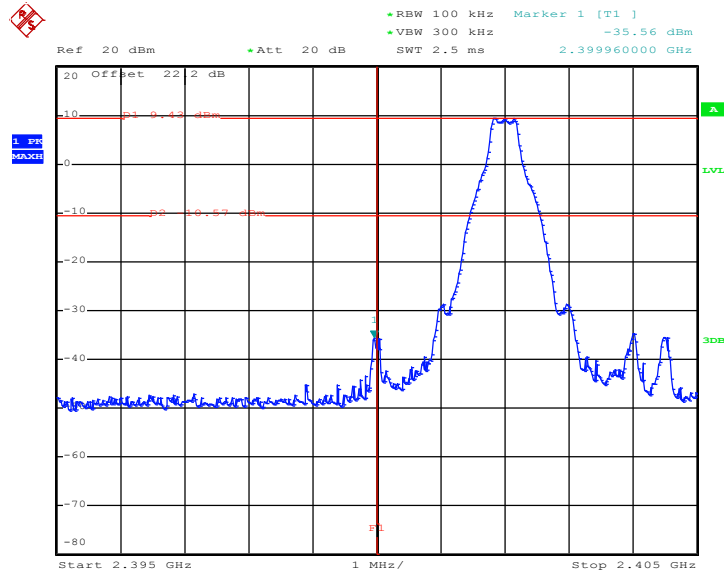

Date: 14.JAN.2019 13:44:10

High Band Edge Plot on Channel 78

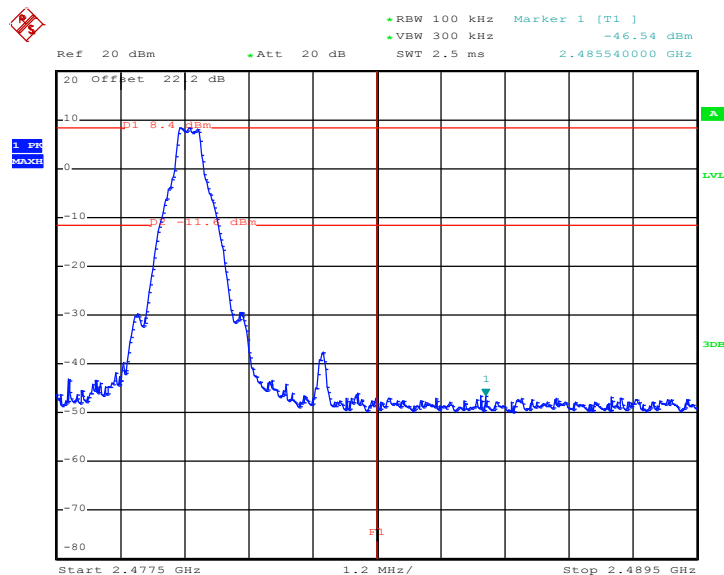

Date: 14.JAN.2019 14:04:18



<2Mbps>

Low Band Edge Plot on Channel 00

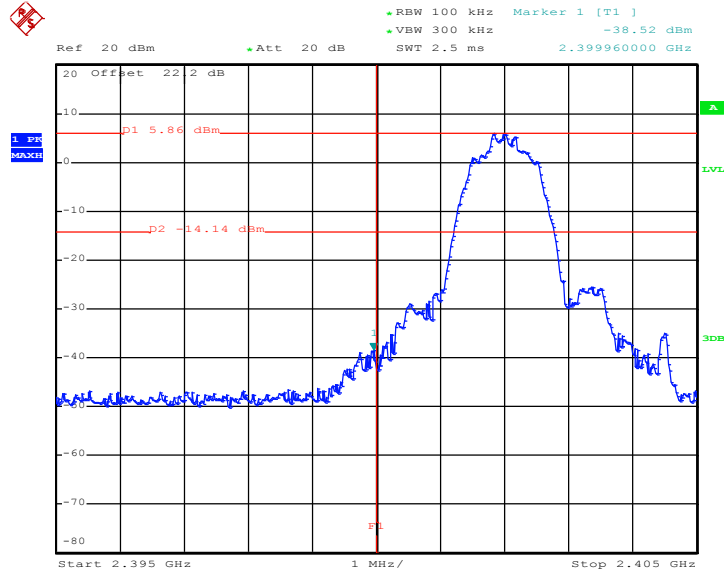

Date: 14.JAN.2019 14:30:18

High Band Edge Plot on Channel 78

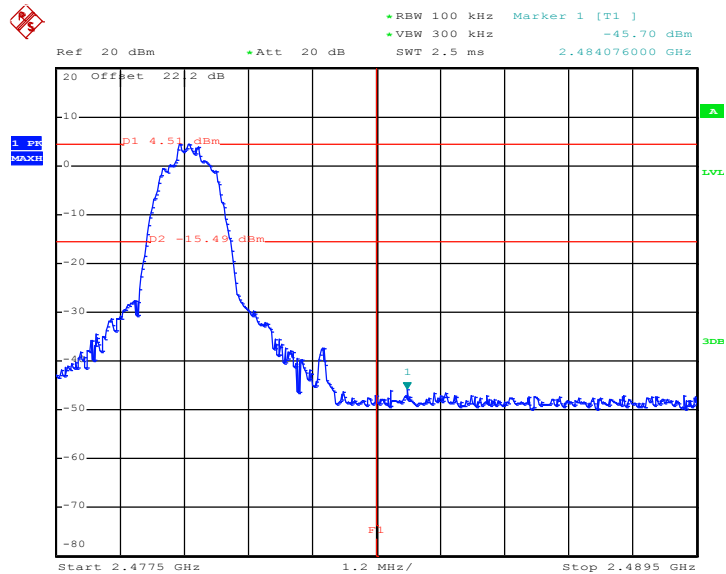

Date: 14.JAN.2019 14:49:10



<3Mbps>

Low Band Edge Plot on Channel 00

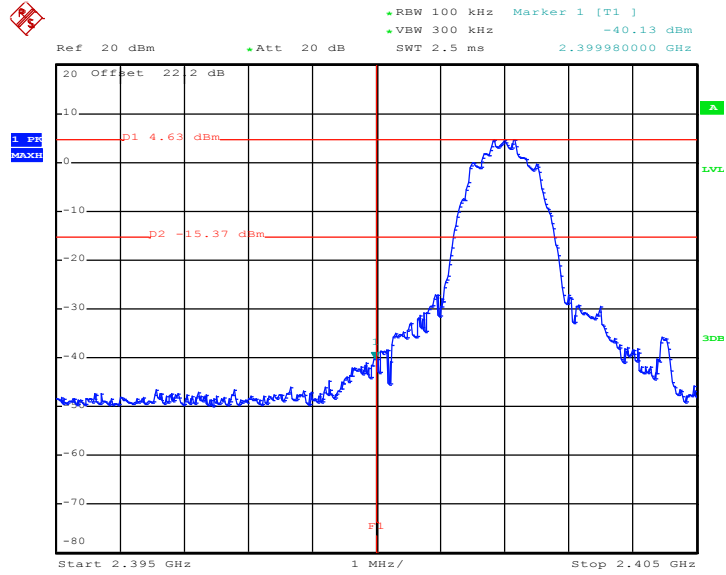

Date: 14.JAN.2019 14:57:15

High Band Edge Plot on Channel 78

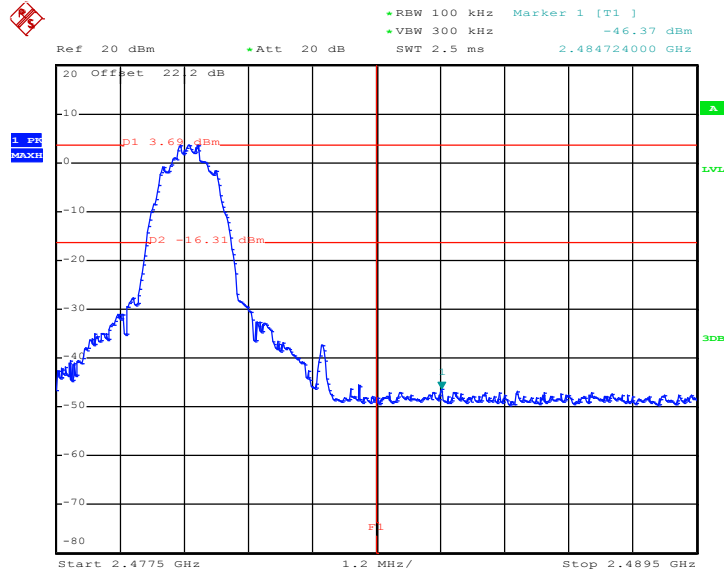

Date: 14.JAN.2019 15:04:55



3.6.6 Test Result of Conducted Hopping Mode Band Edges

Test Engineer :	Allen Lin	Temperature :	21~25°C
		Relative Humidity :	51~54%

<1Mbps>

Hopping Mode Low Band Edge Plot

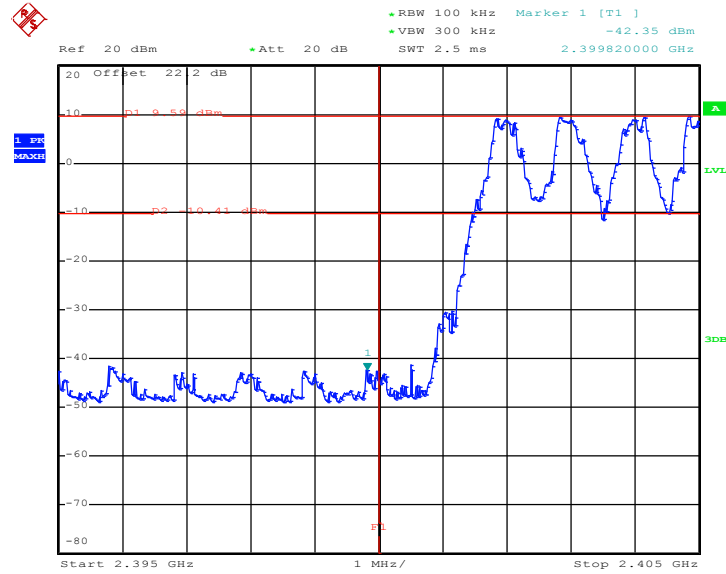

Date: 14.JAN.2019 14:11:01

Hopping Mode High Band Edge Plot

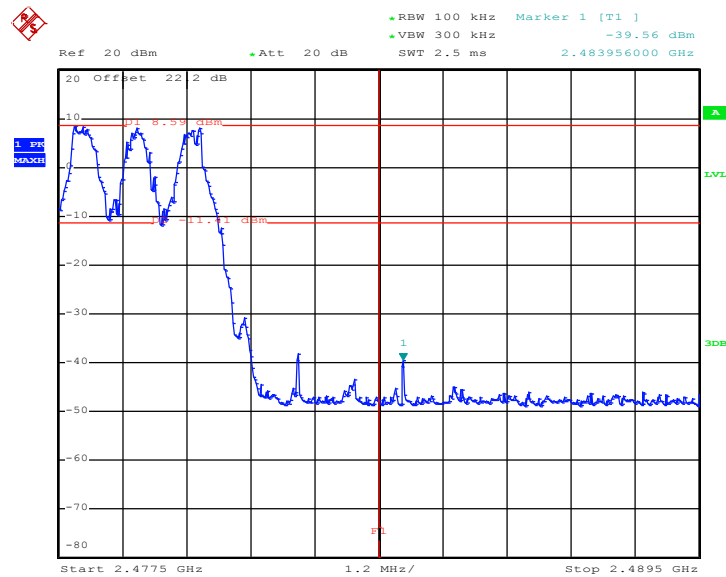

Date: 14.JAN.2019 14:12:05



<2Mbps>

Hopping Mode Low Band Edge Plot

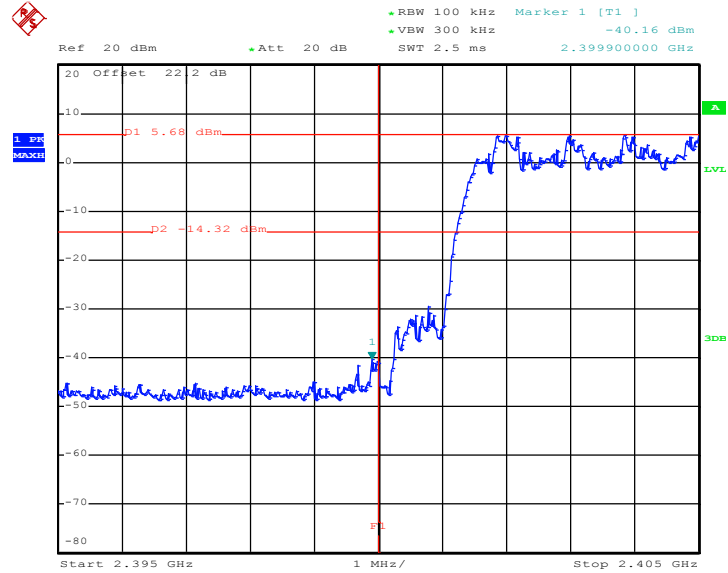

Date: 14.JAN.2019 14:17:23

Hopping Mode High Band Edge Plot

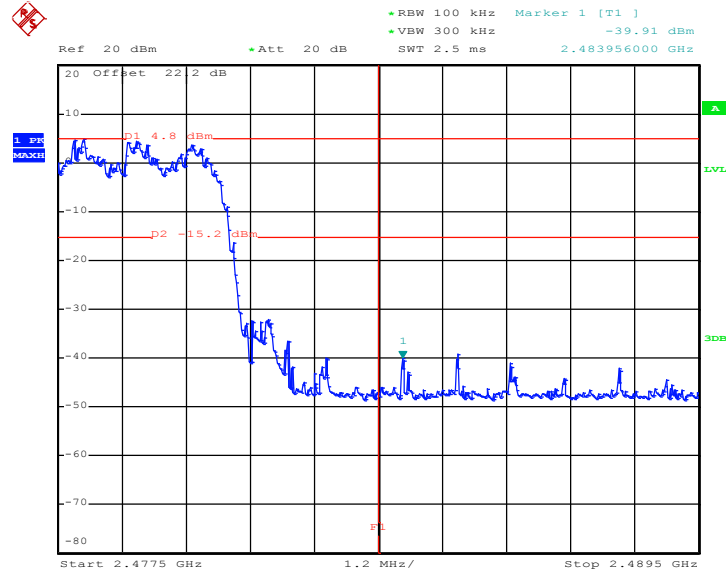

Date: 14.JAN.2019 14:19:25



<3Mbps>

Hopping Mode Low Band Edge Plot

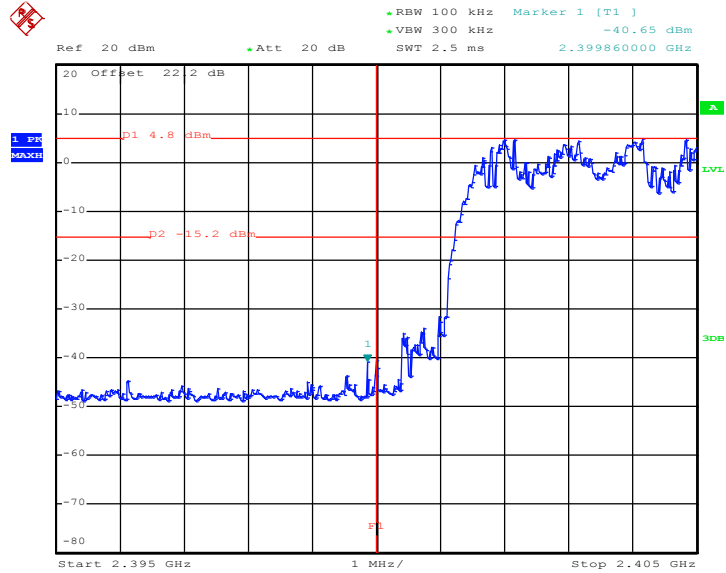

Date: 14.JAN.2019 14:20:54

Hopping Mode High Band Edge Plot

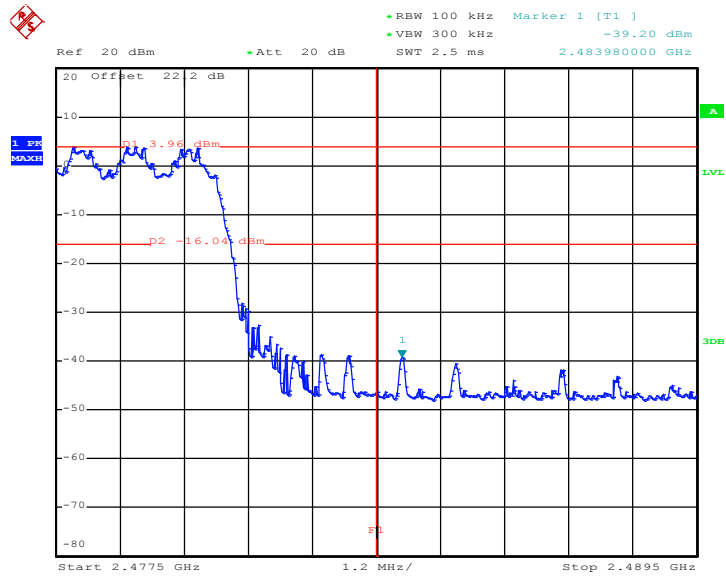

Date: 14.JAN.2019 14:25:48

3.7 Conducted Spurious Emission Measurement

3.7.1 Limit of Spurious Emission Measurement

In any 100 kHz bandwidth outside the intentional radiation frequency band, the radio frequency power shall be at least 20 dB below the highest level of the radiated power. In addition, radiated emissions which fall in the restricted bands must also comply with the radiated emission limits.

3.7.2 Measuring Instruments

See list of measuring equipment of this test report.

3.7.3 Test Procedure

1. The testing follows ANSI C63.10-2013 clause 7.8.8.
2. The RF output of EUT was connected to the spectrum analyzer by RF cable and attenuator. The path loss was compensated to the results for each measurement.
3. Set to the maximum power setting and enable the EUT transmit continuously.
4. Set RBW = 100 kHz, VBW = 300kHz, scan up through 10th harmonic. All harmonics / spurs must be at least 20 dB down from the highest emission level within the authorized band as measured with a 100 kHz RBW.
5. Measure and record the results in the test report.
6. The RF fundamental frequency should be excluded against the limit line in the operating frequency band.

3.7.4 Test Setup





3.7.5 Test Result of Conducted Spurious Emission

Test Engineer :	Allen Lin	Temperature :	21~25°C
		Relative Humidity :	51~54%

<1Mbps>

CSE Plot on Ch 00 between 30MHz ~ 3 GHz

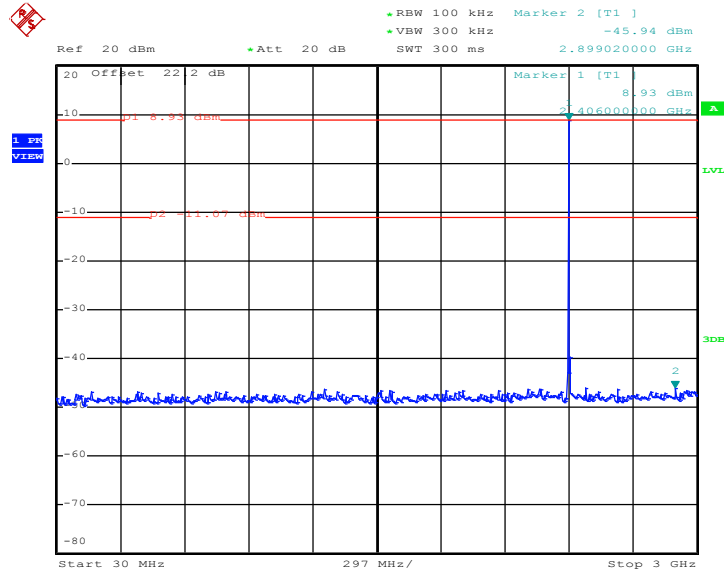

Date: 14.JAN.2019 13:51:22

1Mbps CSE Plot on Ch 00 between 2 GHz ~ 25 GHz

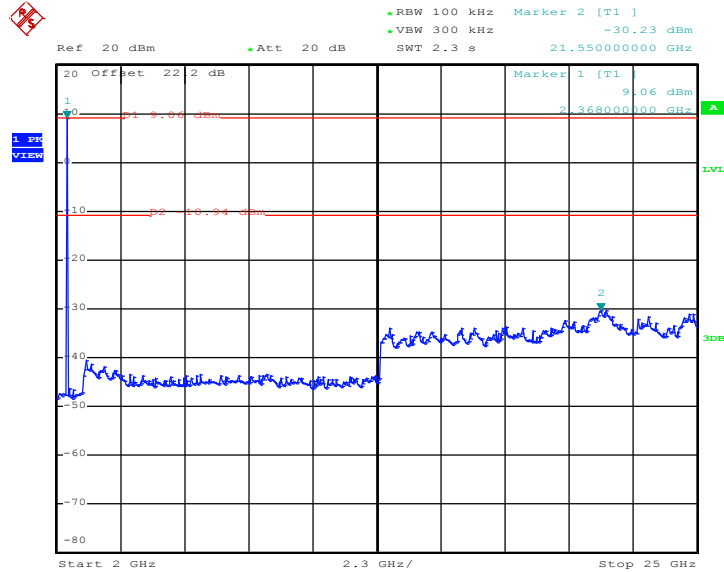

Date: 14.JAN.2019 13:53:41



CSE Plot on Ch 39 between 30MHz ~ 3 GHz

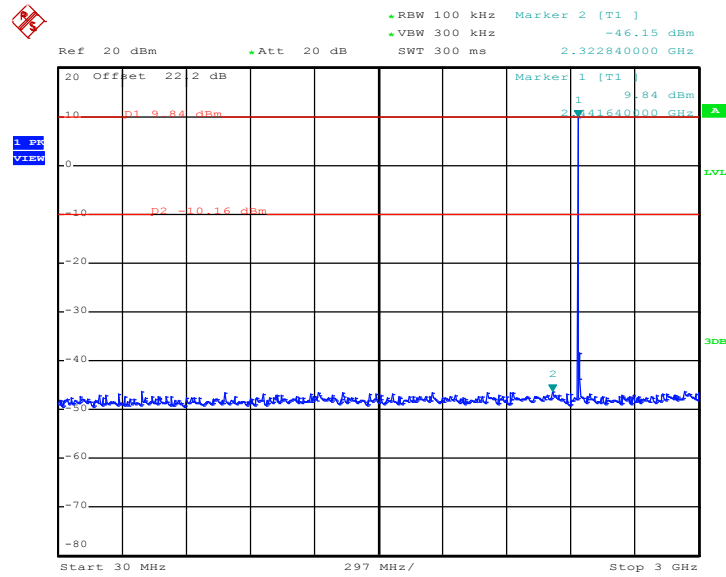

Date: 14.JAN.2019 14:00:45

CSE Plot on Ch 39 between 2 GHz ~ 25 GHz

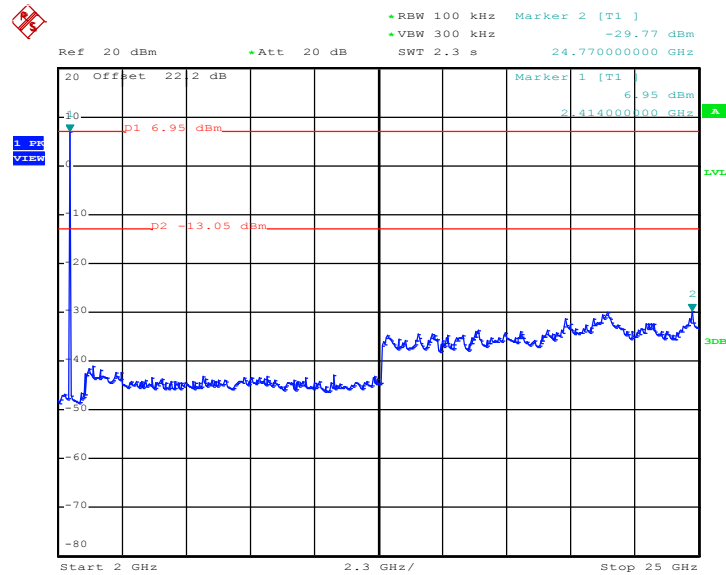

Date: 14.JAN.2019 14:01:12



CSE Plot on Ch 78 between 30MHz ~ 3 GHz

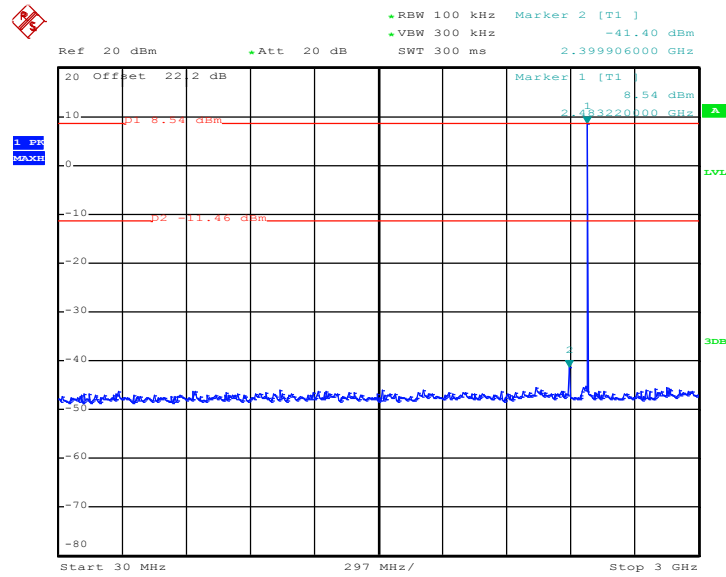

Date: 14.JAN.2019 14:07:20

CSE Plot on Ch 78 between 2 GHz ~ 25 GHz

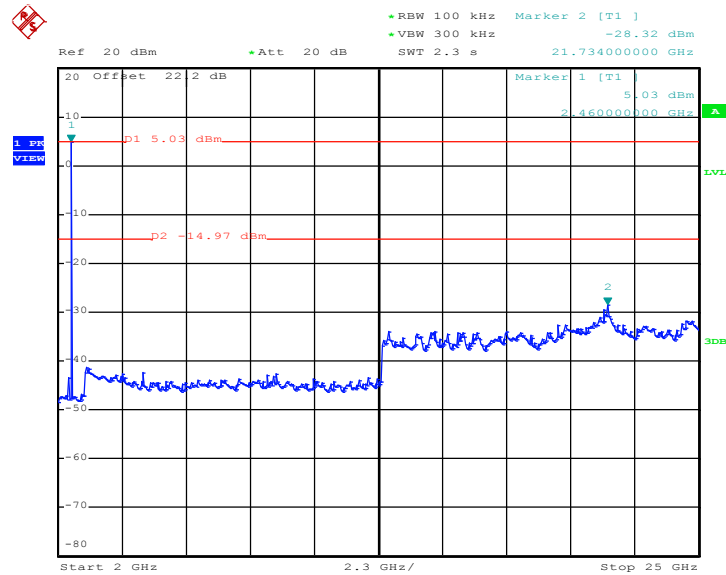

Date: 14.JAN.2019 14:07:54



<2Mbps>

CSE Plot on Ch 00 between 30MHz ~ 3 GHz

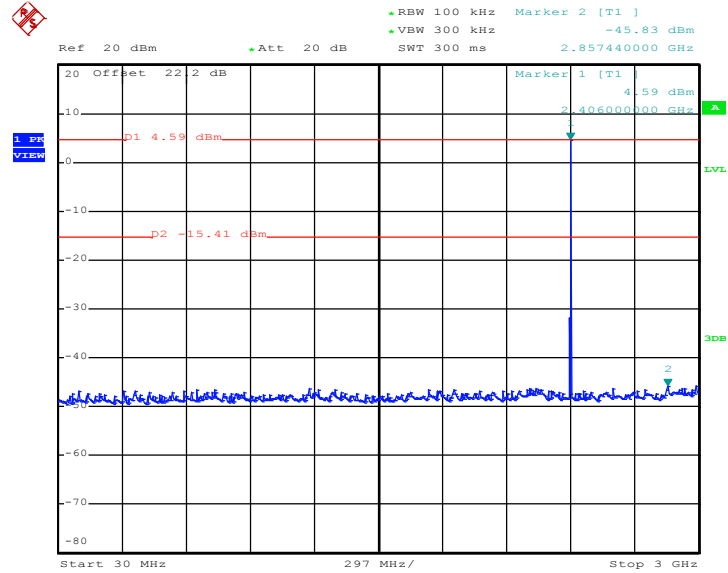

Date: 14.JAN.2019 14:31:57

CSE Plot on Ch 00 between 2 GHz ~ 25 GHz

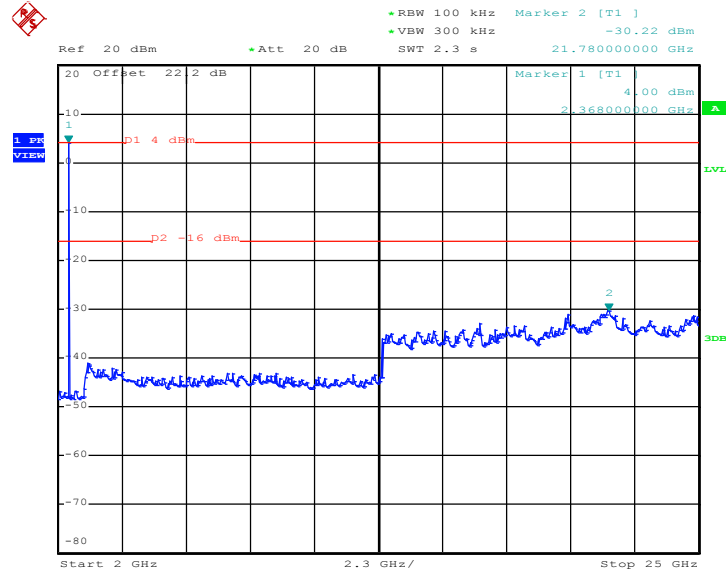

Date: 14.JAN.2019 14:32:29



CSE Plot on Ch 39 between 30MHz ~ 3 GHz

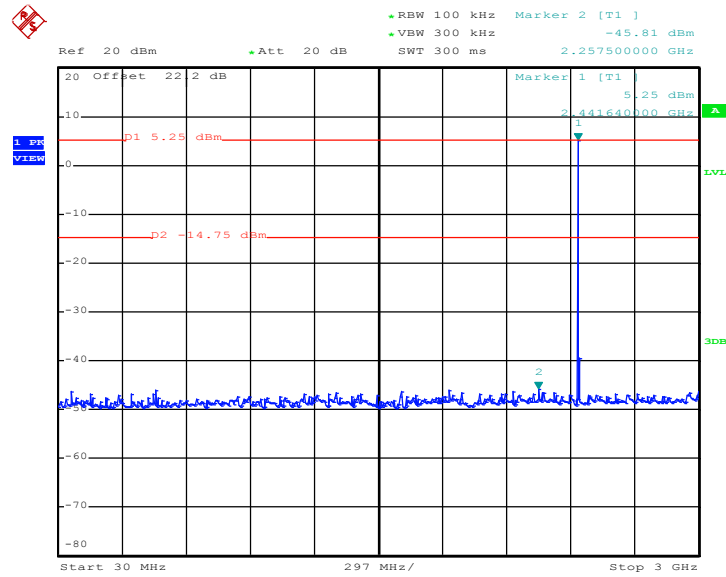

Date: 14.JAN.2019 14:54:53

CSE Plot on Ch 39 between 2 GHz ~ 25 GHz

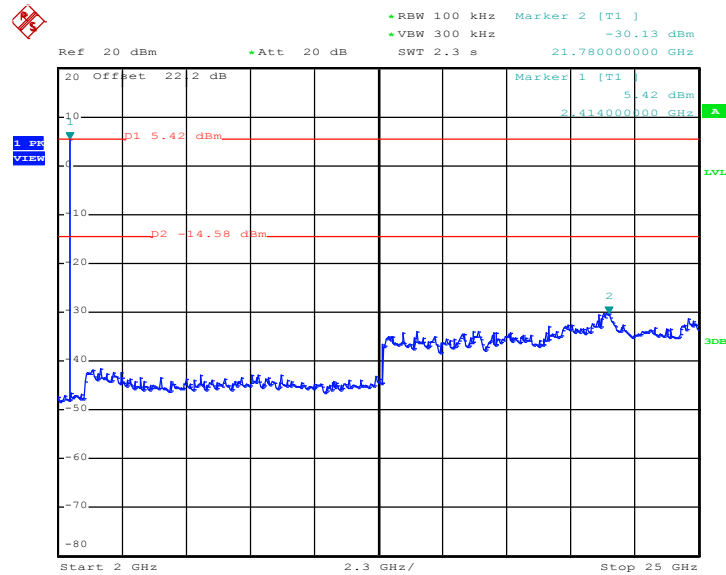

Date: 14.JAN.2019 14:55:20



CSE Plot on Ch 78 between 30MHz ~ 3 GHz

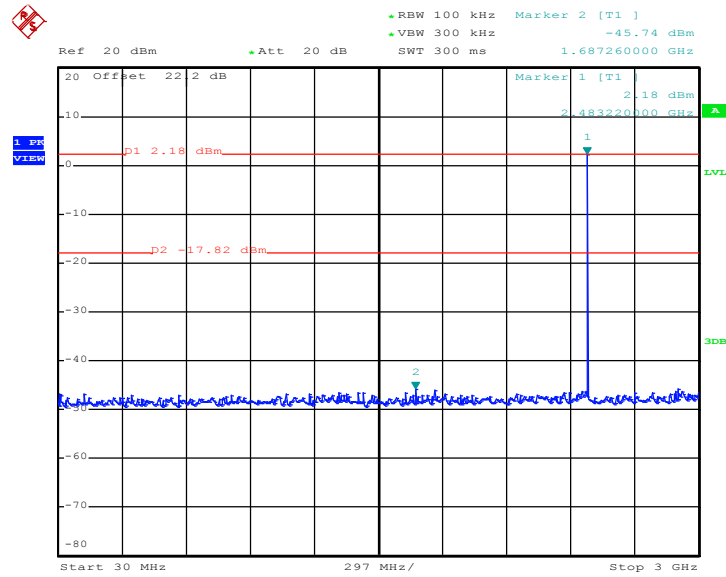

Date: 14.JAN.2019 14:51:59

CSE Plot on Ch 78 between 2 GHz ~ 25 GHz

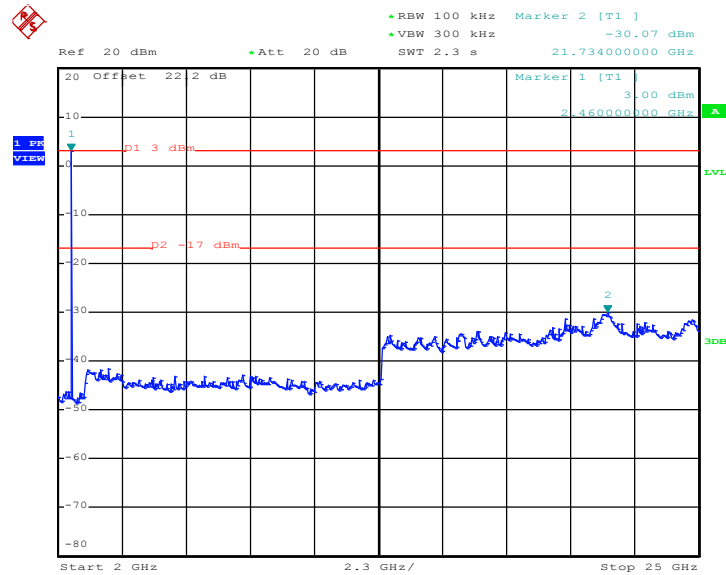

Date: 14.JAN.2019 14:52:25

<3Mbps>

CSE Plot on Ch 00 between 30MHz ~ 3 GHz

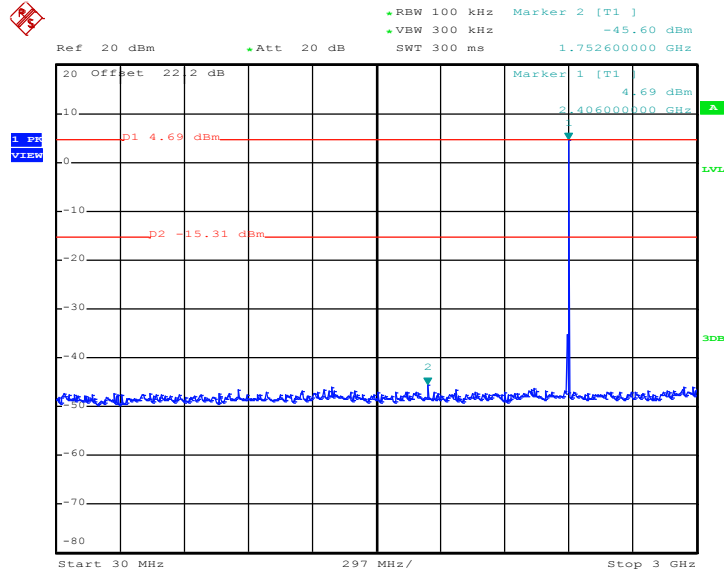

Date: 14.JAN.2019 14:58:26

CSE Plot on Ch 00 between 2 GHz ~ 25 GHz

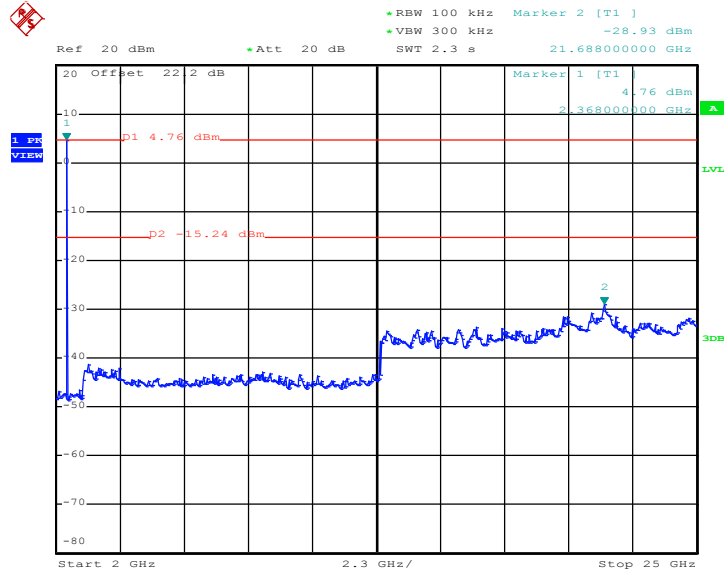

Date: 14.JAN.2019 14:58:54



CSE Plot on Ch 39 between 30MHz ~ 3 GHz

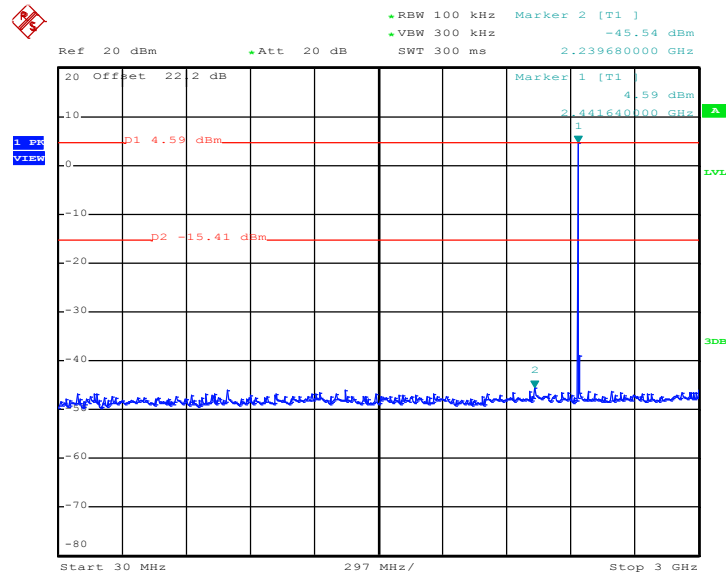

Date: 14.JAN.2019 15:02:10

CSE Plot on Ch 39 between 2 GHz ~ 25 GHz

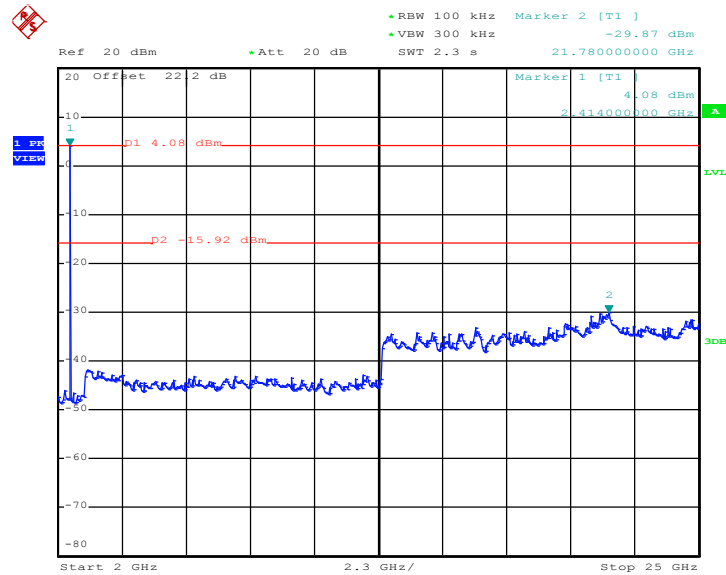

Date: 14.JAN.2019 15:02:41



CSE Plot on Ch 78 between 30MHz ~ 3 GHz

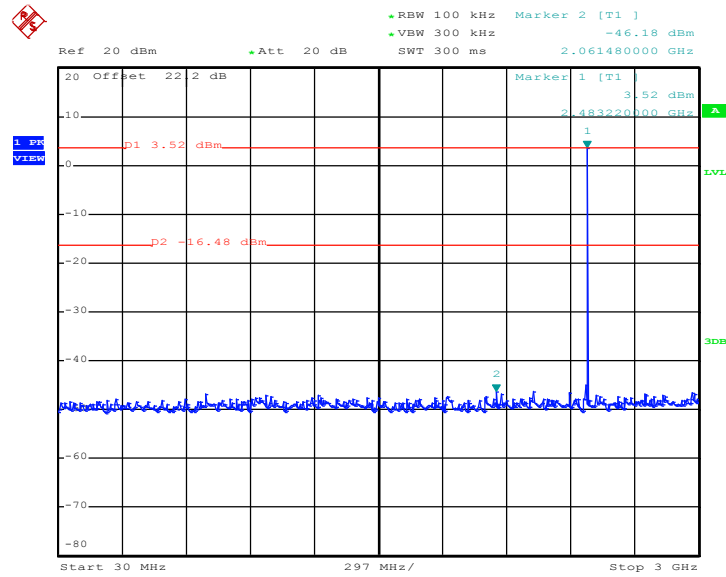

Date: 14.JAN.2019 15:08:50

CSE Plot on Ch 78 between 2 GHz ~ 25 GHz

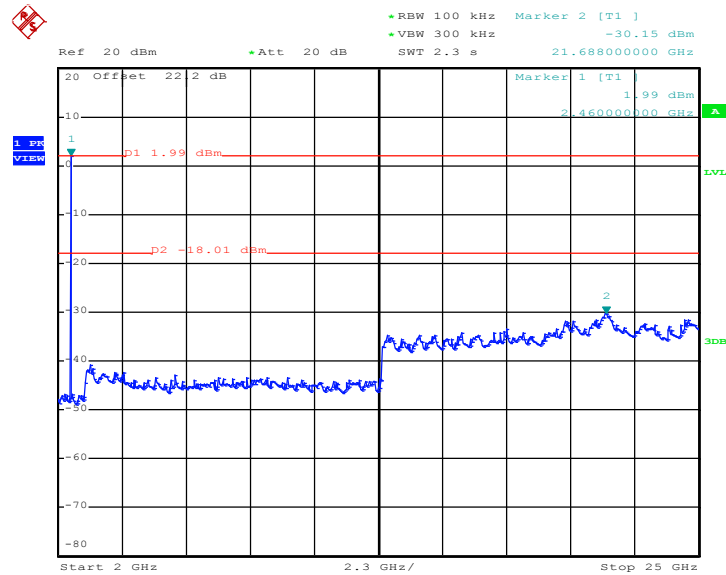

Date: 14.JAN.2019 15:09:17



3.8 Radiated Band Edges and Spurious Emission Measurement

3.8.1 Limit of Radiated Band Edges and Spurious Emission

In any 100 kHz bandwidth outside the intentional radiator frequency band, all harmonics/spurious must be at least 20 dB below the highest emission level within the authorized band. In addition, radiated emissions which fall in the restricted bands must also comply with the limits as below.

Frequency (MHz)	Field Strength (microvolts/meter)	Measurement Distance (meters)
0.009 – 0.490	2400/F(kHz)	300
0.490 – 1.705	24000/F(kHz)	30
1.705 – 30.0	30	30
30 – 88	100	3
88 – 216	150	3
216 - 960	200	3
Above 960	500	3

3.8.2 Measuring Instruments

See list of measuring equipment of this test report.



3.8.3 Test Procedures

1. The EUT was placed on a turntable with 0.8 meter for frequency below 1GHz and 1.5 meter for frequency above 1GHz respectively above ground.
2. The EUT was set 3 meters from the interference receiving antenna, which was mounted on the top of a variable height antenna tower.
3. For each suspected emission, the EUT was arranged to its worst case and then tune the Antenna tower (from 1 m to 4 m) and turntable (from 0 degree to 360 degrees) to find the maximum reading. A pre-amp and a high pass filter are used for the test in order to get better signal level to comply with the guidelines.
4. Set to the maximum power setting and enable the EUT transmit continuously.
5. Use the following spectrum analyzer settings:
 - (1) Span shall wide enough to fully capture the emission being measured;
 - (2) Set RBW=100 kHz for $f < 1$ GHz, RBW=1MHz for $f > 1$ GHz ; VBW \geq RBW; Sweep = auto; Detector function = peak; Trace = max hold for peak
 - (3) For average measurement: use duty cycle correction factor method per 15.35(c).
Duty cycle = On time/100 milliseconds
On time = $N_1 * L_1 + N_2 * L_2 + \dots + N_{n-1} * L_{n-1} + N_n * L_n$
Where N_1 is number of type 1 pulses, L_1 is length of type 1 pulses, etc.
Average Emission Level = Peak Emission Level + $20 * \log(\text{Duty cycle})$
6. Corrected Reading: Antenna Factor + Cable Loss + Read Level - Preamp Factor = Level
7. For testing below 1GHz, if the emission level of the EUT in peak mode was 3 dB lower than the limit specified, then peak values of EUT will be reported, otherwise, the emissions will be repeated one by one using the CISPR quasi-peak method and reported.
8. For testing above 1GHz, the emission level of the EUT in peak mode was 20dB lower than average limit (that means the emission level in average mode also complies with the limit in average mode), then peak values of EUT will be reported, otherwise, the emissions will be measured in average mode again and reported.

Note: The average levels were calculated from the peak level corrected with duty cycle correction factor (-24.79dB) derived from $20 \log(\text{dwell time}/100\text{ms})$. This correction is only for signals that hop with the fundamental signal, such as band-edge and harmonic. Other spurious signals that are independent of the hopping signal would not use this correction.

3.8.4 Test Setup

For radiated emissions below 30MHz

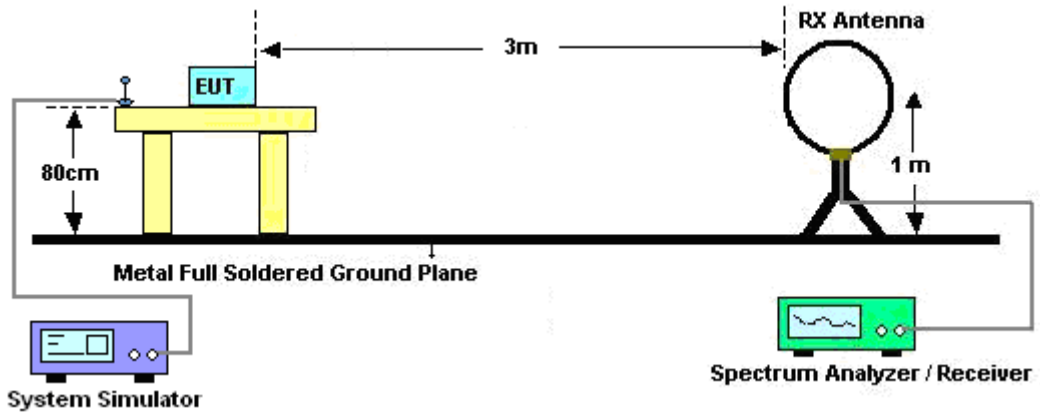

For radiated emissions from 30MHz to 1GHz

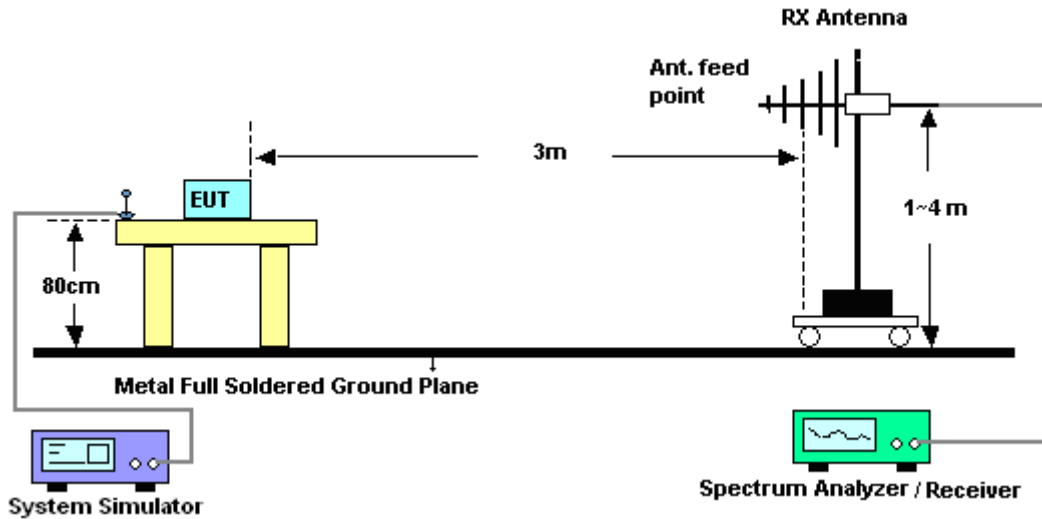

For radiated emissions above 1GHz

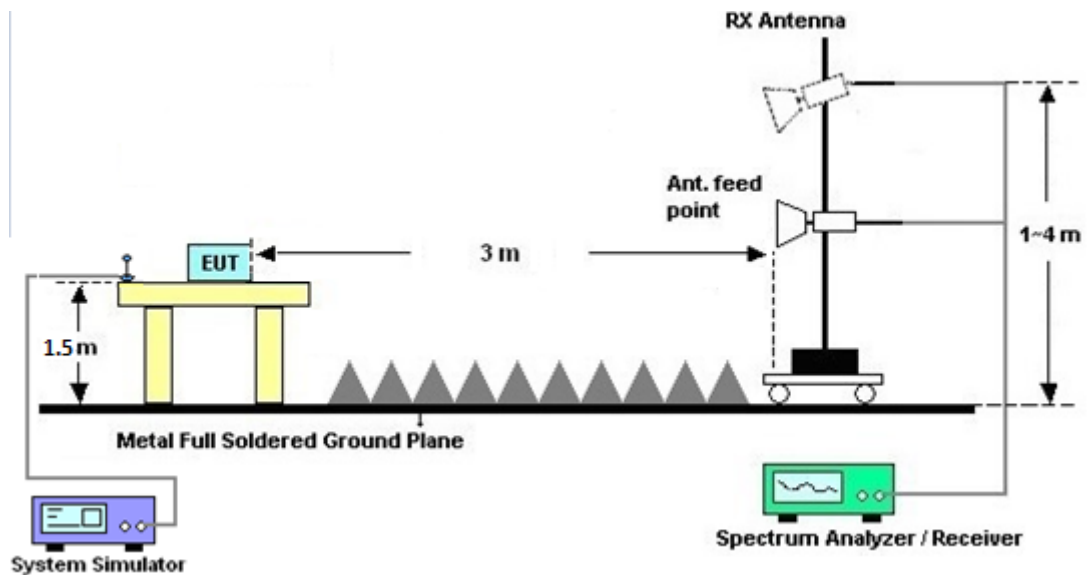

3.8.5 Test Results of Radiated Spurious Emissions (9 kHz ~ 30 MHz)

The low frequency, which started from 9 kHz to 30MHz, was pre-scanned and the result which was 20dB lower than the limit line was not reported.

There is a comparison data of both open-field test site and alternative test site - semi-Anechoic chamber according to 414788 D01 Radiated Test Site v01r01, and the result came out very similar.

3.8.6 Test Result of Radiated Spurious at Band Edges

Please refer to Appendix B and C.

3.8.7 Duty Cycle

Please refer to Appendix D.

3.8.8 Test Result of Radiated Spurious Emission (30MHz ~ 10th Harmonic)

Please refer to Appendix B and C.



3.9 AC Conducted Emission Measurement

3.9.1 Limit of AC Conducted Emission

For equipment that is designed to be connected to the public utility (AC) power line, the radio frequency voltage that is conducted back onto the AC power line on any frequency or frequencies within the band 150 kHz to 30 MHz shall not exceed the limits in the following table.

Frequency of emission (MHz)	Conducted limit (dB μ V)	
	Quasi-peak	Average
0.15-0.5	66 to 56*	56 to 46*
0.5-5	56	46
5-30	60	50

*Decreases with the logarithm of the frequency.

3.9.2 Measuring Instruments

See list of measuring equipment of this test report.

3.9.3 Test Procedures

1. The EUT was placed 0.4 meter from the conducting wall of the shielding room was kept at least 80 centimeters from any other grounded conducting surface.
2. Connect EUT to the power mains through a line impedance stabilization network (LISN).
3. All the support units are connecting to the other LISN.
4. The LISN provides 50 ohm coupling impedance for the measuring instrument.
5. The FCC states that a 50 ohm, 50 microhenry LISN should be used.
6. Both sides of AC line were checked for maximum conducted interference.
7. The frequency range from 150 kHz to 30 MHz was searched.
8. Set the test-receiver system to Peak Detect Function and specified bandwidth (IF Bandwidth = 9kHz) with Maximum Hold Mode. Then measurement is also conducted by Average Detector and Quasi-Peak Detector Function respectively.

3.9.4 Test Setup

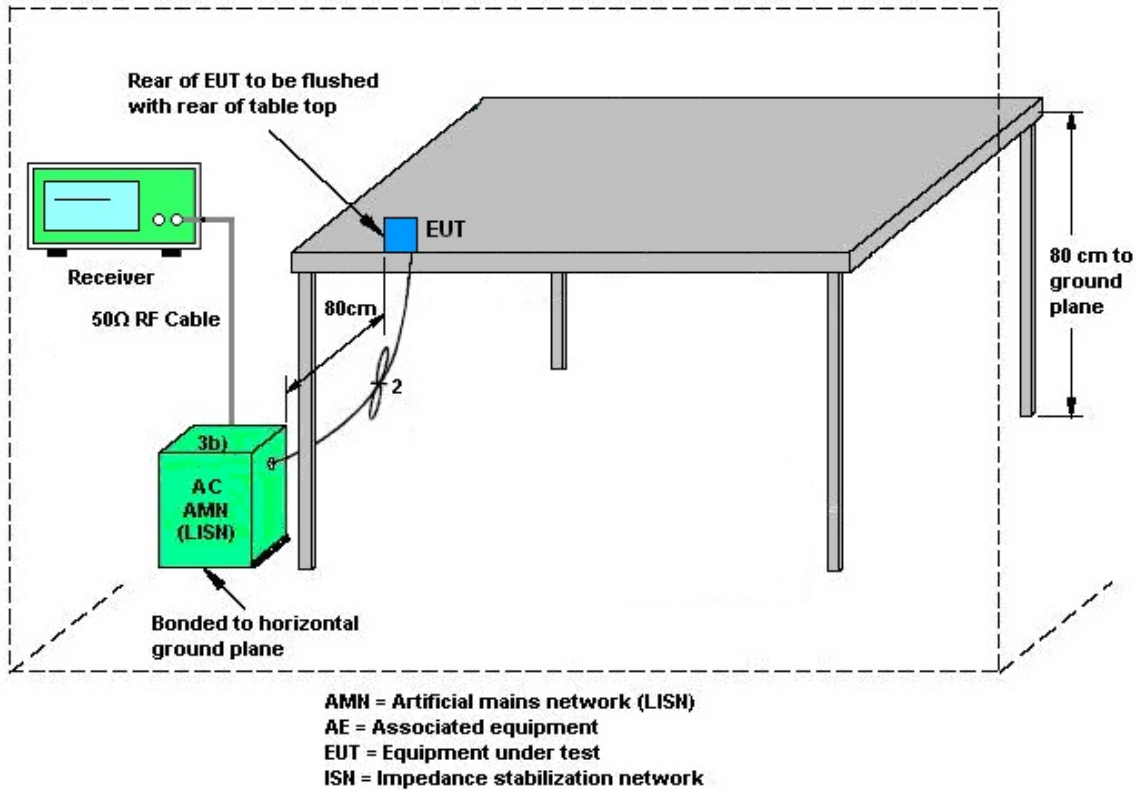

3.9.5 Test Result of AC Conducted Emission

Please refer to Appendix A.



3.10 Antenna Requirements

3.10.1 Standard Applicable

If directional gain of transmitting antennas is greater than 6dBi, the power shall be reduced by the same level in dB comparing to gain minus 6dBi. The use of a permanently attached antenna or of an antenna that uses a unique coupling to the intentional radiator shall be considered sufficient to comply with the rule.

3.10.2 Antenna Anti-Replacement Construction

An embedded-in antenna design is used.

3.10.3 Antenna Gain

The antenna peak gain of EUT is less than 6 dBi. Therefore, it is not necessary to reduce maximum peak output power limit.



4 List of Measuring Equipment

Instrument	Manufacturer	Model No.	Serial No.	Characteristics	Calibration Date	Test Date	Due Date	Remark
Power Meter	Agilent	E4416A	GB41292344	N/A	Dec. 27, 2018	Jan. 10, 2019~ Jan. 14, 2019	Dec. 26, 2019	Conducted (TH05-HY)
Power Sensor	Agilent	E9327A	US40441548	50MHz~18GHz	Dec. 27, 2018	Jan. 10, 2019~ Jan. 14, 2019	Dec. 26, 2019	Conducted (TH05-HY)
Spectrum Analyzer	Rohde & Schwarz	FSP40	100057	9kHz-40GHz	Nov. 21, 2018	Jan. 10, 2019~ Jan. 14, 2019	Nov. 20, 2019	Conducted (TH05-HY)
BT Base Station (Measure)	Rohde & Schwarz	CBT	101136	BT 3.0	Sep. 27, 2018	Jan. 10, 2019~ Jan. 14, 2019	Sep. 26, 2019	Conducted (TH05-HY)
Switch Box & RF Cable	Burgeon	ETF-058	EC1300484	N/A	Mar. 01, 2018	Jan. 10, 2019~ Jan. 14, 2019	Feb. 28, 2019	Conducted (TH05-HY)
AC Power Source	ChainTek	APC-1000W	N/A	N/A	N/A	Jan. 11, 2019	N/A	Conduction (CO05-HY)
EMI Test Receiver	Rohde & Schwarz	ESR3	102388	9KHz~3.6GHz	Nov. 12, 2018	Jan. 11, 2019	Nov. 11, 2019	Conduction (CO05-HY)
LISN	Rohde & Schwarz	ENV216	100080	9kHz~30MHz	Nov. 14, 2018	Jan. 11, 2019	Nov. 13, 2019	Conduction (CO05-HY)
Software	Rohde & Schwarz	EMC32 V10.30	N/A	N/A	N/A	Jan. 11, 2019	N/A	Conduction (CO05-HY)
LF Cable	HUBER + SUHNER	RG-214/U	LF01	N/A	Dec. 31, 2018	Jan. 11, 2019	Dec. 30, 2019	Conduction (CO05-HY)
Pulse Limiter	Rohde & Schwarz	ESH3-Z2	100851	N/A	Dec. 31, 2018	Jan. 11, 2019	Dec. 30, 2019	Conduction (CO05-HY)
Loop Antenna	Rohde & Schwarz	HFH2-Z2	100488	9 kHz~30 MHz	Jan. 07, 2019	Jan. 16, 2019~ Jan. 21, 2019	Jan. 06, 2020	Radiation (03CH16-HY)
Bilog Antenna	TESEQ	CBL6111D&0802N1D01N-06	47020&06	30MHz to 1GHz	Oct. 13, 2018	Jan. 16, 2019~ Jan. 21, 2019	Oct. 12, 2019	Radiation (03CH16-HY)
Horn Antenna	SCHWARZBECK	BBHA 9120 D	9120D-1522	1G~18GHz	Sep. 07, 2018	Jan. 16, 2019~ Jan. 21, 2019	Sep. 06, 2019	Radiation (03CH16-HY)
SHF-EHF Horn Antenna	SCHWARZBECK	BBHA 9170	BBHA9170576	18GHz ~ 40GHz	May 08, 2018	Jan. 16, 2019~ Jan. 21, 2019	May 07, 2019	Radiation (03CH16-HY)
EMI Test Receiver	Keysight	N9038A (MXE)	MY57290111	3Hz~26.5GHz	Nov. 29, 2018	Jan. 16, 2019~ Jan. 21, 2019	Nov. 28, 2019	Radiation (03CH16-HY)
Spectrum Analyzer	Agilent	N9010A	MY53470118	10Hz~44GHz	Apr. 17, 2018	Jan. 16, 2019~ Jan. 21, 2019	Apr. 16, 2019	Radiation (03CH16-HY)
Amplifier	SONOMA	310N	371607	9kHz~1000MHz	Oct. 02, 2018	Jan. 16, 2019~ Jan. 21, 2019	Oct. 01, 2019	Radiation (03CH16-HY)
Preamplifier	Jet-Power	JPA0118-55-303	1710001800054001	1GHz~18GHz	Apr. 16, 2018	Jan. 16, 2019~ Jan. 21, 2019	Apr. 15, 2019	Radiation (03CH16-HY)
Preamplifier	Keysight	83017A	MY53270147	1GHz~26.5GHz	Feb. 02, 2018	Jan. 16, 2019~ Jan. 21, 2019	Feb. 01, 2019	Radiation (03CH16-HY)
Amplifier	MITEQ	TTA1840-35-HG	1871923	18GHz~40GHz, VSWR : 2.5:1 max	Jul. 16, 2018	Jan. 16, 2019~ Jan. 21, 2019	Jul. 15, 2019	Radiation (03CH16-HY)
RF Cable	HUBER + SUHNER	SUCOFLEX 126E	0058/126E	30M-18G	Mar. 14, 2018	Jan. 16, 2019~ Jan. 21, 2019	Mar. 13, 2019	Radiation (03CH16-HY)
RF Cable	HUBER + SUHNER	SUCOFLEX 104	MY15539/4	30M-18G	Mar. 14, 2018	Jan. 16, 2019~ Jan. 21, 2019	Mar. 13, 2019	Radiation (03CH16-HY)
RF Cable	HUBER + SUHNER	SUCOFLEX 104	MY9837/4 PE	30M~18GHz	Mar. 14, 2018	Jan. 16, 2019~ Jan. 21, 2019	Mar. 13, 2019	Radiation (03CH16-HY)
RF Cable	HUBER + SUHNER	SUCOFLEX 104	MY36979/4	30M~18GHz	Mar. 14, 2018	Jan. 16, 2019~ Jan. 21, 2019	Mar. 13, 2019	Radiation (03CH16-HY)
Software	Audix	E3 6.2009-8-24	RK-001136	N/A	N/A	Jan. 16, 2019~ Jan. 21, 2019	N/A	Radiation (03CH16-HY)



5 Uncertainty of Evaluation

Uncertainty of Conducted Emission Measurement (150 kHz ~ 30 MHz)

Measuring Uncertainty for a Level of Confidence of 95% ($U = 2Uc(y)$)	2.2
---	-----

Uncertainty of Radiated Emission Measurement (30 MHz ~ 1000 MHz)

Measuring Uncertainty for a Level of Confidence of 95% ($U = 2Uc(y)$)	4.9
---	-----

Uncertainty of Radiated Emission Measurement (1000 MHz ~ 18000 MHz)

Measuring Uncertainty for a Level of Confidence of 95% ($U = 2Uc(y)$)	5.8
---	-----

Uncertainty of Radiated Emission Measurement (18000 MHz ~ 40000 MHz)

Measuring Uncertainty for a Level of Confidence of 95% ($U = 2Uc(y)$)	3.9
---	-----



Appendix A. AC Conducted Emission Test Results

Test Mode :	Mode 1	Temperature :	24~26°C
Test Engineer :	Jimmy Chang	Relative Humidity :	51~53%
Test Voltage :	120Vac / 60Hz	Phase :	Line

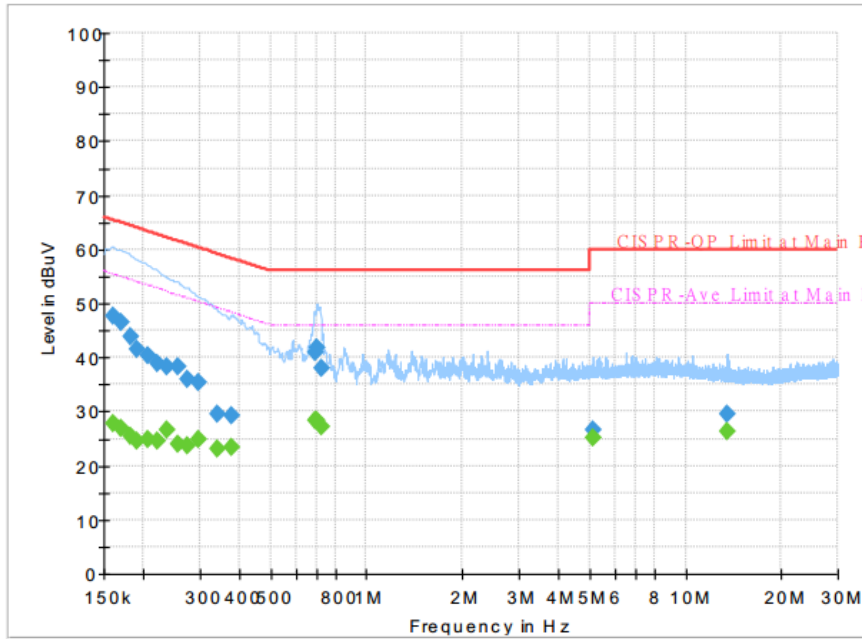

Final Result :

Frequency (MHz)	QuasiPeak (dBuV)	CAverage (dBuV)	Limit (dBuV)	Margin (dB)	Line	Filter	Corr. (dB)
0.161250	---	27.71	55.40	27.69	L1	OFF	19.5
0.161250	47.52	---	65.40	17.88	L1	OFF	19.5
0.170250	---	27.03	54.95	27.92	L1	OFF	19.5
0.170250	46.41	---	64.95	18.54	L1	OFF	19.5
0.181500	---	25.43	54.42	28.99	L1	OFF	19.5
0.181500	43.74	---	64.42	20.68	L1	OFF	19.5
0.190500	---	24.69	54.02	29.33	L1	OFF	19.5
0.190500	41.45	---	64.02	22.57	L1	OFF	19.5
0.206250	---	24.90	53.36	28.46	L1	OFF	19.5
0.206250	40.47	---	63.36	22.89	L1	OFF	19.5
0.219750	---	24.55	52.83	28.28	L1	OFF	19.5
0.219750	39.01	---	62.83	23.82	L1	OFF	19.5
0.235500	---	26.72	52.25	25.53	L1	OFF	19.5
0.235500	38.17	---	62.25	24.08	L1	OFF	19.5
0.255750	---	23.90	51.57	27.67	L1	OFF	19.5
0.255750	38.23	---	61.57	23.34	L1	OFF	19.5
0.273750	---	23.74	51.00	27.26	L1	OFF	19.5
0.273750	35.83	---	61.00	25.17	L1	OFF	19.5
0.296250	---	24.84	50.35	25.51	L1	OFF	19.5
0.296250	35.43	---	60.35	24.92	L1	OFF	19.5
0.341250	---	23.10	49.17	26.07	L1	OFF	19.5
0.341250	29.40	---	59.17	29.77	L1	OFF	19.5



Test Mode :	Mode 1	Temperature :	24~26°C
Test Engineer :	Jimmy Chang	Relative Humidity :	51~53%
Test Voltage :	120Vac / 60Hz	Phase :	Line

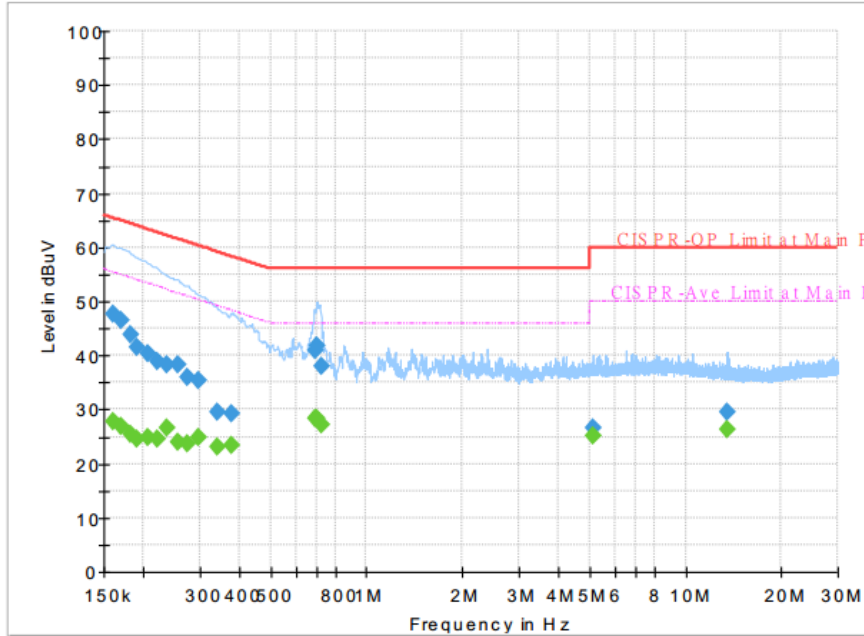

Final Result :

Frequency (MHz)	QuasiPeak (dBuV)	CAverage (dBuV)	Limit (dBuV)	Margin (dB)	Line	Filter	Corr. (dB)
0.379500	---	23.42	48.29	24.87	L1	OFF	19.5
0.379500	29.33	---	58.29	28.96	L1	OFF	19.5
0.690000	---	28.30	46.00	17.70	L1	OFF	19.6
0.690000	40.89	---	56.00	15.11	L1	OFF	19.6
0.701250	---	28.24	46.00	17.76	L1	OFF	19.6
0.701250	41.92	---	56.00	14.08	L1	OFF	19.6
0.719250	---	27.25	46.00	18.75	L1	OFF	19.6
0.719250	38.10	---	56.00	17.90	L1	OFF	19.6
5.147250	---	25.17	50.00	24.83	L1	OFF	19.7
5.147250	26.65	---	60.00	33.35	L1	OFF	19.7
13.560000	---	26.23	50.00	23.77	L1	OFF	20.0
13.560000	29.39	---	60.00	30.61	L1	OFF	20.0



Tese Mode :	Mode 1	Temperature :	24~26°C
Test Engineer :	Jimmy Chang	Relative Humidity :	51~53%
Test Voltage :	120Vac / 60Hz	Phase :	Neutral

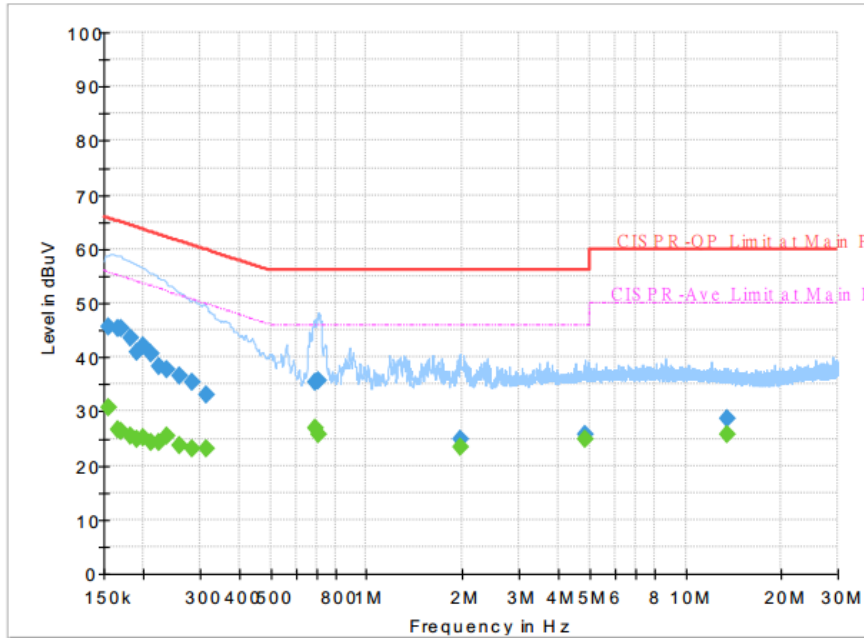

Final Result :

Frequency (MHz)	QuasiPeak (dBuV)	CAverage (dBuV)	Limit (dBuV)	Margin (dB)	Line	Filter	Corr. (dB)
0.154500	---	30.78	55.75	24.97	N	OFF	19.5
0.154500	45.49	---	65.75	20.26	N	OFF	19.5
0.165750	---	26.73	55.17	28.44	N	OFF	19.5
0.165750	45.35	---	65.17	19.82	N	OFF	19.5
0.170250	---	26.38	54.95	28.57	N	OFF	19.5
0.170250	45.30	---	64.95	19.65	N	OFF	19.5
0.181500	---	25.43	54.42	28.99	N	OFF	19.5
0.181500	43.69	---	64.42	20.73	N	OFF	19.5
0.190500	---	24.80	54.02	29.22	N	OFF	19.5
0.190500	40.83	---	64.02	23.19	N	OFF	19.5
0.199500	---	25.07	53.63	28.56	N	OFF	19.5
0.199500	42.01	---	63.63	21.62	N	OFF	19.5
0.210750	---	24.37	53.18	28.81	N	OFF	19.5
0.210750	40.73	---	63.18	22.45	N	OFF	19.5
0.224250	---	24.29	52.66	28.37	N	OFF	19.5
0.224250	38.44	---	62.66	24.22	N	OFF	19.5
0.237750	---	25.48	52.17	26.69	N	OFF	19.5
0.237750	37.83	---	62.17	24.34	N	OFF	19.5
0.258000	---	23.69	51.50	27.81	N	OFF	19.5
0.258000	36.47	---	61.50	25.03	N	OFF	19.5
0.285000	---	23.24	50.67	27.43	N	OFF	19.5
0.285000	35.24	---	60.67	25.43	N	OFF	19.5
0.314250	---	23.08	49.86	26.78	N	OFF	19.5
0.314250	33.04	---	59.86	26.82	N	OFF	19.5



Tese Mode :	Mode 1	Temperature :	24~26°C
Test Engineer :	Jimmy Chang	Relative Humidity :	51~53%
Test Voltage :	120Vac / 60Hz	Phase :	Neutral

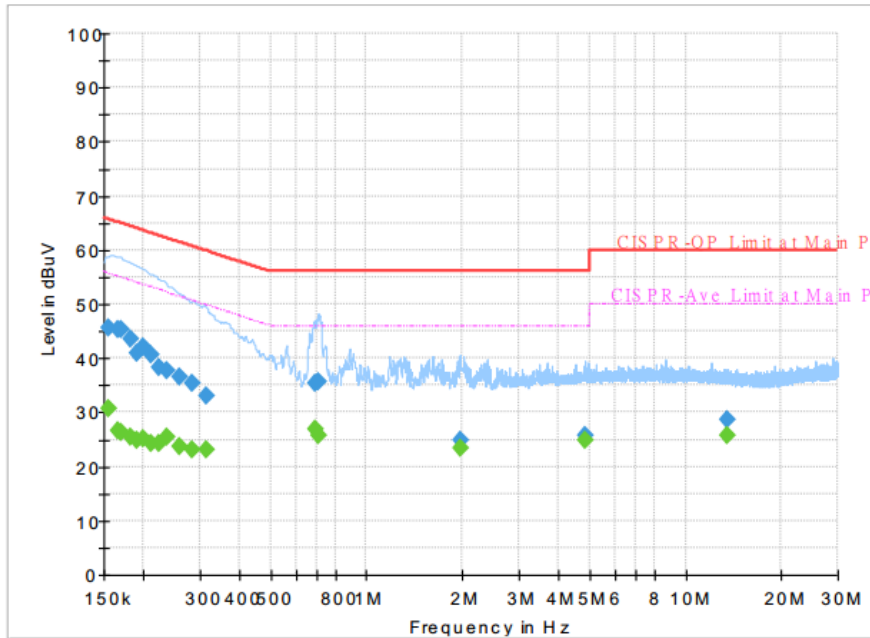

Final Result :

Frequency (MHz)	QuasiPeak (dBuV)	CAverage (dBuV)	Limit (dBuV)	Margin (dB)	Line	Filter	Corr. (dB)
0.687750	---	26.76	46.00	19.24	N	OFF	19.6
0.687750	35.32	---	56.00	20.68	N	OFF	19.6
0.705750	---	25.83	46.00	20.17	N	OFF	19.6
0.705750	35.69	---	56.00	20.31	N	OFF	19.6
1.959000	---	23.32	46.00	22.68	N	OFF	19.6
1.959000	24.90	---	56.00	31.10	N	OFF	19.6
4.839000	---	24.76	46.00	21.24	N	OFF	19.7
4.839000	25.85	---	56.00	30.15	N	OFF	19.7
13.560000	---	25.82	50.00	24.18	N	OFF	20.1
13.560000	28.56	---	60.00	31.44	N	OFF	20.1



Appendix B. Radiated Spurious Emission

Test Engineer :	Jacky Hung, CR Liao, and Andy Yang	Temperature :	23~25°C
		Relative Humidity :	55~57%

2.4GHz 2400~2483.5MHz

BT (Band Edge @ 3m)

BT	Note	Frequency (MHz)	Level (dBμV/m)	Over Limit (dB)	Limit Line (dBμV/m)	Read Level (dBμV)	Antenna Factor (dB/m)	Path Loss (dB)	Preamp Factor (dB)	Ant Pos (cm)	Table Pos (deg)	Peak Avg. (P/A)	Pol. (H/V)	
BT CH00 2402MHz		2372.37	47.01	-26.99	74	41.44	27.19	8.37	29.99	106	311	P	H	
		2372.37	22.22	-31.78	54	-	-	-	-	-	-	A	H	
	*	2402	108.12	-	-	102.44	27.26	8.41	29.99	106	311	P	H	
	*	2402	83.33	-	-	-	-	-	-	-	-	A	H	
		2385.6	46.71	-27.29	74	41.08	27.23	8.39	29.99	349	8	P	V	
		2385.6	21.92	-32.08	54	-	-	-	-	-	-	A	V	
	*	2402	106.42	-	-	100.74	27.26	8.41	29.99	349	8	P	V	
	*	2402	81.63	-	-	-	-	-	-	-	-	A	V	
BT CH 39 2441MHz		2348.78	47.79	-26.21	74	42.31	27.14	8.34	30	100	310	P	H	
		2348.78	23	-31	54	-	-	-	-	-	-	A	H	
	*	2441	108.81	-	-	102.99	27.36	8.43	29.97	100	310	P	H	
	*	2441	84.02	-	-	-	-	-	-	-	-	A	H	
		2491.53	47.1	-26.9	74	41.13	27.48	8.46	29.97	100	310	P	H	
		2491.53	22.31	-31.69	54	-	-	-	-	-	-	A	H	
		2323.44	46.55	-27.45	74	41.18	27.08	8.3	30.01	384	36	P	V	
		2323.44	21.76	-32.24	54	-	-	-	-	-	-	A	V	
	*	2441	106.93	-	-	101.11	27.36	8.43	29.97	384	36	P	V	
	*	2441	82.14	-	-	-	-	-	-	-	-	A	V	
		2495.1	46.78	-27.22	74	40.78	27.49	8.47	29.96	384	36	P	V	
		2495.1	21.99	-32.01	54	-	-	-	-	-	-	A	V	



BT CH 78 2480MHz	*	2480	107.88	-	-	101.94	27.45	8.46	29.97	100	314	P	H
	*	2480	83.09	-	-	-	-	-	-	-	-	A	H
		2483.64	56	-18	74	50.05	27.46	8.46	29.97	100	314	P	H
		2483.64	31.21	-22.79	54	-	-	-	-	-	-	A	H
	*	2480	105.73	-	-	99.79	27.45	8.46	29.97	375	37	P	V
	*	2480	80.94	-	-	-	-	-	-	-	-	A	V
		2483.6	53.68	-20.32	74	47.73	27.46	8.46	29.97	375	37	P	V
		2483.6	28.89	-25.11	54	-	-	-	-	-	-	A	V
Remark	1. No other spurious found. 2. All results are PASS against Peak and Average limit line.												



2.4GHz 2400~2483.5MHz
BT (Harmonic @ 3m)

BT	Note	Frequency (MHz)	Level (dBμV/m)	Over Limit (dB)	Limit Line (dBμV/m)	Read Level (dBμV)	Antenna Factor (dB/m)	Path Loss (dB)	Preamp Factor (dB)	Ant Pos (cm)	Table Pos (deg)	Peak Avg. (P/A)	Pol. (H/V)	
BT CH 00 2402MHz		4804	38.54	-35.46	74	52.14	31.21	13.73	58.54	100	0	P	H	
		4804	13.75	-40.25	54	-	-	-	-	-	-	A	H	
													H	
													H	
		4804	38.52	-35.48	74	52.12	31.21	13.73	58.54	100	0	P	V	
		4804	13.73	-40.27	54	-	-	-	-	-	-	-	A	V
														V
														V
BT CH 39 2441MHz		4882	39.32	-34.68	74	52.62	31.36	13.86	58.52	100	0	P	H	
		4882	14.53	-39.47	54	-	-	-	-	-	-	A	H	
		7323	43.02	-30.98	74	50.67	36.1	15.21	58.96	100	0	P	H	
		7323	18.23	-35.77	54	-	-	-	-	-	-	A	H	
		4882	38.62	-35.38	74	51.92	31.36	13.86	58.52	100	0	P	V	
		4882	13.83	-40.17	54	-	-	-	-	-	-	A	V	
		7323	42.38	-31.62	74	50.03	36.1	15.21	58.96	100	0	P	V	
		7323	17.59	-36.41	54	-	-	-	-	-	-	A	V	
BT CH 78 2480MHz		4960	39.15	-34.85	74	52.17	31.52	13.97	58.51	100	0	P	H	
		4960	14.36	-39.64	54	-	-	-	-	-	-	A	H	
		7440	42.26	-31.74	74	49.4	36.43	15.28	58.85	100	0	P	H	
		7440	17.47	-36.53	54	-	-	-	-	-	-	A	H	
		4960	39.47	-34.53	74	52.49	31.52	13.97	58.51	100	0	P	V	
		4960	14.68	-39.32	54	-	-	-	-	-	-	A	V	
		7440	42.43	-31.57	74	49.57	36.43	15.28	58.85	100	0	P	V	
		7440	17.64	-36.36	54	-	-	-	-	-	-	A	V	
Remark	1. No other spurious found. 2. All results are PASS against Peak and Average limit line.													



Note symbol

*	Fundamental Frequency which can be ignored. However, the level of any unwanted emissions shall not exceed the level of the fundamental frequency.
!	Test result is over limit line.
P/A	Peak or Average
H/V	Horizontal or Vertical



A calculation example for radiated spurious emission is shown as below:

BT	Note	Frequency	Level	Over	Limit	Read	Antenna	Path	Preamp	Ant	Table	Peak	Pol.
		(MHz)	(dBμV/m)	(dB)	(dBμV/m)	(dBμV)	(dB/m)	(dB)	(dB)	(cm)	(deg)	(P/A)	(H/V)
BT CH 00 2402MHz		2390	55.45	-18.55	74	54.51	32.22	4.58	35.86	103	308	P	H
		2390	43.54	-10.46	54	42.6	32.22	4.58	35.86	103	308	A	H

1. Path Loss(dB) = Cable loss(dB) + Filter loss(dB) + Attenuator loss(dB)
2. Level(dBμV/m) =
Antenna Factor(dB/m) + Path Loss(dB) + Read Level(dBμV) - Preamp Factor(dB)
3. Over Limit(dB) = Level(dBμV/m) – Limit Line(dBμV/m)

For Peak Limit @ 2390MHz:

1. Level(dBμV/m)
= Antenna Factor(dB/m) + Path Loss(dB) + Read Level(dBμV) - Preamp Factor(dB)
= 32.22(dB/m) + 4.58(dB) + 54.51(dBμV) – 35.86 (dB)
= 55.45 (dBμV/m)
2. Over Limit(dB)
= Level(dBμV/m) – Limit Line(dBμV/m)
= 55.45(dBμV/m) – 74(dBμV/m)
= -18.55(dB)

For Average Limit @ 2390MHz:

1. Level(dBμV/m)
= Antenna Factor(dB/m) + Path Loss(dB) + Read Level(dBμV) - Preamp Factor(dB)
= 32.22(dB/m) + 4.58(dB) + 42.6(dBμV) – 35.86 (dB)
= 43.54 (dBμV/m)
2. Over Limit(dB)
= Level(dBμV/m) – Limit Line(dBμV/m)
= 43.54(dBμV/m) – 54(dBμV/m)
= -10.46(dB)

Both peak and average measured complies with the limit line, so test result is “PASS”.



Appendix C. Radiated Spurious Emission Plots

Test Engineer :	Jacky Hung, CR Liao, and Andy Yang	Temperature :	23~25°C
		Relative Humidity :	55~57%

2.4GHz 2400~2483.5MHz

BT (Band Edge @ 3m)

BT	2.4GHz 2400~2483.5MHz Band Edge @ 3m	
ANT	BT CH00 2402MHz	
1	Horizontal	Fundamental
Peak	<p> Site : 03CH16-HY Condition : PEAK_BE_74 3m 91200_1522 HORIZONTAL Detector : Peak Project : 910212 </p>	<p> Site : 03CH16-HY Condition : PEAK_74 3m 91200_1522 HORIZONTAL Detector : Peak Project : 910212 </p>

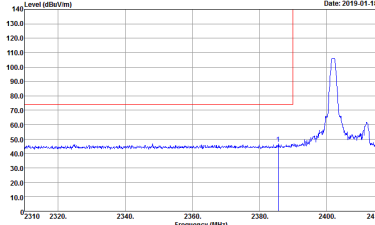
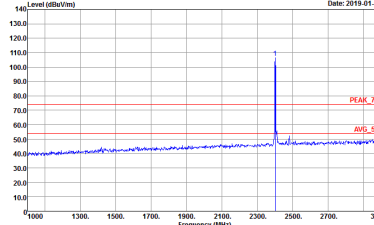

BT	2.4GHz 2400~2483.5MHz Band Edge @ 3m	
ANT	BT CH00 2402MHz	
1	Vertical	Fundamental
Peak	 <p data-bbox="430 712 702 772">Site : 03CH16-HY Condition : PEAK_8E_74 3m 91200_1522 VERTICAL RBW:1000.000KHz VBW:3000.000KHz SWT:Auto Detector : Peak Project : 910212</p>	 <p data-bbox="901 712 1173 772">Site : 03CH16-HY Condition : PEAK_74 3m 91200_1522 VERTICAL RBW:1000.000KHz VBW:3000.000KHz SWT:Auto Detector : Peak Project : 910212</p>



BT	2.4GHz 2400~2483.5MHz Band Edge @ 3m	
ANT	BT CH39 2441MHz	
1	Horizontal	Fundamental
Peak	<p>Site : 03CH16-HY Condition : PEAK_BE_74 3m 91200_1522 HORIZONTAL : RBW:1000.000KHz VBW:3000.000KHz SWF:Auto Detector : Peak Project : 910212</p>	<p>Site : 03CH16-HY Condition : PEAK_74 3m 91200_1522 HORIZONTAL : RBW:1000.000KHz VBW:3000.000KHz SWF:Auto Detector : Peak Project : 910212</p>
Peak	<p>Site : 03CH16-HY Condition : PEAK_BE_74 3m 91200_1522 HORIZONTAL : RBW:1000.000KHz VBW:3000.000KHz SWF:Auto Detector : Peak Project : 910212</p>	Left blank



BT	2.4GHz 2400~2483.5MHz Band Edge @ 3m	
ANT	BT CH39 2441MHz	
1	Vertical	Fundamental
Peak	<p>Site : 03CH16-HY Condition : PEAK_BE_74 3m 91200_1522 VERTICAL RBW:1000.000KHz VBW:3000.000KHz SWT:Auto Detector : Peak Project : 910212</p>	<p>Site : 03CH16-HY Condition : PEAK_74 3m 91200_1522 VERTICAL RBW:1000.000KHz VBW:3000.000KHz SWT:Auto Detector : Peak Project : 910212</p>
Peak	<p>Site : 03CH16-HY Condition : PEAK_BE_74 3m 91200_1522 VERTICAL RBW:1000.000KHz VBW:3000.000KHz SWT:Auto Detector : Peak Project : 910212</p>	Left blank

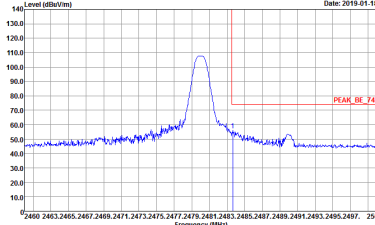
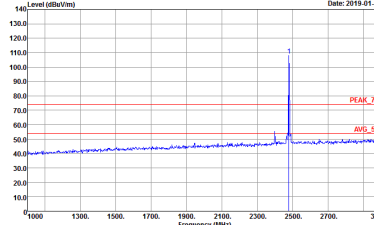

BT	2.4GHz 2400~2483.5MHz Band Edge @ 3m	
ANT	BT CH78 2480MHz	
1	Horizontal	Fundamental
Peak	 <p>Site : 03CH16-HY Condition : PEAK_BE_74 3m 91200_1522 HORIZONTAL RBW:1000.000KHz VBW:3000.000KHz SWT:Auto Detector : Peak Project : 910212</p>	 <p>Site : 03CH16-HY Condition : PEAK_74 3m 91200_1522 HORIZONTAL RBW:1000.000KHz VBW:3000.000KHz SWT:Auto Detector : Peak Project : 910212</p>

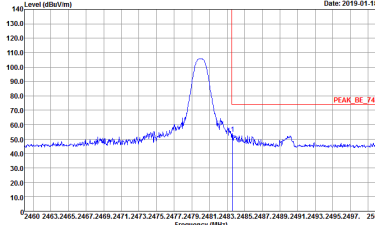
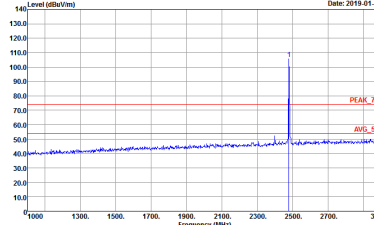

BT	2.4GHz 2400~2483.5MHz Band Edge @ 3m	
ANT	BT CH78 2480MHz	
1	Vertical	Fundamental
Peak	 <p>Date: 2019-01-18</p> <p>PEAK_BE_74</p> <p>Site : 03CH16-HY Condition : PEAK_BE_74 3m 91200_1522 VERTICAL RBW:1000.000KHz VBW:3000.000KHz SWT:Auto Detector : Peak Project : 910212</p>	 <p>Date: 2019-01-18</p> <p>PEAK_74</p> <p>Site : 03CH16-HY Condition : PEAK_74 3m 91200_1522 VERTICAL RBW:1000.000KHz VBW:3000.000KHz SWT:Auto Detector : Peak Project : 910212</p>



2.4GHz 2400~2483.5MHz

BT (Harmonic @ 3m)

BT	2.4GHz 2400~2483.5MHz Harmonic @ 3m	
ANT	BT CH00 2402MHz	
1	Horizontal	Vertical
Peak Avg.	<p>Site : 03CH16-4Y Condition : PEAK_74 3m 91200_1522 HORIZONTAL Detector : Peak Project : 910212</p>	<p>Site : 03CH16-4Y Condition : PEAK_74 3m 91200_1522 VERTICAL Detector : Peak Project : 910212</p>



BT	2.4GHz 2400~2483.5MHz Harmonic @ 3m	
ANT	BT CH39 2441MHz	
1	Horizontal	Vertical
Peak Avg.	<p>Site : 03CH16-HY Condition : PEAK_74 3m 91200_1522 HORIZONTAL Detector : Peak Project : 910212</p>	<p>Site : 03CH16-HY Condition : PEAK_74 3m 91200_1522 VERTICAL Detector : Peak Project : 910212</p>

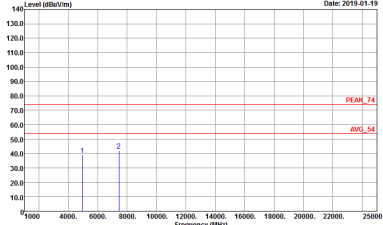
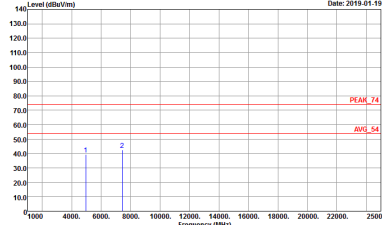

BT	2.4GHz 2400~2483.5MHz Harmonic @ 3m	
ANT	BT CH78 2480MHz	
1	Horizontal	Vertical
<p>Peak</p> <p>Avg.</p>	 <p>Site : 03CH16-HY Condition : PEAK_74 3m 91200_1522 HORIZONTAL Detector : Peak Project : 910212</p>	 <p>Site : 03CH16-HY Condition : PEAK_74 3m 91200_1522 VERTICAL Detector : Peak Project : 910212</p>



Emission below 1GHz

2.4GHz BT (LF)

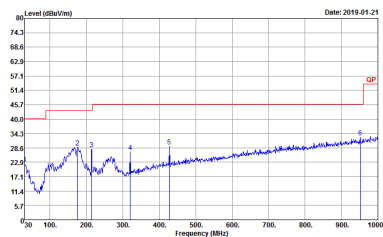
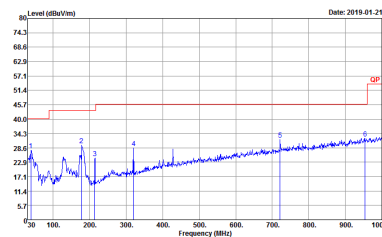
BT	2.4GHz 2400~2483.5MHz	
ANT	BT LF	
1	Horizontal	Vertical
QP / Peak	 <p>Site : 03CH16-HY Condition : QP 3m BTLOG_47020406 HORIZONTAL Detector : Peak Project : 910212</p>	 <p>Site : 03CH16-HY Condition : QP 3m BTLOG_47020406 VERTICAL Detector : Peak Project : 910212</p>

Appendix D. Duty Cycle Plots

DH5 on time (One Pulse) Plot on Channel 39

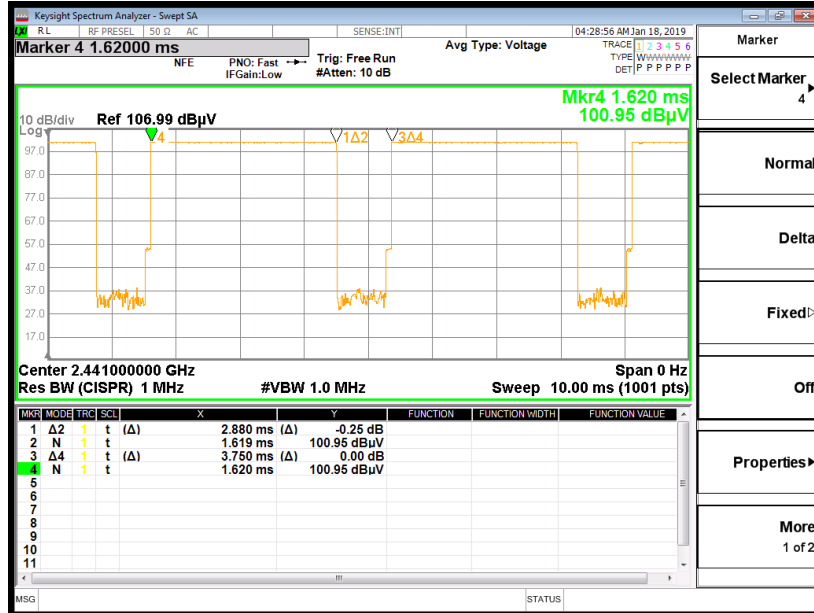

on time (Count Pulses) Plot on Channel 39

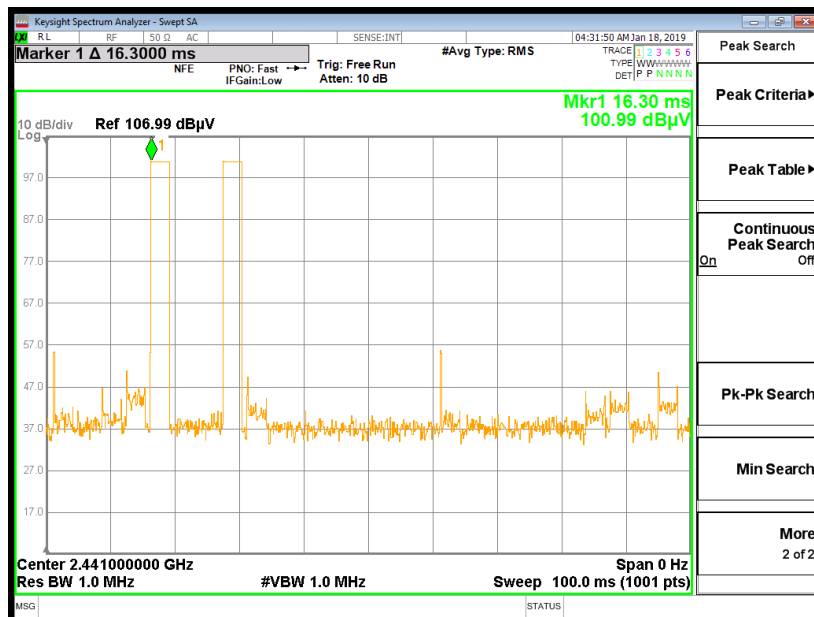

Note:

1. Worst case Duty cycle = on time/100 milliseconds = $2 * 2.88 / 100 = 5.76 \%$
2. Worst case Duty cycle correction factor = $20 * \log(\text{Duty cycle}) = -24.79 \text{ dB}$
3. **DH5** has the highest duty cycle worst case and is reported.



Duty Cycle Correction Factor Consideration for AFH mode:

Bluetooth normal hopping rate is 1600Hz and reduced to 800Hz in AFH mode; due to the reduced number of hopping frequencies, with the same packet configuration the dwell time in each channel frequency within 100msec period is longer in AFH mode than normal mode.

In AFH mode, the minimum hopping frequencies are 20, to get the longest dwell time DH5 packet is observed; the period to have DH5 packet completing one hopping sequence is

$$2.88 \text{ ms} \times 20 \text{ channels} = 57.6 \text{ ms}$$

There cannot be 2 complete hopping sequences within 100ms period, considering the random hopping behavior, maximum 2 hops can be possibly observed within the period. $[100\text{ms} / 57.6\text{ms}] = 2$ hops

Thus, the maximum possible ON time:

$$2.88 \text{ ms} \times 2 = 5.76 \text{ ms}$$

Worst case Duty Cycle Correction factor, which is derived from the maximum possible ON time,

$$20 \times \log(5.76 \text{ ms}/100\text{ms}) = -24.79 \text{ dB}$$