

# RF TEST REPORT



Report No.: 18071070-FCC-R

Supersede Report No.: N/A

Applicant	Southern Telecom Inc.	
Product Name	HD WI-FI Security Camera	
Model No.	SVC561	
Serial No.	N/A	
Test Standard	FCC Part 15.247, ANSI C63.10: 2013	
Test Date	September 18 to 25, 2018	
Issue Date	September 26, 2018	
Test Result	<input checked="" type="checkbox"/> Pass <input type="checkbox"/> Fail	
Equipment complied with the specification	<input checked="" type="checkbox"/>	
Equipment did not comply with the specification	<input type="checkbox"/>	
		
Aaron Liang Test Engineer	David Huang Checked By	
This test report may be reproduced in full only Test result presented in this test report is applicable to the tested sample only		

Issued by:

**SIEMIC (SHENZHEN-CHINA) LABORATORIES**

Zone A, Floor 1, Building 2 Wan Ye Long Technology Park

South Side of Zhoushi Road, Bao' an District, Shenzhen, Guangdong China 518108

Phone: +86 0755 2601 4629801 Email: [China@siemic.com.cn](mailto:China@siemic.com.cn)

## Laboratories Introduction

SIEMIC, headquartered in the heart of Silicon Valley, with superior facilities in US and Asia, is one of the leading independent testing and certification facilities providing customers with one-stop shop services for Compliance Testing and Global Certifications.



In addition to testing and certification, SIEMIC provides initial design reviews and compliance management throughout a project. Our extensive experience with China, Asia Pacific, North America, European, and International compliance requirements, assures the fastest, most cost effective way to attain regulatory compliance for the global markets.

### Accreditations for Conformity Assessment

Country/Region	Scope
USA	EMC, RF/Wireless, SAR, Telecom
Canada	EMC, RF/Wireless, SAR, Telecom
Taiwan	EMC, RF, Telecom, SAR, Safety
Hong Kong	RF/Wireless, SAR, Telecom
Australia	EMC, RF, Telecom, SAR, Safety
Korea	EMI, EMS, RF, SAR, Telecom, Safety
Japan	EMI, RF/Wireless, SAR, Telecom
Singapore	EMC, RF, SAR, Telecom
Europe	EMC, RF, SAR, Telecom, Safety

Test Report No.	18071070-FCC-R
Page	3 of 26

This page has been left blank intentionally.

# CONTENTS

1. REPORT REVISION HISTORY.....	5
2. CUSTOMER INFORMATION .....	5
3. TEST SITE INFORMATION.....	5
4. EQUIPMENT UNDER TEST (EUT) INFORMATION .....	6
5. TEST SUMMARY .....	8
6. MEASUREMENTS, EXAMINATION AND DERIVED RESULTS .....	9
6.1 AC POWER LINE CONDUCTED EMISSIONS.....	9
6.2 RADIATED SPURIOUS EMISSIONS & RESTRICTED BAND .....	15
ANNEX A. TEST INSTRUMENT.....	21
ANNEX B. TEST SETUP AND SUPPORTING EQUIPMENT.....	22
ANNEX C. USER MANUAL / BLOCK DIAGRAM / SCHEMATICS / PARTLIST/ DECLARATION OF SIMILARITY.....	26

## 1. Report Revision History

Report No.	Report Version	Description	Issue Date
18071070-FCC-R	NONE	Original	September 26, 2018

## 2. Customer information

Applicant Name	Southern Telecom Inc.
Applicant Add	5601 1st Ave, 2nd Floor Brooklyn New York United States
Manufacturer	Southern Telecom Inc.
Manufacturer Add	5601 1st Ave, 2nd Floor Brooklyn New York United States

## 3. Test site information

Test Lab :

Lab performing tests	SIEMIC (Shenzhen-China) LABORATORIES
Lab Address	Zone A, Floor 1, Building 2 Wan Ye Long Technology Park South Side of Zhoushi Road, Bao' an District, Shenzhen, Guangdong China 518108
FCC Test Site No.	535293
IC Test Site No.	4842E-1
Test Software	Radiated Emission Program-To Shenzhen v2.0

## 4. Equipment under Test (EUT) Information

Description of EUT:	HD WI-FI Security Camera
Main Model:	SVC561
Serial Model:	N/A
Date EUT received:	September 17 , 2018
Test Date(s):	September 18 to 25, 2018
Equipment Category :	DTS
Antenna Gain:	WIFI: 2.5dBi
Antenna Type:	PCB Antenna
Type of Modulation:	802.11b/g/n: DSSS, OFDM
RF Operating Frequency (ies):	WIFI: 802.11b/g/n(20M): 2412-2462 MHz
Number of Channels:	WIFI :802.11b/g/n(20M): 11CH
Port:	Please refer to the user manual
Input Power:	Adapter: Model: A18A-050100U-US2 Input: AC100-240V~50/60Hz,Max.0.2A Output: DC 5V , 1A
Trade Name :	SHARPER IMAGE
FCC ID:	2ABV4SVC561

**Mark:**

Revision Number	Adapter Model	Report Number	Description of Revision	Date of Revision
0	D31-05050100	18070602-FCC-R	Original Report	July 18, 2018
1	A18A-050100U-US2	18071070-FCC-R	Amended Report	September 26, 2018

Note: This is the amended report application (18071070-FCC-R) of the device, the original submission (18070602-FCC-R) was granted on July 18, 2018. The difference between the original device and the current one was as following the detail information:

**The difference is for different Adapter**

And based on the above differences, we will retest the “ AC Power Line Conducted Emissions and Radiated Emissions” test data, and others please refer to report 18070602-FCC-R.

## 5. Test Summary

The product was tested in accordance with the following specifications.

All testing has been performed according to below product classification:

FCC Rules	Description of Test	Result
§15.207 (a),	AC Power Line Conducted Emissions	Compliance
§15.205, §15.209, §15.247(d)	Radiated Emissions & Unwanted Emissions into Restricted Frequency Bands	Compliance

### Measurement Uncertainty

Emissions		
Test Item	Description	Uncertainty
Band-Edge & Unwanted Emissions into Restricted Frequency Bands and Radiated Emissions & Unwanted Emissions into Restricted Frequency Bands	Confidence level of approximately 95% (in the case where distributions are normal), with a coverage factor of 2 (for EUTs < 0.5m X 0.5m X 0.5m)	+5.6dB/-4.5dB
-	-	-



## 6. Measurements, Examination And Derived Results

### 6.1 AC Power Line Conducted Emissions

Temperature	26 °C
Relative Humidity	55%
Atmospheric Pressure	1017mbar
Test date :	September 26, 2018
Tested By :	Aaron Liang

#### Requirement(s):

Spec	Item	Requirement	Applicable														
47CFR§15.207, RSS210 (A8.1)	a)	For Low-power radio-frequency devices that is designed to be connected to the public utility (AC) power line, the radio frequency voltage that is conducted back onto the AC power line on any frequency or frequencies, within the band 150 kHz to 30 MHz, shall not exceed the limits in the following table, as measured using a 50 [mu] H/50 ohms line impedance stabilization network (LISN). The lower limit applies at the boundary between the frequencies ranges.	<input checked="" type="checkbox"/>														
		<table border="1"> <thead> <tr> <th rowspan="2">Frequency ranges (MHz)</th> <th colspan="2">Limit (dBµV)</th> </tr> <tr> <th>QP</th> <th>Average</th> </tr> </thead> <tbody> <tr> <td>0.15 ~ 0.5</td> <td>66 – 56</td> <td>56 – 46</td> </tr> <tr> <td>0.5 ~ 5</td> <td>56</td> <td>46</td> </tr> <tr> <td>5 ~ 30</td> <td>60</td> <td>50</td> </tr> </tbody> </table>		Frequency ranges (MHz)	Limit (dBµV)		QP	Average	0.15 ~ 0.5	66 – 56	56 – 46	0.5 ~ 5	56	46	5 ~ 30	60	50
		Frequency ranges (MHz)			Limit (dBµV)												
				QP	Average												
0.15 ~ 0.5	66 – 56	56 – 46															
0.5 ~ 5	56	46															
5 ~ 30	60	50															

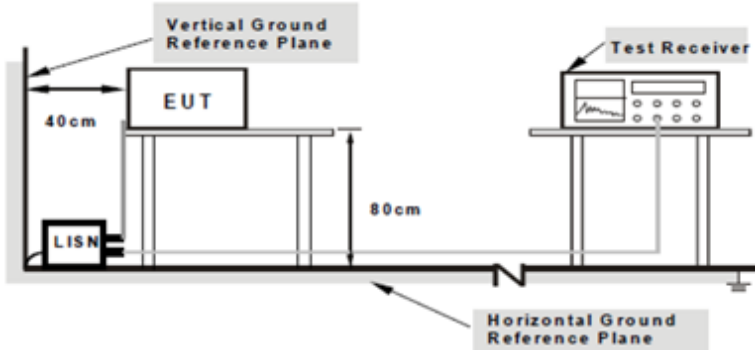
Test Setup	 <p style="text-align: center;">Note: 1.Support units were connected to second LISN. 2.Both of LISNs (AMN) are 80cm from EUT and at least 80cm from other units and other metal planes support units.</p>
------------	---

Procedure	<ol style="list-style-type: none"> <li>The EUT and supporting equipment were set up in accordance with the requirements of the standard on top of a 1.5m x 1m x 0.8m high, non-metallic table.</li> <li>The power supply for the EUT was fed through a 50W/50mH EUT LISN, connected to filtered mains.</li> </ol>
-----------	---

Test Report No.	18071070-FCC-R
Page	10 of 26

	<ol style="list-style-type: none"> <li>3. The RF OUT of the EUT LISN was connected to the EMI test receiver via a low-loss coaxial cable.</li> <li>4. All other supporting equipment were powered separately from another main supply.</li> <li>5. The EUT was switched on and allowed to warm up to its normal operating condition.</li> <li>6. A scan was made on the NEUTRAL line (for AC mains) or Earth line (for DC power) over the required frequency range using an EMI test receiver.</li> <li>7. High peaks, relative to the limit line, The EMI test receiver was then tuned to the selected frequencies and the necessary measurements made with a receiver bandwidth setting of 10 kHz.</li> <li>8. Step 7 was then repeated for the LIVE line (for AC mains) or DC line (for DC power).</li> </ol>
Remark	
Result	<input checked="" type="checkbox"/> Pass <input type="checkbox"/> Fail

Test Data  Yes  N/A

Test Plot  Yes (See below)  N/A

<b>Test Mode:</b>	<b>Transmitting Mode</b>
-------------------	--------------------------

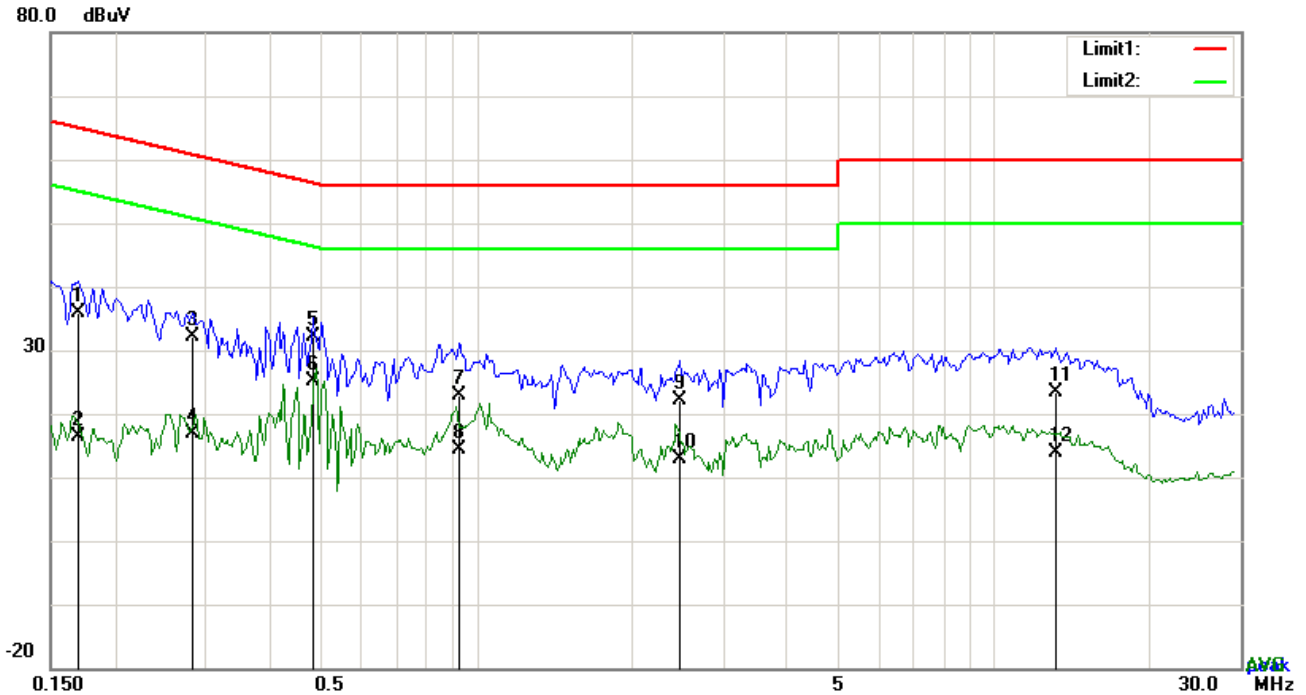

**Test Data**

**Phase Line Plot at 120Vac, 60Hz**

No.	P/L	Frequency (MHz)	Reading (dBµV)	Detector	Corrected (dB)	Result (dBµV)	Limit (dBµV)	Margin (dB)
1	L1	0.1695	25.88	QP	10.03	35.91	64.98	-29.07
2	L1	0.1695	6.28	AVG	10.03	16.31	54.98	-38.67
3	L1	0.2826	22.16	QP	10.03	32.19	60.74	-28.55
4	L1	0.2826	6.91	AVG	10.03	16.94	50.74	-33.80
5	L1	0.4815	22.09	QP	10.03	32.12	56.31	-24.19
6	L1	0.4815	14.99	AVG	10.03	25.02	46.31	-21.29
7	L1	0.9261	12.94	QP	10.03	22.97	56.00	-33.03
8	L1	0.9261	4.29	AVG	10.03	14.32	46.00	-31.68
9	L1	2.4744	12.17	QP	10.05	22.22	56.00	-33.78
10	L1	2.4744	2.85	AVG	10.05	12.90	46.00	-33.10
11	L1	13.1673	13.09	QP	10.20	23.29	60.00	-36.71
12	L1	13.1673	3.57	AVG	10.20	13.77	50.00	-36.23

<b>Test Mode:</b>	<b>Transmitting Mode</b>
-------------------	--------------------------

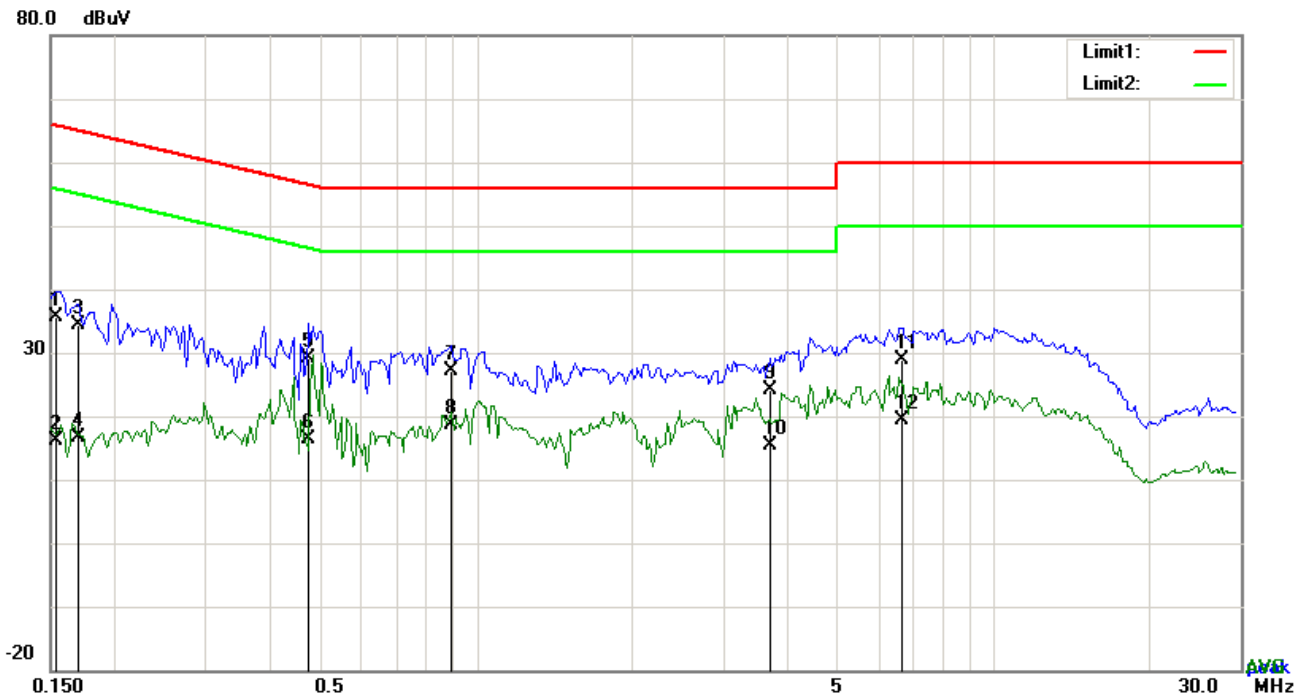

**Test Data**

**Phase Neutral Plot at 120Vac, 60Hz**

No.	P/L	Frequency (MHz)	Reading (dBµV)	Detector	Corrected (dB)	Result (dBµV)	Limit (dBµV)	Margin (dB)
1	N	0.1539	25.55	QP	10.02	35.57	65.79	-30.22
2	N	0.1539	6.00	AVG	10.02	16.02	55.79	-39.77
3	N	0.1695	24.46	QP	10.02	34.48	64.98	-30.50
4	N	0.1695	6.54	AVG	10.02	16.56	54.98	-38.42
5	N	0.4737	19.23	QP	10.02	29.25	56.45	-27.20
6	N	0.4737	6.37	AVG	10.02	16.39	46.45	-30.06
7	N	0.8910	17.20	QP	10.03	27.23	56.00	-28.77
8	N	0.8910	8.59	AVG	10.03	18.62	46.00	-27.38
9	N	3.6942	14.03	QP	10.06	24.09	56.00	-31.91
10	N	3.6942	5.21	AVG	10.06	15.27	46.00	-30.73
11	N	6.6543	18.75	QP	10.09	28.84	60.00	-31.16
12	N	6.6543	9.35	AVG	10.09	19.44	50.00	-30.56

<b>Test Mode:</b>	<b>Transmitting Mode</b>
-------------------	--------------------------

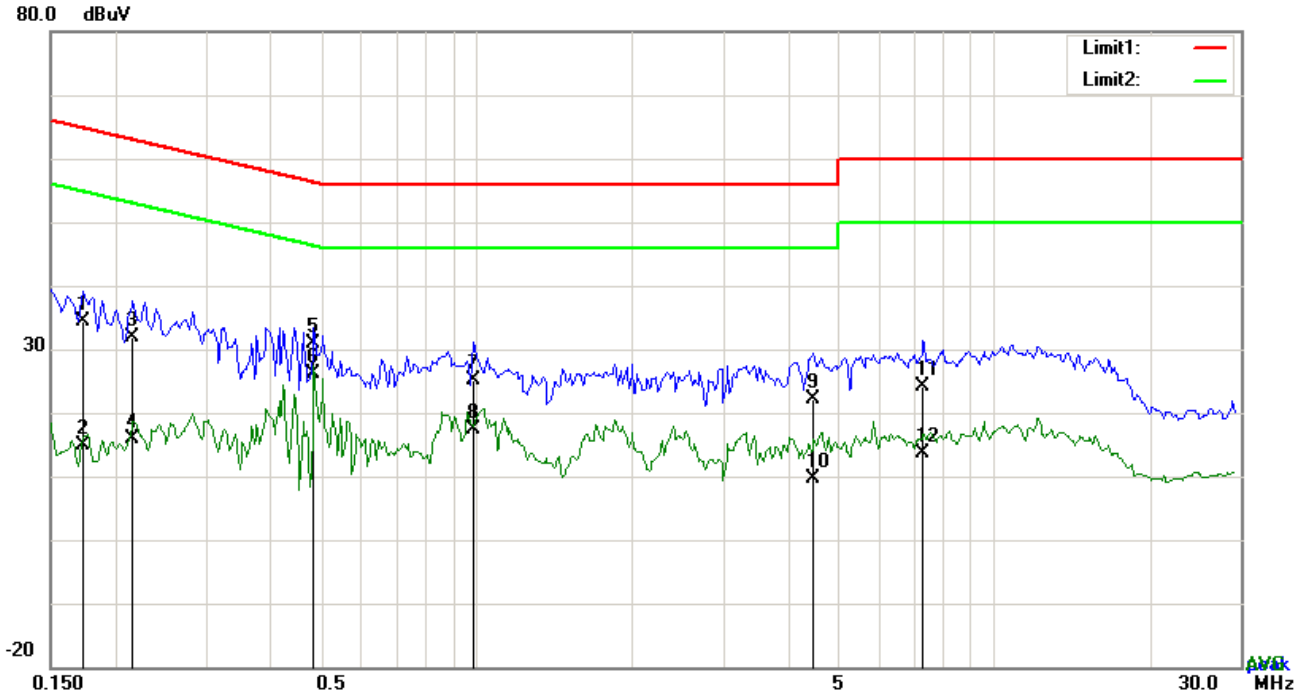

**Test Data**

**Phase Line Plot at 240Vac, 60Hz**

No.	P/L	Frequency (MHz)	Reading (dBµV)	Detector	Corrected (dB)	Result (dBµV)	Limit (dBµV)	Margin (dB)
1	L1	0.1734	24.40	QP	10.03	34.43	64.80	-30.37
2	L1	0.1734	4.80	AVG	10.03	14.83	54.80	-39.97
3	L1	0.2163	21.82	QP	10.03	31.85	62.96	-31.11
4	L1	0.2163	5.85	AVG	10.03	15.88	52.96	-37.08
5	L1	0.4854	20.84	QP	10.03	30.87	56.25	-25.38
6	L1	0.4854	16.21	AVG	10.03	26.24	46.25	-20.01
7	L1	0.9846	15.17	QP	10.03	25.20	56.00	-30.80
8	L1	0.9846	7.40	AVG	10.03	17.43	46.00	-28.57
9	L1	4.4820	12.18	QP	10.07	22.25	56.00	-33.75
10	L1	4.4820	-0.33	AVG	10.07	9.74	46.00	-36.26
11	L1	7.3251	14.12	QP	10.11	24.23	60.00	-35.77
12	L1	7.3251	3.52	AVG	10.11	13.63	50.00	-36.37

<b>Test Mode:</b>	<b>Transmitting Mode</b>
-------------------	--------------------------

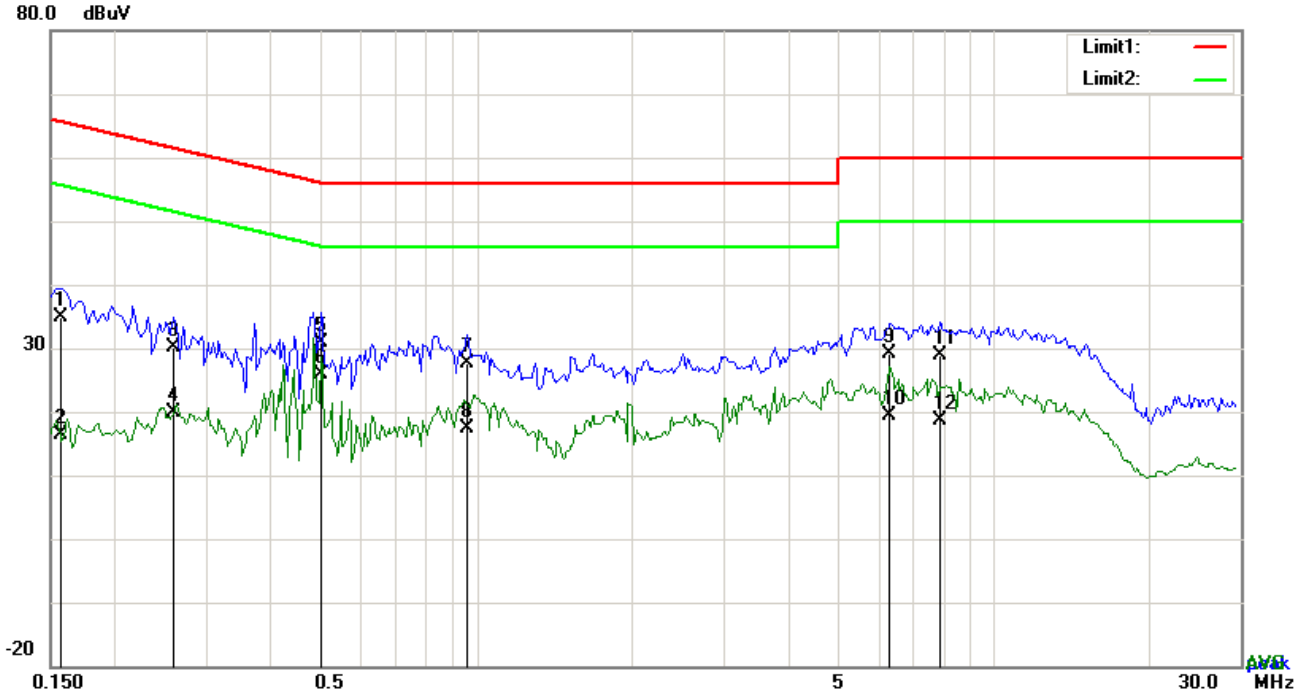

**Test Data**

**Phase Neutral Plot at 240Vac, 60Hz**

No.	P/L	Frequency (MHz)	Reading (dBμV)	Detector	Corrected (dB)	Result (dBμV)	Limit (dBμV)	Margin (dB)
1	N	0.1578	24.81	QP	10.02	34.83	65.58	-30.75
2	N	0.1578	6.45	AVG	10.02	16.47	55.58	-39.11
3	N	0.2592	20.02	QP	10.02	30.04	61.46	-31.42
4	N	0.2592	9.87	AVG	10.02	19.89	51.46	-31.57
5	N	0.5010	20.82	QP	10.02	30.84	56.00	-25.16
6	N	0.5010	15.86	AVG	10.02	25.88	46.00	-20.12
7	N	0.9612	17.64	QP	10.03	27.67	56.00	-28.33
8	N	0.9612	7.40	AVG	10.03	17.43	46.00	-28.57
9	N	6.2994	18.97	QP	10.09	29.06	60.00	-30.94
10	N	6.2994	9.20	AVG	10.09	19.29	50.00	-30.71
11	N	7.8789	18.78	QP	10.11	28.89	60.00	-31.11
12	N	7.8789	8.52	AVG	10.11	18.63	50.00	-31.37

## 6.2 Radiated Spurious Emissions & Restricted Band

Temperature	26 °C
Relative Humidity	55%
Atmospheric Pressure	1017mbar
Test date :	September 26, 2018
Tested By :	Aaron Liang

### Requirement(s):

Spec	Item	Requirement	Applicable																
47CFR§15.247(d), RSS210 (A8.5)	a)	<p>Except higher limit as specified elsewhere in other section, the emissions from the low-power radio-frequency devices shall not exceed the field strength levels specified in the following table and the level of any unwanted emissions shall not exceed the level of the fundamental emission. The tighter limit applies at the band edges</p> <table border="1"> <thead> <tr> <th>Frequency range (MHz)</th> <th>Field Strength (µV/m)</th> </tr> </thead> <tbody> <tr> <td>0.009~0.490</td> <td>2400/F(KHz)</td> </tr> <tr> <td>0.490~1.705</td> <td>24000/F(KHz)</td> </tr> <tr> <td>1.705~30.0</td> <td>30</td> </tr> <tr> <td>30 – 88</td> <td>100</td> </tr> <tr> <td>88 – 216</td> <td>150</td> </tr> <tr> <td>216 960</td> <td>200</td> </tr> <tr> <td>Above 960</td> <td>500</td> </tr> </tbody> </table>	Frequency range (MHz)	Field Strength (µV/m)	0.009~0.490	2400/F(KHz)	0.490~1.705	24000/F(KHz)	1.705~30.0	30	30 – 88	100	88 – 216	150	216 960	200	Above 960	500	<input checked="" type="checkbox"/>
	Frequency range (MHz)	Field Strength (µV/m)																	
	0.009~0.490	2400/F(KHz)																	
0.490~1.705	24000/F(KHz)																		
1.705~30.0	30																		
30 – 88	100																		
88 – 216	150																		
216 960	200																		
Above 960	500																		
b)	<p>For non-restricted band, In any 100 kHz bandwidth outside the frequency band in which the spread spectrum or digitally modulated intentional radiator is operating, the radio frequency power that is produced by the intentional radiator shall be at least 20 dB or 30dB below that in the 100 kHz bandwidth within the band that contains the highest level of the desired power, determined by the measurement method on output power to be used. Attenuation below the general limits specified in § 15.209(a) is not required</p> <p><input checked="" type="checkbox"/> 20 dB down      <input type="checkbox"/> 30 dB down</p>	<input checked="" type="checkbox"/>																	
c)	<p>or restricted band, emission must also comply with the radiated emission limits specified in 15.209</p>	<input checked="" type="checkbox"/>																	

<p>Test Setup</p>	
<p>Procedure</p>	<ol style="list-style-type: none"> <li>1. The EUT was switched on and allowed to warm up to its normal operating condition.</li> <li>2. The test was carried out at the selected frequency points obtained from the EUT characterization. Maximization of the emissions, was carried out by rotating the EUT, changing the antenna polarization, and adjusting the antenna height in the following manner:             <ol style="list-style-type: none"> <li>a. Vertical or horizontal polarization (whichever gave the higher emission level over a full rotation of the EUT) was chosen.</li> <li>b. The EUT was then rotated to the direction that gave the maximum emission.</li> <li>c. Finally, the antenna height was adjusted to the height that gave the maximum emission.</li> </ol> </li> <li>3. The resolution bandwidth and video bandwidth of test receiver/spectrum analyzer is 120 kHz for Quasiy Peak detection at frequency below 1GHz.</li> <li>4. The resolution bandwidth of test receiver/spectrum analyzer is 1MHz and video bandwidth is 3MHz with Peak detection for Peak measurement at frequency above 1GHz.</li> </ol>



Test Report No.	18071070-FCC-R
Page	17 of 26

	<p>The resolution bandwidth of test receiver/spectrum analyzer is 1MHz and the video bandwidth is 10Hz with Peak detection for Average Measurement as below at frequency above 1GHz.</p> <p>5. Steps 2 and 3 were repeated for the next frequency point, until all selected frequency points were measured.</p>
Remark	
Result	<input checked="" type="checkbox"/> Pass <input type="checkbox"/> Fail

Test Data     Yes                       N/A

Test Plot     Yes (See below)             N/A

**Test Result:**

<b>Test Mode:</b>	Transmitting Mode
-------------------	-------------------

Frequency range: 9KHz - 30MHz

Freq. (MHz)	Detection value	Factor (dB/m)	Reading (dBuV/m)	Result (dBuV/m)	Limit@3m (dBuV/m)	Margin (dB)
--	--	--	--	--	--	>20
--	--	--	--	--	--	>20

**Note:**

The amplitude of spurious emissions which are attenuated by more than 20dB below the permissible value has no need to be reported.

Distance extrapolation factor =  $40 \log (\text{specific distance}/\text{test distance})$ (dB);

Limit line = specific limits(dBuv) + distance extrapolation factor.

<b>Test Mode:</b>	<b>Transmitting Mode</b>
-------------------	--------------------------

**30MHz -1GHz**

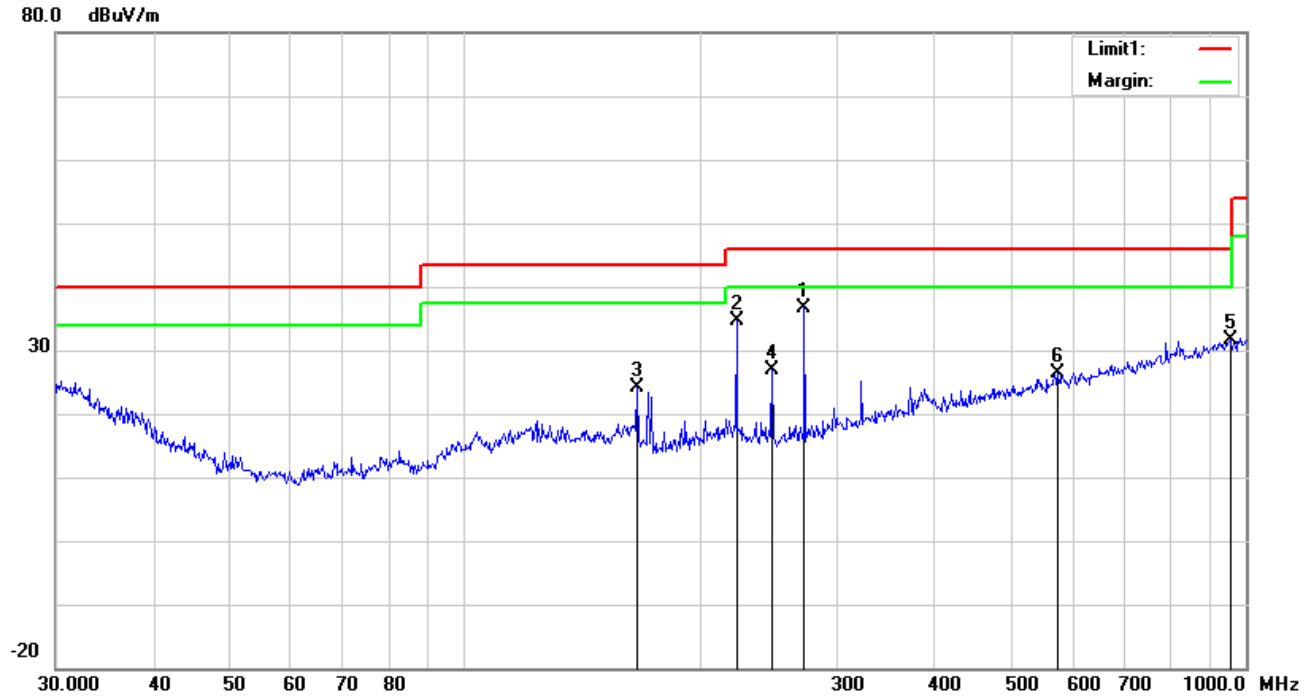

**Test Data**

**Vertical Polarity Plot @3m**

No.	P/L	Frequency	Reading	Ant_F	PA_G	Cab_L	Result	Limit	Margin	Height	Degree
		(MHz)	(dBuV/m)	(dB/m)	(dB)	(dB)	(dBuV/m)	(dBuV/m)	(dB)	(cm)	( ° )
1	H	272.2776	44.92	12.38	22.29	1.74	36.75	46.00	-9.25	100	105
2	H	222.9502	43.52	11.78	22.34	1.61	34.57	46.00	-11.43	100	109
3	H	166.0680	32.97	12.11	22.26	1.37	24.19	43.50	-19.31	100	283
4	H	247.6819	36.05	11.43	22.29	1.69	26.88	46.00	-19.12	100	305
5	H	955.4381	26.34	22.78	20.77	3.20	31.55	46.00	-14.45	100	214
6	H	574.6258	26.80	18.74	21.64	2.48	26.38	46.00	-19.62	200	181

### 30MHz -1GHz

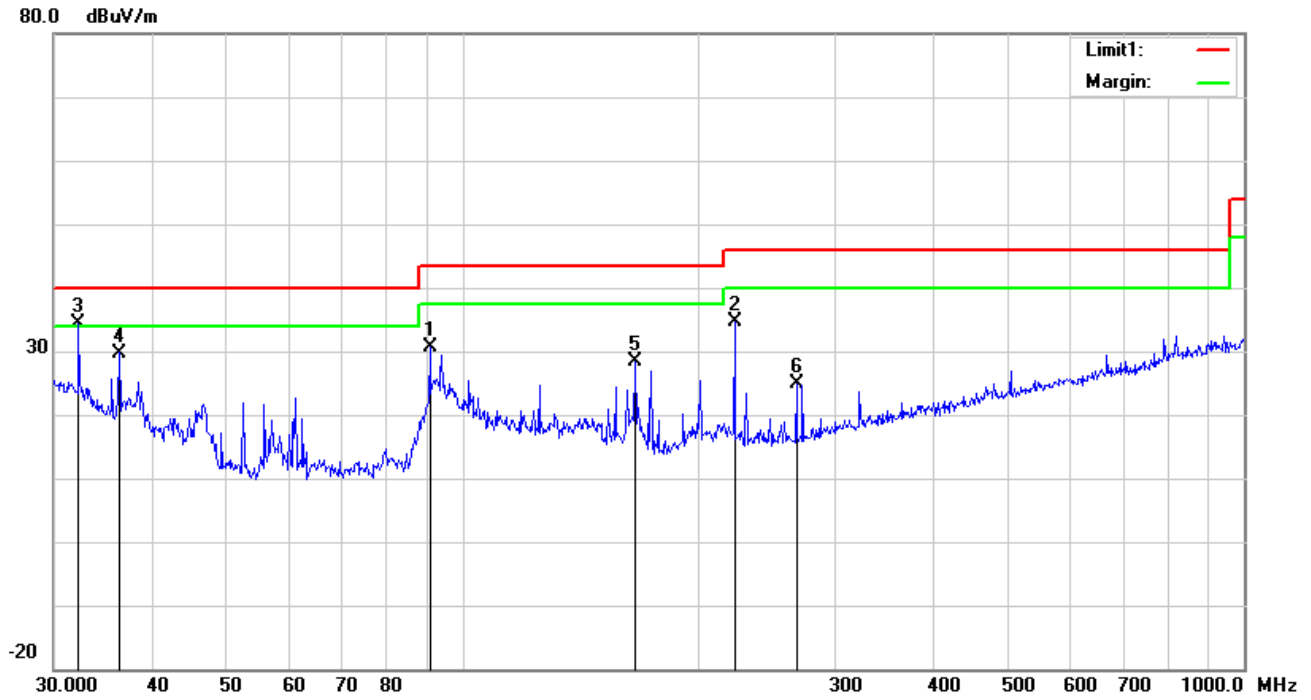

*Test Data*

### Horizontal Polarity Plot @3m

N o.	P/ L	Frequency (MHz)	Reading (dBuV/m )	Ant_F (dB/m)	PA_G (dB)	Cab_L (dB)	Result (dBuV/m)	Limit (dBuV/m)	Margin (dB)	Height (cm)	Degr ee ( )
1	V	90.8554	43.72	8.21	22.32	0.96	30.57	43.50	-12.93	100	294
2	V	222.9502	43.47	11.78	22.34	1.61	34.52	46.00	-11.48	100	100
3	V	32.2925	36.24	19.63	22.27	0.68	34.28	40.00	-5.72	100	205
4	V	36.3814	34.70	16.54	22.26	0.77	29.75	40.00	-10.25	100	188
5	V	166.6514	37.14	12.07	22.26	1.37	28.32	43.50	-15.18	100	110
6	V	267.5455	33.27	12.17	22.29	1.73	24.88	46.00	-21.12	200	348

## Annex A. TEST INSTRUMENT

Instrument	Model	Serial #	Cal Date	Cal Due	In use
<b>AC Line Conducted</b>					
EMI test receiver	ESCS30	8471241027	09/15/2017	09/14/2018	<input checked="" type="checkbox"/>
Line Impedance	LI-125A	191106	09/23/2017	09/22/2018	<input checked="" type="checkbox"/>
Line Impedance	LI-125A	191107	09/23/2017	09/22/2018	<input checked="" type="checkbox"/>
ISN	ISN T800	34373	09/23/2017	09/22/2018	<input type="checkbox"/>
Transient Limiter	LIT-153	531118	08/30/2017	08/29/2018	<input type="checkbox"/>
<b>Radiated Emissions</b>					
EMI test receiver	ESL6	100262	09/15/2017	09/14/2018	<input checked="" type="checkbox"/>
Positioning Controller	UC3000	MF780208282	11/17/2017	11/16/2018	<input checked="" type="checkbox"/>
OPT 010 AMPLIFIER (0.1-1300MHz)	8447E	2727A02430	08/30/2017	08/29/2018	<input checked="" type="checkbox"/>
Microwave Preamplifier (1 ~ 26.5GHz)	8449B	3008A02402	03/22/2018	03/21/2019	<input checked="" type="checkbox"/>
Horn Antenna	BBHA9170	3145226D1	09/27/2017	09/26/2018	<input checked="" type="checkbox"/>
Active Antenna (9kHz-30MHz)	AL-130	121031	10/12/2017	10/11/2018	<input checked="" type="checkbox"/>
Bilog Antenna (30MHz~6GHz)	JB6	A110712	09/19/2017	09/18/2018	<input checked="" type="checkbox"/>
Double Ridge Horn Antenna (1 ~18GHz)	AH-118	71283	09/22/2017	09/21/2018	<input checked="" type="checkbox"/>
Universal Radio Communication Tester	CMU200	121393	09/23/2017	09/22/2018	<input checked="" type="checkbox"/>

## Annex B. TEST SETUP AND SUPPORTING EQUIPMENT

### Annex B.i. TEST SET UP BLOCK

#### Block Configuration Diagram for AC Line Conducted Emissions

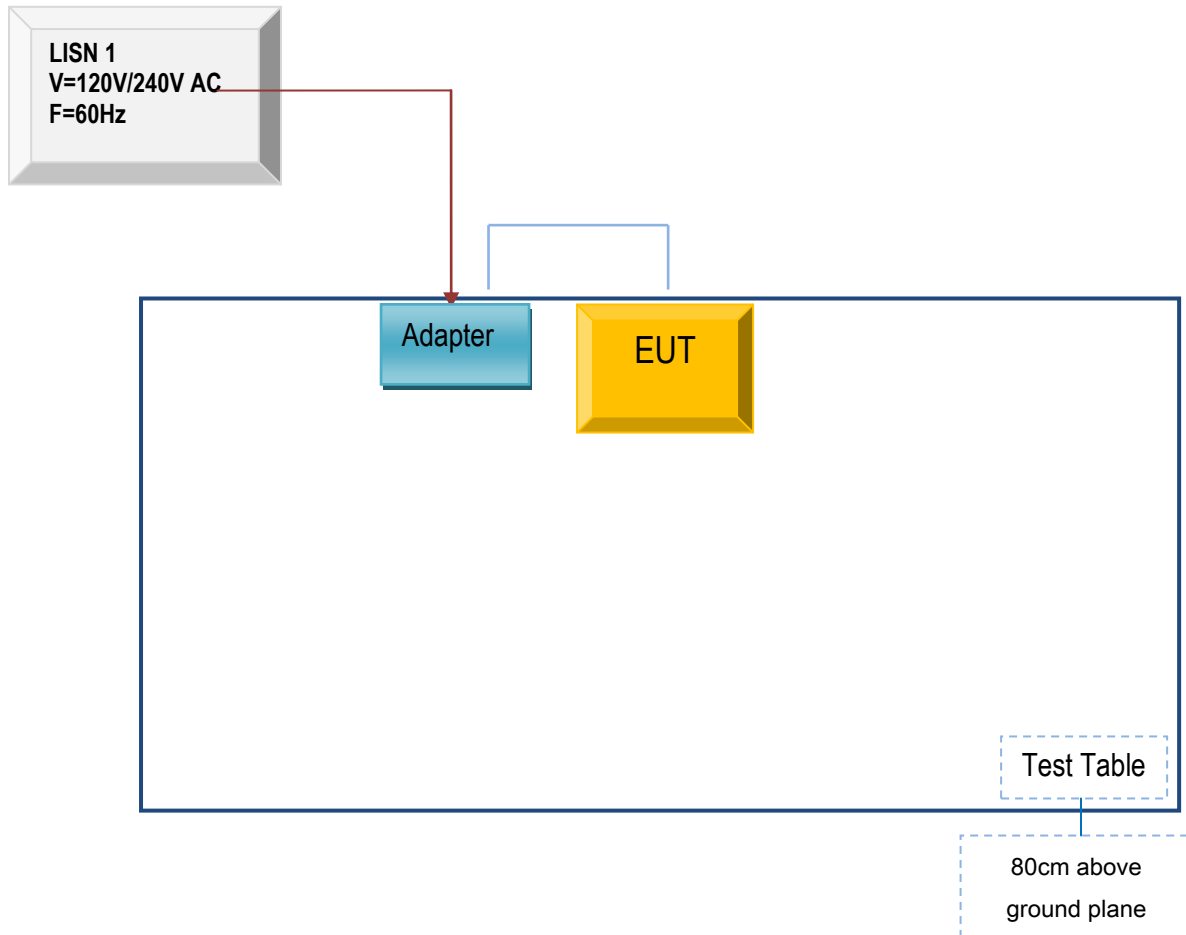

**Block Configuration Diagram for Radiated Emissions ( Below 1GHz ) .**

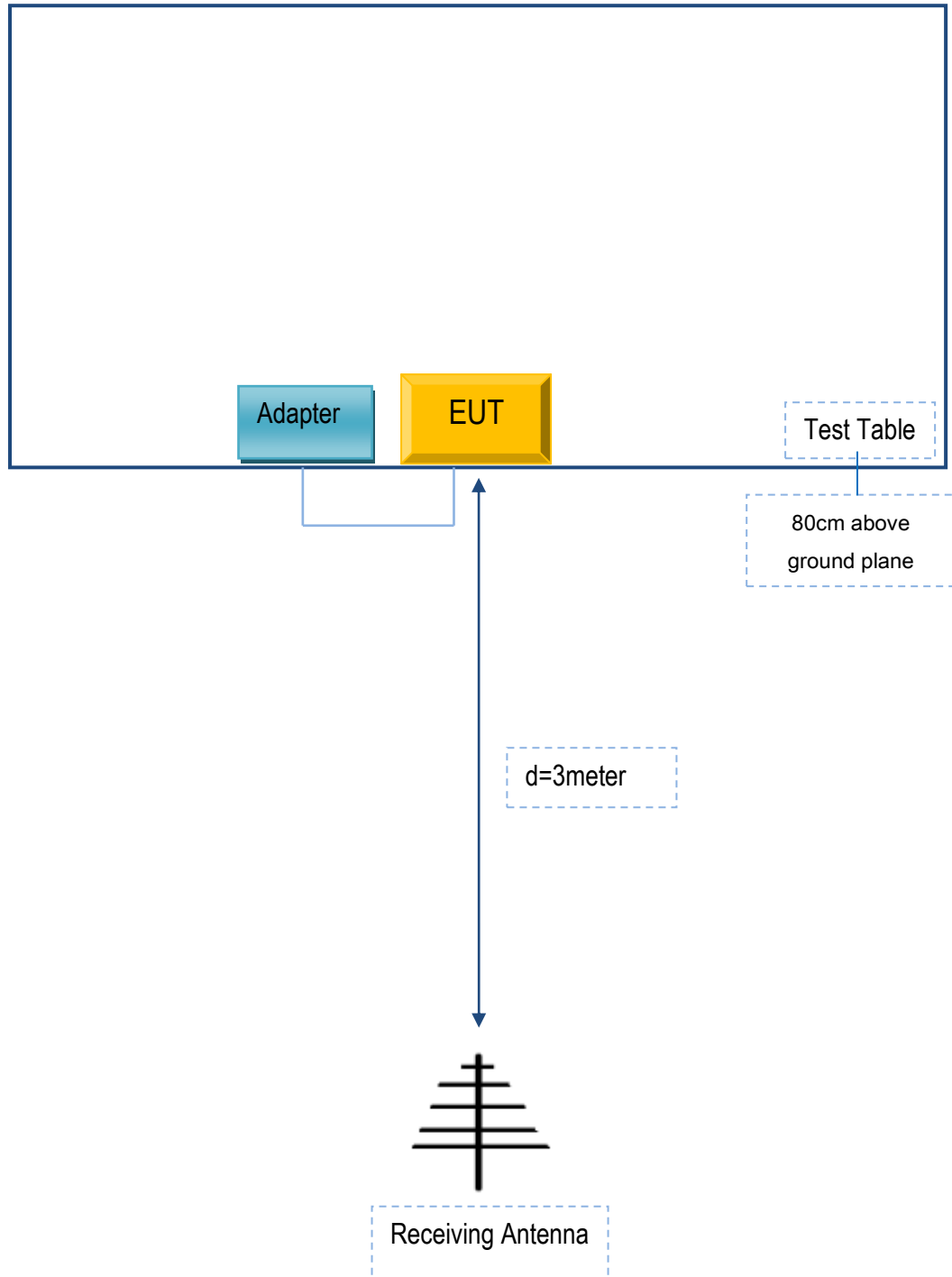

**Block Configuration Diagram for Radiated Emissions ( Above 1GHz ) .**

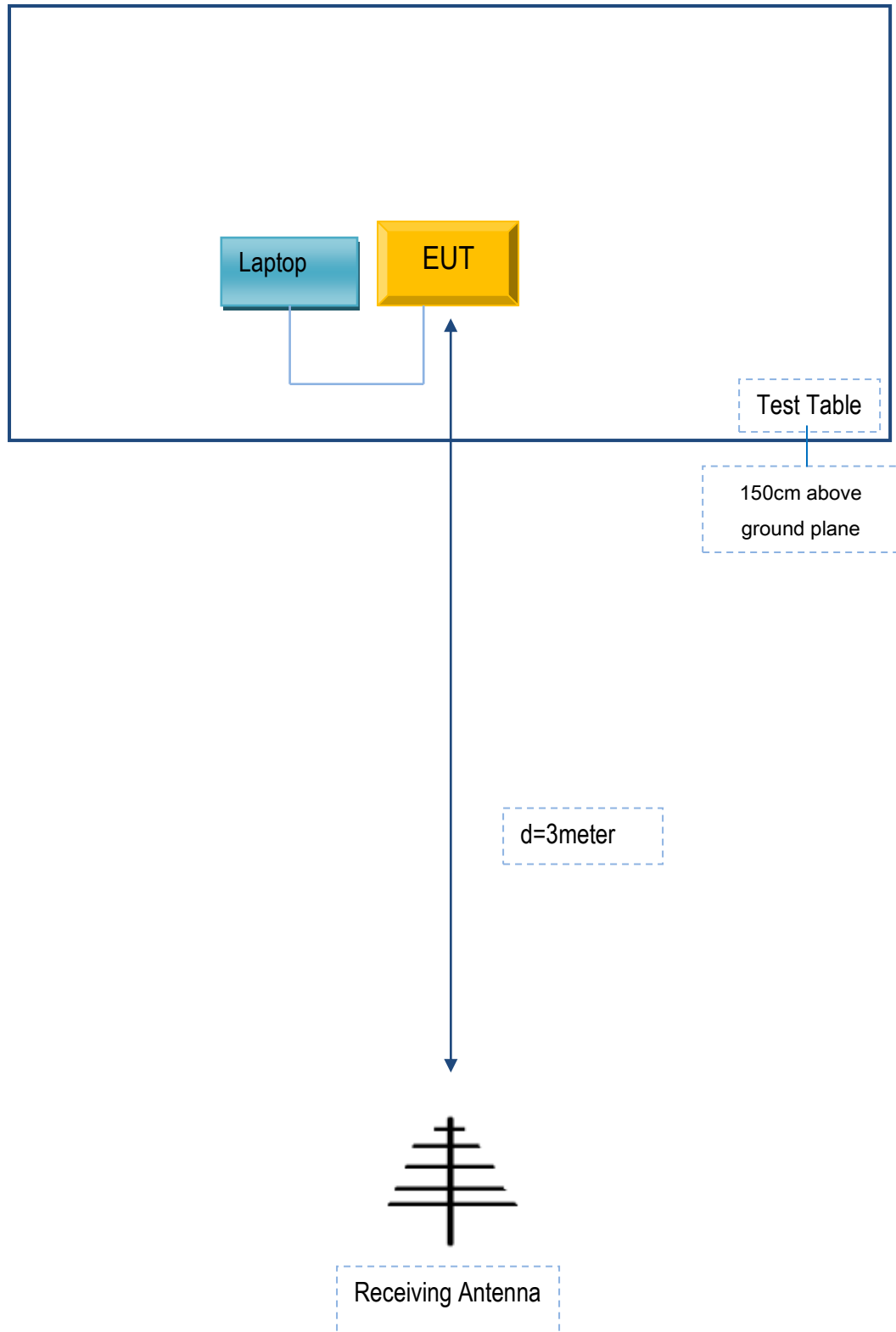



## **Annex B. ii. SUPPORTING EQUIPMENT DESCRIPTION**

The following is a description of supporting equipment and details of cables used with the EUT.

### **Supporting Equipment:**

<b>Manufacturer</b>	<b>Equipment Description</b>	<b>Model</b>	<b>Serial No</b>
DongGuan AoHai Power Technology Co.,Ltd	Adapter	A18A-050100U-US2	N/A

### **Supporting Cable:**

<b>Cable type</b>	<b>Shield Type</b>	<b>Ferrite Core</b>	<b>Length</b>	<b>Serial No</b>
USB Cable	Un-shielding	No	0.8m	N/A

Test Report No.	18071070-FCC-R
Page	26 of 26

**Annex C. User Manual / Block Diagram / Schematics / Partlist/  
DECLARATION OF SIMILARITY**

**Please see the attachment**