



SAR TEST REPORT

Report Reference No..... : JTT201605026

FCC ID..... : 2ABUBSPH6015

Compiled by

(position+printed name+signature)..: File administrators Kevin Liu

Kevin Liu

Supervised by

(position+printed name+signature)..: Project Engineer Kevin Liu

Kevin Liu

Approved by

(position+printed name+signature)..: RF Manager Eric Wang

Eric Wang

Date of issue.....: June 01, 2016

Testing Laboratory Name: Shenzhen Yidajietong Test Technology Co., Ltd.

Address.....: 3/F., Building 12, Shangsha Innovation & Technology Park, Futian District, Shenzhen, Guangdong, China

Applicant's name.....: SHENZHEN SAMHOO SCI&TECH CO.,LTD

Address.....: Room 401, Building 2th, Huaqiangyun Industrial Park, Meixiu Road, Meilin, Futian District, Shenzhen, China

Test specification :

Standard: IEEE 1528:2013

47CFR §2.1093

TRF Originator.....: SHENZHEN JIETONG INFORMATION TECHNOLOGY CO., LTD

Master TRF.....: Dated 2014-01

SHENZHEN JIETONG INFORMATION TECHNOLOGY CO., LTD All rights reserved.

This publication may be reproduced in whole or in part for non-commercial purposes as long as the SHENZHEN JIETONG INFORMATION TECHNOLOGY CO., LTD as copyright owner and source of the material. SHENZHEN JIETONG INFORMATION TECHNOLOGY CO., LTD takes no responsibility for and will not assume liability for damages resulting from the reader's interpretation of the reproduced material due to its placement and context.

Test item description: Digital Two-Way Radio

Trade Mark: Samhoo

Manufacturer: SHENZHEN SAMHOO SCI&TECH CO.,LTD

Model/Type reference.....: SPH6015

Listed Models: /

Ratings.....: DC 7.40V

EUT Type: Production Unit

Exposure category.....: Occupational /Controlled environment

Result.....: PASS

TEST REPORT

Test Report No. :	JTT201605026	June 01, 2016
		Date of issue

Equipment under Test : **Digital Two-Way Radio**

Model /Type : SPH6015

Listed Models : /

Applicant : **SHENZHEN SAMHOO SCI&TECH CO.,LTD**

Address : Room 401, Building 2th, Huaqiangyun Industrial Park,
Meixiu Road, Meilin, Futian District, Shenzhen, China

Manufacturer : **SHENZHEN SAMHOO SCI&TECH CO.,LTD**

Address : Room 401, Building 2th, Huaqiangyun Industrial Park,
Meixiu Road, Meilin, Futian District, Shenzhen, China

Test Result:	PASS
---------------------	-------------

The test report merely corresponds to the test sample.
It is not permitted to copy extracts of these test result without the written permission of the test laboratory.

**** Modified History ****

Revison	Description	Issued Data	Remark
Revsion 1.0	Initial Test Report Release	2016-06-01	Eric Wang

Contents

1.	<u>TEST STANDARDS</u>	5
2.	<u>SUMMARY</u>	6
2.1.	General Remarks	6
2.2.	Product Description	6
2.3.	Summary SAR Results	6
2.4.	Equipment under Test	6
2.5.	EUT operation mode	6
2.6.	TEST Configuration	7
2.7.	EUT configuration	7
3.	<u>TEST ENVIRONMENT</u>	8
3.1.	Address of the test laboratory	8
3.2.	Test Facility	8
3.3.	Environmental conditions	8
3.4.	SAR Limits	8
3.5.	Equipments Used during the Test	9
4.	<u>SAR MEASUREMENTS SYSTEM CONFIGURATION</u>	10
4.1.	SAR Measurement Set-up	10
4.2.	DASY5 E-field Probe System	11
4.3.	Phantoms	11
4.4.	Device Holder	12
4.5.	Scanning Procedure	12
4.6.	Data Storage and Evaluation	13
4.7.	SAR Measurement System	14
4.8.	Dielectric Performance	15
4.9.	System Check	15
4.10.	Measurement Procedures	17
5.	<u>TEST CONDITIONS AND RESULTS</u>	22
5.1.	Conducted Power Results	22
5.2.	Test reduction procedure	22
5.3.	SAR Measurement Results	22
5.4.	SAR Reporting Results	27
5.5.	SAR Measurement Variability	28
5.6.	Measurement Uncertainty (100-300MHz)	28
5.7.	System Check Results	33
5.8.	SAR Test Graph Results	35
6.	<u>CALIBRATION CERTIFICATE</u>	38
6.1.	Probe Calibration Certificate	38
6.2.	CLA150 Dipole Calibration Certificate	49
6.3.	DAE4 Calibration Certificate	57
7.	<u>TEST SETUP PHOTOS</u>	61
8.	<u>EXTERNAL PHOTOS OF THE EUT</u>	64

1. TEST STANDARDS

The tests were performed according to following standards:

[IEEE 1528-2013 \(2014-06\)](#): Recommended Practice for Determining the Peak Spatial-Average Specific Absorption Rate (SAR) in the Human Head from Wireless Communications Devices: Measurement Techniques

[IEEE Std. C95-3 \(2002\)](#): IEEE Recommended Practice for the Measurement of Potentially Hazardous Electromagnetic Fields – RF and Microwave

[IEEE Std. C95-1 \(1992\)](#): IEEE Standard for Safety Levels with Respect to Human Exposure to Radio Frequency Electromagnetic Fields, 3 kHz to 300 GHz.

[IEC 62209-2 \(2010\)](#): Human exposure to radio frequency fields from hand-held and bodymounted wireless communication devices. Human models, instrumentation, and procedures. Procedure to determine the specific absorption rate (SAR) for wireless communication devices used in close proximity to the human body (frequency range of 30 MHz to 6 GHz)

[KDB 865664D01v01r04 \(August 7, 2015\)](#): SAR Measurement Requirements for 100 MHz to 6 GHz

[KDB 865664D02v01r02 \(October 23, 2015\)](#): RF Exposure Compliance Reporting and Documentation Considerations

[KDB 643646 D01 SAR Test for PTT Radios v01r03 \(October 23, 2015\)](#): SAR Test Reduction Considerations for Occupational PTT Radios

[KDB 447498 D01 General RF Exposure Guidance v06 \(October 23, 2015\)](#): Mobile and Portable Devices RF Exposure Procedures and Equipment Authorization Policies

[2015 October TCB Workshop](#): SAR may be scaled if radio is tested at lower power without overheating as invalid SAR results cannot be scaled to compensate for power droop

2. SUMMARY

2.1. General Remarks

Date of receipt of test sample	:	May 06, 2016
Testing commenced on	:	May 24, 2016
Testing concluded on	:	May 25, 2016

2.2. Product Description

EUT Name	:	Digital Two-Way Radio
Model Number	:	SPH6015
Trade Mark	:	Samhoo
EUT function description	:	Please reference user manual of this device
Power supply	:	DC 7.40V from battery
Operation frequency range	:	136 MHz – 174 MHz
Modulation type	:	12.5KHz for FM(Analog), 12.5KHz for 4FSK(Digital)
RF Rated Output power	:	4.5W/1W
Emission type	:	FXW/FXD(Digital)/F3E(Analog)
Antenna Type	:	External
Date of Receipt	:	2016/05/06
Device Type	:	Portable
Sample Type	:	Prototype Unit
Exposure category:	:	Occupational exposure / Controlled environment
Test Frequency:	:	150.8 MHz – 156.45MHz – 162.1MHz – 167.75MHz – 173.4MHz

2.3. Summary SAR Results

FCC					
Mode	Channel Separation	Frequency (MHz)	Position	Maximum Report SAR Results (mW/g)	
				100% duty cycle	50% duty cycle
VHF	12.5KHz	162.10	Face-held	1.080	0.540
VHF	12.5KHz	162.10	Body-Worn	2.080	1.040

2.4. Equipment under Test

Power supply system utilised

Power supply voltage	:	<input type="radio"/> 120V / 60 Hz	<input type="radio"/> 115V / 60Hz
		<input type="radio"/> 12 V DC	<input type="radio"/> 24 V DC
		<input checked="" type="radio"/> Other (specified in blank below)	

DC 7.40 V

2.5. EUT operation mode

The spatial peak SAR values were assessed for VHF systems. Battery and accessories shall be specified by the manufacturer. The EUT battery must be fully charged and checked periodically during the test to ascertain uniform power output.

The sample enter into 100% duty cycle continuous transmit controlled by software VanDyke SecureCRT v7.2.6 provided by application.

2.6. TEST Configuration

Face-Held Configuration

Face-held Configuration- per FCC KDB447498 page 22: "A test separation distance of 25 mm must be applied for in-front-of the face SAR test exclusion and SAR measurements."

Per FCC KDB643646 Appendix Head SAR Test Considerations: "Passive body-worn and audio accessories generally do not apply to the head SAR of PTT radios. Head SAR is measured with the front surface of the radio positioned at 2.5cm parallel to a flat phantom. A phantom shell thickness of 2mm is required. When the front of the radio has a contour or non-uniform surface with a variation of 1.0cm or more, the average distance of such variations is used to establish the 2.5cm test separation from the phantom.

Body-worn Configuration

Body-worn measurements-per FCC KDB447498 page 22 "When body-worn accessory SAR testing is required, the body-worn accessory requirements in section 4.2.2 should be applied. PTT two-way radios that support held-to-ear operating mode must also be tested according to the exposure configurations required for handsets. This generally does not apply to cellphones with PTT options that have already been tested in more conservative configurations in applicable wireless modes for SAR compliance at 100% duty factor." According to KDB643646 D01 for Body SAR Test Considerations for Body-worn Accessories: Body SAR is measured with the radio placed in a body-worn accessory, positioned against a flat phantom, representative of the normal operating conditions expected by users and typically with a standard default audio accessory supplied with the radio, may be designed to operate with a subset of the combinations of antennas, batteries and body-worn accessories, when a default audio accessory does not fully support all accessory must be selected to be the default audio accessory for body-worn accessories testing. If an alternative audio accessory cannot be identified, body-worn accessories should be tested without any body accessories should be tested without any audio. In general, all sides of the radio that may be positioned facing the user when using a body-worn accessory must be considered for SAR compliance.

2.7. EUT configuration

The following peripheral devices and interface cables were connected during the measurement:

Accessory name	Internal Identification	Model	Description	Remark
Antenna	A1	N/A	External Antenna	performed
Battery	B1	B00237200	Intrinsically Safe Li-ion Battery	performed
Belt clip	BC1	SBC00	Belt Clip	performed
Audio Accessories	AC1	EH0100	C-Earset with on-mic PTT	performed
Audio Accessories	AC2	EA0100	Earpiece with on-mic PTT & transparent acoustic tube	performed
Audio Accessories	AC3	ES0100	Earbud with on-mic PTT	performed
Leather carrying	LA1	SLCB100	Leather carrying	performed

AE ID: is used to identify the test sample in the lab internally.

3. TEST ENVIRONMENT

3.1. Address of the test laboratory

Shenzhen Yidajietong Test Technology Co., Ltd.

3/F., Building 12, Shangsha Innovation & Technology Park, Futian District, Shenzhen, Guangdong, China

3.2. Test Facility

The test facility is recognized, certified, or accredited by the following organizations:

CNAS-Lab Code: L7547

The Testing and Technology Center for SHENZHEN YIDA JIETONG INFORMATION TECHNOLOGY CO., LTD has been assessed and proved to be in compliance with CNAS-CL01 Accreditation Criteria for Testing and Calibration Laboratories (identical to ISO/IEC 17025: 2005 General Requirements) for the Competence of Testing and Calibration Laboratories, Date of Registration: March, 2015. Valid time is until March, 2018.

3.3. Environmental conditions

During the measurement the environmental conditions were within the listed ranges:

Temperature:	18-25 ° C
Humidity:	40-65 %
Atmospheric pressure:	950-1050mbar

3.4. SAR Limits

FCC Limit (1g Tissue)

Exposure Limits	SAR (W/kg)	
	(General Population / Uncontrolled Exposure Environment)	(Occupational / Controlled Exposure Environment)
Spatial Average (averaged over the whole body)	0.08	0.4
Spatial Peak (averaged over any 1 g of tissue)	1.60	8.0
Spatial Peak (hands/wrists/feet/ankles averaged over 10 g)	4.0	20.0

Population/Uncontrolled Environments are defined as locations where there is the exposure of individual who have no knowledge or control of their exposure.

Occupational/Controlled Environments are defined as locations where there is exposure that may be incurred by people who are aware of the potential for exposure (i.e. as a result of employment or occupation).

3.5. Equipments Used during the Test

Test Equipment	Manufacturer	Type/Model	Serial Number	Calibration	
				Last Calibration	Calibration Interval
Data Acquisition Electronics DAEx	SPEAG	DAE4	1315	2015/07/22	1
E-field Probe	SPEAG	EX3DV4	3883	2015/08/22	1
System Validation Dipole D450V3	SPEAG	CLA150	4019	2016/02/11	3
Network analyzer	Agilent	8753E	US37390562	2016/03/05	1
Dielectric Probe Kit	Agilent	85070E	US44020288	/	/
Power meter	Agilent	E4417A	GB41292254	2015/12/15	1
Power sensor	Agilent	8481H	MY41095360	2015/12/15	1
Power sensor	Agilent	8481H	MY41095361	2015/12/15	1
Signal generator	IFR	2032	203002/100	2015/10/12	1
Amplifier	AR	75A250	302205	2015/10/12	1

Note:

- 1) Per KDB865664D01 requirements for dipole calibration, the test laboratory has adopted three year extended calibration interval. Each measured dipole is expected to evaluate with following criteria at least on annual interval.
 - a) There is no physical damage on the dipole;
 - b) System check with specific dipole is within 10% of calibrated values;
 - c) The most recent return-loss results, measured at least annually, deviates by no more than 20% from the previous measurement;
 - d) The most recent measurement of the real or imaginary parts of the impedance, measured at least annually is within 50 Ω from the previous measurement.
- 2) Network analyzer probe calibration against air, distilled water and a shorting block performed before measuring liquid parameters.

4. SAR Measurements System configuration

4.1. SAR Measurement Set-up

The DASY5 system for performing compliance tests consists of the following items:

A standard high precision 6-axis robot (Stäubli RX family) with controller and software. An arm extension for accommodating the data acquisition electronics (DAE).

A dosimetric probe, i.e. an isotropic E-field probe optimized and calibrated for usage in tissue simulating liquid. The probe is equipped with an optical surface detector system.

A data acquisition electronic (DAE) which performs the signal amplification, signal multiplexing, AD-conversion, offset measurements, mechanical surface detection, collision detection, etc. The unit is battery powered with standard or rechargeable batteries. The signal is optically transmitted to the EOC.

A unit to operate the optical surface detector which is connected to the EOC.

The Electro-Optical Coupler (EOC) performs the conversion from the optical into a digital electric signal of the DAE. The EOC is connected to the DASY5 measurement server.

The DASY5 measurement server, which performs all real-time data evaluation for field measurements and surface detection, controls robot movements and handles safety operation. A computer operating Windows 2003.

DASY5 software and SEMCAD data evaluation software.

Remote control with teach panel and additional circuitry for robot safety such as warning lamps, etc.

The generic twin phantom enabling the testing of left-hand and right-hand usage.

The device holder for handheld Mobile Phones.

Tissue simulating liquid mixed according to the given recipes.

System validation dipoles allowing to validate the proper functioning of the system.

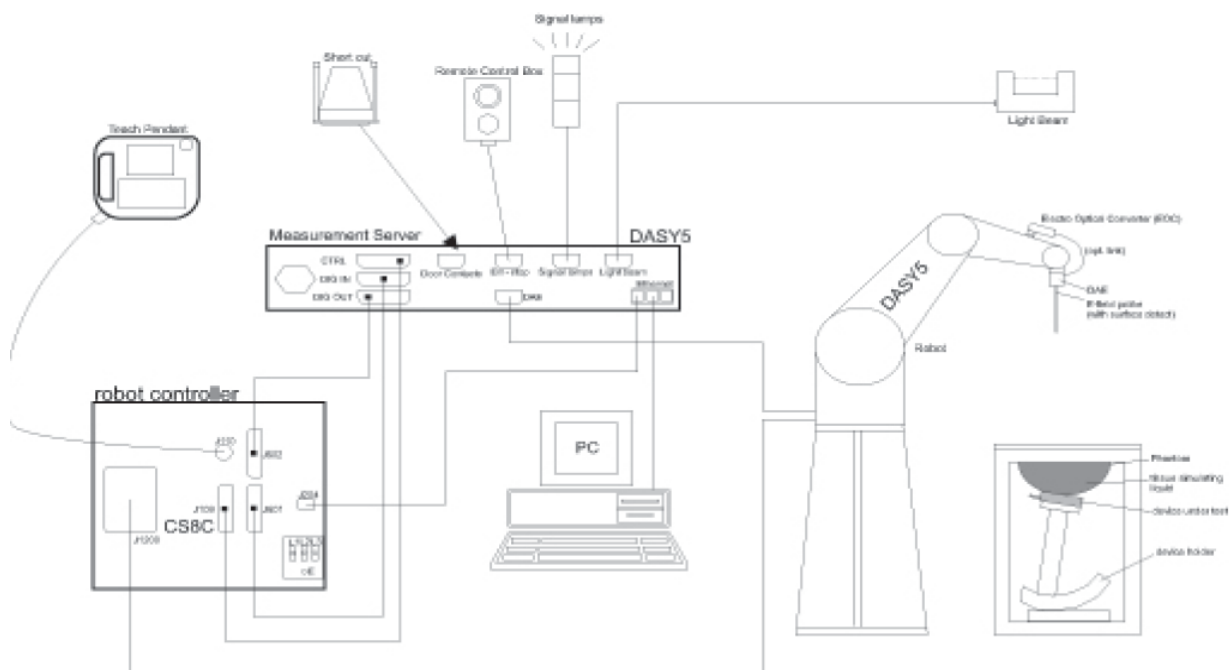

4.2. DASY5 E-field Probe System

The SAR measurements were conducted with the dosimetric probe ES3DV3 (manufactured by SPEAG), designed in the classical triangular configuration and optimized for dosimetric evaluation.

Probe Specification

Construction	Symmetrical design with triangular core Interleaved sensors Built-in shielding against static charges PEEK enclosure material (resistant to organic solvents, e.g., DGBE)
Calibration	ISO/IEC 17025 calibration service available.
Frequency	10 MHz to 4 GHz; Linearity: ± 0.2 dB (30 MHz to 4 GHz)
Directivity	± 0.2 dB in HSL (rotation around probe axis) ± 0.3 dB in tissue material (rotation normal to probe axis)
Dynamic Range	5 μ W/g to > 100 mW/g; Linearity: ± 0.2 dB
Dimensions	Overall length: 337 mm (Tip: 20 mm) Tip diameter: 3.9 mm (Body: 12 mm) Distance from probe tip to dipole centers: 2.0 mm
Application	General dosimetry up to 4 GHz Dosimetry in strong gradient fields Compliance tests of Mobile Phones
Compatibility	DASY3, DASY4, DASY52 SAR and higher, EASY4/MRI



Isotropic E-Field Probe

The isotropic E-Field probe has been fully calibrated and assessed for isotropicity, and boundary effect within a controlled environment. Depending on the frequency for which the probe is calibrated the method utilized for calibration will change.

The E-Field probe utilizes a triangular sensor arrangement as detailed in the diagram below:

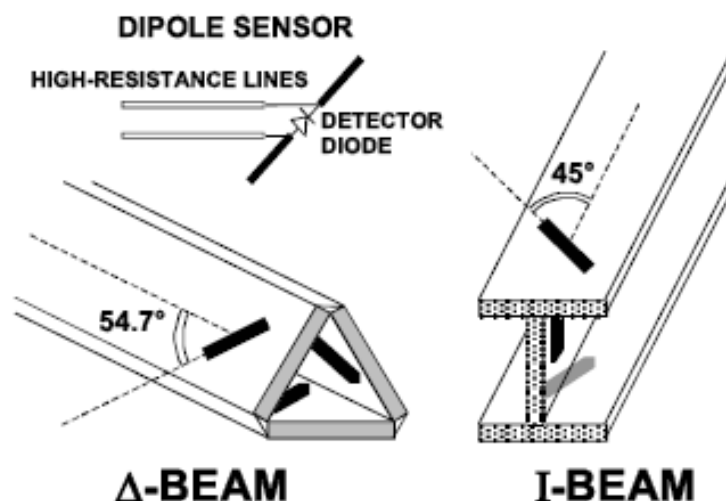

4.3. Phantoms

Phantom for compliance testing of handheld and body-mounted wireless devices in the frequency range of 30 MHz to 6 GHz. ELI is fully compatible with the IEC 62209-2 standard and all known tissue-simulating liquids. ELI has been optimized regarding its performance and can be integrated into our standard phantom tables. A cover prevents evaporation of the liquid. Reference markings on the phantom allow installation of the complete setup, including all predefined phantom positions and measurement grids, by teaching three points. The phantom is compatible with all SPEAG dosimetric probes and dipoles.

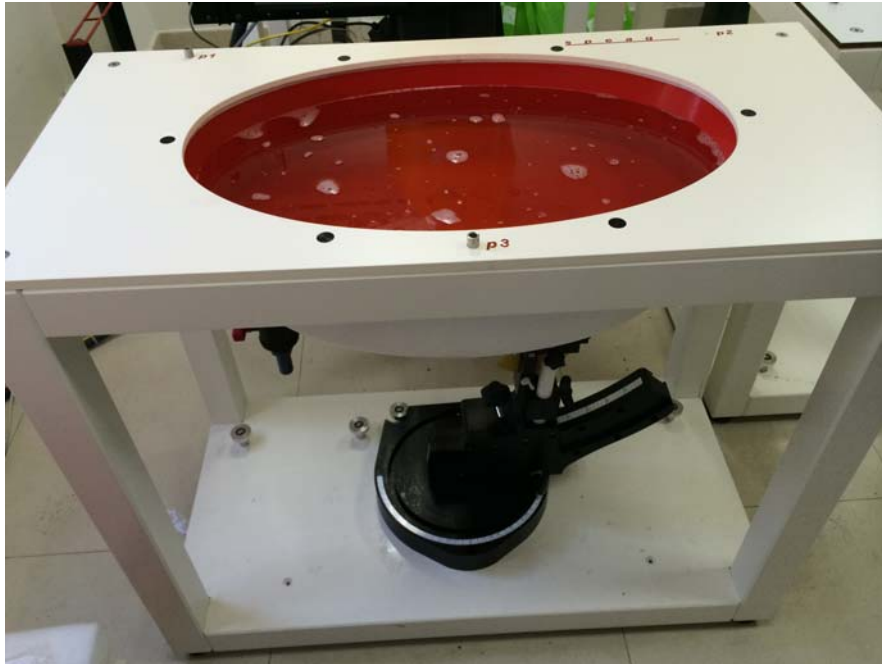

ELI Phantom

4.4. Device Holder

The device was placed in the device holder (illustrated below) that is supplied by SPEAG as an integral part of the DASY system.

The DASY device holder is designed to cope with the different positions given in the standard. It has two scales for device rotation (with respect to the body axis) and device inclination (with respect to the line between the ear reference points). The rotation centers for both scales is the ear reference point (ERP). Thus the device needs no repositioning when changing the angles.

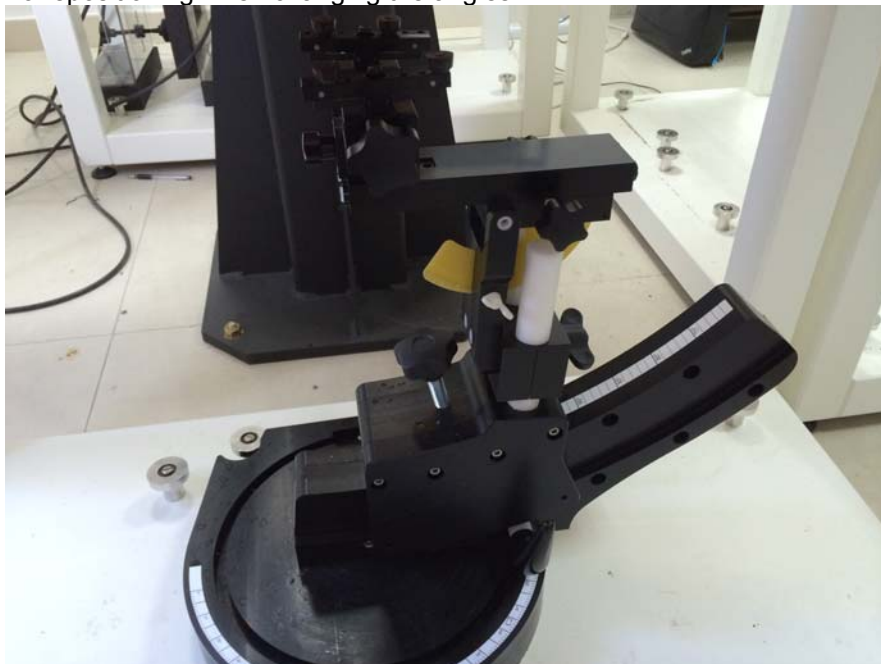

Device holder supplied by SPEAG

4.5. Scanning Procedure

The DASY5 installation includes predefined files with recommended procedures for measurements and validation. They are read-only document files and destined as fully defined but unmeasured masks. All test positions (head or body-worn) are tested with the same configuration of test steps differing only in the grid definition for the different test positions.

The “reference” and “drift” measurements are located at the beginning and end of the batch process. They measure the field drift at one single point in the liquid over the complete procedure. The indicated drift is mainly the variation of the DUT's output power and should vary max. $\pm 5\%$.

The “surface check” measurement tests the optical surface detection system of the DASY5 system by repeatedly detecting the surface with the optical and mechanical surface detector and comparing the results. The output gives the detecting heights of both systems, the difference between the two systems and the standard deviation of the detection repeatability. Air bubbles or refraction in the liquid due to separation of the sugar-water mixture gives poor repeatability (above ± 0.1 mm). To prevent wrong results tests are only executed when the liquid is free of air bubbles. The difference between the optical surface detection and the actual surface depends on the probe and is specified with each probe (It does not depend on the surface reflectivity or the probe angle to the surface within $\pm 30^\circ$.)

Area Scan

The Area Scan is used as a fast scan in two dimensions to find the area of high field values before running a detailed measurement around the hot spot. Before starting the area scan a grid spacing of 15 mm x 15 mm is set. During the scan the distance of the probe to the phantom remains unchanged. After finishing area scan, the field maxima within a range of 2 dB will be ascertained.

Zoom Scan

Zoom Scans are used to estimate the peak spatial SAR values within a cubic averaging volume containing 1 g and 10 g of simulated tissue. The default Zoom Scan is done by 7x7x7 points within a cube whose base is centered around the maxima found in the preceding area scan.

Spatial Peak Detection

The procedure for spatial peak SAR evaluation has been implemented and can determine values of masses of 1g and 10g, as well as for user-specific masses. The DASY5 system allows evaluations that combine measured data and robot positions, such as: • maximum search • extrapolation • boundary correction • peak search for averaged SAR. During a maximum search, global and local maxima searches are automatically performed in 2-D after each Area Scan measurement with at least 6 measurement points. It is based on the evaluation of the local SAR gradient calculated by the Quadratic Shepard's method. The algorithm will find the global maximum and all local maxima within -2 dB of the global maxima for all SAR distributions.

Extrapolation routines are used to obtain SAR values between the lowest measurement points and the inner phantom surface. The extrapolation distance is determined by the surface detection distance and the probe sensor offset. Several measurements at different distances are necessary for the extrapolation. Extrapolation routines require at least 10 measurement points in 3-D space. They are used in the Zoom Scan to obtain SAR values between the lowest measurement points and the inner phantom surface. The routine uses the modified Quadratic Shepard's method for extrapolation. For a grid using 7x7x7 measurement points with 5mm resolution amounting to 343 measurement points, the uncertainty of the extrapolation routines is less than 1% for 1g and 10g cubes.

A Z-axis scan measures the total SAR value at the x- and y-position of the maximum SAR value found during the cube 7x7x7 scan. The probe is moved away in z-direction from the bottom of the SAM phantom in 5mm steps.

4.6. Data Storage and Evaluation

Data Storage

The DASY5 software stores the acquired data from the data acquisition electronics as raw data (in microvolt readings from the probe sensors), together with all necessary software parameters for the data evaluation (probe calibration data, liquid parameters and device frequency and modulation data) in measurement files with the extension “.DA4”. The software evaluates the desired unit and format for output each time the data is visualized or exported. This allows verification of the complete software setup even after the measurement and allows correction of incorrect parameter settings. For example, if a measurement has been performed with a wrong crest factor parameter in the device setup, the parameter can be corrected afterwards and the data can be re-evaluated.

The measured data can be visualized or exported in different units or formats, depending on the selected probe type ([V/m], [A/m], [°C], [mW/g], [mW/cm²], [dBrel], etc.). Some of these units are not available in certain situations or show meaningless results, e.g., a SAR output in a lossless media will always be zero. Raw data can also be exported to perform the evaluation with other software packages.

Data Evaluation

The SEMCAD software automatically executes the following procedures to calculate the field units from the microvolt readings at the probe connector. The parameters used in the evaluation are stored in the configuration modules of the software:

Probe parameters:	- Sensitivity	Normi, ai0, ai1, ai2
	- Conversion factor	ConvFi

	- Diode compression point	Dcpi
Device parameters:	- Frequency	f
	- Crest factor	cf
Media parameters:	- Conductivity	σ
	- Density	ρ

These parameters must be set correctly in the software. They can be found in the component documents or they can be imported into the software from the configuration files issued for the DASY5 components. In the direct measuring mode of the multimeter option, the parameters of the actual system setup are used. In the scan visualization and export modes, the parameters stored in the corresponding document files are used.

The first step of the evaluation is a linearization of the filtered input signal to account for the compression characteristics of the detector diode. The compensation depends on the input signal, the diode type and the DC-transmission factor from the diode to the evaluation electronics. If the exciting field is pulsed, the crest factor of the signal must be known to correctly compensate for peak power. The formula for each channel can be given as:

$$V_i = U_i + U_i^2 \cdot \frac{cf}{dcp_i}$$

With	V_i	= compensated signal of channel i	(i = x, y, z)
	U_i	= input signal of channel i	(i = x, y, z)
	cf	= crest factor of exciting field	(DASY parameter)
	dcp _i	= diode compression point	(DASY parameter)

From the compensated input signals the primary field data for each channel can be evaluated:

$$\text{E - fieldprobes : } E_i = \sqrt{\frac{V_i}{\text{Norm}_i \cdot \text{ConvF}}}$$

$$\text{H - fieldprobes : } H_i = \sqrt{V_i} \cdot \frac{a_{i0} + a_{i1}f + a_{i2}f^2}{f}$$

With	V_i	= compensated signal of channel i	(i = x, y, z)
	Norm_i	= sensor sensitivity of channel i	(i = x, y, z)
		[mV/(V/m) ²] for E-field Probes	
	ConvF	= sensitivity enhancement in solution	
	a_{ij}	= sensor sensitivity factors for H-field probes	
	f	= carrier frequency [GHz]	
	E_i	= electric field strength of channel i in V/m	
	H_i	= magnetic field strength of channel i in A/m	

The RSS value of the field components gives the total field strength (Hermitian magnitude):

$$E_{tot} = \sqrt{E_x^2 + E_y^2 + E_z^2}$$

The primary field data are used to calculate the derived field units.

$$SAR = E_{tot}^2 \cdot \frac{\sigma}{\rho \cdot 1'000}$$

with	SAR	= local specific absorption rate in mW/g
	E_{tot}	= total field strength in V/m
	σ	= conductivity in [mho/m] or [Siemens/m]
	ρ	= equivalent tissue density in g/cm ³

Note that the density is normally set to 1 (or 1.06), to account for actual brain density rather than the density of the simulation liquid.

4.7. SAR Measurement System

The SAR measurement system being used is the DASY5 system, the system is controlled remotely from a PC, which contains the software to control the robot and data acquisition equipment. The software also displays the data obtained from test scans.

In operation, the system first does an area (2D) scan at a fixed depth within the liquid from the inside wall of the phantom. When the maximum SAR point has been found, the system will then carry out a 3D scan centred at that point to determine volume averaged SAR level.

4.7.1 Tissue Dielectric Parameters for Head and Body Phantoms

The liquid is consisted of water,salt,Glycol,Sugar,Preventol and Cellulose.The liquid has previously been proven to be suited for worst-case. It's satisfying the latest tissue dielectric parameters requirements proposed by the KDB865664.

Target Frequency (MHz)	Head		Body	
	ϵ_r	σ (S/m)	ϵ_r	σ (S/m)
150	52.3	0.76	61.9	0.80
300	45.3	0.87	58.2	0.92
450	43.5	0.87	56.7	0.94
835	41.5	0.90	55.2	0.97
900	41.5	0.97	55.0	1.05
915	41.5	0.98	55.0	1.06
1450	40.5	1.20	54.0	1.30
1610	40.3	1.29	53.8	1.40
1800-2000	40.0	1.40	53.3	1.52
2450	39.2	1.80	52.7	1.95
3000	38.5	2.40	52.0	2.73
5800	35.3	5.27	48.2	6.00

(ϵ_r = relative permittivity, σ = conductivity and ρ = 1000 kg/m³)

4.8. Dielectric Performance

Dielectric performance of Head and Body tissue simulating liquid.

Composition of the Head Tissue Equivalent Matter

Mixture %	Frequency 150MHz
Water	38.36
Sugar	55.42
Salt	5.11
Preventol	0.10
Cellulose	1.07
Dielectric Parameters Target Value	f=150MHz ϵ_r =52.3 σ =0.76

Composition of the Body Tissue Equivalent Matter

Mixture %	Frequency 150MHz
Water	46.22
Sugar	49.78
Salt	3.07
Preventol	0.10
Cellulose	0.47
Dielectric Parameters Target Value	f=150MHz ϵ_r =61.9 σ =0.80

Tissue Type	Measured Frequency (MHz)	Target Tissue		Measured Tissue				Liquid Temp.	Test Data
		ϵ_r	σ	ϵ_r	Dev. %	σ	Dev. %		
150H	150	52.30	0.76	51.10	-2.29%	0.78	2.63%	22.2 degree	2016-05-24
150B	150	61.90	0.80	63.20	2.10%	0.83	3.75%	22.2 degree	2016-05-25

4.9. System Check

The purpose of the system check is to verify that the system operates within its specifications at the device test frequency.The system check is simple check of repeatability to make sure that the system works correctly at the time of the compliance test;

System check results have to be equal or near the values determined during dipole calibration with the relevant liquids and test system (± 10 %).

System check is performed regularly on all frequency bands where tests are performed with the DASY5 system.

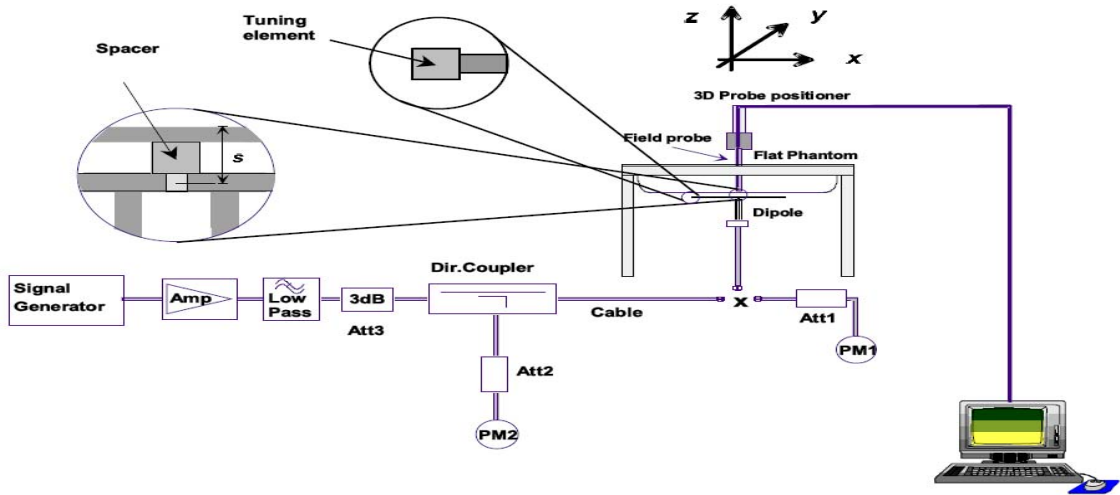

The output power on dipole port must be calibrated to 30 dBm (1000mW) before dipole is connected.

Justification for Extended SAR Dipole Calibrations

Referring to KDB 865664D01V01r04, if dipoles are verified in return loss (<-20dB, within 20% of prior calibration), and in impedance (within 5 ohm of prior calibration), the annual calibration is not necessary and the calibration interval can be extended. While calibration intervals not exceed 3 years.

System Check in Head Tissue Simulating Liquid

Freq	Test Date	Dielectric Parameters		Temp	1000mW Measured		1W Normalized		1W Target		Limit (±10% Deviation)	
		ϵ_r	$\sigma(s/m)$		SAR _{1g}	SAR _{10g}	SAR _{1g}	SAR _{10g}	SAR _{1g}	SAR _{10g}	SAR _{1g}	SAR _{10g}
150MHz	2016/05/24	51.10	0.78	22.2	3.77	2.46	3.77	2.46	3.79	2.52	-0.53%	-2.38%

System Check in Body Tissue Simulating Liquid

Freq	Test Date	Dielectric Parameters		Temp	1000mW Measured		1W Normalized		1W Target		Limit (±10% Deviation)	
		ϵ_r	$\sigma(s/m)$		SAR _{1g}	SAR _{10g}	SAR _{1g}	SAR _{10g}	SAR _{1g}	SAR _{10g}	SAR _{1g}	SAR _{10g}
150MHz	2016/05/25	63.20	0.83	22.2	3.83	2.51	3.83	2.51	3.89	2.59	-1.54%	-3.09%

4.10. Measurement Procedures

Tests to be performed

In order to determine the highest value of the peak spatial-average SAR of a handset, all device positions, configurations and operational modes shall be tested for each frequency band according to steps 1 to 3 below. A flowchart of the test process is shown in Picture 11

Step 1: The tests described in 11.2 shall be performed at the channel that is closest to the centre of the transmit frequency band (f_c) for:

- a) all device positions (cheek and tilt, for both left and right sides of the SAM phantom, as described in Chapter 8),
- b) all configurations for each device position in a), e.g., antenna extended and retracted, and
- c) all operational modes, e.g., analogue and digital, for each device position in a) and configuration in b) in each frequency band.
- d) If more than three frequencies need to be tested according to 11.1 (i.e., $N_c > 3$), then all frequencies, configurations and modes shall be tested for all of the above test conditions.

Step 2: For the condition providing highest peak spatial-average SAR determined in Step 1, perform all tests described in 11.2 at all other test frequencies, i.e., lowest and highest frequencies. In addition, for all other conditions (device position, configuration and operational mode) where the peak spatial-average SAR value determined in Step 1 is within 3 dB of the applicable SAR limit, it is recommended that all other test frequencies shall be tested as well.

Step 3: Examine all data to determine the highest value of the peak spatial-average SAR found in Steps 1 to 2.

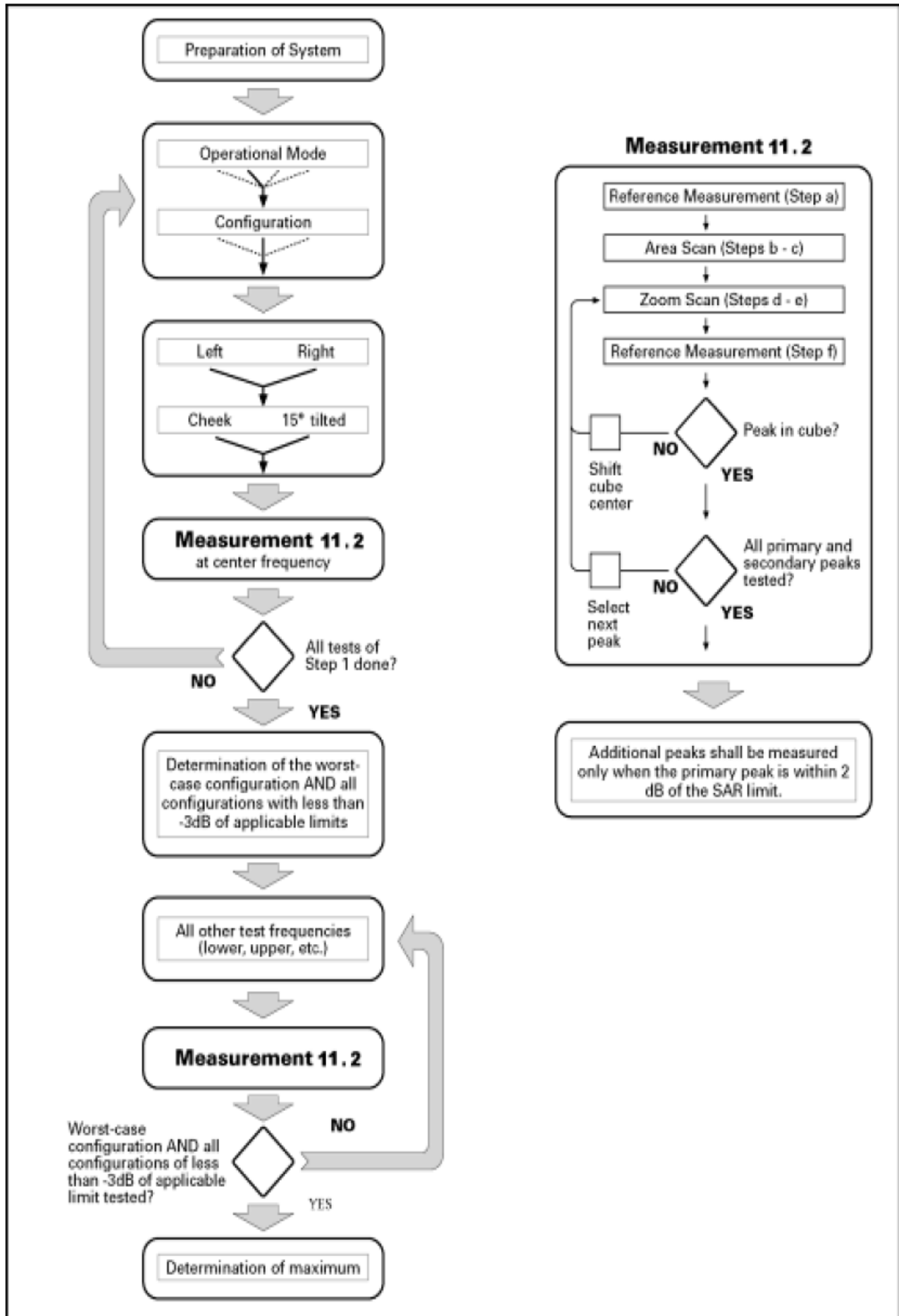

Picture 11 Block diagram of the tests to be performed

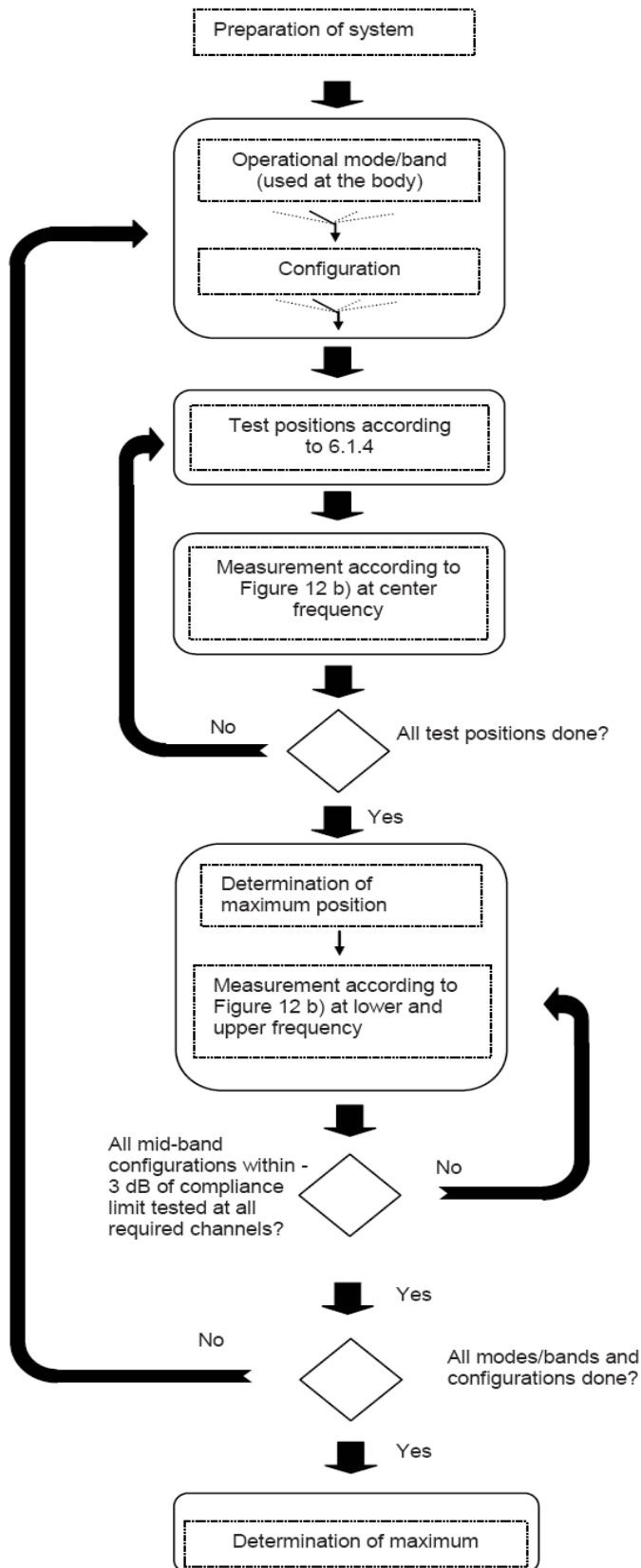

Figure 12a – Tests to be performed

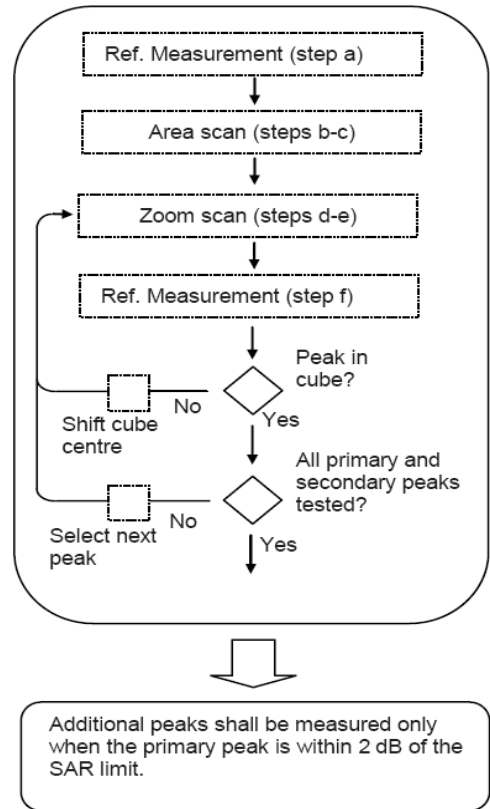

Figure 12b – General procedure

Picture 12 Block diagram of the tests to be performed

Measurement procedure

The following procedure shall be performed for each of the test conditions (see Picture 11) described in 11.1:

- a) Measure the local SAR at a test point within 8 mm or less in the normal direction from the inner surface of the phantom.
- b) Measure the two-dimensional SAR distribution within the phantom (area scan procedure). The boundary of the measurement area shall not be closer than 20 mm from the phantom side walls. The distance between the measurement points should enable the detection of the location of local maximum with an

accuracy of better than half the linear dimension of the tissue cube after interpolation. A maximum grip spacing of 20 mm for frequencies below 3 GHz and $(60/f \text{ [GHz]})$ mm for frequencies of 3GHz and greater is recommended. The maximum distance between the geometrical centre of the probe detectors and the inner surface of the phantom shall be 5 mm for frequencies below 3 GHz and $\delta \ln(2)/2$ mm for frequencies of 3 GHz and greater, where δ is the plane wave skin depth and $\ln(x)$ is the natural logarithm. The maximum variation of the sensor-phantom surface shall be ± 1 mm for frequencies below 3 GHz and ± 0.5 mm for frequencies of 3 GHz and greater. At all measurement points the angle of the probe with respect to the line normal to the surface should be less than 5° . If this cannot be achieved for a measurement distance to the phantom inner surface shorter than the probe diameter, additional measurement distance to the phantom inner surface shorter than the probe diameter, additional

- c) From the scanned SAR distribution, identify the position of the maximum SAR value, in addition identify the positions of any local maxima with SAR values within 2 dB of the maximum value that are not within the zoom-scan volume; additional peaks shall be measured only when the primary peak is within 2 dB of the SAR limit. This is consistent with the 2 dB threshold already stated;
- d) Measure the three-dimensional SAR distribution at the local maxima locations identified in step
- e) The horizontal grid step shall be $(24 / f[\text{GHz}])$ mm or less but not more than 8 mm. The minimum zoom size of 30 mm by 30 mm and 30 mm for frequencies below 3 GHz. For higher frequencies, the minimum zoom size of 22 mm by 22 mm and 22 mm. The grip step in the vertical direction shall be $(8-f[\text{GHz}])$ mm or less but not more than 5 mm, if uniform spacing is used. If variable spacing is used in the vertical direction, the maximum spacing between the two closest measured points to the phantom shell shall be $(12 / f[\text{GHz}])$ mm or less but not more than 4 mm, and the spacing between father points shall increase by an incremental factor not exceeding 1.5. When variable spacing is used, extrapolation routines shall be tested with the same spacing as used in measurements. The maximum distance between the geometrical centre of the probe detectors and the inner surface of the phantom shall be 5 mm for frequencies below 3 GHz and $\delta \ln(2)/2$ mm for frequencies of 3 GHz and greater, where δ is the plane wave skin depth and $\ln(x)$ is the natural logarithm. Separate grids shall be centered on each of the local SAR maxima found in step c). Uncertainties due to field distortion between the media boundary and the dielectric enclosure of the probe should also be minimized, which is achieved is the distance between the phantom surface and physical tip of the probe is larger than probe tip diameter. Other methods may utilize correction procedures for these boundary effects that enable high precision measurements closer than half the probe diameter. For all measurement points, the angle of the probe with respect to the flat phantom surface shall be less than 5° . If this cannot be achieved an additional uncertainty evaluation is needed.
- f) Use post processing(e.g. interpolation and extrapolation) procedures to determine the local SAR values at the spatial resolution needed for mass averaging.

Measurement procedure

The following procedure shall be performed for each of the test conditions (see Picture 11) described in 11.1:

- g) Measure the local SAR at a test point within 8 mm or less in the normal direction from the inner surface of the phantom.
- h) Measure the two-dimensional SAR distribution within the phantom (area scan procedure). The boundary of the measurement area shall not be closer than 20 mm from the phantom side walls. The distance between the measurement points should enable the detection of the location of local maximum with an accuracy of better than half the linear dimension of the tissue cube after interpolation. A maximum grip spacing of 20 mm for frequencies below 3 GHz and $(60/f \text{ [GHz]})$ mm for frequencies of 3GHz and greater is recommended. The maximum distance between the geometrical centre of the probe detectors and the inner surface of the phantom shall be 5 mm for frequencies below 3 GHz and $\delta \ln(2)/2$ mm for frequencies of 3 GHz and greater, where δ is the plane wave skin depth and $\ln(x)$ is the natural logarithm. The maximum variation of the sensor-phantom surface shall be ± 1 mm for frequencies below 3 GHz and ± 0.5 mm for frequencies of 3 GHz and greater. At all measurement points the angle of the probe with respect to the line normal to the surface should be less than 5° . If this cannot be achieved for a measurement distance to the phantom inner surface shorter than the probe diameter, additional measurement distance to the phantom inner surface shorter than the probe diameter, additional
- i) From the scanned SAR distribution, identify the position of the maximum SAR value, in addition identify the positions of any local maxima with SAR values within 2 dB of the maximum value that are not within the zoom-scan volume; additional peaks shall be measured only when the primary peak is within 2 dB of the SAR limit. This is consistent with the 2 dB threshold already stated;
- j) Measure the three-dimensional SAR distribution at the local maxima locations identified in step
- k) The horizontal grid step shall be $(24 / f[\text{GHz}])$ mm or less but not more than 8 mm. The minimum zoom size of 30 mm by 30 mm and 30 mm for frequencies below 3 GHz. For higher frequencies, the minimum zoom size of 22 mm by 22 mm and 22 mm. The grip step in the vertical direction shall be $(8-f[\text{GHz}])$ mm or less but not more than 5 mm, if uniform spacing is used. If variable spacing is used in the vertical direction, the maximum spacing between the two closest measured points to the phantom shell shall be $(12 / f[\text{GHz}])$ mm or less but not more than 4 mm, and the spacing between father points shall increase by an incremental factor not exceeding 1.5. When variable spacing is used, extrapolation routines shall be tested with the same spacing as used in measurements. The maximum distance between the geometrical

centre of the probe detectors and the inner surface of the phantom shall be 5 mm for frequencies below 3 GHz and $\delta \ln(2)/2$ mm for frequencies of 3 GHz and greater, where δ is the plane wave skin depth and $\ln(x)$ is the natural logarithm. Separate grids shall be centered on each of the local SAR maxima found in step c). Uncertainties due to field distortion between the media boundary and the dielectric enclosure of the probe should also be minimized, which is achieved if the distance between the phantom surface and physical tip of the probe is larger than probe tip diameter. Other methods may utilize correction procedures for these boundary effects that enable high precision measurements closer than half the probe diameter. For all measurement points, the angle of the probe with respect to the flat phantom surface shall be less than 5°. If this cannot be achieved an additional uncertainty evaluation is needed.

- l) Use post processing(e.g. interpolation and extrapolation) procedures to determine the local SAR values at the spatial resolution needed for mass averaging.

Power Drift

To control the output power stability during the SAR test, DASY5 system calculates the power drift by measuring the E-field at the same location at the beginning and at the end of the measurement for each test position. These drift values can be found in Table 2 to Table 6 labeled as: (Power Drift [dB]). This ensures that the power drift during one measurement is within 5%.

5. TEST CONDITIONS AND RESULTS

5.1. Conducted Power Results

According KDB 447498 D01 General RF Exposure Guidance v06 Section 4.1 2) states that “Unless it is specified differently in the published RF exposure KDB procedures, these requirements also apply to test reduction and test exclusion considerations. Time-averaged maximum conducted output power applies to SAR and, as required by § 2.1091(c), time-averaged ERP applies to MPE. When an antenna port is not available on the device to support conducted power measurement, such as FRS and certain Part 15 transmitters with built-in integral antennas, the maximum output power allowed for production units should be used to determine RF exposure test exclusion and compliance.”

SAR may be scaled if radio is tested at lower power without overheating as invalid SAR results cannot be scaled to compensate for power droop according to October 2015 TCB Workshop.

Table 5

Modulation Type	Channel Separation	Test Channel	Test Frequency	Average Transmitter Power			
				Rated High power level		Rated Lower power level	
				(dBm)	(Watts)	(dBm)	(Watts)
Analog/FM	12.5KHz	Ch1	150.80 MHz	36.51	4.477	30.14	1.033
		Ch2	156.45 MHz	36.48	4.446	30.19	1.045
		Ch3	162.10 MHz	36.67	4.645	30.04	1.009
		Ch4	167.75 MHz	36.55	4.519	30.02	1.005
		Ch5	173.40 MHz	36.47	4.436	29.98	0.995
Digital/4FSK	12.5KHz	Ch6	150.80 MHz	35.88	3.873	29.24	0.839
		Ch7	156.45 MHz	35.74	3.750	29.43	0.877
		Ch8	162.10 MHz	35.75	3.758	29.23	0.838
		Ch9	167.75 MHz	35.91	3.899	29.23	0.838
		Ch10	173.40 MHz	35.94	3.926	29.41	0.873

Note:

- As the average power of LMR(Land Mobile Radio) in FM modulation (CW) mode higher than 4FSK mode, LMR SAR tests were performed in CW (FM) mode (100% duty cycle) and 50% duty cycle was applied to PTT configurations in the final results.
- The high power level and lower power level adjust by software, without any modification for hardware.

5.2. Test reduction procedure

The calculated 1-g and 10-g average SAR results indicated as “Max Calc. SAR1-g” and “Max Calc. SAR10-g” in the data Tables is scaling the measured SAR to account for power levelling variations and power slump. The adjusted 1-g and 10-g average SAR results indicated as “SAR1-g_Adju” and “SAR10-g_Adju” in the data Tables is scaling the measured SAR in lower power to account for the same frequency high power levelling. A Table and graph of output power versus time is provided.

For this device the “Max Calc. 1g-SAR” and “Max Calc.10g-SAR” are scaled using the following formula:

$$\text{Max_Calc} = \text{SAR_Adju} * \text{DC} * (\text{P_max} / \text{P_cond})$$

P_max = highest power including turn up tolerance (W)

P_cond_high = highest power in conduct measured (W)

DC = Transmission mode Duty Cycle in % where applicable 50% duty cycle is applied for PTT operation

SAR_adju = Adjust 1-g and 10-g Average SAR from measured SAR (W/kg)

$$\text{SAR_Adju} = \text{SAR_meas} * (\text{P_cond_high} / \text{P_cond_low})$$

P_cond_high = highest power at high power level (W)

P_cond_low = values of highest power frequency rated low power level (W)

5.3. SAR Measurement Results

5.3.1 LMR Assessment at the Head for 150.8-173.4 MHz Band

Battery B00237200 was selected as the default battery for assessment at the Head and Body because it is only battery (refer to external photos for battery illustration). The default battery was used during conducted

power measurements for all test channels in listed in Table 5. The channel with the highest conducted power will be identified as the default channel per KDB 643646 (SAR Test for PTT Radios). We tested highest power channel in lower power in order to meet power drift refer to according to October 2015 TCB Workshop, we adjusted measured SAR values in lower power to highest power; SAR plots of the highest results are presented in SAR measurement results according to KDB 865664D02;

Table 6

Test Frequency		Mode	P_cond_high (W)	P_cond_low (W)	Carry Accessory	Audio Accessory	Spacing (mm)	SAR_meas. (W/kg)	Power Drift (dB)	Scaling Factor	SAR_adju (W/kg)
Channel	MHz										
Ch1	150.80	CW	4.477	1.033	SBC100	n/a	25	0.194	-0.12	4.603	0.893
Ch2	156.45	CW	4.446	1.045							
Ch3	162.10	CW	4.645	1.009							
Ch4	167.75	CW	4.519	1.005							
Ch5	173.40	CW	4.436	0.995							

Head SAR Test Considerations Note:

1. *Passive body-worn and audio accessories generally do not apply to the head SAR of PTT radios. Head SAR is measured with the front surface of the radio positioned at 2.5 cm parallel to a flat phantom. A phantom shell thickness of 2 mm is required. When the front of the radio has a contour or non-uniform surface with a variation of 1.0 cm or more, the average distance of such variations is used to establish the 2.5 cm test separation from the phantom.*
2. *Testing antennas with the default battery:*
 - A. *Start by testing a PTT radio with a standard battery (default battery) that is supplied with the radio to measure the head SAR of each antenna on the highest output power channel, according to the test channels required by the number-of-test-channels formula in KDB Publication 447498 D01 and in the frequency range covered by each antenna within the operating frequency bands of the radio. When multiple standard batteries are supplied with a radio, the battery with the highest capacity is considered the default battery for making head SAR measurements.*
 - l) *When the head SAR of an antenna tested in A) is:*
 - a). ≤ 3.5 W/kg, testing of all other required channels is not necessary for that antenna
 - b). > 3.5 W/kg and ≤ 4.0 W/kg, testing of the required immediately adjacent channel(s) is not necessary; testing of the other required channels may still be required
 - c). > 4.0 W/kg and ≤ 6.0 W/kg, head SAR should be measured for that antenna on the required immediately adjacent channels; testing of the other required channels still needs consideration.
 - d). > 6.0 W/kg, test all required channels for that antenna
 - e). for the remaining channels that cannot be excluded in b) and c), which still require consideration, the 3.5 W/kg exclusion in a) and 4.0 W/kg exclusion in b) may be applied recursively with respect to the highest output power channel among the remaining channels; measure the SAR for the remaining channels that cannot be excluded
 - i) if an immediately adjacent channel measured in c) or a remaining channel measured in e) is > 6.0 W/kg, test all required channels for that antenna.
3. *Testing antennas with additional batteries:*
 - A. *Based on the SAR distributions measured in 1), for antennas of the same type and construction operating within the same device frequency band, if the frequency range of an antenna (A) is fully within the frequency range of another antenna (B) and the highest SAR for antenna (A) is either ≤ 4.0 W/kg or ≤ 6.0 W/kg and it is at least 25% lower than the highest SAR measured for antenna (B) within the device operating frequency band, further head SAR tests with additional batteries for antenna (A) are not necessary. Justifications for antenna similarities must be clearly explained in the SAR report.*
 - B. *When the SAR for all antennas tested using the default battery in 1) are ≤ 4.0 W/kg, test additional batteries using the antenna and channel configuration that resulted in the highest SAR among all antennas tested in 1). Testing of additional batteries in combination with the remaining antennas is unnecessary.*
 - l) *When the SAR measured with an additional battery in B) is > 6.0 W/kg, test that additional battery on the highest SAR channel of each antenna measured in 1)*
 - a). *if the SAR measured in l) is > 6.0 W/kg, test that additional battery and antenna combination(s) on the required immediately adjacent channels*
 - i) *if the SAR measured in l) or a) is > 7.0 W/kg, test all required channels for the antenna and battery combination(s).*
 - C. *When the SAR for at least one of the antennas tested in 1) with the default battery is > 4.0 W/kg:*
 - l) *An antenna tested in 1) with highest SAR ≤ 4.0 W/kg does not need to be tested for additional batteries.*

- II) When the highest SAR of an antenna tested in 1) is > 4.0 W/kg and ≤ 6.0 W/kg, test additional batteries on the channel that resulted in the highest SAR for that antenna in 1).
- III) When the SAR of an antenna tested in 1) or in 2) C) II) is > 6.0 W/kg, test that battery and antenna combination on the required immediately adjacent channels
 - a) if the SAR measured in III) is > 7.0 W/kg, test that battery and antenna combination on all required channels

5.3.2 LMR Assessment at the Body worn for Body with SBC00 and EH0100

DUT assessment with offered antennas, default battery (B00237200) and, default body worn accessory (SBC100), default audio accessory (EH0100) per KDB 643646. The default battery was used during conducted power measurements for all test channels in listed in Table 5. The channel with the highest conducted power will be identified as the default channel per KDB 643646 (SAR Test for PTT Radios). We tested highest power channel in lower power in order to meet power drift refer to according to October 2015 TCB Workshop, we adjusted measured SAR values in lower power to highest power; SAR plots of the highest results are presented in SAR measurement results according to KDB 865664D02;

Table 7

Test Frequency		Mode	P_cond_high (W)	P_cond_low (W)	Carry Accessory	Audio Accessory	Spacing (mm)	SAR_meas. (W/kg)	Power Drift (dB)	Scaling Factor	SAR_adju (W/kg)
Channel	MHz										
Ch1	150.80	CW	4.477	1.033	SBC100	EH0100	0	0.373	-0.19	4.603	1.717
Ch2	156.45	CW	4.446	1.045							
Ch3	162.10	CW	4.645	1.009							
Ch4	167.75	CW	4.519	1.005							
Ch5	173.40	CW	4.436	0.995							

Body SAR Test Considerations for Body-worn Accessories Note:

1. *Body SAR is measured with the radio placed in a body-worn accessory, positioned against a flat phantom, representative of the normal operating conditions expected by users and typically with a standard default audio accessory supplied with the radio. Since audio accessories, including any default audio accessories supplied with a radio, may be designed to operate with a subset of the combinations of antennas, batteries and body-worn accessories, when a default audio accessory does not fully support all the test configurations required in this section for body-worn accessories testing an alternative audio accessory must be selected to be the default audio accessory for body-worn accessories testing.9 If an alternative audio accessory cannot be identified, body-worn accessories should be tested without any audio accessory. In general, all sides of the radio that may be positioned facing the user when using a body-worn accessory must be considered for SAR compliance.*
2. *Testing antennas with the default battery and body-worn accessory:*
 - A) *Start by testing a PTT radio with the thinnest battery and a standard (default) body-worn accessory that are both supplied with the radio and, if applicable, a default audio accessory, to measure the body SAR of each antenna on the highest output power channel, according to the test channels required by the number-of-test-channels formula in KDB Publication 447498 D01 and in the frequency range covered by each antenna within the operating frequency bands of the radio. When multiple default body-worn accessories are supplied with a radio, the standard body-worn accessory expected to result in the highest SAR based on its construction and exposure conditions is considered the default body-worn accessory for making body-worn SAR measurements.*
 - I) *When the body SAR of an antenna tested in A) is:*
 - a) ≤ 3.5 W/kg, testing of all other required channels is not necessary for that antenna
 - b) > 3.5 W/kg and ≤ 4.0 W/kg, testing of the required immediately adjacent channel(s) is not necessary; testing of the other required channels may still be required
 - c) > 4.0 W/kg and ≤ 6.0 W/kg, body SAR should be measured for that antenna on the required immediately adjacent channels; testing of the other required channels still needs consideration
 - d) > 6.0 W/kg, test all required channels for that antenna
 - e) for the remaining channels that cannot be excluded in b) and c), which still require consideration, the 3.5 W/kg exclusion in a) and 4.0 W/kg exclusion in b) may be applied recursively with respect to the highest output power channel among the remaining channels; measure the SAR of the remaining channels that cannot be excluded
 - i) if an immediately adjacent channel measured in c) or a remaining channel measured in e) is > 6.0 W/kg, test all required channels for that antenna
3. *Testing antennas and default body-worn accessory with additional batteries:*
 - A) *For batteries with similar construction, test only the battery that is expected to result in the highest SAR. This is generally determined by the smallest antenna separation distance provided by the*

battery and body-worn accessory, between the radio and the user, with the applicable side(s) of the radio facing the user.

- B) Based on the SAR distributions measured in 1), for antennas of the same type and construction operating within the same device frequency band, if the frequency range of an antenna (A) is fully within the frequency range of another antenna (B) and the highest SAR for antenna (A) is either ≤ 4.0 W/kg or ≤ 6.0 W/kg and it is at least 25% lower than the highest SAR measured for antenna (B) within the device operating frequency band, further body SAR tests for the default body-worn accessory with additional batteries for antenna (A) are not necessary. Justifications for antenna similarities must be clearly explained in the SAR report.
 - C) When the SAR for all antennas tested using the thinnest battery in 1) is ≤ 4.0 W/kg, test additional batteries using the antenna and channel configuration that resulted in the highest SAR among all antennas tested in. Testing of additional batteries in combination with the default body-worn and audio accessory and remaining antennas is unnecessary.
 - I) When the SAR measured with an additional battery in C) is > 6.0 W/kg, test that additional battery with the default body-worn and audio accessory on the highest SAR channel for each antenna measured in 1)
 - a) if the SAR measured in I) is > 6.0 W/kg, test that additional battery and antenna combination(s) with the default body-worn and audio accessory on the required immediately adjacent channels
 - i) if the SAR measured in I) or a) is > 7.0 W/kg, test all required channels for the configuration(s)
 - D) When the SAR for at least one of the antennas tested in 1) with the thinnest battery using the default body-worn and audio accessory is > 4.0 W/kg:
 - A) An antenna tested in 1) with highest SAR ≤ 4.0 W/kg does not need to be tested for additional batteries.
 - B) When the highest SAR of an antenna tested in 1) is > 4.0 W/kg and ≤ 6.0 W/kg, test additional batteries with the default body-worn and audio accessory on the channel that resulted in the highest SAR for that antenna in 1).
 - C) When the SAR of an antenna tested in 1) or in 2) D) II) is > 6.0 W/kg, test that battery and antenna combination with the default body-worn and audio accessory on the required immediately adjacent channels
 - a) if the SAR measured in III) is > 7.0 W/kg, test that battery, antenna, body-worn and audio accessory combination on all required channels
4. Report the measured body SAR for the default body-worn and audio accessory
5. Repeat the preceding test sequence for additional body-worn accessories by replacing “default body-worn” accessory with each “additional body-worn” accessory. For body-worn accessories with similar construction and operating configurations, test only the body-worn accessory within the group that is expected to result in the highest SAR. This is typically determined by the smallest antenna separation distance provided by the body-worn accessory, between the radio and the user, with the applicable side(s) of the radio facing the user. Similarities in construction and operating configurations for batteries and body-worn accessories must be clearly explained in the SAR report.

5.3.3 LMR Assessment at the Body worn for Body with SLCB100 and EH0100

DUT assessment with offered antennas, default battery (B00237200) and, default body worn accessory (SLCB100), default audio accessory (EH0100) per KDB 643646. The default battery was used during conducted power measurements for all test channels in listed in Table 5. The channel with the highest conducted power will be identified as the default channel per KDB 643646 (SAR Test for PTT Radios). We tested highest power channel in lower power in order to meet power drift refer to according to October 2015 TCB Workshop, we adjusted measured SAR values in lower power to highest power; SAR plots of the highest results are presented in SAR measurement results according to KDB 865664D02;

Table 8

Test Frequency		Mode	P_cond_high (W)	P_cond_low (W)	Carry Accessory	Audio Accessory	Spacing (mm)	SAR_meas. (W/kg)	Power Drift (dB)	Scaling Factor	SAR_adju (W/kg)
Channel	MHz										
Ch1	150.80	CW	4.477	1.033	SLCB100	EH0100					
Ch2	156.45	CW	4.446	1.045	SLCB100	EH0100					
Ch3	162.10	CW	4.645	1.009	SLCB100	EH0100	0	0.286	-0.11	4.603	1.316
Ch4	167.75	CW	4.519	1.005	SLCB100	EH0100					
Ch5	173.40	CW	4.436	0.995	SLCB100	EH0100					

Body SAR Test Considerations for Body-worn Accessories Note:

Same as Section 5.3.2

5.3.4 LMR Assessment at the Body worn for Body with Other Audio Accessories

DUT assessment with offered antennas, default battery (B00237200) and, default body worn accessory (SLCB100), per KDB 643646. Assessment of additional audio accessories per “KDB 643646 Body SAR Test Consideration for Audio Accessories without Built-in Antenna” Section 1; The default battery was used during conducted power measurements for all test channels in listed in Table 5. The channel with the highest conducted power will be identified as the default channel per KDB 643646 (SAR Test for PTT Radios). We tested highest power channel in lower power in order to meet power drift refer to according to October 2015 TCB Workshop, we adjusted measured SAR values in lower power to highest power; SAR plots of the highest results among Section 5.3.2 are presented in SAR measurement results according to KDB 865664D02;

Table 9

Test Frequency		Mode	P_cond_high (W)	P_cond_low (W)	Carry Accessory	Audio Accessory	Spacing (mm)	SAR_meas. (W/kg)	Power Drift (dB)	Scaling Factor	SAR_adju (W/kg)
Channel	MHz										
Ch1	150.80	CW	4.477	1.033	SBC100	EA0100	0	0.359	-0.17	4.603	1.652
Ch2	156.45	CW	4.446	1.045							
Ch3	162.10	CW	4.645	1.009							
Ch4	167.75	CW	4.519	1.005							
Ch5	173.40	CW	4.436	0.995							
Ch1	150.80	CW	4.477	1.033	SBC100	ES0100	0	0.344	-0.08	4.603	1.583
Ch2	156.45	CW	4.446	1.045							
Ch3	162.10	CW	4.645	1.009							
Ch4	167.75	CW	4.519	1.005							
Ch5	173.40	CW	4.436	0.995							

Body SAR Test Considerations for Body-worn Accessories Note:

1. *Audio accessories with an integral antenna or radiating element must be tested separately from those without any primary radiating element. An audio accessory with a built-in antenna that enables the antenna on a PTT radio to be disconnected from its output while the audio accessory is in use should be tested using the highest capacity default battery. When transmission from the antenna on the PTT radio is disabled while the audio accessory is transmitting using its integral antenna, the normal body-worn accessories for the radio are not expected to influence the SAR of the audio accessory. In addition, special body-worn attachments are generally used for audio accessories with an integral antenna; the audio accessory must be tested according to how it is attached to the user during normal operation. Body SAR is measured with the audio accessory positioned against a flat phantom representative of the normal operating and exposure conditions expected by users. All sides of the audio accessory that may be positioned against the user must be considered for SAR compliance.*
2. *An audio accessory is tested on the highest output power channel, according to the test channels required by the number-of-test-channels formula in KDB Publication 447498 D01 and in the frequency range covered by the antenna on the audio accessory within the operating frequency bands of the radio to measure body SAR.*
 - A) *Based on the SAR distributions measured in 1), for audio accessories of the same type and construction operating within the same device frequency band, if the (antenna) frequency range of an audio accessory (A) is fully within the (antenna) frequency range of another audio accessory (B) and the highest SAR for accessory (A) is either ≤ 4.0 W/kg or ≤ 6.0 W/kg and it is at least 25% lower than the highest SAR measured for accessory (B) within the device operating frequency band, further body SAR tests are not necessary for audio accessory (A). Justifications for antenna and audio accessory similarities must be clearly explained in the SAR report.*
 - B) *When the body SAR of an audio accessory tested in 1) is:*
 - I) ≤ 3.5 W/kg, *testing of all other required channels is not necessary for that audio accessory*
 - II) > 3.5 W/kg and ≤ 4.0 W/kg, *testing of the required immediately adjacent channel(s) is not necessary; testing of the other required channels may still be required*
 - III) > 4.0 W/kg and ≤ 6.0 W/kg, *body SAR should be measured for that audio accessory and antenna on the required immediately adjacent channels; testing of the other required channels still needs consideration*
 - IV) > 7.0 W/kg, *test all required channels for that audio accessory*
 - V) *for the remaining channels that cannot be excluded in II) and III), which still require consideration, the 3.5 W/kg exclusion in I) and 4.0 W/kg exclusion II) may be applied recursively with respect to the highest output power channel among the remaining channels that cannot be excluded; measure the SAR for the remaining channels that cannot be excluded*
 - a) *if an immediately adjacent channel in III) or a remain channel measured in V) is > 7.0 W/kg, test all required channels for that audio accessory*

5.4. SAR Reporting Results

These are not actual measurement SAR values, measurement SAR values taken from Section 5.3 SAR Measurement Results; we also take Section 5.2 formula to calculate maximum report SAR in 50% duty cycle.

$$\text{Max_Calc} = \text{SAR_Adju} * \text{DC} * (\text{P_max} / \text{P_cond})$$

P_max = highest power including turn up tolerance (W)

P_cond_high = highest power in conduct measured (W)

DC = Transmission mode Duty Cycle in % where applicable 50% duty cycle is applied for PTT operation

SAR_adju = Adjust 1-g and 10-g Average SAR from measured SAR (W/kg)

5.4.1 LMR Assessment at the Head for 150.8-173.4 MHz Band

Table 10

Test Frequency		Mode	P_cond_high (W)	P_max	Carry Accessory	Audio Accessory	Spacing (mm)	SAR_adju (W/kg)	Power Drift (dB)	Scaling Factor	Max Calc. SAR _{1-g} (W/kg)	Plot
Channel	MHz											
Ch1	150.80	PTT	4.477	5.623	SBC100	n/a	25	0.893	-0.12	1.211	0.540	1
Ch2	156.45	PTT	4.446	5.623								
Ch3	162.10	PTT	4.645	5.623								
Ch4	167.75	PTT	4.519	5.623								
Ch5	173.40	PTT	4.436	5.623								

5.4.2 LMR Assessment at the Body worn for Body with SBC00 and EH0100

Table 11

Test Frequency		Mode	P_cond_high (W)	P_max	Carry Accessory	Audio Accessory	Spacing (mm)	SAR_adju (W/kg)	Power Drift (dB)	Scaling Factor	Max Calc. SAR _{1-g} (W/kg)	Plot
Channel	MHz											
Ch1	150.80	PTT	4.477	5.623	SBC100	EH0100	0	1.717	-0.19	1.211	1.040	2
Ch2	156.45	PTT	4.446	5.623			0					
Ch3	162.10	PTT	4.645	5.623			0					
Ch4	167.75	PTT	4.519	5.623			0					
Ch5	173.40	PTT	4.436	5.623			0					

5.4.3 LMR Assessment at the Body worn for Body with SLCB100 and EH0100

Table 12

Test Frequency		Mode	P_cond_high (W)	P_max	Carry Accessory	Audio Accessory	Spacing (mm)	SAR_adju (W/kg)	Power Drift (dB)	Scaling Factor	Max Calc. SAR _{1-g} (W/kg)	Plot
Channel	MHz											
Ch1	150.80	PTT	4.477	5.623	SLCB100	EH0100	0	1.316	-0.11	1.211	0.796	3
Ch2	156.45	PTT	4.446	5.623	SLCB100	EH0100	0					
Ch3	162.10	PTT	4.645	5.623	SLCB100	EH0100	0					
Ch4	167.75	PTT	4.519	5.623	SLCB100	EH0100	0					
Ch5	173.40	PTT	4.436	5.623	SLCB100	EH0100	0					

5.4.4 LMR Assessment at the Body worn for Body with Other Audio Accessories

Table 13

Test Frequency		Mode	P_cond_high (W)	P_max	Carry Accessory	Audio Accessory	Spacing (mm)	SAR_adju (W/kg)	Power Drift (dB)	Scaling Factor	Max Calc. SAR _{1-g} (W/kg)	Plot
Channel	MHz											
Ch1	150.80	PTT	4.477	5.623	SBC100	EA0100	0	1.652	-0.17	1.211	1.000	
Ch2	156.45	PTT	4.446	5.623			0					
Ch3	162.10	PTT	4.645	5.623			0					
Ch4	167.75	PTT	4.519	5.623			0					
Ch5	173.40	PTT	4.436	5.623			0					
Ch1	150.80	PTT	4.477	5.623	SBC100	ES0100	0	1.583	-0.08	1.211	0.959	
Ch2	156.45	PTT	4.446	5.623			0					
Ch3	162.10	PTT	4.645	5.623			0					
Ch4	167.75	PTT	4.519	5.623			0					
Ch5	173.40	PTT	4.436	5.623			0					

5.5. SAR Measurement Variability

SAR measurement variability must be assessed for each frequency band, which is determined by the SAR probe calibration point and tissue-equivalent medium used for the device measurements. When both head and body tissue-equivalent media are required for SAR measurements in a frequency band, the variability measurement procedures should be applied to the tissue medium with the highest measured SAR, using the highest measured SAR configuration for that tissue-equivalent medium. The following procedures are applied to determine if repeated measurements are required.

- 1) Repeated measurement is not required when the original highest measured SAR is < 0.80 W/kg; steps 2) through 4) do not apply.
- 2) When the original highest measured SAR is ≥ 0.80 W/kg, repeat that measurement once.
- 3) Perform a second repeated measurement only if the ratio of largest to smallest SAR for the original and first repeated measurements is > 1.20 or when the original or repeated measurement is ≥ 1.45 W/kg (~ 10% from the 1-g SAR limit).
- 4) Perform a third repeated measurement only if the original, first or second repeated measurement is ≥ 1.5 W/kg and the ratio of largest to smallest SAR for the original, first and second repeated measurements is > 1.20.

The same procedures should be adapted for measurements according to extremity and occupational exposure limits by applying a factor of 2.5 for extremity exposure and a factor of 5 for occupational exposure to the corresponding SAR thresholds.

Thus the following procedures are applied to determine if repeated measurements are required for occupational exposure.

- 5) Repeated measurement is not required when the original highest measured SAR is < 4.00 W/kg; steps 6) through 8) do not apply.
- 6) When the original highest measured SAR is ≥ 4.00 W/kg, repeat that measurement once.
- 7) Perform a second repeated measurement only if the ratio of largest to smallest SAR for the original and first repeated measurements is > 6.00 or when the original or repeated measurement is ≥ 7.25 W/kg (~ 10% from the 1-g SAR limit).
- 8) Perform a third repeated measurement only if the original, first or second repeated measurement is ≥ 7.5 W/kg and the ratio of largest to smallest SAR for the original, first and second repeated measurements is > 1.20.

Frequency (MHz)	Mode	Carry Accessory	Audio Accessory	Test Position	Repeated SAR (yes/no)	Highest SAR _{1-g, adju} (mW/g)	First Repeated	
							SAR _{1-g, adju} (mW/g)	Largest to Smallest SAR Ratio
162.10	CW	SBC100	EH0100	Body-worn	no	1.717	n/a	n/a

5.6. Measurement Uncertainty (100-300MHz)

According to IEC62209-1/IEEE 1528:2013										
No.	Error Description	Type	Uncertainty Value	Probably Distribution	Div.	(Ci) 1g	(Ci) 10g	Std. Unc. (1g)	Std. Unc. (10g)	Degree of freedom
Measurement System										
1	Probe calibration	B	5.50%	N	1	1	1	5.50%	5.50%	∞
2	Axial isotropy	B	4.70%	R	$\sqrt{3}$	0.7	0.7	1.90%	1.90%	∞
3	Hemispherical isotropy	B	9.60%	R	$\sqrt{3}$	0.7	0.7	3.90%	3.90%	∞
4	Boundary Effects	B	1.00%	R	$\sqrt{3}$	1	1	0.60%	0.60%	∞
5	Probe Linearity	B	4.70%	R	$\sqrt{3}$	1	1	2.70%	2.70%	∞
6	Detection limit	B	1.00%	R	$\sqrt{3}$	1	1	0.60%	0.60%	∞
7	RF ambient conditions-noise	B	0.00%	R	$\sqrt{3}$	1	1	0.00%	0.00%	∞
8	RF ambient conditions-	B	0.00%	R	$\sqrt{3}$	1	1	0.00%	0.00%	∞

	reflection									
9	Response time	B	0.80%	R	$\sqrt{3}$	1	1	0.50%	0.50%	∞
10	Integration time	B	5.00%	R	$\sqrt{3}$	1	1	2.90%	2.90%	∞
11	RF ambient	B	3.00%	R	$\sqrt{3}$	1	1	1.70%	1.70%	∞
12	Probe positioned mech. restrictions	B	0.40%	R	$\sqrt{3}$	1	1	0.20%	0.20%	∞
13	Probe positioning with respect to phantom shell	B	2.90%	R	$\sqrt{3}$	1	1	1.70%	1.70%	∞
14	Max.SAR evaluation	B	3.90%	R	$\sqrt{3}$	1	1	2.30%	2.30%	∞
Test Sample Related										
15	Test sample positioning	A	1.86%	N	1	1	1	1.86%	1.86%	∞
16	Device holder uncertainty	A	1.70%	N	1	1	1	1.70%	1.70%	∞
17	Drift of output power	B	5.00%	R	$\sqrt{3}$	1	1	2.90%	2.90%	∞
Phantom and Set-up										
18	Phantom uncertainty	B	4.00%	R	$\sqrt{3}$	1	1	2.30%	2.30%	∞
19	Liquid conductivity (target)	B	5.00%	R	$\sqrt{3}$	0.64	0.43	1.80%	1.20%	∞
20	Liquid conductivity (meas.)	A	0.50%	N	1	0.64	0.43	0.32%	0.26%	∞
21	Liquid permittivity (target)	B	5.00%	R	$\sqrt{3}$	0.64	0.43	1.80%	1.20%	∞
22	Liquid cpermittivity (meas.)	A	0.16%	N	1	0.64	0.43	0.10%	0.07%	∞
Combined standard uncertainty	$u_c = \sqrt{\sum_{i=1}^{22} c_i^2 u_i^2}$		/	/	/	/	/	10.20%	10.00%	∞
Expanded uncertainty (confidence interval of 95 %)	$u_e = 2u_c$		/	R	K=2	/	/	20.40%	20.00%	∞

According to IEC62209-2/2010

No.	Error Description	Type	Uncertainty Value	Probably Distribution	Div.	(Ci) 1g	(Ci) 10g	Std. Unc. (1g)	Std. Unc. (10g)	Degree of freedom
Measurement System										
1	Probe calibration	B	6.20%	N	1	1	1	6.20%	6.20%	∞
2	Axial isotropy	B	4.70%	R	$\sqrt{3}$	0.7	0.7	1.90%	1.90%	∞
3	Hemispherical isotropy	B	9.60%	R	$\sqrt{3}$	0.7	0.7	3.90%	3.90%	∞
4	Boundary Effects	B	2.00%	R	$\sqrt{3}$	1	1	1.20%	1.20%	∞
5	Probe	B	4.70%	R	$\sqrt{3}$	1	1	2.70%	2.70%	∞

	Linearity									
6	Detection limit	B	1.00%	R	$\sqrt{3}$	1	1	0.60%	0.60%	∞
7	RF ambient conditions-noise	B	0.00%	R	$\sqrt{3}$	1	1	0.00%	0.00%	∞
8	RF ambient conditions-reflection	B	0.00%	R	$\sqrt{3}$	1	1	0.00%	0.00%	∞
9	Response time	B	0.80%	R	$\sqrt{3}$	1	1	0.50%	0.50%	∞
10	Integration time	B	5.00%	R	$\sqrt{3}$	1	1	2.90%	2.90%	∞
11	RF Ambient	B	3.00%	R	$\sqrt{3}$	1	1	1.70%	1.70%	∞
12	Probe positioned mech. restrictions	B	0.80%	R	$\sqrt{3}$	1	1	0.50%	0.50%	∞
13	Probe positioning with respect to phantom shell	B	6.70%	R	$\sqrt{3}$	1	1	3.90%	3.90%	∞
14	Max.SAR Evaluation	B	3.90%	R	$\sqrt{3}$	1	1	2.30%	2.30%	∞
15	Modulation Response	B	2.40%	R	$\sqrt{3}$	1	1	1.40%	1.40%	∞
Test Sample Related										
16	Test sample positioning	A	1.86%	N	1	1	1	1.86%	1.86%	∞
17	Device holder uncertainty	A	1.70%	N	1	1	1	1.70%	1.70%	∞
18	Drift of output power	B	5.00%	R	$\sqrt{3}$	1	1	2.90%	2.90%	∞
Phantom and Set-up										
19	Phantom uncertainty	B	6.10%	R	$\sqrt{3}$	1	1	3.50%	3.50%	∞
20	SAR correction	B	1.90%	R	$\sqrt{3}$	1	0.84	1.11%	0.90%	∞
21	Liquid conductivity (target)	B	5.00%	R	$\sqrt{3}$	0.64	0.43	1.80%	1.20%	∞
22	Liquid conductivity (meas.)	A	0.50%	N	1	0.64	0.43	0.32%	0.26%	∞
23	Liquid permittivity (target)	B	5.00%	R	$\sqrt{3}$	0.64	0.43	1.80%	1.20%	∞
24	Liquid permittivity (meas.)	A	0.16%	N	1	0.64	0.43	0.10%	0.07%	∞
25	Temp.Unc.-Conductivity	B	3.40%	R	$\sqrt{3}$	0.78	0.71	1.50%	1.40%	∞
26	Temp.Unc.-Permittivity	B	0.40%	R	$\sqrt{3}$	0.23	0.26	0.10%	0.10%	∞
Combined standard uncertainty	$u_c = \sqrt{\sum_{i=1}^{22} c_i^2 u_i^2}$		/	/	/	/	/	12.90%	12.70%	∞
Expanded uncertainty (confidence interval of 95 %)	$u_e = 2u_c$		/	R	K=2	/	/	25.80%	25.40%	∞

Uncertainty of a System Performance Check with DASY5 System										
According to IEC62209-2/2010										
No.	Error Description	Type	Uncertainty Value	Probably Distribution	Div.	(Ci) 1g	(Ci) 10g	Std. Unc. (1g)	Std. Unc. (10g)	Degree of freedom
Measurement System										
1	Probe calibration	B	6.00%	N	1	1	1	6.00%	6.00%	∞
2	Axial isotropy	B	4.70%	R	$\sqrt{3}$	0.7	0.7	1.90%	1.90%	∞
3	Hemispherical isotropy	B	0.00%	R	$\sqrt{3}$	0.7	0.7	0.00%	0.00%	∞
4	Boundary Effects	B	1.00%	R	$\sqrt{3}$	1	1	0.60%	0.60%	∞
5	Probe Linearity	B	4.70%	R	$\sqrt{3}$	1	1	2.70%	2.70%	∞
6	Detection limit	B	1.00%	R	$\sqrt{3}$	1	1	0.60%	0.60%	∞
7	RF ambient conditions-noise	B	0.00%	R	$\sqrt{3}$	1	1	0.00%	0.00%	∞
8	RF ambient conditions-reflection	B	0.00%	R	$\sqrt{3}$	1	1	0.00%	0.00%	∞
9	Response time	B	0.80%	R	$\sqrt{3}$	1	1	0.50%	0.50%	∞
10	Integration time	B	5.00%	R	$\sqrt{3}$	1	1	2.90%	2.90%	∞
11	RF Ambient	B	3.00%	R	$\sqrt{3}$	1	1	1.70%	1.70%	∞
12	Probe positioned mech. restrictions	B	0.80%	R	$\sqrt{3}$	1	1	0.50%	0.50%	∞
13	Probe positioning with respect to phantom shell	B	6.70%	R	$\sqrt{3}$	1	1	3.90%	3.90%	∞
14	Max.SAR Evalation	B	3.90%	R	$\sqrt{3}$	1	1	2.30%	2.30%	∞
15	Modulation Response	B	2.40%	R	$\sqrt{3}$	1	1	1.40%	1.40%	∞
Test Sample Related										
16	Test sample positioning	A	0.00%	N	1	1	1	0.00%	0.00%	∞
17	Device holder uncertainty	A	5.00%	N	1	1	1	2.50%	2.50%	∞
18	Drift of output power	B	3.40%	R	$\sqrt{3}$	1	1	2.00%	2.00%	∞
Phantom and Set-up										
19	Phantom uncertainty	B	4.00%	R	$\sqrt{3}$	1	1	2.30%	2.30%	∞
20	SAR correction	B	1.90%	R	$\sqrt{3}$	1	0.84	1.11%	0.90%	∞
21	Liquid conductivity (meas.)	A	0.50%	N	1	0.64	0.43	0.32%	0.26%	∞
22	Liquid permittivity (meas.)	A	0.16%	N	1	0.64	0.43	0.10%	0.07%	∞
23	Temp.Unc.-Conductivity	B	1.70%	R	$\sqrt{3}$	0.78	0.71	0.80%	0.80%	∞

24	Temp.Unc.- Permittivity	B	0.40%	R	$\sqrt{3}$	0.23	0.26	0.10%	0.10%	∞
Combined standard uncertainty	$u_c = \sqrt{\sum_{i=1}^{22} c_i^2 u_i^2}$		/	/	/	/	/	13.00%	12.90%	∞
Expanded uncertainty (confidence interval of 95 %)	$u_e = 2u_c$		/	R	K=2	/	/	26.00%	25.80%	∞

5.7. System Check Results

System Performance Check at 150 MHz Head TSL

DUT: Dipole150 MHz; Type: CLA150; Serial: 4019

Date/Time: 05/24/2016 9:22:35 AM

Communication System: DuiJiangJi; Frequency: 150 MHz; Duty Cycle: 1:1

Medium parameters used (interpolated): $f = 150$ MHz; $\sigma = 0.78$ S/m; $\epsilon_r = 51.10$; $\rho = 1000$ kg/m³

Phantom section: Flat Section

DASY5 Configuration:

Probe: EX3DV4 - SN3883; ConvF(10.13, 10.13, 10.13); Calibrated: 8/22/2015;

Sensor-Surface: 2mm (Mechanical Surface Detection)

Electronics: DAE4 Sn1315; Calibrated: 07/22/2015

Phantom: ELI 4.0; Type: QDOVA001BA;

Measurement SW: DASY52, Version 52.8 (2); SEMCAD X Version 14.6.6 (6824)

System Performance Check at 150MHz/Area Scan (81x81x1): Interpolated grid: dx=1.500 mm, dy=1.50 mm

Maximum value of SAR (interpolated) = 3.92 mW/g

System Performance Check at 150MHz/Zoom Scan (7x7x7)/Cube 0: Measurement grid: dx=5mm, dy=5mm, dz=5mm

Reference Value = 68.85 V/m; Power Drift = -0.15 dB

Peak SAR (extrapolated) = 5.81 mW/g

SAR(1 g) = 3.77 mW/g; SAR(10 g) = 2.46 mW/g

Maximum value of SAR (measured) = 4.00 mW/g

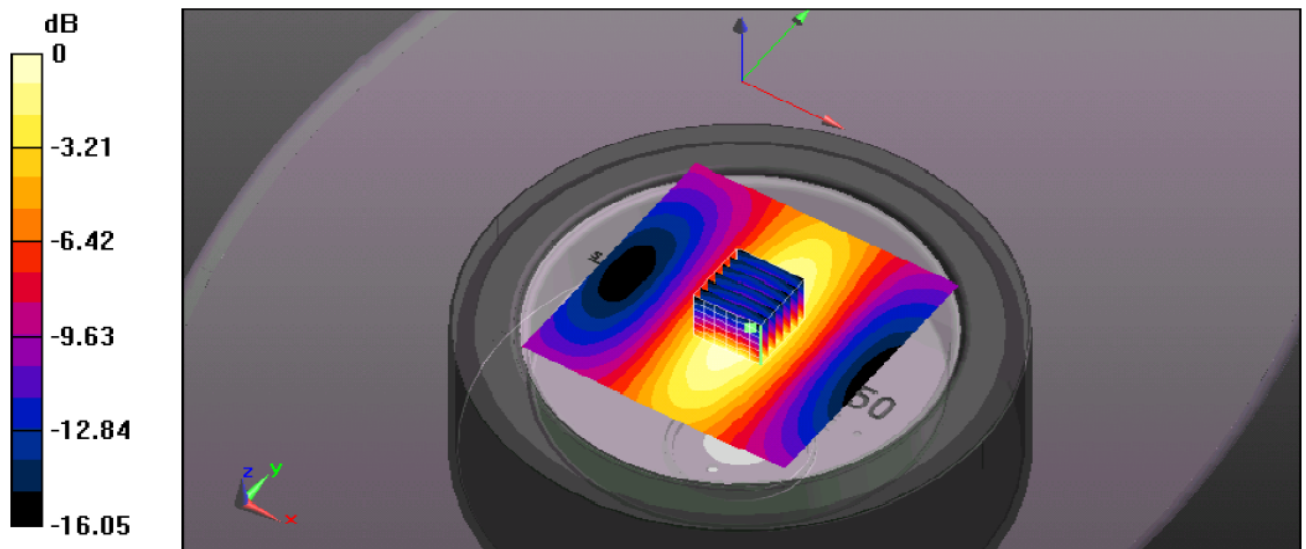

0 dB = 4.00 mW/g = 6.02 dB mW/g

System Performance Check 150MHz Head 1000mW

System Performance Check at 150 MHz Body TSL

DUT: Dipole150 MHz; Type: CLA150; Serial: 4019

Date/Time: 05/25/2016 00:35:24 AM

Medium parameters used (interpolated): $f = 150$ MHz; $\sigma = 0.83$ S/m; $\epsilon_r = 63.20$; $\rho = 1000$ kg/m³

Communication System: DuiJiangJi; Frequency: 150 MHz; Duty Cycle: 1:1

Phantom section: Flat Section

DASY5 Configuration:

Probe: EX3DV4 - SN3883; ConvF(10.15, 10.15, 10.15); Calibrated: 8/22/2015;

Sensor-Surface: 2mm (Mechanical Surface Detection)

Electronics: DAE4 Sn1315; Calibrated: 07/22/2015

Phantom: ELI 4.0; Type: QDOVA001BA;

Measurement SW: DASY52, Version 52.8 (2); SEMCAD X Version 14.6.6 (6824)

System Performance Check at 150MHz/Area Scan (81x81x1): Interpolated grid: dx=1.500 mm, dy=1.50 mm

Maximum value of SAR (interpolated) = 1.45 mW/g

System Performance Check at 150MHz/Zoom Scan (7x7x7)/Cube 0: Measurement grid: dx=5mm, dy=5mm, dz=5mm

Reference Value = 69.811 V/m; Power Drift = 0.02 dB

Peak SAR (extrapolated) = 1.71 mW/g

SAR(1 g) = 3.83 mW/g; SAR(10 g) = 2.51 mW/g

Maximum value of SAR (measured) = 4.00 mW/g

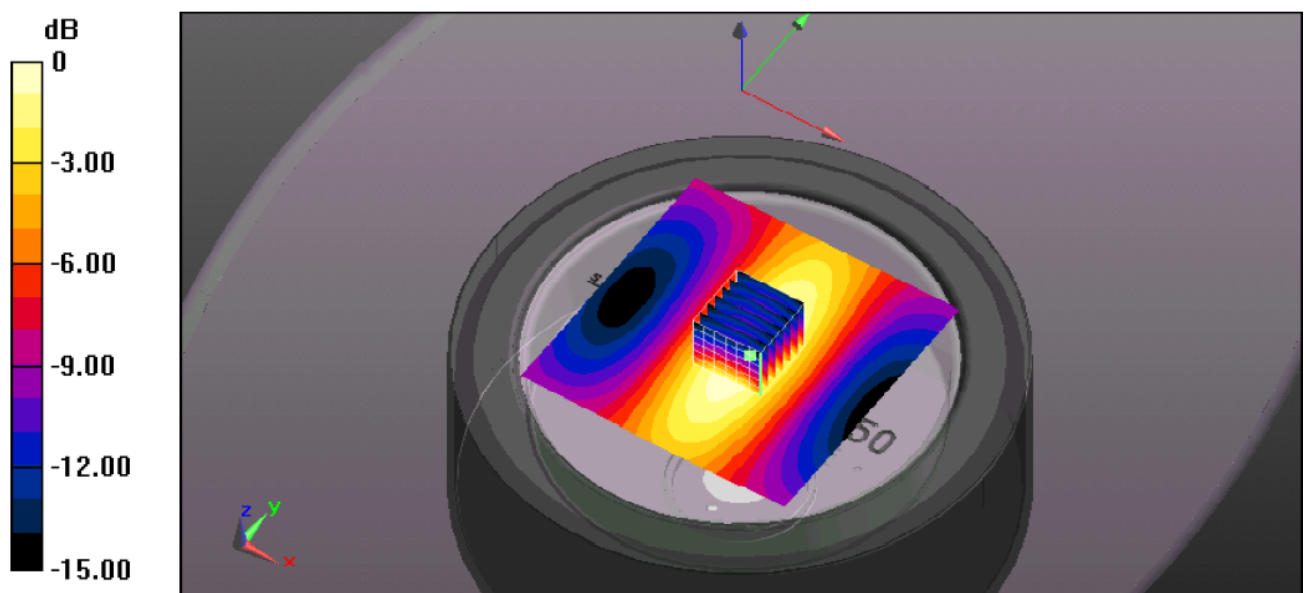

0 dB = 4.00 mW/g = 6.02 dB mW/g

5.8. SAR Test Graph Results

SAR plots for **the highest measured SAR** in each exposure configuration, wireless mode and frequency band combination according to FCC KDB 865664 D02

Face Held for FM Modulation at 12.5KHz Channel Separation, Front towards Phantom 162.10MHz

Communication System: PTT 150; Frequency: 162.10 MHz; Duty Cycle:1:1

Medium parameters used (interpolated): $f = 162.0$ MHz; $\sigma = 0.78$ S/m; $\epsilon_r = 51.60$; $\rho = 1000$ kg/m³

Phantom section: Flat Section

Probe: EX3DV4 - SN3883; ConvF(10.13, 10.13, 10.13); Calibrated: 8/22/2015;

Sensor-Surface: 2mm (Mechanical Surface Detection)

Electronics: DAE4 Sn1315; Calibrated: 07/22/2015

Phantom: ELI 4.0; Type: QDOVA001BA;

Measurement SW: DASY52, Version 52.8 (2); SEMCAD X Version 14.6.6 (6824)

Towards Phantom 162.10 MHz / Area Scan (51x181x1): Interpolated grid: dx=1.50 mm, dy=1.50 mm

Maximum value of SAR (interpolated) = 0.225 mW/g

Towards Phantom 162.10 MHz / Zoom Scan (7x7x7)/Cube 0: Measurement grid: dx=5mm, dy=5mm, dz=5mm

Reference Value = 17.601 V/m; Power Drift = -0.12 dB

Peak SAR (extrapolated) = 0.285 mW/g

SAR(1 g) = 0.194 mW/g; SAR(10 g) = 0.148 mW/g

Maximum value of SAR (measured) = 0.231 mW/g

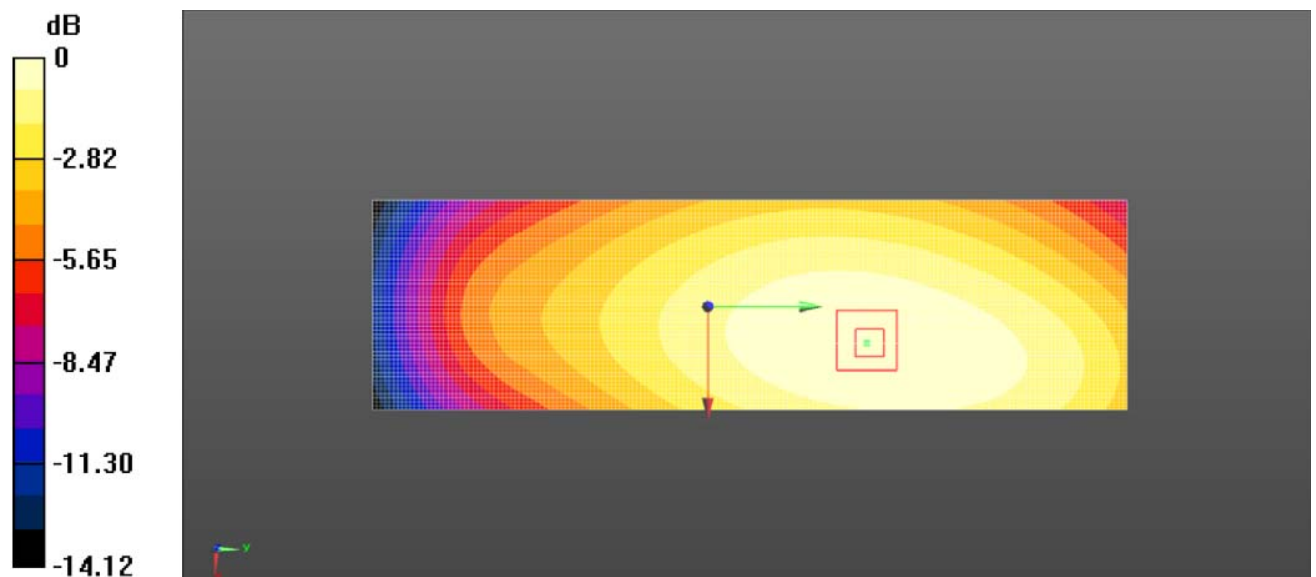

0 dB = 0.231 mW/g = -6.36 dB mW/g

Date/Time: 05/24/2016 11:14:57 AM

Figure 1: Face held for FM Modulation at 12.5KHz Channel Separation Front towards Phantom 162.10 MHz

Body- Worn FM Modulation at 12.5KHz Channel Separation With A1, B1, BC1, AC1, Front towards Ground 162.10 MHz

Communication System: PTT150; Frequency: 162.10 MHz; Duty Cycle: 1:1

Medium parameters used (interpolated): $f = 162.0$ MHz; $\sigma = 0.83$ S/m; $\epsilon_r = 63.40$; $\rho = 1000$ kg/m³

Phantom section : Flat Section

Probe: EX3DV4 - SN3883; ConvF(10.15, 10.15, 10.15); Calibrated: 8/22/2015;

Sensor-Surface: 2mm (Mechanical Surface Detection)

Electronics: DAE4 Sn1315; Calibrated: 07/22/2015

Phantom: ELI 4.0; Type: QDOVA001BA;

Measurement SW: DASY52, Version 52.8 (2); SEMCAD X Version 14.6.6 (6824)

Towards Ground 162.10 MHz / Area Scan (51x181x1): Interpolated grid: dx=1.50 mm, dy=1.50 mm

Maximum value of SAR (interpolated) = 0.416 mW/g

Towards Ground 162.10 MHz /Zoom Scan (7x7x7)/Cube 0: Measurement grid: dx=5mm, dy=5mm, dz=5mm

Reference Value = 33.614 V/m; Power Drift = -0.19 dB

Peak SAR (extrapolated) = 0.454 mW/g

SAR(1 g) = 0.373 mW/g; SAR(10 g) = 0.286 mW/g

Maximum value of SAR (measured) = 0.416 mW/g

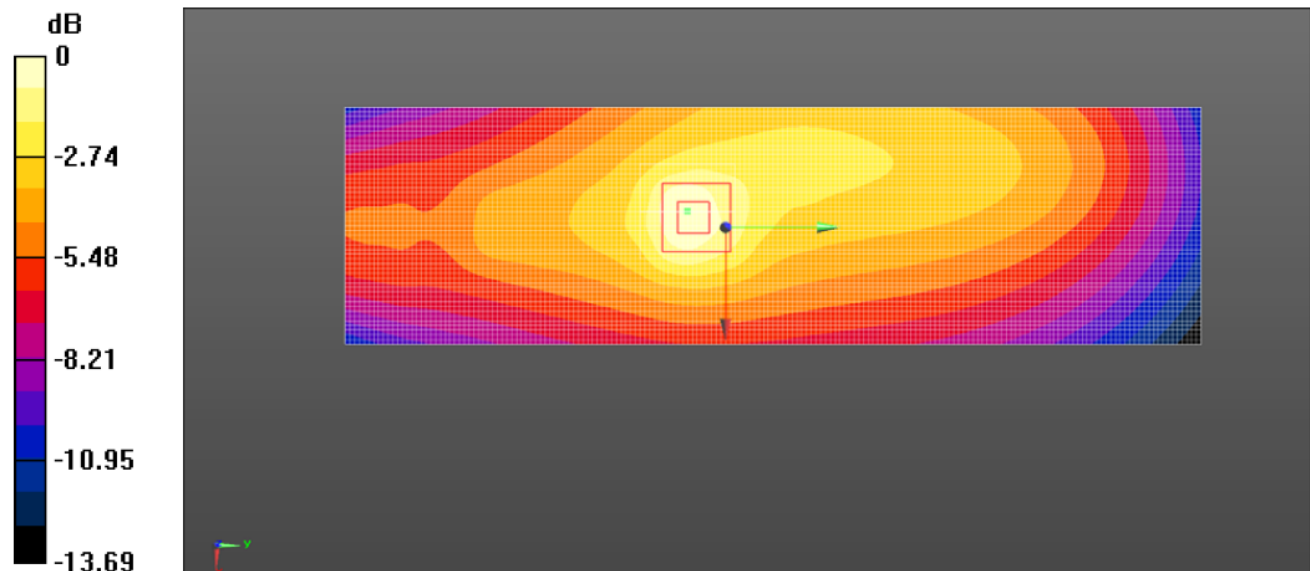

0 dB = 0.416 mW/g = -3.81 dB mW/g

Date/Time: 05/25/2016 01:14:26 AM

Plot 2: Body-worn for FM Modulation at 12.5KHz Channel Separation With A1, B1, BC1, AC1; Front towards Ground 162.10 MHz

Body- Worn FM Modulation at 12.5KHz Channel Separation With A1, B1, LA1, AC1, Front towards Ground 162.10 MHz

Communication System: PTT150; Frequency: 162.10 MHz; Duty Cycle: 1:1

Medium parameters used (interpolated): $f = 162.0$ MHz; $\sigma = 0.83$ S/m; $\epsilon_r = 63.40$; $\rho = 1000$ kg/m³

Phantom section : Flat Section

Probe: EX3DV4 - SN3883; ConvF(10.15, 10.15, 10.15); Calibrated: 8/22/2015;

Sensor-Surface: 2mm (Mechanical Surface Detection)

Electronics: DAE4 Sn1315; Calibrated: 07/22/2015

Phantom: ELI 4.0; Type: QDOVA001BA;

Measurement SW: DASY52, Version 52.8 (2); SEMCAD X Version 14.6.6 (6824)

Towards Ground 162.10 MHz / Area Scan (51x181x1): Interpolated grid: dx=1.50 mm, dy=1.50 mm

Maximum value of SAR (interpolated) = 0.288 mW/g

Towards Ground 162.10 MHz /Zoom Scan (7x7x7)/Cube 0: Measurement grid: dx=5mm, dy=5mm, dz=5mm

Reference Value = 29.808 V/m; Power Drift = -0.11 dB

Peak SAR (extrapolated) = 0.302 mW/g

SAR(1 g) = 0.286 mW/g; SAR(10 g) = 0.217 mW/g

Maximum value of SAR (measured) = 0.278 mW/g

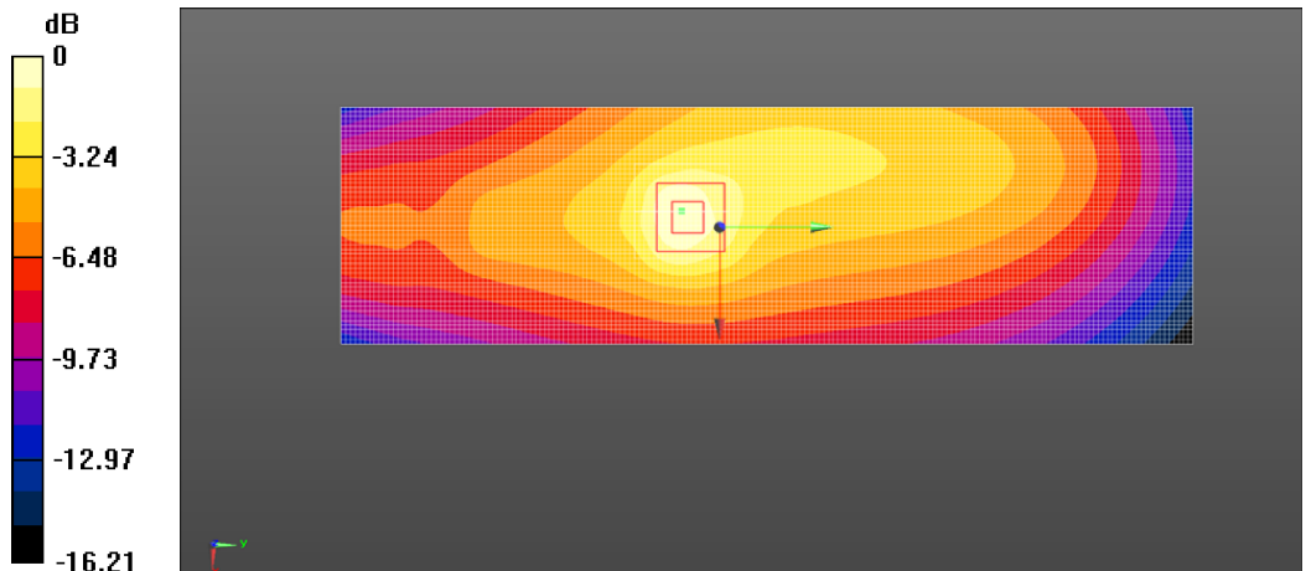

0 dB = 0.278 mW/g = -5.56 dB mW/g

Date/Time: 05/25/2016 06:45:01 AM

Plot 3: Body-worn for FM Modulation at 12.5KHz Channel Separation With A1, B1, LA1, AC1; Front towards Ground 162.10 MHz

6. Calibration Certificate

6.1. Probe Calibration Certificate

Calibration Laboratory of
Schmid & Partner
Engineering AG
Zeughausstrasse 43, 8004 Zurich, Switzerland



S Schweizerischer Kalibrierdienst
C Service suisse d'étalonnage
S Servizio svizzero di taratura
S Swiss Calibration Service

Accredited by the Swiss Accreditation Service (SAS)
The Swiss Accreditation Service is one of the signatories to the EA
Multilateral Agreement for the recognition of calibration certificates

Accreditation No.: SCS 0108

Client **CTTL (Auden)**

Certificate No: **EX3-3883_Aug15**

CALIBRATION CERTIFICATE

Object **EX3DV4 - SN:3883**

Calibration procedure(s) **QA CAL-01.v9, QA CAL-12.v9, QA CAL-23.v5, QA CAL-25.v6
Calibration procedure for dosimetric E-field probes**

Calibration date: **August 22, 2015**

This calibration certificate documents the traceability to national standards, which realize the physical units of measurements (SI).
The measurements and the uncertainties with confidence probability are given on the following pages and are part of the certificate.

All calibrations have been conducted in the closed laboratory facility: environment temperature $(22 \pm 3)^\circ\text{C}$ and humidity $< 70\%$.

Calibration Equipment used (M&TE critical for calibration)

Primary Standards	ID	Cal Date (Certificate No.)	Scheduled Calibration
Power meter E4419B	GB41293874	01-Apr-15 (No. 217-02128)	Mar-16
Power sensor E4412A	MY41498087	01-Apr-15 (No. 217-02128)	Mar-16
Reference 3 dB Attenuator	SN: S5054 (3c)	01-Apr-15 (No. 217-02129)	Mar-16
Reference 20 dB Attenuator	SN: S5277 (20x)	01-Apr-15 (No. 217-02132)	Mar-16
Reference 30 dB Attenuator	SN: S5129 (30b)	01-Apr-15 (No. 217-02133)	Mar-16
Reference Probe ES3DV2	SN: 3013	30-Dec-14 (No. ES3-3013_Dec14)	Dec-15
DAE4	SN: 660	14-Jan-15 (No. DAE4-660_Jan15)	Jan-16
Secondary Standards	ID	Check Date (in house)	Scheduled Check
RF generator HP 8648C	US3642U01700	4-Aug-99 (in house check Apr-13)	In house check: Apr-16
Network Analyzer HP 8753E	US37390585	18-Oct-01 (in house check Oct-14)	In house check: Oct-15

	Name	Function	Signature
Calibrated by:	Jeton Kastrati	Laboratory Technician	
Approved by:	Katja Pokovic	Technical Manager	

Issued: August 25 2015

This calibration certificate shall not be reproduced except in full without written approval of the laboratory.

**Calibration Laboratory of
Schmid & Partner
Engineering AG**
Zeughausstrasse 43, 8004 Zurich, Switzerland



S Schweizerischer Kalibrierdienst
C Service suisse d'étalonnage
S Servizio svizzero di taratura
S Swiss Calibration Service

Accredited by the Swiss Accreditation Service (SAS)

The Swiss Accreditation Service is one of the signatories to the EA
Multilateral Agreement for the recognition of calibration certificates

Accreditation No.: **SCS 0108**

Glossary:

TSL	tissue simulating liquid
NORM _{x,y,z}	sensitivity in free space
ConvF	sensitivity in TSL / NORM _{x,y,z}
DCP	diode compression point
CF	crest factor (1/duty_cycle) of the RF signal
A, B, C, D	modulation dependent linearization parameters
Polarization ϕ	ϕ rotation around probe axis
Polarization ϑ	ϑ rotation around an axis that is in the plane normal to probe axis (at measurement center), i.e., $\vartheta = 0$ is normal to probe axis
Connector Angle	information used in DASY system to align probe sensor X to the robot coordinate system

Calibration is Performed According to the Following Standards:

- IEEE Std 1528-2013, "IEEE Recommended Practice for Determining the Peak Spatial-Averaged Specific Absorption Rate (SAR) in the Human Head from Wireless Communications Devices: Measurement Techniques", June 2013
- IEC 62209-1, "Procedure to measure the Specific Absorption Rate (SAR) for hand-held devices used in close proximity to the ear (frequency range of 300 MHz to 3 GHz)", February 2005

Methods Applied and Interpretation of Parameters:

- NORM_{x,y,z}**: Assessed for E-field polarization $\vartheta = 0$ ($f \leq 900$ MHz in TEM-cell; $f > 1800$ MHz: R22 waveguide). NORM_{x,y,z} are only intermediate values, i.e., the uncertainties of NORM_{x,y,z} does not affect the E²-field uncertainty inside TSL (see below ConvF).
- NORM(f)_{x,y,z} = NORM_{x,y,z} * frequency_response** (see Frequency Response Chart). This linearization is implemented in DASY4 software versions later than 4.2. The uncertainty of the frequency response is included in the stated uncertainty of ConvF.
- DCP_{x,y,z}**: DCP are numerical linearization parameters assessed based on the data of power sweep with CW signal (no uncertainty required). DCP does not depend on frequency nor media.
- PAR**: PAR is the Peak to Average Ratio that is not calibrated but determined based on the signal characteristics
- A_{x,y,z}; B_{x,y,z}; C_{x,y,z}; D_{x,y,z}; VR_{x,y,z}**: A, B, C, D are numerical linearization parameters assessed based on the data of power sweep for specific modulation signal. The parameters do not depend on frequency nor media. VR is the maximum calibration range expressed in RMS voltage across the diode.
- ConvF and Boundary Effect Parameters**: Assessed in flat phantom using E-field (or Temperature Transfer Standard for $f \leq 800$ MHz) and inside waveguide using analytical field distributions based on power measurements for $f > 800$ MHz. The same setups are used for assessment of the parameters applied for boundary compensation (alpha, depth) of which typical uncertainty values are given. These parameters are used in DASY4 software to improve probe accuracy close to the boundary. The sensitivity in TSL corresponds to NORM_{x,y,z} * ConvF whereby the uncertainty corresponds to that given for ConvF. A frequency dependent ConvF is used in DASY version 4.4 and higher which allows extending the validity from ± 50 MHz to ± 100 MHz.
- Spherical isotropy (3D deviation from isotropy)**: in a field of low gradients realized using a flat phantom exposed by a patch antenna.
- Sensor Offset**: The sensor offset corresponds to the offset of virtual measurement center from the probe tip (on probe axis). No tolerance required.
- Connector Angle**: The angle is assessed using the information gained by determining the NORM_x (no uncertainty required).

EX3DV4 – SN:3883

August 22, 2015

Probe EX3DV4

SN:3883

Manufactured: October 25, 2011
Calibrated: August 22, 2015

Calibrated for DASYS/EASY Systems
(Note: non-compatible with DASYS2 system!)

EX3DV4 – SN:3883

August 22, 2015

DASY/EASY - Parameters of Probe: EX3DV4 - SN:3883**Basic Calibration Parameters**

	Sensor X	Sensor Y	Sensor Z	Unc (k=2)
Norm ($\mu\text{V}/(\text{V}/\text{m})^2$) ^A	0.54	0.57	0.54	$\pm 10.1\%$
DCP (mV) ^B	101.3	101.4	101.4	

Modulation Calibration Parameters

UID	Communication System Name		A dB	B dB $\sqrt{\mu\text{V}}$	C	D dB	VR mV	Unc ^E (k=2)
0	CW	X	0.0	0.0	1.0	0.00	173.3	$\pm 3.3\%$
		Y	0.0	0.0	1.0		176.3	
		Z	0.0	0.0	1.0		168.3	

The reported uncertainty of measurement is stated as the standard uncertainty of measurement multiplied by the coverage factor $k=2$, which for a normal distribution corresponds to a coverage probability of approximately 95%.

^A The uncertainties of NormX,Y,Z do not affect the E^2 -field uncertainty inside TSL (see Pages 5 and 6).

^B Numerical linearization parameter: uncertainty not required.

^E Uncertainty is determined using the max. deviation from linear response applying rectangular distribution and is expressed for the square of the field value.

EX3DV4 – SN:3883

August 22, 2015

DASY/EASY - Parameters of Probe: EX3DV4 - SN:3883

Calibration Parameter Determined in Head Tissue Simulating Media

f (MHz) ^C	Relative Permittivity ^F	Conductivity (S/m) ^F	ConvF X	ConvF Y	ConvF Z	Alpha ^G	Depth ^G (mm)	Unct. (k=2)
150	52.3	0.76	10.13	10.13	10.13	0.08	1.20	± 13.3 %

^C Frequency validity above 300 MHz of ± 100 MHz only applies for DASY v4.4 and higher (see Page 2), else it is restricted to ± 50 MHz. The uncertainty is the RSS of the ConvF uncertainty at calibration frequency and the uncertainty for the indicated frequency band. Frequency validity below 300 MHz is ± 10, 25, 40, 50 and 70 MHz for ConvF assessments at 30, 64, 128, 150 and 220 MHz respectively. Above 5 GHz frequency validity can be extended to ± 110 MHz.

^F At frequencies below 3 GHz, the validity of tissue parameters (ϵ and σ) can be relaxed to ± 10% if liquid compensation formula is applied to measured SAR values. At frequencies above 3 GHz, the validity of tissue parameters (ϵ and σ) is restricted to ± 5%. The uncertainty is the RSS of the ConvF uncertainty for indicated target tissue parameters.

^G Alpha/Depth are determined during calibration. SPEAG warrants that the remaining deviation due to the boundary effect after compensation is always less than ± 1% for frequencies below 3 GHz and below ± 2% for frequencies between 3-6 GHz at any distance larger than half the probe tip diameter from the boundary.

EX3DV4 – SN:3883

August 22, 2015

DASY/EASY - Parameters of Probe: EX3DV4 - SN:3883

Calibration Parameter Determined in Body Tissue Simulating Media

f (MHz) ^c	Relative Permittivity ^f	Conductivity (S/m) ^f	ConvF X	ConvF Y	ConvF Z	Alpha ^g	Depth (mm) ^g	Unct. (k=2)
150	61.9	0.80	10.15	10.15	10.15	0.05	1.25	± 13.3 %

^c Frequency validity above 300 MHz of ± 100 MHz only applies for DASY v4.4 and higher (see Page 2), else it is restricted to ± 50 MHz. The uncertainty is the RSS of the ConvF uncertainty at calibration frequency and the uncertainty for the indicated frequency band. Frequency validity below 300 MHz is ± 10, 25, 40, 50 and 70 MHz for ConvF assessments at 30, 64, 128, 150 and 220 MHz respectively. Above 5 GHz frequency validity can be extended to ± 110 MHz.

^f At frequencies below 3 GHz, the validity of tissue parameters (ϵ and σ) can be relaxed to ± 10% if liquid compensation formula is applied to measured SAR values. At frequencies above 3 GHz, the validity of tissue parameters (ϵ and σ) is restricted to ± 5%. The uncertainty is the RSS of the ConvF uncertainty for indicated target tissue parameters.

^g Alpha/Depth are determined during calibration. SPEAG warrants that the remaining deviation due to the boundary effect after compensation is always less than ± 1% for frequencies below 3 GHz and below ± 2% for frequencies between 3-6 GHz at any distance larger than half the probe tip diameter from the boundary.

EX3DV4 – SN:3883

August 22, 2015

Frequency Response of E-Field (TEM-Cell: ifi110 EXX, Waveguide: R22)

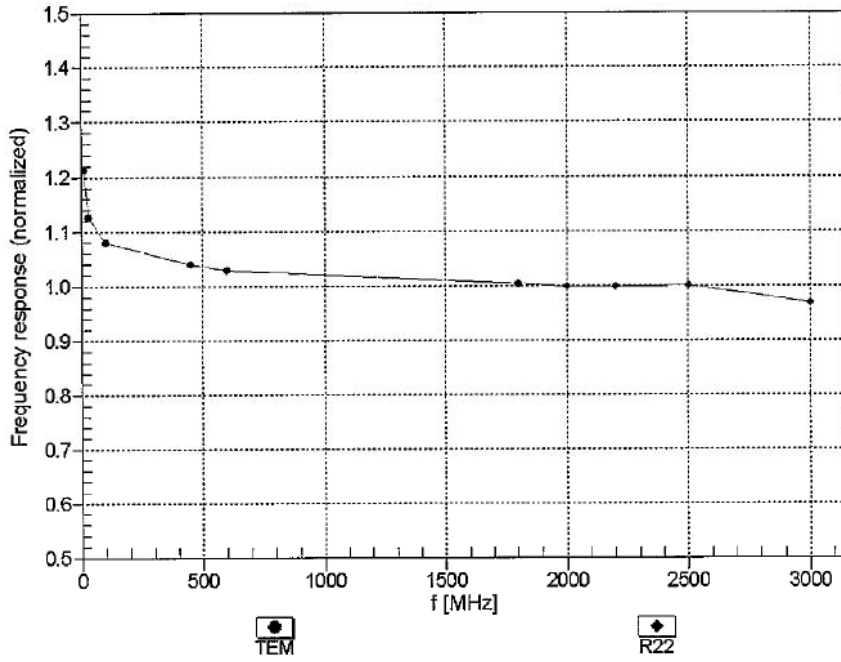

Uncertainty of Frequency Response of E-field: $\pm 6.3\%$ ($k=2$)

EX3DV4 – SN:3883

August 22, 2015

Receiving Pattern (ϕ), $\theta = 0^\circ$

f=600 MHz,TEM

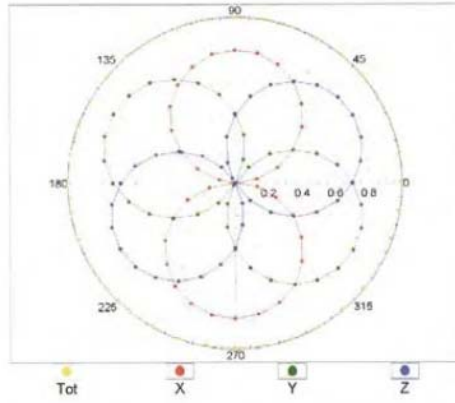

f=1800 MHz,R22

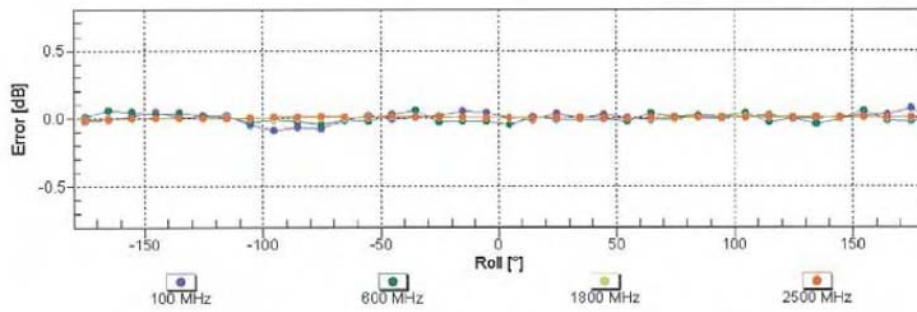
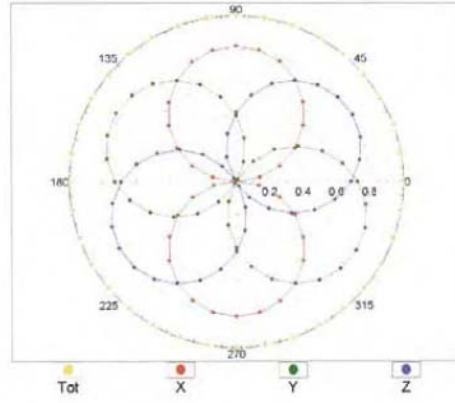

Uncertainty of Axial Isotropy Assessment: $\pm 0.5\%$ (k=2)

EX3DV4 – SN:3883

August 22, 2015

Dynamic Range $f(\text{SAR}_{\text{head}})$ (TEM cell, $f_{\text{eval}} = 1900 \text{ MHz}$)

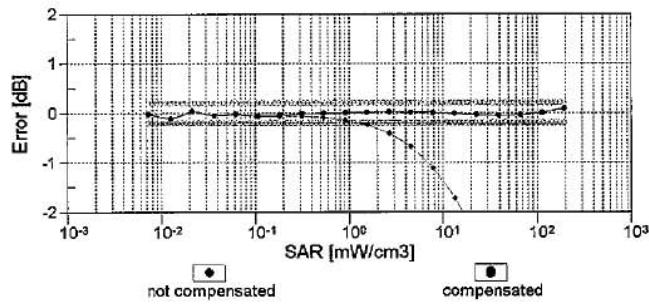
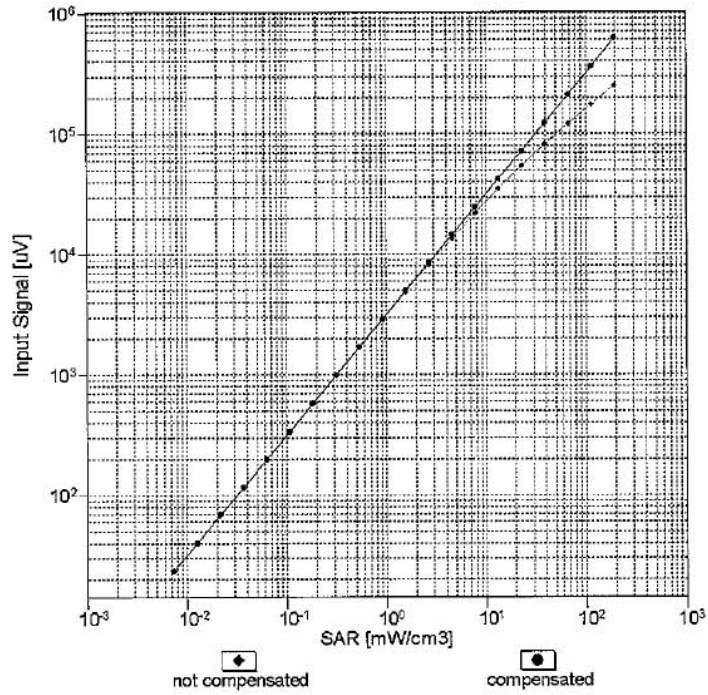

Uncertainty of Linearity Assessment: $\pm 0.6\%$ ($k=2$)

EX3DV4 – SN:3883

August 22, 2015

Conversion Factor Assessment

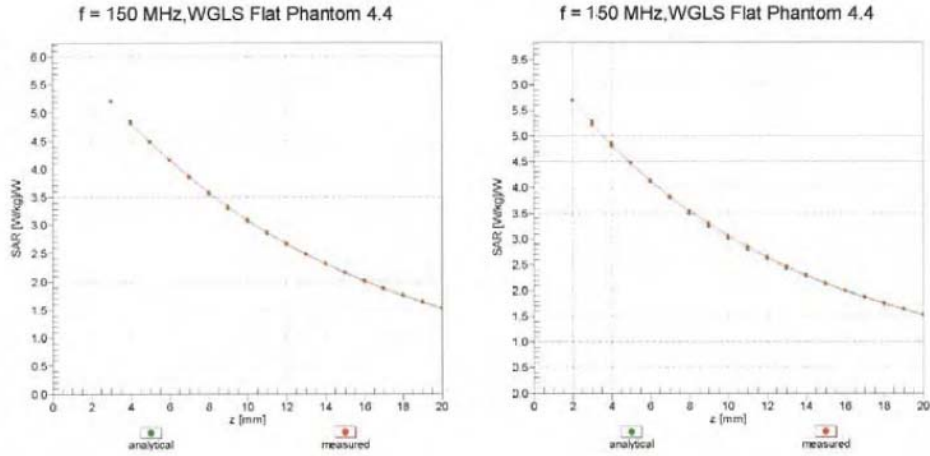

Deviation from Isotropy in Liquid

Error (ϕ, θ), f = 900 MHz

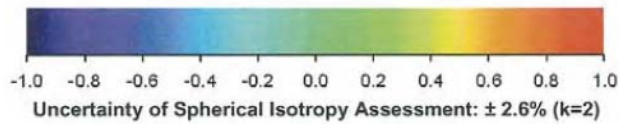
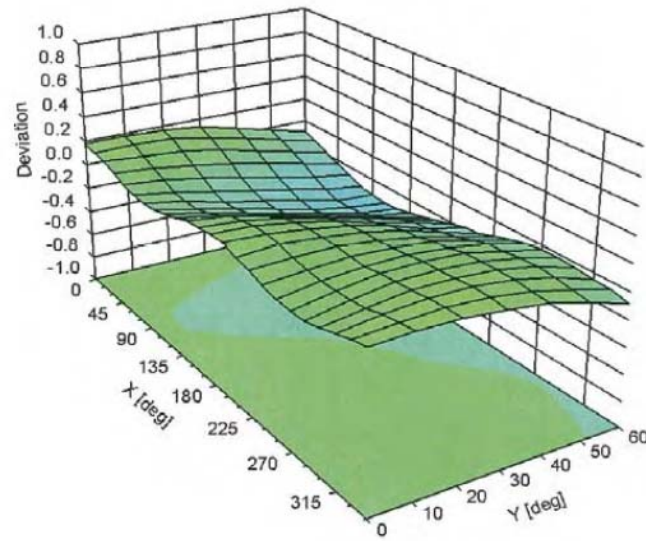

EX3DV4 – SN:3883

August 22, 2015

DASY/EASY - Parameters of Probe: EX3DV4 - SN:3883**Other Probe Parameters**

Sensor Arrangement	Triangular
Connector Angle (°)	27.7
Mechanical Surface Detection Mode	enabled
Optical Surface Detection Mode	disabled
Probe Overall Length	337 mm
Probe Body Diameter	10 mm
Tip Length	9 mm
Tip Diameter	2.5 mm
Probe Tip to Sensor X Calibration Point	1 mm
Probe Tip to Sensor Y Calibration Point	1 mm
Probe Tip to Sensor Z Calibration Point	1 mm
Recommended Measurement Distance from Surface	1.4 mm

6.2. CLA150 Dipole Calibration Certificate

**Calibration Laboratory of
Schmid & Partner
Engineering AG**
Zeughausstrasse 43, 8004 Zurich, Switzerland





S Schweizerischer Kalibrierdienst
C Service suisse d'étalonnage
S Servizio svizzero di taratura
S Swiss Calibration Service

Accredited by the Swiss Accreditation Service (SAS)
The Swiss Accreditation Service is one of the signatories to the EA
Multilateral Agreement for the recognition of calibration certificates

Accreditation No.: SCS 0108

Client **CIQ (Auden)**

Certificate No: **CLA150-4019_Feb16**

CALIBRATION CERTIFICATE

Object: **CLA150 - SN: 4019**

Calibration procedure(s): **QA CAL-15.v8
Calibration procedure for system validation sources below 700 MHz**

Calibration date: **February 11, 2016**

This calibration certificate documents the traceability to national standards, which realize the physical units of measurements (SI). The measurements and the uncertainties with confidence probability are given on the following pages and are part of the certificate.

All calibrations have been conducted in the closed laboratory facility: environment temperature (22 ± 3)°C and humidity < 70%.

Calibration Equipment used (M&TE critical for calibration)

Primary Standards	ID #	Cal Date (Certificate No.)	Scheduled Calibration
Power meter E4419B	GB41293874	01-Apr-15 (No. 217-02128)	Mar-16
Power sensor E4412A	MY41498087	01-Apr-15 (No. 217-02128)	Mar-16
Reference 3 dB Attenuator	SN: S5054 (3c)	01-Apr-15 (No. 217-02129)	Mar-16
Reference 20 dB Attenuator	SN: S5058 (20k)	01-Apr-15 (No. 217-02131)	Mar-16
Type-N mismatch combination	SN: 5047.2 / 06327	01-Apr-15 (No. 217-02134)	Mar-16
Reference Probe EX3DV4	SN: 3877	31-Dec-15 (No. EX3-3877_Dec15)	Dec-16
DAE4	SN: 654	08-Jul-15 (No. DAE4-654_Jul15)	Jul-16

Secondary Standards	ID #	Check Date (in house)	Scheduled Check
RF generator HP 8648C	US3642U01700	04-Aug-99 (in house check Apr-13)	In house check: Apr-16
Network Analyzer HP 8753E	US37390585	18-Oct-01 (in house check Oct-15)	In house check: Oct-16

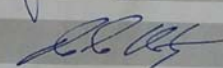
	Name	Function	Signature
Calibrated by:	Jeton Kastrati	Laboratory Technician	
Approved by:	Katja Pokovic	Technical Manager	

Issued: February 15, 2016

This calibration certificate shall not be reproduced except in full without written approval of the laboratory.

Certificate No: CLA150-4019_Feb16

Page 1 of 8

**Calibration Laboratory of
Schmid & Partner
Engineering AG**
Zeughausstrasse 43, 8004 Zurich, Switzerland



S Schweizerischer Kalibrierdienst
C Service suisse d'étalonnage
S Servizio svizzero di taratura
S Swiss Calibration Service

Accredited by the Swiss Accreditation Service (SAS)
The Swiss Accreditation Service is one of the signatories to the EA
Multilateral Agreement for the recognition of calibration certificates

Accreditation No.: SCS 0108

Glossary:

TSL	tissue simulating liquid
ConvF	sensitivity in TSL / NORM x,y,z
N/A	not applicable or not measured

Calibration is Performed According to the Following Standards:

- IEEE Std 1528-2013, "IEEE Recommended Practice for Determining the Peak Spatial-Averaged Specific Absorption Rate (SAR) in the Human Head from Wireless Communications Devices: Measurement Techniques", June 2013
- IEC 62209-1, "Procedure to measure the Specific Absorption Rate (SAR) for hand-held devices used in close proximity to the ear (frequency range of 300 MHz to 3 GHz)", February 2005
- IEC 62209-2, "Procedure to determine the Specific Absorption Rate (SAR) for wireless communication devices used in close proximity to the human body (frequency range of 30 MHz to 6 GHz)", March 2010
- KDB 865664, "SAR Measurement Requirements for 100 MHz to 6 GHz"

Additional Documentation:

- DASY4/5 System Handbook

Methods Applied and Interpretation of Parameters:

- Measurement Conditions:** Further details are available from the Validation Report at the end of the certificate. All figures stated in the certificate are valid at the frequency indicated.
- Antenna Parameters with TSL:** The source is mounted in a touch configuration below the center marking of the flat phantom.
- Return Loss:** This parameter is measured with the source positioned under the liquid filled phantom (as described in the measurement condition clause). The Return Loss ensures low reflected power. No uncertainty required.
- SAR measured:** SAR measured at the stated antenna input power.
- SAR normalized:** SAR as measured, normalized to an input power of 1 W at the antenna connector.
- SAR for nominal TSL parameters:** The measured TSL parameters are used to calculate the nominal SAR result.

The reported uncertainty of measurement is stated as the standard uncertainty of measurement multiplied by the coverage factor $k=2$, which for a normal distribution corresponds to a coverage probability of approximately 95%.

Measurement Conditions

DASY system configuration, as far as not given on page 1.

DASY Version	DASY5	V52.8.8
Extrapolation	Advanced Extrapolation	
Phantom	ELI4 Flat Phantom	Shell thickness: 2 ± 0.2 mm
EUT Positioning	Touch Position	
Zoom Scan Resolution	$dx, dy = 4.0$ mm, $dz = 1.4$ mm	Graded Ratio = 1.4 (Z direction)
Frequency	150 MHz ± 1 MHz	

Head TSL parameters

The following parameters and calculations were applied.

	Temperature	Permittivity	Conductivity
Nominal Head TSL parameters	22.0 °C	52.3	0.76 mho/m
Measured Head TSL parameters	(22.0 ± 0.2) °C	$50.4 \pm 6\%$	0.78 mho/m $\pm 6\%$
Head TSL temperature change during test	< 0.5 °C	----	----

SAR result with Head TSL

SAR averaged over 1 cm^3 (1 g) of Head TSL	Condition	
SAR measured	1 W input power	3.90 W/kg
SAR for nominal Head TSL parameters	normalized to 1W	3.79 W/kg $\pm 18.4\%$ (k=2)

SAR averaged over 10 cm^3 (10 g) of Head TSL	condition	
SAR measured	1 W input power	2.59 W/kg
SAR for nominal Head TSL parameters	normalized to 1W	2.52 W/kg $\pm 18.0\%$ (k=2)

Body TSL parameters

The following parameters and calculations were applied.

	Temperature	Permittivity	Conductivity
Nominal Body TSL parameters	22.0 °C	61.9	0.80 mho/m
Measured Body TSL parameters	(22.0 ± 0.2) °C	$60.4 \pm 6\%$	0.84 mho/m $\pm 6\%$
Body TSL temperature change during test	< 0.5 °C	----	----

SAR result with Body TSL

SAR averaged over 1 cm^3 (1 g) of Body TSL	Condition	
SAR measured	1 W input power	4.06 W/kg
SAR for nominal Body TSL parameters	normalized to 1W	3.89 W/kg $\pm 18.4\%$ (k=2)

SAR averaged over 10 cm^3 (10 g) of Body TSL	condition	
SAR measured	1 W input power	2.70 W/kg
SAR for nominal Body TSL parameters	normalized to 1W	2.59 W/kg $\pm 18.0\%$ (k=2)

Appendix (Additional assessments outside the scope of SCS 0108)**Antenna Parameters with Head TSL**

Impedance, transformed to feed point	47.4 Ω - 5.3 j Ω
Return Loss	- 24.4 dB

Antenna Parameters with Body TSL

Impedance, transformed to feed point	50.9 Ω - 8.0 j Ω
Return Loss	- 22.0 dB

Additional EUT Data

Manufactured by	SPEAG
Manufactured on	November 25, 2015

DASY5 Validation Report for Head TSL

Date: 11.02.2016

Test Laboratory: SPEAG, Zurich, Switzerland

DUT: CLA150; Type: CLA150; Serial: CLA150 - SN: 4019

Communication System: UID 0 - CW; Frequency: 150 MHz
Medium parameters used: $f = 150 \text{ MHz}$; $\sigma = 0.78 \text{ S/m}$; $\epsilon_r = 50.4$; $\rho = 1000 \text{ kg/m}^3$
Phantom section: Flat Section
Measurement Standard: DASY5 (IEEE/IEC/ANSI C63.19-2011)

DASY52 Configuration:

- Probe: EX3DV4 - SN3877; ConvF(12.02, 12.02, 12.02); Calibrated: 31.12.2015;
- Sensor-Surface: 1.4mm (Mechanical Surface Detection)
- Electronics: DAE4 Sn654; Calibrated: 08.07.2015
- Phantom: ELI v4.0; Type: QDOVA001BB; Serial: TP:1003
- DASY52 52.8.8(1258); SEMCAD X 14.6.10(7372)

CLA Calibration for HSL-LF Tissue/CLA150, touch configuration, Pin=1W/Area Scan (81x81x1): Interpolated grid: $dx=1.500 \text{ mm}$, $dy=1.500 \text{ mm}$
Maximum value of SAR (interpolated) = 5.13 W/kg

CLA Calibration for HSL-LF Tissue/CLA150, touch configuration, Pin=1W/Zoom Scan, dist=1.4mm (8x9x7)/Cube 0: Measurement grid: $dx=4\text{mm}$, $dy=4\text{mm}$, $dz=1.4\text{mm}$
Reference Value = 83.28 V/m; Power Drift = -0.01 dB
Peak SAR (extrapolated) = 7.21 W/kg
SAR(1 g) = 3.9 W/kg; SAR(10 g) = 2.59 W/kg
Maximum value of SAR (measured) = 5.45 W/kg

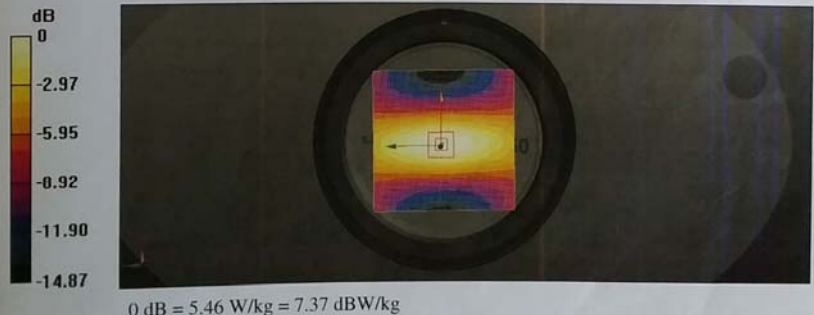

Impedance Measurement Plot for Head TSL

CH1 S11 1 U FS 11 Feb 2016 14:24:42
1: 47.443 Ω -5.3320 Ω 198.99 pF 150.000 000 MHz

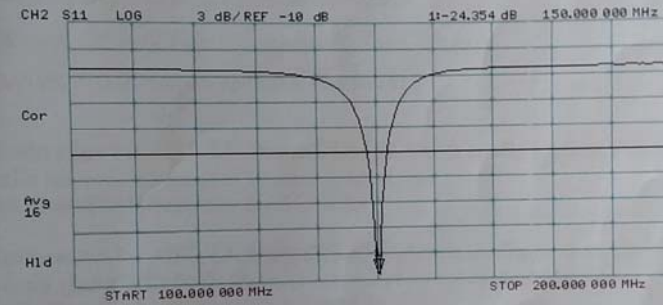
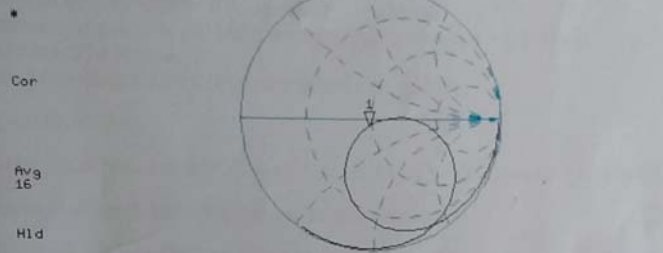

DASY5 Validation Report for Body TSL

Date: 11.02.2016

Test Laboratory: SPEAG, Zurich, Switzerland

DUT: CLA150; Type: CLA150; Serial: CLA150 - SN: 4019

Communication System: UID 0 - CW; Frequency: 150 MHz

Medium parameters used: $f = 150 \text{ MHz}$; $\sigma = 0.84 \text{ S/m}$; $\epsilon_r = 60.4$; $\rho = 1000 \text{ kg/m}^3$

Phantom section: Flat Section

Measurement Standard: DASY5 (IEEE/IEC/ANSI C63.19-2011)

DASY52 Configuration:

- Probe: EX3DV4 - SN3877; ConvF(11.44, 11.44, 11.44); Calibrated: 31.12.2015;
- Sensor-Surface: 1.4mm (Mechanical Surface Detection)
- Electronics: DAE4 Sn654; Calibrated: 08.07.2015
- Phantom: ELI v4.0; Type: QDOVA001BB; Serial: TP:1003
- DASY52 52.8.8(1258); SEMCAD X 14.6.10(7372)

CLA Calibration for MSL-LF Tissue/CLA150, touch configuration, Pin=1W/Area Scan

(81x81x1): Interpolated grid: $dx=1.500 \text{ mm}$, $dy=1.500 \text{ mm}$

Maximum value of SAR (interpolated) = 5.71 W/kg

CLA Calibration for MSL-LF Tissue/CLA150, touch configuration, Pin=1W/Zoom Scan,

dist=1.4mm (8x9x7)/Cube 0: Measurement grid: $dx=4\text{mm}$, $dy=4\text{mm}$, $dz=1.4\text{mm}$

Reference Value = 82.17 V/m; Power Drift = -0.05 dB

Peak SAR (extrapolated) = 7.49 W/kg

SAR(1 g) = 4.06 W/kg; SAR(10 g) = 2.7 W/kg

Maximum value of SAR (measured) = 5.65 W/kg

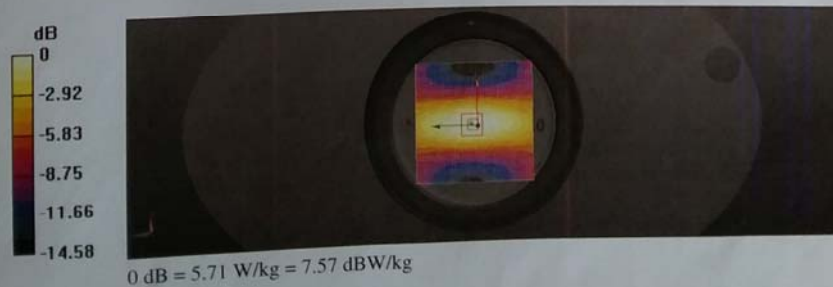

Impedance Measurement Plot for Body TSL

CHI S11 1 U FS 11 Feb 2016 19:07:10
1: 50.896 ω -8.0039 ω 132.56 pF 150.000 000 MHz

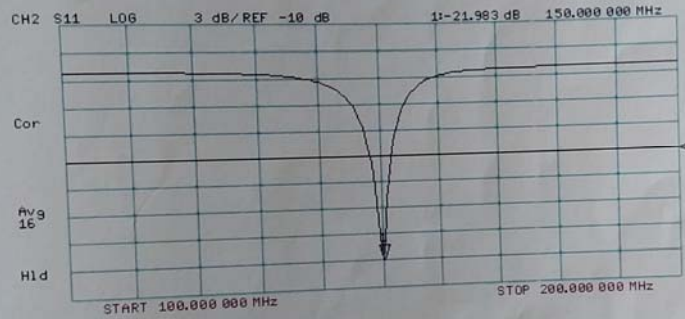
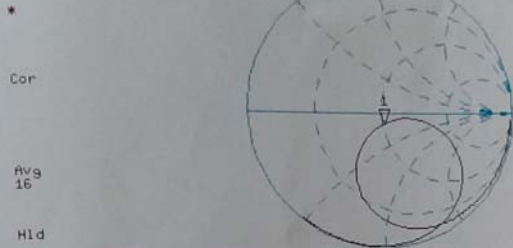

6.3. DAE4 Calibration Certificate



Add: No.51 Xueyuan Road, Haidian District, Beijing, 100191, China
 Tel: +86-10-62304633-2218 Fax: +86-10-62304633-2209
 E-mail: ttl@chinattl.com Http://www.chinattl.cn



Client : **CIQ(Shenzhen)**

Certificate No: **Z15-97098**

CALIBRATION CERTIFICATE

Object: **DAE4 - SN: 1315**

Calibration Procedure(s): **FD-Z11-2-002-01
 Calibration Procedure for the Data Acquisition Electronics (DAEx)**

Calibration date: **July 22, 2015**

This calibration Certificate documents the traceability to national standards, which realize the physical units of measurements(SI). The measurements and the uncertainties with confidence probability are given on the following pages and are part of the certificate.

All calibrations have been conducted in the closed laboratory facility: environment temperature(22±3)°C and humidity<70%.

Calibration Equipment used (M&TE critical for calibration)

Primary Standards	ID #	Cal Date(Calibrated by, Certificate No.)	Scheduled Calibration
Process Calibrator 753	1971018	06-July-15 (CTTL, No:J15X04257)	July-16

	Name	Function	Signature
Calibrated by:	Yu Zongying	SAR Test Engineer	
Reviewed by:	Qi Dianyuan	SAR Project Leader	
Approved by:	Lu Bingsong	Deputy Director of the laboratory	

Issued: July 23, 2015

This calibration certificate shall not be reproduced except in full without written approval of the laboratory.



Add: No.51 Xueyuan Road, Haidian District, Beijing, 100191, China
Tel: +86-10-62304633-2218 Fax: +86-10-62304633-2209
E-mail: cttl@chinattl.com Http://www.chinattl.cn

Glossary:

DAE data acquisition electronics
Connector angle information used in DASY system to align probe sensor X to the robot coordinate system.

Methods Applied and Interpretation of Parameters:

- *DC Voltage Measurement:* Calibration Factor assessed for use in DASY system by comparison with a calibrated instrument traceable to national standards. The figure given corresponds to the full scale range of the voltmeter in the respective range.
- *Connector angle:* The angle of the connector is assessed measuring the angle mechanically by a tool inserted. Uncertainty is not required.
- The report provide only calibration results for DAE, it does not contain other performance test results.



Add: No.51 Xueyuan Road, Haidian District, Beijing, 100191, China
 Tel: +86-10-62304633-2218 Fax: +86-10-62304633-2209
 E-mail: cttl@chinattl.com Http://www.chinattl.cn

DC Voltage Measurement

A/D - Converter Resolution nominal

High Range: 1LSB = 6.1 μ V , full range = -100...+300 mV

Low Range: 1LSB = 61nV , full range = -1.....+3mV

DASY measurement parameters: Auto Zero Time: 3 sec; Measuring time: 3 sec

Calibration Factors	X	Y	Z
High Range	405.192 \pm 0.15% (k=2)	405.031 \pm 0.15% (k=2)	404.98 \pm 0.15% (k=2)
Low Range	3.99083 \pm 0.7% (k=2)	3.98595 \pm 0.7% (k=2)	3.9887 \pm 0.7% (k=2)

Connector Angle

Connector Angle to be used in DASY system	21 $^{\circ}$ \pm 1 $^{\circ}$
---	----------------------------------



**Acceptable Conditions for SAR Measurements Using Probes and Dipoles
Calibrated under the SPEAG-CTTL Dual-Logo Calibration Program to
Support FCC Equipment Certification**

The acceptable conditions for SAR measurements using probes, dipoles and DAEs calibrated by CTTL (*China Telecommunication Technology Labs*), under the Dual-Logo Calibration Certificate program and quality assurance (QA) protocols established between SPEAG (*Schmid & Partner Engineering AG, Switzerland*) and CTTL, to support FCC (*U.S. Federal Communications Commission*) equipment certification are defined and described in the following. The conditions in this KDB are valid until December 31, 2015.

- 1) The agreement established between SPEAG and CTTL is only applicable to calibration services performed by CTTL where its clients (companies and divisions of such companies) are headquartered in the Greater China Region, including Taiwan and Hong Kong. CTTL shall inform the FCC of any changes or early termination to the agreement.
- 2) Only a subset of the calibration services specified in the SPEAG-CTTL agreement, while it remains valid, are applicable to SAR measurements performed using such equipment for supporting FCC equipment certification. These are identified in the following.
 - a) Calibration of dosimetric (SAR) probes EX3DVx, ET3DVx and ES3DVx.
 - i) Free-space E-field and H-field probes, including those used for HAC (hearing aid compatibility) evaluation, temperature probes, other probes or equipment not identified in this document, when calibrated by CTTL, are excluded and cannot be used for measurements to support FCC equipment certification.
 - ii) Signal specific and bundled probe calibrations based on PMR (probe modulation response) characteristics or probe sensor model based linearization methods that are not fully described in SAR standards are excluded and cannot be used for measurements to support FCC equipment certification.
 - b) Calibration of SAR system validation dipoles, excluding HAC dipoles.
 - c) Calibration of data acquisition electronics DAE3Vx, DAE4Vx and DAEasyVx.
 - d) For FCC equipment certification purposes, the frequency range of SAR probe and dipole calibrations is limited to 700 MHz - 6 GHz and provided it is supported by the equipment identified in the CTTL QA protocol (a separate attachment to this document).
 - e) The identical system and equipment setup, measurement configurations, hardware, evaluation algorithms, calibration and QA protocols, including the format of calibration certificates and reports used by SPEAG shall be applied by CTTL. Equivalent test equipment and measurement configurations may be considered only when agreed by both SPEAG and the FCC.
 - f) The calibrated items are only applicable to SPEAG DASY 4 and DASY 5 systems or higher version systems that satisfy the requirements of this KDB.
- 3) The SPEAG-CTTL agreement includes specific protocols identified in the following to ensure the quality of calibration services provided by CTTL under this SPEAG-

7. Test Setup Photos

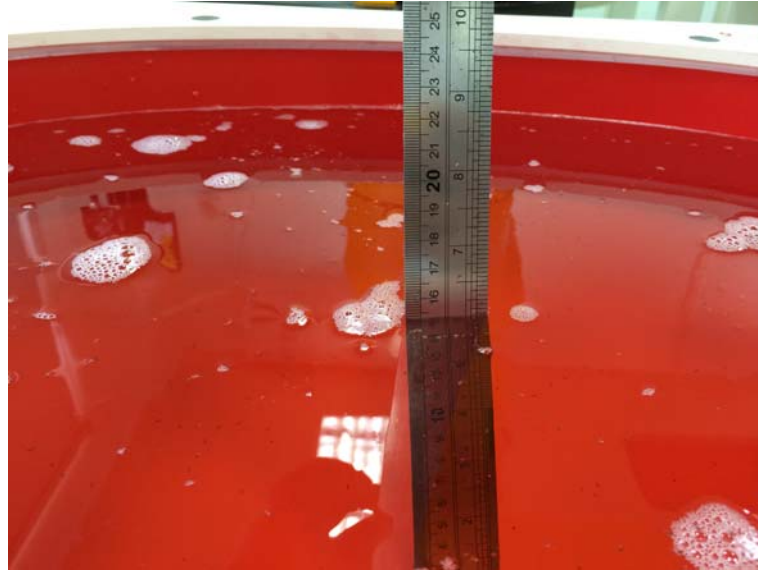

Photograph of the depth in the Head Phantom (150MHz)

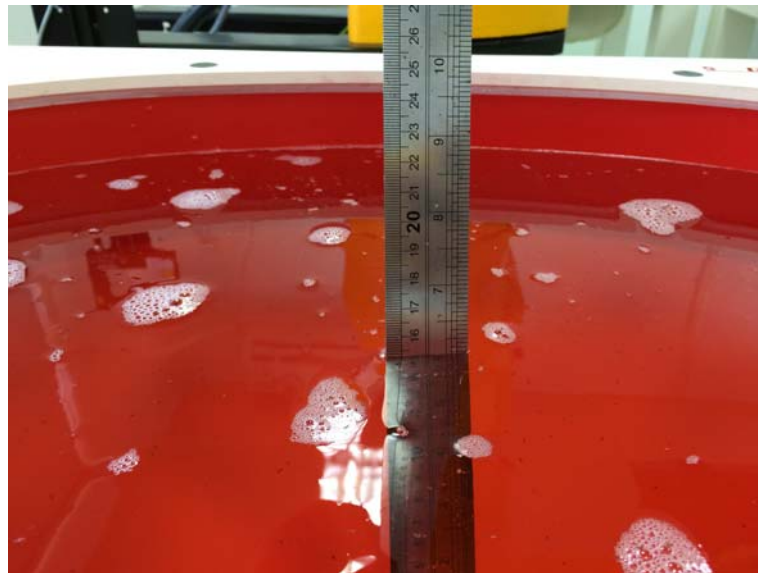

Photograph of the depth in the Body Phantom (150MHz)



Face-held, the front of the EUT towards phantom (The distance was 25mm)

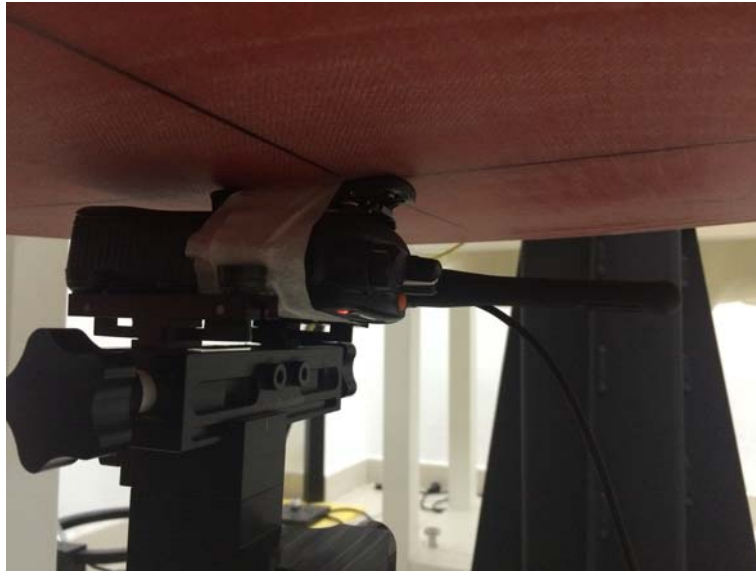

**Body-worn, the front of the EUT towards ground with A1, B1, BC1 and AC1
(The distance was 0mm)**



**Body-worn, the front of the EUT towards ground with A1, B1, BC1 and AC2
(The distance was 0mm)**



**Body-worn, the front of the EUT towards ground with A1, B1, BC1 and AC3
(The distance was 0mm)**



**Body-worn, the front of the EUT towards ground with A1, B1, LA1 and AC1
(The distance was 0mm)**

8. External Photos of the EUT

External Photos



B1- Battery, Intrinsically Safe Li-ion Battery (B00237200)



A1- External Antenna



BC1- Belt clip (SBC00)



AC1- Audio Accessories C-Earset with on-mic PTT (EH0100)



AC2- Audio Accessories - Earpiece with on-mic PTT & transparent acoustic tube (EA0100)



AC3- Audio Accessories - Earbud with on-mic PTT (ES0100)



LA1- Leather carrying (SLCB100)



.....End of Report.....