



FCC Part 15C Test Report

FCC ID: 2ABU6-MS50SF3

Product Name:	BLE module
Trademark:	Minew
Model Name :	MS50SF3, MS50SF4
Prepared For :	SHENZHEN MINEW TECHNOLOGIES CO., LTD
Address :	6th Floor, H Building, Gangzhihong Science Park, Qinglong Road, Longhua District, Shenzhen City, China
Prepared By :	Shenzhen BCTC Technology Co., Ltd.
Address :	No.101, Yousong Road, Longhua New District, Shenzhen, China
Test Date:	May 10 - May 15, 2017
Date of Report :	May 15, 2017
Report No.:	BCTC-LH170501834E



TEST RESULT CERTIFICATION

Applicant's name: SHENZHEN MINEW TECHNOLOGIES CO., LTD

Address: 6th Floor, H Building, Gangzhihong Science Park, Qinglong Road, Longhua District, Shenzhen City, China

Manufacture's Name: SHENZHEN MINEW TECHNOLOGIES CO., LTD

Address: 6th Floor, H Building, Gangzhihong Science Park, Qinglong Road, Longhua District, Shenzhen City, China

Product description

Product name.....: BLE module

Trademark: Minew

Model and/or type reference : MS50SF3, MS50SF4

Standards: FCC Part15.247

Test procedure ANSI C63.10-2013

This device described above has been tested by BCTC, and the test results show that the equipment under test (EUT) is in compliance with the FCC requirements. And it is applicable only to the tested sample identified in the report.

This report shall not be reproduced except in full, without the written approval of BCTC, this document may be altered or revised by BCTC, personal only, and shall be noted in the revision of the document.

Prepared by(Engineer): Snow Zeng

Reviewer(Supervisor): Jade Yang

Approved(Manager): Carson Zhang

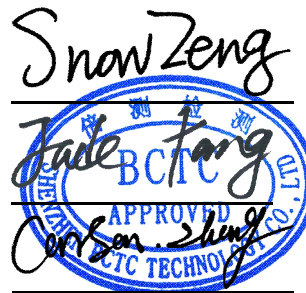

**Table of Contents**

	Page
1 . SUMMARY OF TEST RESULTS	5
1.1 TEST FACILITY	6
1.2 MEASUREMENT UNCERTAINTY	6
2 . GENERAL INFORMATION	7
2.1 GENERAL DESCRIPTION OF EUT	7
2.2 DESCRIPTION OF TEST MODES	8
2.3 BLOCK DIGRAM SHOWING THE CONFIGURATION OF SYSTEM TESTED	9
2.4 DESCRIPTION OF SUPPORT UNITS(CONDUCTED MODE)	9
2.5 EQUIPMENTS LIST FOR ALL TEST ITEMS	10
3 . EMC EMISSION TEST	11
3.1 CONDUCTED EMISSION MEASUREMENT	11
3.1.1 POWER LINE CONDUCTED EMISSION LIMITS	11
3.1.2 TEST PROCEDURE	12
3.1.3 DEVIATION FROM TEST STANDARD	12
3.1.4 TEST SETUP	12
3.1.5 EUT OPERATING CONDITIONS	12
3.1.6 TEST RESULTS	12
3.2 RADIATED EMISSION MEASUREMENT	13
3.2.1 RADIATED EMISSION LIMITS	13
3.2.2 TEST PROCEDURE	14
3.2.3 DEVIATION FROM TEST STANDARD	14
3.2.4 TEST SETUP	15
3.2.5 EUT OPERATING CONDITIONS	16
3.2.6 TEST RESULTS (BETWEEN 9KHZ – 30 MHZ)	17
3.2.7 TEST RESULTS (BETWEEN 30MHZ – 1GHZ)	18
3.2.8 TEST RESULTS (1GHZ~25GHZ)	20
4 . POWER SPECTRAL DENSITY TEST	26
4.1 APPLIED PROCEDURES / LIMIT	26
4.1.1 TEST PROCEDURE	26
4.1.2 DEVIATION FROM STANDARD	26
4.1.3 TEST SETUP	26
4.1.4 EUT OPERATION CONDITIONS	26
4.1.5 TEST RESULTS	27



Table of Contents		Page
5 . BANDWIDTH TEST		29
5.1 APPLIED PROCEDURES / LIMIT		29
5.1.1 TEST PROCEDURE		29
5.1.2 DEVIATION FROM STANDARD		29
5.1.3 TEST SETUP		29
5.1.4 EUT OPERATION CONDITIONS		29
5.1.5 TEST RESULTS		30
6 . PEAK OUTPUT POWER TEST		32
6.1 APPLIED PROCEDURES / LIMIT		32
6.1.1 TEST PROCEDURE		32
6.1.2 DEVIATION FROM STANDARD		32
6.1.3 TEST SETUP		32
6.1.4 EUT OPERATION CONDITIONS		32
6.1.5 TEST RESULTS		33
7 . 100 KHZ BANDWIDTH OF FREQUENCY BAND EDGE		34
7.1 DEVIATION FROM STANDARD		35
7.2 TEST SETUP		35
7.3 EUT OPERATION CONDITIONS		35
7.4 TEST RESULTS		36
8 . ANTENNA REQUIREMENT		37
8.1 STANDARD REQUIREMENT		37
8.2 EUT ANTENNA		37
9 . TEST SEUUP PHOTO		38
10 . EUT PHOTO		40



1. SUMMARY OF TEST RESULTS

Test procedures according to the technical standards:

FCC Part15 (15.247) , Subpart C			
Standard Section	Test Item	Judgment	Remark
15.207	Conducted Emission	N/A	
15.247 (a)(2)	6dB Bandwidth	PASS	
15.247 (b)	Peak Output Power	PASS	
15.247 (c)	Radiated Spurious Emission	PASS	
15.247 (d)	Power Spectral Density	PASS	
15.205	Band Edge Emission	PASS	
15.203	Antenna Requirement	PASS	

NOTE:

(1) "N/A" denotes test is not applicable in this Test Report



1.1 TEST FACILITY

Shenzhen BCTC Technology Co., Ltd.

Add. : No.101, Yousong Road, Longhua New District, Shenzhen, China

FCC Registered No.: 187086

1.2 MEASUREMENT UNCERTAINTY

The reported uncertainty of measurement $y \pm U$, where expanded uncertainty U is based on a standard uncertainty multiplied by a coverage factor of $k=2$, providing a level of confidence of approximately **95 %**.

No.	Item	Uncertainty
1	Conducted Emission Test	$\pm 1.38\text{dB}$
2	RF power, conducted	$\pm 0.16\text{dB}$
3	Spurious emissions, conducted	$\pm 0.21\text{dB}$
4	All emissions, radiated (<1G)	$\pm 4.68\text{dB}$
5	All emissions, radiated (>1G)	$\pm 4.89\text{dB}$
6	Temperature	$\pm 0.5^\circ\text{C}$
7	Humidity	$\pm 2\%$



2. GENERAL INFORMATION

2.1 GENERAL DESCRIPTION OF EUT

Equipment	BLE module	
Trade Name	Minew	
Model Name	MS50SF3, MS50SF4	
Model Difference	The product's different for model number and outlook color.	
Product Description	The EUT is a BLE module	
	Operation Frequency:	2402~2480 MHz
	Modulation Type:	GFSK
	Bit Rate of Transmitter	2Mbps
	Number Of Channel	40 CH
	Antenna type:	PCB antenna
	Antenna Gain (dBi)	-3.74dBi
	Based on the application, features, or specification exhibited in User's Manual, the EUT is considered as an ITE/Computing Device. More details of EUT technical specification, please refer to the User's Manual.	
Channel List	Please refer to the Note 2.	
Power	DC 3V	
hardware version	--	
Software version	--	
Serial number	--	
Connecting I/O Port(s)	Please refer to the User's Manual	

Note:

1. For a more detailed features description, please refer to the manufacturer's specifications or the User's Manual.

2.

Channel List					
Channel	Frequency (MHz)	Channel	Frequency (MHz)	Channel	Frequency (MHz)
01	2402	20	2440		
02	2404	21	2442		
~	~	~	~		
9	2418	39	2478		
10	2420	40	2480		



2.2 DESCRIPTION OF TEST MODES

To investigate the maximum EMI emission characteristics generated from EUT, the test system was pre-scanning tested based on the consideration of following EUT operation mode or test configuration mode which possibly have effect on EMI emission level. Each of these EUT operation mode(s) or test configuration mode(s) mentioned above was evaluated respectively.

Pretest Mode	Description
Mode 1	CH01
Mode 2	CH20
Mode 3	CH40
Mode 4	Link Mode

For Radiated Emission	
Final Test Mode	Description
Mode 1	CH01
Mode 2	CH20
Mode 3	CH40

Note:

- (1) The measurements are performed at the highest, middle, lowest available channels.



2.3 BLOCK DIGRAM SHOWING THE CONFIGURATION OF SYSTEM TESTED

Radiated Spurious Emission Test

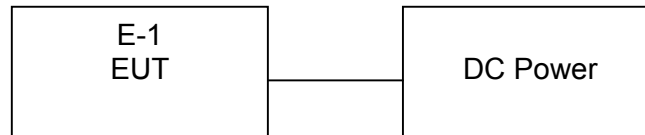

2.4 DESCRIPTION OF SUPPORT UNITS(CONDUCTED MODE)

The EUT has been tested as an independent unit together with other necessary accessories or support units. The following support units or accessories were used to form a representative test configuration during the tests.

Item	Equipment	Mfr/Brand	Model/Type No.	Series No.	Note
E-1	BLE module	N/A	MS50SF3	N/A	EUT

Item	Shielded Type	Ferrite Core	Length	Note

Note:

- (1) The support equipment was authorized by Declaration of Confirmation.
- (2) For detachable type I/O cable should be specified the length in cm in 『Length』 column.



2.5 EQUIPMENTS LIST FOR ALL TEST ITEMS

Radiation test, Band-edge test and 6db bandwidth test equipment

Item	Equipment	Manufacturer	Type No.	Serial No.	Last calibration	Calibrated until
1	Spectrum Analyzer (9kHz-26.5GHz)	Agilent	E4407B	MY45108040	2016.08.27	2017.08.26
2	Test Receiver (9kHz-7GHz)	R&S	ESPI	101318	2016.08.27	2017.08.26
3	Bilog Antenna (30MHz-1GHz)	R&S	VULB 9168	VULB91 68-438	2016.08.27	2017.08.26
4	Horn Antenna (1GHz-18GHz)	SCHWARZBECK	BBHA9120D	1201	2016.09.03	2017.09.03
5	Horn Antenna (14GHz-40GHz)	SCHWARZBECK	BBHA 9170	9170-181	2016.09.03	2017.09.03
6	Amplifier (9KHz-6GHz)	SCHWARZBECK	BBV9744	9744-0037	2016.08.27	2017.08.26
7	Amplifier (1GHz-18GHz)	SCHWARZBECK	BBV9718	9718-309	2016.08.27	2017.08.26
8	Amplifier (18GHz-40GHz)	SCHWARZBECK	BBV 9721	9721-205	2016.08.27	2017.08.26
9	Loop Antenna (9KHz-30MHz)	SCHWARZBECK	FMZB1519B	00014	2016.09.03	2017.09.03
10	RF cables1 (9kHz-1GHz)	R&S	R203	R20X	2016.08.27	2017.08.26
11	RF cables2 (1GHz-40GHz)	R&S	R204	R21X	2016.08.27	2017.08.26
12	Antenna connector	Florida RF Labs	N/A	RF 01#	2016.08.27	2017.08.26
13	Power Metter	ANRITSU	ML2487A	6K00001568	2016.08.27	2017.08.26
14	Power Sensor (AV)	ANRITSU	ML2491A	030989	2016.08.27	2017.08.26
15	Signal Analyzer 9kHz-26.5GHz	Agilent	N9010A	MY48030494	2016.08.27	2017.08.26
16	Test Receiver 20kHz-40GHz	R&S	ESU 40	100376	2016.08.27	2017.08.26
17	D.C. Power Supply	LongWei	PS-305D	010964729	2016.08.27	2017.08.26

Conduction Test equipment

Item	Equipment	Manufacturer	Type No.	Serial No.	Last calibration	Calibrated until
1	Test Receiver	R&S	ESCI	1166.5950K03-1 01165-ha	2016.08.27	2017.08.26
2	LISN	SCHWARZBECK	NSLK8127	8127739	2016.08.27	2017.08.26
3	LISN	R&S	NSLK8126	8126487	2016.08.27	2017.08.26
4	RF cables	R&S	R204	R20X	2016.08.27	2017.08.26
5	Attenuator	R&S	ESH3-Z2	143206	2016.08.27	2017.08.26



3. EMC EMISSION TEST

3.1 CONDUCTED EMISSION MEASUREMENT

3.1.1 POWER LINE CONDUCTED EMISSION Limits (Frequency Range 150KHz-30MHz)

FREQUENCY (MHz)	Limit (dBuV)		Standard
	Quasi-peak	Average	
0.15 -0.5	66 - 56 *	56 - 46 *	FCC
0.50 -5.0	56.00	46.00	FCC
5.0 -30.0	60.00	50.00	FCC

Note:

- (1) The tighter limit applies at the band edges.
- (2) The limit of " * " marked band means the limitation decreases linearly with the logarithm of the frequency in the range.

The following table is the setting of the receiver

Receiver Parameters	Setting
Attenuation	10 dB
Start Frequency	0.15 MHz
Stop Frequency	30 MHz
IF Bandwidth	9 kHz

3.1.2 TEST PROCEDURE

- The EUT was placed 0.8 meters from the horizontal ground plane with EUT being connected to the power mains through a line impedance stabilization network (LISN). All other support equipments powered from additional LISN(s). The LISN provide 50 Ohm/ 50uH of coupling impedance for the measuring instrument.
- Interconnecting cables that hang closer than 40 cm to the ground plane shall be folded back and forth in the center forming a bundle 30 to 40 cm long.
- I/O cables that are not connected to a peripheral shall be bundled in the center. The end of the cable may be terminated, if required, using the correct terminating impedance. The overall length shall not exceed 1 m.
- LISN at least 80 cm from nearest part of EUT chassis.
- For the actual test configuration, please refer to the related Item –EUT Test Photos.

3.1.3 DEVIATION FROM TEST STANDARD

No deviation

3.1.4 TEST SETUP

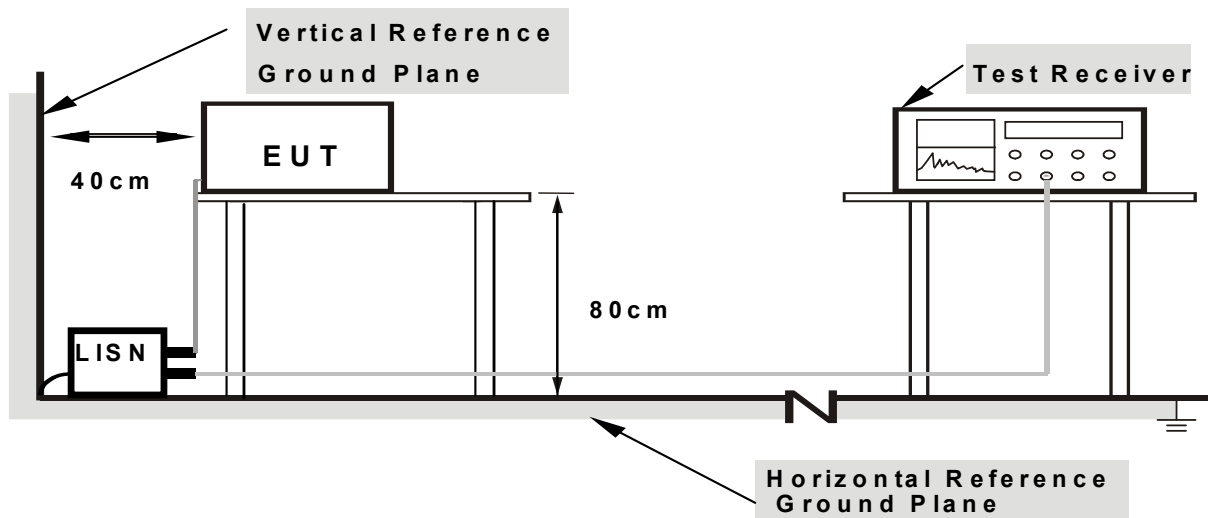

Note: 1.Support units were connected to second LISN .

2.Both of LISNs (AMN) are 80 cm from EUT and at least 80 from other units and other metal planes

3.1.5 EUT OPERATING CONDITIONS

The EUT was configured for testing in a typical fashion (as a customer would normally use it). The EUT has been programmed to continuously transmit during test. This operating condition was tested and used to collect the included data.

3.1.6 TEST RESULTS



3.2 RADIATED EMISSION MEASUREMENT

3.2.1 RADIATED EMISSION LIMITS (Frequency Range 9kHz-1000MHz)

In case the emission fall within the restricted band specified on 15.205(a), then the 15.209(a) limit in the table below has to be followed.

Frequencies (MHz)	Field Strength (micorvolts/meter)	Measurement Distance (meters)
0.009~0.490	2400/F(KHz)	300
0.490~1.705	24000/F(KHz)	30
1.705~30.0	30	30
30~88	100	3
88~216	150	3
216~960	200	3
Above 960	500	3

LIMITS OF RADIATED EMISSION MEASUREMENT (Above 1000MHz)

FREQUENCY (MHz)	Limit (dBuV/m) (at 3M)	
	PEAK	AVERAGE
Above 1000	74	54

Notes:

- (1) The limit for radiated test was performed according to FCC PART 15C.
- (2) The tighter limit applies at the band edges.
- (3) Emission level (dBuV/m)=20log Emission level (uV/m).

Spectrum Parameter	Setting
Attenuation	Auto
Start Frequency	1000 MHz
Stop Frequency	25GHz
RB / VB (emission in restricted band)	1 MHz / 1 MHz for Peak, 1 MHz / 10Hz for Average

Receiver Parameter	Setting
Attenuation	Auto
Start ~ Stop Frequency	9kHz~150kHz / RB 200Hz for QP
Start ~ Stop Frequency	150kHz~30MHz / RB 9kHz for QP
Start ~ Stop Frequency	30MHz~1000MHz / RB 120kHz for QP



3.2.2 TEST PROCEDURE

- a. The measuring distance of at 3 m shall be used for measurements at frequency up to 1GHz. For frequencies above 1GHz, any suitable measuring distance may be used.
- b. The EUT was placed on the top of a rotating table 0.8 meters above the ground at a 3 meter open area test site. The table was rotated 360 degrees to determine the position of the highest radiation.
- c. The height of the equipment or of the substitution antenna shall be 0.8 m; the height of the test antenna shall vary between 1 m to 4 m. Both horizontal and vertical polarizations of the antenna are set to make the measurement.
- d. The initial step in collecting conducted emission data is a spectrum analyzer peak detector mode pre-scanning the measurement frequency range. Significant peaks are then marked and then Quasi Peak detector mode re-measured.
- e. If the Peak Mode measured value compliance with and lower than Quasi Peak Mode Limit, the EUT shall be deemed to meet QP Limits and then no additional QP Mode measurement performed.
- f. For the actual test configuration, please refer to the related Item –EUT Test Photos.

Note:

Both horizontal and vertical antenna polarities were tested and performed pretest to three orthogonal axis. The worst case emissions were reported

3.2.3 DEVIATION FROM TEST STANDARD

No deviation

3.2.4 TEST SETUP

(A) Radiated Emission Test-Up Frequency Below 30MHz

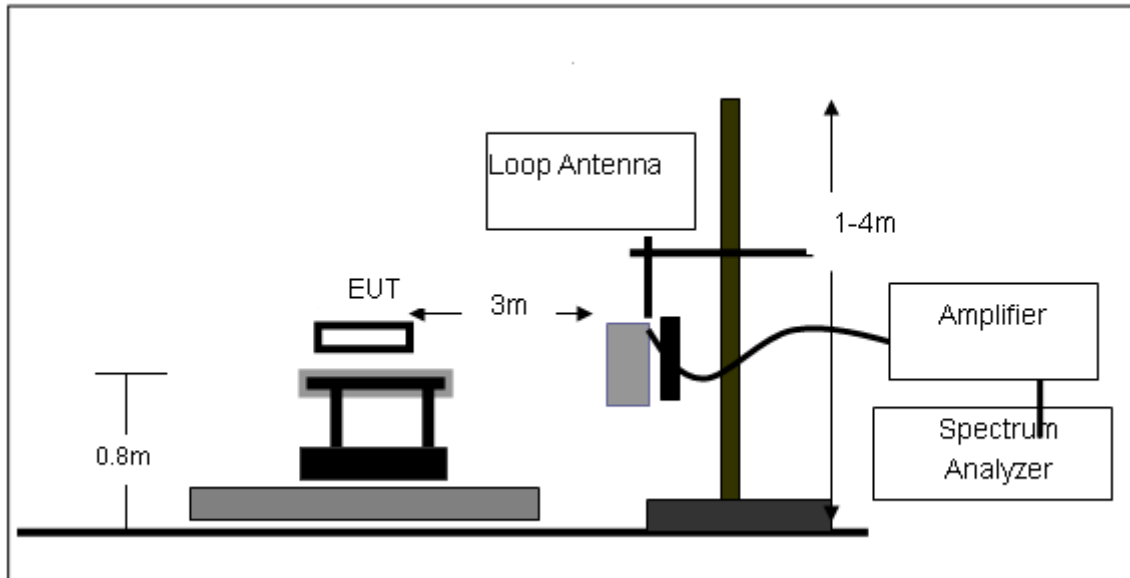

(B) Radiated Emission Test-Up Frequency 30MHz~1GHz

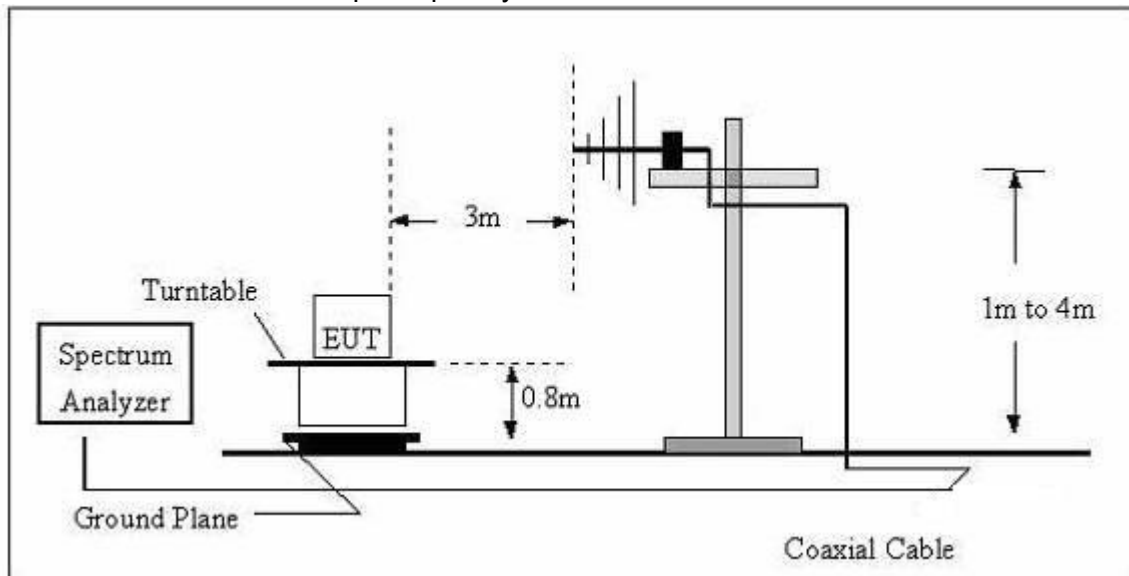

(C) Radiated Emission Test-Up Frequency Above 1GHz

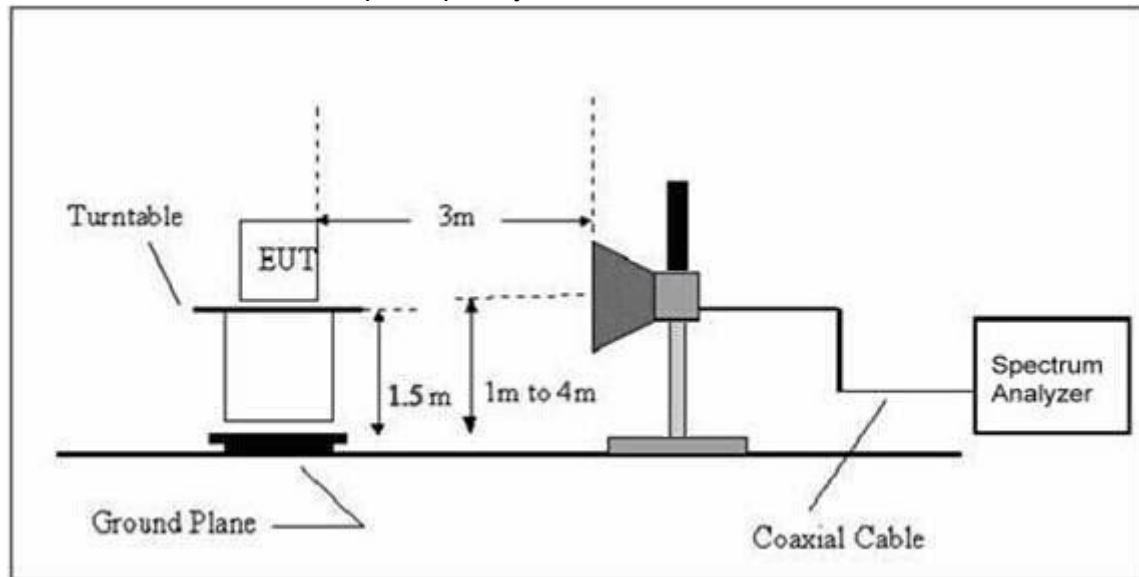

3.2.5 EUT OPERATING CONDITIONS

The EUT tested system was configured as the statements of 2.4 Unless otherwise a special operating condition is specified in the follows during the testing.

**3.2.6 TEST RESULTS (BETWEEN 9KHZ – 30 MHZ)**

Temperature:	20°C	Relative Humidity:	48%
Pressure:	1010 hPa	Test Voltage :	DC 3.0V
Test Mode :	Mode 4	Polarization :	--

Freq. (MHz)	Reading (dBuV/m)	Limit (dBuV/m)	Margin (dB)	State P/F
--	--	--	--	PASS
--	--	--	--	PASS

NOTE:

The amplitude of spurious emissions which are attenuated by more than 20dB below the permissible value has no need to be reported.

Distance extrapolation factor = $40 \log (\text{specific distance}/\text{test distance})(\text{dB})$;

Limit line = specific limits(dBuv) + distance extrapolation factor.



3.2.7 TEST RESULTS (BETWEEN 30MHZ – 1GHZ)

Temperature :	26°C	Relative Humidity :	54%
Pressure :	1010 hPa	Polarization :	Horizontal
Test Voltage :	DC 3.0V		
Test Mode :	Mode 4		

No.	Mk.	Freq.	Reading Level	Correct Factor	Measurement	Limit	Over	Antenna Height	Table Degree	
		MHz	dBuV	dB/m	dBuV/m	dBuV/m	dB	cm	degree	Comment
1	*	61.5618	37.13	-11.83	25.30	40.00	-14.70	QP		
2		118.1862	27.31	-14.88	12.43	43.50	-31.07	QP		
3		193.7728	27.27	-15.81	11.46	43.50	-32.04	QP		
4		315.4808	41.68	-12.18	29.50	46.00	-16.50	QP		
5		537.5891	26.26	-7.45	18.81	46.00	-27.19	QP		
6		793.3960	22.58	-2.62	19.96	46.00	-26.04	QP		

Remark:

Factor = Antenna Factor + Cable Loss – Pre-amplifier.

All interfaces was connected, and BT TX mode was link.

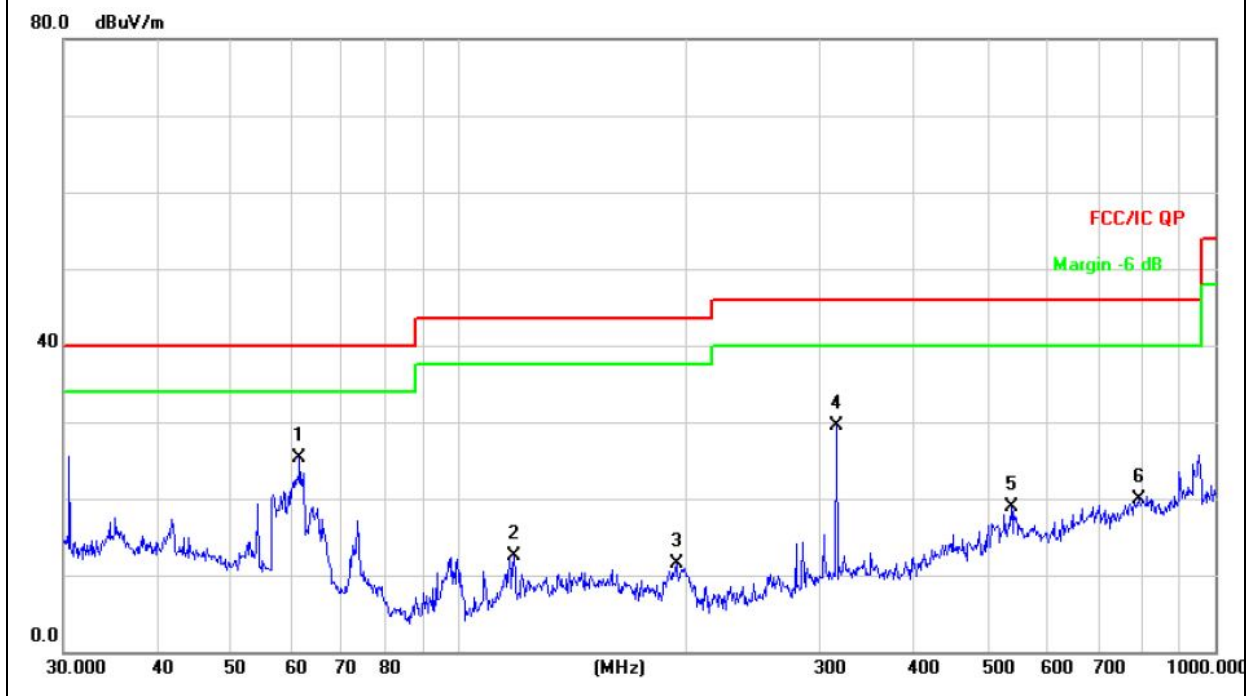



Temperature :	26°C	Relative Humidity :	54%
Pressure :	1010 hPa	Polarization :	Vertical
Test Voltage :	DC 3.0V		
Test Mode :	Mode 4		

No.	Mk.	Freq.	Reading Level	Correct Factor	Measurement	Limit	Over	Antenna Height	Table Degree	
		MHz	dBuV	dB/m	dBuV/m	dBuV/m	dB	cm	degree	Comment
1		53.8818	28.99	-10.93	18.06	40.00	-21.94	QP		
2		65.3432	29.42	-12.66	16.76	40.00	-23.24	QP		
3		159.7844	23.74	-12.87	10.87	43.50	-32.63	QP		
4		279.0436	35.27	-13.13	22.14	46.00	-23.86	QP		
5		672.8444	22.91	-4.80	18.11	46.00	-27.89	QP		
6	*	935.5463	28.05	-0.78	27.27	46.00	-18.73	QP		

Remark:

Factor = Antenna Factor + Cable Loss – Pre-amplifier.

All interfaces was connected, and BT TX mode was link.

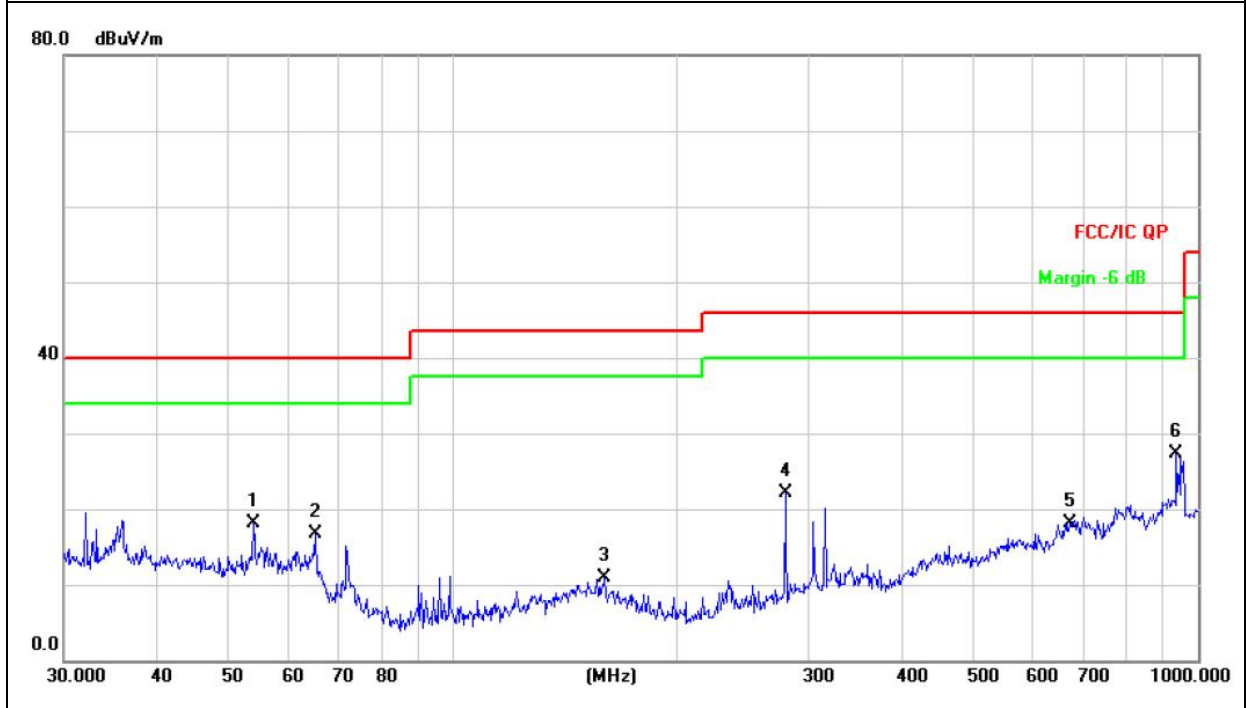



3.2.8 TEST RESULTS (1GHZ~25GHZ)

Polar (H/V)	Frequency	Meter Reading	Pre-amplifier	Cable Loss	Antenna Factor	Emission Level	Limits	Margin	Detector Type
	(MHz)	(dBuV)	(dB)	(dB)	(dB/m)	(dBuV/m)	(dBuV/m)	(dB)	
operation frequency:2402									
V	4804.00	61.84	38.06	7.78	23.25	54.81	74.00	-19.19	PK
V	4804.00	46.61	38.06	7.78	23.25	39.58	54.00	-14.42	AV
V	7206.00	60.27	38.45	8.13	23.71	53.66	74.00	-20.34	PK
V	7206.00	44.33	38.45	8.13	23.71	37.72	54.00	-16.28	AV
V	16132.00	54.39	38.75	10.36	26.57	52.57	74.00	-21.43	PK
H	4804.00	62.03	38.06	7.78	23.25	55.00	74.00	-19.00	PK
H	4804.00	46.45	38.06	7.78	23.25	39.42	54.00	-14.58	AV
H	7206.00	60.49	38.45	8.13	23.71	53.88	74.00	-20.12	PK
H	7206.00	43.35	38.45	8.13	23.71	36.74	54.00	-17.26	AV
H	16132.00	53.50	38.75	10.36	26.57	51.68	74.00	-22.32	PK
operation frequency:2441									
V	4882.00	62.10	38.11	7.82	23.61	55.42	74.00	-18.58	PK
V	4882.00	46.10	38.11	7.82	23.61	39.42	54.00	-14.58	AV
V	7323.00	60.12	38.51	8.28	23.96	53.85	74.00	-20.15	PK
V	7323.00	43.98	38.51	8.28	23.93	37.68	54.00	-16.32	AV
V	16132.00	54.43	38.75	10.36	26.57	52.61	74.00	-21.39	PK
H	4882.00	62.29	38.11	7.82	23.61	55.61	74.00	-18.39	PK
H	4882.00	46.42	38.11	7.82	23.61	39.74	54.00	-14.26	AV
H	7323.00	60.21	38.51	8.28	23.96	53.94	74.00	-20.06	PK
H	7323.00	43.25	38.51	8.28	23.93	36.95	54.00	-17.05	AV
H	16132.00	53.54	38.75	10.36	26.57	51.72	74.00	-22.28	PK
operation frequency:2480									
V	4960.00	62.87	38.26	7.96	23.83	56.40	74.00	-17.60	PK
V	4960.00	46.74	38.26	7.96	23.83	40.27	54.00	-13.73	AV
V	7440.00	59.90	38.72	8.31	24.03	53.52	74.00	-20.48	PK
V	7440.00	43.86	38.72	8.31	24.03	37.48	54.00	-16.52	AV
V	16132.00	54.42	38.75	10.36	26.57	52.60	74.00	-21.40	PK
H	2480.00	63.06	38.26	7.96	23.83	56.59	74.00	-17.41	PK
H	2480.00	46.65	38.26	7.96	23.83	40.18	54.00	-13.82	AV
H	4960.00	61.54	38.72	8.31	24.03	55.16	74.00	-18.84	PK
H	4960.00	43.71	38.72	8.31	24.03	37.33	54.00	-16.67	AV
H	16132.00	53.44	38.75	10.36	26.57	51.62	74.00	-22.38	PK

Remark:

1. Emission Level = Meter Reading + Antenna Factor + Cable Loss – Pre-amplifier, Margin= Emission Level - Limit
2. If peak below the average limit, the average emission was no test.
3. The amplitude of spurious emissions which are attenuated by more than 20dB below the permissible value has no need to be reported.



For conducted
2402MHz

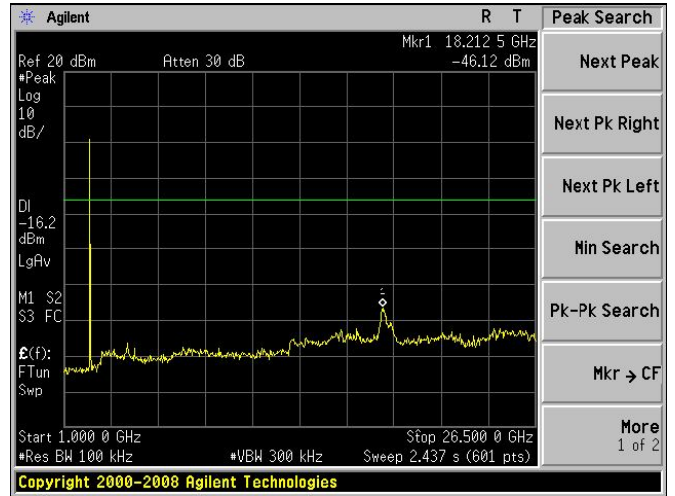
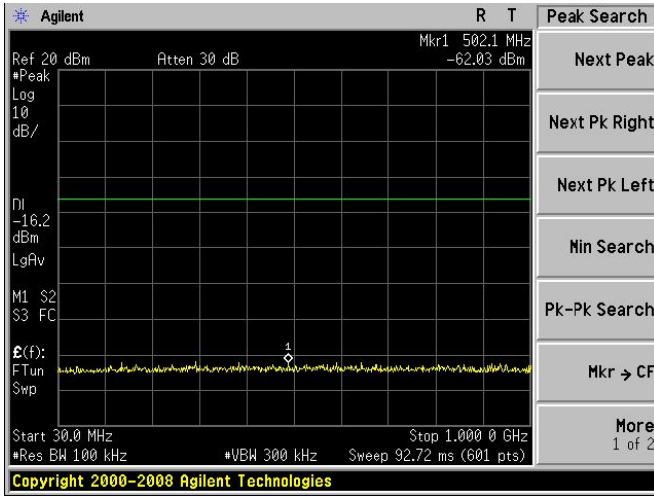

2440MHz

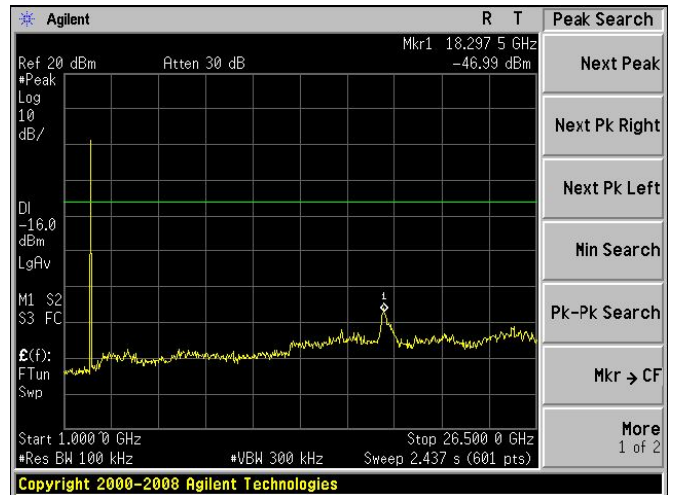
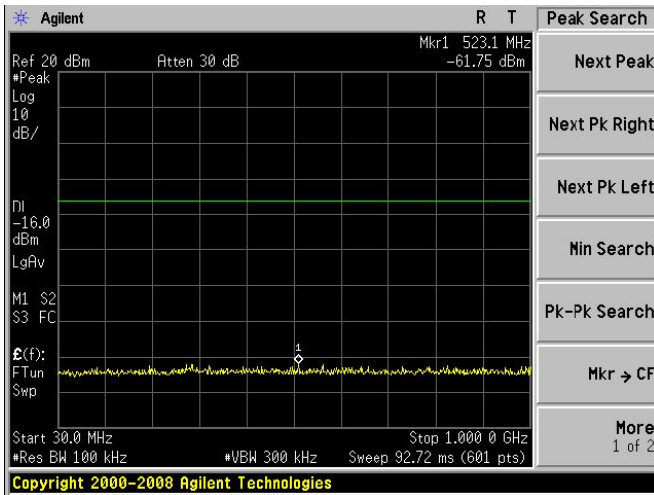

2480MHz

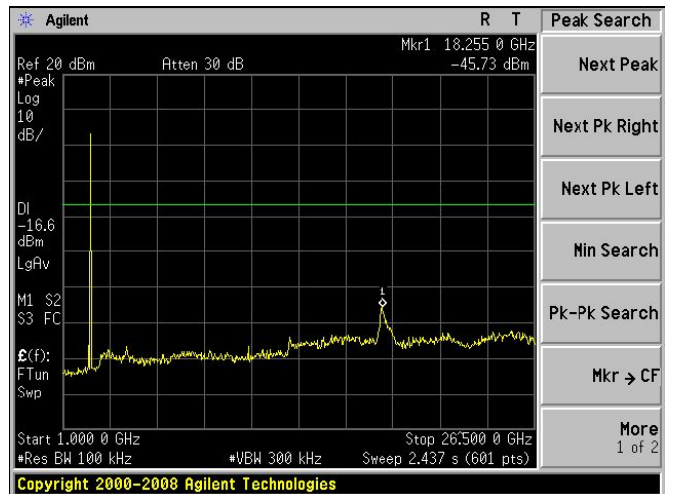
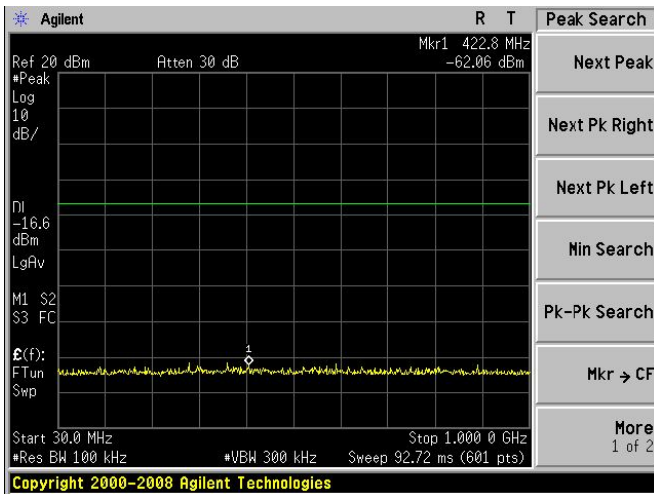



3.3 RADIATED BAND EMISSION MEASUREMENT

3.3.1 TEST REQUIREMENT:

FCC Part15 C Section 15.209 and 15.205

LIMITS OF RADIATED EMISSION MEASUREMENT (Above 1000MHz)

FREQUENCY (MHz)	Limit (dBuV/m) (at 3M)	
	PEAK	AVERAGE
Above 1000	74	54

Notes:

- (1) The limit for radiated test was performed according to FCC PART 15C.
- (2) The tighter limit applies at the band edges.
- (3) Emission level (dBuV/m)=20log Emission level (uV/m).

Spectrum Parameter	Setting
Attenuation	Auto
Start Frequency	2300MHz
Stop Frequency	2520
RB / VB (emission in restricted band)	1 MHz / 1 MHz for Peak, 1 MHz / 10Hz for Average

3.3.2 TEST PROCEDURE

Above 1GHz test procedure as below:

- a. 1. The EUT was placed on the top of a rotating table 1.5 meters above the ground at a 3 meter camber. The table was rotated 360 degrees to determine the position of the highest radiation.
- b. The EUT was set 3 meters away from the interference-receiving antenna, which was mounted on the top of a variable-height antenna tower.
- c. The antenna height is varied from one meter to four meters above the ground to determine the maximum value of the field strength. Both horizontal and vertical polarizations of the antenna are set to make the measurement.
- d. For each suspected emission, the EUT was arranged to its worst case and then the antenna was tuned to heights from 1 meter to 4 meters and the rota table was turned from 0 degrees to 360 degrees to find the maximum reading.
- e. The test-receiver system was set to Peak Detect Function and Specified Bandwidth with Maximum Hold Mode.
- f. If the emission level of the EUT in peak mode was 10dB lower than the limit specified, then testing could be stopped and the peak values of the EUT would be reported. Otherwise the emissions that did not have 10dB margin would be re-tested one by one using peak, quasi-peak or average method as specified and then reported in a data sheet.
- g. Test the EUT in the lowest channel,the Highest channel

Note:

Both horizontal and vertical antenna polarities were tested and performed pretest to three orthogonal axis. The worst case emissions were reported

3.3.3 DEVIATION FROM TEST STANDARD

No deviation

3.3.4 TEST SETUP

Radiated Emission Test-Up Frequency Above 1GHz

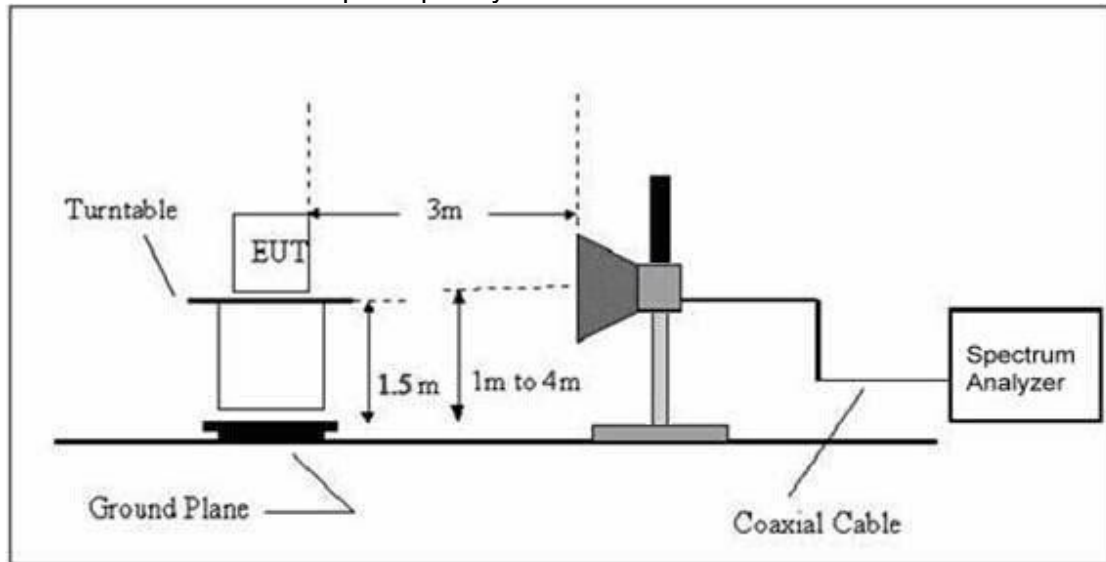

3.3.5 EUT OPERATING CONDITIONS

The EUT tested system was configured as the statements of 2.3 Unless otherwise a special operating condition is specified in the follows during the testing.
The plot only show the Horizontal's average data.



3.3.6 TEST RESULT

Polar (H/V)	Frequency	Meter Reading	Pre-amplifier	Cable Loss	Antenna Factor	Emission evel	Limits	Margin	Detector Type
	(MHz)	(dBuV)	(dB)	(dB)	(dB/m)	(dBuV/m)	(dBuV/m)	(dB)	
operation frequency:2402									
V	2390.00	65.64	38.06	7.42	20.15	55.15	74.00	-18.85	PK
V	2390.00	54.51	38.06	7.42	20.15	44.02	54.00	-9.98	AV
V	2400.00	65.84	38.06	7.42	20.15	55.35	74.00	-18.65	PK
V	2400.00	54.11	38.06	7.42	20.15	43.62	54.00	-10.38	AV
H	2390.00	65.92	38.06	7.42	20.15	55.43	74.00	-18.57	PK
H	2390.00	54.54	38.06	7.42	20.15	44.05	54.00	-9.95	AV
H	2400.00	65.79	38.06	7.42	20.15	55.30	74.00	-18.70	PK
H	2400.00	54.48	38.06	7.42	20.15	43.99	54.00	-10.01	AV

Remark:

1. Emission Level = Meter Reading + Factor, Margin= Emission Level - Limit
2. If peak below the average limit, the average emission was no test.
3. The amplitude of spurious emissions which are attenuated by more than 20dB below the permissible value has no need to be reported.

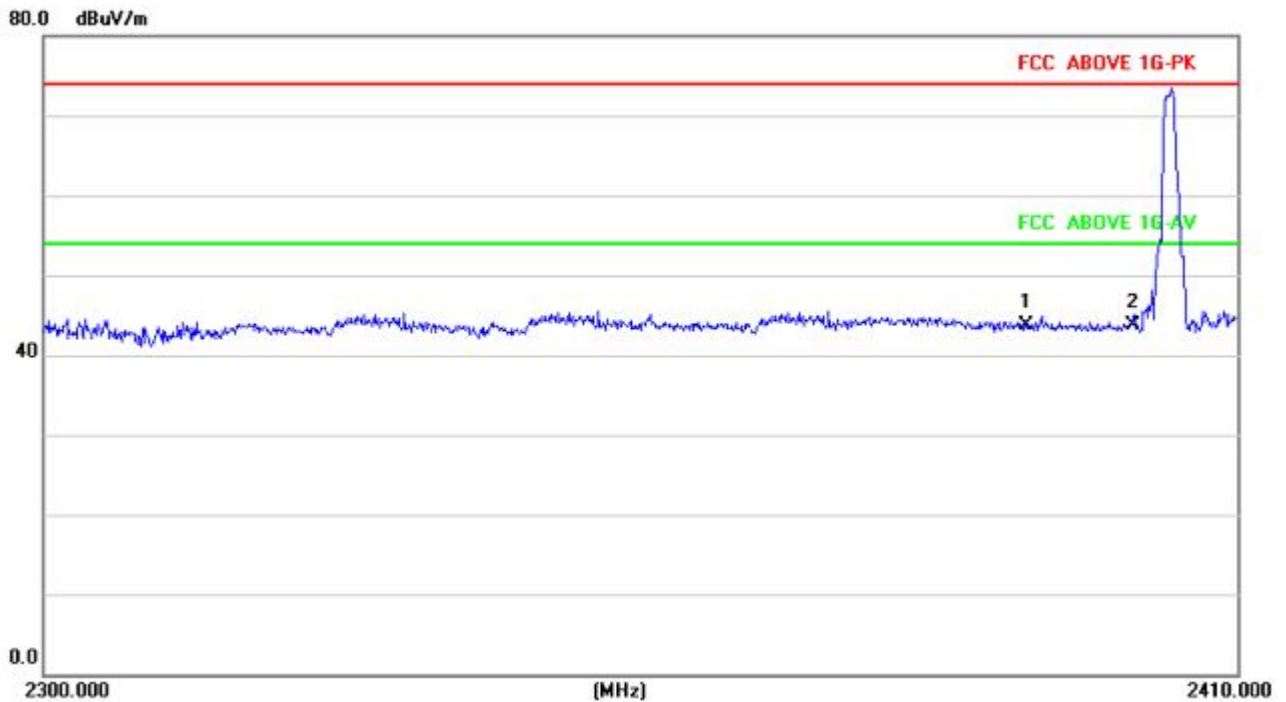



Polar (H/V)	Frequency	Meter Reading	Pre-amplifier	Cable Loss	Antenna Factor	Emission Level	Limits	Margin	Detector Type
	(MHz)	(dBuV)	(dB)	(dB)	(dB/m)	(dBuV/m)	(dBuV/m)	(dB)	
operation frequency:2480									
V	2483.50	65.84	38.17	7.42	20.51	55.60	74.00	-18.40	PK
V	2483.50	54.75	38.17	7.42	20.51	44.51	54.00	-9.49	AV
V	2500.00	65.78	38.20	7.45	20.54	55.57	74.00	-18.43	PK
V	2500.00	54.22	38.20	7.45	20.54	44.01	54.00	-9.99	AV
H	2483.50	65.96	38.17	7.42	20.51	55.72	74.00	-18.28	PK
H	2483.50	54.79	38.17	7.42	20.51	44.55	54.00	-9.45	AV
H	2500.00	65.59	38.20	7.45	20.54	55.38	74.00	-18.62	PK
H	2500.00	55.05	38.20	7.45	20.54	44.84	54.00	-9.16	AV

Remark:

1. Emission Level = Meter Reading + Factor, Margin= Emission Level - Limit
2. If peak below the average limit, the average emission was no test.
3. The amplitude of spurious emissions which are attenuated by more than 20dB below the permissible value has no need to be reported.

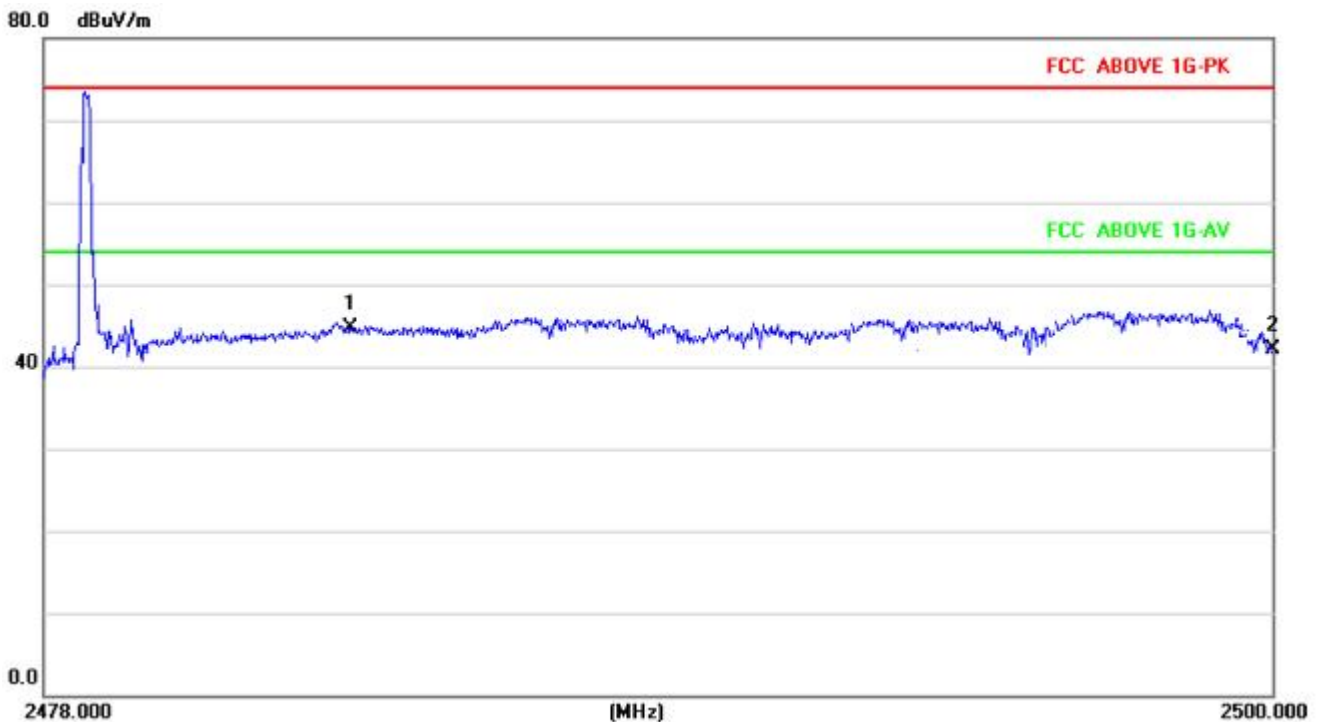

4. POWER SPECTRAL DENSITY TEST

4.1 APPLIED PROCEDURES / LIMIT

FCC Part15 (15.247) , Subpart C				
Section	Test Item	Limit	Frequency Range (MHz)	Result
15.247	Power Spectral Density	8 dBm (in any 3KHz)	2400-2483.5	PASS

4.1.1 TEST PROCEDURE

1. Set analyzer center frequency to DTS channel center frequency.
2. Set the span to 1.5 times the DTS bandwidth.
3. Set the RBW to: $3 \text{ kHz} \leq \text{RBW} \leq 100 \text{ kHz}$.
4. Set the VBW $\geq 3 \times \text{RBW}$.
5. Detector = peak.
6. Sweep time = auto couple.
7. Trace mode = max hold.
8. Allow trace to fully stabilize.
9. Use the peak marker function to determine the maximum amplitude level within the RBW.
10. If measured value exceeds limit, reduce RBW (no less than 3 kHz) and repeat.

4.1.2 DEVIATION FROM STANDARD

No deviation.

4.1.3 TEST SETUP

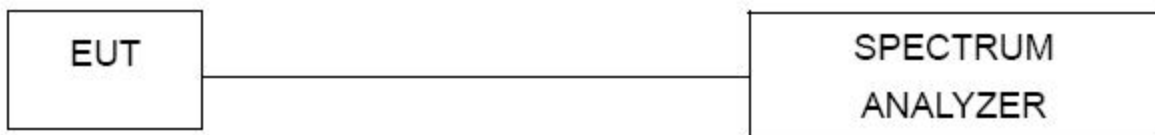

4.1.4 EUT OPERATION CONDITIONS

The EUT tested system was configured as the statements of 2.1 Unless otherwise a special operating condition is specified in the follows during the testing.



4.1.5 TEST RESULTS

Temperature :	25°C	Relative Humidity :	60%
Pressure :	1015 hPa	Test Voltage :	DC 3.0V
Test Mode :	TX Mode /CH01, CH20, CH40		

Frequency	Reading (dBm)	Cable Loss (dB)	Power Density (dBm)	Limit (dBm)	Result
2402 MHz	-12.73	0.5	-12.23	<8	PASS
2440 MHz	-12.68	0.5	-12.18	<8	PASS
2480 MHz	-13.41	0.5	-12.91	<8	PASS

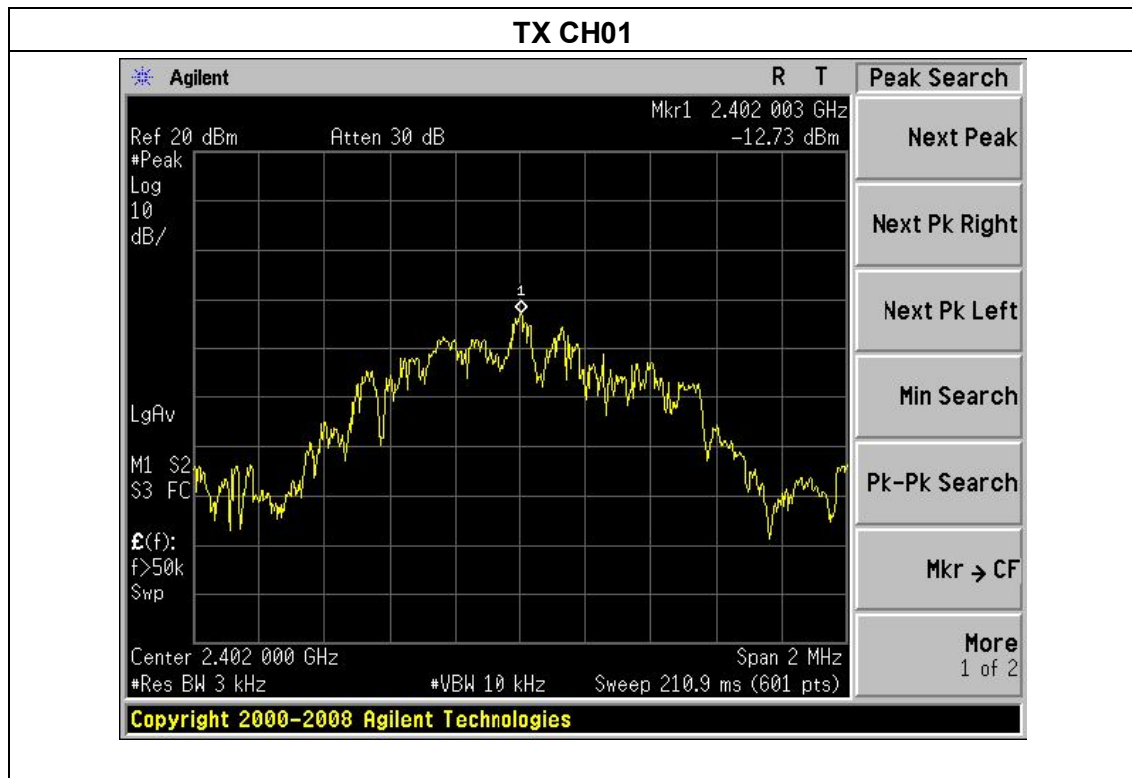

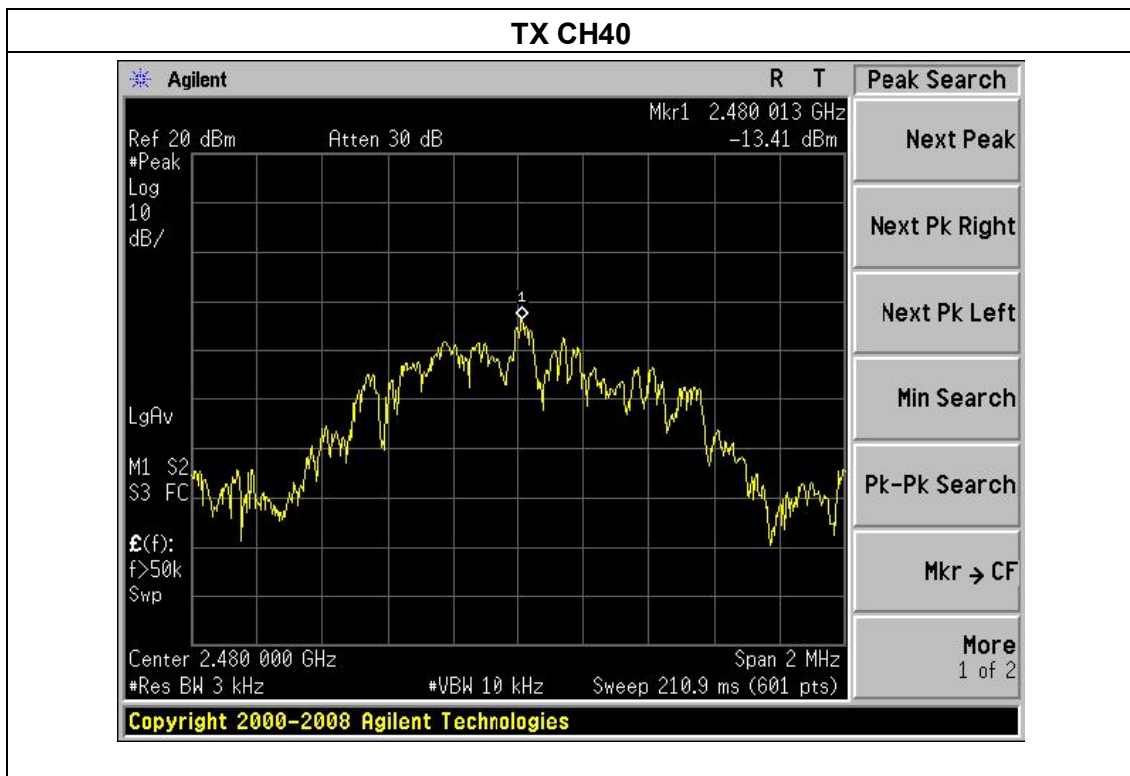
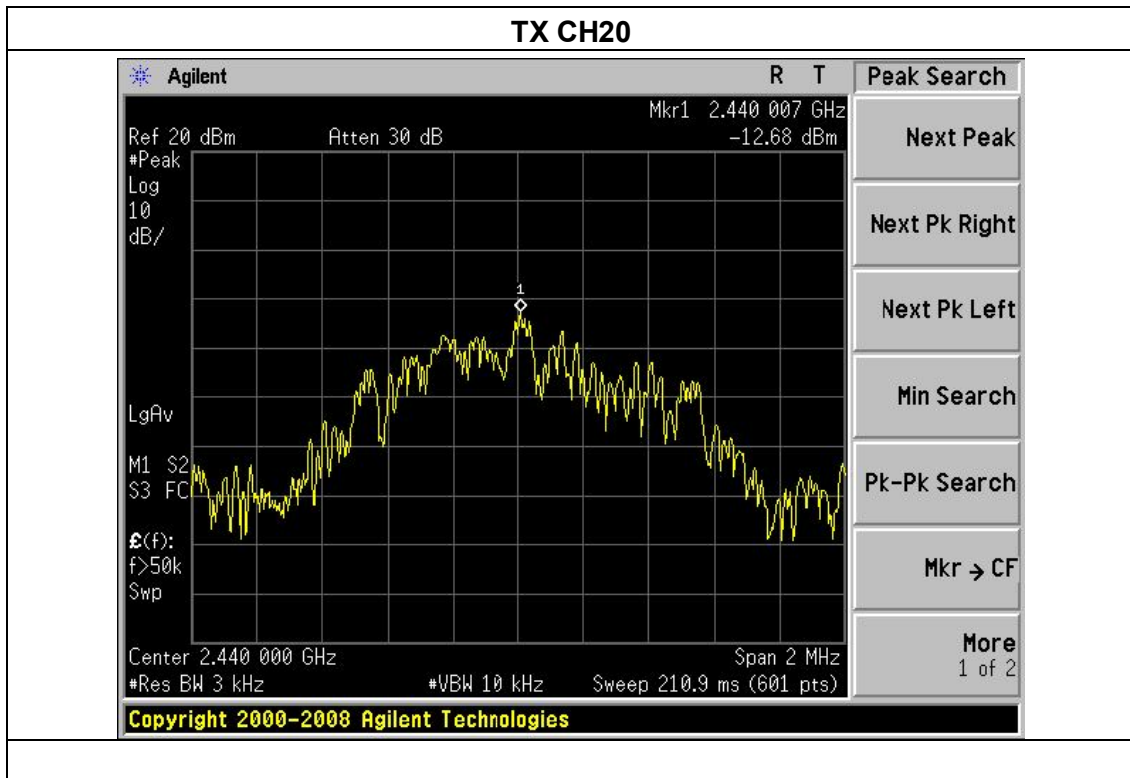

5. BANDWIDTH TEST

5.1 APPLIED PROCEDURES / LIMIT

FCC Part15 (15.247) , Subpart C				
Section	Test Item	Limit	Frequency Range (MHz)	Result
15.247(a)(2)	Bandwidth	$\geq 500\text{KHz}$ (6dB bandwidth)	2400-2483.5	PASS

5.1.1 TEST PROCEDURE

1. Set RBW = 100 kHz.
2. Set the video bandwidth (VBW) $\geq 3 \times$ RBW.
3. Detector = Peak.
4. Trace mode = max hold.
5. Sweep = auto couple.
6. Allow the trace to stabilize.
7. Measure the maximum width of the emission that is constrained by the frequencies associated with the two outermost amplitude points (upper and lower frequencies) that are attenuated by 6 dB relative to the maximum level measured in the fundamental emission.

5.1.2 DEVIATION FROM STANDARD

No deviation.

5.1.3 TEST SETUP



5.1.4 EUT OPERATION CONDITIONS

The EUT tested system was configured as the statements of 2.4 Unless otherwise a special operating condition is specified in the follows during the testing.



5.1.5 TEST RESULTS

Temperature :	25°C	Relative Humidity :	60%
Pressure :	1012 hPa	Test Voltage :	DC 3.0V
Test Mode :	TX Mode /CH01, CH20, CH40		

Channel	Frequency (MHz)	6dB bandwidth (KHz)	Limit (kHz)	Result
Low	2402	512.5	>500	Pass
Middle	2440	509.9	>500	Pass
High	2480	509.3	>500	Pass

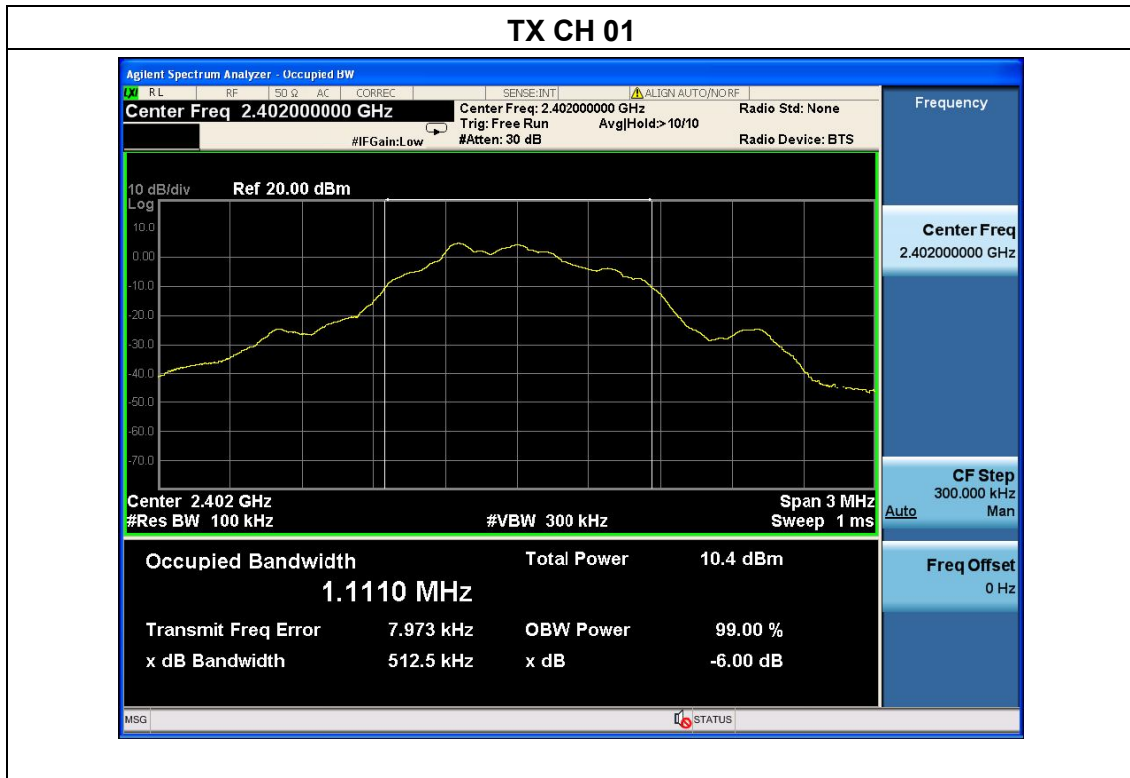



TX CH 20



TX CH 40



6. PEAK OUTPUT POWER TEST

6.1 APPLIED PROCEDURES / LIMIT

FCC Part15 (15.247) , Subpart C				
Section	Test Item	Limit	Frequency Range (MHz)	Result
15.247(b)(3)	Peak Output Power	1 watt or 30dBm	2400-2483.5	PASS

6.1.1 TEST PROCEDURE

- a. The EUT was directly connected to the Power meter

6.1.2 DEVIATION FROM STANDARD

No deviation.

6.1.3 TEST SETUP



6.1.4 EUT OPERATION CONDITIONS

The EUT tested system was configured as the statements of 2.4 Unless otherwise a special operating condition is specified in the follows during the testing.

**6.1.5 TEST RESULTS**

Temperature :	25°C	Relative Humidity :	60%
Pressure :	1012 hPa	Test Voltage :	DC 3.0V
Test Mode :	TX Mode		

TX Mode			
Test Channe	Frequency	Maximum Conducted Output Power(PK)	LIMIT
	(MHz)	(dBm)	dBm
CH01	2402	-0.23	30
CH20	2440	-0.18	30
CH40	2480	-0.21	30



7. BAND EDGE

APPLICABLE STANDARD

In any 100 kHz bandwidth outside the frequency band in which the spread spectrum or digitally modulated intentional radiator is operating, the radio frequency power that is produced by the intentional radiator shall be at least 20 dB below that in the 100 kHz bandwidth within the band that contains the highest level of the desired power, based on either an RF conducted or a radiated measurement, provided the transmitter demonstrates compliance with the peak conducted power limits. If the transmitter complies with the conducted power limits based on the use of RMS averaging over a time interval, as permitted under paragraph (b)(3) of this section, the attenuation required under this paragraph shall be 30 dB instead of 20 dB. Attenuation below the general limits specified in §15.209(a) is not required. In addition, radiated emissions which fall in the restricted bands, as defined in §15.205(a), must also comply with the radiated emission limits specified in §15.209(a) (see §15.205(c)).

TEST PROCEDURE

- a) Check the calibration of the measuring instrument using either an internal calibrator or a known signal from an external generator.
- b) Position the EUT without connection to measurement instrument. Turn on the EUT and connect its antenna terminal to measurement instrument via a low loss cable. Then set it to any one measured frequency within its operating range, and make sure the instrument is operated in its linear range.
- c) Set RBW to 100 kHz and VBW of spectrum analyzer to 300 kHz with a convenient frequency span including 100 kHz bandwidth from band edge.
- d) Measure the highest amplitude appearing on spectral display and set it as a reference level. Plot the graph with marking the highest point and edge frequency.
- e) Repeat above procedures until all measured frequencies were complete.



7.1 DEVIATION FROM STANDARD

No deviation.

7.2 TEST SETUP



7.3 EUT OPERATION CONDITIONS

The EUT tested system was configured as the statements of 2.4 Unless otherwise a special operating condition is specified in the follows during the testing.



7.4 TEST RESULTS

Temperature :	25°C	Relative Humidity :	60%
Pressure :	1012 hPa	Test Voltage :	DC 3.0V

Band Edge, Left Side

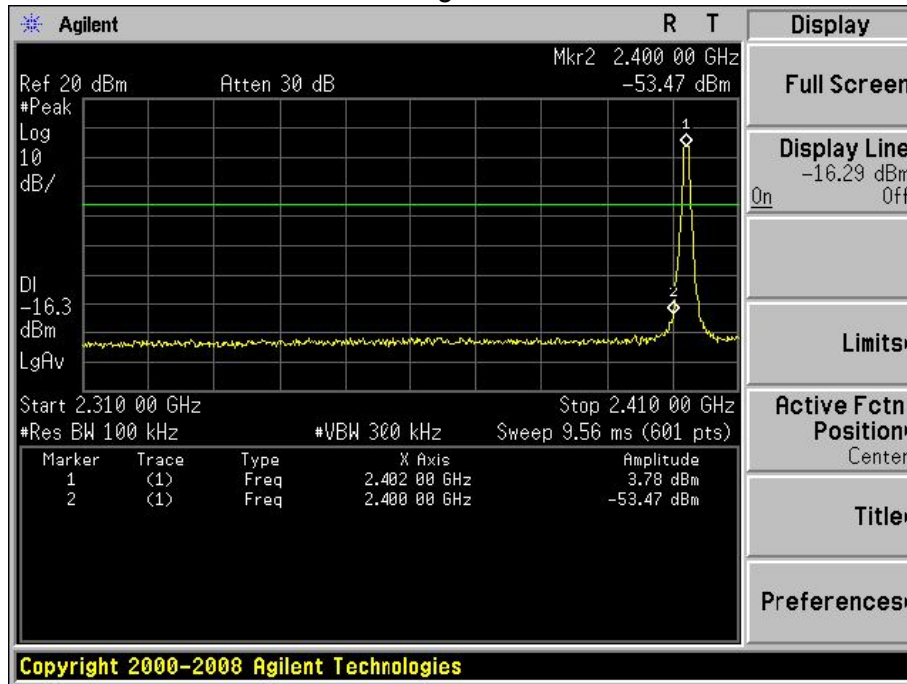

Band Edge, Right Side

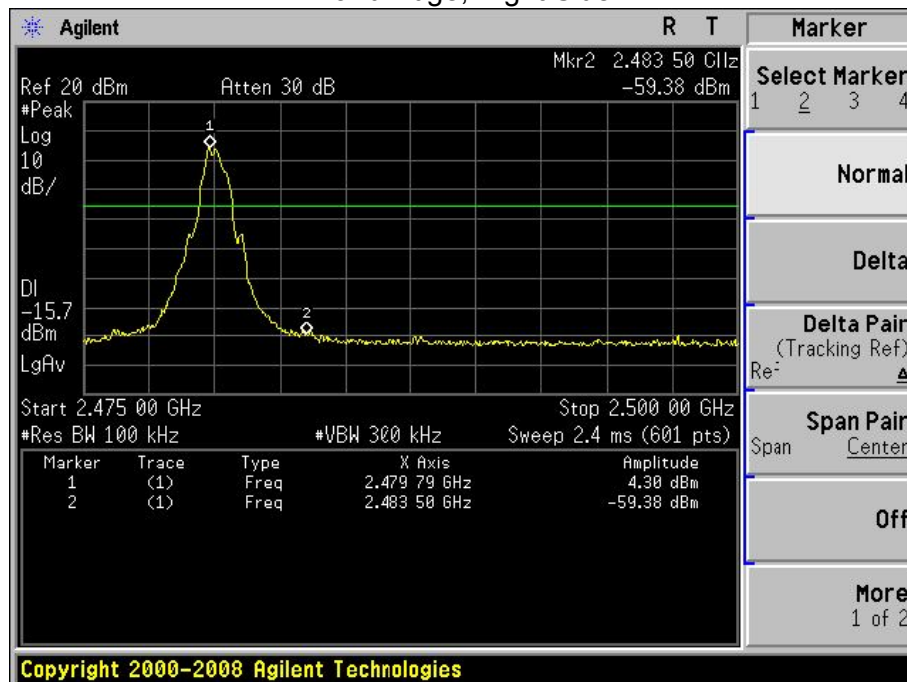



8. ANTENNA REQUIREMENT

8.1 STANDARD REQUIREMENT

15.203 requirement: For intentional device, according to 15.203: an intentional radiator shall be designed to ensure that no antenna other than that furnished by the responsible party shall be used with the device.

8.2 EUT ANTENNA

The EUT antenna is PCB antenna,. It comply with the standard requirement.

9. TEST SEUUP PHOTO

Radiated Emission

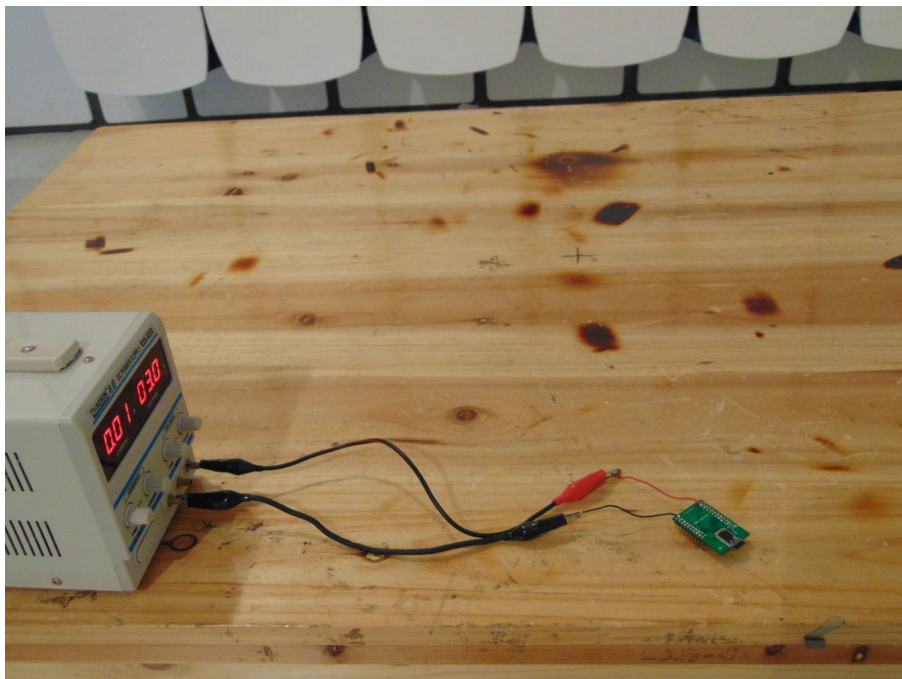

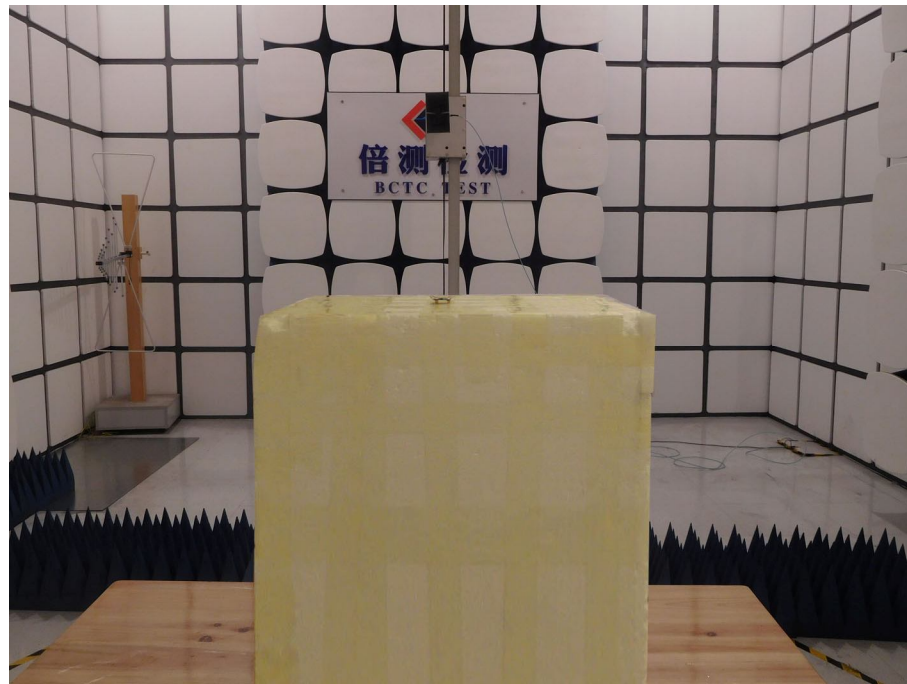

10. EUT PHOTO

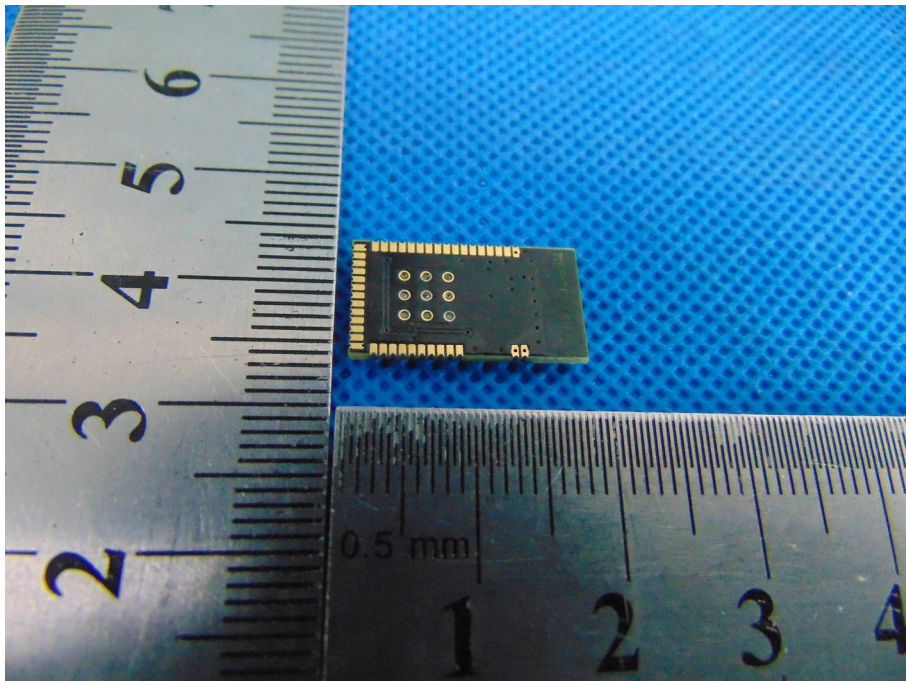
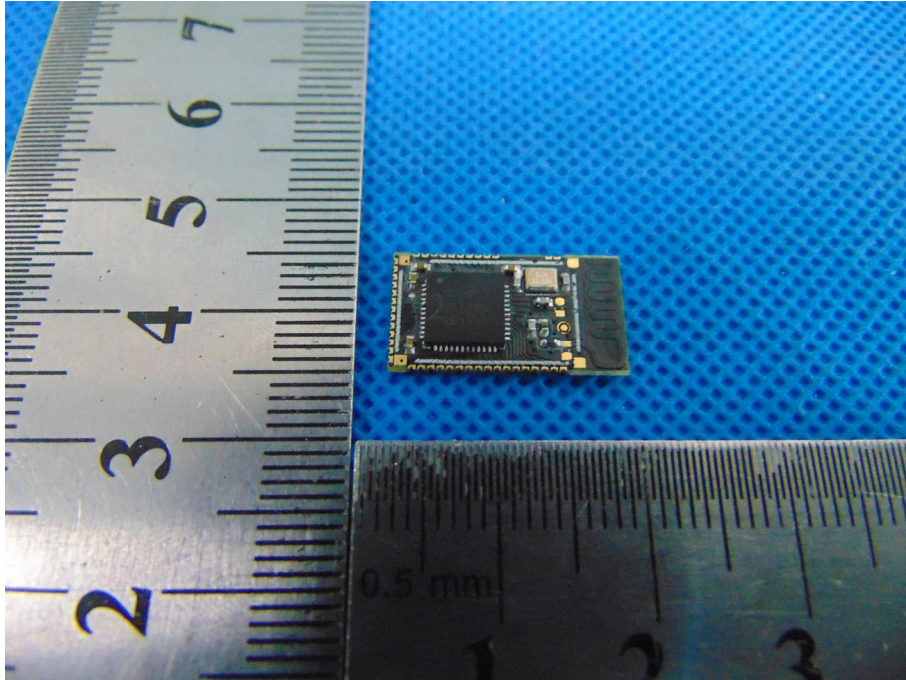

***** END OF REPORT *****