



### FCC PART 15 SUBPART C TEST REPORT

**Report Reference No.**.....: **CTL14112173046-WF**

Compiled by

( position+printed name+signature)...: File administrators Jacky Chen

Name of the organization performing the tests

Test Engineer Tracy Qi

( position+printed name+signature)...:

Approved by

( position+printed name+signature)...: Manager Tracy Qi

Date of issue.....: Dec. 22, 2014

**Test Firm**.....: **Shenzhen CTL Testing Technology Co., Ltd.**

Address.....: Floor 1-A, Baisha Technology Park, No. 3011, Shahexi Road, Nanshan, Shenzhen 518055 China.

**Applicant's name**.....: **Shenzhen Minew Technologies Co.,Ltd.**

Address.....: 5 Floor, H Building, Gangzhilong Science Park, Qinglong Road, Longhua District, Shenzhen City, China

**Test specification:**

Standard .....: **FCC Part 15.249:** Operation within the bands 920-928 MHz, 2400-2483.5 MHz, 5725-5850 MHz and 24.0 - 24.25 GHz

TRF Originator.....: Shenzhen CTL Testing Technology Co., Ltd.

Master TRF.....: Dated 2011-01

**Shenzhen CTL Testing Technology Co., Ltd. All rights reserved.**

This publication may be reproduced in whole or in part for non-commercial purposes as long as the Shenzhen CTL Testing Technology Co., Ltd. is acknowledged as copyright owner and source of the material. Shenzhen CTL Testing Technology Co., Ltd. takes no responsibility for and will not assume liability for damages resulting from the reader's interpretation of the reproduced material due to its placement and context.

**Test item description** ..... : **Digital Broadcasting Device (iBeacon)**

Trade Mark .....: MINEW

Models/Type reference.....: i3 (MS63PX)

Modulation .....: GFSK

Work Frequency.....: 2402 MHz~2480 MHz

Antenna Type.....: internal

FCC ID .....: 2ABU6-I3

Result.....: **Positive**

**TEST REPORT**

<b>Test Report No. :</b>	<b>CTL1412173046-WF</b>	Dec.22, 2014
		Date of issue

Equipment under Test : Digital Broadcasting Device (iBeacon)

Model /Type : i3 (MS63PX)

**Applicant** : **Shenzhen Minew Technologies Co.,Ltd.**

Address : 5 Floor, H Building, Gangzhilong Science Park, Qinglong Road,  
Longhua District, Shenzhen City, China

**Manufacturer** **Shenzhen Minew Technologies Co.,Ltd.**

Address 5 Floor, H Building, Gangzhilong Science Park, Qinglong Road,  
Longhua District, Shenzhen City, China

**Test Result** according to the  
standards on page 4:

**Positive**

The test report merely corresponds to the test sample.  
It is not permitted to copy extracts of these test result without the written permission of the test  
laboratory.

## Contents

<b><u>1.</u></b>	<b><u>TEST STANDARDS .....</u></b>	<b><u>4</u></b>
<b><u>2.</u></b>	<b><u>SUMMARY .....</u></b>	<b><u>5</u></b>
2.1.	General Remarks	5
2.2.	Equipment Under Test	5
2.3.	Short description of the Equipment under Test (EUT)	5
2.4.	EUT operation mode	6
2.5.	EUT configuration	6
2.6.	Related Submittal(s) / Grant (s)	6
2.7.	Modifications	6
<b><u>3.</u></b>	<b><u>TEST ENVIRONMENT .....</u></b>	<b><u>7</u></b>
3.1.	Address of the test laboratory	7
3.2.	Test Facility	7
3.3.	Environmental conditions	7
3.4.	Configuration of Tested System	7
3.5.	Statement of the measurement uncertainty	8
3.6.	Equipments Used during the Test	9
<b><u>4.</u></b>	<b><u>TEST CONDITIONS AND RESULTS .....</u></b>	<b><u>10</u></b>
4.1.	Conducted Emissions Test	10
4.2.	Fundamental Emissions	12
4.3.	Transmitter Radiated Unwanted Emissions	13
4.4.	Band Edge Measurement	29
4.5.	Occupied Bandwidth Measurement	38
<b><u>5.</u></b>	<b><u>ANTENNA REQUIREMENT .....</u></b>	<b><u>40</u></b>
<b><u>6.</u></b>	<b><u>TEST SETUP PHOTOS OF THE EUT .....</u></b>	<b><u>41</u></b>
<b><u>7.</u></b>	<b><u>EXTERNAL AND INTERNAL PHOTOS OF THE EUT .....</u></b>	<b><u>42</u></b>

## 1. TEST STANDARDS

The tests were performed according to following standards:

[FCC Rules Part 15.249](#): Operation within the bands 902 - 928 MHz, 2400 - 2483.5 MHz, 5725 - 5875 MHz, and 24.0 - 24.25 GHz.

[ANSI C63.4-2009](#)



## 2. SUMMARY

### 2.1. General Remarks

Date of receipt of test sample : Dec. 17, 2014

Testing commenced on : Dec. 17, 2014

Testing concluded on : Dec. 22, 2014

### 2.2. Equipment Under Test

#### Power supply system utilised

Power supply voltage :  120V / 60 Hz  115V / 60Hz  
 12 V DC  24 V DC  
 Other (specified in blank below)

DC 3.0V from battery(2\*AA)

### 2.3. Short description of the Equipment under Test (EUT)

The EUT is a Digital Broadcasting Device (iBeacon) work at 2402~2480 MHz support Bluetooth 4.0.  
 Channel List:

Channel	Frequency (MHz)	Channel	Frequency (MHz)
00	2402	20	2442
01	2404	21	2444
02	2406	22	2446
03	2408	23	2448
04	2410	24	2450
05	2412	25	2452
06	2414	26	2454
07	2416	27	2456
08	2418	28	2458
09	2420	29	2460
10	2422	30	2462
11	2424	31	2464
12	2426	32	2466
13	2428	33	2468
14	2430	34	2470
15	2432	35	2472
16	2434	36	2474
17	2436	37	2476
18	2438	38	2478
19	2440	39	2480

Modulation: GFSK(1Mbps)

For more details, refer to the user's manual of the EUT.

Serial number: Prototype

## 2.4. EUT operation mode

Test Mode(TM)	Description	Remark
TM1	Bottom Channel Transmitting	/
TM2	Middle Channel Transmitting	/
TM3	Top Channel Transmitting	/

The field strength of radiation emission was measured in the following position: EUT stand-up position (Y axis), lie-down position (X, Z axis).

The following data show only with the worst case setup.

Data of the worst mode is reported by this report.

## 2.5. EUT configuration

The following peripheral devices and interface cables were connected during the measurement:

○ - supplied by the manufacturer

● - supplied by the lab

## 2.6. Related Submittal(s) / Grant (s)

This submittal(s) (test report) is intended for FCC ID: 2ABU6-I3 filing to comply with Section 15.249 of the FCC Part 15, Subpart C Rules.

## 2.7. Modifications

No modifications were implemented to meet testing criteria.

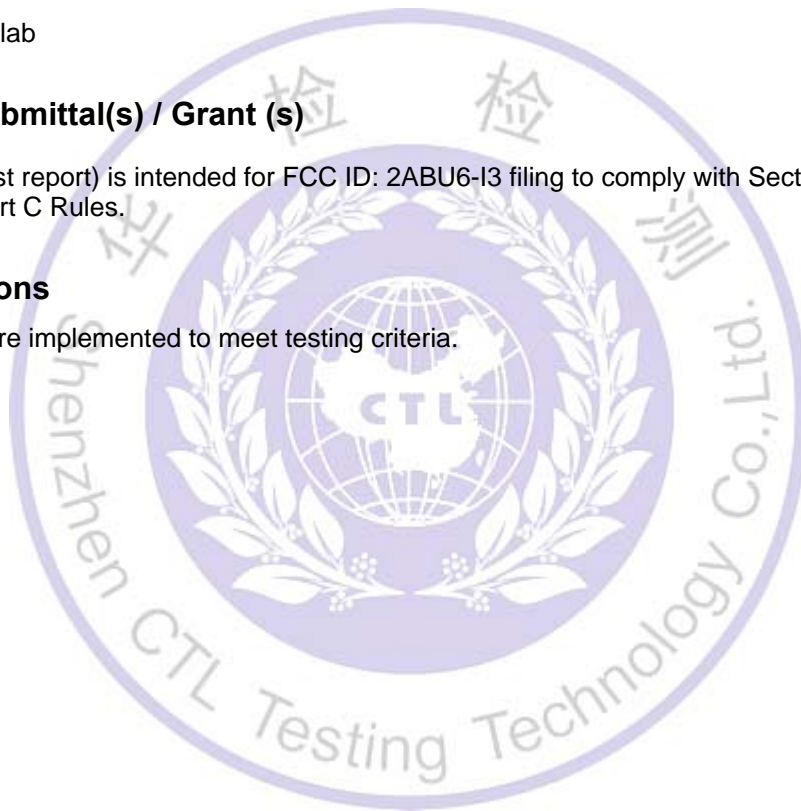

### **3. TEST ENVIRONMENT**

#### **3.1. Address of the test laboratory**

Shenzhen CTL Testing Technology Co., Ltd.  
Floor 1-A, Baisha Technology Park, No. 3011, Shaheji Road, Nanshan, Shenzhen 518055 China

There is one 3m semi-anechoic chamber and two line conducted labs for final test. The Test Sites meet the requirements in documents ANSI C63.4 and CISPR 22/EN 55022 requirements.

#### **3.2. Test Facility**

The test facility is recognized, certified, or accredited by the following organizations:

##### **IC Registration No.: 9618B**

The 3m alternate test site of Shenzhen CTL Testing Technology Co., Ltd. EMC Laboratory has been registered by Certification and Engineer Bureau of Industry Canada for the performance of with Registration No.: 9618B on November 13, 2013.

##### **FCC-Registration No.: 970318**

Shenzhen CTL Testing Technology Co., Ltd. EMC Laboratory has been registered and fully described in a report filed with the (FCC) Federal Communications Commission. The acceptance letter from the FCC is maintained in our files. Registration 970318, December 19, 2013.

#### **3.3. Environmental conditions**

During the measurement the environmental conditions were within the listed ranges:

Temperature: 15-35 ° C

Humidity: 30-60 %

Atmospheric pressure: 950-1050mbar

#### **3.4. Configuration of Tested System**

**Fig. 2-1 Configuration of Tested System**

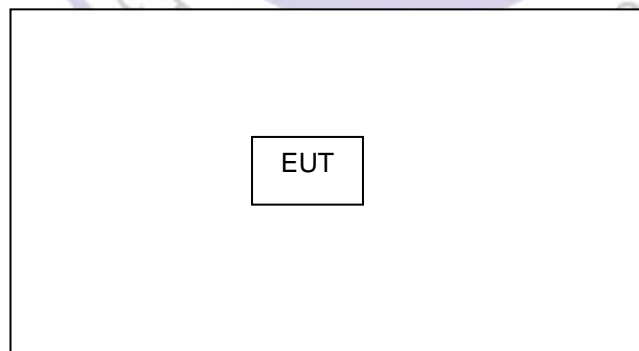

### 3.5. Statement of the measurement uncertainty

The data and results referenced in this document are true and accurate. The reader is cautioned that there may be errors within the calibration limits of the equipment and facilities. The measurement uncertainty was calculated for all measurements listed in this test report acc. to CISPR 16 - 4 „Specification for radio disturbance and immunity measuring apparatus and methods – Part 4: Uncertainty in EMC Measurements“ and is documented in the Shenzhen CTL Testing Technology Co., Ltd. quality system acc. to DIN EN ISO/IEC 17025. Furthermore, component and process variability of devices similar to that tested may result in additional deviation. The manufacturer has the sole responsibility of continued compliance of the device.

Hereafter the best measurement capability for CTL laboratory is reported:

Test	Range	Measurement Uncertainty	Notes
Radiated Emission	30~1000MHz	4.10dB	(1)
Radiated Emission	1~26.5GHz	4.32dB	(1)
Conducted Disturbance	0.15~30MHz	3.20dB	(1)

- (1) This uncertainty represents an expanded uncertainty expressed at approximately the 95% confidence level using a coverage factor of k=2.





### 3.6. Equipments Used during the Test

Test Equipment	Manufacturer	Model No.	Serial No.	Calibration Date	Calibration Due Date
Bilog Antenna	Sunol Sciences Corp.	JB1	A061713	2014/07/12	2015/07/11
EMI Test Receiver	R&S	ESCI	103710	2014/07/10	2015/07/09
Spectrum Analyzer	Agilent	E4407B	MY45108355	2014/07/06	2015/07/05
Controller	EM Electronics	Controller EM 1000	N/A	2014/07/06	2015/07/05
Horn Antenna	Sunol Sciences Corp.	DRH-118	A062013	2014/07/12	2015/07/11
Horn Antenna	SCHWARZBECK	BBHA9170	1562	2014/07/12	2015/07/11
Active Loop Antenna	SCHWARZBECK	FMZB1519	1519-037	2014/07/12	2015/07/11
LISN	R&S	ENV216	101316	2014/07/10	2015/07/09
LISN	SCHWARZBECK	NSLK8127	8127687	2014/07/10	2015/07/09
Microwave Preamplifier	HP	8349B	3155A00882	2014/07/10	2015/07/09
Amplifier	HP	8447D	3113A07663	2014/07/10	2015/07/09
Transient Limiter	Com-Power	LIT-153	532226	2014/07/10	2015/07/09
Radio Communication Tester	R&S	CMU200	3655A03522	2014/07/06	2015/07/05
Temperature/Humidity Meter	zhicheng	ZC1-2	22522	2014/07/10	2015/07/09
SIGNAL GENERATOR	HP	8647A	3200A00852	2014/07/10	2015/07/09
Wideband Peak Power Meter	Anritsu	ML2495A	220.23.35	2014/07/06	2015/07/05
Climate Chamber	ESPEC	EL-10KA	A20120523	2014/07/06	2015/07/05
High-Pass Filter	K&L	9SH10-2700/X12750-O/O	/	2014/07/06	2015/07/05
High-Pass Filter	K&L	41H10-1375/U12750-O/O	/	2014/07/06	2015/07/05

## 4. TEST CONDITIONS AND RESULTS

### 4.1. Conducted Emissions Test

#### TEST CONFIGURATION

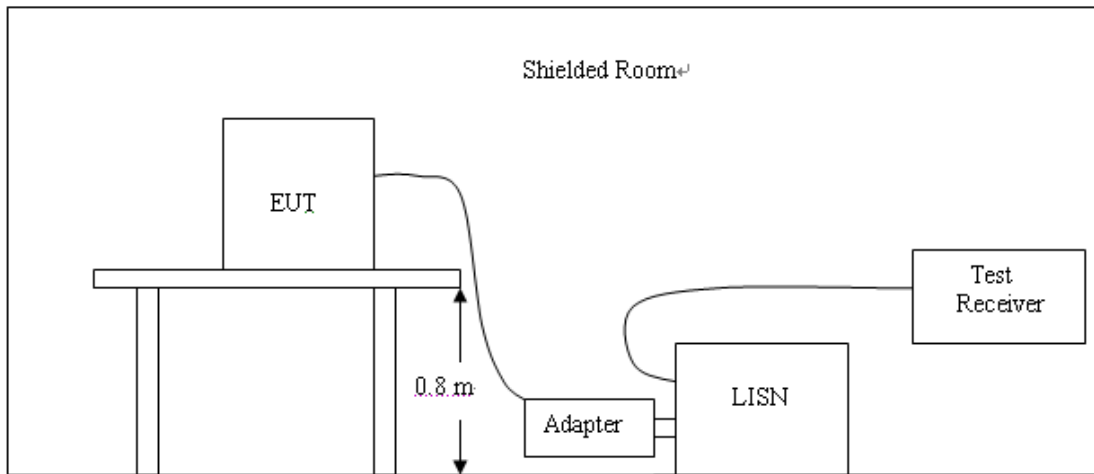

#### TEST PROCEDURE

- 1 The equipment was set up as per the test configuration to simulate typical actual usage per the user's manual. The EUT is a tabletop system, a wooden table with a height of 0.8 meters is used and is placed on the ground plane as per ANSI C63.4.
- 2 Support equipment, if needed, was placed as per ANSI C63.4.
- 3 All I/O cables were positioned to simulate typical actual usage as per ANSI C63.4.
- 4 If a EUT received DC power from the USB Port of Notebook PC, the PC's adapter received AC120V/60Hz power through a Line Impedance Stabilization Network (LISN) which supplied power source and was grounded to the ground plane.
- 5 All support equipments received AC power from a second LISN, if any.
- 6 The EUT test program was started. Emissions were measured on each current carrying line of the EUT using a spectrum Analyzer / Receiver connected to the LISN powering the EUT. The LISN has two monitoring points: Line 1 (Hot Side) and Line 2 (Neutral Side). Two scans were taken: one with Line 1 connected to Analyzer / Receiver and Line 2 connected to a 50 ohm load; the second scan had Line 1 connected to a 50 ohm load and Line 2 connected to the Analyzer / Receiver.
- 7 Analyzer / Receiver scanned from 150 KHz to 30MHz for emissions in each of the test modes.
- 8 During the above scans, the emissions were maximized by cable manipulation.

**The RBW/VBW for 150KHz to 30MHz: 9KHz**

**CONDUCTED POWER LINE EMISSION LIMIT**

For unintentional device, according to § 15.107(a) Line Conducted Emission Limits is as following :

Frequency (MHz)	Maximum RF Line Voltage (dB $\mu$ V)			
	CLASS A		CLASS B	
	Q.P.	Ave.	Q.P.	Ave.
0.15 - 0.50	79	66	66-56*	56-46*
0.50 - 5.00	73	60	56	46
5.00 - 30.0	73	60	60	50

\* Decreasing linearly with the logarithm of the frequency

For intentional device, according to §15.207(a) Line Conducted Emission Limit is same as above table.

**TEST RESULTS**

Not applicable to this device.



## 4.2. Fundamental Emissions

### TEST CONFIGURATION

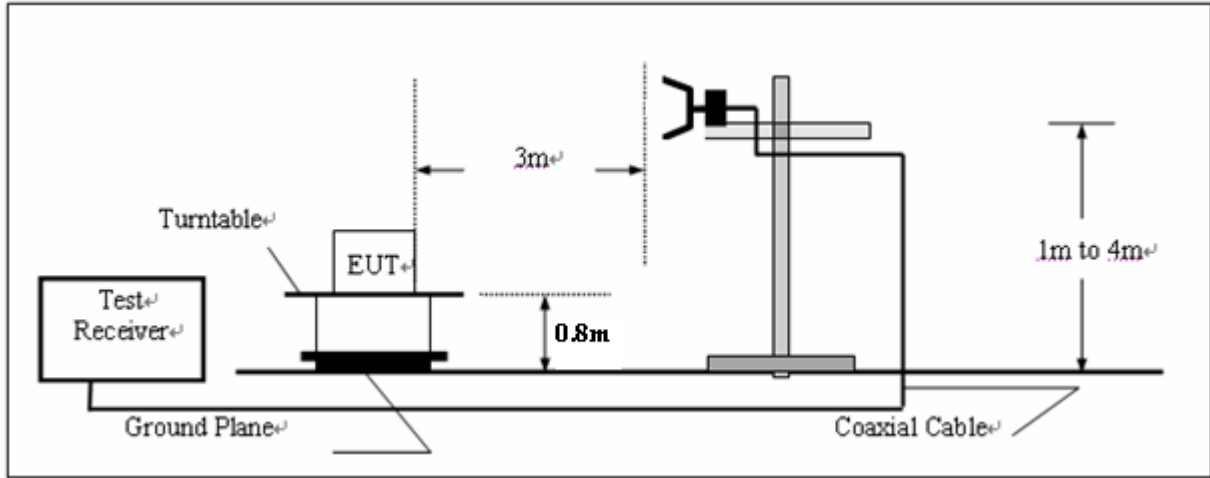

### Fundamental Emissions Limit

2400-2483.5 MHz Band: 94 dBuV/m (average)

For the transmitter emissions shall be measured using following options below:

Remark:

RBW =1MHz, VBW= 3MHz, PK Detector for PK value.

RBW =1MHz, VBW =10Hz, PK Detector for AV value.

### TEST RESULTS

Field Strength of Fundamental Emissions Result					
Modulation	Frequency	Max.Fundamental	Margin	Limit	Type
Mode	(MHz)	(dBuV/m)@3m	(dB)	(dBuV/m)@3m	
GFSK	2402	92.89	21.11	114	peak
GFSK	2402	75.33	18.67	94	average
GFSK	2441	91.72	22.28	114	peak
GFSK	2441	75.06	18.94	94	average
GFSK	2480	91.47	22.53	114	peak
GFSK	2480	75.26	18.74	94	average

Note: Horizontal and Vertical polarity all have been tested, Vertical polarity is the worst case and reported.

### 4.3. Transmitter Radiated Unwanted Emissions

#### TEST CONFIGURATION

(A) Radiated Emission Test Set-Up, Frequency Below 30MHz

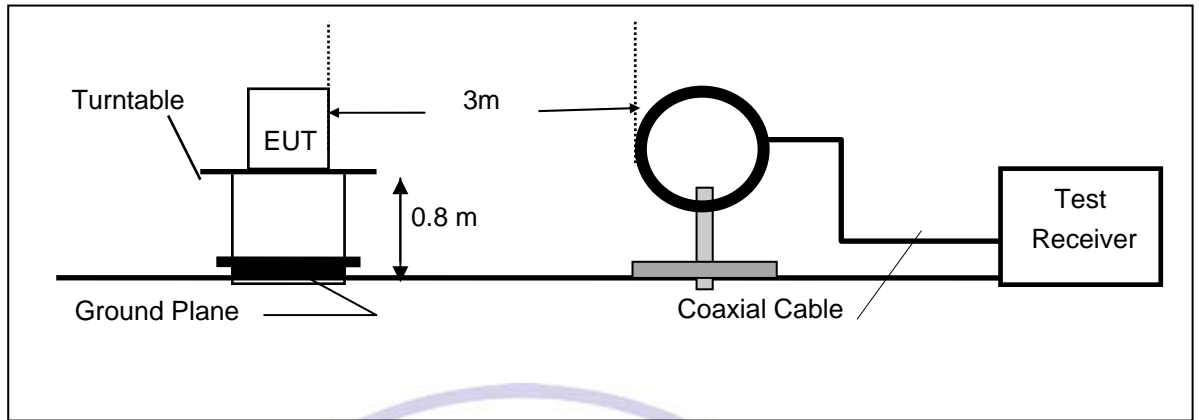

(B) Radiated Emission Test Set-Up, Frequency below 1000MHz

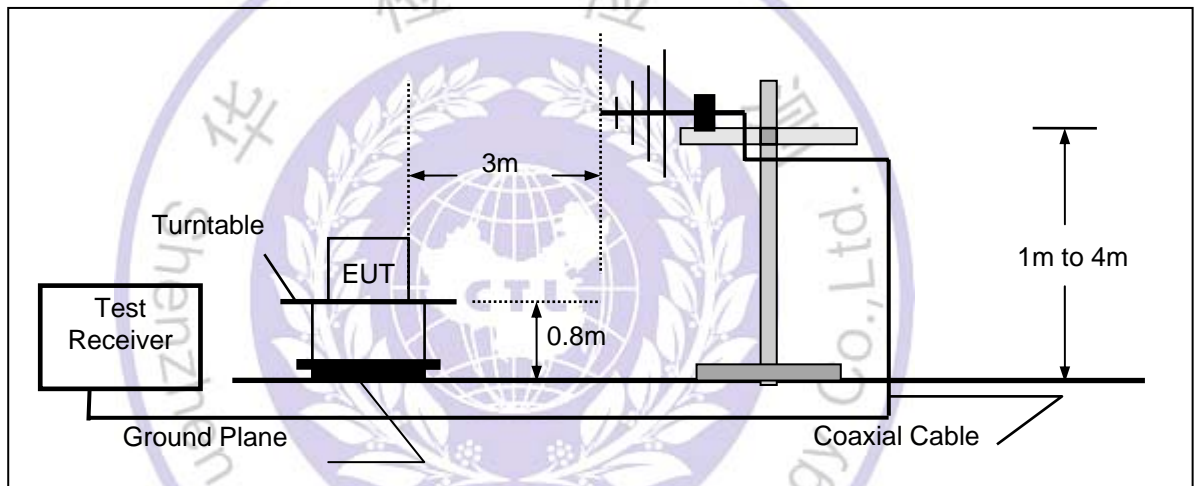

(C) Radiated Emission Test Set-Up, Frequency above 1000MHz

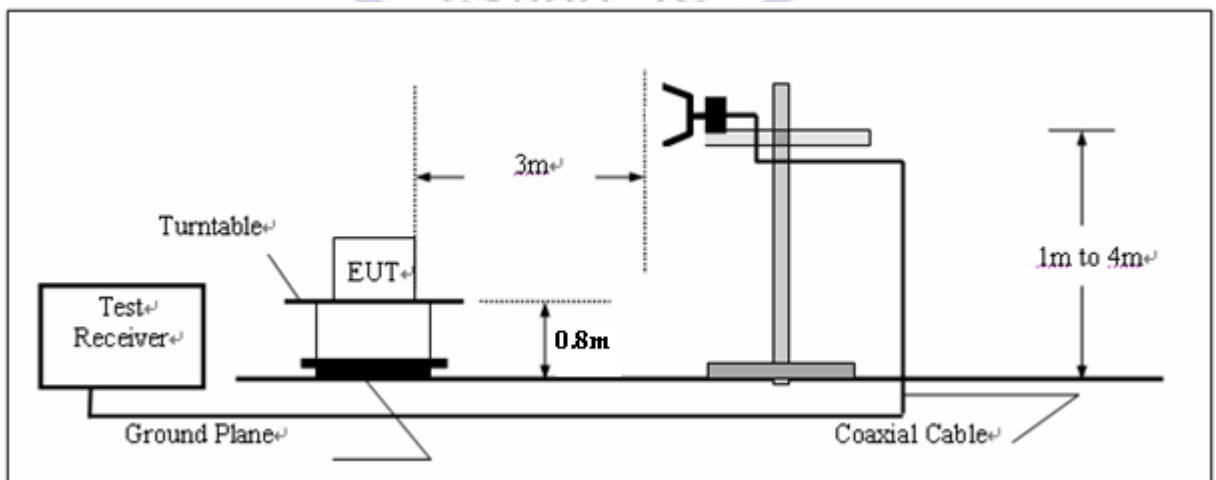

**FIELD STRENGTH CALCULATION**

The field strength is calculated by adding the Antenna Factor and Cable Factor and subtracting the Amplifier Gain and Duty Cycle Correction Factor(if any) from the measured reading. The basic equation with a sample calculation is as follows:

$$FS = RA + AF + CL - AG$$

Where FS = Field Strength	CL = Cable Attenuation Factor (Cable Loss)
RA = Reading Amplitude	AG = Amplifier Gain
AF = Antenna Factor	

**RADIATION LIMIT**

For unintentional device, according to § 15.109(a), except for Class A digital devices, the field strength of radiated emissions from unintentional radiators at a distance of 3 meters shall not exceed the following values:

Frequency (MHz)	Distance (Meters)	Radiated (dBµV/m)	Radiated (µV/m)
30-88	3	40.0	100
88-216	3	43.5	150
216-960	3	46.0	200
Above 960	3	54.0	500

For intentional device, according to § 15.209(a), the general requirement of field strength of radiated emissions from intentional radiators at a distance of 3 meters shall not exceed the above table.

**TEST PROCEDURE**

1. The EUT is placed on a turntable, which is 0.8m above ground plane.
2. The turntable shall be rotated for 360 degrees to determine the position of maximum emission level.
3. EUT is set 3m away from the receiving antenna, which is varied from 1m to 4m to find out the highest emissions.
4. Maximum procedure was performed on the six highest emissions to ensure EUT compliance.
5. And also, each emission was to be maximized by changing the polarization of receiving antenna both horizontal and vertical.
6. Repeat above procedures until the measurements for all frequencies are complete.
7. Based on the Frequency Generator in the device include 32MHz. The test frequency range from 9KHz to 25GHz per FCC PART 15.33(a).

**Note:**

Three axes are chosen for pretest, the Y axis is the worst mode for final test.

For battery operated equipment, the equipment tests shall be performed using a new battery.

**TEST RESULTS**

All the test modes (TM1, TM2, TM3) completed for test. The worst case of Radiated Emission is TM1; the test data of this mode was reported.

Below 1GHz Test Results:

**SWEEP TABLE: "test (30M-1G)"**

Short Description:		Field Strength			
Start	Stop	Detector	Meas. Time	IF Bandw.	Transducer
Frequency	Frequency				
30.0 MHz	1.0 GHz	MaxPeak	300.0 ms	120 kHz	JB1

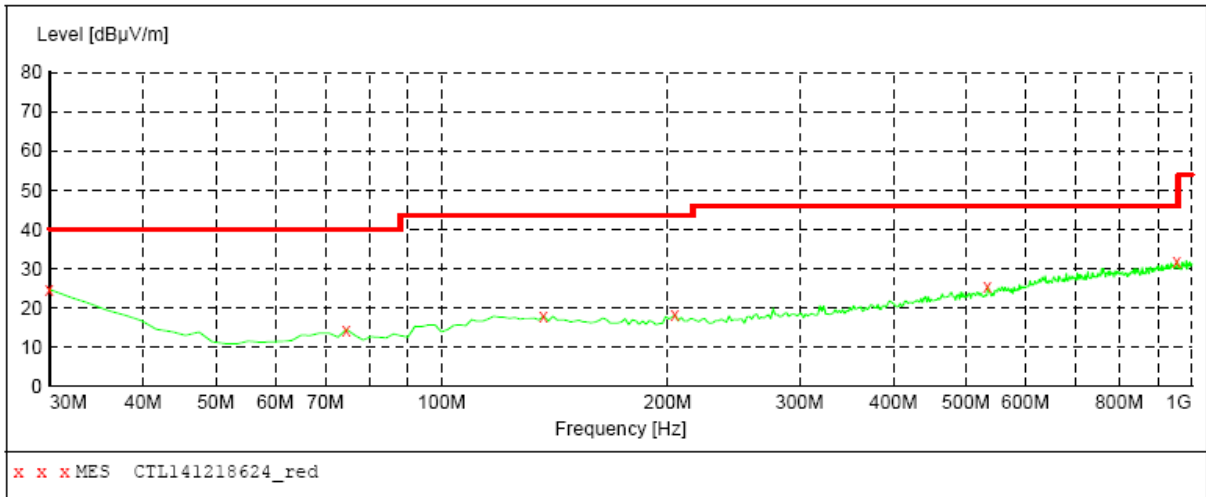

**MEASUREMENT RESULT: "CTL141218624\_red"**

12/18/2014 2:23PM

Frequency MHz	Level dBµV/m	Transd dB	Limit dBµV/m	Margin dB	Det.	Height cm	Azimuth deg	Polarization
30.000000	24.60	21.1	40.0	15.4	---	0.0	0.00	VERTICAL
74.620000	14.40	8.5	40.0	25.6	---	0.0	0.00	VERTICAL
136.700000	17.90	14.7	43.5	25.6	---	0.0	0.00	VERTICAL
204.600000	18.20	14.4	43.5	25.3	---	0.0	0.00	VERTICAL
534.400000	25.40	20.6	46.0	20.6	---	0.0	0.00	VERTICAL
955.380000	32.00	26.7	46.0	14.0	---	0.0	0.00	VERTICAL

Remark:

- (1) Measuring frequencies from 9 KHz to the 1 GHz, Radiated emission test from 9KHz to 30MHz was verified, and no any emission was found except system noise floor.
- (2) \* denotes emission frequency which appearing within the Restricted Bands specified in provision of 15.205, then the general radiated emission limits in 15.209 apply.
- (3) The IF bandwidth of EMI Test Receiver between 30MHz to 1GHz was 120KHz, 1 MHz for measuring above 1 GHz, below 30MHz was 10KHz.

**SWEEP TABLE: "test (30M-1G)"**

Short Description:		Field Strength			
Start	Stop	Detector	Meas. Time	IF Bandw.	Transducer
30.0 MHz	1.0 GHz	MaxPeak	300.0 ms	120 kHz	JB1

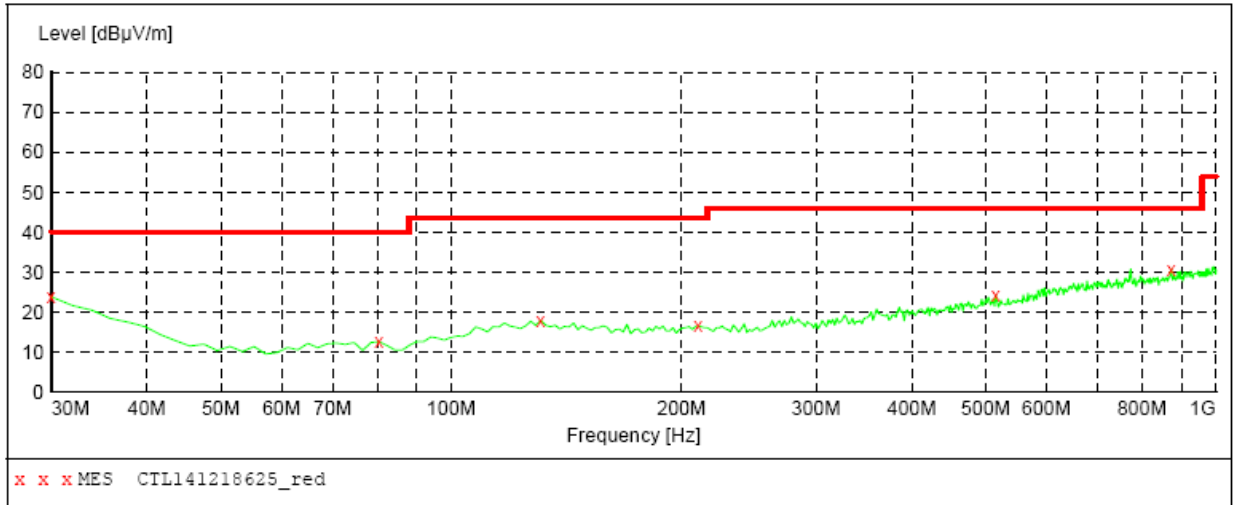

**MEASUREMENT RESULT: "CTL141218625\_red"**

12/18/2014 2:23PM

Frequency MHz	Level dBuV/m	Transd dB	Limit dBuV/m	Margin dB	Det.	Height cm	Azimuth deg	Polarization
30.000000	23.70	21.1	40.0	16.3	---	0.0	0.00	HORIZONTAL
80.440000	12.60	8.8	40.0	27.4	---	0.0	0.00	HORIZONTAL
130.880000	17.90	14.9	43.5	25.6	---	0.0	0.00	HORIZONTAL
210.420000	16.50	14.3	43.5	27.0	---	0.0	0.00	HORIZONTAL
515.000000	24.20	20.5	46.0	21.8	---	0.0	0.00	HORIZONTAL
873.900000	30.80	25.6	46.0	15.2	---	0.0	0.00	HORIZONTAL

Remark:

- (1) Measuring frequencies from 9 KHz to the 1 GHz, Radiated emission test from 9KHz to 30MHz was verified, and no any emission was found except system noise floor.
- (2) \* denotes emission frequency which appearing within the Restricted Bands specified in provision of 15.205, then the general radiated emission limits in 15.209 apply.
- (3) The IF bandwidth of EMI Test Receiver between 30MHz to 1GHz was 120KHz, 1 MHz for measuring above 1 GHz, below 30MHz was 10KHz.



**Above 1 GHz Test Results:**

**Bottom Channel (2402MHz):**

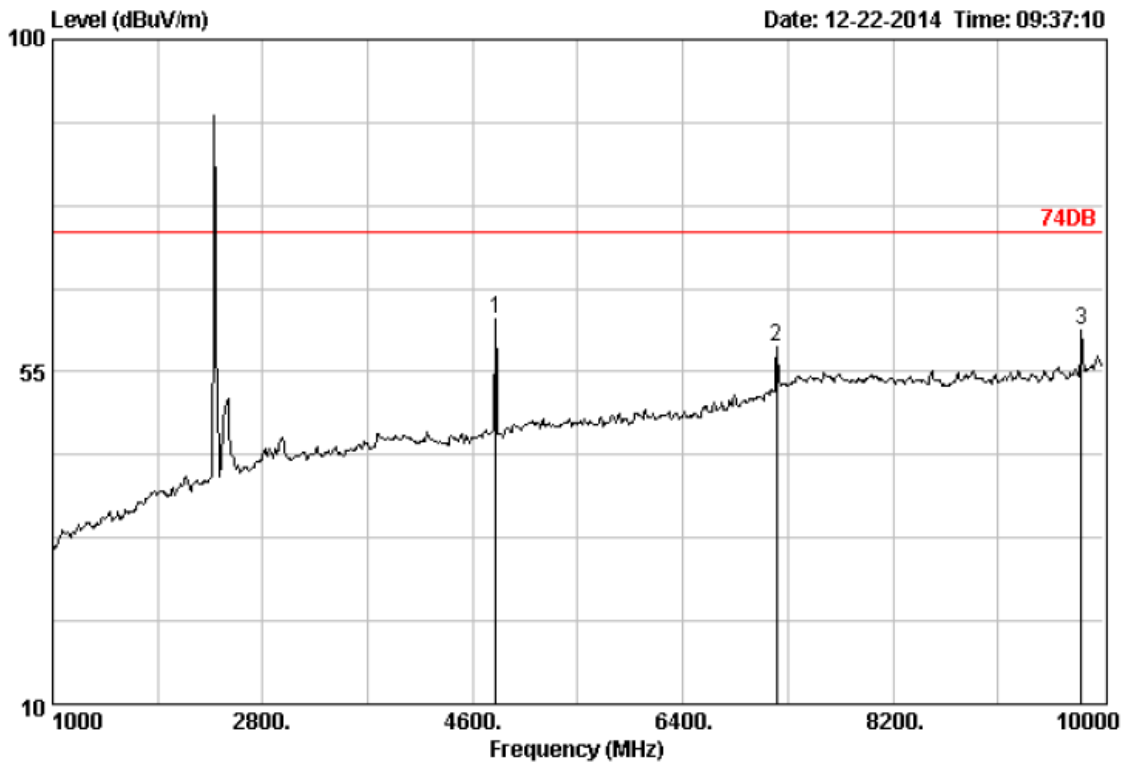

```

Site no.       : 3m Chamber                Data no. : 1271
Dis. / Ant.   : 3m DRH-118              Ant. pol. : HORIZONTAL
Limit         : 74DB
Env. / Ins.   : 23*C/54%
Engineer      :
EUT           :
Power         :
M/N          :
Test Mode     :
    
```

Freq. (MHz)	Ant. Factor (dB)	Cable Loss (dB)	Reading (dBuV)	Emission		Margin (dB)	Remark	
				Level (dBuV/m)	Limits (dBuV/m)			
1	4798.00	33.44	6.90	56.17	62.16	74.00	11.84	Peak
2	7201.00	36.92	9.18	47.37	58.44	74.00	15.56	Peak
3	9811.00	38.71	11.05	46.41	60.59	74.00	13.41	Peak

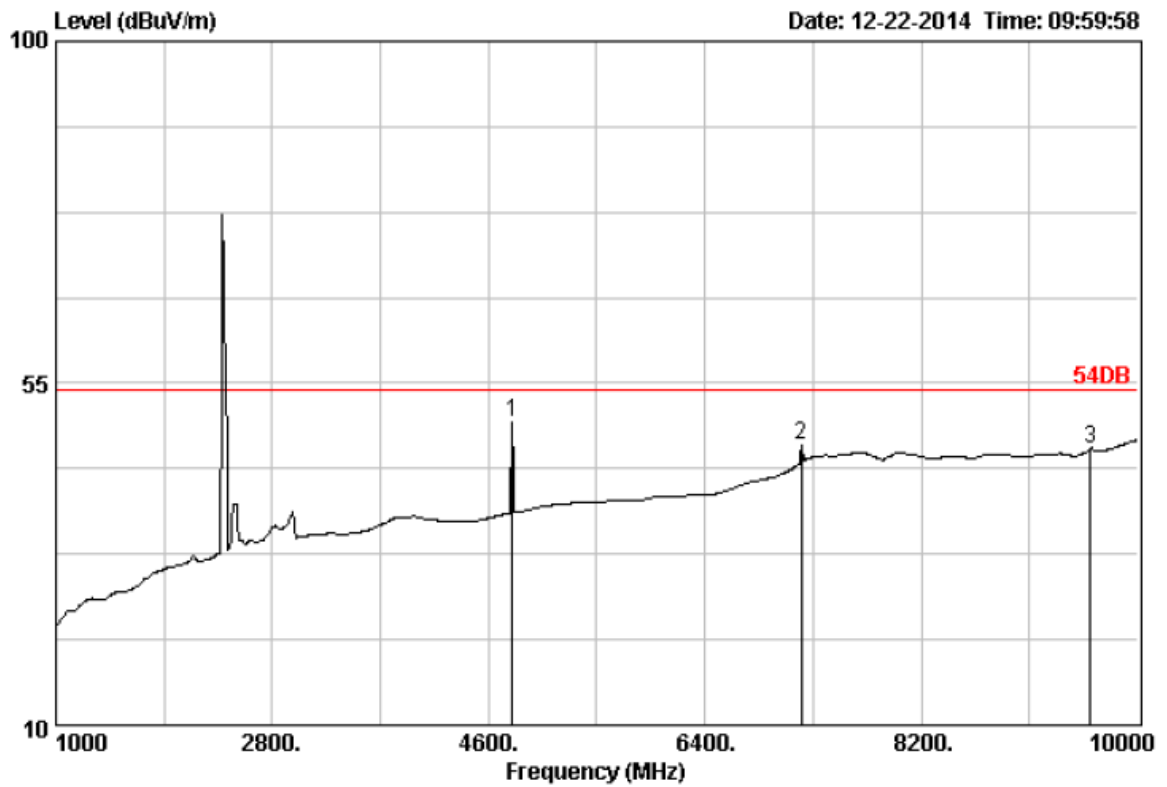

Site no. : 3m Chamber  
 Dis. / Ant. : 3m DRH-118  
 Limit : 54DB  
 Env. / Ins. : 23\*C/54%  
 Engineer :  
 EUT :  
 Power :  
 M/N :  
 Test Mode :

Data no. : 1276  
 Ant. pol. : HORIZONTAL

	Freq. (MHz)	Ant. Factor (dB)	Cable Loss (dB)	Emission				Remark
				Reading (dBuV)	Level (dBuV/m)	Limits (dBuV/m)	Margin (dB)	
1	4798.00	33.44	6.90	43.81	49.80	54.00	4.20	Average
2	7201.00	36.92	9.18	35.81	46.88	54.00	7.12	Average
3	9608.00	38.53	10.97	32.85	46.36	54.00	7.64	Average

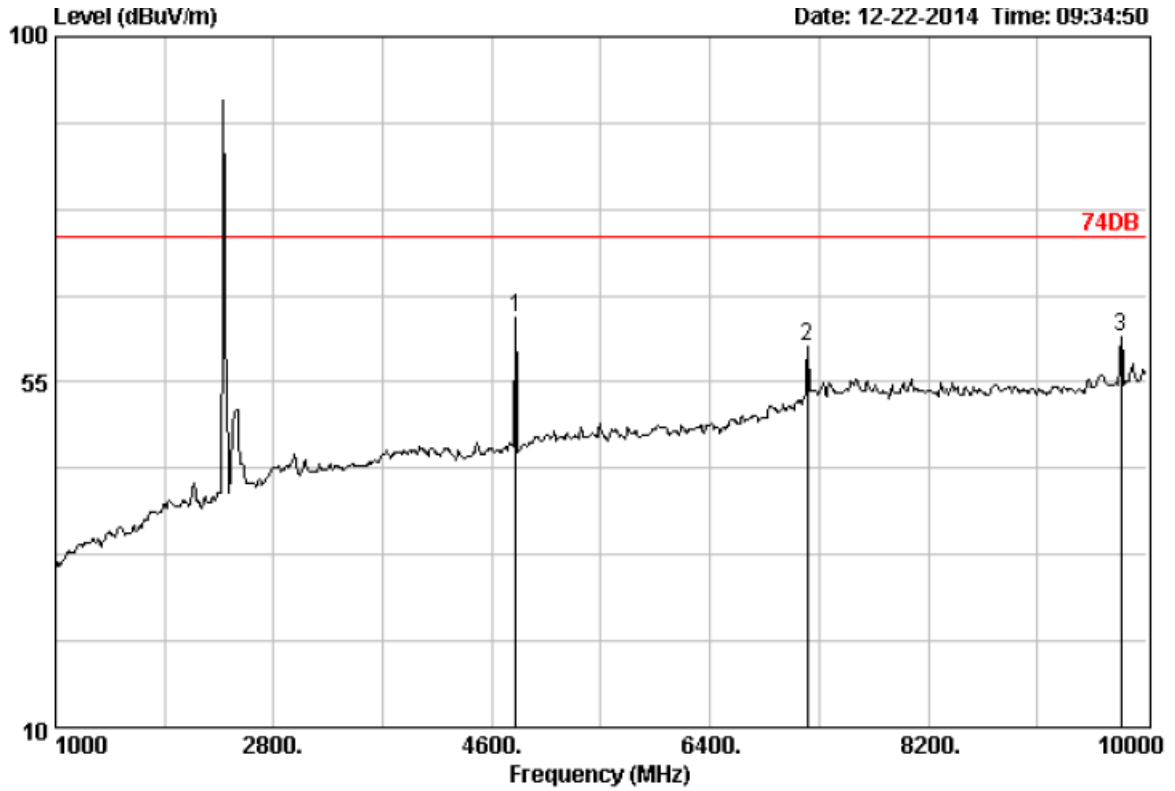

Date: 12-22-2014 Time: 09:34:50

Site no. : 3m Chamber  
 Dis. / Ant. : 3m DRH-118  
 Limit : 74DB  
 Env. / Ins. : 23°C/54%  
 Engineer :  
 EUT :  
 Power :  
 M/N :  
 Test Mode :

Data no. : 1270  
 Ant. pol. : VERTICAL

	Freq. (MHz)	Ant. Factor (dB)	Cable Loss (dB)	Reading (dBuV)	Emission		Margin (dB)	Remark
					Level (dBuV/m)	Limits (dBuV/m)		
1	4798.00	33.44	6.90	57.51	63.50	74.00	10.50	Peak
2	7201.00	36.92	9.18	48.53	59.60	74.00	14.40	Peak
3	9793.00	38.69	11.05	46.68	60.80	74.00	13.20	Peak

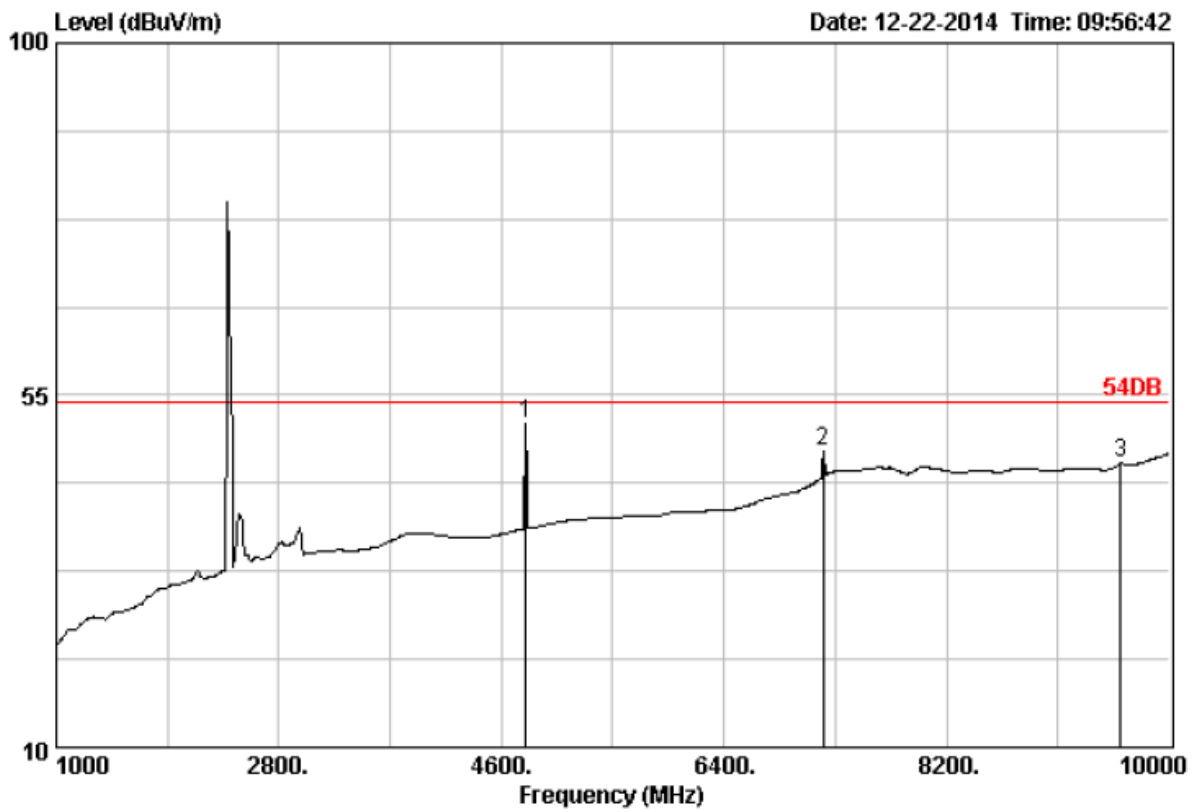

Site no. : 3m Chamber Data no. : 1275  
 Dis. / Ant. : 3m DRH-118 Ant. pol. : VERTICAL  
 Limit : 54DB  
 Env. / Ins. : 23\*C/54%  
 Engineer :  
 EUT :  
 Power :  
 M/N :  
 Test Mode :

	Freq. (MHz)	Ant. Factor (dB)	Cable Loss (dB)	Emission				Remark
				Reading (dBuV)	Level (dBuV/m)	Limits (dBuV/m)	Margin (dB)	
1	4798.00	33.44	6.90	45.37	51.36	54.00	2.64	Average
2	7201.00	36.92	9.18	36.76	47.83	54.00	6.17	Average
3	9608.00	38.53	10.97	32.80	46.31	54.00	7.69	Average

Middle Channel (2440 MHz):

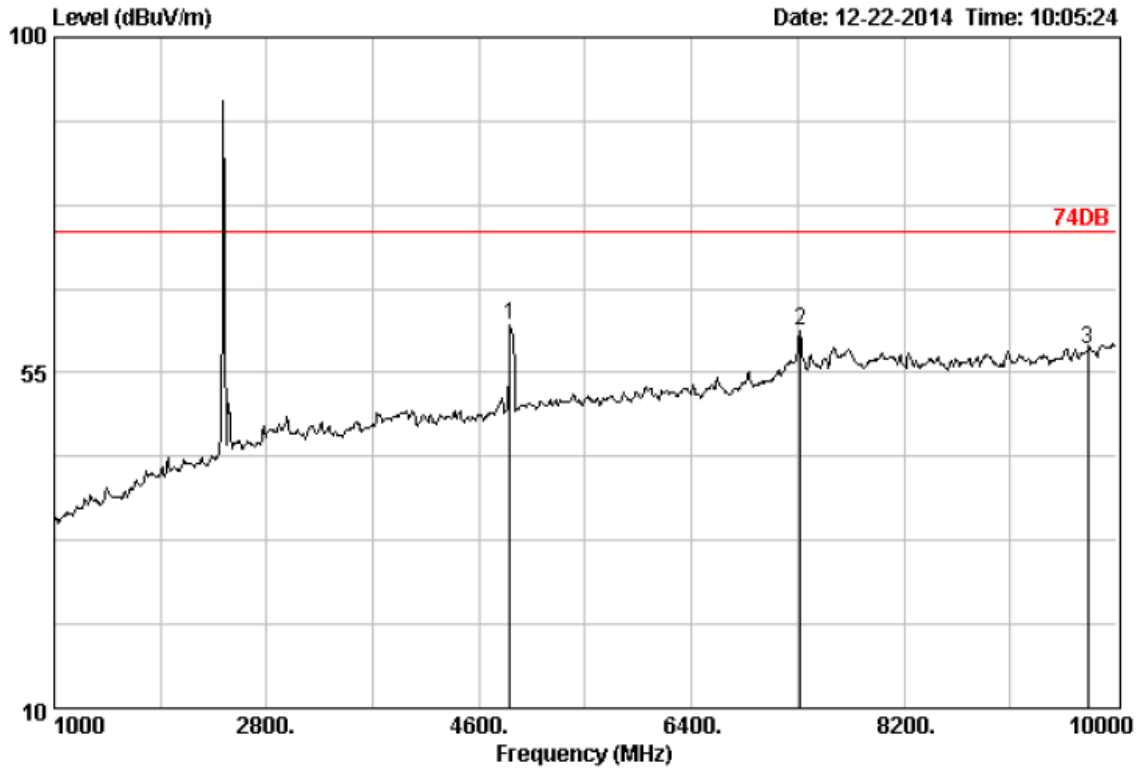

Site no. : 3m Chamber Data no. : 1278  
 Dis. / Ant. : 3m DRH-118 Ant. pol. : HORIZONTAL  
 Limit : 74DB  
 Env. / Ins. : 23°C/54%  
 Engineer :  
 EUT :  
 Power :  
 M/N :  
 Test Mode :

	Freq. (MHz)	Ant. Factor (dB)	Cable Loss (dB)	Emission				
				Reading (dBuV)	Level (dBuV/m)	Limits (dBuV/m)	Margin (dB)	Remark
1	4861.00	33.57	6.94	55.18	61.38	74.00	12.62	Peak
2	7318.00	37.46	9.23	48.83	60.52	74.00	13.48	Peak
3	9760.00	38.65	11.03	44.16	58.15	74.00	15.85	Peak

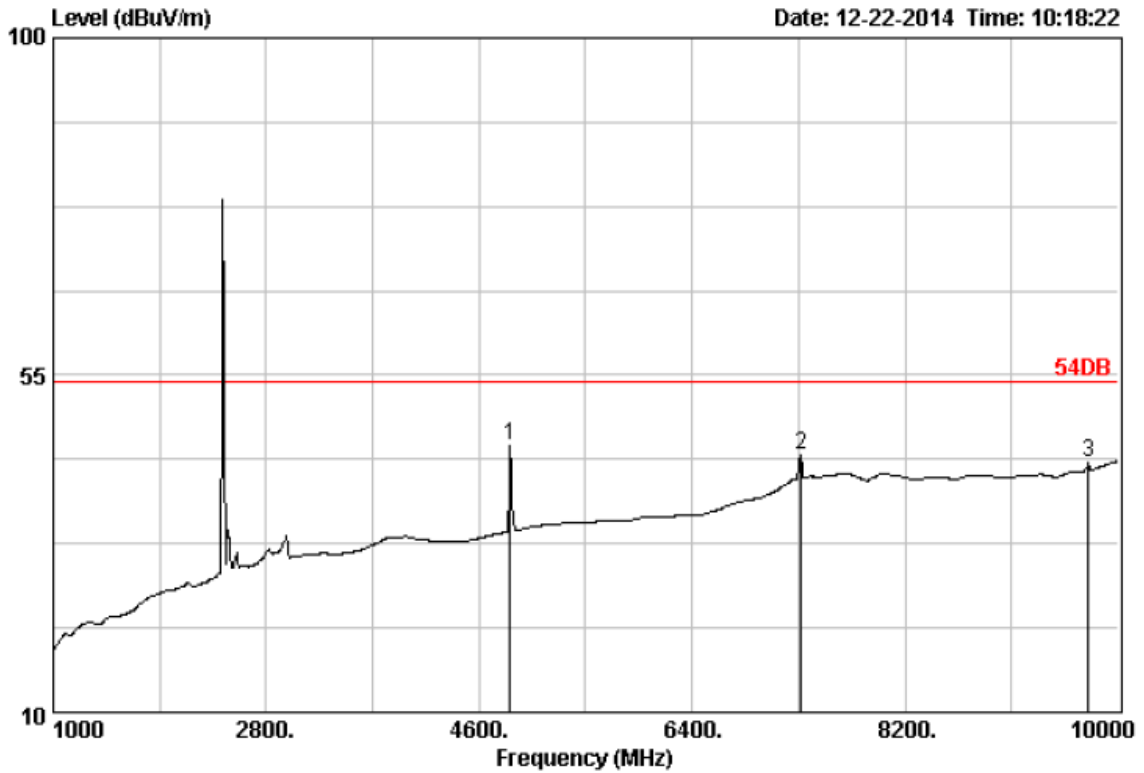

Site no. : 3m Chamber  
 Dis. / Ant. : 3m DRH-118  
 Limit : 54DB  
 Env. / Ins. : 23°C/54%  
 Engineer :  
 EUT :  
 Power :  
 M/N :  
 Test Mode :

Data no. : 1280  
 Ant. pol. : HORIZONTAL

	Freq. (MHz)	Ant. Factor (dB)	Cable Loss (dB)	Reading (dBUV)	Emission Level (dBUV/m)	Limits (dBUV/m)	Margin (dB)	Remark
1	4861.00	33.57	6.94	39.45	45.65	54.00	8.35	Average
2	7318.00	37.46	9.23	32.76	44.45	54.00	9.55	Average
3	9748.00	38.65	11.03	29.32	43.29	54.00	10.71	Average

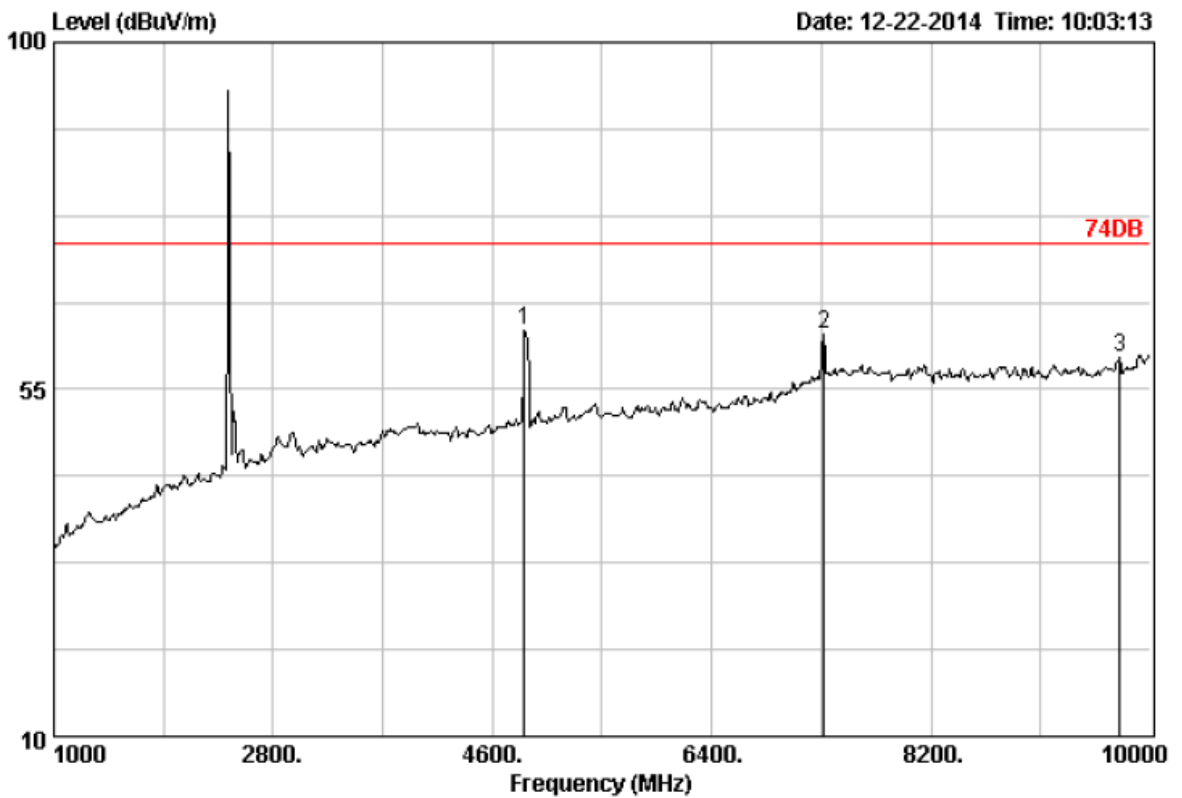

Site no. : 3m Chamber Data no. : 1277  
 Dis. / Ant. : 3m DRH-118 Ant. pol. : VERTICAL  
 Limit : 74DB  
 Env. / Ins. : 23\*C/54%  
 Engineer :  
 EUT :  
 Power :  
 M/N :  
 Test Mode :

	Freq. (MHz)	Ant. Factor (dB)	Cable Loss (dB)	Reading (dBuV)	Emission			Remark
					Level (dBuV/m)	Limits (dBuV/m)	Margin (dB)	
1	4861.00	33.57	6.94	56.37	62.57	74.00	11.43	Peak
2	7318.00	37.46	9.23	50.37	62.06	74.00	11.94	Peak
3	9748.00	38.65	11.03	45.18	59.15	74.00	14.85	Peak

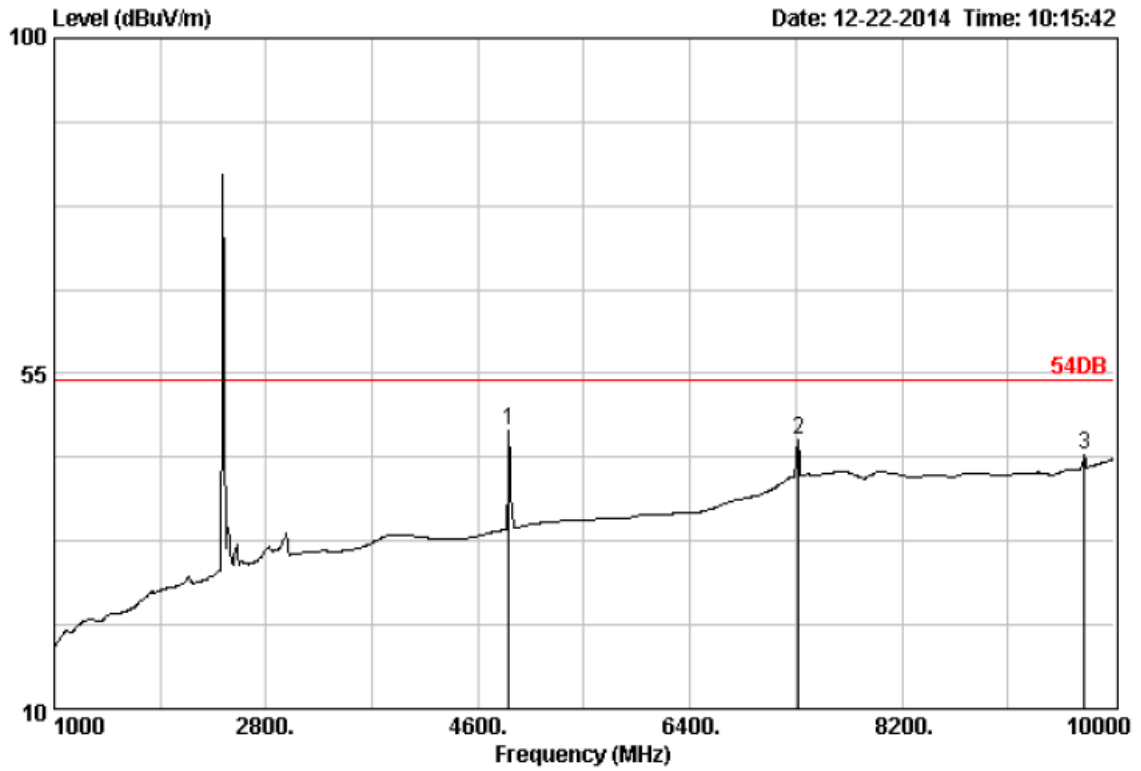

Site no. : 3m Chamber  
 Dis. / Ant. : 3m DRH-118  
 Limit : 54DB  
 Env. / Ins. : 23\*C/54%  
 Engineer :  
 EUT :  
 Power :  
 M/N :  
 Test Mode :

Data no. : 1279  
 Ant. pol. : VERTICAL

	Freq. (MHz)	Ant. Factor (dB)	Cable Loss (dB)	Reading (dBuV)	Emission		Margin (dB)	Remark
					Level (dBuV/m)	Limits (dBuV/m)		
1	4861.00	33.57	6.94	41.05	47.25	54.00	6.75	Average
2	7318.00	37.46	9.23	34.35	46.04	54.00	7.96	Average
3	9748.00	38.65	11.03	30.20	44.17	54.00	9.83	Average



Top Channel (2480MHz):

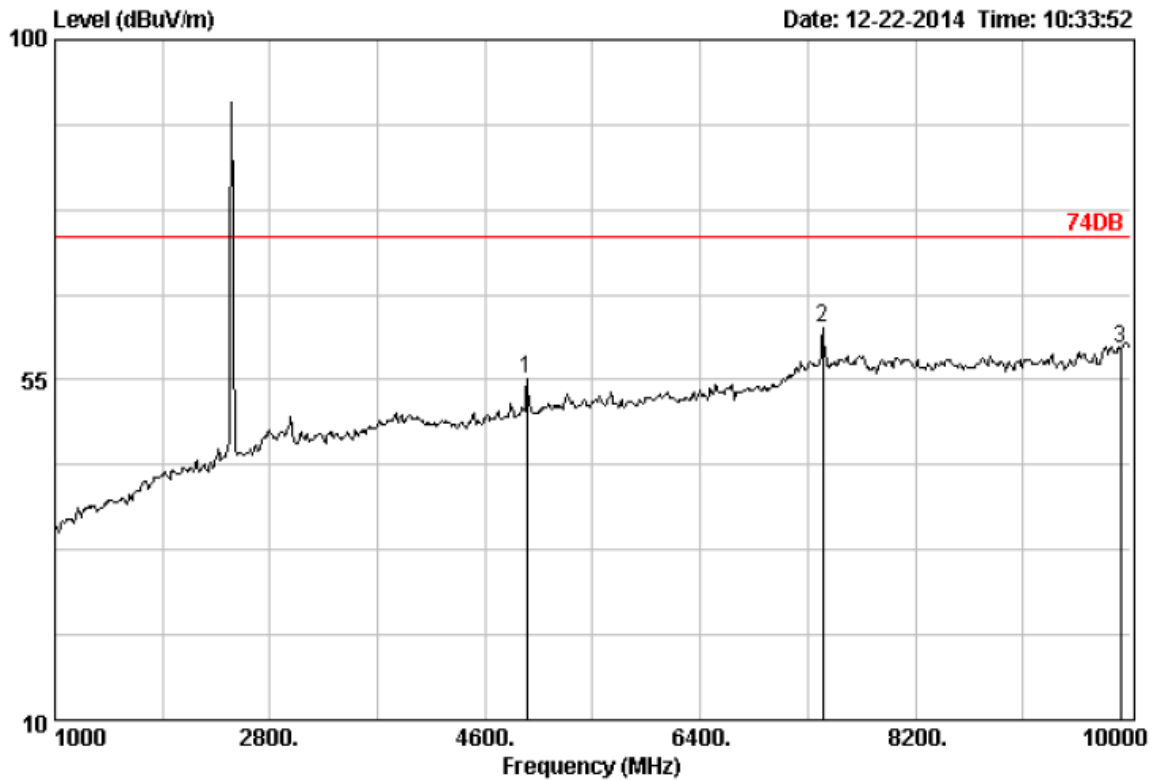

Site no. : 3m Chamber Data no. : 1286  
 Dis. / Ant. : 3m DRH-118 Ant. pol. : HORIZONTAL  
 Limit : 74DB  
 Env. / Ins. : 23\*C/54%  
 Engineer :  
 EUT :  
 Power :  
 M/N :  
 Test Mode :

	Freq. (MHz)	Ant. Factor (dB)	Cable Loss (dB)	Reading (dBuV)	Emission Level (dBuV/m)	Limits (dBuV/m)	Margin (dB)	Remark
1	4951.00	33.80	7.00	48.61	55.15	74.00	18.85	Peak
2	7426.00	37.64	9.27	50.06	62.00	74.00	12.00	Peak
3	9920.00	38.90	11.10	44.41	59.04	74.00	14.96	Peak

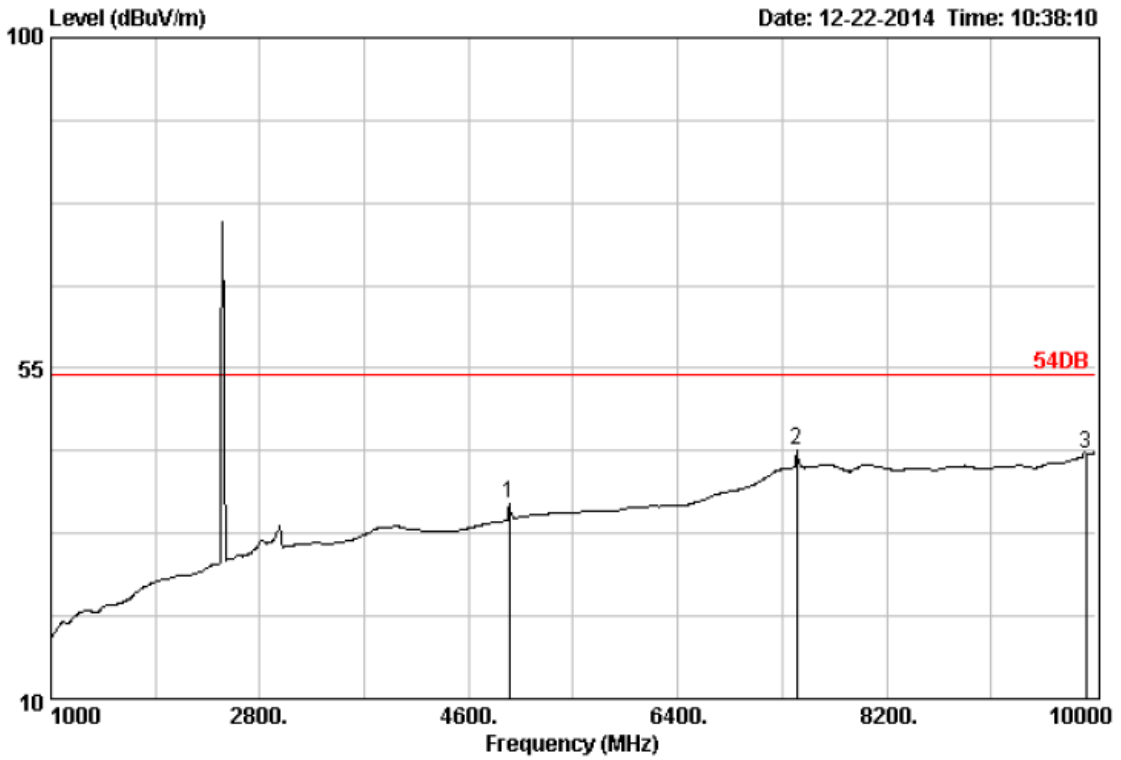

Site no. : 3m Chamber  
 Dis. / Ant. : 3m DRH-118  
 Limit : 54DB  
 Env. / Ins. : 23\*C/54%  
 Engineer :  
 EUT :  
 Power :  
 M/N :  
 Test Mode :  
 Data no. : 1287  
 Ant. pol. : HORIZONTAL

	Freq. (MHz)	Ant. Factor (dB)	Cable Loss (dB)	Reading (dBuV)	Emission Level (dBuV/m)	Limits (dBuV/m)	Margin (dB)	Remark
1	4951.00	33.80	7.00	30.12	36.66	54.00	17.34	Average
2	7426.00	37.64	9.27	31.93	43.87	54.00	10.13	Average
3	9920.00	38.90	11.10	28.71	43.34	54.00	10.66	Average

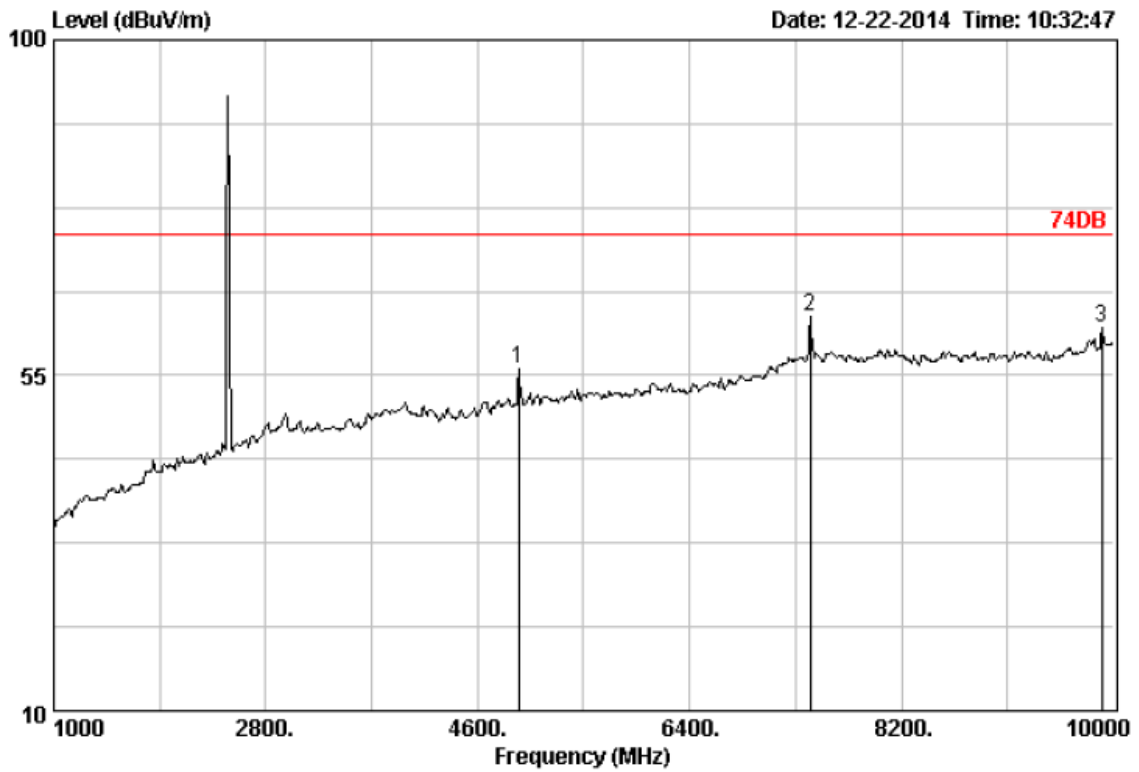

Site no. : 3m Chamber  
 Dis. / Ant. : 3m DRH-118  
 Limit : 74DB  
 Env. / Ins. : 23\*C/54%  
 Engineer :  
 EUT :  
 Power :  
 M/N :  
 Test Mode :

Data no. : 1285  
 Ant. pol. : VERTICAL

	Freq. (MHz)	Ant. Factor (dB)	Cable Loss (dB)	Reading (dBuV)	Emission Level (dBuV/m)	Limits (dBuV/m)	Margin (dB)	Remark
1	4951.00	33.80	7.00	49.43	55.97	74.00	18.03	Peak
2	7426.00	37.64	9.27	50.93	62.87	74.00	11.13	Peak
3	9901.00	38.87	11.10	46.85	61.41	74.00	12.59	Peak

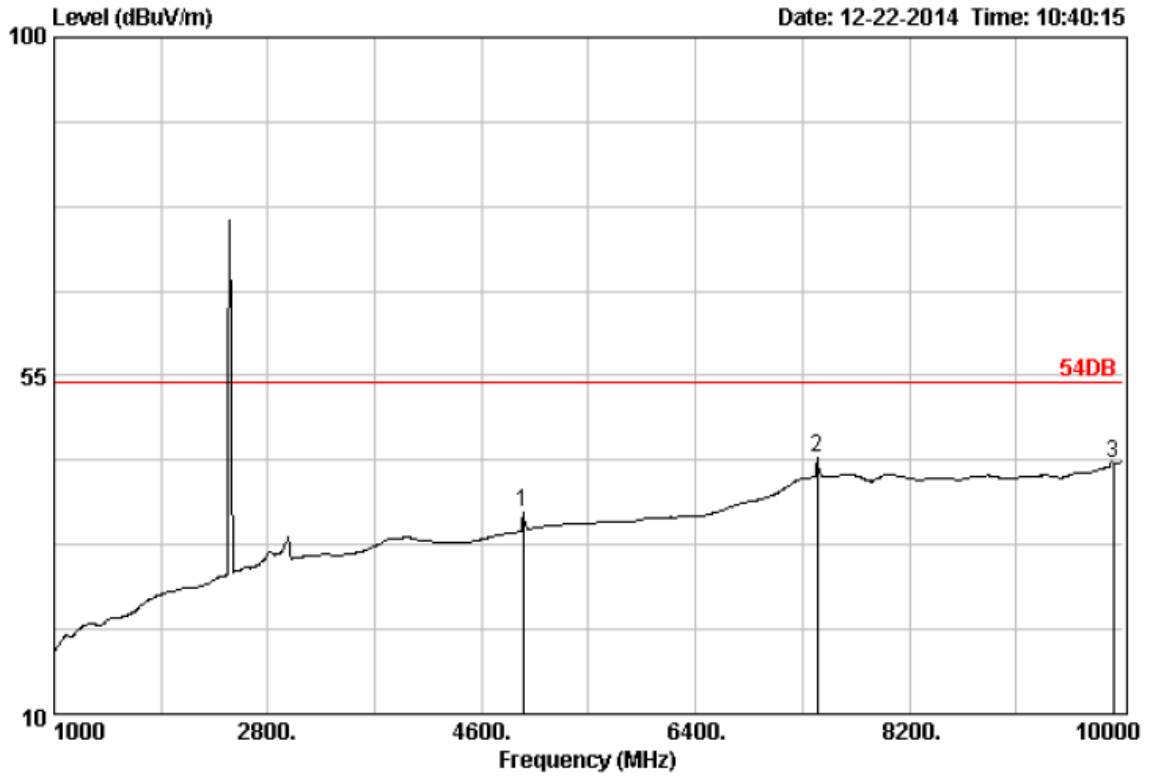

Site no. : 3m Chamber Data no. : 1288  
 Dis. / Ant. : 3m DRH-118 Ant. pol. : VERTICAL  
 Limit : 54DB  
 Env. / Ins. : 23°C/54%  
 Engineer :  
 EUT :  
 Power :  
 M/N :  
 Test Mode :

	Freq. (MHz)	Ant. Factor (dB)	Cable Loss (dB)	Reading (dBuV)	Emission Level (dBuV/m)	Limits (dBuV/m)	Margin (dB)	Remark
1	4951.00	33.80	7.00	30.40	36.94	54.00	17.06	Average
2	7426.00	37.64	9.27	32.10	44.04	54.00	9.96	Average
3	9920.00	38.90	11.10	28.74	43.37	54.00	10.63	Average

**Note:** above 10GHz up to 25GHz was verified, and no any emission was found except system noise floor.

## 4.4. Band Edge Measurement

### TEST CONFIGURATION

Same as Section 4.2

### TEST PROCEDURE

The band edge compliance of RF radiated emission should be measured by following the guidance in ANSI C63.4 with respect to maximizing the emission by rotating the EUT, measuring the emission while the EUT is situated in three orthogonal planes (if appropriate), adjusting the measurement antenna height and polarization etc. Set RBW to 1 MHz and VBM to 3MHz to measure the peak field strength and set RBW to 1MHz and VBW to 10Hz to measure the average radiated field strength.

PK detector is used for both AV and PK test.

### LIMIT

FCC PART 15.249(d) Emissions radiated outside of the specified frequency bands, except for harmonics, shall be attenuated by at least 50 dB below the level of the fundamental or to the general radiated emission limits in §15.209, whichever is the lesser attenuation.

### TEST RESULTS

#### **Note:**

For the band-edge measurement, both hopping-on mode and hopping-off mode measured. And the worst case (hopping-off) is recorded.

**See next pages please.**

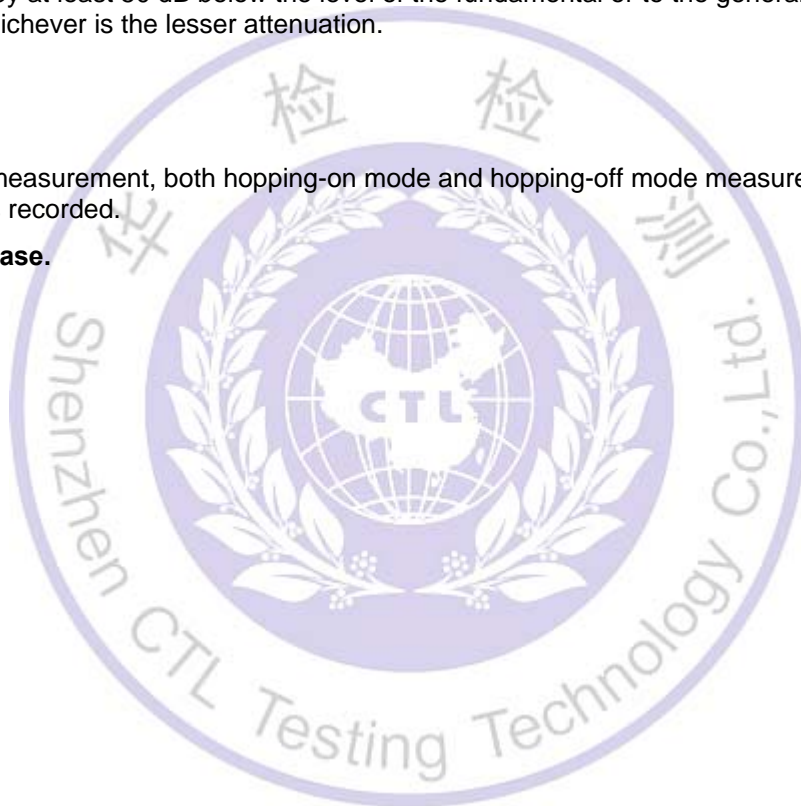

**Radiated Test:**

Operation Mode: TX on Bot Channel

Polarity: Hor.

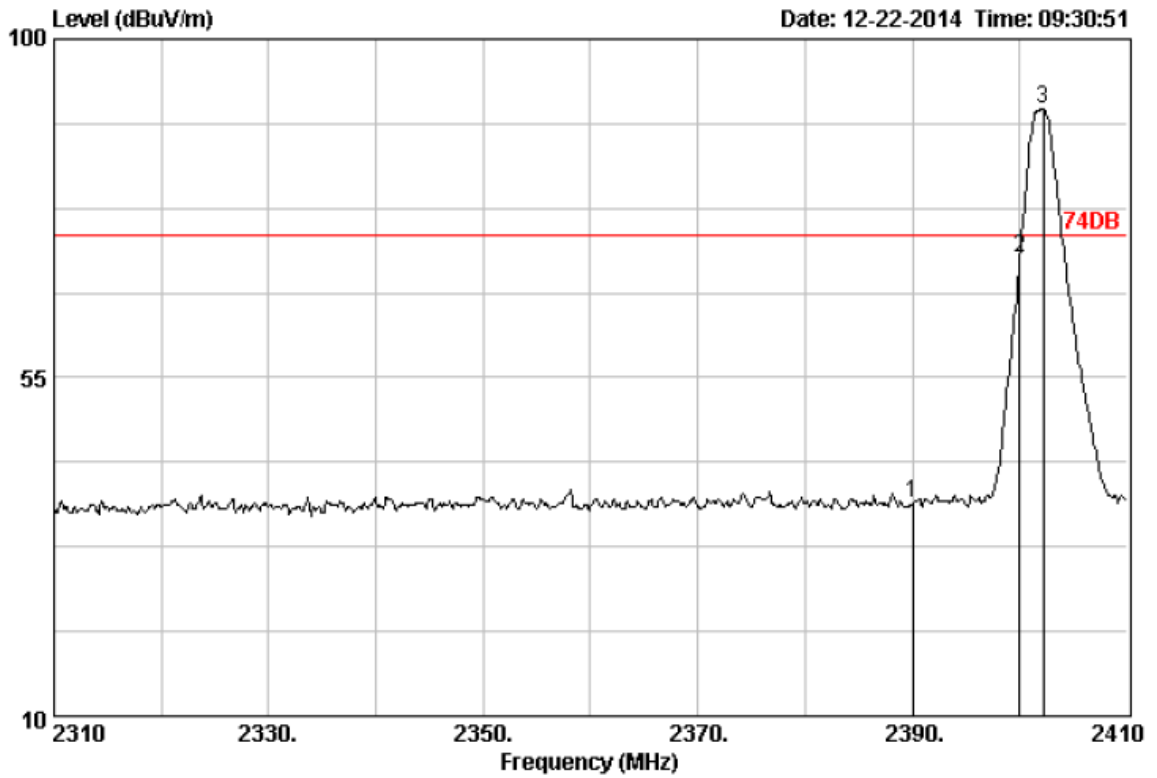

```

Site no.       : 3m Chamber
Dis. / Ant.   : 3m DRH-118
Limit         : 74DB
Env. / Ins.   : 23*C/54%
Engineer      :
EUT           :
Power         :
M/N           :
Test Mode     :
Data no.      : 1269
Ant. pol.     : HORIZONTAL
    
```

	Freq. (MHz)	Ant. Factor (dB)	Cable Loss (dB)	Reading (dBUV)	Emission			Remark
					Level (dBUV/m)	Limits (dBUV/m)	Margin (dB)	
1	2390.00	28.78	4.61	40.26	38.29	74.00	35.71	Peak
2	2400.00	28.78	4.61	72.81	70.84	74.00	3.16	Peak
3	2402.20	28.78	4.61	92.79	90.82	74.00	-16.82	Peak

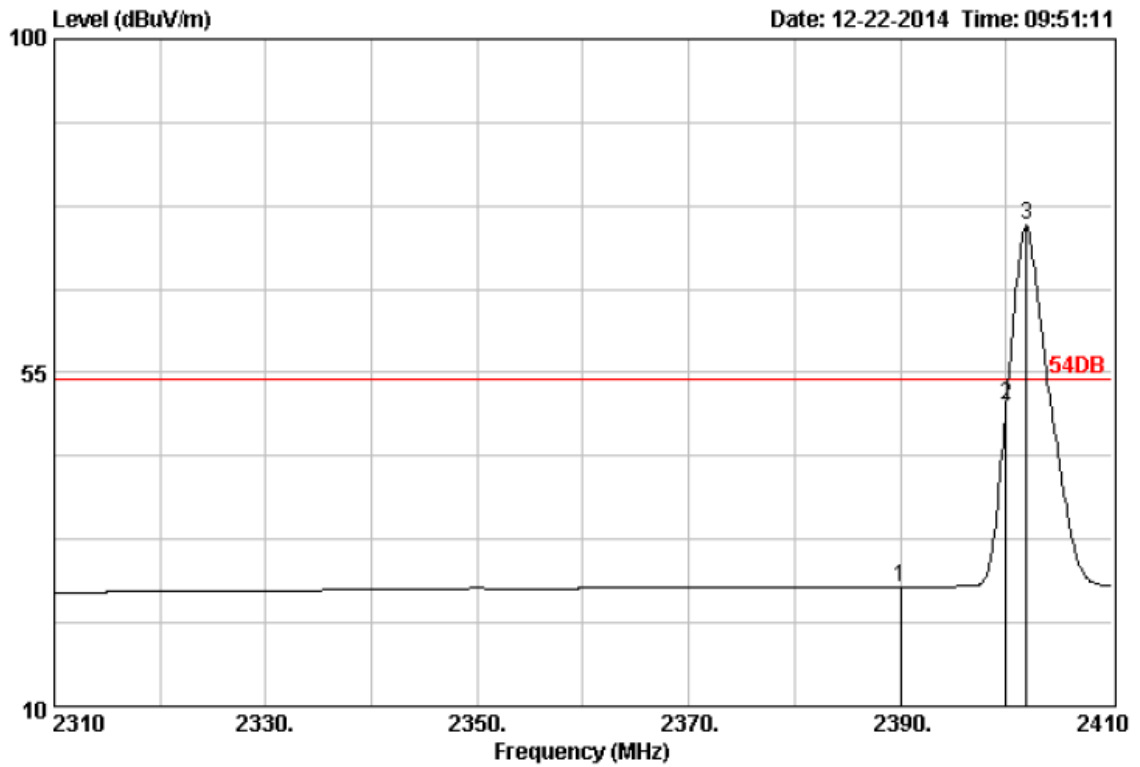

Site no. : 3m Chamber Data no. : 1274  
 Dis. / Ant. : 3m DRH-118 Ant. pol. : HORIZONTAL  
 Limit : 54DB  
 Env. / Ins. : 23\*C/54%  
 Engineer :  
 EUT :  
 Power :  
 M/N :  
 Test Mode :

	Freq. (MHz)	Ant. Factor (dB)	Cable Loss (dB)	Emission				Remark
				Reading (dBuV)	Level (dBuV/m)	Limits (dBuV/m)	Margin (dB)	
1	2390.00	28.78	4.61	28.10	26.13	54.00	27.87	Average
2	2400.00	28.78	4.61	52.46	50.49	54.00	3.51	Average
3	2401.90	28.78	4.61	76.84	74.87	54.00	-20.87	Average

Operation Mode: TX on Bot Channel

Polarity: Ver.

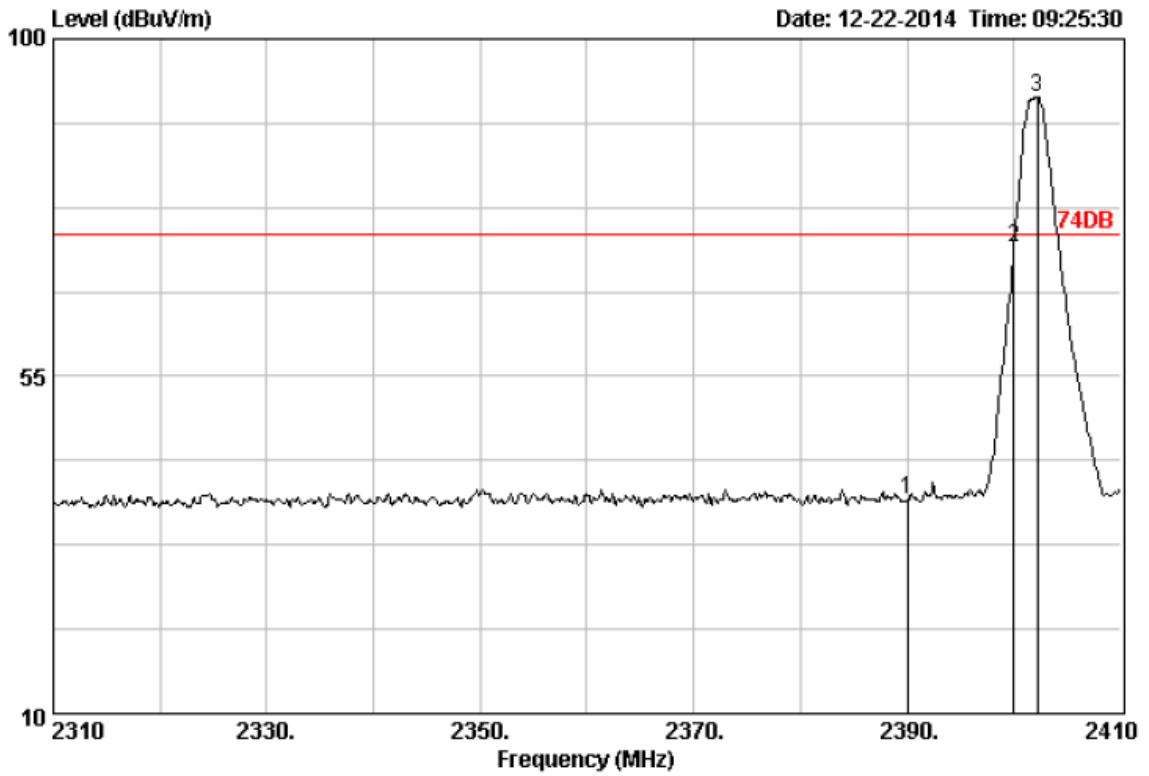

```

Site no.      : 3m Chamber
Dis. / Ant.  : 3m DRH-118
Limit        : 74DB
Env. / Ins.  : 23*C/54%
Engineer     :
EUT         :
Power       :
M/N        :
Test Mode   :
Data no.    : 1268
Ant. pol.   : VERTICAL
    
```

	Freq. (MHz)	Ant. Factor (dB)	Cable Loss (dB)	Reading (dBuV)	Emission		Margin (dB)	Remark
					Level (dBuV/m)	Limits (dBuV/m)		
1	2390.00	28.78	4.61	40.44	38.47	74.00	35.53	Peak
2	2400.00	28.78	4.61	74.14	72.17	74.00	1.83	Peak
3	2402.20	28.78	4.61	94.31	92.34	74.00	-18.34	Peak



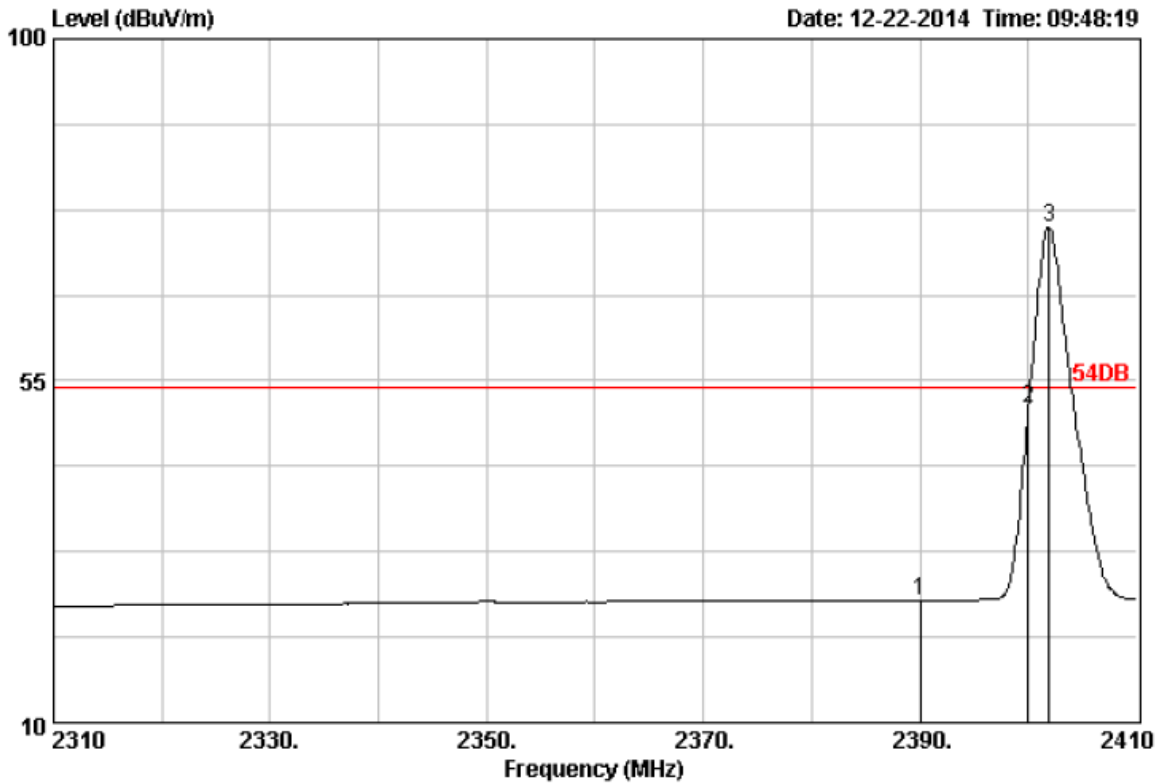

Site no. : 3m Chamber Data no. : 1273  
 Dis. / Ant. : 3m DRH-118 Ant. pol. : VERTICAL  
 Limit : 54DB  
 Env. / Ins. : 23\*C/54%  
 Engineer :  
 EUT :  
 Power :  
 M/N :  
 Test Mode :

	Freq. (MHz)	Ant. Factor (dB)	Cable Loss (dB)	Reading (dBuV)	Emission			Remark
					Level (dBuV/m)	Limits (dBuV/m)	Margin (dB)	
1	2390.00	28.78	4.61	28.10	26.13	54.00	27.87	Average
2	2400.00	28.78	4.61	53.28	51.31	54.00	2.69	Average
3	2401.90	28.78	4.61	77.14	75.17	54.00	-21.17	Average

Note: The field strength of any emissions which appear outside of this band shall not exceed the general radiated emission limits in Section 15.209.

Operation Mode: TX on Top Channel

Polarity: Hor.

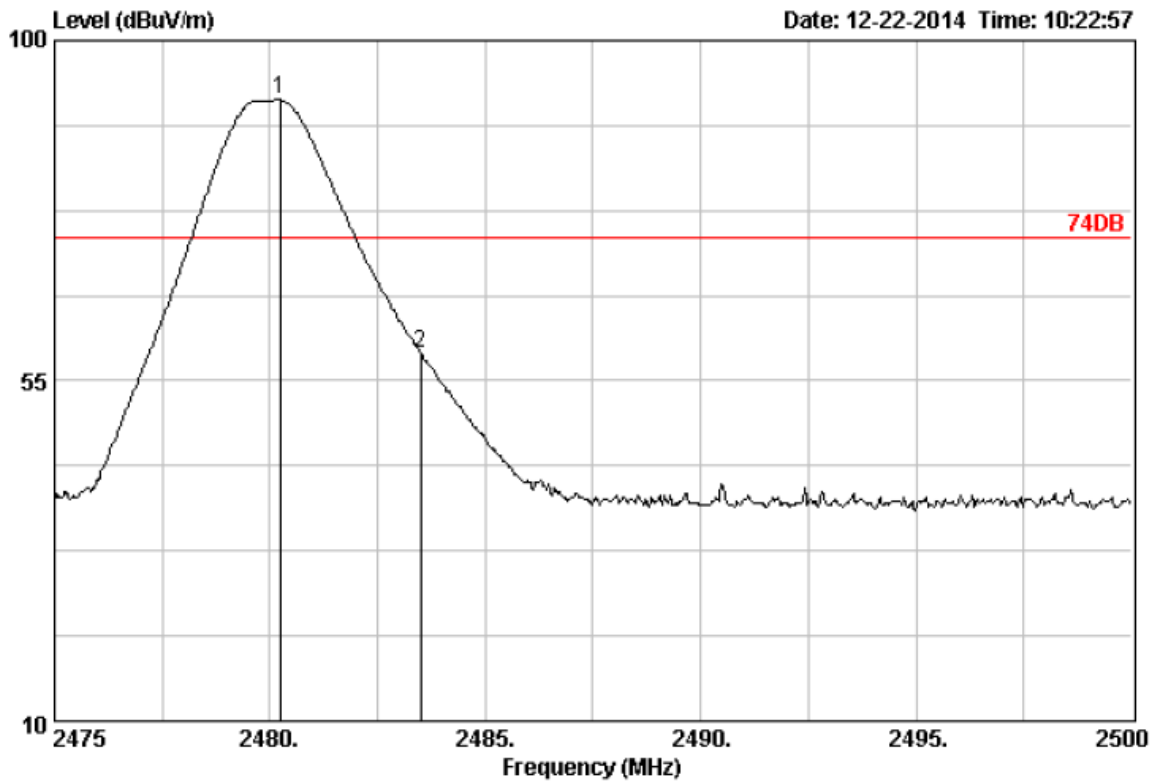

```

Site no.       : 3m Chamber                Data no. : 1282
Dis. / Ant.   : 3m DRH-118              Ant. pol. : HORIZONTAL
Limit        : 74DB
Env. / Ins.   : 23*C/54%
Engineer     :
EUT          :
Power        :
M/N         :
Test Mode    :
    
```

	Freq. (MHz)	Ant. Factor (dB)	Cable Loss (dB)	Reading (dBuV)	Emission			Remark
					Level (dBuV/m)	Limits (dBuV/m)	Margin (dB)	
1	2480.23	28.93	4.70	93.86	92.11	74.00	-18.11	Peak
2	2483.50	28.93	4.70	60.46	58.71	74.00	15.29	Peak

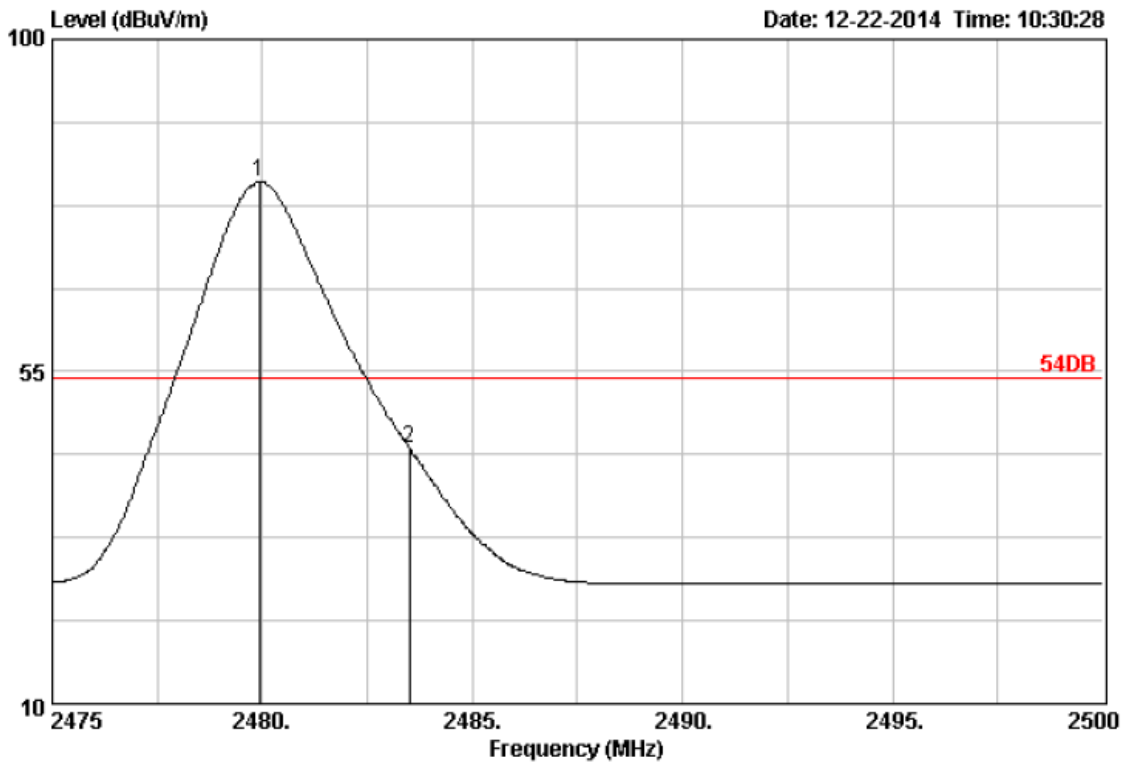

Site no. : 3m Chamber  
 Dis. / Ant. : 3m DRH-118  
 Limit : 54DB  
 Env. / Ins. : 23\*C/54%  
 Engineer :  
 EUT :  
 Power :  
 M/N :  
 Test Mode :

Data no. : 1284  
 Ant. pol. : HORIZONTAL

	Freq. (MHz)	Ant. Factor (dB)	Cable Loss (dB)	Reading (dBuV)	Emission Level (dBuV/m)	Limits (dBuV/m)	Margin (dB)	Remark
1	2479.93	28.93	4.70	82.48	80.73	54.00	-26.73	Average
2	2483.50	28.93	4.70	46.43	44.68	54.00	9.32	Average

Operation Mode: TX on Top Channel

Polarity: Ver.

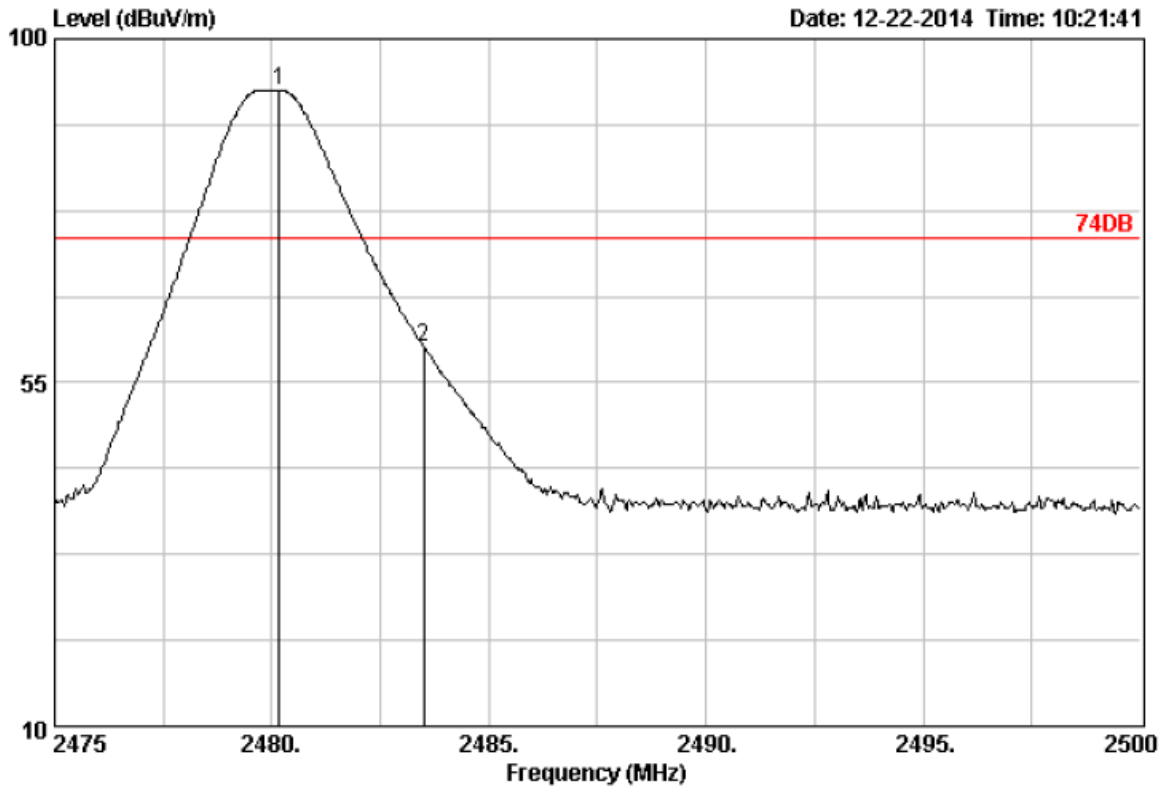

Site no. : 3m Chamber  
 Dis. / Ant. : 3m DRH-118  
 Limit : 74DB  
 Env. / Ins. : 23\*C/54%  
 Engineer :  
 EUT :  
 Power :  
 M/N :  
 Test Mode :

Data no. : 1281  
 Ant. pol. : VERTICAL

	Freq. (MHz)	Ant. Cable		Emission				Remark
		Factor (dB)	Loss (dB)	Reading (dBuV)	Level (dBuV/m)	Limits (dBuV/m)	Margin (dB)	
1	2480.18	28.93	4.70	95.01	93.26	74.00	-19.26	Peak
2	2483.50	28.93	4.70	61.40	59.65	74.00	14.35	Peak

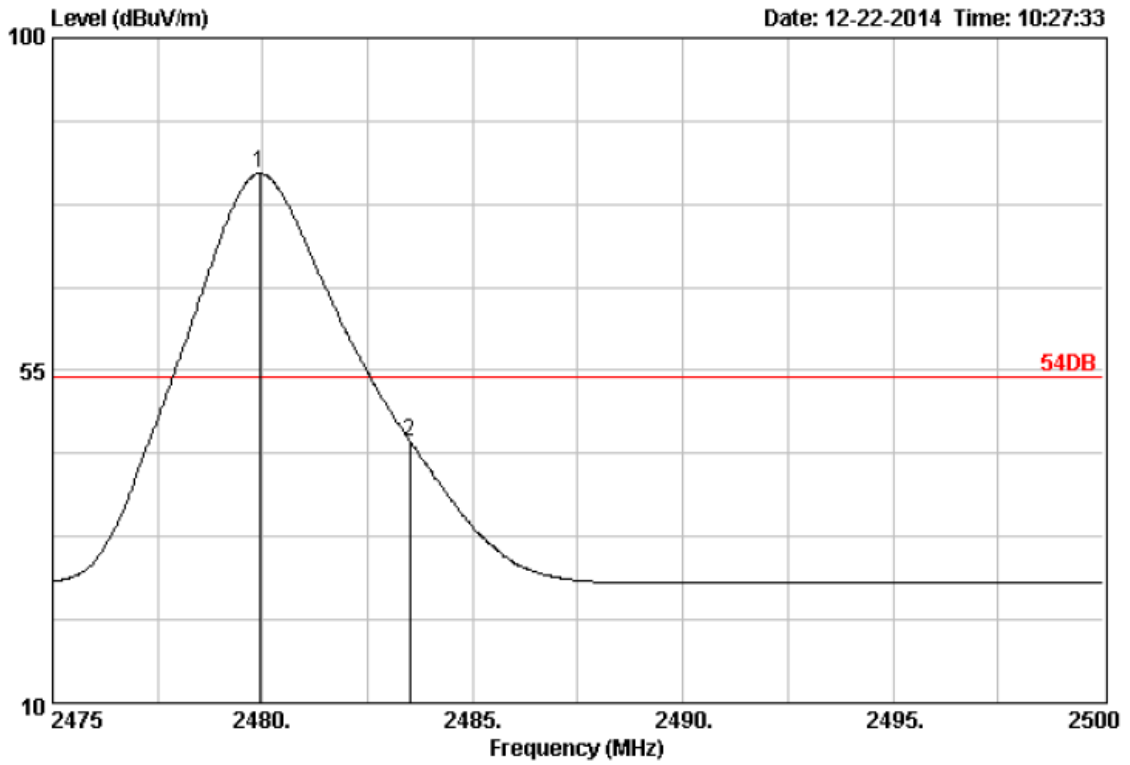

```

Site no.       : 3m Chamber
Dis. / Ant.   : 3m DRH-118
Limit         : 54DB
Env. / Ins.   : 23*C/54%
Engineer      :
EUT           :
Power         :
M/N           :
Test Mode     :
Data no.      : 1283
Ant. pol.     : VERTICAL
    
```

No.	Freq. (MHz)	Ant. Factor (dB)	Cable Loss (dB)	Reading (dBuV)	Emission			Remark
					Level (dBuV/m)	Limits (dBuV/m)	Margin (dB)	
1	2479.93	28.93	4.70	83.41	81.66	54.00	-27.66	Average
2	2483.50	28.93	4.70	47.16	45.41	54.00	8.59	Average

Note: The field strength of any emissions which appear outside of this band shall not exceed the general radiated emission limits in Section 15.209.

### 4.5. Occupied Bandwidth Measurement

#### Measurement Procedure

1. Set EUT as normal operation.
2. Based on Public Notice-DA 00-705:  $RBW \geq 1\%$  of the 20 dB bandwidth,  $VBW \geq RBW$ .
3. The useful radiated emission from the EUT was detected by the spectrum analyser with peak detector.

#### Test SET-UP (Block Diagram of Configuration)

Same as 4.2 Radiated Emission Measurement.

#### Measurement Equipment Used:

Same as 4.2 Radiated Emission Measurement.

#### Measurement Results

##### 2402MHz

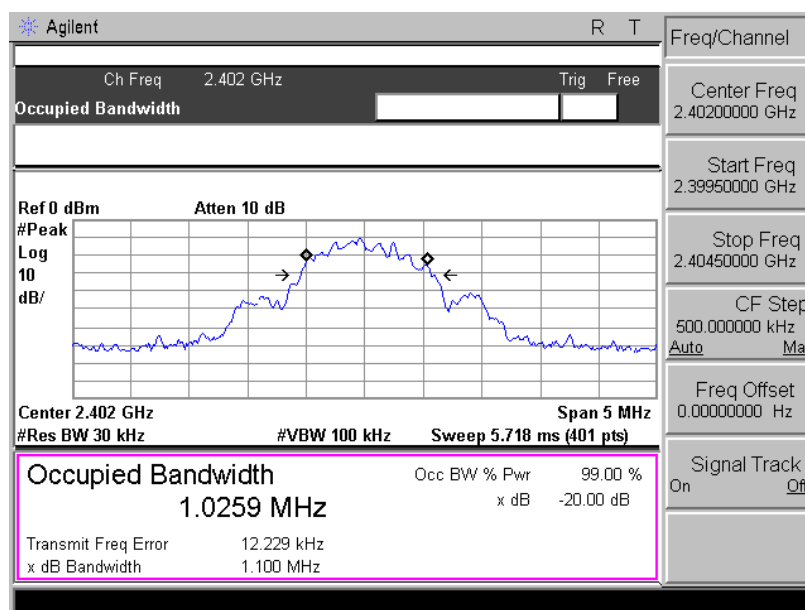

20dB Bandwidth: 1100KHz

##### 2440MHz

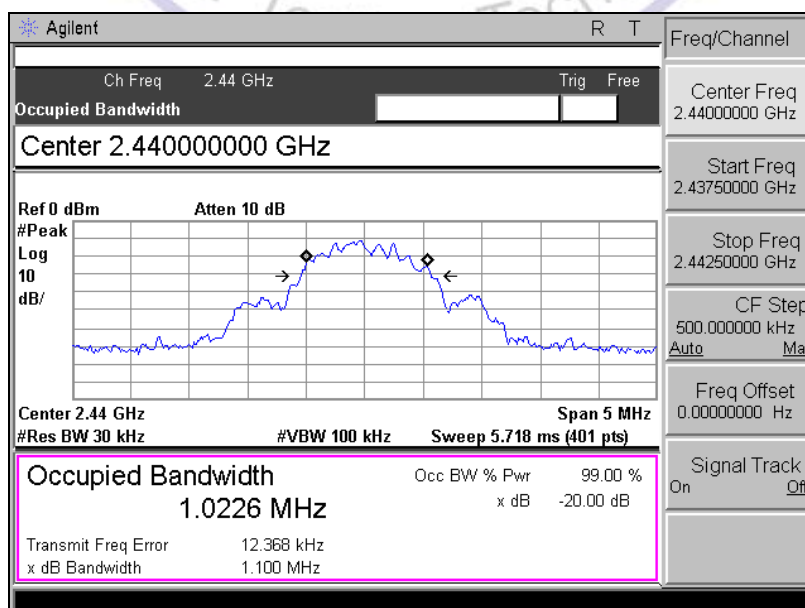

20dB Bandwidth: 1100KHz

2480MHz

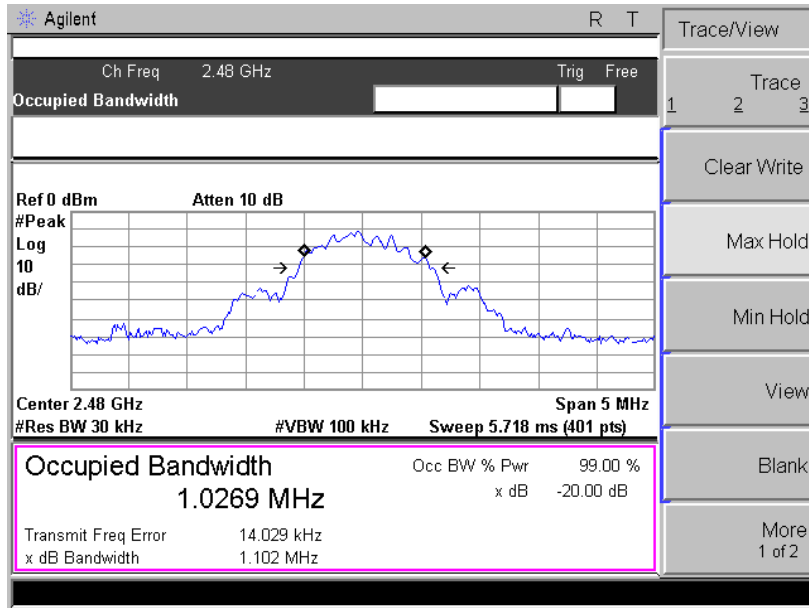

20dB Bandwidth: 1102KHz



## **5. Antenna Requirement**

### **Standard Applicable**

For intentional device, according to FCC 47 CFR Section 15.203, an intentional radiator shall be designed to ensure that no antenna other than that furnished by the responsible party shall be used with the device.

And according to FCC 47 CFR Section 15.247 (c), if transmitting antennas of directional gain greater than 6dBi are used, the power shall be reduced by the amount in dB that the directional gain of the antenna exceeds 6dBi.

### **Refer to statement below for compliance.**

The manufacturer may design the unit so that the user can replace a broken antenna, but the use of a standard antenna jack or electrical connector is prohibited. Further, this requirement does not apply to intentional radiators that must be professionally installed.

### **Antenna Connected Construction**

The antenna used in this product is an internal Antenna, The directional gains of antenna used for transmitting is 0 dBi.





## 6. Test Setup Photos of the EUT

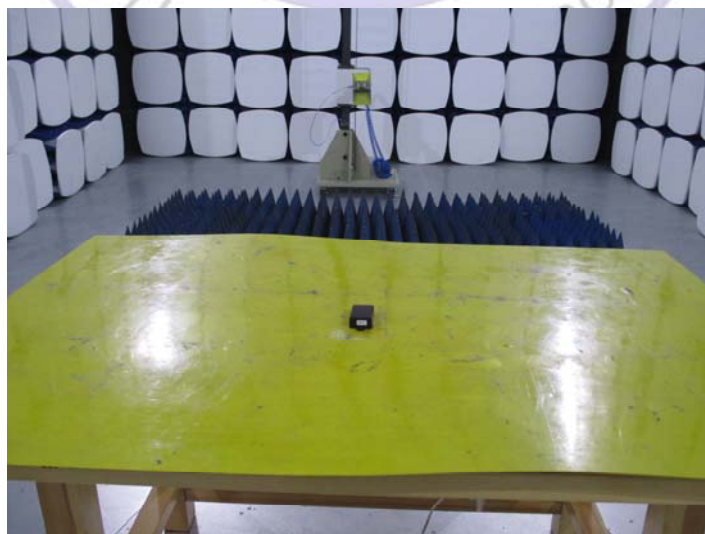
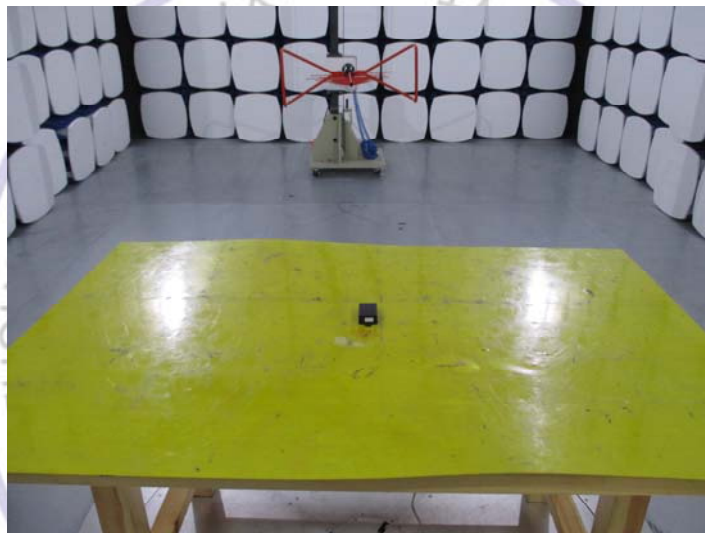
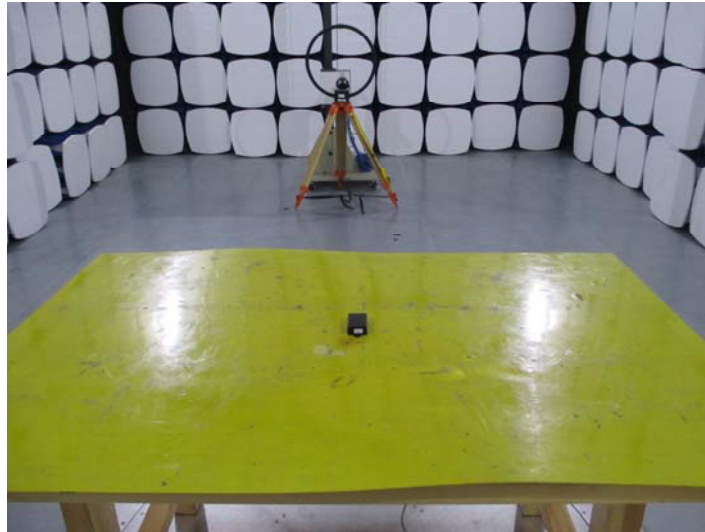

## 7. External and Internal Photos of the EUT

### External Photos of EUT

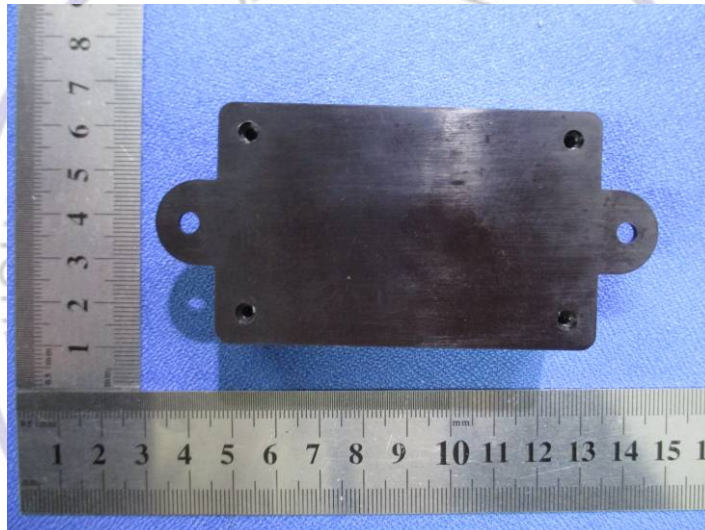
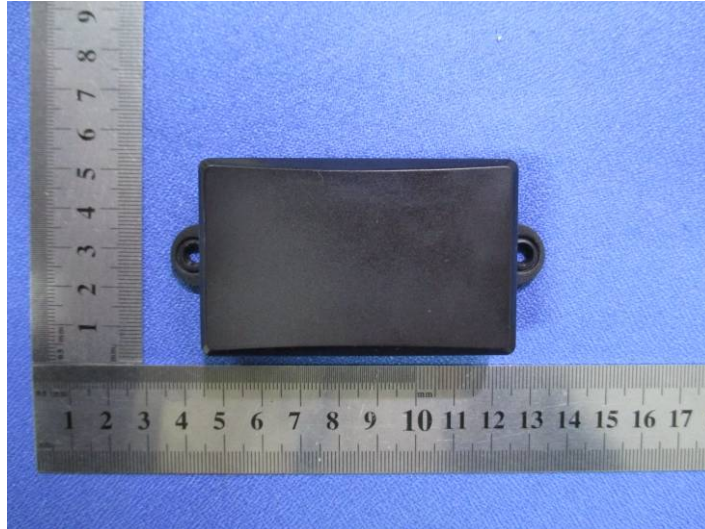



Internal Photos of EUT

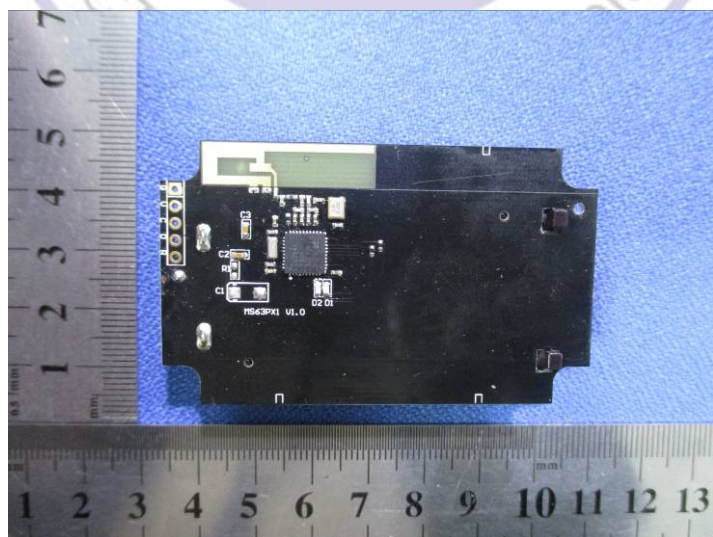

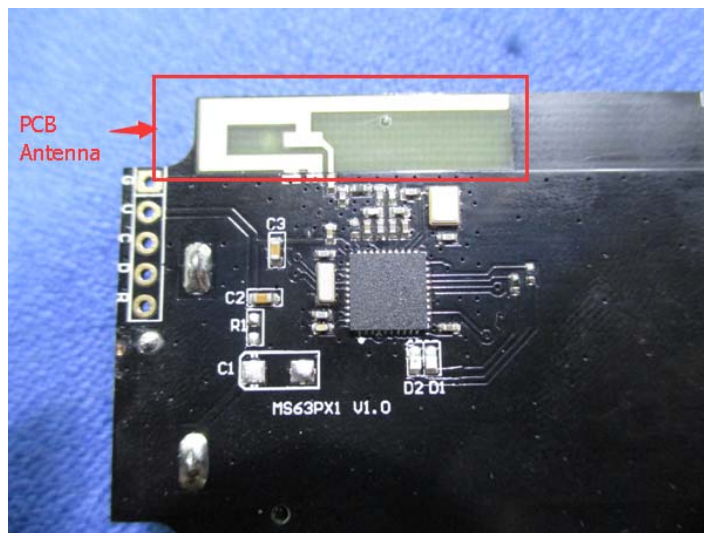

.....End of Report.....

