

部 品 规 格 书

部品名称

版 本

生效日期

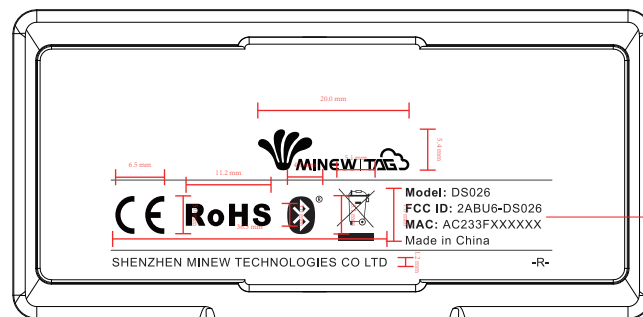

Arial 4.5pt

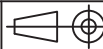
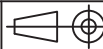
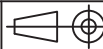
3					材 质		<table border="1"> <tr> <td colspan="2">未标公差</td> <td rowspan="5">  </td> <td rowspan="5">制 订</td> <td rowspan="5">审 核</td> <td rowspan="5">批 准</td> </tr> <tr> <td>L ≤ 4</td> <td>± 0.1</td> </tr> <tr> <td>4 < L ≤ 16</td> <td>± 0.12</td> </tr> <tr> <td>16 < L ≤ 63</td> <td>± 0.2</td> </tr> <tr> <td>63 < L ≤ 250</td> <td>± 0.4</td> </tr> <tr> <td>250 > L</td> <td>± 0.5</td> </tr> </table>	未标公差			制 订	审 核	批 准	L ≤ 4	± 0.1	4 < L ≤ 16	± 0.12	16 < L ≤ 63	± 0.2	63 < L ≤ 250	± 0.4	250 > L	± 0.5
未标公差			制 订	审 核	批 准																		
L ≤ 4	± 0.1																						
4 < L ≤ 16	± 0.12																						
16 < L ≤ 63	± 0.2																						
63 < L ≤ 250	± 0.4																						
250 > L	± 0.5																						
2				表 面 处 理		单 位: mm																	
1				颜 色		比 例: 1/1																	
NO.	年.月.日	版 本	变 更 记 录	签 名	部 品 料 号	年.月.日																	



部 品 规 格 书

部品名称
版 本
生效日期

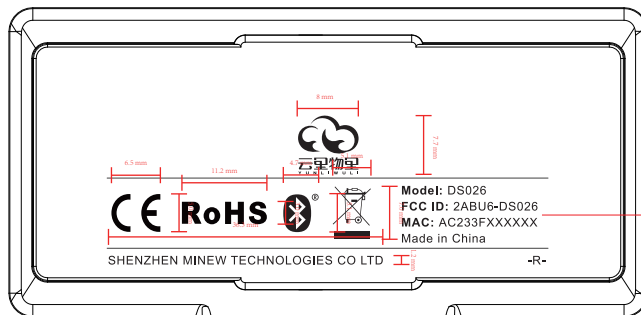

Arial 4.5pt

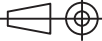
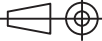
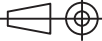
3					材 质		<table border="1"> <tr> <td colspan="2">未标公差</td> <td rowspan="5">  </td> <td rowspan="5">制 订</td> <td rowspan="5">审 核</td> <td rowspan="5">批 准</td> </tr> <tr> <td>L ≤ 4</td> <td>± 0.1</td> </tr> <tr> <td>4 < L ≤ 16</td> <td>± 0.12</td> </tr> <tr> <td>16 < L ≤ 63</td> <td>± 0.2</td> </tr> <tr> <td>63 < L ≤ 250</td> <td>± 0.4</td> </tr> <tr> <td>250 > L</td> <td>± 0.5</td> </tr> </table>	未标公差			制 订	审 核	批 准	L ≤ 4	± 0.1	4 < L ≤ 16	± 0.12	16 < L ≤ 63	± 0.2	63 < L ≤ 250	± 0.4	250 > L	± 0.5
未标公差			制 订	审 核	批 准																		
L ≤ 4	± 0.1																						
4 < L ≤ 16	± 0.12																						
16 < L ≤ 63	± 0.2																						
63 < L ≤ 250	± 0.4																						
250 > L	± 0.5																						
2				表面处理		单位：mm																	
1				颜 色		比例：1/1																	
NO.	年.月.日	版本	变 更 记 录	签 名	部品料号	年.月.日																	

