

TEST REPORT

Report No.: BCTC2209527128E

Applicant: SHENZHEN MINEW TECHNOLOGIES CO., LTD.

Product Name: AoA Locator

Model/Type Reference: AR1

Tested Date: 2022-08-28 to 2022-09-10

Issued Date: 2022-10-10



Shenzhen BCTC Testing Co., Ltd.



FCC ID: 2ABU6-AR1

Product Name: AoA Locator
Trademark: MINEW
Model/Type Ref.: AR1
Prepared For: SHENZHEN MINEW TECHNOLOGIES CO., LTD.
Address: 3rd Floor, I Building, Gangzhilong Science Park, Qinglong Road, Longhua District, Shenzhen City, China
Manufacturer: Shenzhen Minew Technologies Co.,Ltd.
Address: Building 3, Instrument World Industrial Park, No. 306, Guanlan Guiyue Road, Longhua District, Shenzhen
Prepared By: Shenzhen BCTC Technology Co., Ltd.
Address: 1-2/F., Building B, Pengzhou Industrial Park, No.158, Fuyuan 1st Road, Tangwei, Fuhai Subdistrict, Bao'an District, Shenzhen, Guangdong, China
Sample Received Date: 2022-08-28
Sample tested Date: 2022-08-28 to 2022-09-10
Report No.: BCTC2209527128E
Test Standards: FCC Part15.247
ANSI C63.10-2013
Test Results: PASS
Remark: This is Bluetooth BLE radio test report.

Tested by:

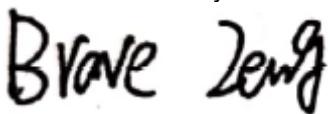

Brave Zeng/ Project Handler

Approved by:



Zero Zhou/Reviewer

The test report is effective only with both signature and specialized stamp. This result(s) shown in this report refer only to the sample(s) tested. Without written approval of Shenzhen BCTC Testing Co., Ltd, this report can't be reproduced except in full. The tested sample(s) and the sample information are provided by the client.

Table of Content

	Page
Test Report Declaration	
1. Version	5
2. Test Summary	6
3. Measurement Uncertainty	7
4. Product Information and Test Setup.....	8
4.1 Product Information.....	8
4.2 Test Setup Configuration	9
4.3 Support Equipment	9
4.4 Channel List.....	10
4.5 Test Mode	10
5. Test Facility and Test Instrument Used	11
5.1 Test Facility.....	11
5.2 Test Instrument Used.....	11
6. Conducted Emissions.....	13
6.1 Block Diagram Of Test Setup.....	13
6.2 Limit	13
6.3 Test procedure.....	13
6.4 EUT Operating Conditions	13
6.5 Test Result	14
7. Radiated Emissions.....	16
7.1 Block Diagram Of Test Setup.....	16
7.2 Limit	17
7.3 Test procedure.....	18
7.4 EUT operating Conditions	19
7.5 Test Result.....	20
8. Radiated Band Emission Measurement and Restricted Bands Of Operation.....	27
8.1 Block Diagram Of Test Setup.....	27
8.2 Limit	27
8.3 Test Procedure	28
8.4 EUT Operating Conditions	28
8.5 Test Result.....	29
9. Power Spectral Density Test	33
9.1 Block Diagram Of Test Setup.....	33
9.2 Limit	33
9.3 Test procedure.....	33
9.4 EUT Operating Conditions	33
9.5 Test Result.....	34
10. Bandwidth Test.....	39
10.1 Block Diagram Of Test Setup.....	39
10.2 Limit	39
10.3 Test procedure.....	39
10.4 EUT operating Conditions	39
10.5 Test Result.....	40
11. Peak Output Power Test	45
11.1 Block Diagram Of Test Setup.....	45
11.2 Limit	45

11.3	Test Procedure	45
11.4	EUT Operating Conditions	45
11.5	Test Result	45
12.	100 kHz Bandwidth Of Frequency Band Edge	46
12.1	Block Diagram Of Test Setup.....	46
12.2	Limit	46
12.3	Test procedure.....	46
12.4	EUT operating Conditions.....	46
12.5	Test Result.....	46
13.	Antenna Requirement	57
13.1	Limit	57
13.2	Test Result.....	57
14.	EUT Test Setup Photographs.....	58

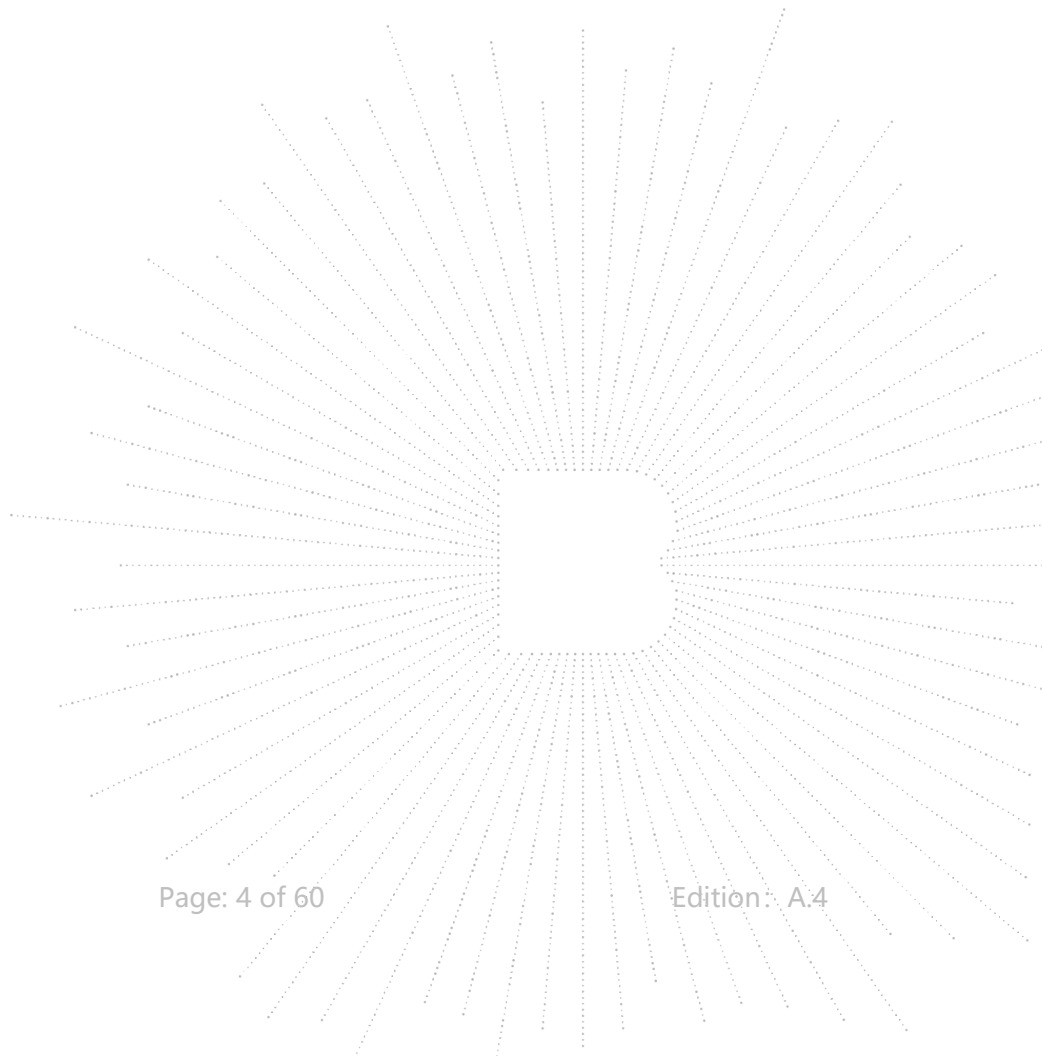

1. Version

Report No.	Issue Date	Description	Approved
BCTC2209527128E	2022-10-10	Original	Valid

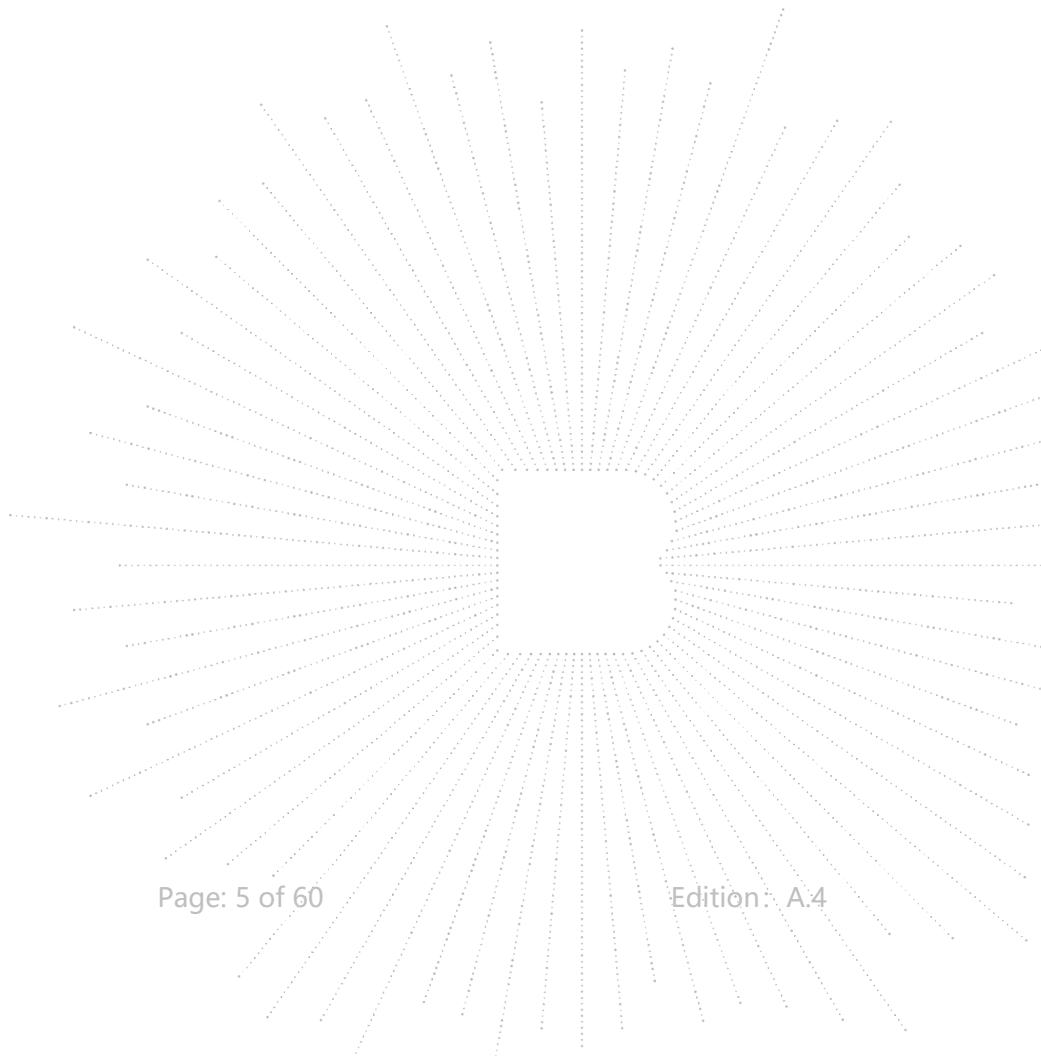

2. Test Summary

The Product has been tested according to the following specifications:

No.	Test Parameter	Clause No.	Results
1	Conducted Emission	15.207	PASS
2	6dB Bandwidth	15.247 (a)(2)	PASS
3	Peak Output Power	15.247 (b)	PASS
4	Radiated Spurious Emission	15.247 (d), 15.205	PASS
5	Power Spectral Density	15.247 (e)	PASS
6	Restricted Band of Operation	15.205	PASS
7	Band Edge (Out of Band Emissions)	15.247(d)	PASS
8	Antenna Requirement	15.203	PASS

NOTE1: According to FCC OET KDB 558074, the report use radiated measurements in the restricted frequency bands. In addition, the radiated test is also performed to ensure the emissions emanating from the device cabinet also comply with the applicable limits.

Remark:

N/A is an abbreviation for Not Applicable and means this test item is not applicable for this device according to the technology characteristic of device.

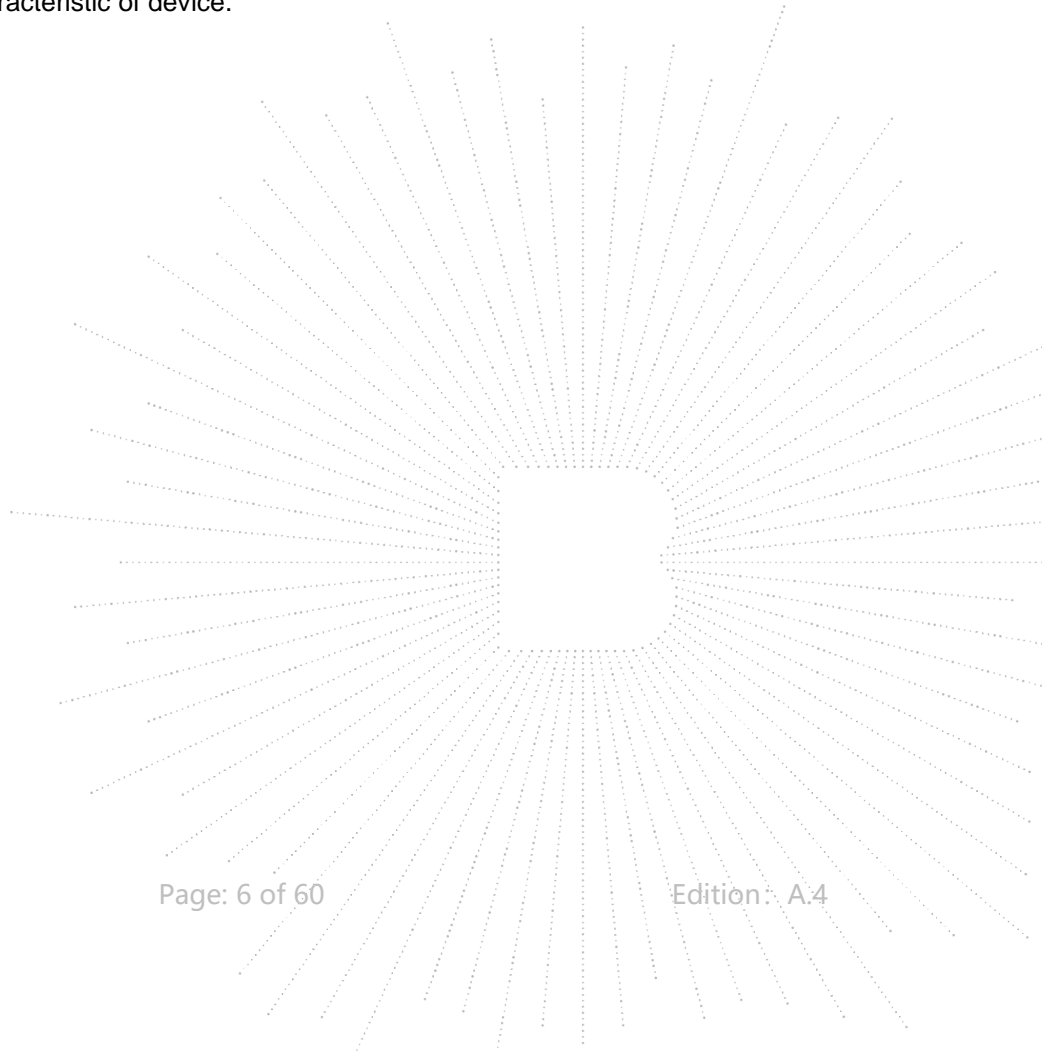

3. Measurement Uncertainty

Where relevant, the following measurement uncertainty levels have been estimated for tests performed on the Product as specified in CISPR 16-4-2. This uncertainty represents an expanded uncertainty expressed at approximately the 95% confidence level using a coverage factor of k=2.

No.	Item	Uncertainty
1	3m chamber Radiated spurious emission(30MHz-1GHz)	U=4.3dB
2	3m chamber Radiated spurious emission(9KHz-30MHz)	U=3.7dB
3	3m chamber Radiated spurious emission(1GHz-18GHz)	U=4.5dB
4	3m chamber Radiated spurious emission(18GHz-40GHz)	U=3.34dB
5	Conducted Emission (150kHz-30MHz)	U=3.20dB
6	Conducted Adjacent channel power	U=1.38dB
7	Conducted output power uncertainty Above 1G	U=1.576dB
8	Conducted output power uncertainty below 1G	U=1.28dB
9	humidity uncertainty	U=5.3%
10	Temperature uncertainty	U=0.59°C

4. Product Information and Test Setup

4.1 Product Information

Model/Type reference:	AR1
Model differences:	N/A
Bluetooth Version:	Bluetooth V5.0
Hardware Version:	N/A
Software Version:	N/A
Operation Frequency:	Bluetooth: 2402-2480MHz
Type of Modulation:	Bluetooth: GFSK
Number Of Channel:	40 channel
Maximum Conducted Output Power:	8.09 dBm
Antenna installation:	PCB antenna
Antenna Gain:	<p>ANT1: -4.89 dBi ANT2: -4.54 dBi ANT3: -3.65 dBi ANT4: -3.48 dBi ANT5: -2.69 dBi ANT6: -2.78 dBi ANT7: -2.89 dBi ANT8: -3.53 dBi ANT9: -2.62 dBi ANT10: -3.49 dBi ANT11: -3.63 dBi ANT12: -3.36 dBi</p> <p>The product consists of one primary switch + 4 secondary switches + 12 antenna groups. The primary switch controls 4 secondary switches, each secondary switch controls 3 antennas, and is controlled by the 4 GPIO levels of the microcontroller. The state of the first-level switch and the second-level switch, so as to select a certain antenna to transmit, and only one antenna can transmit at a time.</p>
Ratings:	DC5V

4.2 Test Setup Configuration

See test photographs attached in EUT test setup photographs for the actual connections between product and support equipment.

Conducted Emission / Radiated Spurious Emission:



4.3 Support Equipment

No.	Device Type	Brand	Model	Series No.	Note
E-1	AoA Locator	MINEW	AR1	N/A	EUT
E-2	AoA Gateway	MINEW	G2	N/A	N/A

Auxiliary Cable List and Details

Cable Description	Length (m)	Shielded/Unshielded	With / Without Ferrite
LAN Cable	1.5	Shielded	With Ferrite

Notes:

1. All the equipment/cables were placed in the worst-case configuration to maximize the emission during the test.
2. Grounding was established in accordance with the manufacturer's requirements and conditions for the intended use.

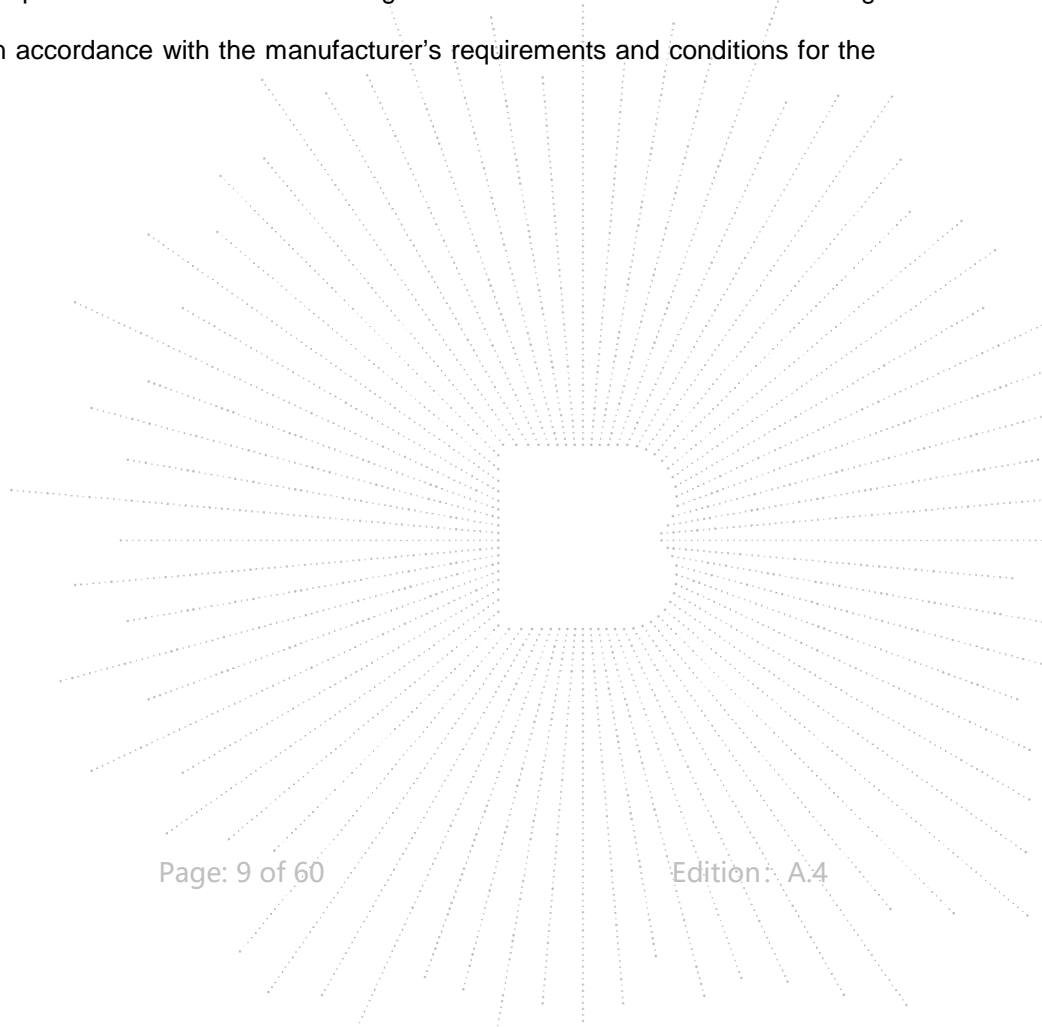

4.4 Channel List

Channel List					
Channel	Frequency (MHz)	Channel	Frequency (MHz)	Channel	Frequency (MHz)
01	2402	11	2422	21	2442
02	2404	12	2424	22	2444
03	2406	13	2426	23	2446
~	~	~	~	~	~
09	2418	19	2438	39	2478
10	2420	20	2440	40	2480

4.5 Test Mode

To investigate the maximum EMI emission characteristics generated from EUT, the test system was pre-scanning tested based on the consideration of following EUT operation mode or test configuration mode which possibly have effect on EMI emission level. Each of these EUT operation mode(s) or test configuration mode(s) mentioned above was evaluated respectively.

For All Mode	Description	Modulation Type
Mode 1	CH01	GFSK 1M
Mode 2	CH20	
Mode 3	CH40	
Mode 4	CH01	GFSK 2M
Mode 5	CH20	
Mode 6	CH40	
Mode 7	Link mode (Conducted emission and Radiated emission)	

Note:

(1) The measurements are performed at the highest, middle, lowest available channels.

5. Test Facility and Test Instrument Used

5.1 Test Facility

All measurement facilities used to collect the measurement data are located at Shenzhen BCTC Testing Co., Ltd. Address: 1-2/F., Building B, Pengzhou Industrial Park, No.158, Fuyuan 1st Road, Tangwei, Fuhai Subdistrict, Bao'an District, Shenzhen, Guangdong, China. The site and apparatus are constructed in conformance with the requirements of ANSI C63.4 and CISPR 16-1-1 other equivalent standards.

FCC Test Firm Registration Number: 712850

IC Registered No.: 23583

5.2 Test Instrument Used

Conducted Emissions Test					
Equipment	Manufacturer	Model#	Serial#	Last Cal.	Next Cal.
Receiver	R&S	ESR3	102075	May 24, 2022	May 23, 2023
LISN	R&S	ENV216	101375	May 24, 2022	May 23, 2023
Software	Frad	EZ-EMC	EMC-CON 3A1	\	\
Attenuator	\	10dB DC-6GHz	1650	May 24, 2022	May 23, 2023

RF Conducted Test					
Equipment	Manufacturer	Model#	Serial#	Last Cal.	Next Cal.
Power Metter	Keysight	E4419	\	May 24, 2022	May 23, 2023
Power Sensor (AV)	Keysight	E9300A	\	May 24, 2022	May 23, 2023
Signal Analyzer 20kHz-26.5G Hz	Keysight	N9020A	MY49100060	May 24, 2022	May 23, 2023
Spectrum Analyzer 9kHz-40GHz	R&S	FSP 40	\	May 24, 2022	May 23, 2023

Radiated Emissions Test (966 Chamber)					
Equipment	Manufacturer	Model#	Serial#	Last Cal.	Next Cal.
966 chamber	ChengYu	966 Room	966	Jun. 06. 2020	Jun. 05, 2023
Receiver	R&S	ESR3	102075	May 24, 2022	May 23, 2023
Receiver	R&S	ESRP	101154	May 24, 2022	May 23, 2023
Amplifier	SKET	LAPA_01G18 G-45dB	\	May 24, 2022	May 23, 2023
Amplifier	Schwarzbeck	BBV9744	9744-0037	May 24, 2022	May 23, 2023
TRILOG Broadband Antenna	Schwarzbeck	VULB9163	942	May 26, 2022	May 25, 2023
Horn Antenna	Schwarzbeck	BBHA9120D	1541	May 24, 2022	May 23, 2023
Horn Antenn (18GHz-40GHz)	Schwarzbeck	BBHA9170	00822	Jun. 15, 2021	May 23, 2023
Amplifier (18GHz-40GHz)	MITEQ	TTA1840-35- HG	2034381	May 26, 2022	May 25, 2023
Loop Antenna (9kHz-30MHz)	Schwarzbeck	FMZB1519B	00014	May 26, 2022	May 25, 2023
RF cables1 (9kHz-30MHz)	Huber+Suhnar	9kHz-30MHz	B1702988-000 8	May 26, 2022	May 25, 2023
RF cables2 (30MHz-1GHz)	Huber+Suhnar	30MHz-1GHz	1486150	May 26, 2022	May 25, 2023
RF cables3 (1GHz-40GHz)	Huber+Suhnar	1GHz-40GHz	1607106	May 28, 2021	May 25, 2023
Power Metter	Keysight	E4419	\	May 26, 2022	May 25, 2023
Power Sensor (AV)	Keysight	E9300A	\	May 26, 2022	May 25, 2023
Signal Analyzer 20kHz-26.5G Hz	Keysight	N9020A	MY49100060	May 26, 2022	May 25, 2023
Spectrum Analyzer 9kHz-40GHz	R&S	FSP 40	\	May 26, 2022	May 25, 2023
Software	Frad	EZ-EMC	FA-03A2 RE	\	\

6. Conducted Emissions

6.1 Block Diagram Of Test Setup

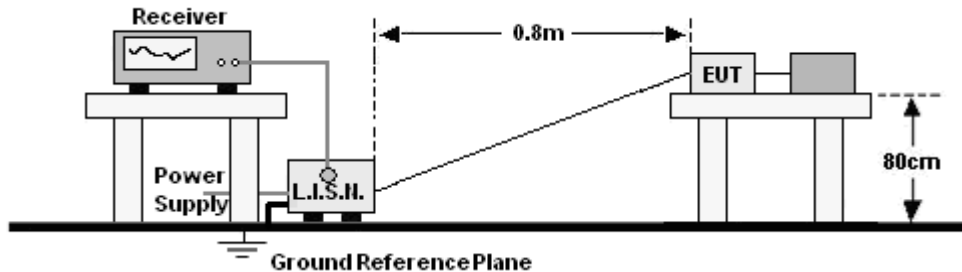

6.2 Limit

Frequency (MHz)	Limit (dBuV)	
	Quas-peak	Average
0.15 -0.5	66 - 56 *	56 - 46 *
0.50 -5.0	56.00	46.00
5.0 -30.0	60.00	50.00

Notes:
 1. *Decreasing linearly with logarithm of frequency.
 2. The lower limit shall apply at the transition frequencies.

6.3 Test procedure

Receiver Parameters	Setting
Attenuation	10 dB
Start Frequency	0.15 MHz
Stop Frequency	30 MHz
IF Bandwidth	9 kHz

- The Product was placed on a nonconductive table 0.8 m above the horizontal ground reference plane, and 0.4 m from the vertical ground reference plane, and connected to the main through Line Impedance Stabilization Network (L.I.S.N).
- The RBW of the receiver was set at 9 kHz in 150 kHz ~ 30MHz with Peak and AVG detector in Max Hold mode. Run the receiver's pre-scan to record the maximum disturbance generated from Product in all power lines in the full band.
- For each frequency whose maximum record was higher or close to limit, measure its QP and AVG values and record.

6.4 EUT Operating Conditions

The EUT was configured for testing in a typical fashion (as a customer would normally use it). The EUT has been programmed to continuously transmit during test. This operating condition was tested and used to collect the included data.

6.5 Test Result

Temperature:	26 °C	Relative Humidity:	54%
Pressure:	101KPa	Test Voltage :	AC120V/60Hz
Test Mode:	Mode 7	Polarization :	L

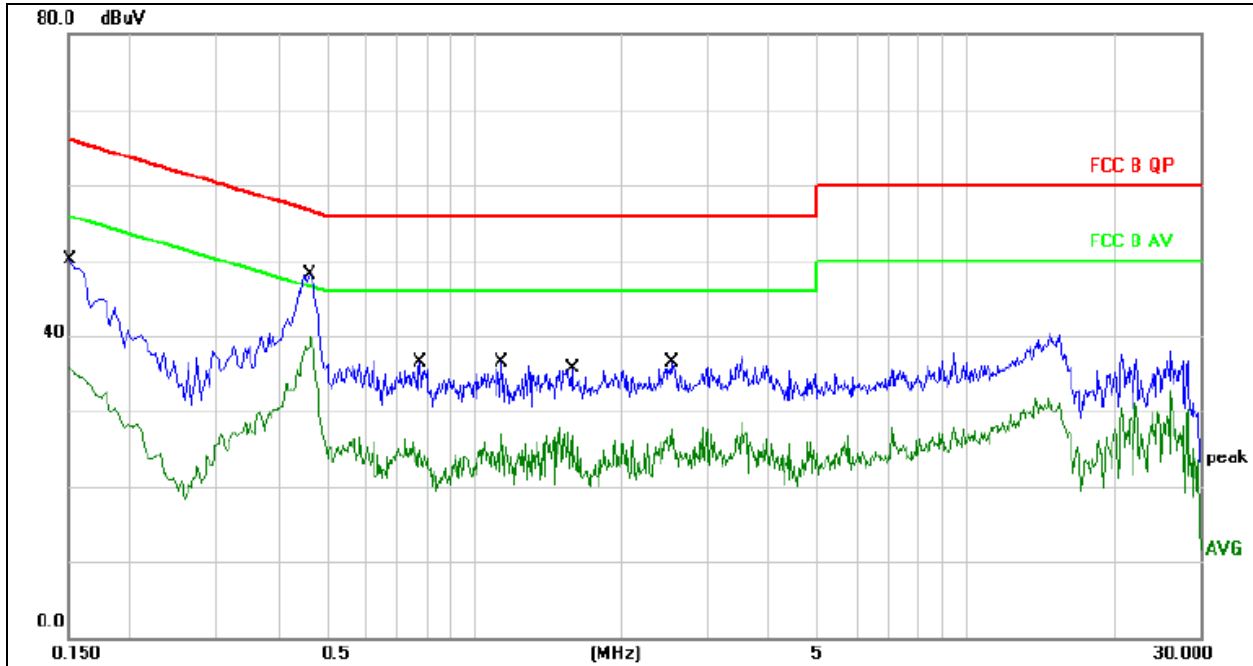

Remark:

1. All readings are Quasi-Peak and Average values.
2. Factor = Insertion Loss + Cable Loss.
3. Measurement = Reading Level + Correct Factor
4. Over = Measurement - Limit

No. Mk.	Freq. MHz	Reading Level dBuV	Correct Factor dB	Measure- ment dBuV	Limit dBuV	Over dB	Detector	Comment
1	0.1500	40.18	9.96	50.14	65.99	-15.85	QP	
2	0.1500	26.04	9.96	36.00	55.99	-19.99	AVG	
3	0.4620	38.08	10.10	48.18	56.66	-8.48	QP	
4 *	0.4620	29.72	10.10	39.82	46.66	-6.84	AVG	
5	0.7780	26.35	10.14	36.49	56.00	-19.51	QP	
6	0.7780	16.20	10.14	26.34	46.00	-19.66	AVG	
7	1.1380	26.43	10.12	36.55	56.00	-19.45	QP	
8	1.1380	16.76	10.12	26.88	46.00	-19.12	AVG	
9	1.5820	25.54	10.18	35.72	56.00	-20.28	QP	
10	1.5820	17.70	10.18	27.88	46.00	-18.12	AVG	
11	2.5180	26.18	10.33	36.51	56.00	-19.49	QP	
12	2.5180	17.44	10.33	27.77	46.00	-18.23	AVG	

Temperature:	26 °C	Relative Humidity:	54%
Pressure:	101KPa	Test Voltage :	AC120V/60Hz
Test Mode:	Mode 7	Polarization :	N

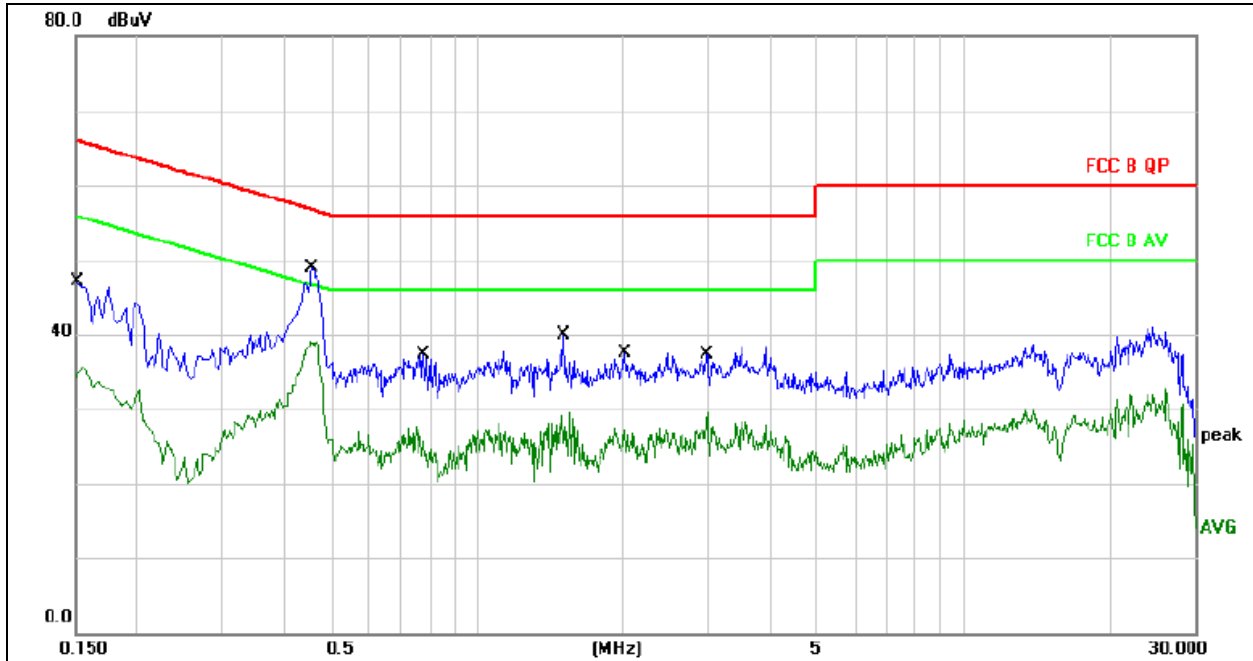
Remark:

1. All readings are Quasi-Peak and Average values.
2. Factor = Insertion Loss + Cable Loss.
3. Measurement = Reading Level + Correct Factor
4. Over = Measurement - Limit

No. Mk.	Freq. MHz	Reading Level dBuV	Correct Factor dB	Measure- ment dBuV	Limit dBuV	Over dB	Detector	Comment
1	0.1500	37.07	9.96	47.03	65.99	-18.96	QP	
2	0.1500	25.63	9.96	35.59	55.99	-20.40	AVG	
3	0.4580	38.84	10.09	48.93	56.73	-7.80	QP	
4 *	0.4580	29.06	10.09	39.15	46.73	-7.58	AVG	
5	0.7780	27.19	10.14	37.33	56.00	-18.67	QP	
6	0.7780	17.48	10.14	27.62	46.00	-18.38	AVG	
7	1.5060	29.69	10.17	39.86	56.00	-16.14	QP	
8	1.5060	19.42	10.17	29.59	46.00	-16.41	AVG	
9	2.0220	27.33	10.23	37.56	56.00	-18.44	QP	
10	2.0220	17.29	10.23	27.52	46.00	-18.48	AVG	
11	2.9739	26.97	10.42	37.39	56.00	-18.61	QP	
12	2.9739	19.05	10.42	29.47	46.00	-16.53	AVG	

7. Radiated Emissions

7.1 Block Diagram Of Test Setup

(A) Radiated Emission Test-Up Frequency Below 30MHz

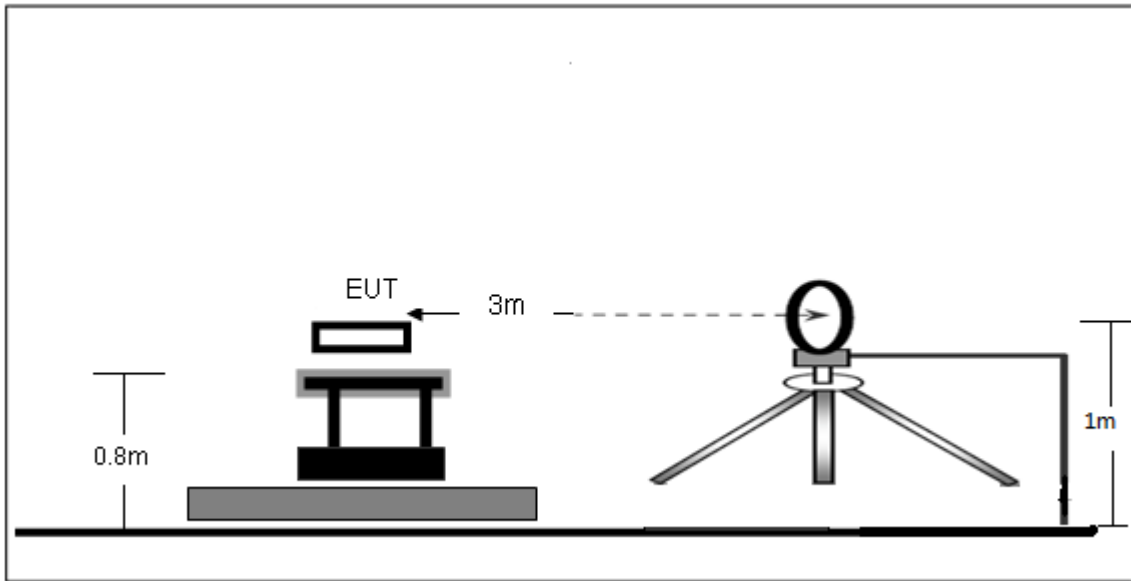

(B) Radiated Emission Test-Up Frequency 30MHz~1GHz

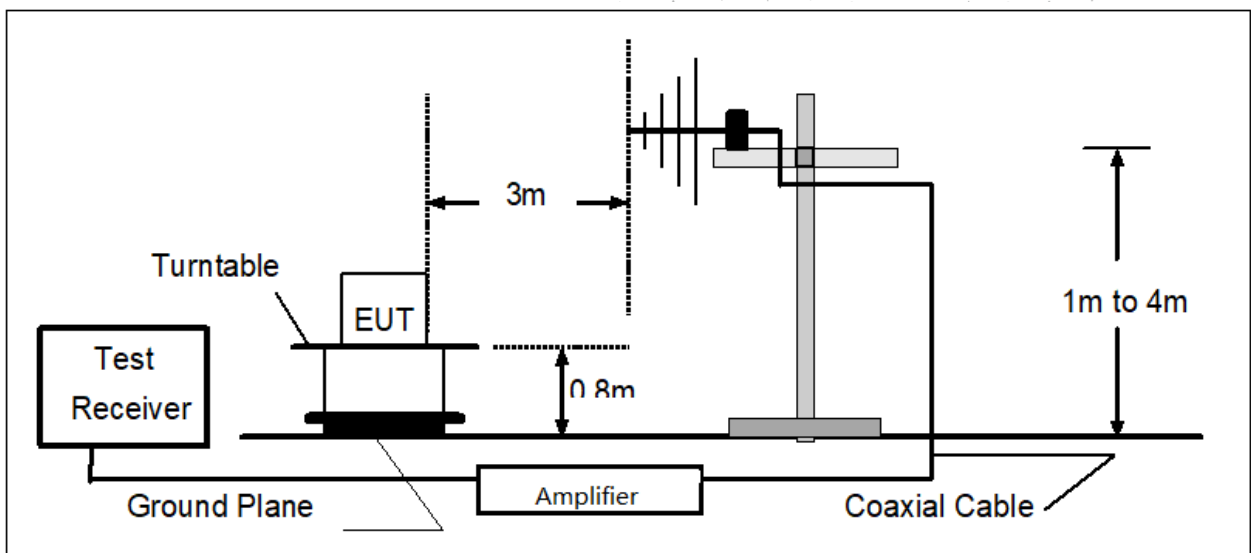

(C) Radiated Emission Test-Up Frequency Above 1GHz

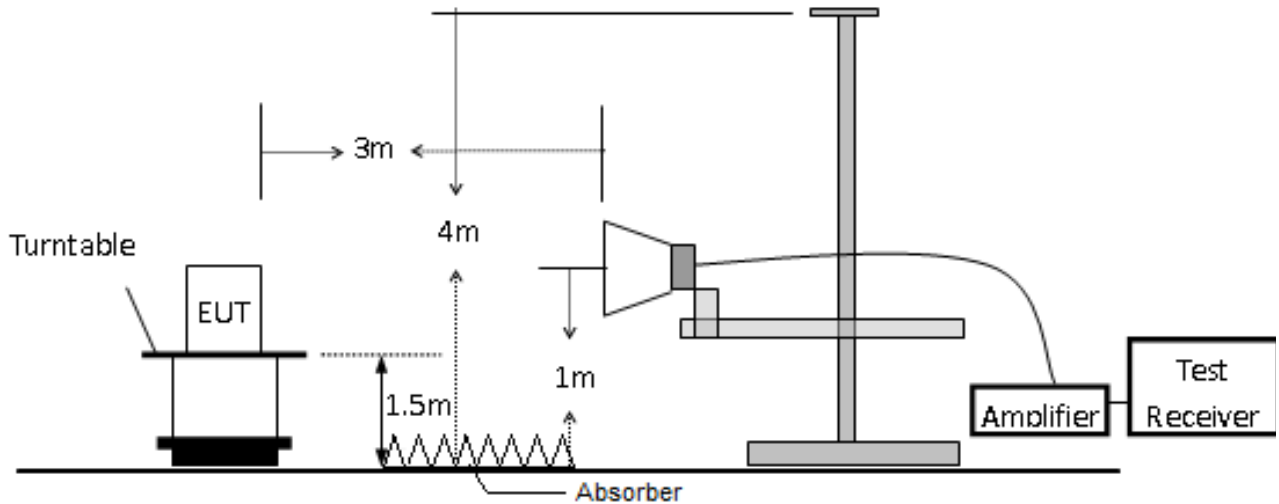

7.2 Limit

20dBc in any 100 kHz bandwidth outside the operating frequency band. In case the emission fall within the restricted band specified on 15.205(a), then the 15.209(a) limit in the table below has to be followed.

Frequency (MHz)	Field Strength uV/m	Distance (m)	Field Strength Limit at 3m Distance	
			uV/m	dBuV/m
0.009 ~ 0.490	2400/F(kHz)	300	10000 * 2400/F(kHz)	$20\log^{(2400/F(kHz))} + 80$
0.490 ~ 1.705	24000/F(kHz)	30	100 * 24000/F(kHz)	$20\log^{(24000/F(kHz))} + 40$
1.705 ~ 30	30	30	100 * 30	$20\log^{(30)} + 40$
30 ~ 88	100	3	100	$20\log^{(100)}$
88 ~ 216	150	3	150	$20\log^{(150)}$
216 ~ 960	200	3	200	$20\log^{(200)}$
Above 960	500	3	500	$20\log^{(500)}$

Limits Of Radiated Emission Measurement (Above 1000MHz)

Frequency (MHz)	Limit (dBuV/m) (at 3M)	
	Peak	Average
Above 1000	74	54

Notes:

- (1) The limit for radiated test was performed according to FCC PART 15C.
 - (2) The tighter limit applies at the band edges.
 - (3) Emission level (dBuV/m) = $20\log$ Emission level (uV/m).
- Frequency Range Of Radiated Measurement

(a) For an intentional radiator the spectrum shall be investigated from the lowest radio frequency signal generated in the device, without going below 9 kHz, up to at least the frequency shown in this paragraph:

(1) If the intentional radiator operates below 10 GHz: to the tenth harmonic of the highest fundamental frequency or to 40 GHz, whichever is lower.

(2) If the intentional radiator operates at or above 10 GHz and below 30 GHz: to the fifth harmonic of the highest fundamental frequency or to 100 GHz, whichever is lower.

(3) If the intentional radiator operates at or above 30 GHz: to the fifth harmonic of the highest fundamental frequency or to 200 GHz, whichever is lower, unless specified otherwise elsewhere in the rules.

(4) If the intentional radiator operates at or above 95 GHz: To the third harmonic of the highest fundamental frequency or to 750 GHz, whichever is lower, unless specified otherwise elsewhere in the rules.

(5) If the intentional radiator contains a digital device, regardless of whether this digital device controls the functions of the intentional radiator or the digital device is used for additional control or function purposes other than to enable the operation of the intentional radiator, the frequency range shall be investigated up to the range specified in paragraphs (a) (1) through (4) of this section or the range applicable to the digital device, as shown in paragraph (b)(1) of this section, whichever is the higher frequency range of investigation.

7.3 Test procedure

Receiver Parameter	Setting
Attenuation	Auto
9kHz~150kHz	RBW 200Hz for QP
150kHz~30MHz	RBW 9kHz for QP
30MHz~1000MHz	RBW 120kHz for QP

Spectrum Parameter	Setting
1-25GHz	RBW 1 MHz /VBW 1 MHz for Peak, RBW 1 MHz / VBW 10Hz for Average

Below 1GHz test procedure as below:

- a. The EUT was placed on the top of a rotating table 0.8 meters above the ground at a 3 meter semi-anechoic chamber. The table was rotated 360 degrees to determine the position of the highest radiation.
- b. The EUT was set 3 meters away from the interference-receiving antenna, which was mounted on the top of a variable-height antenna tower.
- c. The antenna height is varied from one meter to four meters above the ground to determine the maximum value of the field strength. Both horizontal and vertical polarizations of the antenna are set to make the measurement.
- d. For each suspected emission, the EUT was arranged to its worst case and then the antenna was tuned to heights from 1 meter to 4 meters (for the test frequency of below 30MHz, the antenna was tuned to heights 1 meter) and the rotatable table was turned from 0 degrees to 360 degrees to find the maximum reading.
- e. The test-receiver system was set to Peak Detect Function and Specified Bandwidth with Maximum Hold Mode.
- f. If the emission level of the EUT in peak mode was 10dB lower than the limit specified, then testing could be stopped and the peak values of the EUT would be reported. Otherwise the emissions that did not

have 10dB margin would be re-tested one by one using peak, quasi-peak or average method as specified and then reported in a data sheet.

Above 1GHz test procedure as below:

- a. The EUT was placed on the top of a rotating table 1.5 meters above the ground at a 3 meter camber. The table was rotated 360 degrees to determine the position of the highest radiation.
- b. The EUT was set 3 meters away from the interference-receiving antenna, which was mounted on the top of a variable-height antenna tower.
- c. The antenna height is varied from one meter to four meters above the ground to determine the maximum value of the field strength. Both horizontal and vertical polarizations of the antenna are set to make the measurement.
- d. For each suspected emission, the EUT was arranged to its worst case and then the antenna was tuned to heights from 1 meter to 4 meters and the rota table was turned from 0 degrees to 360 degrees to find the maximum reading.
- e. The test-receiver system was set to Peak Detect Function and Specified Bandwidth with Maximum Hold Mode.
- f. If the emission level of the EUT in peak mode was 10dB lower than the limit specified, then testing could be stopped and the peak values of the EUT would be reported. Otherwise the emissions that did not have 10dB margin would be re-tested one by one using peak, quasi-peak or average method as specified and then reported in a data sheet.
- g. Test the EUT in the lowest channel, the middlest channel, the Highest channel.

Note:

Both horizontal and vertical antenna polarities were tested and performed pretest to three orthogonal axis. The worst case emissions were reported.

7.4 EUT operating Conditions

The EUT was configured for testing in a typical fashion (as a customer would normally use it). The EUT has been programmed to continuously transmit during test. This operating condition was tested and used to collect the included data.

7.5 Test Result

Below 30MHz

Temperature:	26 °C	Relative Humidity:	54%
Pressure:	101KPa	Test Voltage :	AC120V/60Hz
Test Mode:	Mode 7		

Freq. (MHz)	Reading (dBuV/m)	Limit (dBuV/m)	Margin (dB)	State P/F
--	--	--	--	PASS
--	--	--	--	PASS

Note:

The amplitude of spurious emissions which are attenuated by more than 20dB below the permissible value has no need to be reported.

Distance extrapolation factor = $40 \log(\text{specific distance}/\text{test distance})$ (dB);

Limit line = specific limits(dBuv) + distance extrapolation factor.

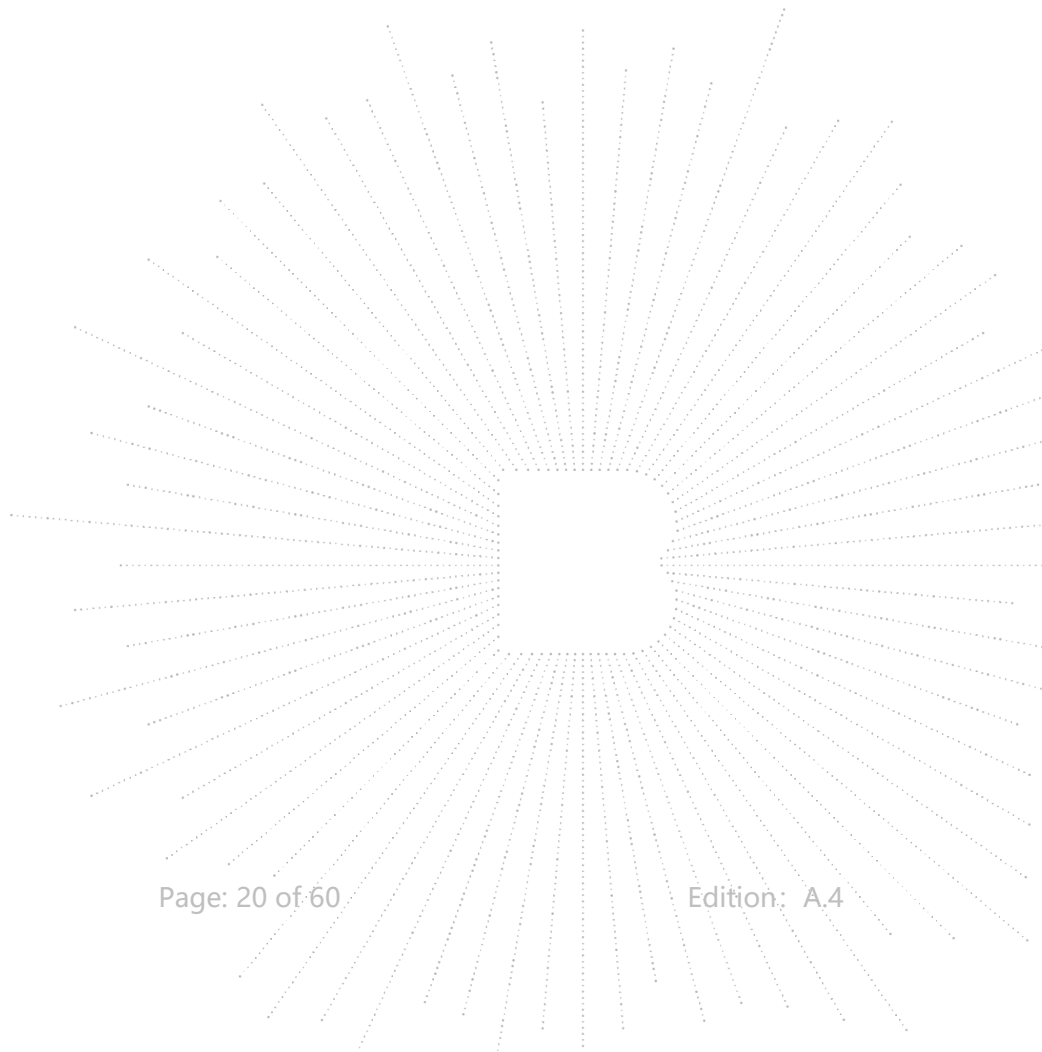

Temperature:	26 °C	Relative Humidity:	54%
Pressure:	101KPa	Phase :	Horizontal
Test Mode:	Mode 7	Test Voltage :	AC120V/60Hz

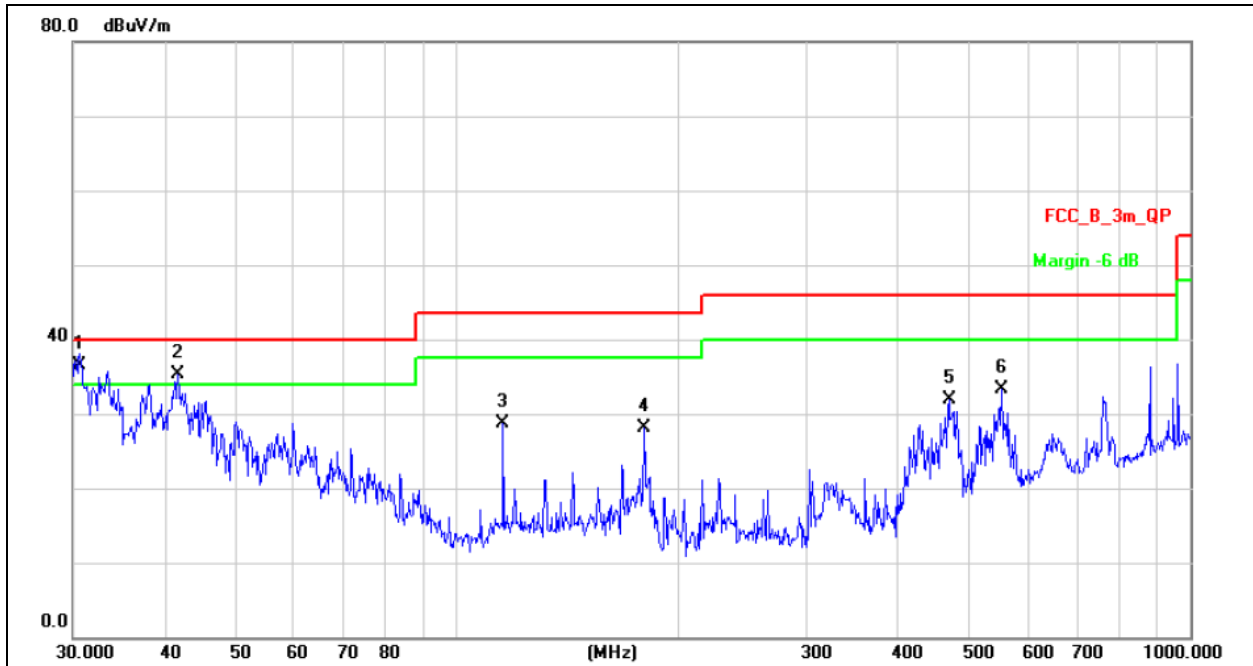
Remark:

1. Factor = Antenna Factor + Cable Loss – Pre-amplifier.
2. Measurement = Reading Level + Correct Factor
3. Over = Measurement - Limit

No.	Mk.	Freq.	Reading Level	Correct Factor	Measurement	Limit	Over	Detector
		MHz	dBuV	dB/m	dBuV/m	dBuV/m	dB	
1	*	30.6379	45.38	-8.84	36.54	40.00	-3.46	QP
2	!	41.7129	43.73	-8.51	35.22	40.00	-4.78	QP
3		115.7256	37.50	-8.88	28.62	43.50	-14.88	QP
4		180.0165	36.31	-8.19	28.12	43.50	-15.38	QP
5		468.8762	34.01	-2.01	32.00	46.00	-14.00	QP
6		552.8832	32.91	0.41	33.32	46.00	-12.68	QP

Temperature:	26 °C	Relative Humidity:	54%
Pressure:	101KPa	Phase :	Vertical
Test Mode:	Mode 7	Test Voltage :	AC120V/60Hz

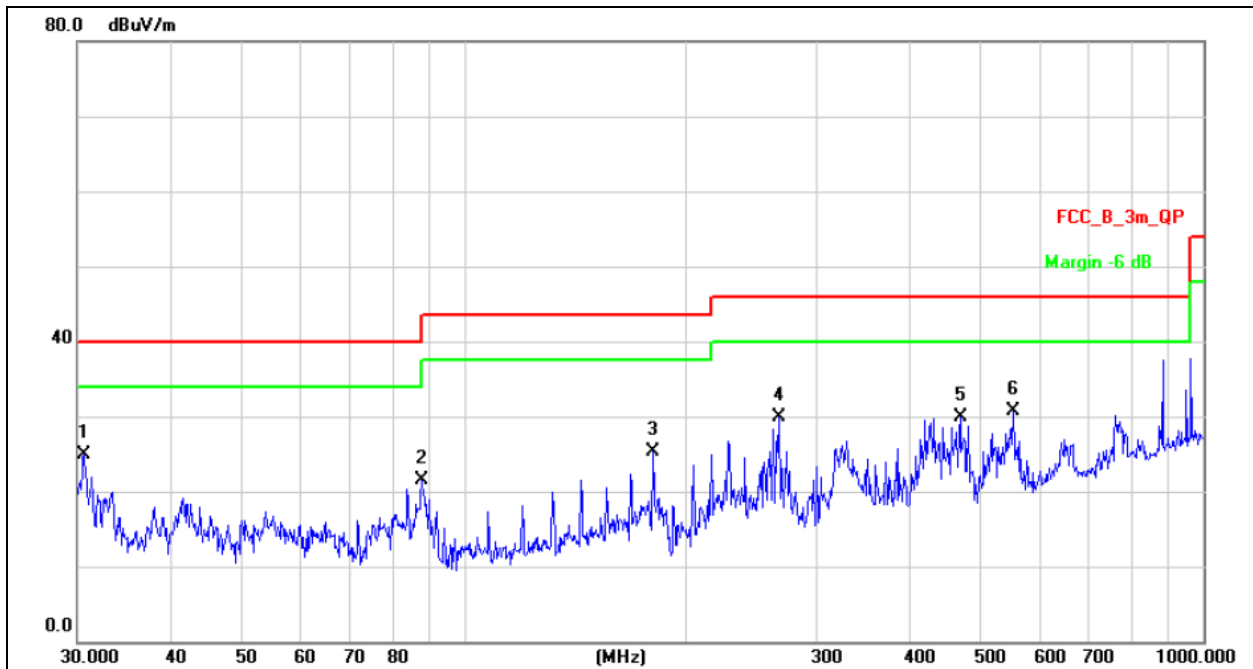

Remark:
 1. Factor = Antenna Factor + Cable Loss – Pre-amplifier.
 2. Measurement = Reading Level + Correct Factor
 3. Over = Measurement - Limit

No.	Mk.	Freq. MHz	Reading Level dBuV	Correct Factor dB/m	Measure- ment dBuV/m	Limit dBuV/m	Over dB	Detector
1	*	30.6379	33.79	-8.84	24.95	40.00	-15.05	QP
2		87.7248	33.12	-11.71	21.41	40.00	-18.59	QP
3		180.0165	33.40	-8.19	25.21	43.50	-18.29	QP
4		266.6089	37.00	-7.12	29.88	46.00	-16.12	QP
5		468.8762	31.84	-2.01	29.83	46.00	-16.17	QP
6		552.8832	30.32	0.41	30.73	46.00	-15.27	QP

Between 1GHz – 25GHz

Worst case: Secondary switch (1) & Antenna 1

GFSK							
Polar (H/V)	Frequency	Reading Level	Correct Factor	Measurement	Limits	Over	Detector Type
	(MHz)	(dBuV/m)	(dB)	(dBuV/m)	(dBuV/m)	(dB)	
Low channel							
V	4804.00	57.16	-0.43	56.73	74.00	-17.27	PK
V	4804.00	51.25	-0.43	50.82	54.00	-3.18	AV
V	7206.00	53.39	8.31	61.70	74.00	-12.30	PK
V	7206.00	39.25	8.31	47.56	54.00	-6.44	AV
H	4804.00	60.96	-0.43	60.53	74.00	-13.47	PK
H	4804.00	49.66	-0.43	49.23	54.00	-4.77	AV
H	7206.00	50.94	8.31	59.25	74.00	-14.75	PK
H	7206.00	42.50	8.31	50.81	54.00	-3.19	AV
Middle channel							
V	4882.00	58.29	-0.38	57.91	74.00	-16.09	PK
V	4882.00	51.02	-0.38	50.64	54.00	-3.36	AV
V	7323.00	52.48	8.83	61.31	74.00	-12.69	PK
V	7323.00	40.23	8.83	49.06	54.00	-4.94	AV
H	4882.00	56.51	-0.38	56.13	74.00	-17.87	PK
H	4882.00	49.29	-0.38	48.91	54.00	-5.09	AV
H	7323.00	50.38	8.83	59.21	74.00	-14.79	PK
H	7323.00	39.28	8.83	48.11	54.00	-5.89	AV
High channel							
V	4960.00	58.52	-0.32	58.20	74.00	-15.80	PK
V	4960.00	49.03	-0.32	48.71	54.00	-5.29	AV
V	7440.00	52.08	9.35	61.43	74.00	-12.57	PK
V	7440.00	39.56	9.35	48.91	54.00	-5.09	AV
H	4960.00	57.25	-0.32	56.93	74.00	-17.07	PK
H	4960.00	48.97	-0.32	48.65	54.00	-5.35	AV
H	7440.00	51.93	9.35	61.28	74.00	-12.72	PK
H	7440.00	41.05	9.35	50.40	54.00	-3.60	AV

Remark:

1. Emission Level = Meter Reading + Factor, Factor = Antenna Factor + Cable Loss – Pre-amplifier. Over = Emission Level - Limit

2. In restricted bands of operation, The spurious emissions below the permissible value more than 20dB

3. The amplitude of spurious emissions which are attenuated by more than 20dB below the permissible value has no need to be reported.

4. The data only shows the worst mode, and the worst mode is BLE GFSK 1Mbps.

Worst case: Secondary switch (2) & Antenna 1

GFSK							
Polar (H/V)	Frequency	Reading Level	Correct Factor	Measurement	Limits	Over	Detector Type
	(MHz)	(dBuV/m)	(dB)	(dBuV/m)	(dBuV/m)	(dB)	
Low channel							
V	4804.00	60.46	-0.43	60.03	74.00	-13.97	PK
V	4804.00	48.24	-0.43	47.81	54.00	-6.19	AV
V	7206.00	51.30	8.31	59.61	74.00	-14.39	PK
V	7206.00	41.41	8.31	49.72	54.00	-4.28	AV
H	4804.00	58.67	-0.43	58.24	74.00	-15.76	PK
H	4804.00	50.86	-0.43	50.43	54.00	-3.57	AV
H	7206.00	53.02	8.31	61.33	74.00	-12.67	PK
H	7206.00	42.23	8.31	50.54	54.00	-3.46	AV
Middle channel							
V	4882.00	56.80	-0.38	56.42	74.00	-17.58	PK
V	4882.00	48.51	-0.38	48.13	54.00	-5.87	AV
V	7323.00	53.09	8.83	61.92	74.00	-12.08	PK
V	7323.00	41.62	8.83	50.45	54.00	-3.55	AV
H	4882.00	56.88	-0.38	56.50	74.00	-17.50	PK
H	4882.00	50.15	-0.38	49.77	54.00	-4.23	AV
H	7323.00	53.16	8.83	61.99	74.00	-12.01	PK
H	7323.00	38.07	8.83	46.90	54.00	-7.10	AV
High channel							
V	4960.00	57.84	-0.32	57.52	74.00	-16.48	PK
V	4960.00	50.25	-0.32	49.93	54.00	-4.07	AV
V	7440.00	53.59	9.35	62.94	74.00	-11.06	PK
V	7440.00	39.43	9.35	48.78	54.00	-5.22	AV
H	4960.00	60.93	-0.32	60.61	74.00	-13.39	PK
H	4960.00	50.68	-0.32	50.36	54.00	-3.64	AV
H	7440.00	53.98	9.35	63.33	74.00	-10.67	PK
H	7440.00	39.89	9.35	49.24	54.00	-4.76	AV

Remark:

1. Emission Level = Meter Reading + Factor, Factor = Antenna Factor + Cable Loss – Pre-amplifier. Over = Emission Level - Limit

2. In restricted bands of operation, The spurious emissions below the permissible value more than 20dB

3. The amplitude of spurious emissions which are attenuated by more than 20dB below the permissible value has no need to be reported.

4. The data only shows the worst mode, and the worst mode is BLE GFSK 1Mbps.

Worst case: Secondary switch (3) & Antenna 1

GFSK							
Polar (H/V)	Frequency	Reading Level	Correct Factor	Measurement	Limits	Over	Detector Type
	(MHz)	(dBuV/m)	(dB)	(dBuV/m)	(dBuV/m)	(dB)	
Low channel							
V	4804.00	60.74	-0.43	60.31	74.00	-13.69	PK
V	4804.00	48.18	-0.43	47.75	54.00	-6.25	AV
V	7206.00	51.37	8.31	59.68	74.00	-14.32	PK
V	7206.00	38.67	8.31	46.98	54.00	-7.02	AV
H	4804.00	56.18	-0.43	55.75	74.00	-18.25	PK
H	4804.00	48.66	-0.43	48.23	54.00	-5.77	AV
H	7206.00	53.08	8.31	61.39	74.00	-12.61	PK
H	7206.00	39.52	8.31	47.83	54.00	-6.17	AV
Middle channel							
V	4882.00	60.68	-0.38	60.30	74.00	-13.70	PK
V	4882.00	50.50	-0.38	50.12	54.00	-3.88	AV
V	7323.00	54.42	8.83	63.25	74.00	-10.75	PK
V	7323.00	41.34	8.83	50.17	54.00	-3.83	AV
H	4882.00	58.21	-0.38	57.83	74.00	-16.17	PK
H	4882.00	48.86	-0.38	48.48	54.00	-5.52	AV
H	7323.00	53.40	8.83	62.23	74.00	-11.77	PK
H	7323.00	39.16	8.83	47.99	54.00	-6.01	AV
High channel							
V	4960.00	59.57	-0.32	59.25	74.00	-14.75	PK
V	4960.00	50.32	-0.32	50.00	54.00	-4.00	AV
V	7440.00	51.03	9.35	60.38	74.00	-13.62	PK
V	7440.00	40.00	9.35	49.35	54.00	-4.65	AV
H	4960.00	56.25	-0.32	55.93	74.00	-18.07	PK
H	4960.00	49.02	-0.32	48.70	54.00	-5.30	AV
H	7440.00	51.51	9.35	60.86	74.00	-13.14	PK
H	7440.00	39.46	9.35	48.81	54.00	-5.19	AV

Remark:

1. Emission Level = Meter Reading + Factor, Factor = Antenna Factor + Cable Loss – Pre-amplifier. Over = Emission Level - Limit
2. In restricted bands of operation, The spurious emissions below the permissible value more than 20dB
3. The amplitude of spurious emissions which are attenuated by more than 20dB below the permissible value has no need to be reported.
4. The data only shows the worst mode, and the worst mode is BLE GFSK 1Mbps.

Worst case: Secondary switch (4) & Antenna 1

GFSK							
Polar (H/V)	Frequency	Reading Level	Correct Factor	Measurement	Limits	Over	Detector Type
	(MHz)	(dBuV/m)	(dB)	(dBuV/m)	(dBuV/m)	(dB)	
Low channel							
V	4804.00	59.08	-0.43	58.65	74.00	-15.35	PK
V	4804.00	49.89	-0.43	49.46	54.00	-4.54	AV
V	7206.00	50.95	8.31	59.26	74.00	-14.74	PK
V	7206.00	39.19	8.31	47.50	54.00	-6.50	AV
H	4804.00	60.97	-0.43	60.54	74.00	-13.46	PK
H	4804.00	52.73	-0.43	52.30	54.00	-1.70	AV
H	7206.00	50.15	8.31	58.46	74.00	-15.54	PK
H	7206.00	39.11	8.31	47.42	54.00	-6.58	AV
Middle channel							
V	4882.00	59.26	-0.38	58.88	74.00	-15.12	PK
V	4882.00	48.49	-0.38	48.11	54.00	-5.89	AV
V	7323.00	51.18	8.83	60.01	74.00	-13.99	PK
V	7323.00	40.38	8.83	49.21	54.00	-4.79	AV
H	4882.00	59.63	-0.38	59.25	74.00	-14.75	PK
H	4882.00	51.08	-0.38	50.70	54.00	-3.30	AV
H	7323.00	52.13	8.83	60.96	74.00	-13.04	PK
H	7323.00	38.35	8.83	47.18	54.00	-6.82	AV
High channel							
V	4960.00	59.43	-0.32	59.11	74.00	-14.89	PK
V	4960.00	50.95	-0.32	50.63	54.00	-3.37	AV
V	7440.00	53.76	9.35	63.11	74.00	-10.89	PK
V	7440.00	40.97	9.35	50.32	54.00	-3.68	AV
H	4960.00	57.35	-0.32	57.03	74.00	-16.97	PK
H	4960.00	48.47	-0.32	48.15	54.00	-5.85	AV
H	7440.00	54.79	9.35	64.14	74.00	-9.86	PK
H	7440.00	38.33	9.35	47.68	54.00	-6.32	AV

Remark:

1. Emission Level = Meter Reading + Factor, Factor = Antenna Factor + Cable Loss – Pre-amplifier. Over = Emission Level - Limit
2. In restricted bands of operation, The spurious emissions below the permissible value more than 20dB
3. The amplitude of spurious emissions which are attenuated by more than 20dB below the permissible value has no need to be reported.
4. The data only shows the worst mode, and the worst mode is BLE GFSK 1Mbps.

8. Radiated Band Emission Measurement and Restricted Bands Of Operation

8.1 Block Diagram Of Test Setup

Radiated Emission Test-Up Frequency Above 1GHz

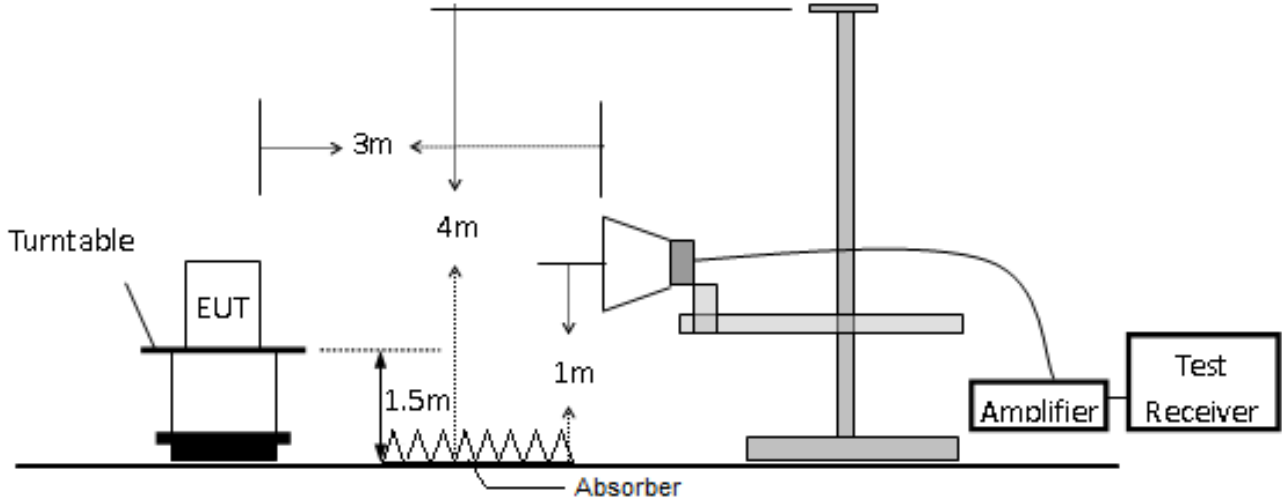

8.2 Limit

FCC Part15 C Section 15.209 and 15.205

(a) Except as shown in paragraph (d) of this section, only spurious emissions are permitted in any of the frequency bands listed below:

MHz	MHz	MHz	GHz
0.090-0.110	16.42-16.423	399.9-410	4.5-5.15
0.495-0.505	16.69475-16.69525	608-614	5.35-5.46
2.1735-2.1905	16.80425-16.80475	960-1240	7.25-7.75
4.125-4.128	25.5-25.67	1300-1427	8.025-8.5
4.17725-4.17775	37.5-38.25	1435-1626.5	9.0-9.2
4.20725-4.20775	73-74.6	1645.5-1646.5	9.3-9.5
6.215-6.218	74.8-75.2	1660-1710	10.6-12.7
6.26775-6.26825	108-121.94	1718.8-1722.2	13.25-13.4
6.31175-6.31225	123-138	2200-2300	14.47-14.5
8.291-8.294	149.9-150.05	2310-2390	15.35-16.2
8.362-8.366	156.52475-156.52525	2483.5-2500	17.7-21.4
8.37625-8.38675	156.7-156.9	2690-2900	22.01-23.12
8.41425-8.41475	162.0125-167.17	3260-3267	23.6-24.0
12.29-12.293	167.72-173.2	3332-3339	31.2-31.8
12.51975-12.52025	240-285	3345.8-3358	36.43-36.5
12.57675-12.57725	322-335.4	3600-4400	(²)
13.36-13.41			

Limits Of Radiated Emission Measurement (Above 1000MHz)

Frequency (MHz)	Limit (dBuV/m) (at 3M)	
	Peak	Average
Above 1000	74	54

Notes:

- (1) The limit for radiated test was performed according to FCC PART 15C.
- (2) The tighter limit applies at the band edges.
- (3) Emission level (dBuV/m) = 20log Emission level (uV/m).

8.3 Test Procedure

Receiver Parameter	Setting
Attenuation	Auto
Start Frequency	2300MHz
Stop Frequency	2520
RB / VB (emission in restricted band)	1 MHz / 1 MHz for Peak, 1 MHz / 10Hz for Average

Above 1GHz test procedure as below:

- a. The EUT was placed on the top of a rotating table 1.5 meters above the ground at a 3 meter camber. The table was rotated 360 degrees to determine the position of the highest radiation.
- b. The EUT was set 3 meters away from the interference-receiving antenna, which was mounted on the top of a variable-height antenna tower.
- c. The antenna height is varied from one meter to four meters above the ground to determine the maximum value of the field strength. Both horizontal and vertical polarizations of the antenna are set to make the measurement.
- d. For each suspected emission, the EUT was arranged to its worst case and then the antenna was tuned to heights from 1 meter to 4 meters and the rota table was turned from 0 degrees to 360 degrees to find the maximum reading.
- e. The test-receiver system was set to Peak Detect Function and Specified Bandwidth with Maximum Hold Mode.
- f. If the emission level of the EUT in peak mode was 10dB lower than the limit specified, then testing could be stopped and the peak values of the EUT would be reported. Otherwise the emissions that did not have 10dB margin would be re-tested one by one using peak, quasi-peak or average method as specified and then reported in a data sheet.
- g. Test the EUT in the lowest channel, the middle channel, the Highest channel.

Note:

Both horizontal and vertical antenna polarities were tested and performed pretest to three orthogonal axis. The worst case emissions were reported.

8.4 EUT Operating Conditions

The EUT was configured for testing in a typical fashion (as a customer would normally use it). The EUT has been programmed to continuously transmit during test. This operating condition was tested and used to collect the included data.

8.5 Test Result

Worst case: Secondary switch (1) & Antenna 1

	Polar (H/V)	Frequency (MHz)	Reading Level (dBuV/m)	Correct Factor (dB)	Measurement (dBuV/m)	Limits (dBuV/m)		Result
					PK	□PK	AV	
GFSK	Low Channel 2402MHz							
	H	2390.00	52.35	-6.70	45.65	74.00	54.00	PASS
	H	2400.00	59.03	-6.71	52.32	74.00	54.00	PASS
	V	2390.00	50.07	-6.70	43.37	74.00	54.00	PASS
	V	2400.00	58.29	-6.71	51.58	74.00	54.00	PASS
	High Channel 2480MHz							
	H	2483.50	60.83	-6.79	54.04	74.00	54.00	PASS
	H	2500.00	50.02	-6.81	43.21	74.00	54.00	PASS
	V	2483.50	60.04	-6.79	53.25	74.00	54.00	PASS
	V	2500.00	53.80	-6.81	46.99	74.00	54.00	PASS

Remark:

1. Emission Level = Meter Reading + Factor,

Factor = Antenna Factor + Cable Loss – Pre-amplifier.

Over= Emission Level - Limit

2. If the PK measured levels comply with average limit, then the average level were deemed to comply with average limit.

3 In restricted bands of operation, The spurious emissions below the permissible value more than 20dB

4. The amplitude of spurious emissions which are attenuated by more than 20dB below the permissible value has no need to be reported.

5. The data only shows the worst mode, and the worst mode is BLE GFSK 1Mbps.

Worst case: Secondary switch (2) & Antenna 1

	Polar (H/V)	Frequency (MHz)	Reading Level (dBuV/m)	Correct Factor (dB)	Measurement (dBuV/m)	Limits (dBuV/m)		Result
					PK	□PK	AV	
Low Channel 2402MHz								
GFSK	H	2390.00	54.94	-6.70	48.24	74.00	54.00	PASS
	H	2400.00	55.53	-6.71	48.82	74.00	54.00	PASS
	V	2390.00	50.57	-6.70	43.87	74.00	54.00	PASS
	V	2400.00	59.41	-6.71	52.70	74.00	54.00	PASS
High Channel 2480MHz								
	H	2483.50	57.37	-6.79	50.58	74.00	54.00	PASS
	H	2500.00	53.30	-6.81	46.49	74.00	54.00	PASS
	V	2483.50	58.56	-6.79	51.77	74.00	54.00	PASS
	V	2500.00	54.42	-6.81	47.61	74.00	54.00	PASS

Remark:

1. Emission Level = Meter Reading + Factor,

Factor = Antenna Factor + Cable Loss – Pre-amplifier.

Over= Emission Level - Limit

2. If the PK measured levels comply with average limit, then the average level were deemed to comply with average limit.

3 In restricted bands of operation, The spurious emissions below the permissible value more than 20dB

4. The amplitude of spurious emissions which are attenuated by more than 20dB below the permissible value has no need to be reported.

5. The data only shows the worst mode, and the worst mode is BLE GFSK 1Mbps.

Worst case: Secondary switch (3) & Antenna 1

	Polar (H/V)	Frequency (MHz)	Reading Level (dBUV/m)	Correct Factor (dB)	Measurement (dBUV/m)	Limits (dBUV/m)		Result
					PK	□PK	AV	
GFSK	Low Channel 2402MHz							
	H	2390.00	50.69	-6.70	43.99	74.00	54.00	PASS
	H	2400.00	57.01	-6.71	50.30	74.00	54.00	PASS
	V	2390.00	53.11	-6.70	46.41	74.00	54.00	PASS
	V	2400.00	59.77	-6.71	53.06	74.00	54.00	PASS
	High Channel 2480MHz							
	H	2483.50	57.31	-6.79	50.52	74.00	54.00	PASS
	H	2500.00	50.07	-6.81	43.26	74.00	54.00	PASS
	V	2483.50	58.03	-6.79	51.24	74.00	54.00	PASS
	V	2500.00	52.82	-6.81	46.01	74.00	54.00	PASS

Remark:

1. Emission Level = Meter Reading + Factor,

Factor = Antenna Factor + Cable Loss – Pre-amplifier.

Over= Emission Level - Limit

2. If the PK measured levels comply with average limit, then the average level were deemed to comply with average limit.

3 In restricted bands of operation, The spurious emissions below the permissible value more than 20dB

4. The amplitude of spurious emissions which are attenuated by more than 20dB below the permissible value has no need to be reported.

5. The data only shows the worst mode, and the worst mode is BLE GFSK 1Mbps.

Worst case: Secondary switch (4) & Antenna 1

	Polar (H/V)	Frequency (MHz)	Reading Level (dBuV/m)	Correct Factor (dB)	Measurement (dBuV/m)	Limits (dBuV/m)		Result
					PK	□PK	AV	
Low Channel 2402MHz								
GFSK	H	2390.00	53.42	-6.70	46.72	74.00	54.00	PASS
	H	2400.00	56.50	-6.71	49.79	74.00	54.00	PASS
	V	2390.00	50.26	-6.70	43.56	74.00	54.00	PASS
	V	2400.00	58.14	-6.71	51.43	74.00	54.00	PASS
High Channel 2480MHz								
	H	2483.50	58.10	-6.79	51.31	74.00	54.00	PASS
	H	2500.00	51.05	-6.81	44.24	74.00	54.00	PASS
	V	2483.50	58.80	-6.79	52.01	74.00	54.00	PASS
	V	2500.00	54.86	-6.81	48.05	74.00	54.00	PASS

Remark:

1. Emission Level = Meter Reading + Factor,

Factor = Antenna Factor + Cable Loss – Pre-amplifier.

Over= Emission Level - Limit

2. If the PK measured levels comply with average limit, then the average level were deemed to comply with average limit.

3 In restricted bands of operation, The spurious emissions below the permissible value more than 20dB

4. The amplitude of spurious emissions which are attenuated by more than 20dB below the permissible value has no need to be reported.

5. The data only shows the worst mode, and the worst mode is BLE GFSK 1Mbps.

9. Power Spectral Density Test

9.1 Block Diagram Of Test Setup



9.2 Limit

FCC Part15 (15.247) , Subpart C				
Section	Test Item	Limit	Frequency Range (MHz)	Result
15.247	Power Spectral Density	8 dBm (in any 3KHz)	2400-2483.5	PASS

Limits Of Radiated Emission Measurement (Above 1000MHz)

9.3 Test procedure

1. Set analyzer center frequency to DTS channel center frequency.
2. Set the span to 1.5 times the DTS bandwidth.
3. Set the RBW to: 3 kHz
4. Set the VBW $\geq 3 \times$ RBW.
5. Detector = peak.
6. Sweep time = auto couple.
7. Trace mode = max hold.
8. Allow trace to fully stabilize.
9. Use the peak marker function to determine the maximum amplitude level within the RBW.
10. If measured value exceeds limit, reduce RBW (no less than 3 kHz) and repeat.

9.4 EUT Operating Conditions

The EUT tested system was configured as the statements of 4.6 Unless otherwise a special operating condition is specified in the follows during the testing.

Note: Power Spectral Density(dBm)=Reading+Cable Loss

9.5 Test Result

Temperature:	26 °C	Relative Humidity:	54%
Pressure:	101KPa	Test Voltage :	DC5V

Mode	Frequency	Power Spectral Density(dBm/3kHz)	Limit (dBm/3kHz)	Result
BLE 1M	2402 MHz	-7.75	8	PASS
	2440 MHz	-7.67	8	PASS
	2480 MHz	-7.69	8	PASS
BLE 2M	2402 MHz	-10.06	8	PASS
	2440 MHz	-9.85	8	PASS
	2480 MHz	-9.63	8	PASS

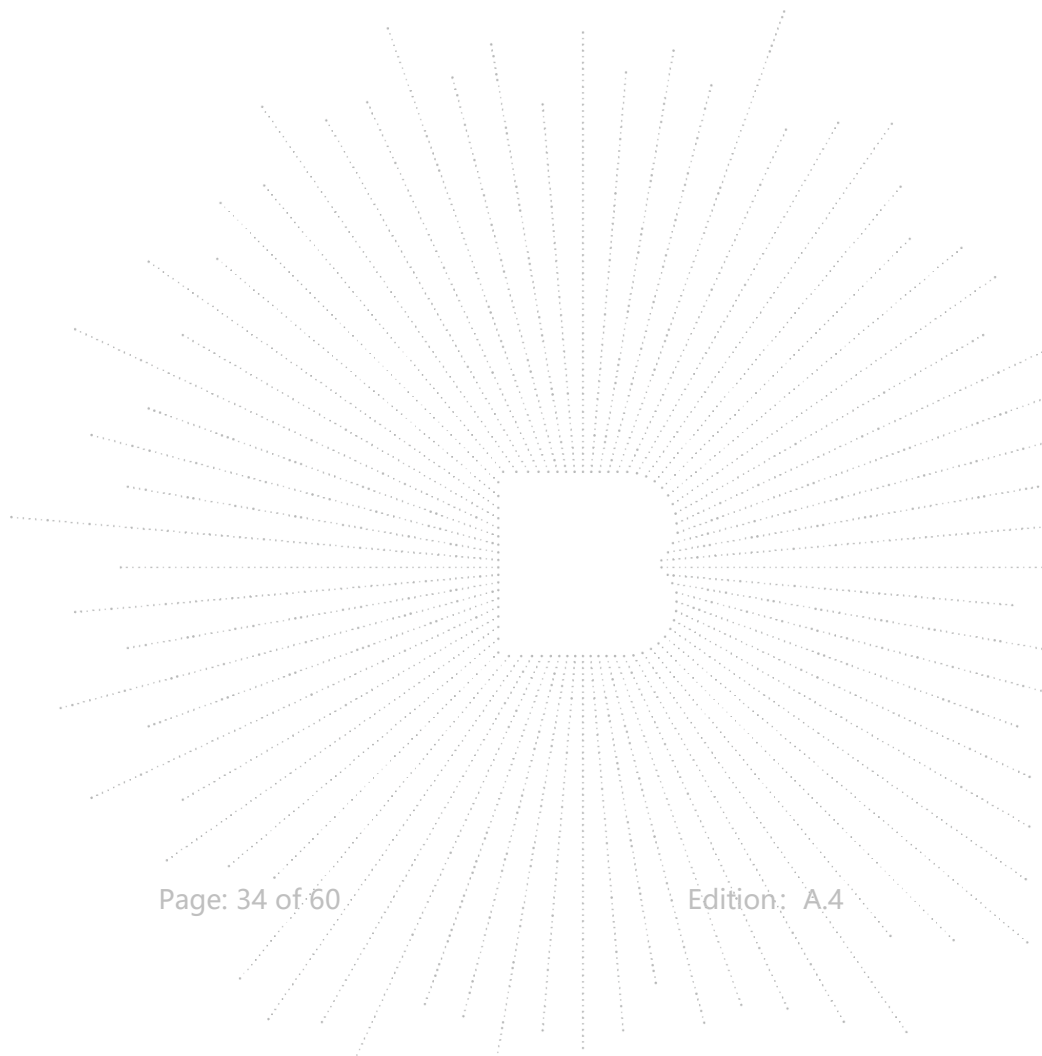

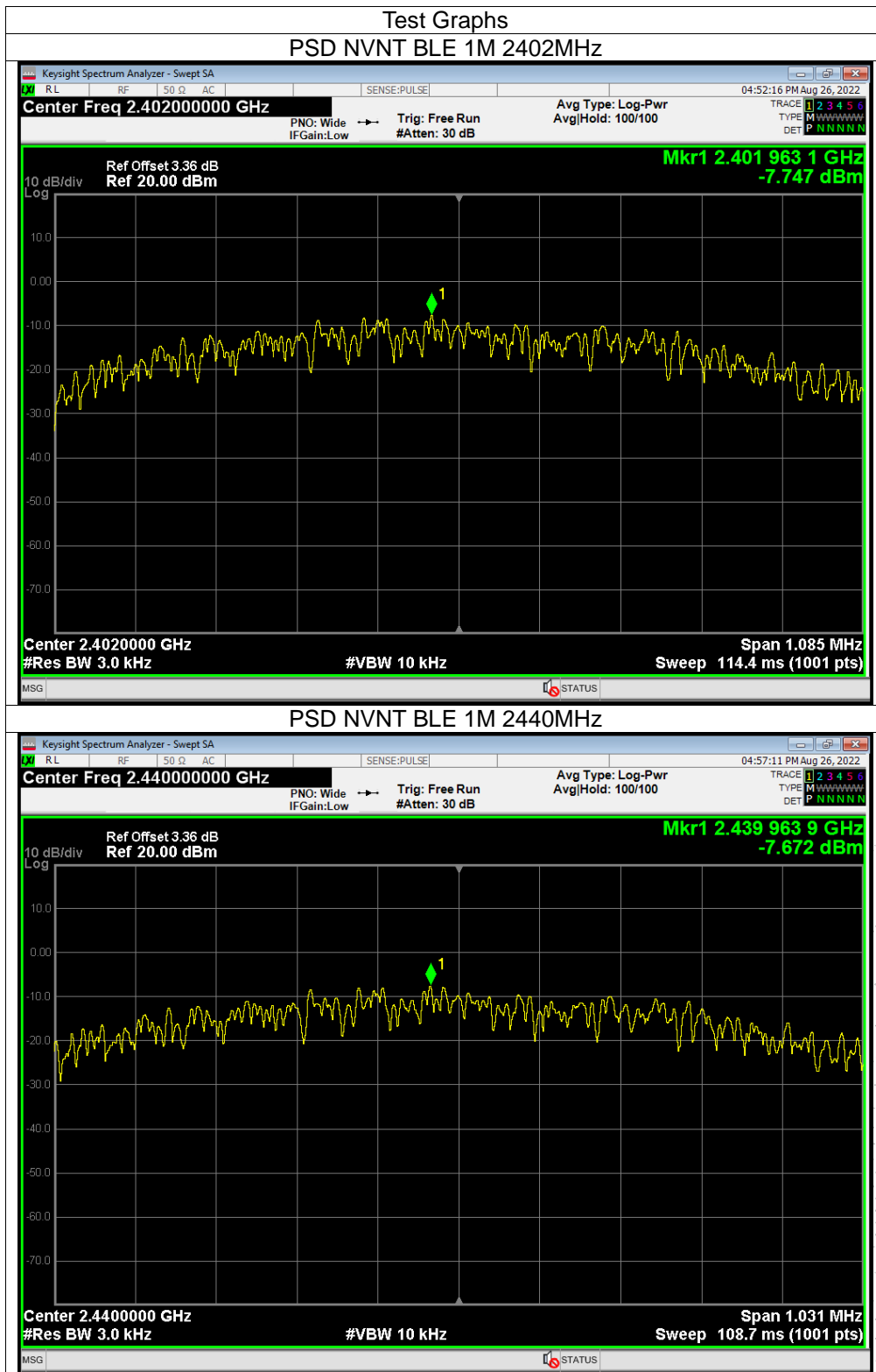

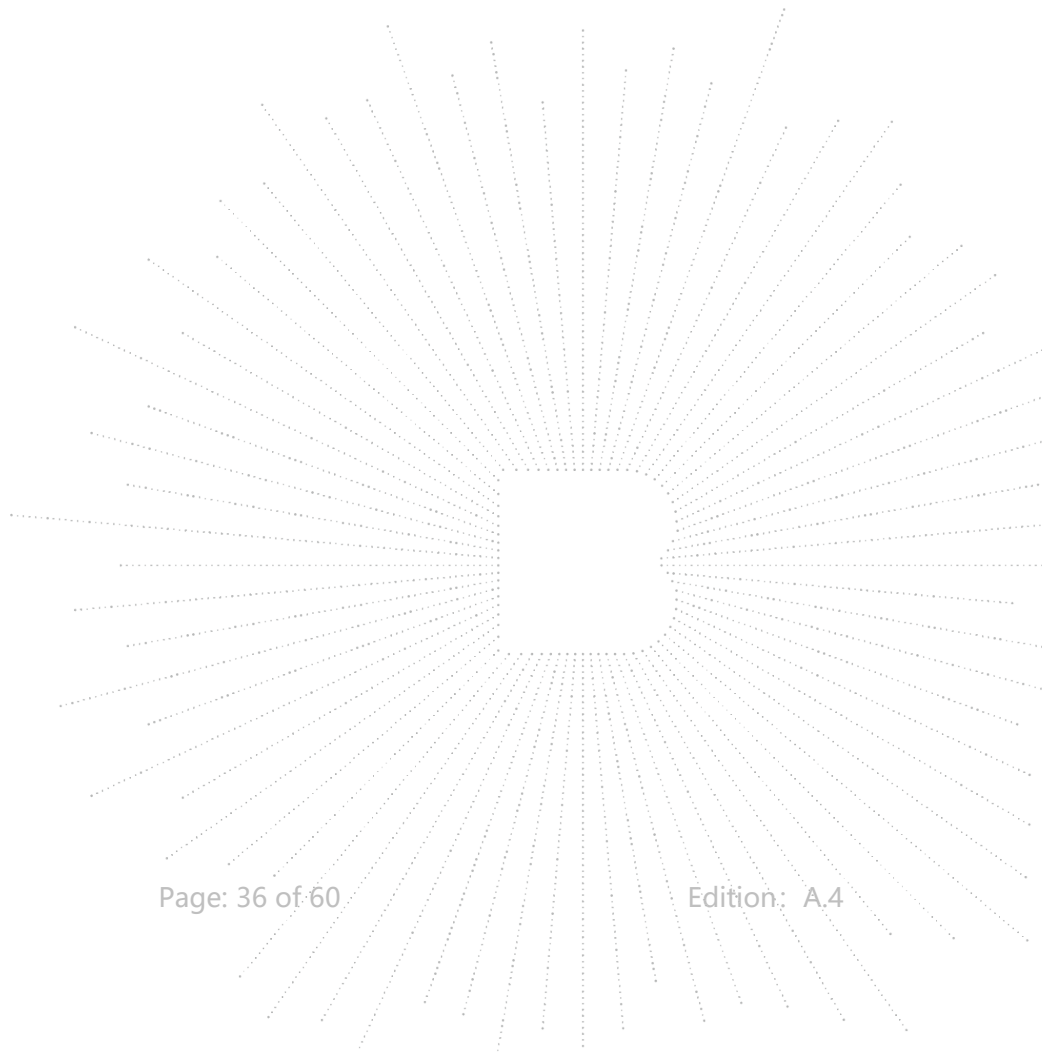
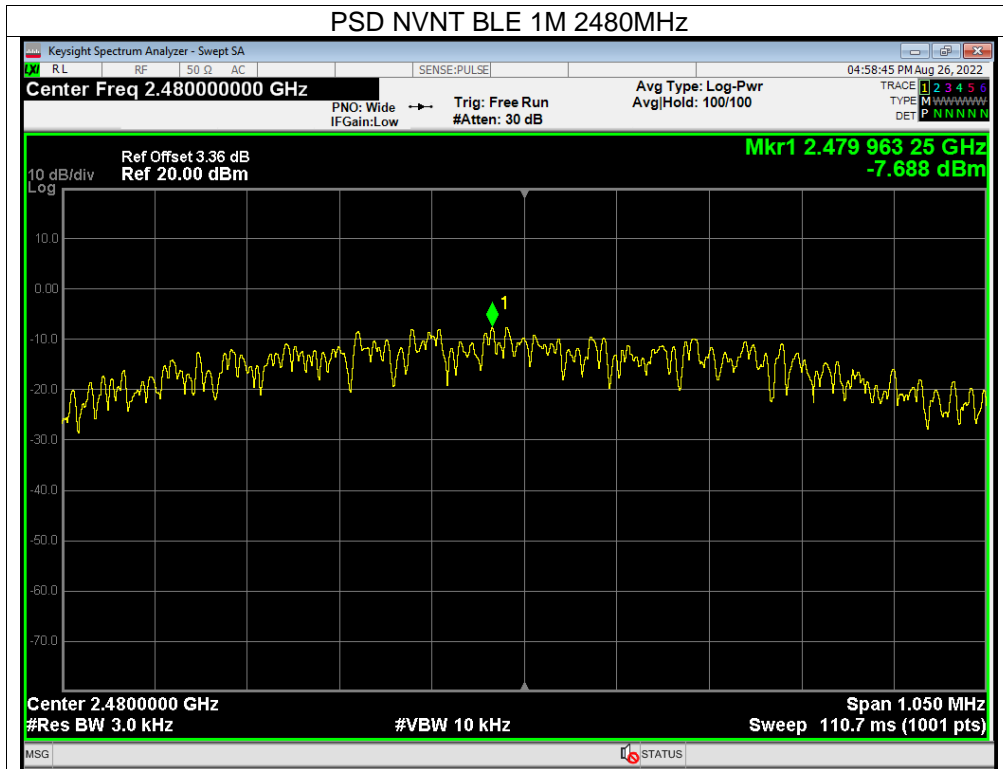

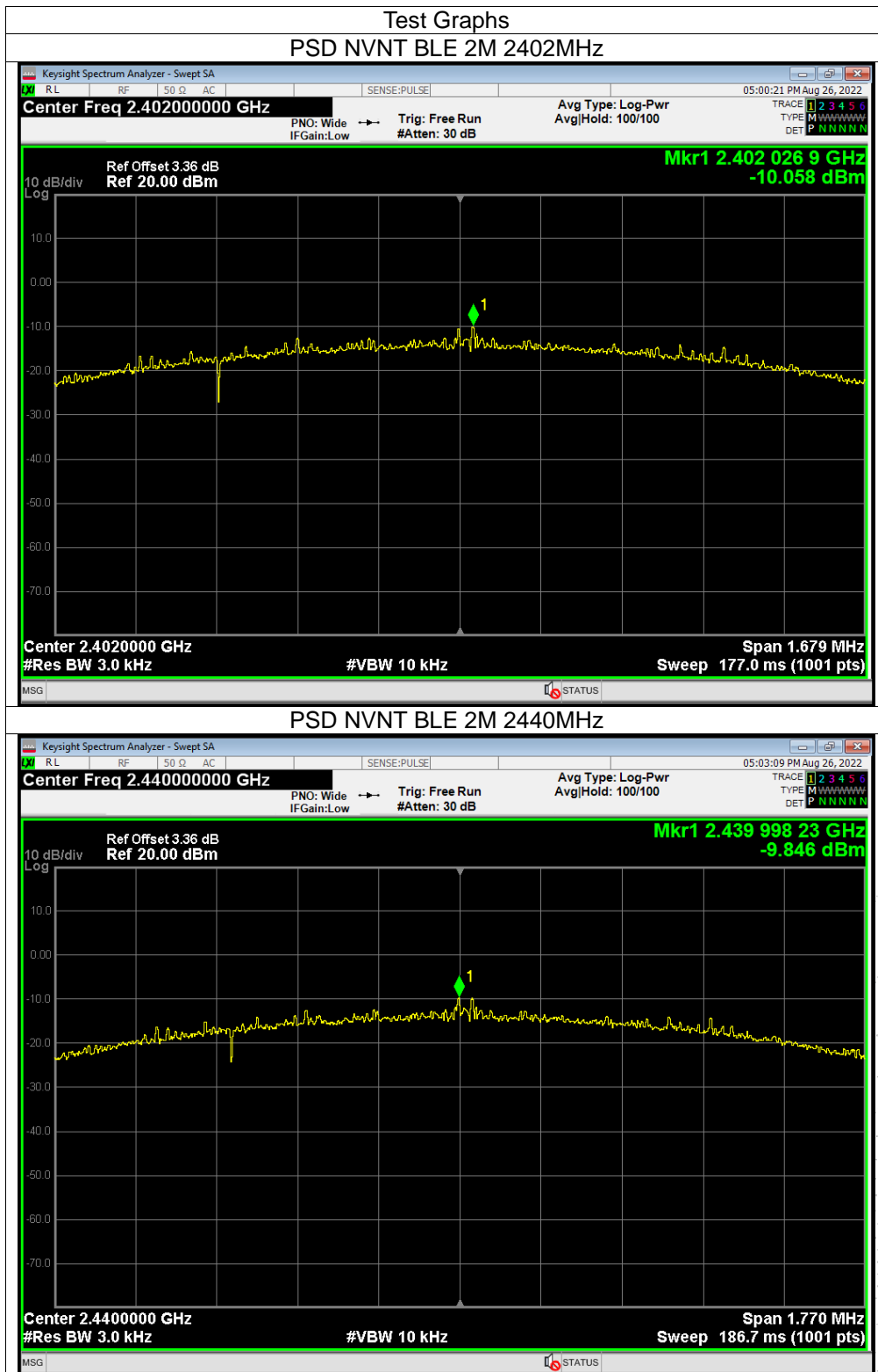

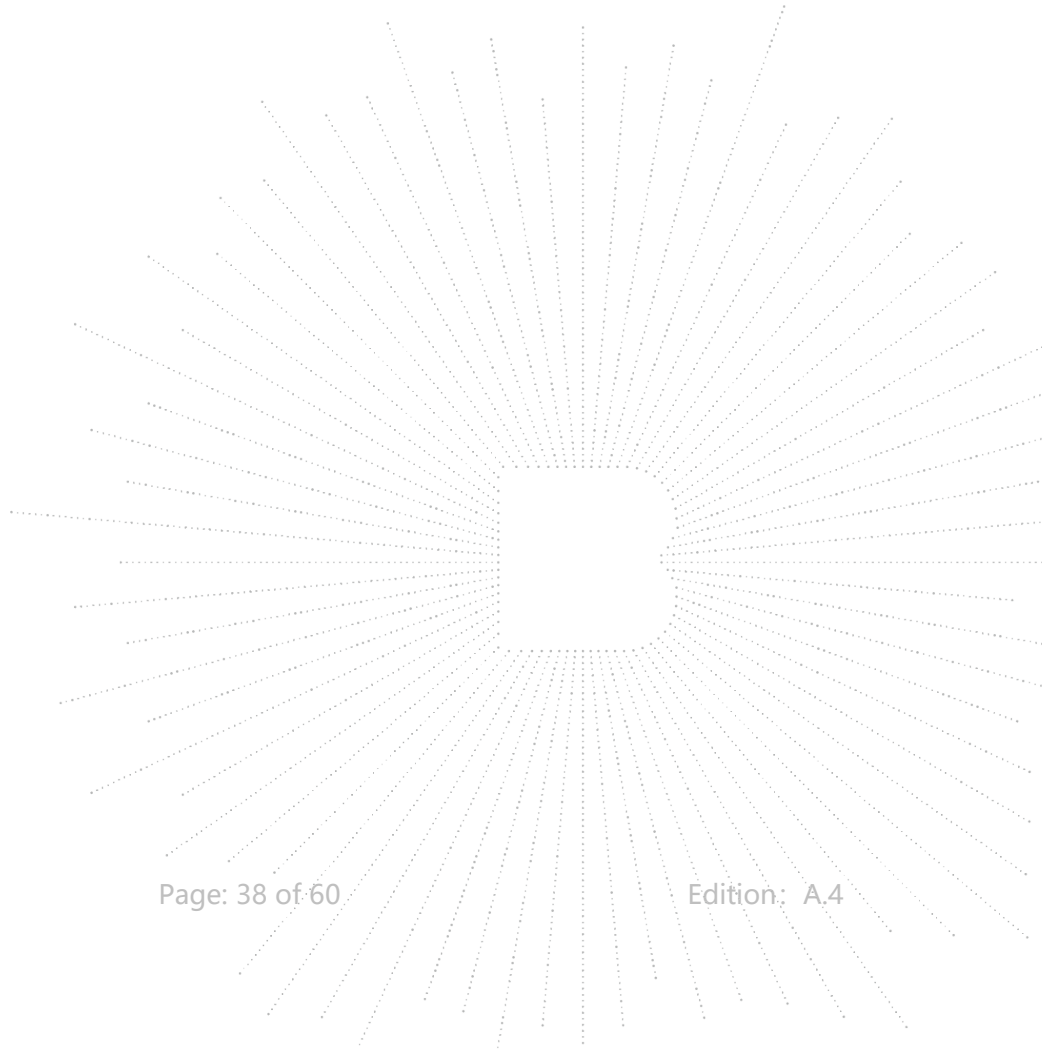
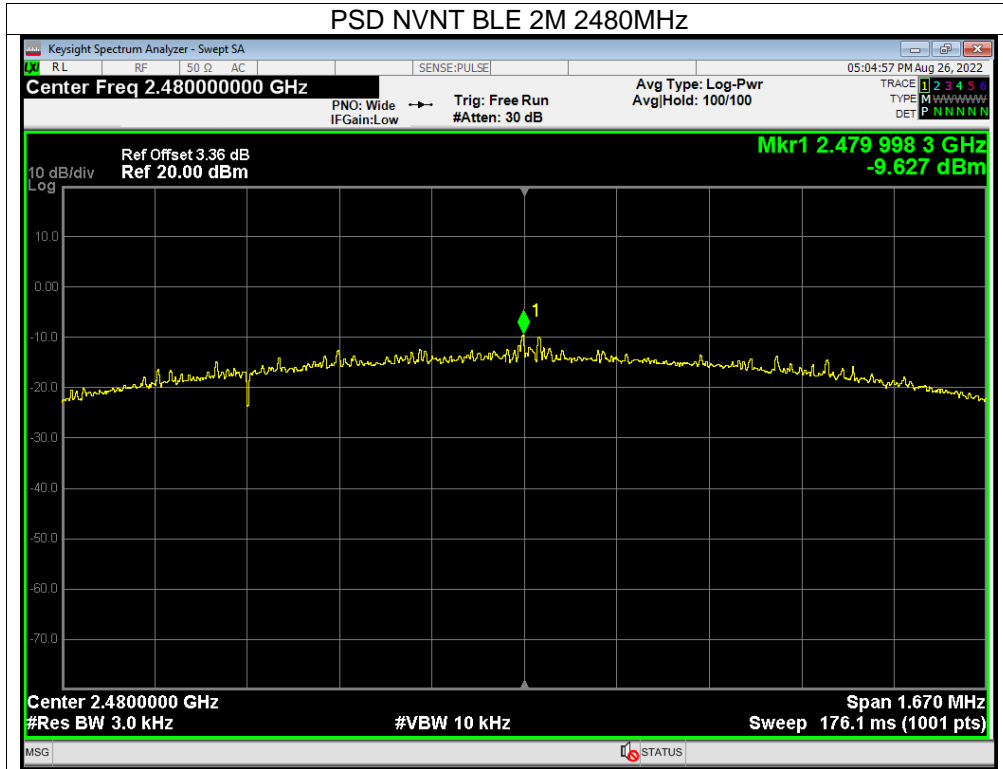

10. Bandwidth Test

10.1 Block Diagram Of Test Setup



10.2 Limit

FCC Part15 (15.247) , Subpart C				
Section	Test Item	Limit	Frequency Range (MHz)	Result
15.247(a)(2)	Bandwidth	$\geq 500\text{KHz}$ (-6dB bandwidth)	2400-2483.5	PASS

10.3 Test procedure

1. Set RBW = 100 kHz.
2. Set the video bandwidth (VBW) $\geq 3 \times$ RBW.
3. Detector = Peak.
4. Trace mode = max hold.
5. Sweep = auto couple.
6. Allow the trace to stabilize.
7. Measure the maximum width of the emission that is constrained by the frequencies associated with the two outermost amplitude points (upper and lower frequencies) that are attenuated by 6 dB relative to the maximum level measured in the fundamental emission.

10.4 EUT operating Conditions

The EUT tested system was configured as the statements of 4.6 Unless otherwise a special operating condition is specified in the follows during the testing.

Note: Power Spectral Density(dBm)=Reading+Cable Loss

10.5 Test Result

Temperature:	26 °C	Relative Humidity:	54%
Pressure:	101KPa	Test Voltage :	DC5V

Mode	Frequency (MHz)	-6dB bandwidth (MHz)	Limit (kHz)	Result
BLE 1M	2402	0.723	500	Pass
	2440	0.687	500	Pass
	2480	0.700	500	Pass
BLE 2M	2402	1.119	500	Pass
	2440	1.180	500	Pass
	2480	1.113	500	Pass

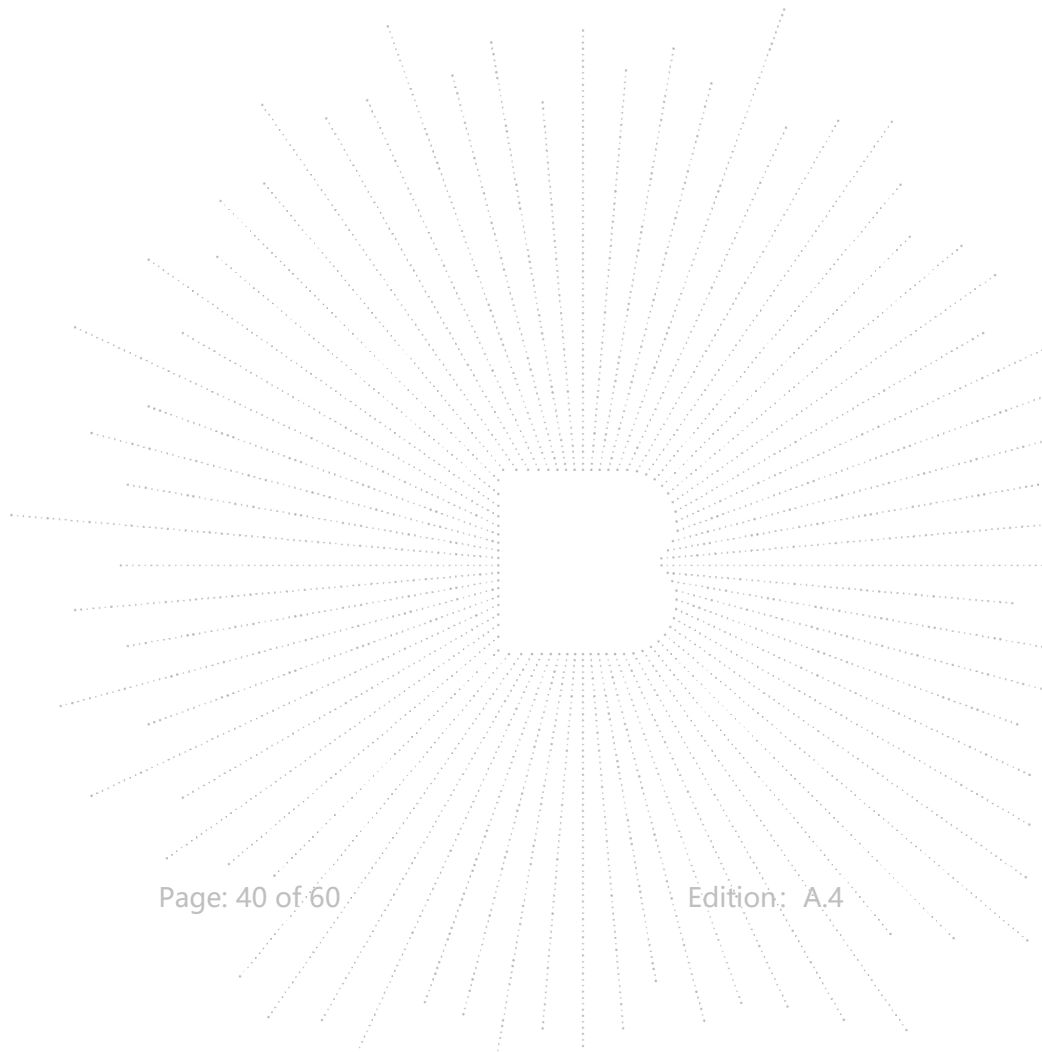



Test Graphs

-6dB Bandwidth NVNT BLE 1M 2402MHz

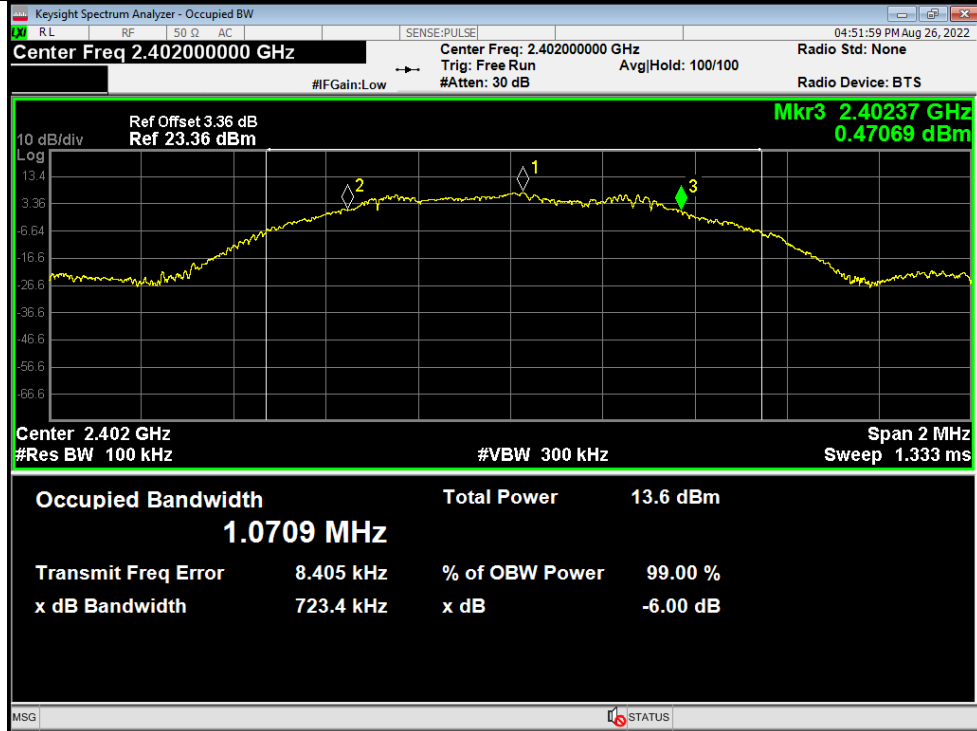

-6dB Bandwidth NVNT BLE 1M 2440MHz

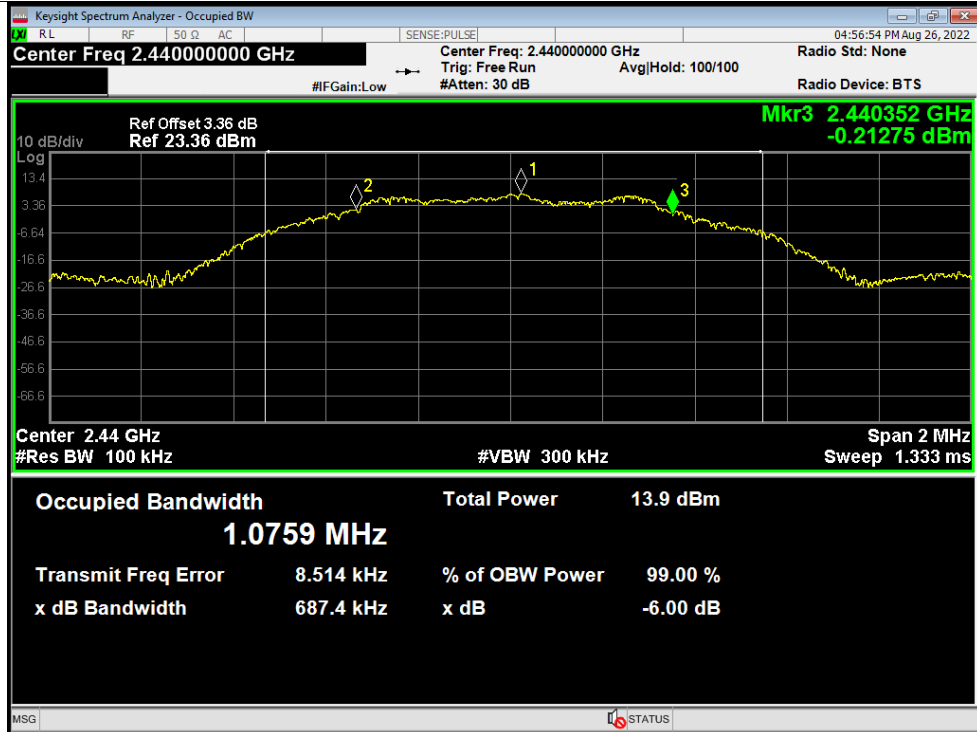

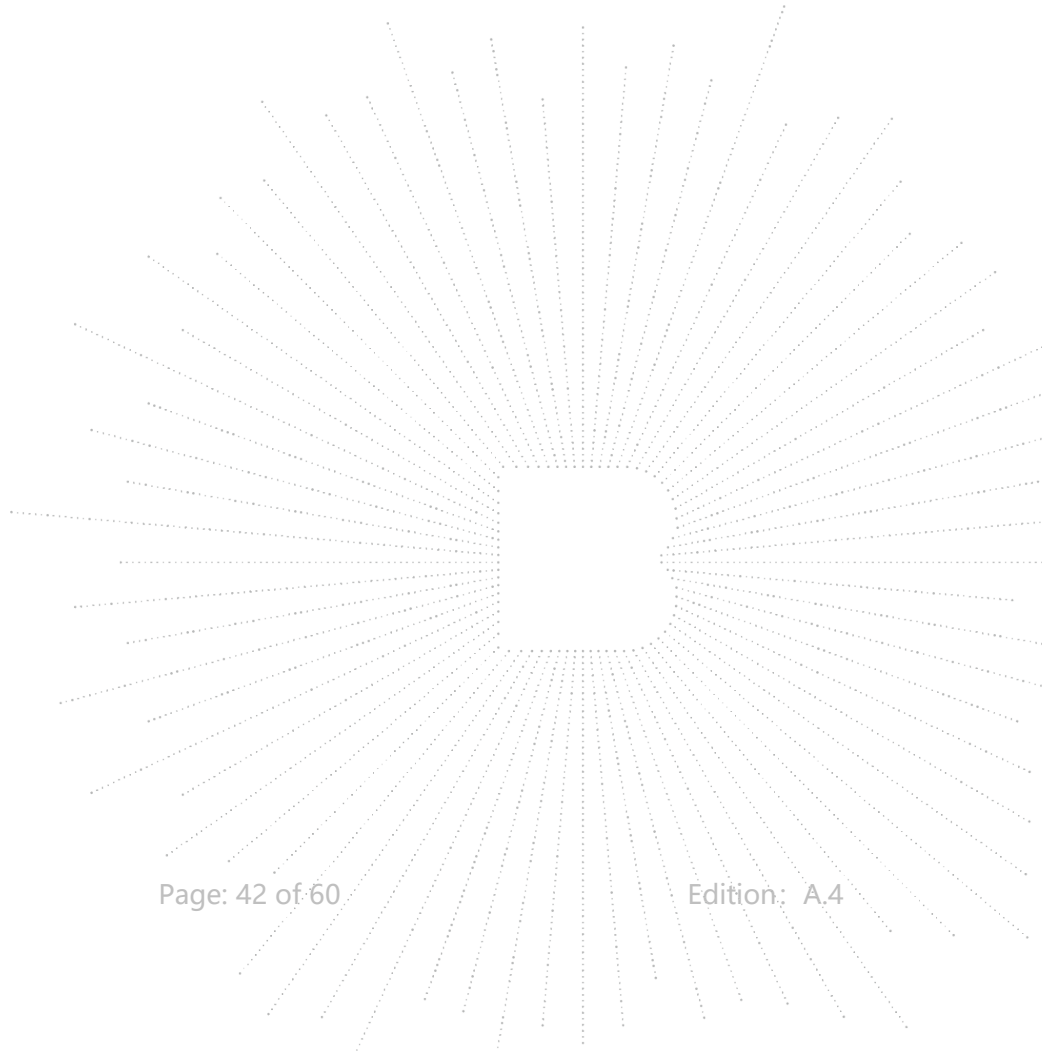
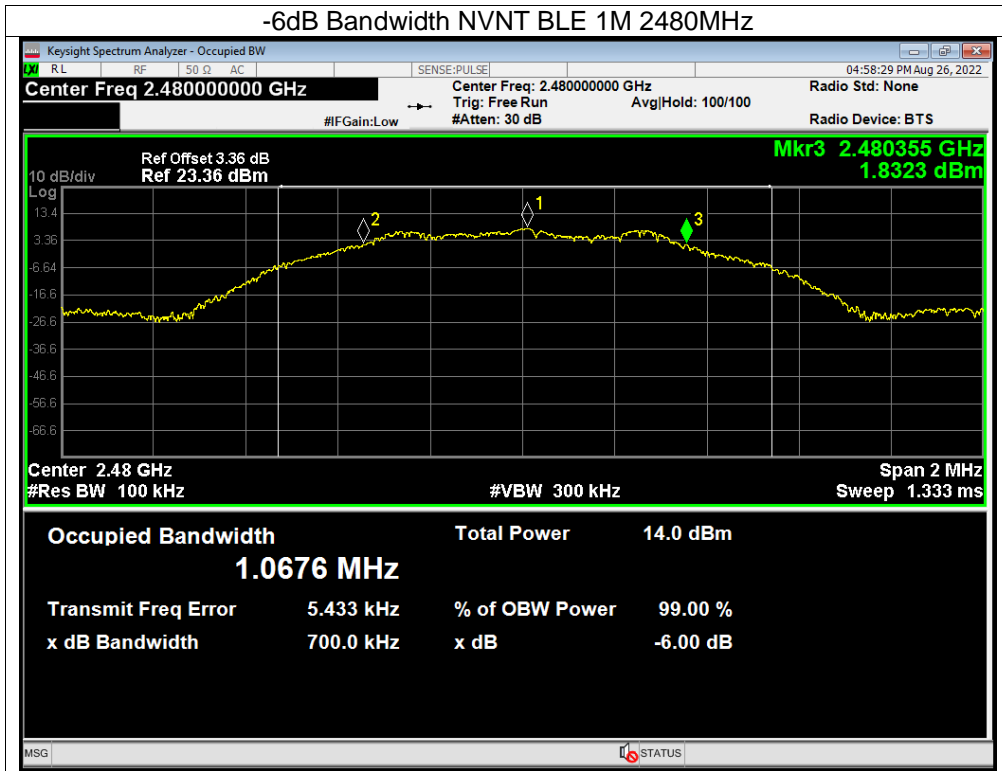

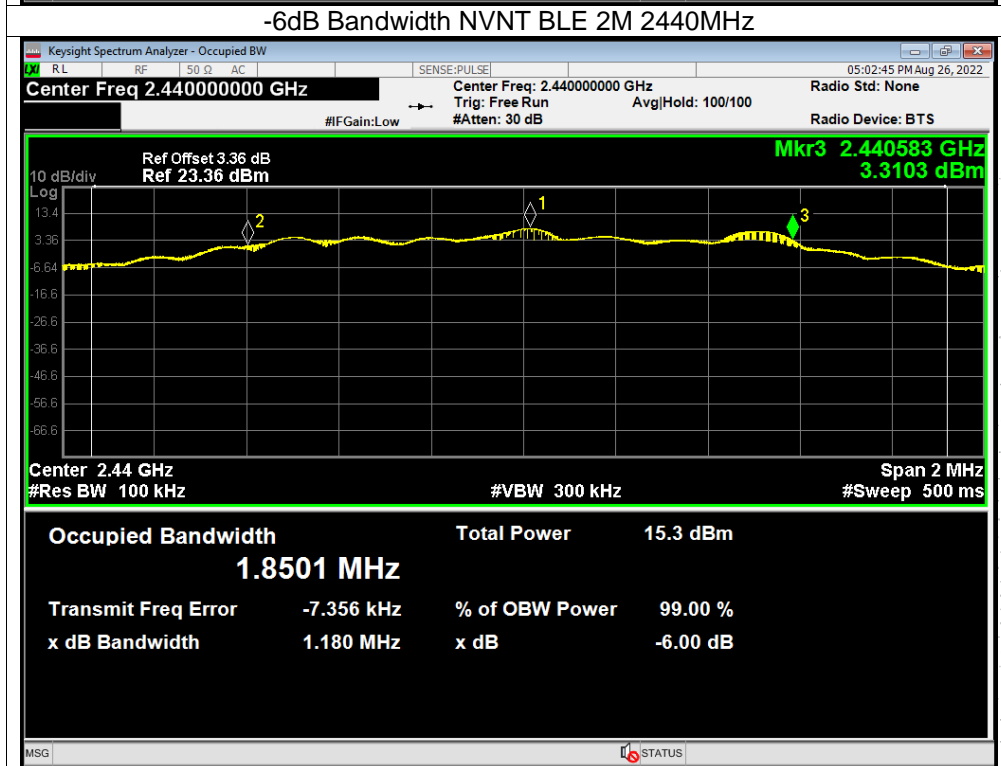
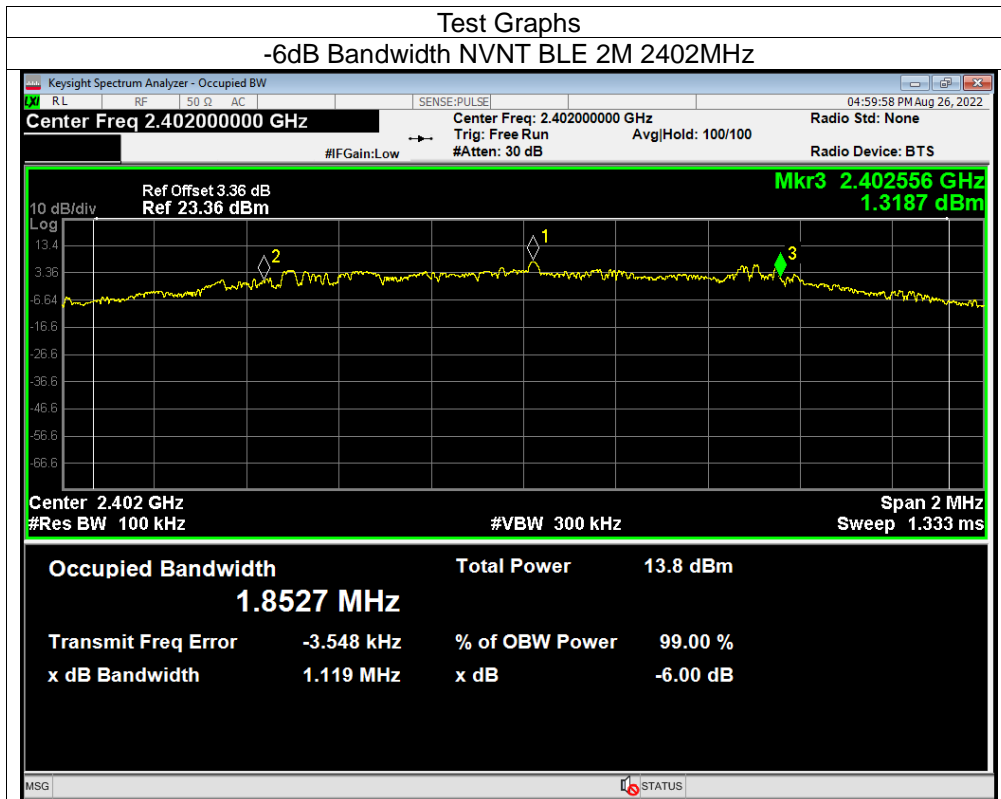

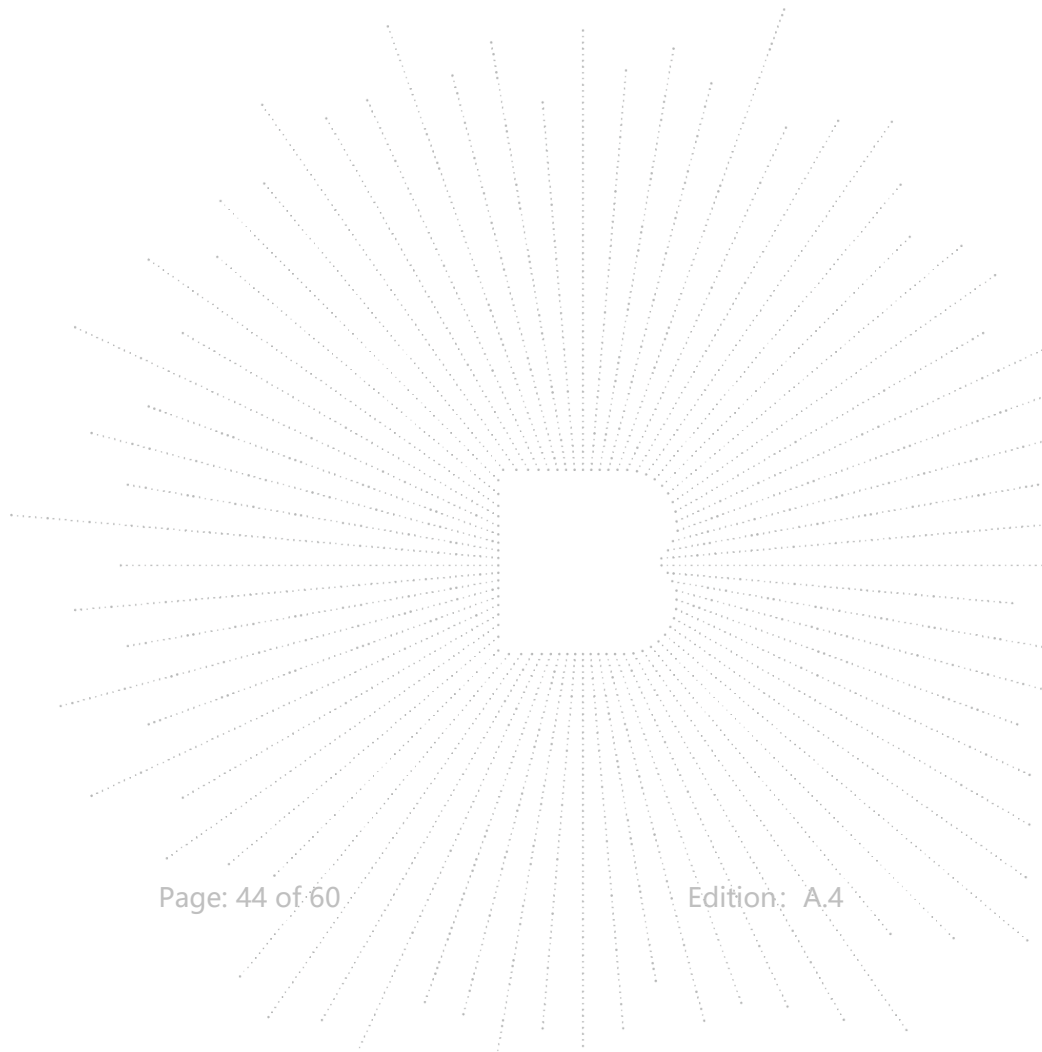
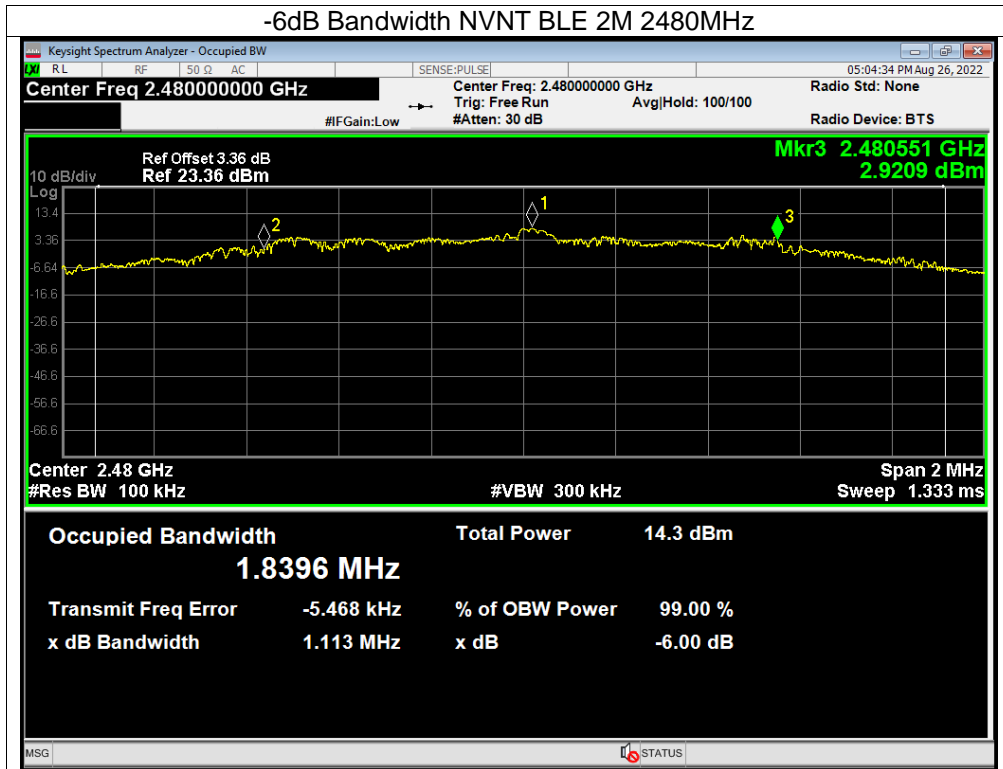

11. Peak Output Power Test

11.1 Block Diagram Of Test Setup



11.2 Limit

FCC Part15 (15.247) , Subpart C				
Section	Test Item	Limit	Frequency Range (MHz)	Result
15.247(b)(3)	Peak Output Power	1 watt or 30dBm	2400-2483.5	PASS

11.3 Test Procedure

- a. The EUT was directly connected to the Power meter

11.4 EUT Operating Conditions

The EUT tested system was configured as the statements of 4.6 Unless otherwise a special operating condition is specified in the follows during the testing.

Note: Power Spectral Density(dBm)=Reading+Cable Loss

11.5 Test Result

Temperature:	26 °C	Relative Humidity:	54%
Pressure:	101KPa	Test Voltage :	DC5V

Mode	Frequency(MHz)	Maximum Conducted Output Power(PK) (dBm)	Conducted Output Power Limit(dBm)
BLE 1M	2402	7.80	30
	2440	8.04	30
	2480	8.09	30
BLE 2M	2402	7.80	30
	2440	8.04	30
	2480	8.08	30

12. 100 kHz Bandwidth Of Frequency Band Edge

12.1 Block Diagram Of Test Setup



12.2 Limit

In any 100 kHz bandwidth outside the frequency band in which the spread spectrum intentional radiator is operating, the radio frequency power that is produced by the intentional radiator shall be at least 20 dB below that in the 100 kHz bandwidth within the band that contains the highest level of the desired power, based on either an RF conducted or a radiated measurement.

12.3 Test procedure

Using the following spectrum analyzer setting:

- Set the RBW = 100KHz.
- Set the VBW = 300KHz.
- Sweep time = auto couple.
- Detector function = peak.
- Trace mode = max hold.
- Allow trace to fully stabilize.

12.4 EUT operating Conditions

The EUT tested system was configured as the statements of 4.6 Unless otherwise a special operating condition is specified in the follows during the testing.

Note: Power Spectral Density(dBm)=Reading+Cable Loss

12.5 Test Result

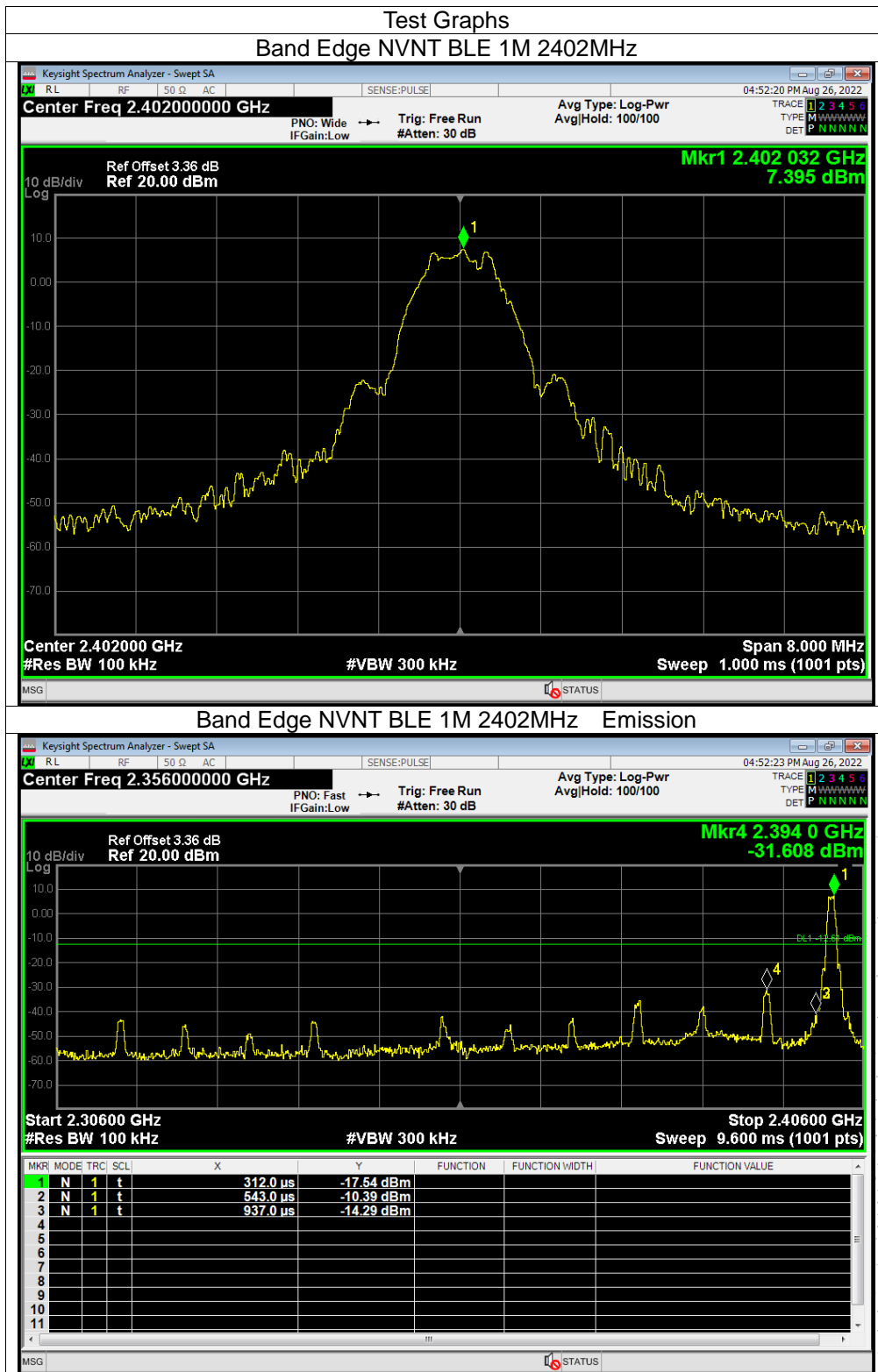

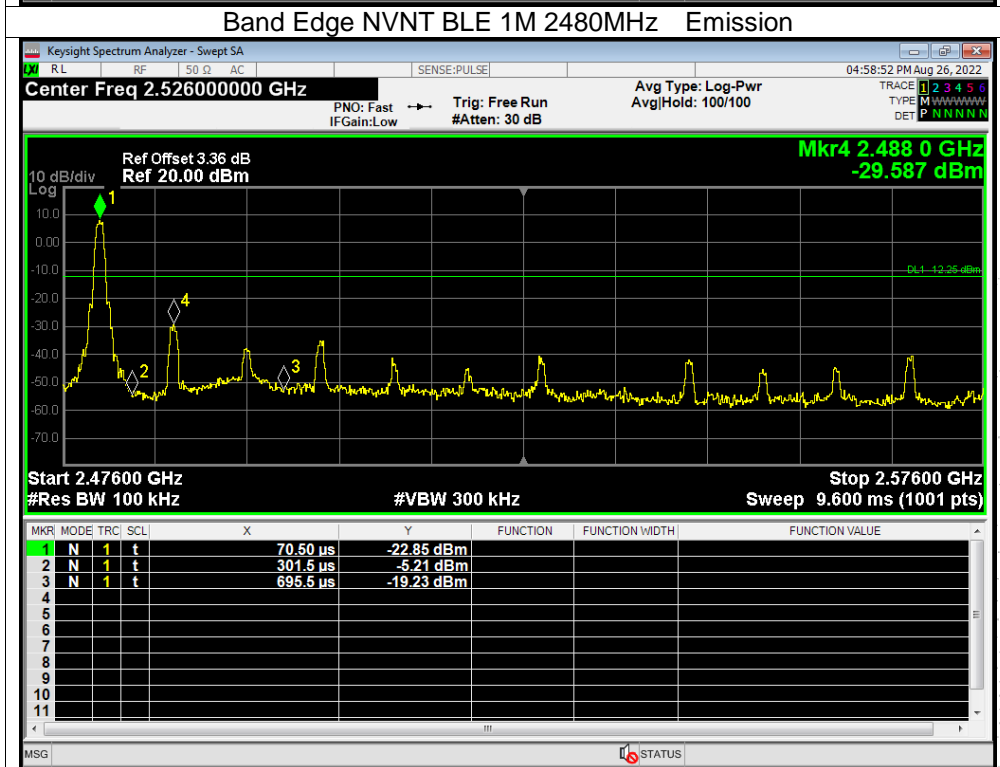
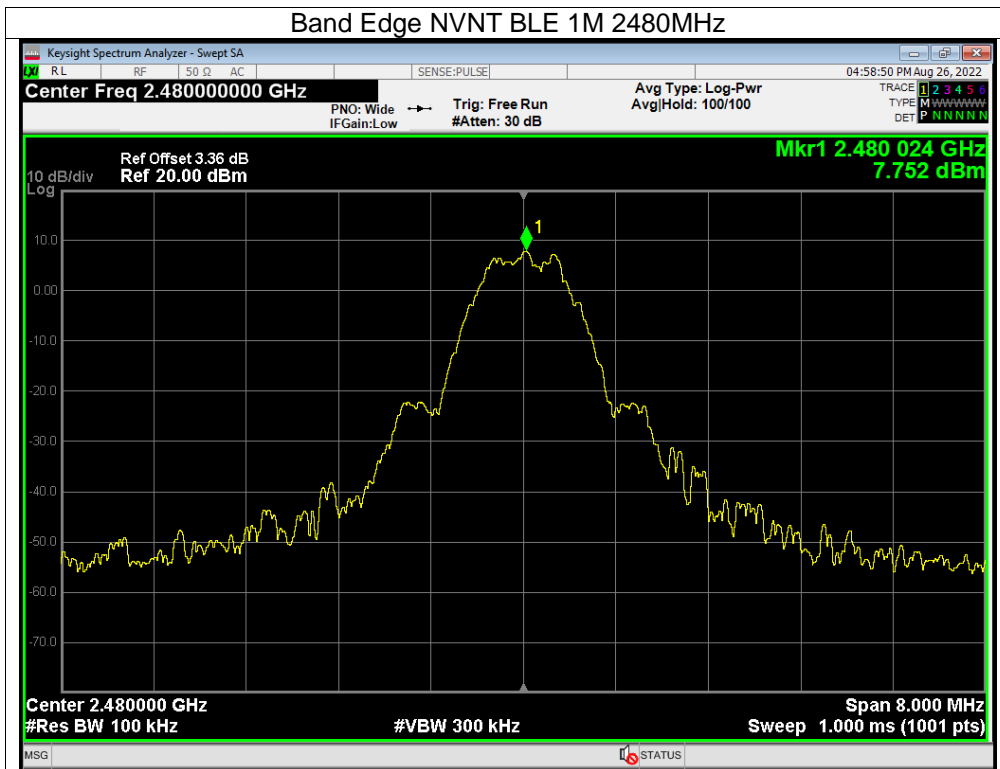

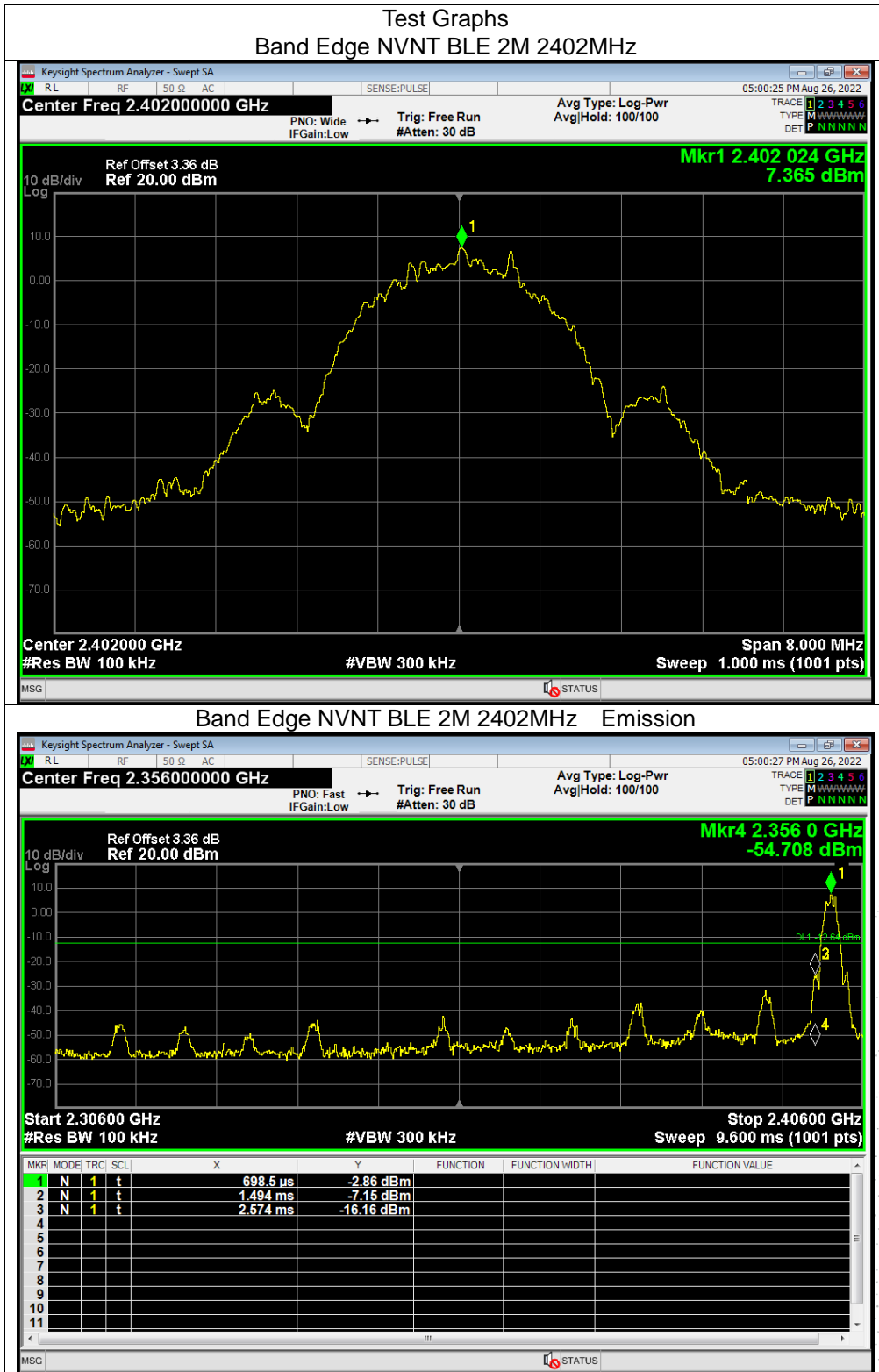

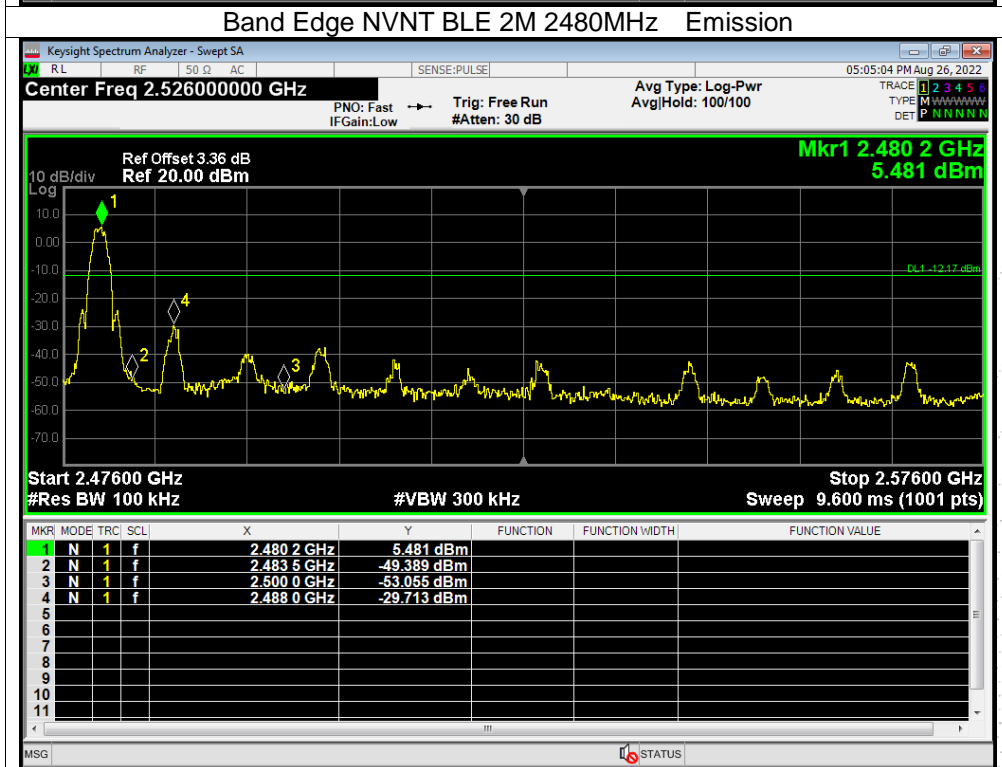
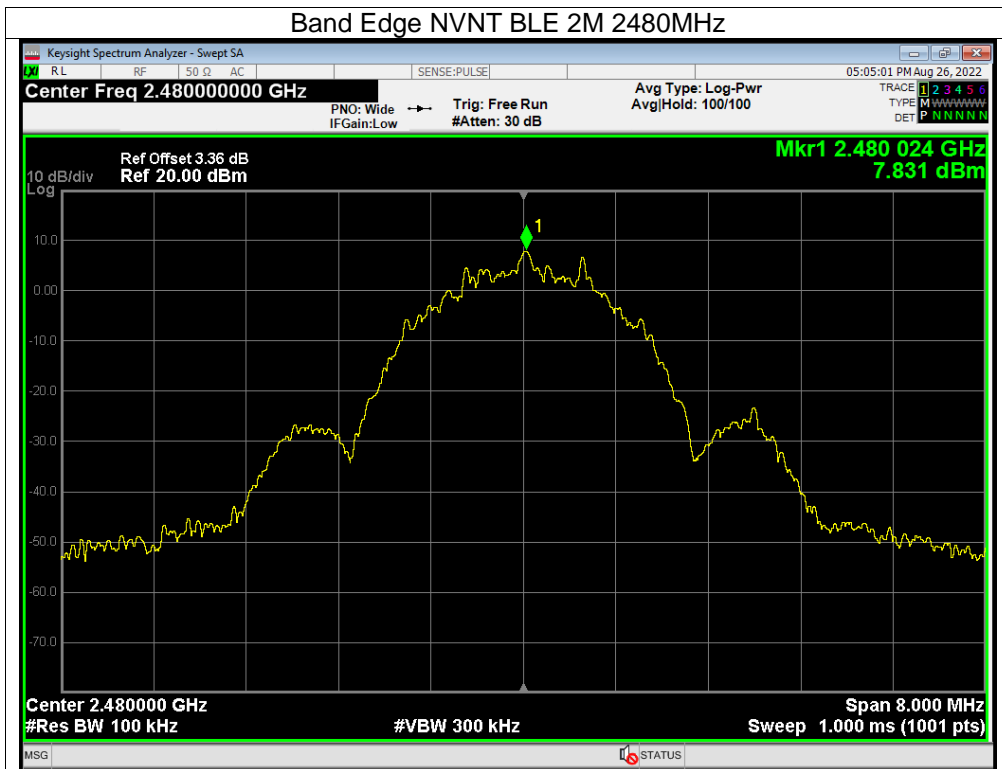

Conducted Emission Measurement

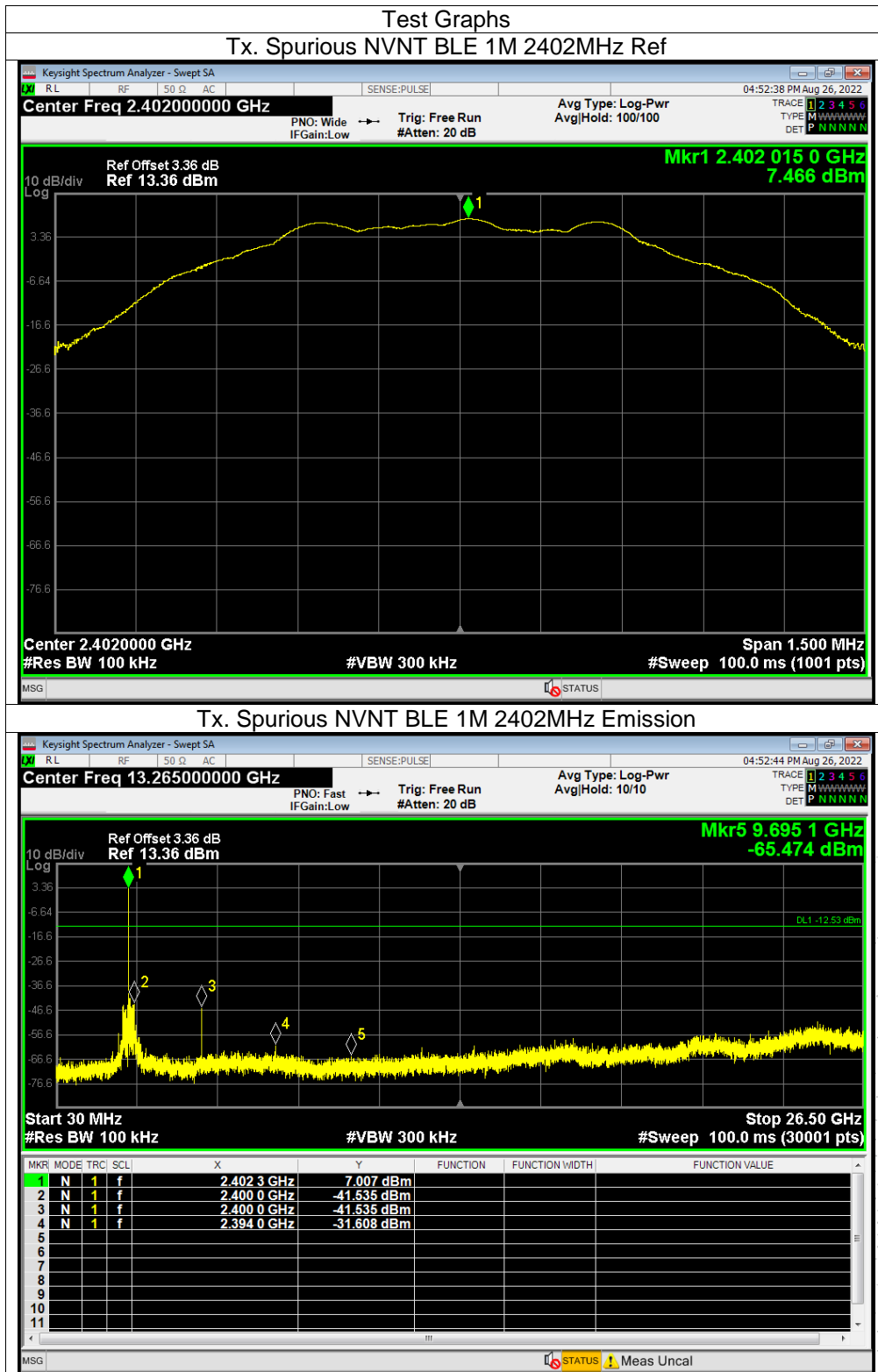

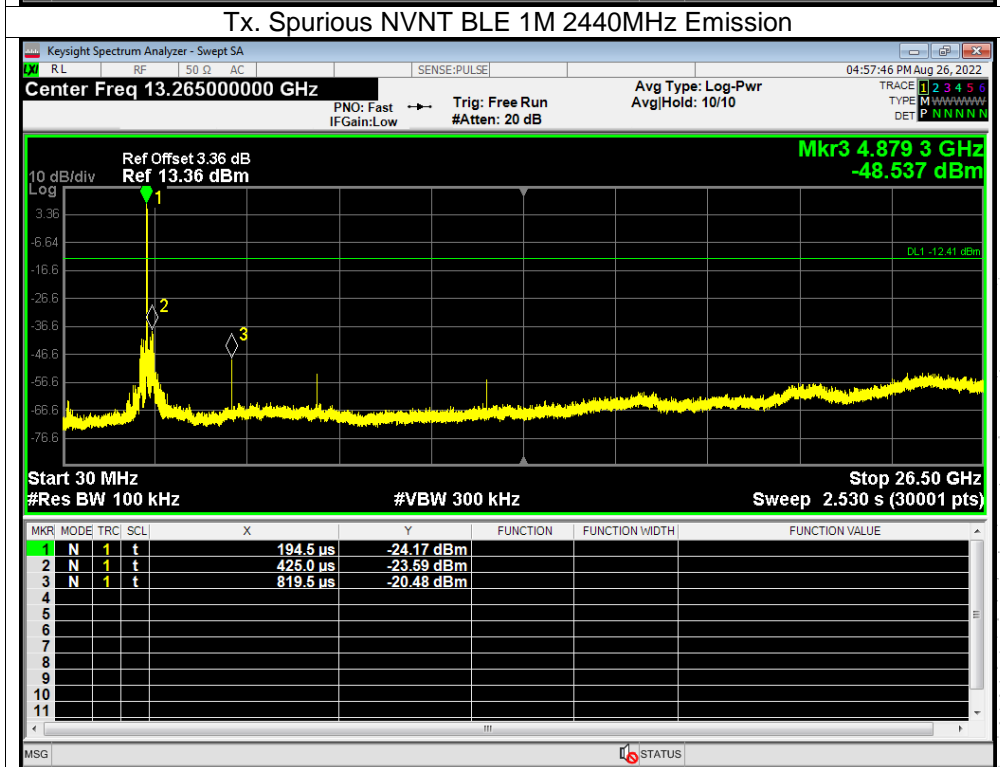
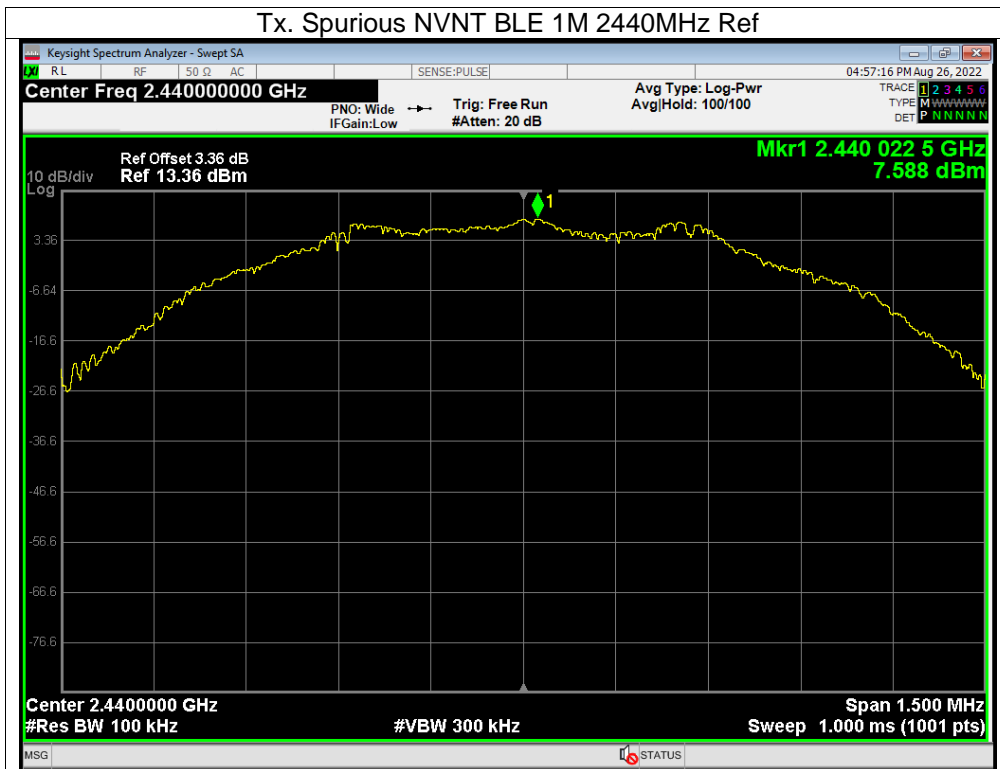

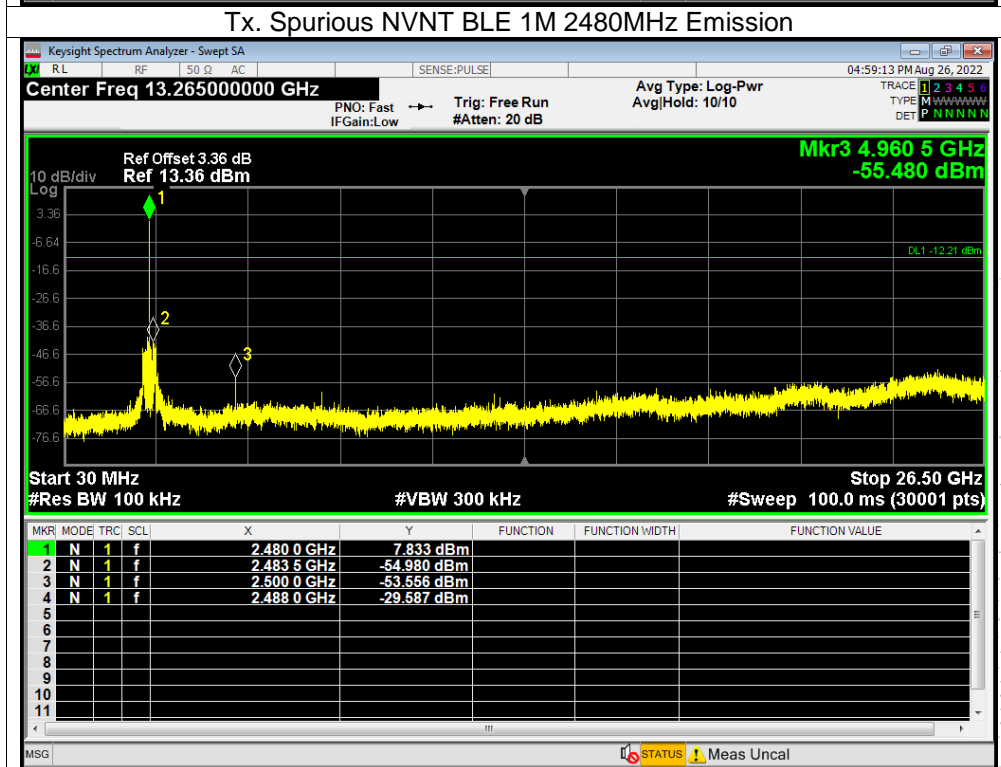
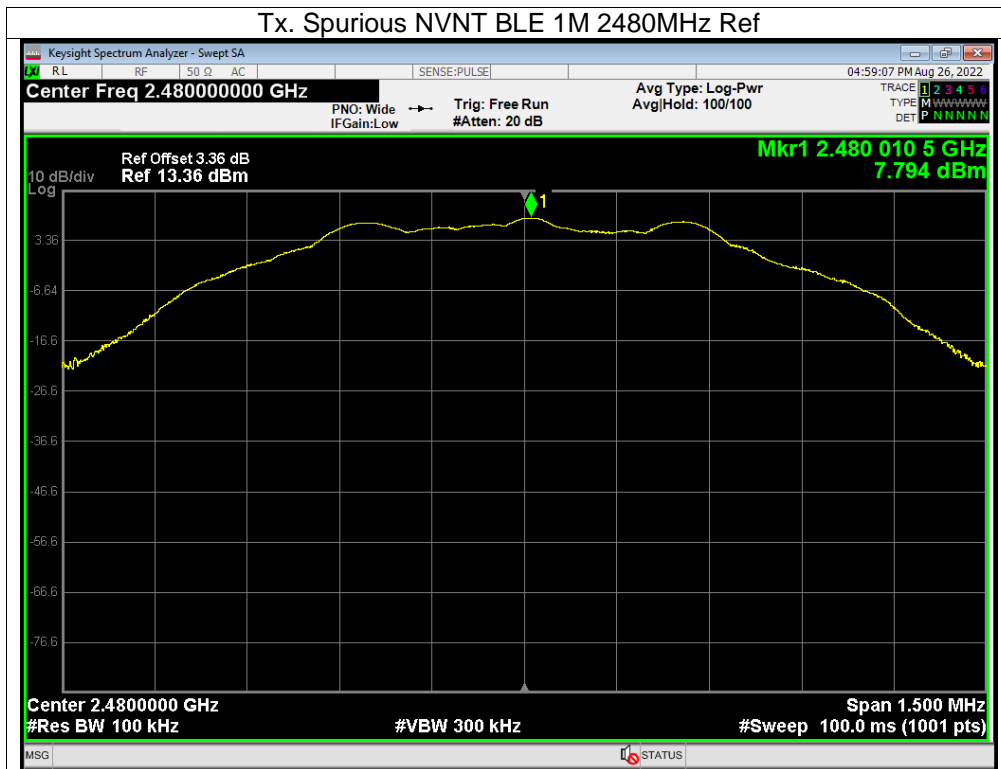

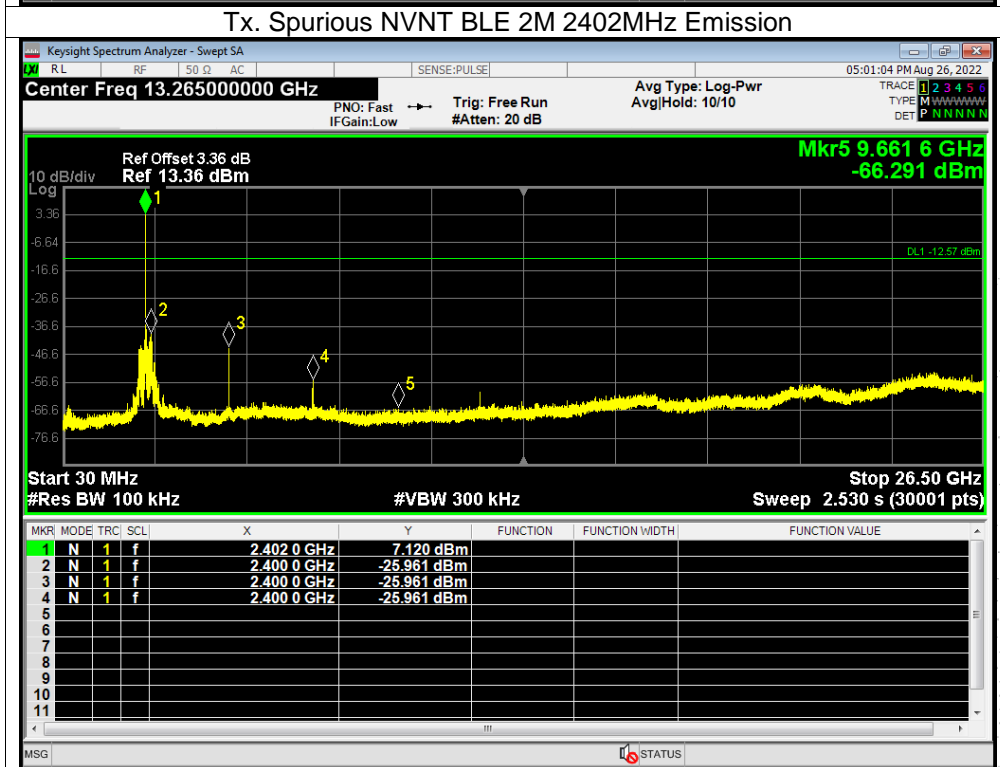
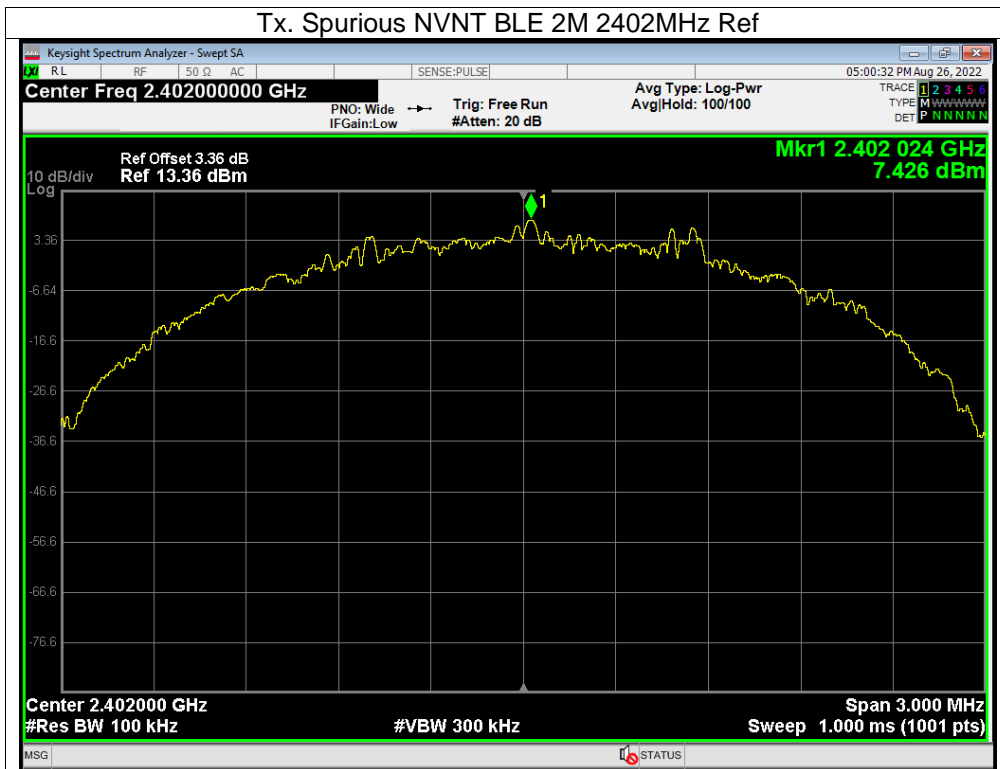

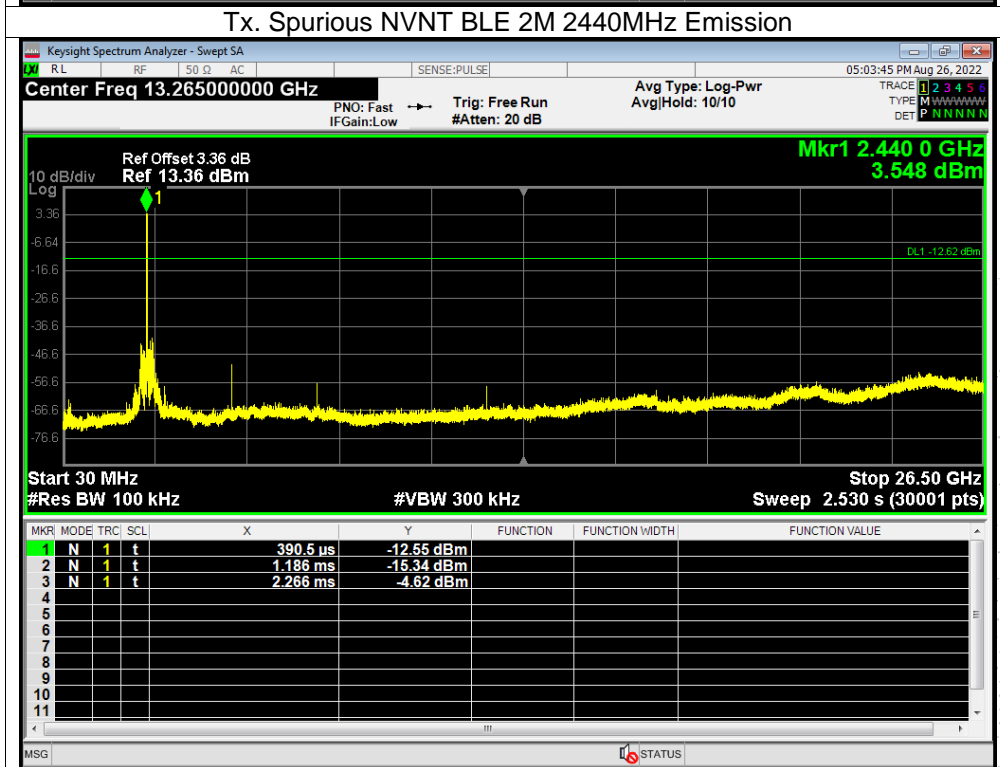
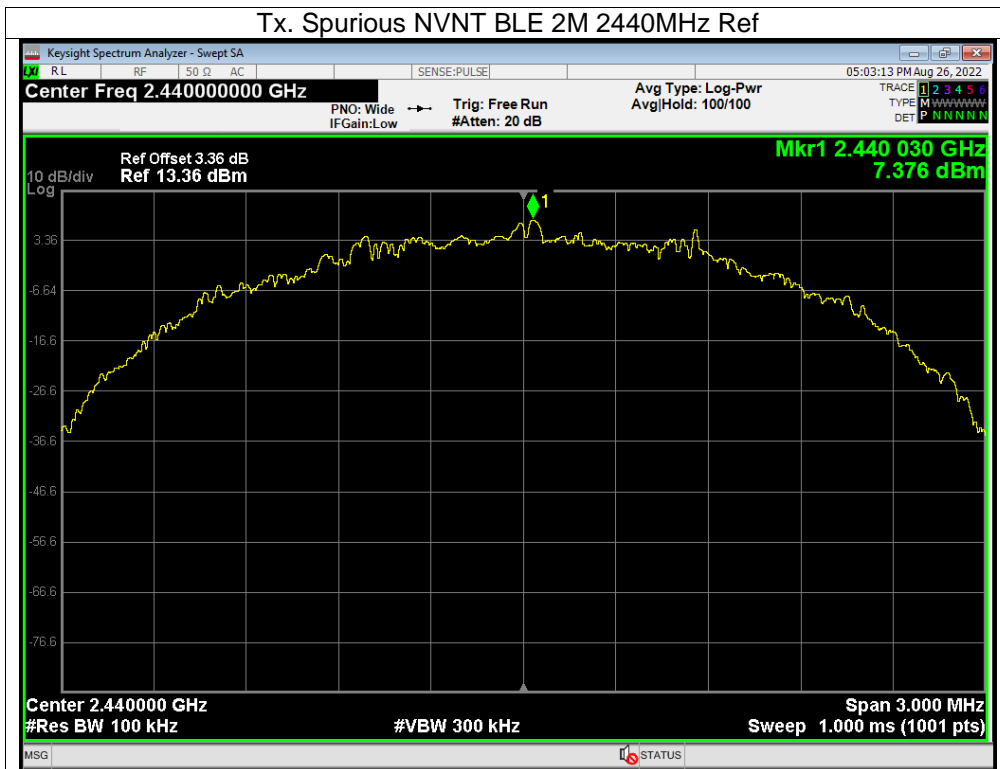

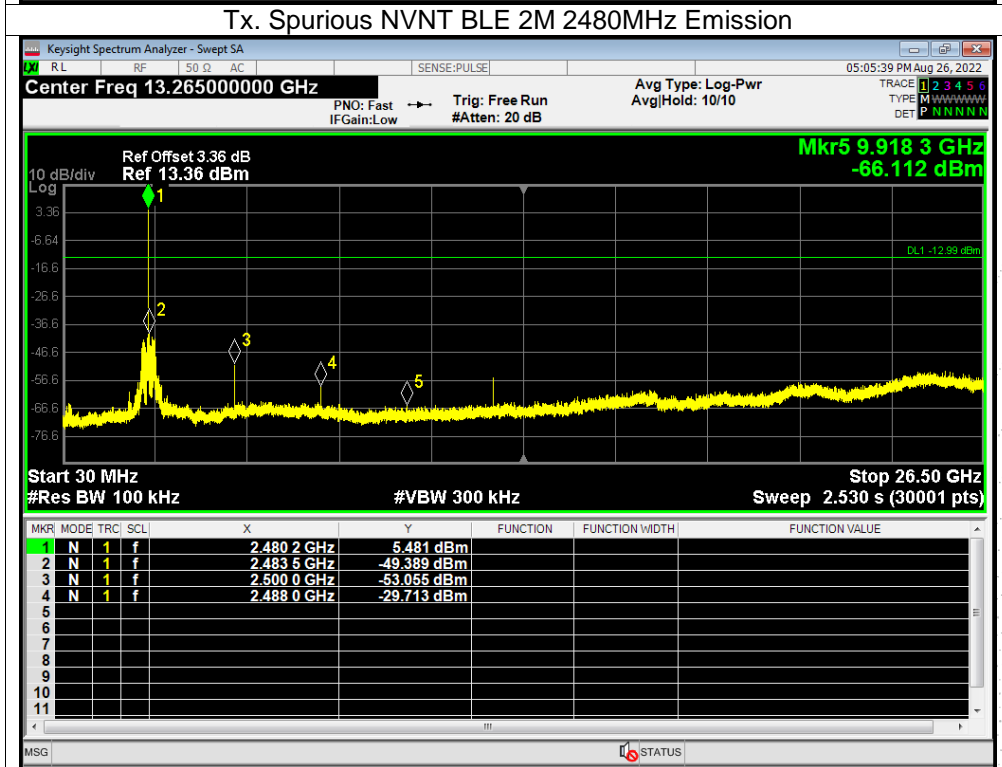
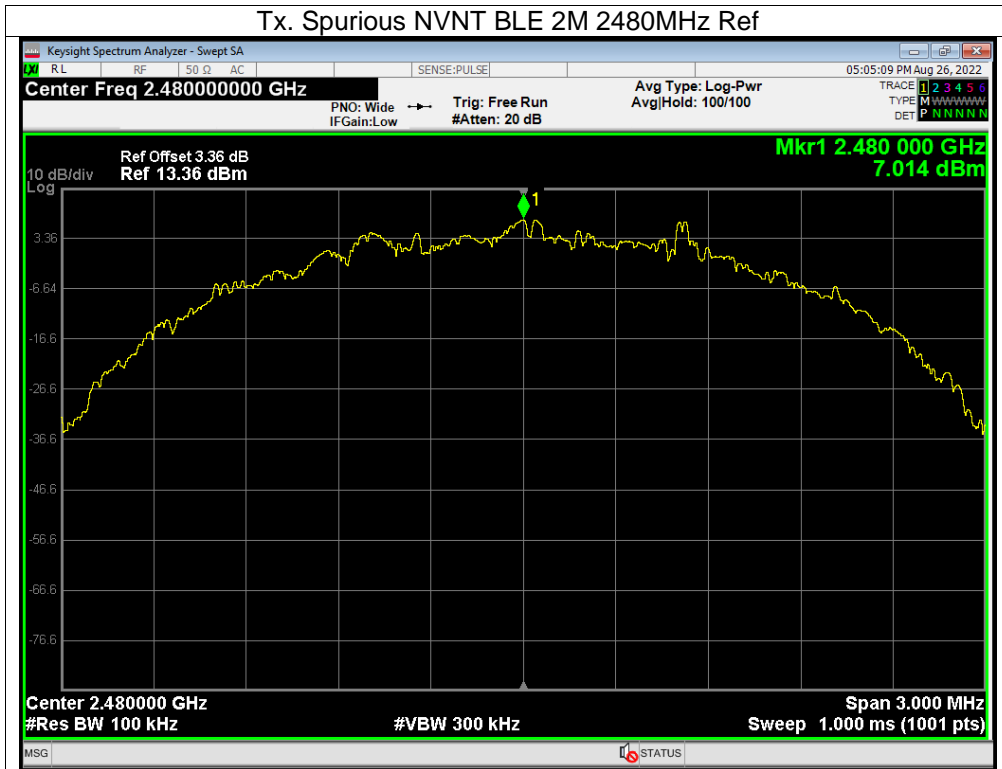

13. Antenna Requirement

13.1 Limit

15.203 requirement: For intentional device, according to 15.203: an intentional radiator shall be designed to ensure that no antenna other than that furnished by the responsible party shall be used with the device.

13.2 Test Result

The EUT antenna is PCB antenna, fulfill the requirement of this section.

14. EUT Test Setup Photographs

Conducted emissions Photo

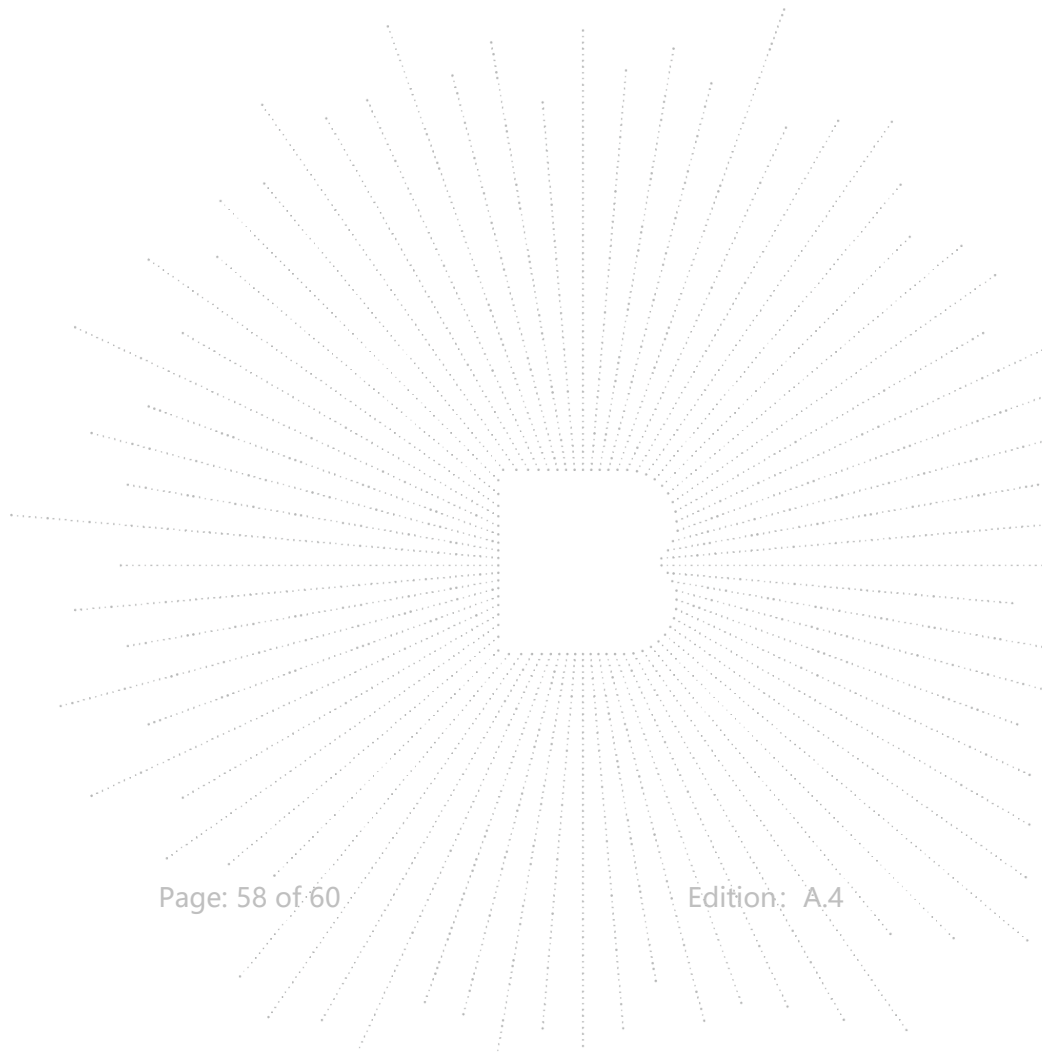

Radiated Measurement Photos

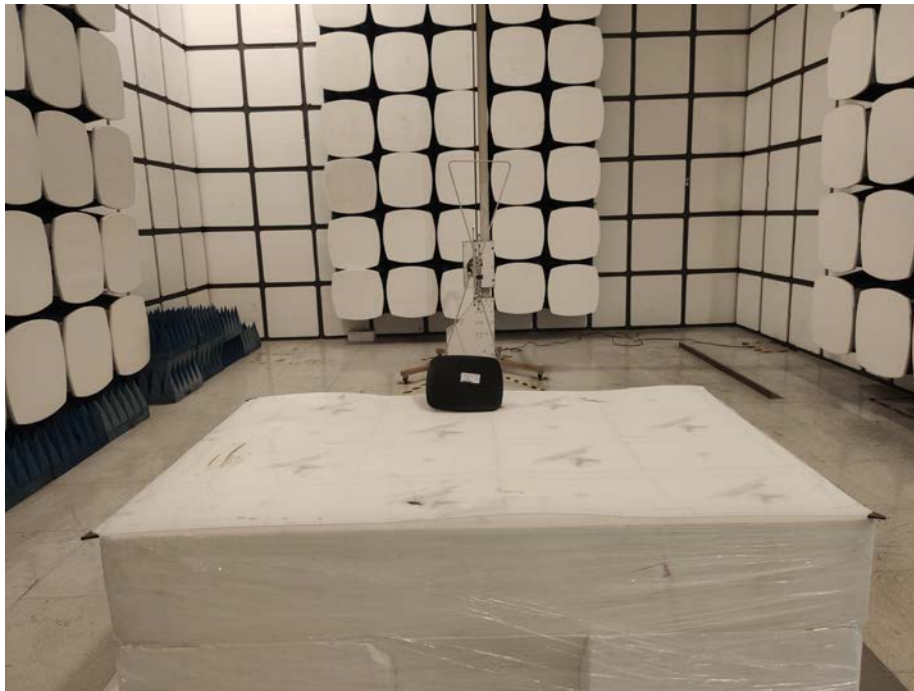

STATEMENT

- 1.The equipment lists are traceable to the national reference standards.
- 2.The test report can not be partially copied unless prior written approval is issued from our lab.
- 3.The test report is invalid without stamp of laboratory.
- 4.The test report is invalid without signature of person(s) testing and authorizing.
- 5.The test process and test result is only related to the Unit Under Test.
- 6.The quality system of our laboratory is in accordance with ISO/IEC17025.
- 7.If there is any objection to report, the client should inform issuing laboratory within 15 days from the date of receiving test report.

Address:

1-2/F., Building B, Pengzhou Industrial Park, No.158, Fuyuan 1st Road, Tangwei, Fuhai Subdistrict, Bao'an District, Shenzhen, Guangdong, China

TEL: 400-788-9558

P.C.: 518103

FAX: 0755-33229357

Website: <http://www.chnbctc.com>

E-Mail: bctc@bctc-lab.com.cn

***** END *****