

FCC Test Report

(Class II Permissive Change)

Product Name	WiFi SOM Module
Model No.	MS-01
FCC ID.	2ABTU-MS01

Applicant	RuggON Corporation
Address	4F, No. 298, Yang Guang St., Neihu Dist., Taipei City, Taiwan

Date of Receipt	Dec. 06, 2019
Issued Date	Jan. 16, 2020
Report No.	19C0098R-RFUSP01V00-A
Report Version	V1.0



The test results relate only to the samples tested.

The test results shown in the test report are traceable to the national/international standard through the calibration report of the equipment and evaluated measurement uncertainty herein.

This report must not be used to claim product endorsement by TAF or any agency of the government.

The test report shall not be reproduced without the written approval of DEKRA Testing and Certification Co., Ltd.

Test Report

Issued Date: Jan. 16, 2020
 Report No.: 19C0098R-RFUSP01V00-A



Product Name	WiFi SOM Module
Applicant	RuggON Corporation
Address	4F, No. 298, Yang Guang St., Neihu Dist., Taipei City, Taiwan
Manufacturer	RuggON Corporation
Model No.	MS-01
FCC ID.	2ABTU-MS01
EUT Rated Voltage	DC 3.3V
EUT Test Voltage	DC 3.3V
Trade Name	RuggON
Applicable Standard	FCC CFR Title 47 Part 15 Subpart C ANSI C63.4: 2014, ANSI C63.10: 2013
Test Result	Complied

Documented By :

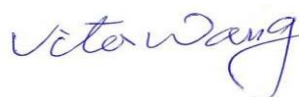

(Adm. Specialist / Vita Wang)

Tested By :



(Engineer / Sam Hsu)

Approved By :



(Director / Vincent Lin)

TABLE OF CONTENTS

Description	Page
1. GENERAL INFORMATION.....	4
1.1. EUT Description	4
1.2. Operational Description.....	6
1.3. Tested System Details.....	7
1.4. Configuration of Tested System	7
1.5. EUT Exercise Software	7
1.6. Test Facility.....	8
1.7. List of Test Item and Equipment	9
2. PEAK POWER OUTPUT.....	11
2.1. Test Setup.....	11
2.2. Limit	11
2.3. Test Procedure.....	11
2.4. Uncertainty.....	11
2.5. Test Result of Peak Power Output.....	12
3. RADIATED EMISSION	14
3.1. Test Setup.....	14
3.2. Limits.....	16
3.3. Test Procedure.....	17
3.4. Uncertainty.....	18
3.5. Test Result of Radiated Emission.....	19
4. BAND EDGE.....	37
4.1. Test Setup.....	37
4.2. Limit	38
4.3. Test Procedure.....	38
4.4. Uncertainty.....	39
4.5. Test Result of Band Edge.....	40
5. DUTY CYCLE.....	56
5.1. Test Setup.....	56
5.2. Test Procedure.....	56
5.3. Uncertainty.....	56
5.4. Test Result of Duty Cycle	57
6. EMI REDUCTION METHOD DURING COMPLIANCE TESTING.....	59
Attachment 1: EUT Test Photographs	
Attachment 2: EUT Detailed Photographs – Externa	
Attachment 3: EUT Detailed Photographs – Internal	

1. GENERAL INFORMATION

1.1. EUT Description

Product Name	WiFi SOM Module
Trade Name	RuggON
Model No.	MS-01
FCC ID.	2ABTU-MS01
Frequency Range	2402 – 2480MHz
Channel Number	V5.0: 40CH
Type of Modulation	V5.0: GFSK(1Mbps)/(2Mbps)
Antenna Type	PIFA Antenna
Channel Control	Auto
Antenna Gain	Refer to the table “Antenna List”

Antenna List

No.	Manufacturer	Part No.	Antenna Type	Peak Gain
1	AnJie	AJDP1J-B0006	PIFA	3.62dBi for 2.4 GHz

Note: The antenna of EUT is conform to FCC 15.203

Center Frequency of Each Channel:

Channel	Frequency	Channel	Frequency	Channel	Frequency	Channel	Frequency
Channel 00:	2402 MHz	Channel 01:	2404 MHz	Channel 02:	2406 MHz	Channel 03:	2408 MHz
Channel 04:	2410 MHz	Channel 05:	2412 MHz	Channel 06:	2414 MHz	Channel 07:	2416 MHz
Channel 08:	2418 MHz	Channel 09:	2420 MHz	Channel 10:	2422 MHz	Channel 11:	2424 MHz
Channel 12:	2426 MHz	Channel 13:	2428 MHz	Channel 14:	2430 MHz	Channel 15:	2432 MHz
Channel 16:	2434 MHz	Channel 17:	2436 MHz	Channel 18:	2438 MHz	Channel 19:	2440 MHz
Channel 20:	2442 MHz	Channel 21:	2444 MHz	Channel 22:	2446 MHz	Channel 23:	2448 MHz
Channel 24:	2450 MHz	Channel 25:	2452 MHz	Channel 26:	2454 MHz	Channel 27:	2456 MHz
Channel 28:	2458 MHz	Channel 29:	2460 MHz	Channel 30:	2462 MHz	Channel 31:	2464 MHz
Channel 32:	2466 MHz	Channel 33:	2468 MHz	Channel 34:	2470 MHz	Channel 35:	2472 MHz
Channel 36:	2474 MHz	Channel 37:	2476 MHz	Channel 38:	2478 MHz	Channel 39:	2480 MHz

Note:

1. The EUT is an WiFi SOM Module , contains functions WLAN (802.11a/b/g/n/ac) with Bluetooth (V5.0 and V3.0+HS, V2.1+EDR) combo card module transceiver ,this report for Bluetooth V5.0.
2. These tests were conducted on a sample for the purpose of demonstrating compliance of transmitter with Part 15 Subpart C Paragraph 15.247 for spread spectrum devices.
3. Regarding to the operation frequency, the lowest, middle and highest frequency are selected to perform the test.
4. This is to request a Class II permissive change for FCC ID: 2ABTU-MS01, originally granted on 12/24/2019.

The major change filed under this application is:

Change #1: Addition an new antenna, antenna type is different with the original application.
(Antenna type: PIFA antenna)

Test Mode	Mode 1: Bluetooth LE 1Mbps Mode 2: Bluetooth LE 2Mbps
-----------	--

1.3. Tested System Details

The types for all equipment, plus descriptions of all cables used in the tested system (including inserted cards) are:

Product	Manufacturer	Model No.	Serial No.	Power Cord
1 Notebook PC	DELL	Latitude 5580	2HRD7H2	Non-Shielded, 0.8m
2 Test Fixture	RuggON	N/A	N/A	N/A

Signal Cable Type	Signal cable Description
A USB Cable	Shielded, 1m
B Power Cable	Shielded, 1.8m

1.4. Configuration of Tested System

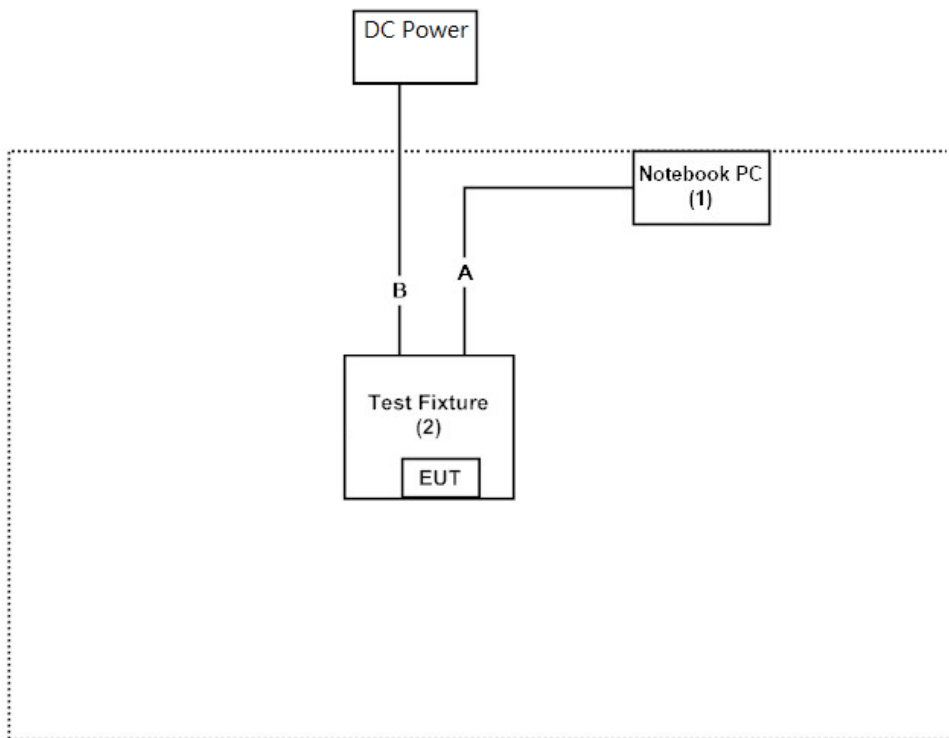

1.5. EUT Exercise Software

- (1) Setup the EUT as shown on 1.4
- (2) Execute software “QRCT3 V3.0.268.0” on the EUT.
- (3) Configure the test mode, the test channel, and the data rate.
- (4) Start the continuous transmission.
- (5) Verify that the EUT works properly.

1.6. Test Facility

Ambient conditions in the laboratory:

Items	Required (IEC 68-1)	Actual
Temperature (°C)	15-35	20-35
Humidity (%RH)	25-75	50-65
Barometric pressure (mbar)	860-1060	950-1000

USA : FCC Registration Number: TW3023

Canada : IC Registration Number: 4075A

Site Description: Accredited by TAF
Accredited Number: 3023

Test Laboratory: DEKRA Testing and Certification Co., Ltd
Address: No.5-22, Ruishukeng, Linkou Dist., New Taipei City 24451,
Taiwan, R.O.C.

Phone number: 886-2-8601-3788

Fax number: 886-2-8601-3789

Email address: info.tw@dekra.com

Website: <http://www.dekra.com.tw>

1.7. List of Test Item and Equipment

For Conducted measurements /CB3/SR8

	Equipment	Manufacturer	Model No.	Serial No.	Cali. Date	Due. Date
	Temperature Chamber	WIT GROUP	TH-1S-B	EQ-201-00146	<u>2019/02/26</u>	2020/02/25
X	Spectrum Analyzer	Agilent	N9010A	MY53470892	2019/09/25	2020/09/24
X	Peak Power Analyzer	Keysight	8990B	MY51000410	2019/07/30	2020/07/29
X	Wideband Power Sensor	Keysight	N1923A	MY56080003	2019/07/30	2020/07/29
X	Wideband Power Sensor	Keysight	N1923A	MY56080004	2019/07/30	2020/07/29
X	EMI Test Receiver	R&S	ESCS 30	100369	<u>2019/11/19</u>	2020/11/18
X	LISN	R&S	ENV216	101105	2019/04/10	2020/04/09
X	LISN	R&S	ESH3-Z5	836679/014	2019/04/10	2020/04/09
X	Coaxial Cable	DEKRA	RG 400	LC018-RG	2019/06/20	2020/06/19

Note:

1. All equipments are calibrated every one year.
2. The test instruments marked with "X" are used to measure the final test results.
3. Test Software version : DEKRA Conduction Test SystemV9.0.5.

For Radiated measurements /Site3/CB8

	Equipment	Manufacturer	Model No.	Serial No.	Cali. Date	Due. Date
X	Spectrum Analyzer	R&S	FSP40	100170	<u>2019/03/11</u>	2020/03/10
X	Loop Antenna	Teseq	HLA6121	37133	2019/10/15	2021/10/14
X	Bilog Antenna	Schaffner Chase	CBL6112B	2794	2019/06/23	2020/06/22
X	Coaxial Cable	DEKRA	L1907-001C	280280.F141.1000D	2019/07/10	2020/07/09
X	Amplifier	EMCI	EMC001330	980254	2019/08/22	2020/08/21
X	Horn Antenna	ETS-LINDGREN	3117	00228113	<u>2019/05/02</u>	2020/05/01
	Coaxial Cable	DEKRA	L1907-002C	280280.F141.1000D	2019/07/10	2020/07/09
X	Amplifier	EMCI	EMC05820SE	980362	2019/06/26	2020/06/25
	Amplifier	EMCI	EMC051845SE	SN980632	2019/08/08	2020/08/07
X	Horn Antenna	Com-Power	AH-1840	101101	2019/10/31	2020/10/30
X	Amplifier + Cable	EMCI	EMC184045SE	980369	2019/04/16	2020/04/15
	Bilog Antenna	Schaffner Chase	CBL6112B	2916	2019/06/23	2020/06/22
	Coaxial Cable	DEKRA	L1907-003C	00100A1B3A120M	2019/07/10	2020/07/09
	Amplifier	EMCI	EMC001330	980255	2019/06/28	2020/06/27
X	Filter	MICRO-TRONICS	BRM50702	G270	2019/08/08	2020/08/07
X	Filter	MICRO-TRONICS	BRM50716	G196	2019/08/08	2020/08/07

Note:

1. Loop Antenna is calibrated every two years, the other equipments are calibrated every one year.
2. The test instruments marked with "X" are used to measure the final test results.
3. Test Software version : DEKRA Test SystemV1.1.

2. Peak Power Output

2.1. Test Setup

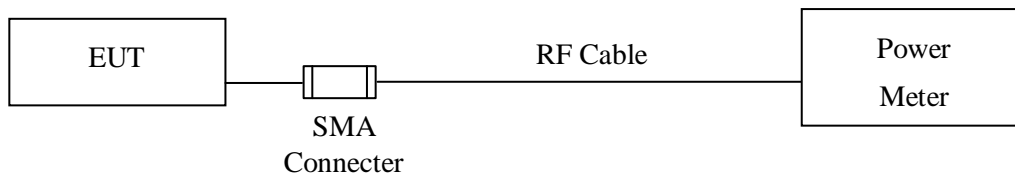

2.2. Limit

The maximum peak power shall be less 1Watt.

2.3. Test Procedure

Tested according to DTS test procedure of KDB 558074 for compliance to FCC 47CFR 15.247 requirements. The maximum peak conducted output power using KDB 558074 section 9.1.3 PKPM1 Peak power meter method.

2.4. Uncertainty

± 1.27 dB

2.5. Test Result of Peak Power Output

Product : WiFi SOM Module
Test Item : Peak Power Output
Test date : 2019/12/27
Test Mode : Mode 1: Bluetooth LE 1Mbps

Channel No.	Frequency (MHz)	Measurement (dBm)	Required Limit	Result
Channel 00	2402.00	2.03	1 Watt= 30 dBm	Pass
Channel 19	2440.00	1.33	1 Watt= 30 dBm	Pass
Channel 39	2480.00	2.12	1 Watt= 30 dBm	Pass

Product : WiFi SOM Module
Test Item : Peak Power Output
Test date : 2019/12/27
Test Mode : Mode 2: Bluetooth LE 2Mbps

Channel No.	Frequency (MHz)	Measurement (dBm)	Required Limit	Result
Channel 00	2402.00	2.20	1 Watt= 30 dBm	Pass
Channel 19	2440.00	1.49	1 Watt= 30 dBm	Pass
Channel 39	2480.00	2.27	1 Watt= 30 dBm	Pass

3. Radiated Emission

3.1. Test Setup

Under 30MHz

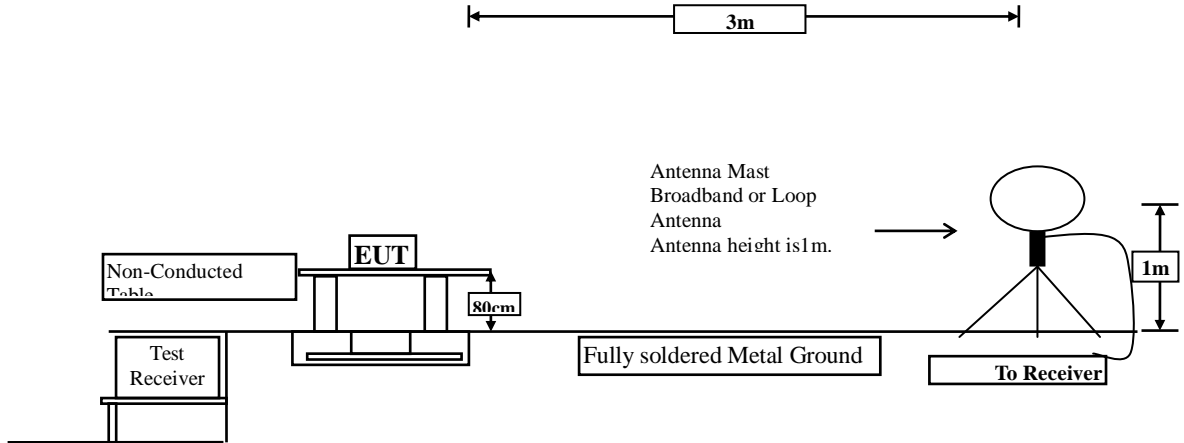

Below 1GHz

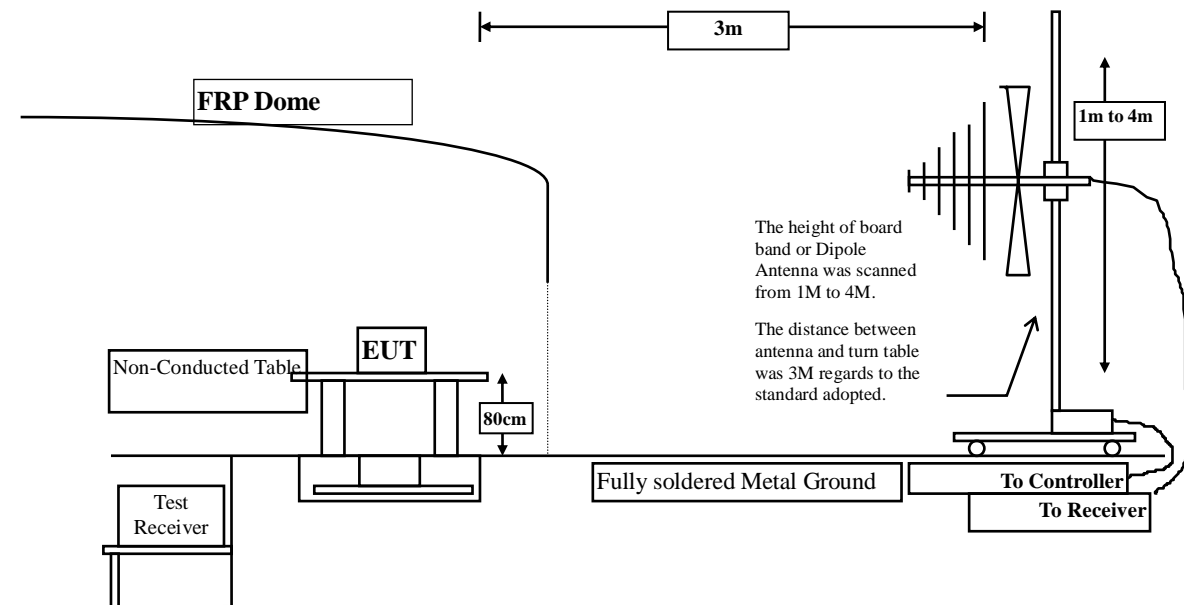

Above 1GHz

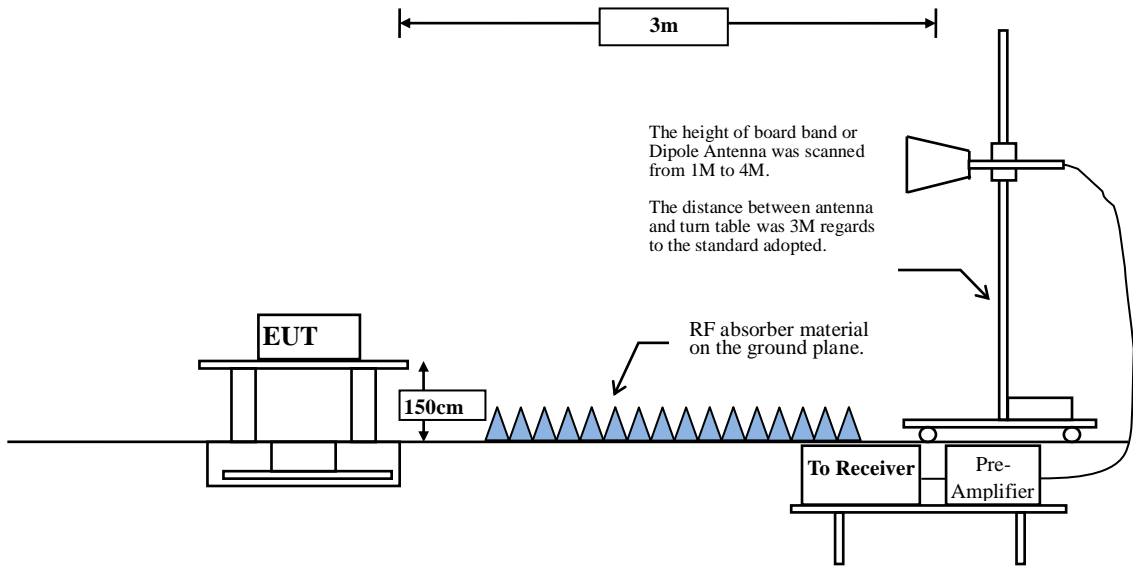

3.2. Limits

➤ General Radiated Emission Limits

Emissions radiated outside of the specified frequency bands, except for harmonics, shall be attenuated by at least 20dB below the level of the fundamental or to the general radiated emission limits in paragraph 15.209, whichever is the lesser attenuation.

FCC Part 15 Subpart C Paragraph 15.209 Limits		
Frequency MHz	Field strength (microvolts/meter)	Measurement distance (meter)
0.009-0.490	2400/F(kHz)	300
0.490-1.705	24000/F(kHz)	30
1.705-30	30	30
30-88	100	3
88-216	150	3
216-960	200	3
Above 960	500	3

- Remarks:
1. RF Voltage (dBuV) = 20 log RF Voltage (uV)
 2. In the Above Table, the tighter limit applies at the band edges.
 3. Distance refers to the distance in meters between the measuring instrument antenna and the closed point of any part of the device or system.

3.3. Test Procedure

The EUT was setup according to ANSI C63.10: 2013 and tested according to DTS test procedure of KDB558074 for compliance to FCC 47CFR 15.247 requirements.

Measuring the frequency range below 1GHz, the EUT is placed on a turn table which is 0.8 meter above ground, when measuring the frequency range above 1GHz, the EUT is placed on a turn table which is 1.5 meter above ground.

The turn table is rotated 360 degrees to determine the position of the maximum emission level.

The EUT was positioned such that the distance from antenna to the EUT was 3 meters.

The antenna is scanned between 1 meter and 4 meters to find out the maximum emission level. This is repeated for both horizontal and vertical polarization of the antenna. In order to find the maximum emission, all of the interface cables were manipulated according to ANSI C63.10: 2013 on radiated measurement.

The resolution bandwidth below 30MHz setting on the field strength meter is 9kHz and 30MHz~1GHz is 120kHz and above 1GHz is 1MHz.

Radiated emission measurements below 30MHz are made using Loop Antenna and 30MHz~1GHz are made using broadband Bilog antenna and above 1GHz are made using Horn Antennas.

The measurement is divided into the Preliminary Measurement and the Final Measurement.

The suspected frequencies are searched for in Preliminary Measurement with the measurement antenna kept pointed at the source of the emission both in azimuth and elevation, with the polarization of the antenna oriented for maximum response. The antenna is pointed at an angle towards the source of the emission, and the EUT is rotated in both height and polarization to maximize the measured emission. The emission is kept within the illumination area of the 3 dB bandwidth of the antenna.

The worst radiated emission is measured in the Open Area Test Site on the Final Measurement.

The measurement frequency range from 9kHz - 10th Harmonic of fundamental was investigated.

RBW and VBW Parameter setting:

According to KDB 558074 Peak power measurement procedure

RBW = as specified in Table 1.

$VBW \geq 3 \times RBW$.

Table 1 —RBW as a function of frequency

Frequency	RBW
9-150 kHz	200-300 Hz
0.15-30 MHz	9-10 kHz
30-1000 MHz	100-120 kHz
> 1000 MHz	1 MHz

According to KDB 558074 Average power measurement procedure

RBW = 1MHz.

VBW = 10Hz, when duty cycle $\geq 98\%$

$VBW \geq 1/T$, when duty cycle $< 98\%$

(T refers to the minimum transmission duration over which the transmitter is on and is transmitting at its maximum power control level for the tested mode of operation.)

2.4GHz band	Duty Cycle (%)	T (ms)	1/T (Hz)	VBW (Hz)
BLE 1M	62.50	0.3913	2556	3000
BLE 2M	32.71	0.2044	4894	5000

Note: Duty Cycle Refer to Section 5.

3.4. Uncertainty

± 4.08 dB above 1GHz

± 4.22 dB below 1GHz

3.5. Test Result of Radiated Emission

Product : WiFi SOM Module
 Test Item : Harmonic Radiated Emission
 Test Site : No.3 OATS
 Test date : 2020/01/02
 Test Mode : Mode 1: Bluetooth LE 1Mbps(2402MHz)

Horizontal

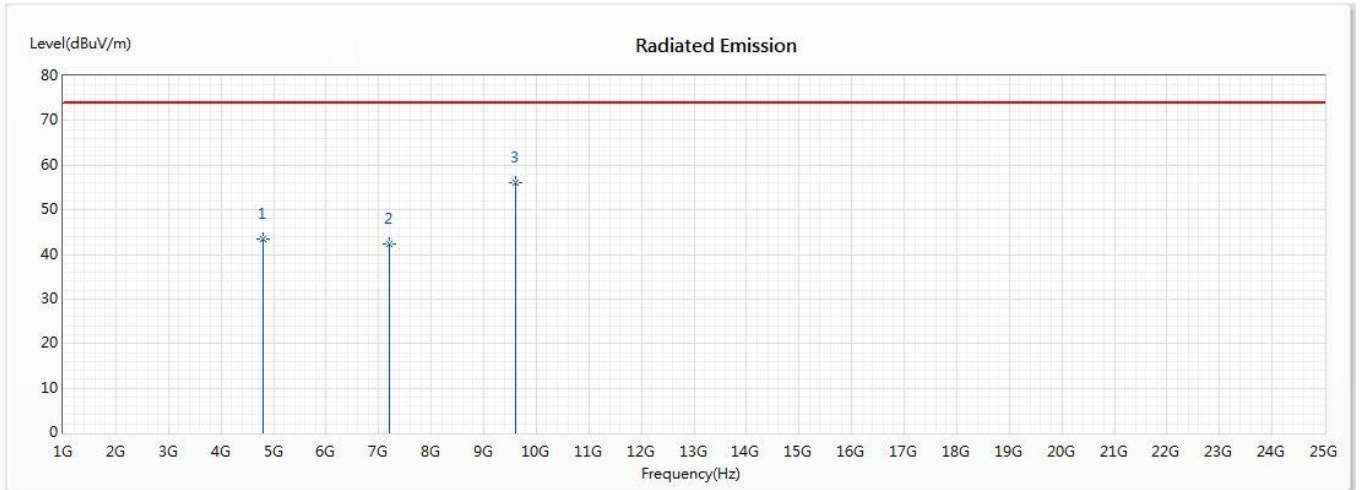

No	Frequency (MHz)	Emission Level (dBuV/m)	Limit (dBuV/m)	Margin (dB)	Reading Level (dBuV)	Correct Factor (dB/m)	Detector Type
1	4804	43.42	74.00	-30.58	55.57	-12.15	PK
2	7206	42.45	74.00	-31.55	55.59	-13.14	PK
* 3	9608	56.05	74.00	-17.95	69.47	-13.42	PK

Note:

1. All Readings below 1GHz are Quasi-Peak, above 1GHz are performed with peak and/or average measurements as necessary.
2. Measurement Level = Reading Level + Correct Factor.
3. Correct Factor = Antenna factor + Cable loss – Amplifier gain.
4. The average measurement was not performed when the peak measured data under the limit of average detection.
5. The emission levels of other frequencies are very lower than the limit and not show in test report.

Product : WiFi SOM Module
 Test Item : Harmonic Radiated Emission
 Test Site : No.3 OATS
 Test date : 2020/01/02
 Test Mode : Mode 1: Bluetooth LE 1Mbps(2402MHz)

Horizontal

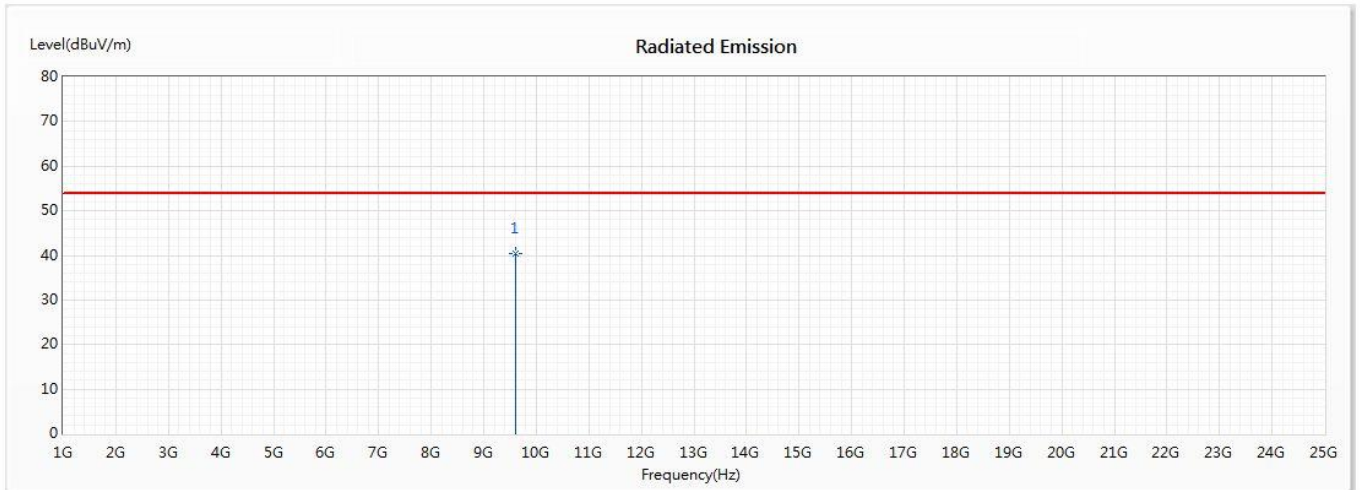

No	Frequency (MHz)	Emission Level (dBuV/m)	Limit (dBuV/m)	Margin (dB)	Reading Level (dBuV)	Correct Factor (dB/m)	Detector Type
* 1	9608	40.35	54.00	-13.65	53.77	-13.42	AV

Note:

1. All Readings below 1GHz are Quasi-Peak, above 1GHz are performed with peak and/or average measurements as necessary.
2. Measurement Level = Reading Level + Correct Factor.
3. Correct Factor = Antenna factor + Cable loss – Amplifier gain.
4. The average measurement was not performed when the peak measured data under the limit of average detection.
5. The emission levels of other frequencies are very lower than the limit and not show in test report.

Product : WiFi SOM Module
 Test Item : Harmonic Radiated Emission
 Test Site : No.3 OATS
 Test date : 2020/01/02
 Test Mode : Mode 1: Bluetooth LE 1Mbps(2402MHz)

Vertical

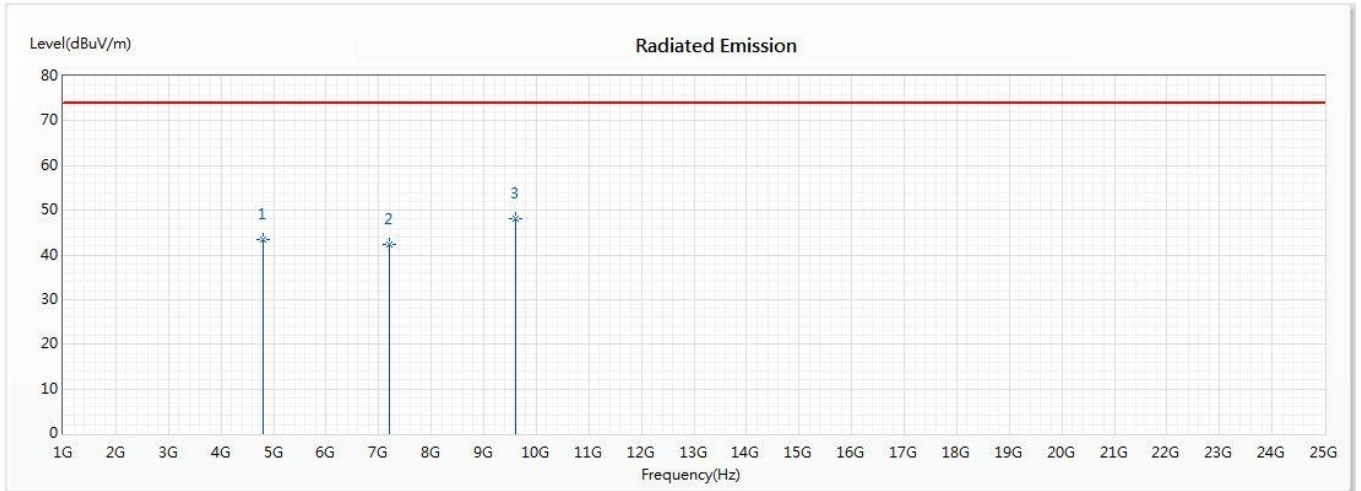

No	Frequency (MHz)	Emission Level (dBuV/m)	Limit (dBuV/m)	Margin (dB)	Reading Level (dBuV)	Correct Factor (dB/m)	Detector Type
1	4804	43.34	74.00	-30.66	55.49	-12.15	PK
2	7206	42.39	74.00	-31.61	55.53	-13.14	PK
* 3	9608	48.07	74.00	-25.93	61.49	-13.42	PK

Note:

1. All Readings below 1GHz are Quasi-Peak, above 1GHz are performed with peak and/or average measurements as necessary.
2. Measurement Level = Reading Level + Correct Factor.
3. Correct Factor = Antenna factor + Cable loss – Amplifier gain.
4. The average measurement was not performed when the peak measured data under the limit of average detection.
5. The emission levels of other frequencies are very lower than the limit and not show in test report.

Product : WiFi SOM Module
 Test Item : Harmonic Radiated Emission
 Test Site : No.3 OATS
 Test date : 2020/01/02
 Test Mode : Mode 1: Bluetooth LE 1Mbps (2440MHz)

Horizontal

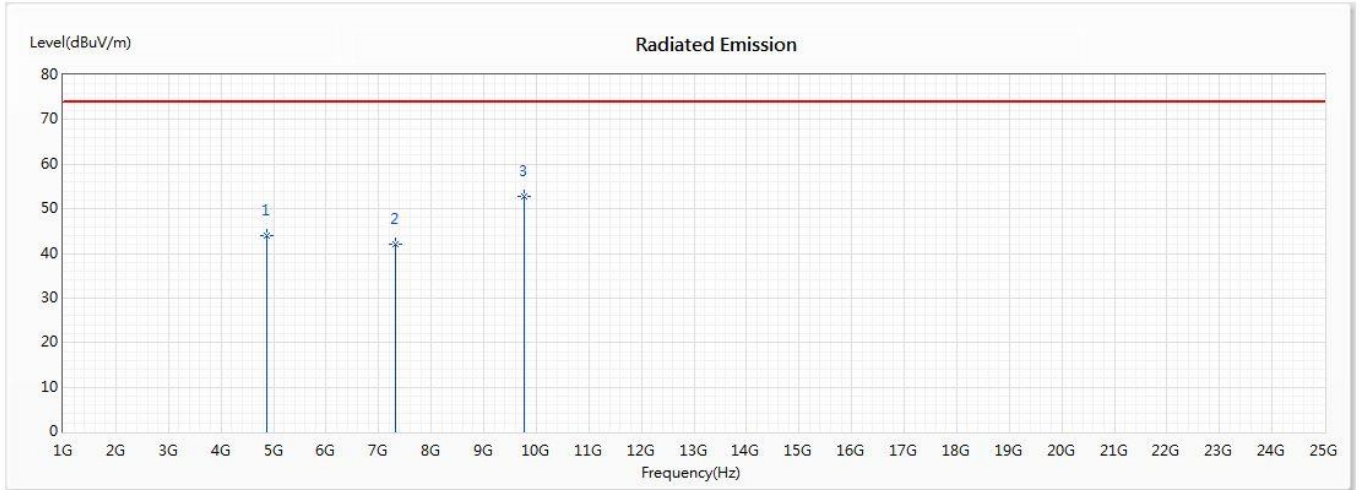

No	Frequency (MHz)	Emission Level (dBuV/m)	Limit (dBuV/m)	Margin (dB)	Reading Level (dBuV)	Correct Factor (dB/m)	Detector Type
1	4880	44.09	74.00	-29.91	55.69	-11.60	PK
2	7320	42.14	74.00	-31.86	55.69	-13.55	PK
* 3	9760	52.65	74.00	-21.35	65.13	-12.48	PK

Note:

1. All Readings below 1GHz are Quasi-Peak, above 1GHz are performed with peak and/or average measurements as necessary.
2. Measurement Level = Reading Level + Correct Factor.
3. Correct Factor = Antenna factor + Cable loss – Amplifier gain.
4. The average measurement was not performed when the peak measured data under the limit of average detection.
5. The emission levels of other frequencies are very lower than the limit and not show in test report.

Product : WiFi SOM Module
 Test Item : Harmonic Radiated Emission
 Test Site : No.3 OATS
 Test date : 2020/01/02
 Test Mode : Mode 1: Bluetooth LE 1Mbps (2440MHz)

Vertical

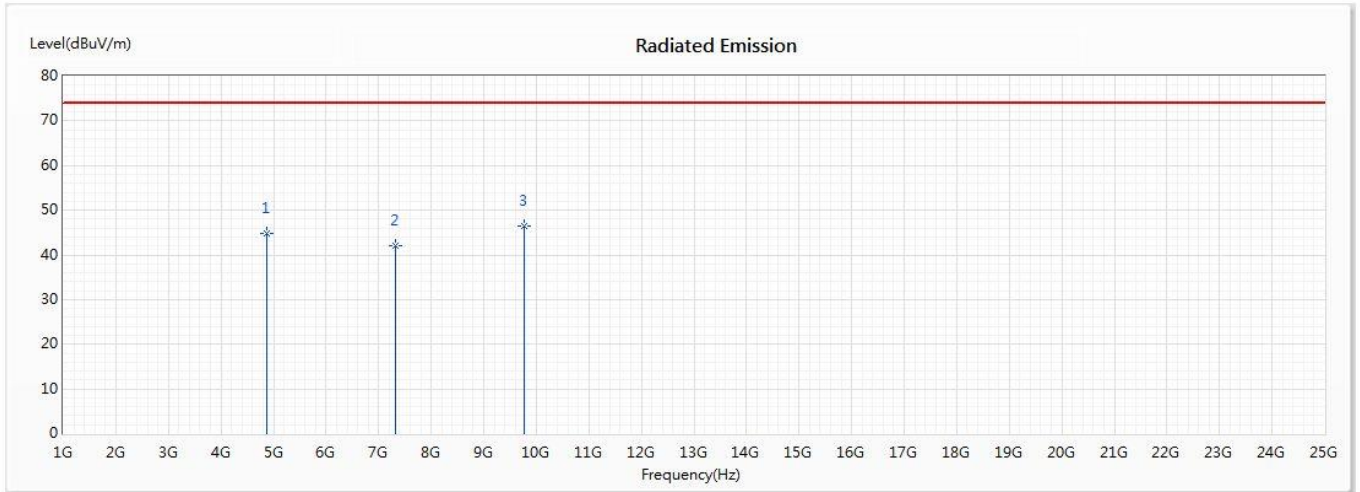

No	Frequency (MHz)	Emission Level (dBuV/m)	Limit (dBuV/m)	Margin (dB)	Reading Level (dBuV)	Correct Factor (dB/m)	Detector Type
1	4880	44.77	74.00	-29.23	56.37	-11.60	PK
2	7320	42.03	74.00	-31.97	55.58	-13.55	PK
* 3	9760	46.47	74.00	-27.53	58.95	-12.48	PK

Note:

1. All Readings below 1GHz are Quasi-Peak, above 1GHz are performed with peak and/or average measurements as necessary.
2. Measurement Level = Reading Level + Correct Factor.
3. Correct Factor = Antenna factor + Cable loss – Amplifier gain.
4. The average measurement was not performed when the peak measured data under the limit of average detection.
5. The emission levels of other frequencies are very lower than the limit and not show in test report.

Product : WiFi SOM Module
 Test Item : Harmonic Radiated Emission
 Test Site : No.3 OATS
 Test date : 2020/01/02
 Test Mode : Mode 1: Bluetooth LE 1Mbps (2480MHz)

Horizontal

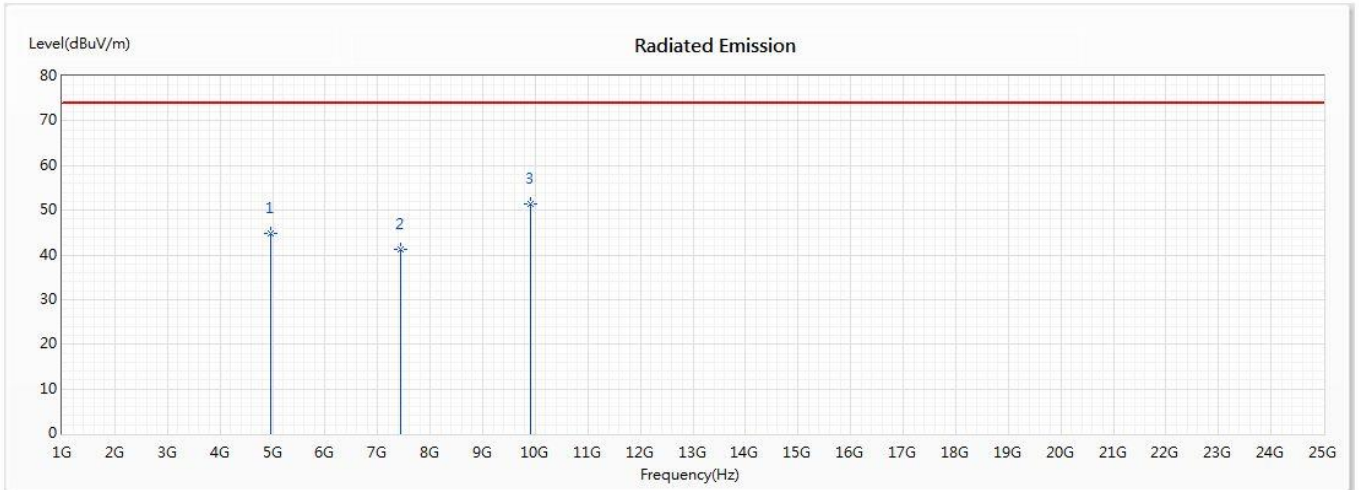

No	Frequency (MHz)	Emission Level (dBuV/m)	Limit (dBuV/m)	Margin (dB)	Reading Level (dBuV)	Correct Factor (dB/m)	Detector Type
1	4960	44.94	74.00	-29.06	55.83	-10.89	PK
2	7440	41.17	74.00	-32.83	55.79	-14.62	PK
* 3	9920	51.53	74.00	-22.47	65.76	-14.23	PK

Note:

1. All Readings below 1GHz are Quasi-Peak, above 1GHz are performed with peak and/or average measurements as necessary.
2. Measurement Level = Reading Level + Correct Factor.
3. Correct Factor = Antenna factor + Cable loss – Amplifier gain.
4. The average measurement was not performed when the peak measured data under the limit of average detection.
5. The emission levels of other frequencies are very lower than the limit and not show in test report.

Product : WiFi SOM Module
 Test Item : Harmonic Radiated Emission
 Test Site : No.3 OATS
 Test date : 2020/01/02
 Test Mode : Mode 1: Bluetooth LE 1Mbps (2480MHz)

Vertical

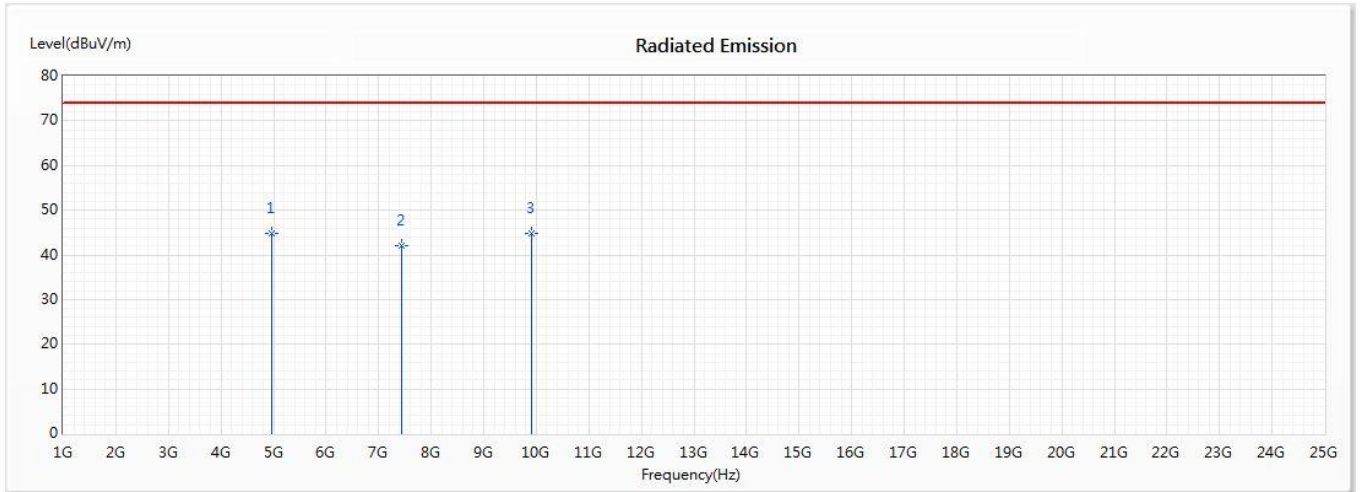

No	Frequency (MHz)	Emission Level (dBuV/m)	Limit (dBuV/m)	Margin (dB)	Reading Level (dBuV)	Correct Factor (dB/m)	Detector Type
* 1	4960	44.89	74.00	-29.11	55.78	-10.89	PK
2	7440	42.07	74.00	-31.93	56.69	-14.62	PK
3	9920	44.81	74.00	-29.19	59.04	-14.23	PK

Note:

1. All Readings below 1GHz are Quasi-Peak, above 1GHz are performed with peak and/or average measurements as necessary.
2. Measurement Level = Reading Level + Correct Factor.
3. Correct Factor = Antenna factor + Cable loss – Amplifier gain.
4. The average measurement was not performed when the peak measured data under the limit of average detection.
5. The emission levels of other frequencies are very lower than the limit and not show in test report.

Product : WiFi SOM Module
 Test Item : Harmonic Radiated Emission
 Test Site : No.3 OATS
 Test date : 2020/01/02
 Test Mode : Mode 2: Bluetooth LE 2Mbps (2402MHz)

Horizontal

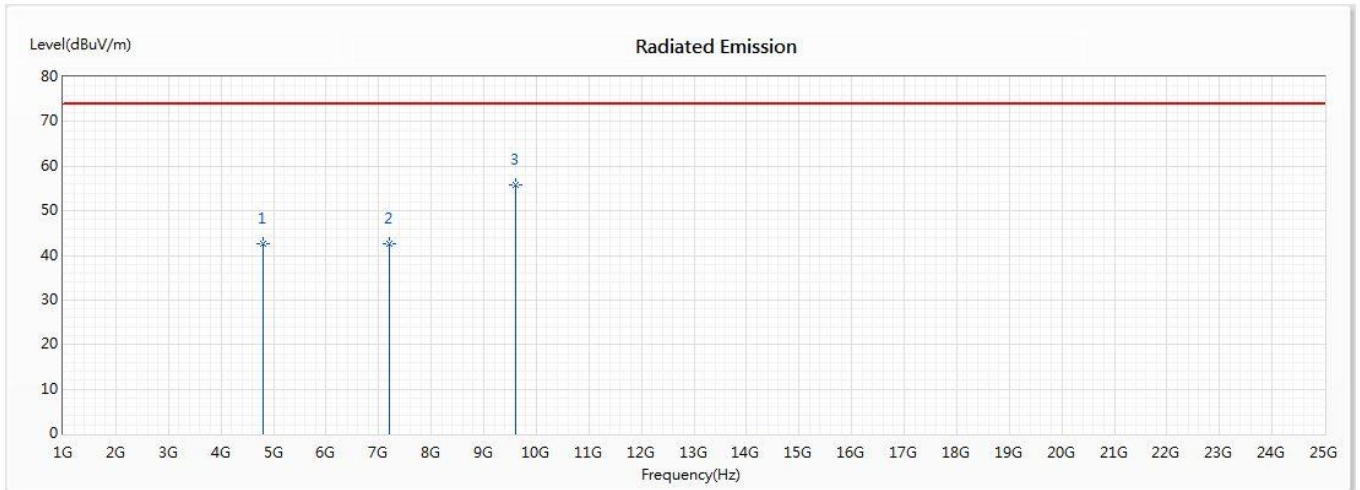

No	Frequency (MHz)	Emission Level (dBuV/m)	Limit (dBuV/m)	Margin (dB)	Reading Level (dBuV)	Correct Factor (dB/m)	Detector Type
1	4804	42.65	74.00	-31.35	54.80	-12.15	PK
2	7206	42.72	74.00	-31.28	55.86	-13.14	PK
* 3	9608	55.86	74.00	-18.14	69.28	-13.42	PK

Note:

1. All Readings below 1GHz are Quasi-Peak, above 1GHz are performed with peak and/or average measurements as necessary.
2. Measurement Level = Reading Level + Correct Factor.
3. Correct Factor = Antenna factor + Cable loss – Amplifier gain.
4. The average measurement was not performed when the peak measured data under the limit of average detection.
5. The emission levels of other frequencies are very lower than the limit and not show in test report.

Product : WiFi SOM Module
 Test Item : Harmonic Radiated Emission
 Test Site : No.3 OATS
 Test date : 2020/01/02
 Test Mode : Mode 2: Bluetooth LE 2Mbps (2402MHz)

Horizontal

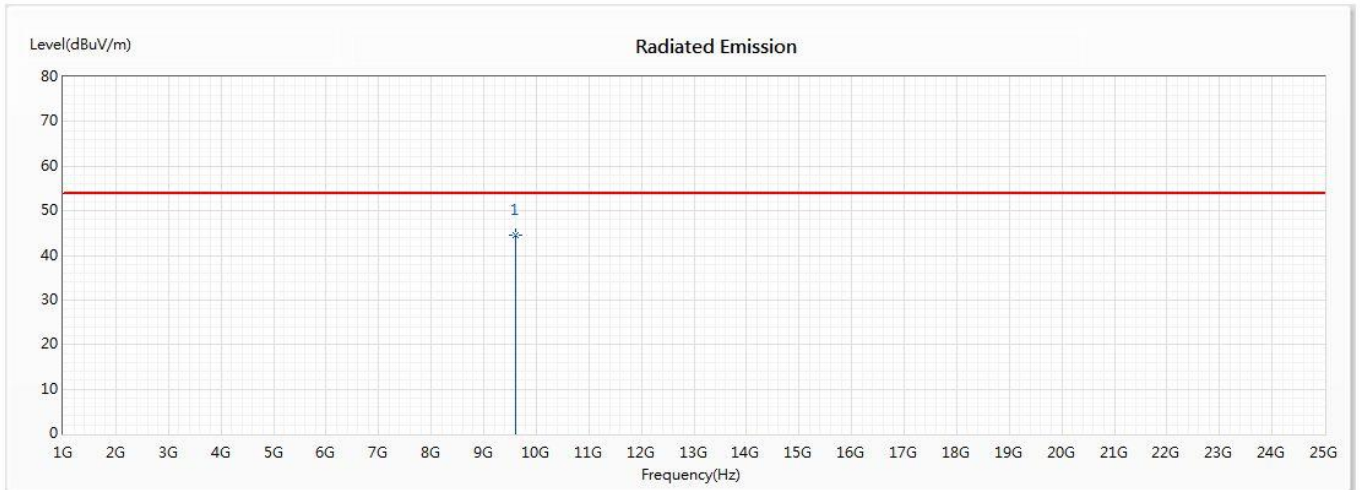

No	Frequency (MHz)	Emission Level (dBuV/m)	Limit (dBuV/m)	Margin (dB)	Reading Level (dBuV)	Correct Factor (dB/m)	Detector Type
* 1	9608	44.47	54.00	-9.53	57.89	-13.42	AV

Note:

1. All Readings below 1GHz are Quasi-Peak, above 1GHz are performed with peak and/or average measurements as necessary.
2. Measurement Level = Reading Level + Correct Factor.
3. Correct Factor = Antenna factor + Cable loss – Amplifier gain.
4. The average measurement was not performed when the peak measured data under the limit of average detection.
5. The emission levels of other frequencies are very lower than the limit and not show in test report.

Product : WiFi SOM Module
 Test Item : Harmonic Radiated Emission
 Test Site : No.3 OATS
 Test date : 2020/01/02
 Test Mode : Mode 2: Bluetooth LE 2Mbps (2402MHz)

Vertical

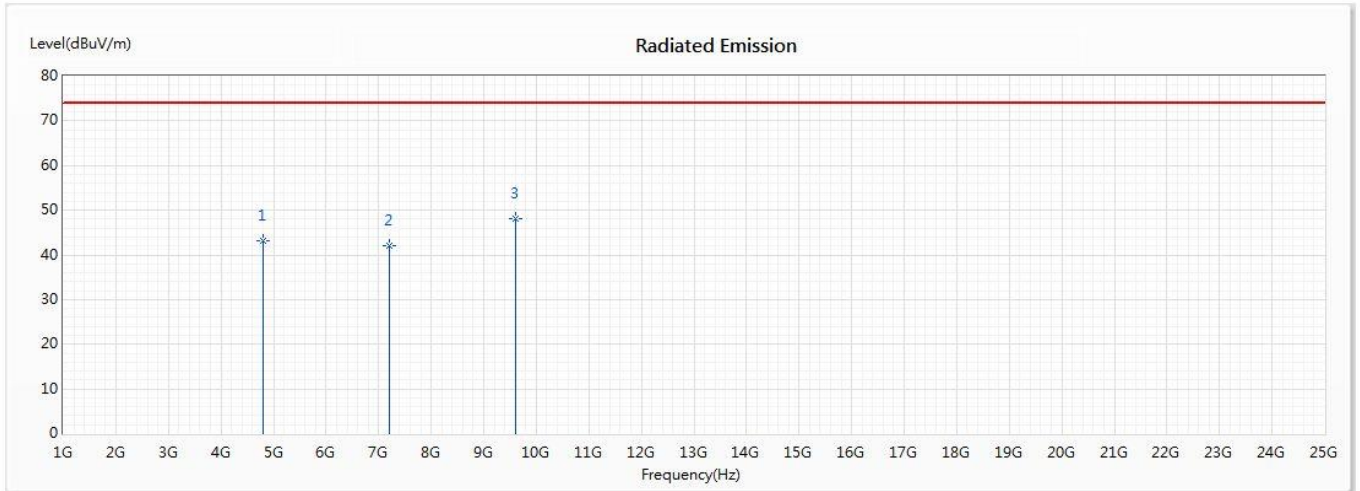

No	Frequency (MHz)	Emission Level (dBuV/m)	Limit (dBuV/m)	Margin (dB)	Reading Level (dBuV)	Correct Factor (dB/m)	Detector Type
1	4804	43.03	74.00	-30.97	55.18	-12.15	PK
2	7206	42.06	74.00	-31.94	55.20	-13.14	PK
* 3	9608	48.03	74.00	-25.97	61.45	-13.42	PK

Note:

1. All Readings below 1GHz are Quasi-Peak, above 1GHz are performed with peak and/or average measurements as necessary.
2. Measurement Level = Reading Level + Correct Factor.
3. Correct Factor = Antenna factor + Cable loss – Amplifier gain.
4. The average measurement was not performed when the peak measured data under the limit of average detection.
5. The emission levels of other frequencies are very lower than the limit and not show in test report.

Product : WiFi SOM Module
 Test Item : Harmonic Radiated Emission
 Test Site : No.3 OATS
 Test date : 2020/01/02
 Test Mode : Mode 2: Bluetooth LE 2Mbps (2440MHz)

Horizontal

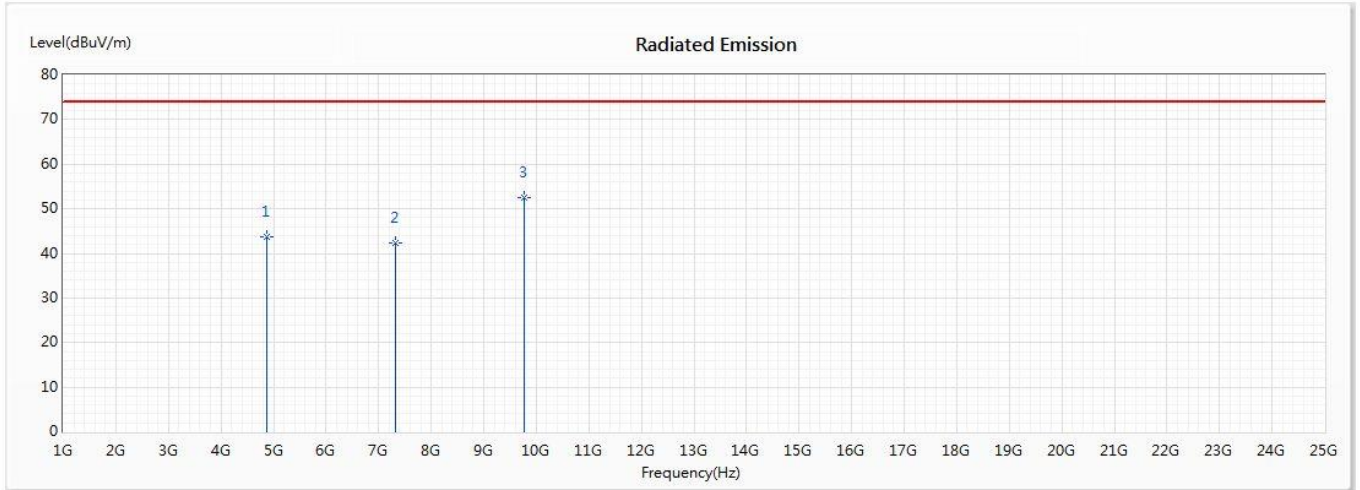

No	Frequency (MHz)	Emission Level (dBuV/m)	Limit (dBuV/m)	Margin (dB)	Reading Level (dBuV)	Correct Factor (dB/m)	Detector Type
1	4880	43.80	74.00	-30.20	55.40	-11.60	PK
2	7320	42.20	74.00	-31.80	55.75	-13.55	PK
* 3	9760	52.62	74.00	-21.38	65.10	-12.48	PK

Note:

1. All Readings below 1GHz are Quasi-Peak, above 1GHz are performed with peak and/or average measurements as necessary.
2. Measurement Level = Reading Level + Correct Factor.
3. Correct Factor = Antenna factor + Cable loss – Amplifier gain.
4. The average measurement was not performed when the peak measured data under the limit of average detection.
5. The emission levels of other frequencies are very lower than the limit and not show in test report.

Product : WiFi SOM Module
 Test Item : Harmonic Radiated Emission
 Test Site : No.3 OATS
 Test date : 2020/01/02
 Test Mode : Mode 2: Bluetooth LE 2Mbps (2440MHz)

Vertical

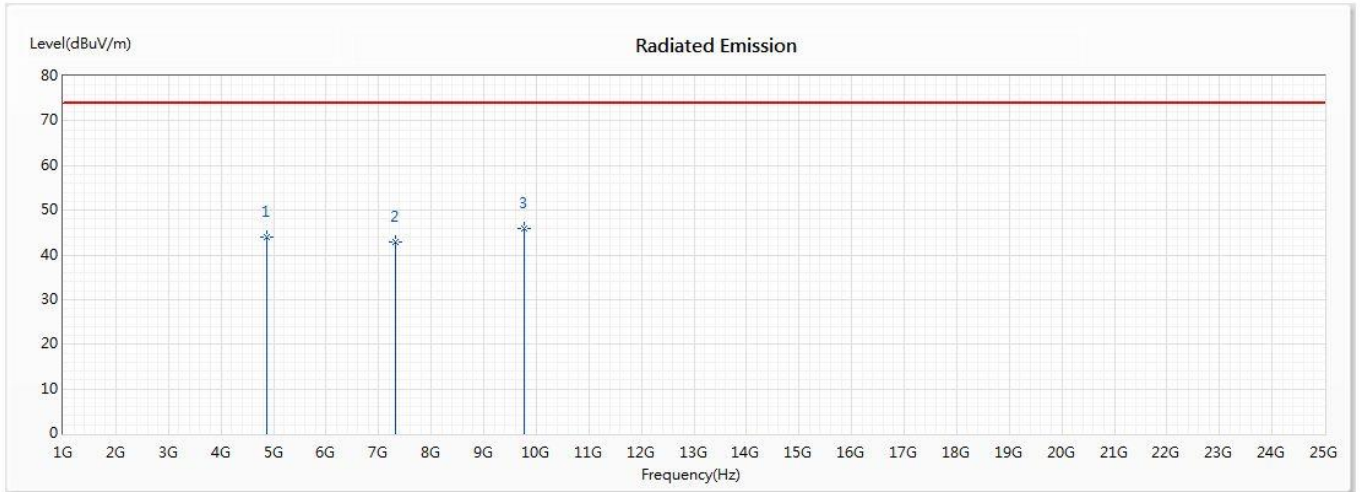

No	Frequency (MHz)	Emission Level (dBuV/m)	Limit (dBuV/m)	Margin (dB)	Reading Level (dBuV)	Correct Factor (dB/m)	Detector Type
1	4880	44.06	74.00	-29.94	55.66	-11.60	PK
2	7320	42.94	74.00	-31.06	56.49	-13.55	PK
* 3	9760	45.95	74.00	-28.05	58.43	-12.48	PK

Note:

1. All Readings below 1GHz are Quasi-Peak, above 1GHz are performed with peak and/or average measurements as necessary.
2. Measurement Level = Reading Level + Correct Factor.
3. Correct Factor = Antenna factor + Cable loss – Amplifier gain.
4. The average measurement was not performed when the peak measured data under the limit of average detection.
5. The emission levels of other frequencies are very lower than the limit and not show in test report.

Product : WiFi SOM Module
 Test Item : Harmonic Radiated Emission
 Test Site : No.3 OATS
 Test date : 2020/01/02
 Test Mode : Mode 2: Bluetooth LE 2Mbps (2480MHz)

Horizontal

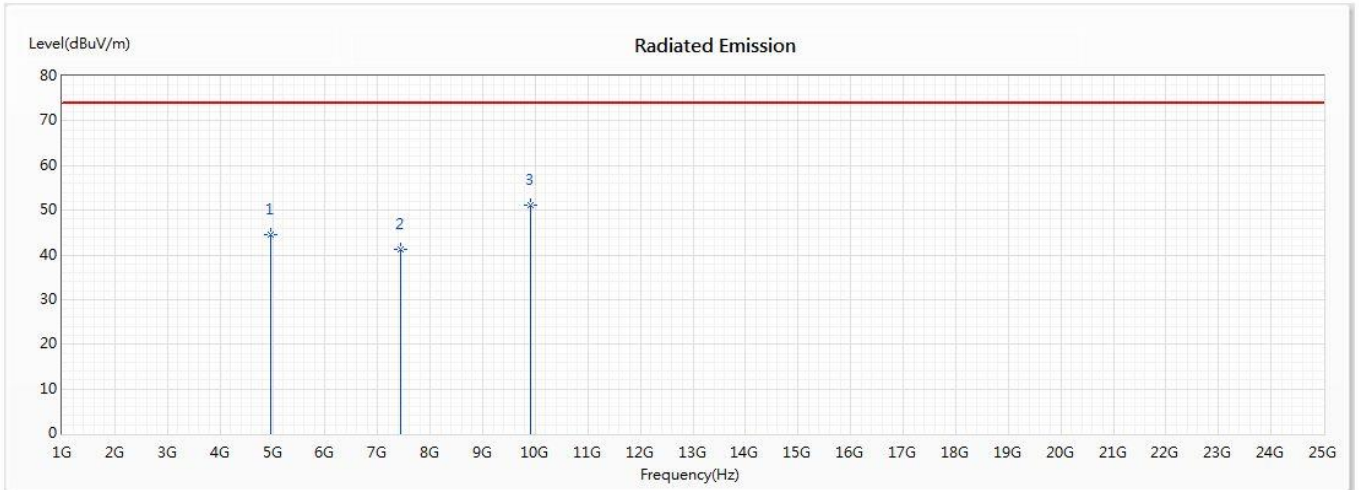

No	Frequency (MHz)	Emission Level (dBuV/m)	Limit (dBuV/m)	Margin (dB)	Reading Level (dBuV)	Correct Factor (dB/m)	Detector Type
1	4960	44.64	74.00	-29.36	55.53	-10.89	PK
2	7440	41.36	74.00	-32.64	55.98	-14.62	PK
* 3	9920	51.01	74.00	-22.99	65.24	-14.23	PK

Note:

1. All Readings below 1GHz are Quasi-Peak, above 1GHz are performed with peak and/or average measurements as necessary.
2. Measurement Level = Reading Level + Correct Factor.
3. Correct Factor = Antenna factor + Cable loss – Amplifier gain.
4. The average measurement was not performed when the peak measured data under the limit of average detection.
5. The emission levels of other frequencies are very lower than the limit and not show in test report.

Product : WiFi SOM Module
 Test Item : Harmonic Radiated Emission
 Test Site : No.3 OATS
 Test date : 2020/01/02
 Test Mode : Mode 2: Bluetooth LE 2Mbps (2480MHz)

Vertical

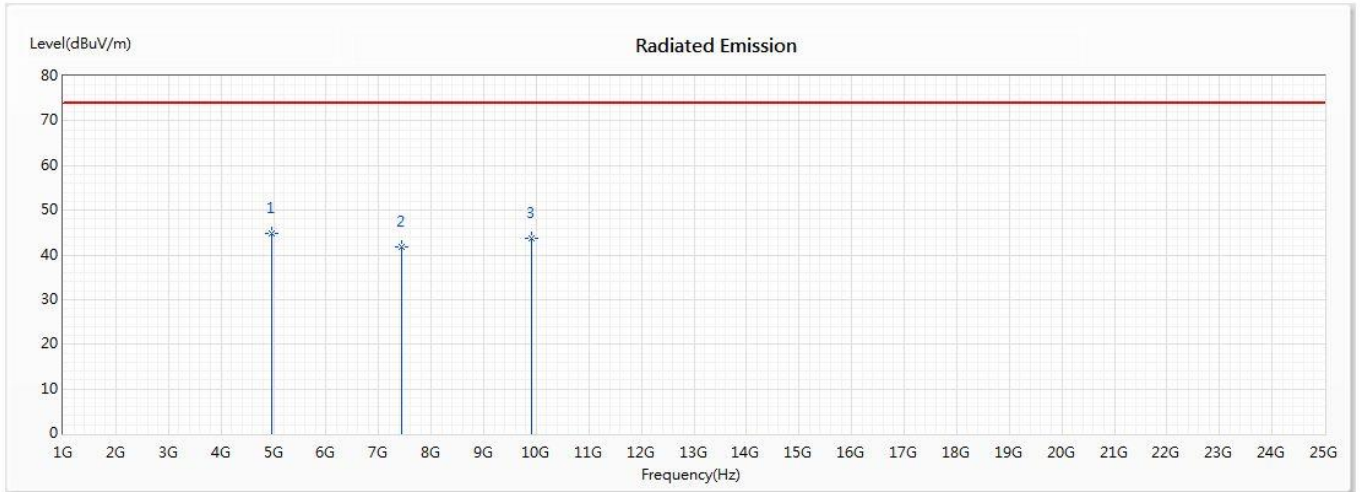

No	Frequency (MHz)	Emission Level (dBuV/m)	Limit (dBuV/m)	Margin (dB)	Reading Level (dBuV)	Correct Factor (dB/m)	Detector Type
* 1	4960	44.89	74.00	-29.11	55.78	-10.89	PK
2	7440	41.92	74.00	-32.08	56.54	-14.62	PK
3	9920	43.78	74.00	-30.22	58.01	-14.23	PK

Note:

1. All Readings below 1GHz are Quasi-Peak, above 1GHz are performed with peak and/or average measurements as necessary.
2. Measurement Level = Reading Level + Correct Factor.
3. Correct Factor = Antenna factor + Cable loss – Amplifier gain.
4. The average measurement was not performed when the peak measured data under the limit of average detection.
5. The emission levels of other frequencies are very lower than the limit and not show in test report.

Product : WiFi SOM Module
 Test Item : General Radiated Emission
 Test Site : No.3 OATS
 Test date : 2020/01/02
 Test Mode : Mode 1: Bluetooth LE 1Mbps (2440MHz)

Horizontal

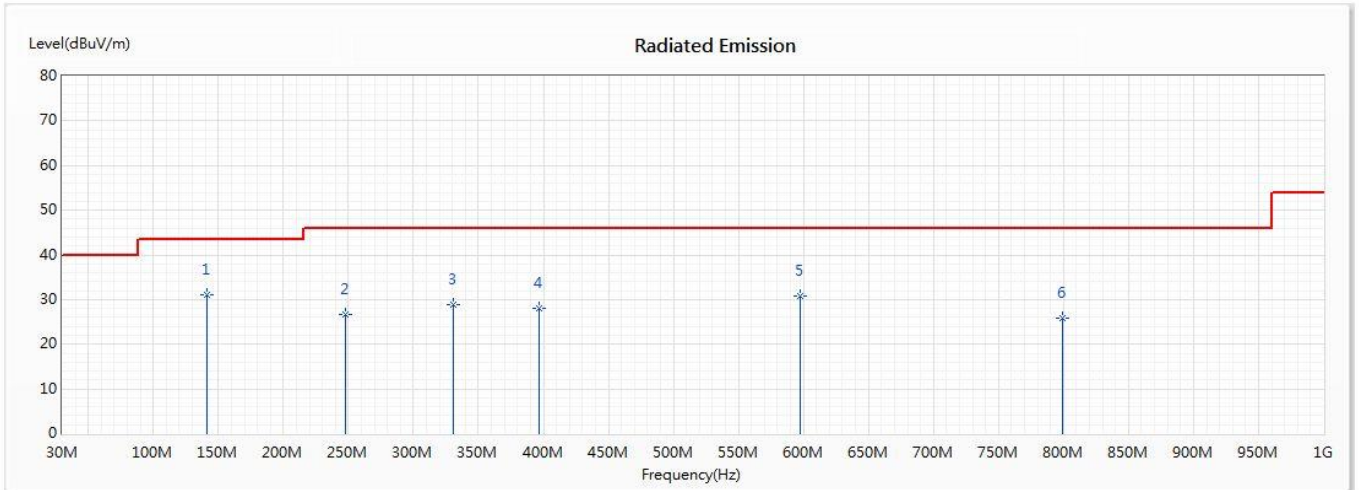

No	Frequency (MHz)	Emission Level (dBuV/m)	Limit (dBuV/m)	Margin (dB)	Reading Level (dBuV)	Correct Factor (dB/m)	Detector Type
* 1	141.058	31.17	43.50	-12.33	49.02	-17.85	QP
2	247.899	26.77	46.00	-19.23	44.83	-18.06	QP
3	330.841	28.87	46.00	-17.13	42.88	-14.01	QP
4	396.913	28.14	46.00	-17.86	41.58	-13.44	QP
5	597.942	30.91	46.00	-15.09	37.61	-6.70	QP
6	798.971	25.96	46.00	-20.04	34.87	-8.91	QP

Note:

1. All Readings below 1GHz are Quasi-Peak, above 1GHz are performed with peak and/or average measurements as necessary.
2. Measurement Level = Reading Level + Correct Factor.
3. Correct Factor = Antenna factor + Cable loss – Amplifier gain.
4. The emission levels of other frequencies are very lower than the limit and not show in test report.
5. No emission found between lowest internal used/generated frequency to 30MHz.

Product : WiFi SOM Module
 Test Item : General Radiated Emission
 Test Site : No.3 OATS
 Test date : 2020/01/02
 Test Mode : Mode 1: Bluetooth LE 1Mbps (2440MHz)

Vertical

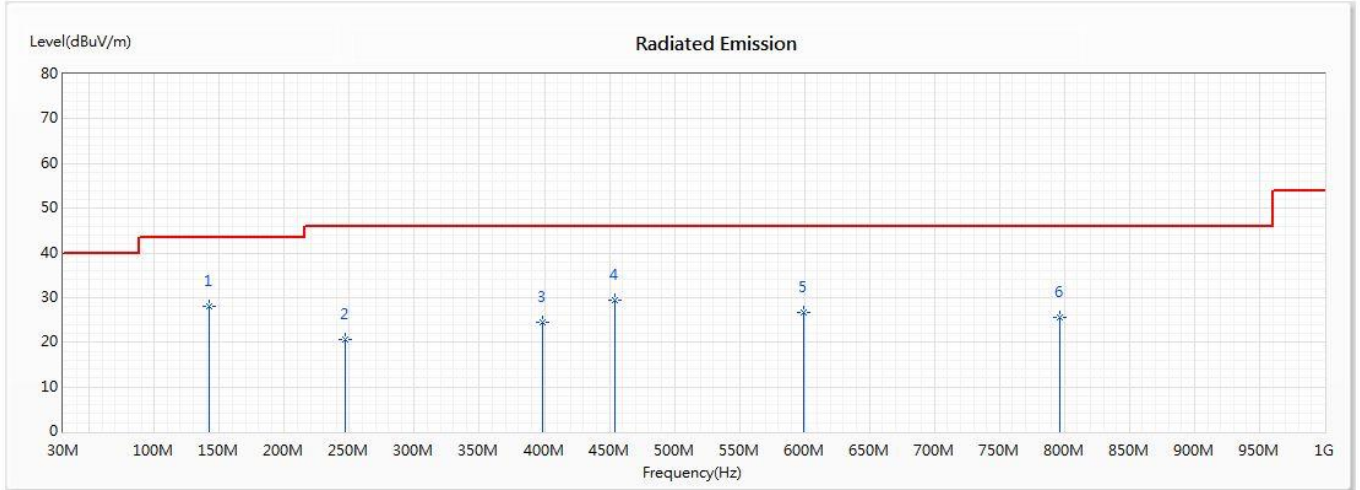

No	Frequency (MHz)	Emission Level (dBuV/m)	Limit (dBuV/m)	Margin (dB)	Reading Level (dBuV)	Correct Factor (dB/m)	Detector Type
* 1	142.464	27.91	43.50	-15.59	46.08	-18.17	QP
2	246.493	20.67	46.00	-25.33	38.82	-18.15	QP
3	398.319	24.44	46.00	-21.56	37.99	-13.55	QP
4	454.551	29.28	46.00	-16.72	39.57	-10.29	QP
5	599.348	26.68	46.00	-19.32	33.31	-6.63	QP
6	796.159	25.48	46.00	-20.52	34.34	-8.86	QP

Note:

1. All Readings below 1GHz are Quasi-Peak, above 1GHz are performed with peak and/or average measurements as necessary.
2. Measurement Level = Reading Level + Correct Factor.
3. Correct Factor = Antenna factor + Cable loss – Amplifier gain.
4. The emission levels of other frequencies are very lower than the limit and not show in test report.
5. No emission found between lowest internal used/generated frequency to 30MHz.

Product : WiFi SOM Module
 Test Item : General Radiated Emission
 Test Site : No.3 OATS
 Test date : 2020/01/02
 Test Mode : Mode 2: Bluetooth LE 2Mbps (2440MHz)

Horizontal

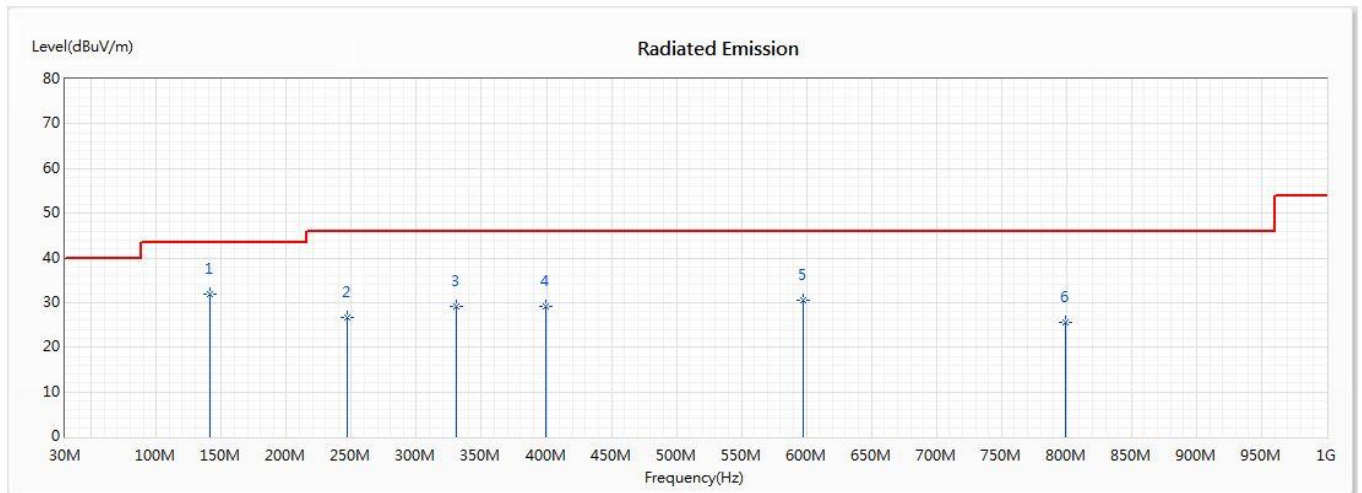

No	Frequency (MHz)	Emission Level (dBuV/m)	Limit (dBuV/m)	Margin (dB)	Reading Level (dBuV)	Correct Factor (dB/m)	Detector Type
* 1	141.058	31.82	43.50	-11.68	49.67	-17.85	QP
2	246.493	26.60	46.00	-19.40	44.75	-18.15	QP
3	330.841	29.21	46.00	-16.79	43.22	-14.01	QP
4	399.725	29.08	46.00	-16.92	42.75	-13.67	QP
5	597.942	30.40	46.00	-15.60	37.10	-6.70	QP
6	798.971	25.64	46.00	-20.36	34.55	-8.91	QP

Note:

1. All Readings below 1GHz are Quasi-Peak, above 1GHz are performed with peak and/or average measurements as necessary.
2. Measurement Level = Reading Level + Correct Factor.
3. Correct Factor = Antenna factor + Cable loss – Amplifier gain.
4. The emission levels of other frequencies are very lower than the limit and not show in test report.
5. No emission found between lowest internal used/generated frequency to 30MHz.

Product : WiFi SOM Module
 Test Item : General Radiated Emission
 Test Site : No.3 OATS
 Test date : 2020/01/02
 Test Mode : Mode 2: Bluetooth LE 2Mbps (2440MHz)

Vertical

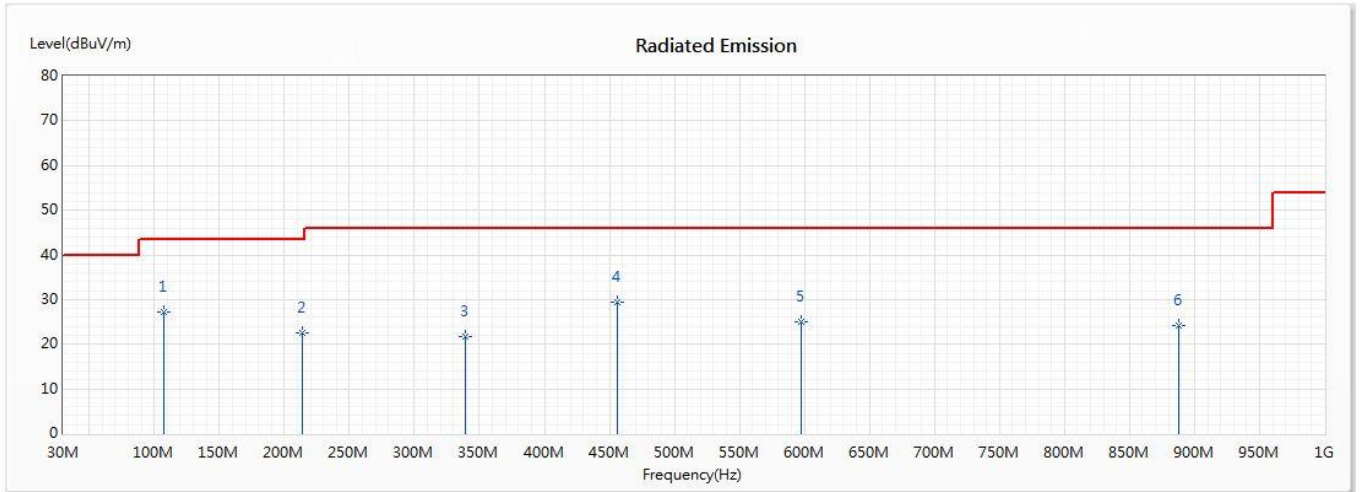

No	Frequency (MHz)	Emission Level (dBuV/m)	Limit (dBuV/m)	Margin (dB)	Reading Level (dBuV)	Correct Factor (dB/m)	Detector Type
* 1	107.319	27.16	43.50	-16.34	43.76	-16.60	QP
2	214.159	22.67	43.50	-20.83	40.83	-18.16	QP
3	339.275	21.71	46.00	-24.29	35.68	-13.97	QP
4	455.957	29.31	46.00	-16.69	39.66	-10.35	QP
5	597.942	25.15	46.00	-20.85	31.85	-6.70	QP
6	887.536	24.25	46.00	-21.75	33.18	-8.93	QP

Note:

1. All Readings below 1GHz are Quasi-Peak, above 1GHz are performed with peak and/or average measurements as necessary.
2. Measurement Level = Reading Level + Correct Factor.
3. Correct Factor = Antenna factor + Cable loss – Amplifier gain.
4. The emission levels of other frequencies are very lower than the limit and not show in test report.
5. No emission found between lowest internal used/generated frequency to 30MHz.

4. Band Edge

4.1. Test Setup

RF Conducted Measurement

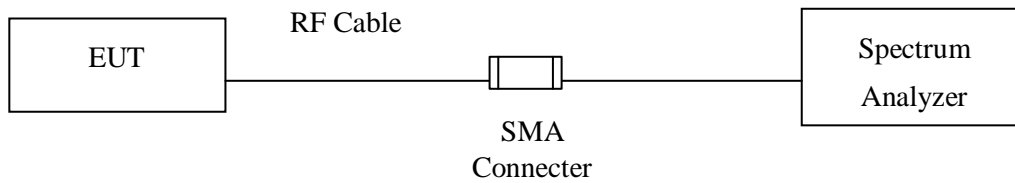

RF Radiated Measurement:

Above 1GHz

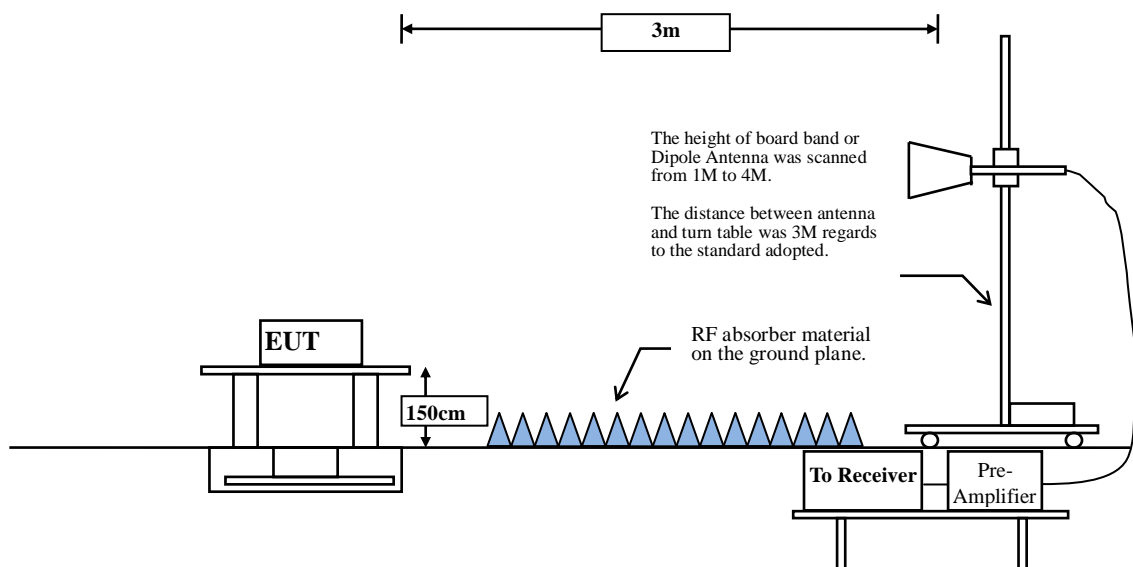

4.2. Limit

In any 100 kHz bandwidth outside the frequency band in which the spread spectrum intentional radiator is operating, the radio frequency power that is produced by the intentional radiator shall be at least 20 dB below that in the 100 kHz bandwidth within the band that contains the highest level of the desired power, based on either an RF conducted or a radiated measurement. Attenuation below the general limits specified in Section 15.209(a) is not required. In addition, radiated emissions which fall in the restricted bands, as defined in Section 15.205(a), must also comply with the radiated emission limits specified in Section 15.209(a) (see Section 15.205(c)).

4.3. Test Procedure

The EUT was setup according to ANSI C63.10, 2013 and tested according to DTS test procedure of KDB558074 for compliance to FCC 47CFR 15.247 requirements.

The EUT is placed on a turn table which is 1.5 meter above ground. The turn table is rotated 360 degrees to determine the position of the maximum emission level. The EUT was positioned such that the distance from antenna to the EUT was 3 meters.

The antenna is scanned from 1 meter to 4 meters to find out the maximum emission level. This is repeated for both horizontal and vertical polarization of the antenna. In order to find the maximum emission, all of the interface cables were manipulated according to ANSI C63.10:2013 on radiated measurement.

RBW and VBW Parameter setting:

According to KDB 558074 Peak power measurement procedure

RBW = as specified in Table 1.

VBW \geq 3 x RBW.

Table 1 —RBW as a function of frequency

Frequency	RBW
9-150 kHz	200-300 Hz
0.15-30 MHz	9-10 kHz
30-1000 MHz	100-120 kHz
> 1000 MHz	1 MHz

According to KDB 558074 Average power measurement procedure

RBW = 1MHz.

VBW = 10Hz, when duty cycle \geq 98 %

VBW \geq 1/T, when duty cycle < 98 %

(T refers to the minimum transmission duration over which the transmitter is on and is transmitting at its maximum power control level for the tested mode of operation.)

2.4GHz band	Duty Cycle (%)	T (ms)	1/T (Hz)	VBW (Hz)
BLE 1M	62.50	0.3913	2556	3000
BLE 2M	32.71	0.2044	4894	5000

Note: Duty Cycle Refer to Section 5.

4.4. Uncertainty

\pm 4.08 dB above 1GHz

\pm 4.22 dB below 1GHz

4.5. Test Result of Band Edge

Product : WiFi SOM Module
 Test Item : Band Edge
 Test Site : No.3 OATS
 Test date : 2019/12/27
 Test Mode : Mode 1: Bluetooth LE 1Mbps (2402MHz)

Horizontal

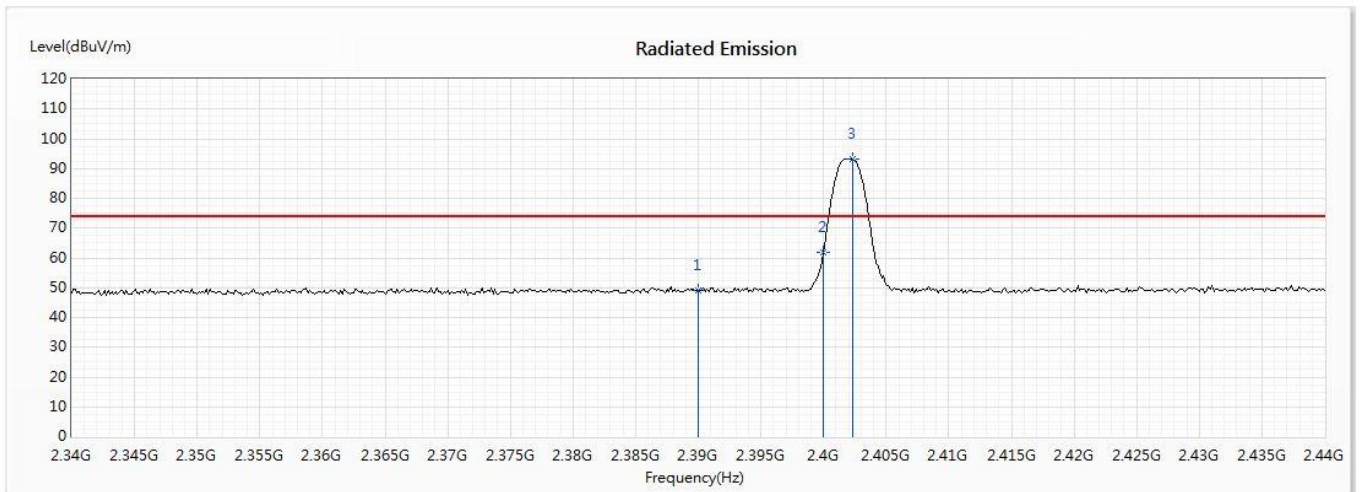

No	Frequency (MHz)	Emission Level (dBuV/m)	Limit (dBuV/m)	Margin (dB)	Reading Level (dBuV)	Correct Factor (dB/m)	Detector Type
1	2390	48.94	74.00	-25.06	36.05	12.89	PK
2	2400	62.00	--	--	49.04	12.96	PK
! 3	2402.319	93.16	--	--	80.19	12.97	PK

Note:

1. All readings above 1GHz are performed with peak and/or average measurements as necessary.
2. Measurement Level = Reading Level + Correct Factor.
3. The average measurement was not performed when the peak measured data under the limit of average detection.

Product : WiFi SOM Module
 Test Item : Band Edge
 Test Site : No.3 OATS
 Test date : 2019/12/27
 Test Mode : Mode 1: Bluetooth LE 1Mbps (2402MHz)

Horizontal

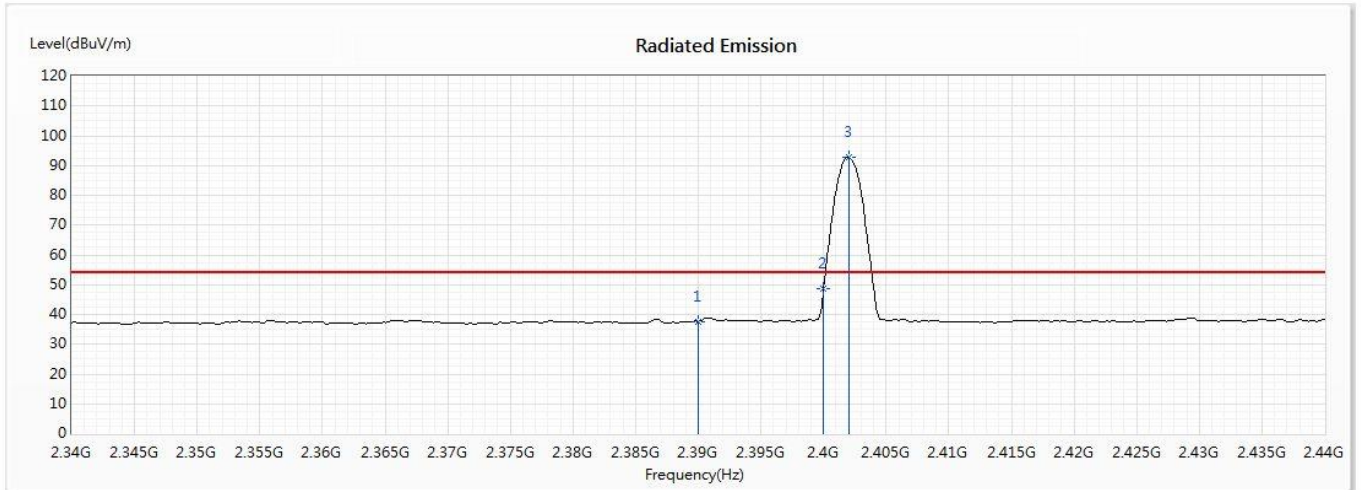

No	Frequency (MHz)	Emission Level (dBuV/m)	Limit (dBuV/m)	Margin (dB)	Reading Level (dBuV)	Correct Factor (dB/m)	Detector Type
1	2390	37.60	54.00	-16.40	24.71	12.89	AV
2	2400	48.52	--	--	35.56	12.96	AV
! 3	2402.029	92.58	--	--	79.61	12.97	AV

Note:

1. All readings above 1GHz are performed with peak and/or average measurements as necessary.
2. Measurement Level = Reading Level + Correct Factor.
3. The average measurement was not performed when the peak measured data under the limit of average detection.

Product : WiFi SOM Module
 Test Item : Band Edge
 Test Site : No.3 OATS
 Test date : 2019/12/27
 Test Mode : Mode 1: Bluetooth LE 1Mbps (2402MHz)

Vertical

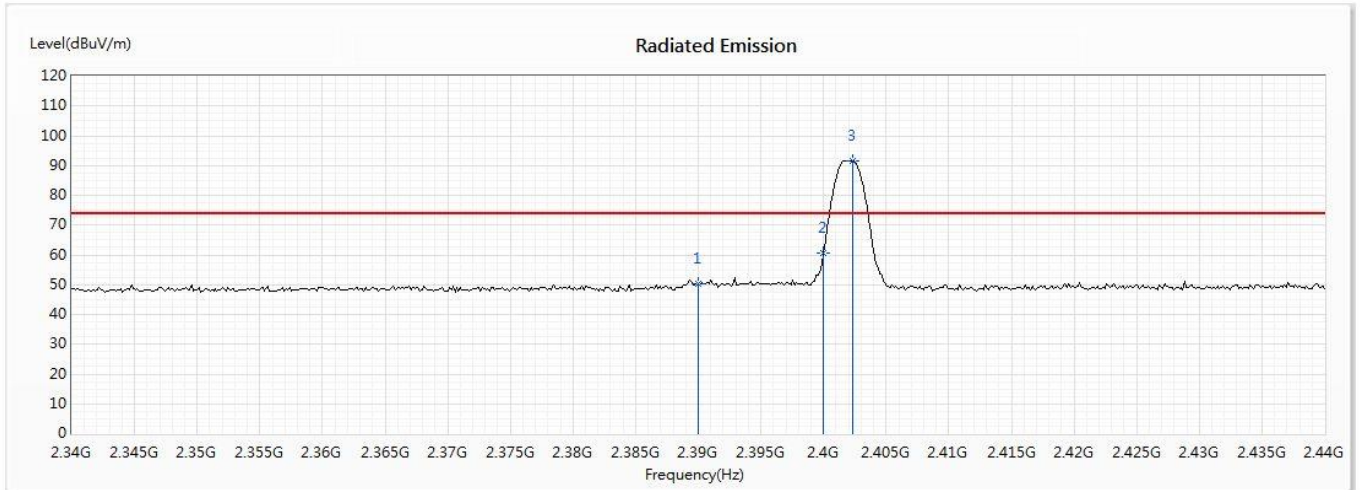

No	Frequency (MHz)	Emission Level (dBuV/m)	Limit (dBuV/m)	Margin (dB)	Reading Level (dBuV)	Correct Factor (dB/m)	Detector Type
1	2390	50.44	74.00	-23.56	37.55	12.89	PK
2	2400	60.58	--	--	47.62	12.96	PK
! 3	2402.319	91.64	--	--	78.67	12.97	PK

Note:

1. All readings above 1GHz are performed with peak and/or average measurements as necessary.
2. Measurement Level = Reading Level + Correct Factor.
3. The average measurement was not performed when the peak measured data under the limit of average detection.

Product : WiFi SOM Module
 Test Item : Band Edge
 Test Site : No.3 OATS
 Test date : 2019/12/27
 Test Mode : Mode 1: Bluetooth LE 1Mbps (2402MHz)

Vertical

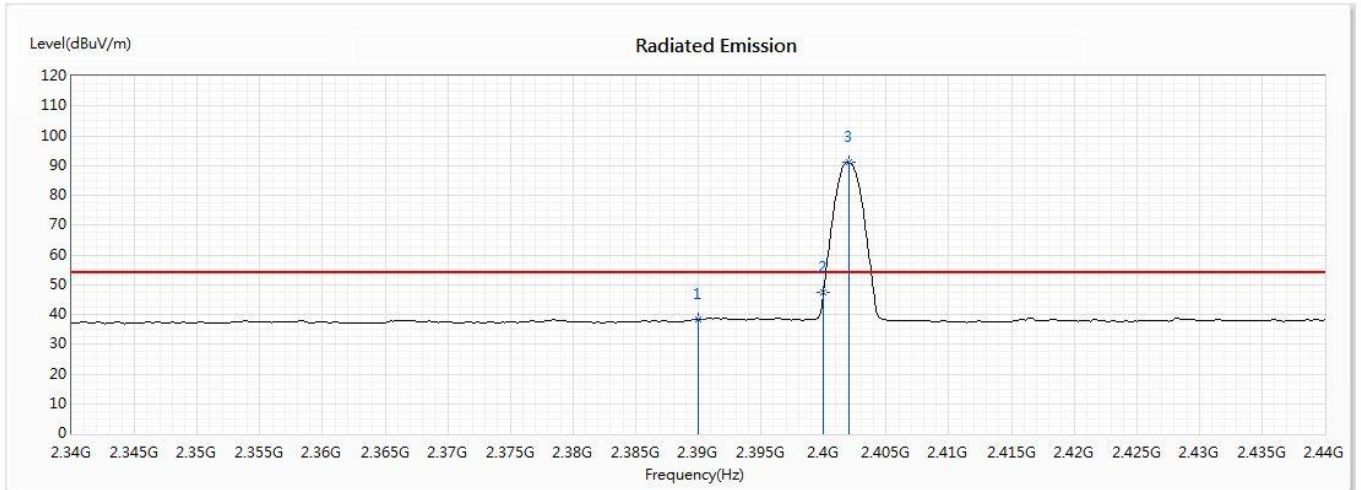

No	Frequency (MHz)	Emission Level (dBuV/m)	Limit (dBuV/m)	Margin (dB)	Reading Level (dBuV)	Correct Factor (dB/m)	Detector Type
1	2390	38.22	54.00	-15.78	25.33	12.89	AV
2	2400	47.48	--	--	34.52	12.96	AV
! 3	2402.029	90.99	--	--	78.02	12.97	AV

Note:

1. All readings above 1GHz are performed with peak and/or average measurements as necessary.
2. Measurement Level = Reading Level + Correct Factor.
3. The average measurement was not performed when the peak measured data under the limit of average detection.

Product : WiFi SOM Module
 Test Item : Band Edge
 Test Site : No.3 OATS
 Test date : 2019/12/27
 Test Mode : Mode 1: Bluetooth LE 1Mbps (2480MHz)

Horizontal

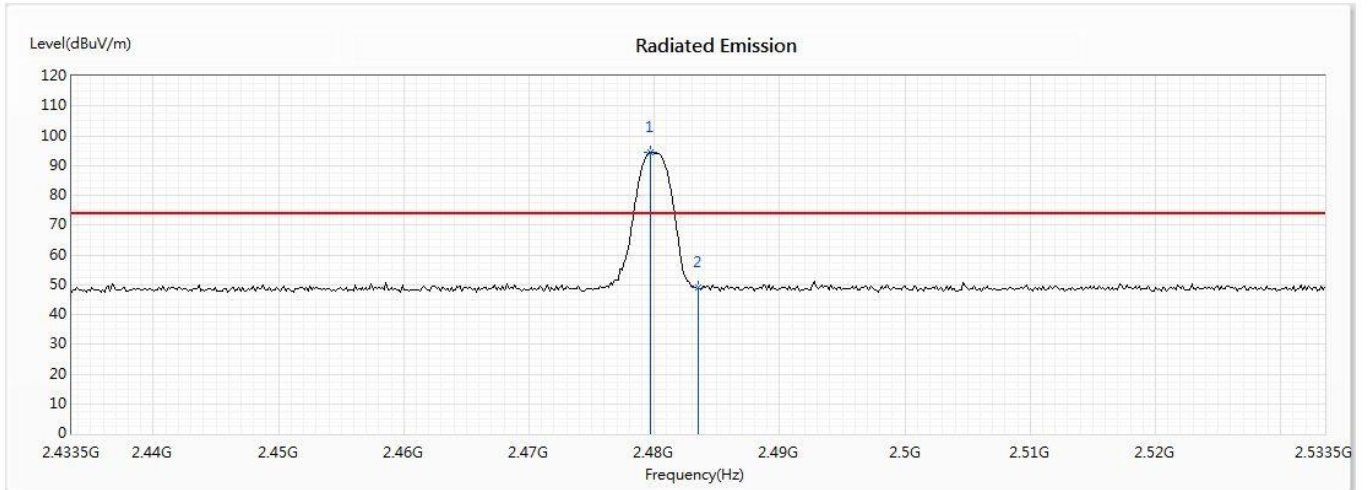

No	Frequency (MHz)	Emission Level (dBuV/m)	Limit (dBuV/m)	Margin (dB)	Reading Level (dBuV)	Correct Factor (dB/m)	Detector Type
! 1	2479.732	94.40	--	--	81.03	13.37	PK
2	2483.5	48.90	74.00	-25.10	35.52	13.38	PK

Note:

1. All readings above 1GHz are performed with peak and/or average measurements as necessary.
2. Measurement Level = Reading Level + Correct Factor.
3. The average measurement was not performed when the peak measured data under the limit of average detection.

Product : WiFi SOM Module
 Test Item : Band Edge
 Test Site : No.3 OATS
 Test date : 2019/12/27
 Test Mode : Mode 1: Bluetooth LE 1Mbps (2480MHz)

Horizontal

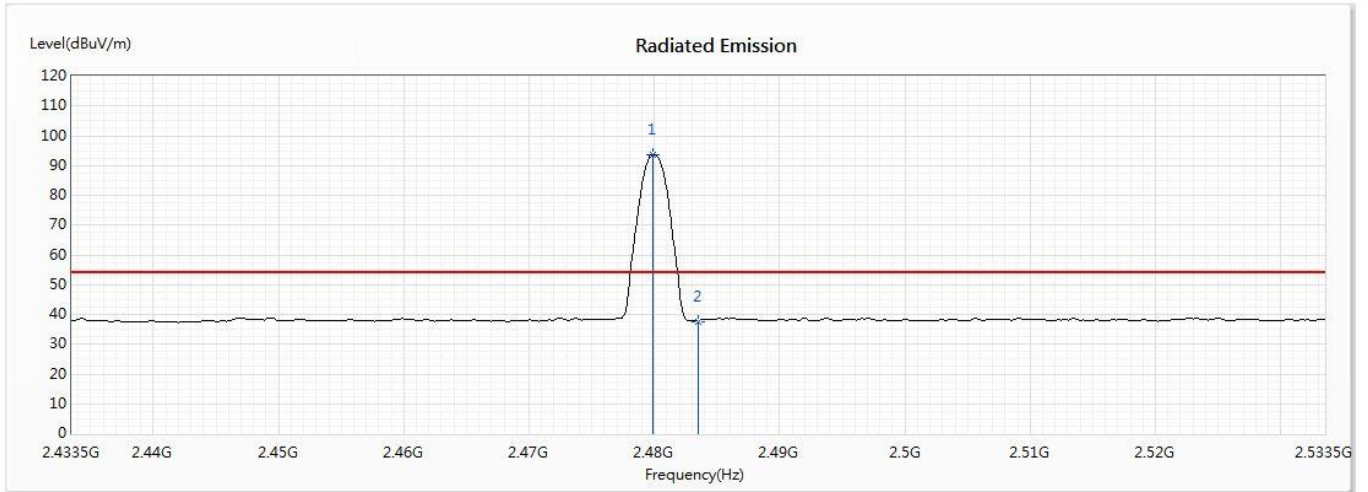

No	Frequency (MHz)	Emission Level (dBuV/m)	Limit (dBuV/m)	Margin (dB)	Reading Level (dBuV)	Correct Factor (dB/m)	Detector Type
! 1	2479.877	93.78	--	--	80.41	13.37	AV
2	2483.5	37.70	54.00	-16.30	24.32	13.38	AV

Note:

1. All readings above 1GHz are performed with peak and/or average measurements as necessary.
2. Measurement Level = Reading Level + Correct Factor.
3. The average measurement was not performed when the peak measured data under the limit of average detection.

Product : WiFi SOM Module
 Test Item : Band Edge
 Test Site : No.3 OATS
 Test date : 2019/12/27
 Test Mode : Mode 1: Bluetooth LE 1Mbps (2480MHz)

Vertical

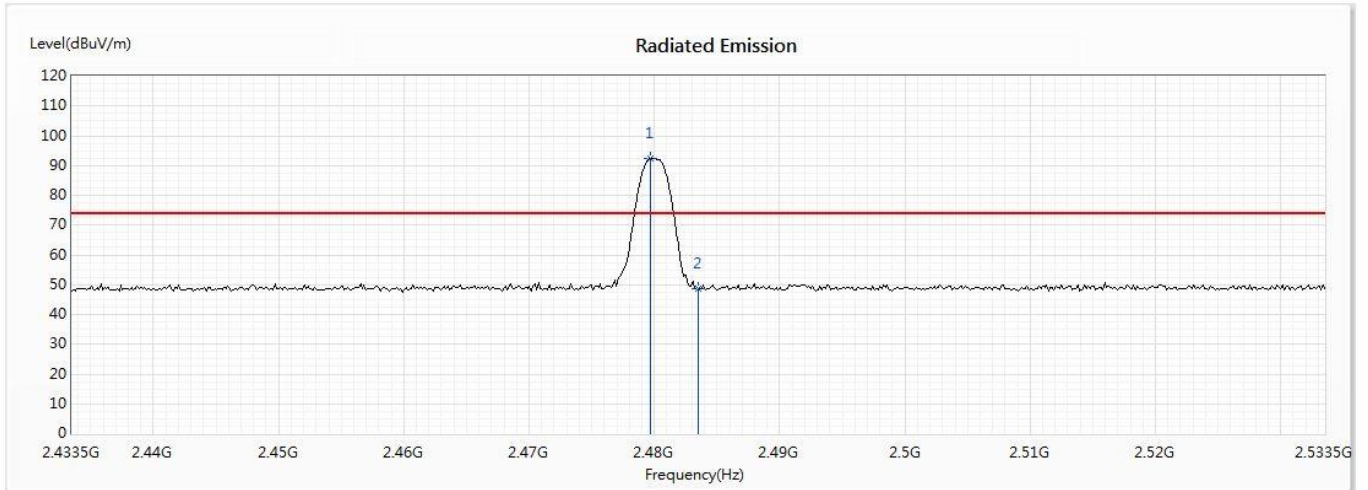

No	Frequency (MHz)	Emission Level (dBuV/m)	Limit (dBuV/m)	Margin (dB)	Reading Level (dBuV)	Correct Factor (dB/m)	Detector Type
! 1	2479.732	92.37	--	--	79.00	13.37	PK
2	2483.5	48.61	74.00	-25.39	35.23	13.38	PK

Note:

1. All readings above 1GHz are performed with peak and/or average measurements as necessary.
2. Measurement Level = Reading Level + Correct Factor.
3. The average measurement was not performed when the peak measured data under the limit of average detection.

Product : WiFi SOM Module
 Test Item : Band Edge
 Test Site : No.3 OATS
 Test date : 2019/12/27
 Test Mode : Mode 1: Bluetooth LE 1Mbps (2480MHz)

Vertical

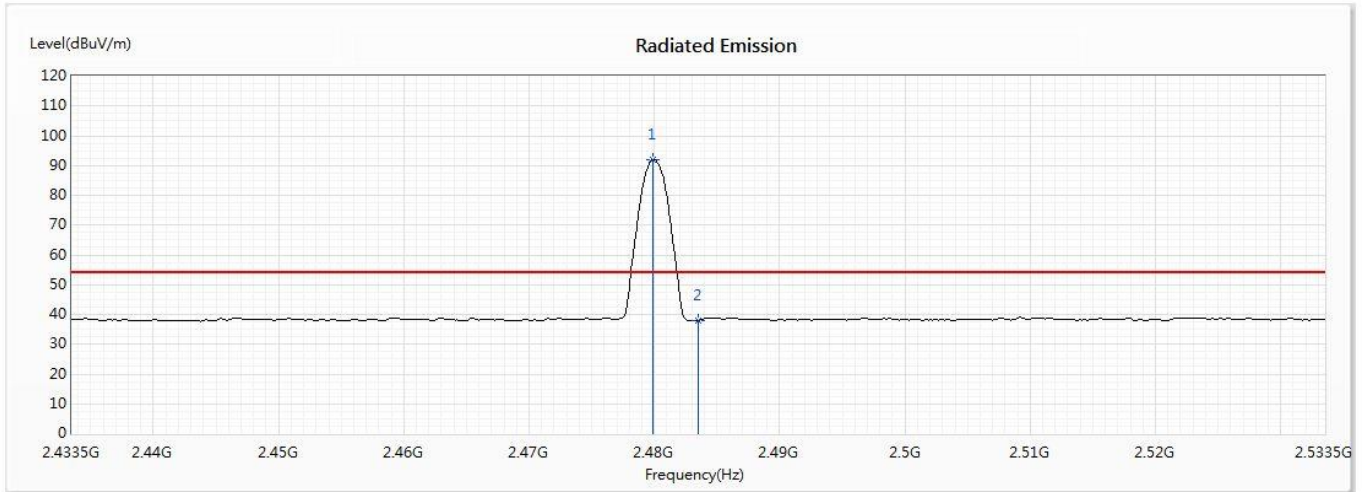

No	Frequency (MHz)	Emission Level (dBuV/m)	Limit (dBuV/m)	Margin (dB)	Reading Level (dBuV)	Correct Factor (dB/m)	Detector Type
! 1	2479.877	91.78	--	--	78.41	13.37	AV
2	2483.5	38.01	54.00	-15.99	24.63	13.38	AV

Note:

1. All readings above 1GHz are performed with peak and/or average measurements as necessary.
2. Measurement Level = Reading Level + Correct Factor.
3. The average measurement was not performed when the peak measured data under the limit of average detection.

Product : WiFi SOM Module
 Test Item : Band Edge
 Test Site : No.3 OATS
 Test date : 2019/12/27
 Test Mode : Mode 2: Bluetooth LE 2Mbps (2402MHz)

Horizontal

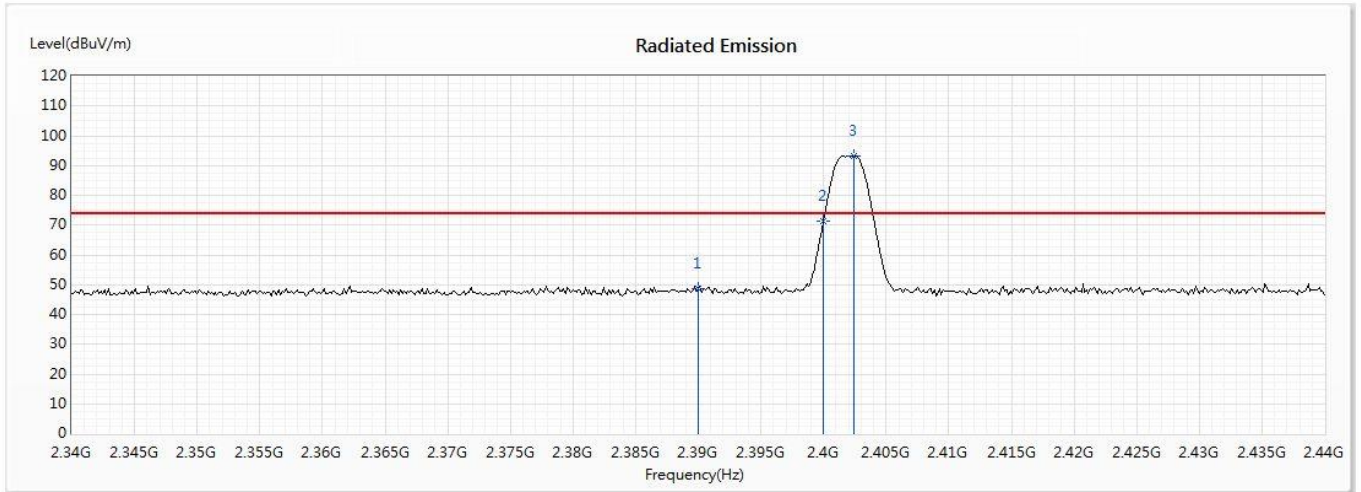

No	Frequency (MHz)	Emission Level (dBuV/m)	Limit (dBuV/m)	Margin (dB)	Reading Level (dBuV)	Correct Factor (dB/m)	Detector Type
1	2390	48.52	74.00	-25.48	35.63	12.89	PK
2	2400	71.47	--	--	58.51	12.96	PK
! 3	2402.464	93.21	--	--	80.24	12.97	PK

Note:

1. All readings above 1GHz are performed with peak and/or average measurements as necessary.
2. Peak measurements: RBW = 1MHz, VBW = 3 MHz, Sweep: Auto.
3. Average measurements: RBW = 1MHz, VBW = 10 Hz, Sweep: Auto.
4. “ * ”, means this data is the worst emission level.
5. Measurement Level = Reading Level + Correct Factor.
6. The average measurement was not performed when the peak measured data under the limit of average detection.

Product : WiFi SOM Module
 Test Item : Band Edge
 Test Site : No.3 OATS
 Test date : 2019/12/27
 Test Mode : Mode 2: Bluetooth LE 2Mbps (2402MHz)

Horizontal

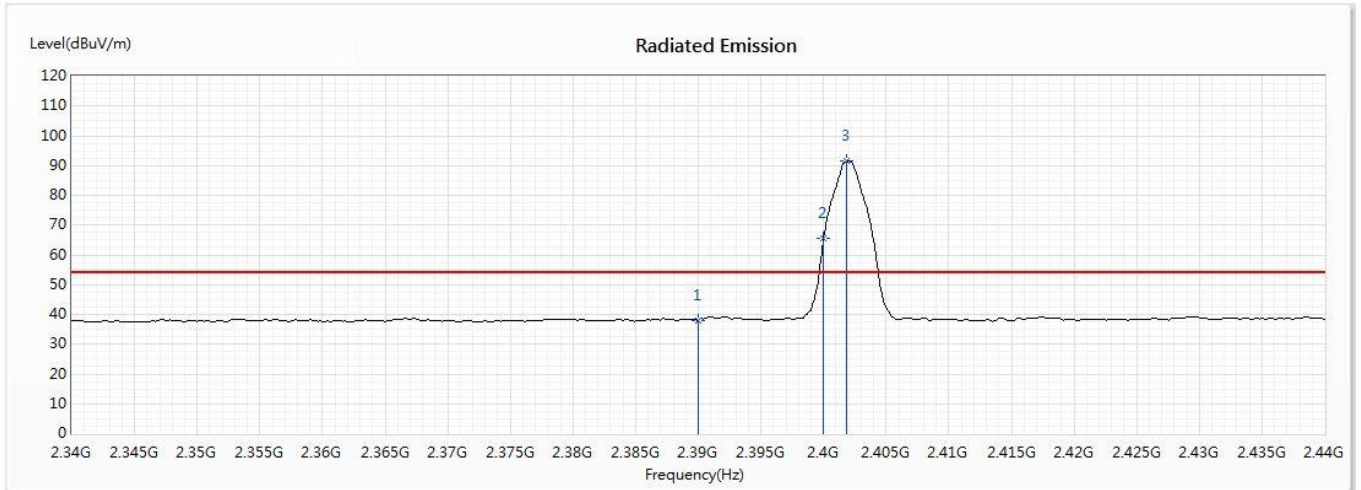

No	Frequency (MHz)	Emission Level (dBuV/m)	Limit (dBuV/m)	Margin (dB)	Reading Level (dBuV)	Correct Factor (dB/m)	Detector Type
1	2390	38.02	54.00	-15.98	25.13	12.89	AV
! 2	2400	65.52	--	--	52.56	12.96	AV
! 3	2401.884	91.57	--	--	78.60	12.97	AV

Note:

1. All readings above 1GHz are performed with peak and/or average measurements as necessary.
2. Measurement Level = Reading Level + Correct Factor.
3. The average measurement was not performed when the peak measured data under the limit of average detection.

Product : WiFi SOM Module
 Test Item : Band Edge
 Test Site : No.3 OATS
 Test date : 2019/12/27
 Test Mode : Mode 2: Bluetooth LE 2Mbps (2402MHz)

Vertical

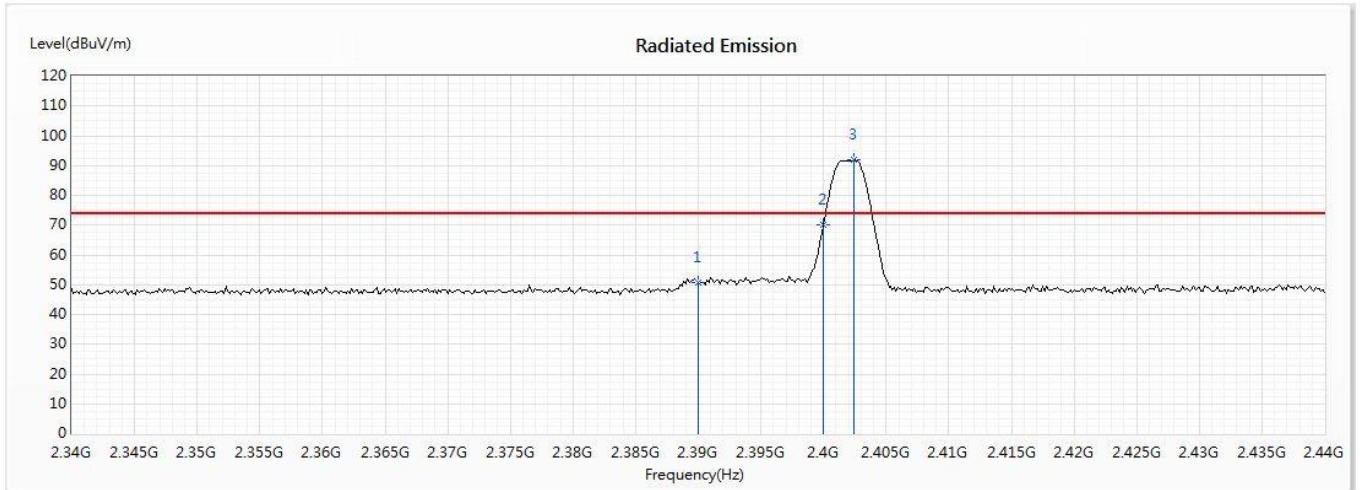

No	Frequency (MHz)	Emission Level (dBuV/m)	Limit (dBuV/m)	Margin (dB)	Reading Level (dBuV)	Correct Factor (dB/m)	Detector Type
1	2390	50.65	74.00	-23.35	37.76	12.89	PK
2	2400	70.18	--	--	57.22	12.96	PK
! 3	2402.464	91.77	--	--	78.80	12.97	PK

Note:

1. All readings above 1GHz are performed with peak and/or average measurements as necessary.
2. Measurement Level = Reading Level + Correct Factor.
3. The average measurement was not performed when the peak measured data under the limit of average detection.

Product : WiFi SOM Module
 Test Item : Band Edge
 Test Site : No.3 OATS
 Test date : 2019/12/27
 Test Mode : Mode 2: Bluetooth LE 2Mbps (2402MHz)

Vertical

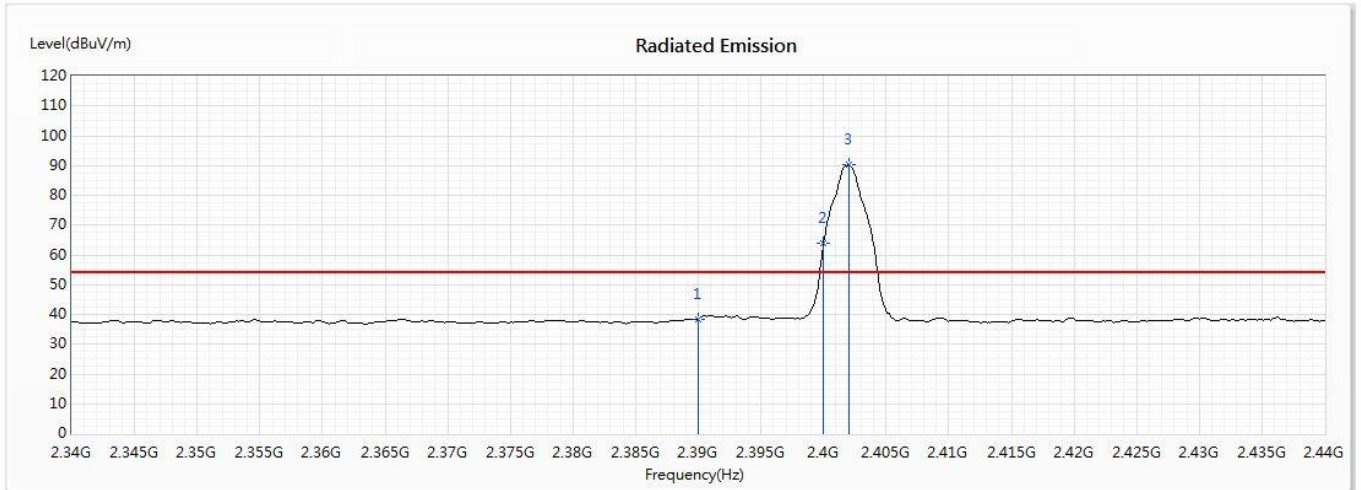

No	Frequency (MHz)	Emission Level (dBuV/m)	Limit (dBuV/m)	Margin (dB)	Reading Level (dBuV)	Correct Factor (dB/m)	Detector Type
1	2390	38.47	54.00	-15.53	25.58	12.89	AV
! 2	2400	63.77	--	--	50.81	12.96	AV
! 3	2402.029	90.14	--	--	77.17	12.97	AV

Note:

1. All readings above 1GHz are performed with peak and/or average measurements as necessary.
2. Measurement Level = Reading Level + Correct Factor.
3. The average measurement was not performed when the peak measured data under the limit of average detection.

Product : WiFi SOM Module
 Test Item : Band Edge
 Test Site : No.3 OATS
 Test date : 2019/12/27
 Test Mode : Mode 2: Bluetooth LE 2Mbps (2480MHz)

Horizontal

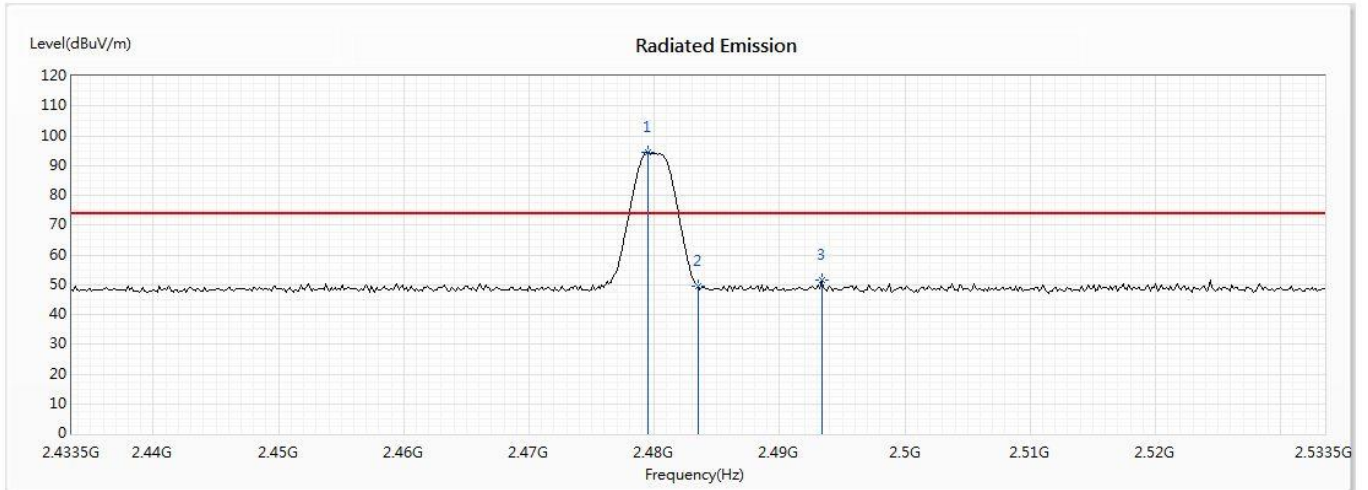

No	Frequency (MHz)	Emission Level (dBuV/m)	Limit (dBuV/m)	Margin (dB)	Reading Level (dBuV)	Correct Factor (dB/m)	Detector Type
! 1	2479.442	94.44	--	--	81.07	13.37	PK
2	2483.5	49.31	74.00	-24.69	35.93	13.38	PK
3	2493.355	51.52	74.00	-22.48	38.13	13.39	PK

Note:

1. All readings above 1GHz are performed with peak and/or average measurements as necessary.
2. Measurement Level = Reading Level + Correct Factor.
3. The average measurement was not performed when the peak measured data under the limit of average detection.

Product : WiFi SOM Module
 Test Item : Band Edge
 Test Site : No.3 OATS
 Test date : 2019/12/27
 Test Mode : Mode 2: Bluetooth LE 2Mbps (2480MHz)

Horizontal

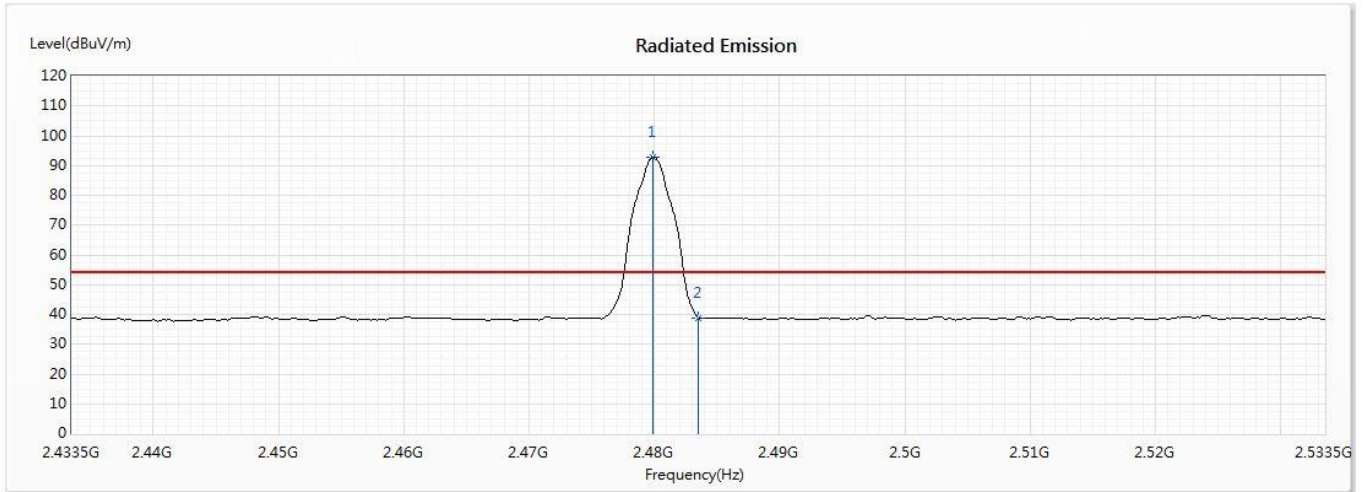

No	Frequency (MHz)	Emission Level (dBuV/m)	Limit (dBuV/m)	Margin (dB)	Reading Level (dBuV)	Correct Factor (dB/m)	Detector Type
! 1	2479.877	92.65	--	--	79.28	13.37	AV
2	2483.5	38.73	54.00	-15.27	25.35	13.38	AV

Note:

1. All readings above 1GHz are performed with peak and/or average measurements as necessary.
2. Measurement Level = Reading Level + Correct Factor.
3. The average measurement was not performed when the peak measured data under the limit of average detection.

Product : WiFi SOM Module
 Test Item : Band Edge
 Test Site : No.3 OATS
 Test date : 2019/12/27
 Test Mode : Mode 2: Bluetooth LE 2Mbps (2480MHz)

Vertical

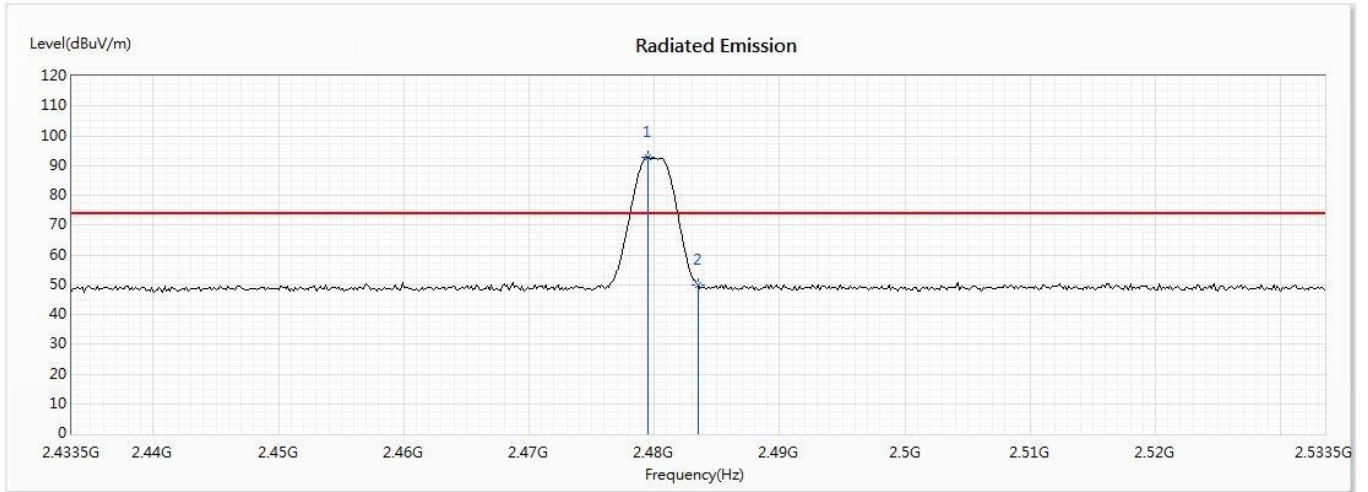

No	Frequency (MHz)	Emission Level (dBuV/m)	Limit (dBuV/m)	Margin (dB)	Reading Level (dBuV)	Correct Factor (dB/m)	Detector Type
! 1	2479.442	92.75	--	--	79.38	13.37	PK
2	2483.5	49.95	74.00	-24.05	36.57	13.38	PK

Note:

1. All readings above 1GHz are performed with peak and/or average measurements as necessary.
2. Measurement Level = Reading Level + Correct Factor.
3. The average measurement was not performed when the peak measured data under the limit of average detection.

Product : WiFi SOM Module
 Test Item : Band Edge
 Test Site : No.3 OATS
 Test date : 2019/12/27
 Test Mode : Mode 2: Bluetooth LE 2Mbps (2480MHz)

Vertical

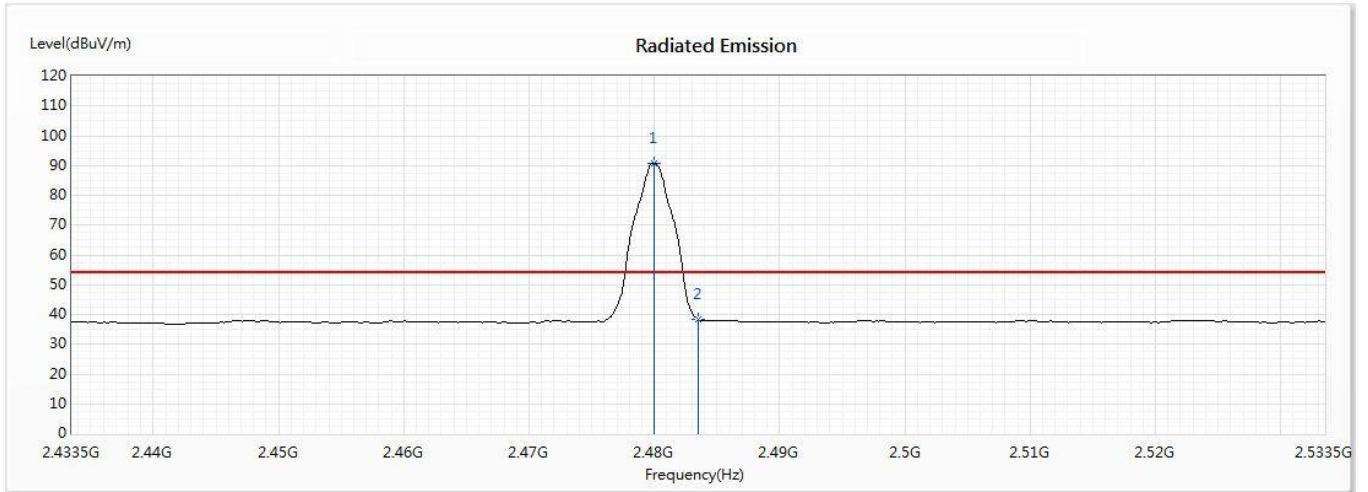

No	Frequency (MHz)	Emission Level (dBuV/m)	Limit (dBuV/m)	Margin (dB)	Reading Level (dBuV)	Correct Factor (dB/m)	Detector Type
! 1	2480.022	90.79	--	--	77.42	13.37	AV
2	2483.5	38.21	54.00	-15.79	24.83	13.38	AV

Note:

1. All readings above 1GHz are performed with peak and/or average measurements as necessary.
2. Measurement Level = Reading Level + Correct Factor.
3. The average measurement was not performed when the peak measured data under the limit of average detection.

5. Duty Cycle

5.1. Test Setup

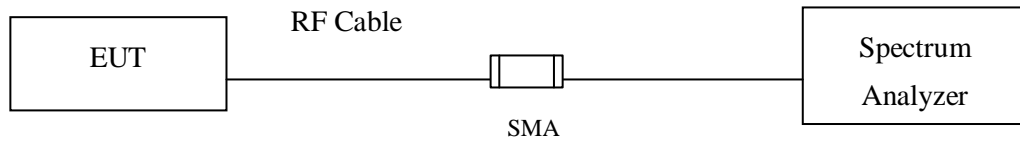

5.2. Test Procedure

The EUT was setup according to ANSI C63.10 2013; tested according to DTS test procedure of KDB558074 for compliance to FCC 47CFR 15.247 requirements.

5.3. Uncertainty

$\pm 2.31\text{msec}$

5.4. Test Result of Duty Cycle

Product : WiFi SOM Module
 Test Item : Duty Cycle
 Test Mode : Mode 1: Bluetooth LE 1Mbps

Duty Cycle Formula:

$$\text{Duty Cycle} = \text{Ton} / (\text{Ton} + \text{Toff})$$

$$\text{Duty Factor} = 10 \text{ Log} (1/\text{Duty Cycle})$$

Results:

2.4GHz band	Ton (ms)	Ton + Toff (ms)	Duty Cycle (%)	Duty Factor (dB)
BLE	2.1449	2.5217	85.06	0.70

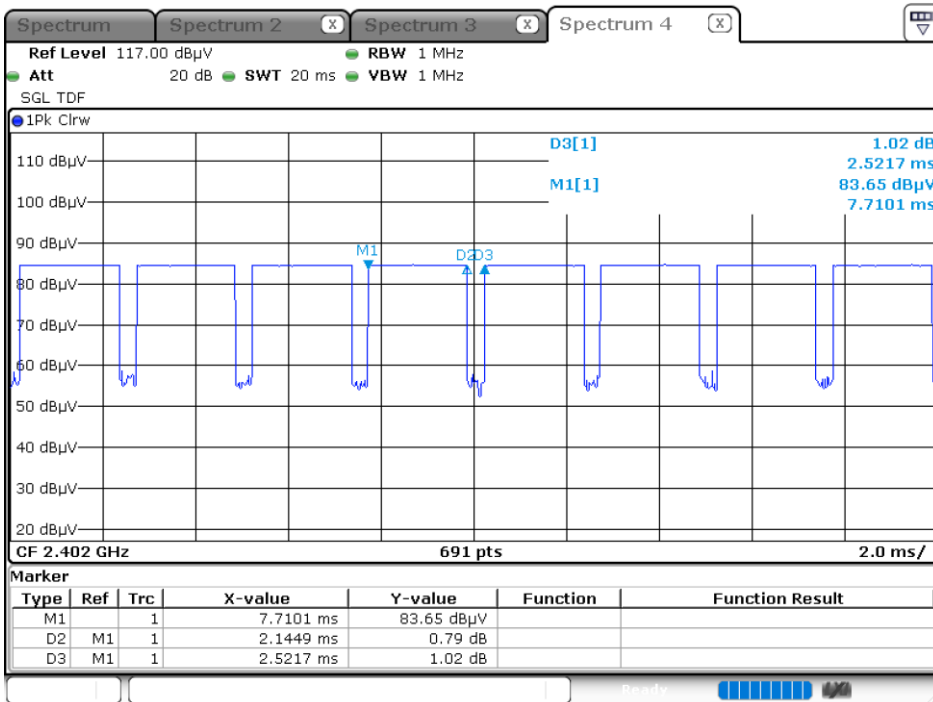

Date: 27.DEC.2019 02:38:04

Product : WiFi SOM Module
 Test Item : Duty Cycle
 Test Mode : Mode 2: Bluetooth LE 2Mbps

Duty Cycle Formula:

$$\text{Duty Cycle} = \text{Ton} / (\text{Ton} + \text{Toff})$$

$$\text{Duty Factor} = 10 \text{ Log} (1/\text{Duty Cycle})$$

Results:

2.4GHz band	Ton (ms)	Ton + Toff (ms)	Duty Cycle (%)	Duty Factor (dB)
BLE-2M	1.0725	1.8841	56.92	2.45

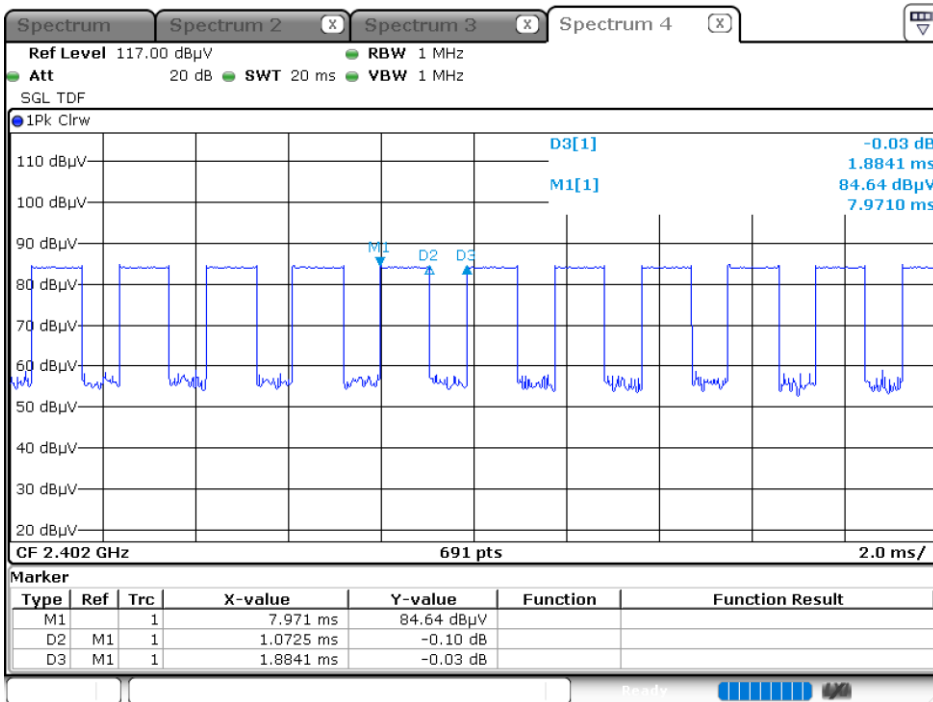

Date: 27.DEC.2019 02:36:20

6. EMI Reduction Method During Compliance Testing

No modification was made during testing.