



**FCC 47 CFR PART 15 SUBPART E
TEST REPORT**

For

Panel PC

Model : VM-521

Trade Name : RuggON

Issued for

RuggON Corporation

**3F., No.10, Ln. 181, Sec. 2, Jiuzong Rd., Neihu Dist., Taipei City 114, Taiwan
(R.O.C.)**

Issued by

**Compliance Certification Services Inc.
Hsinchu Lab.**

**NO. 989-1 Wen Shan Rd., Shang Shan Village,
Qionglin Shiang Hsinchu County 30741, Taiwan, R.O.C**

TEL: +886-3-5921698

FAX: +886-3-5921108

<http://www.ccsrf.com>

E-Mail : service@ccsrf.com

Issued Date: December 05, 2014



Note: This report shall not be reproduced except in full, without the written approval of Compliance Certification Services Inc. This document may be altered or revised by Compliance Certification Services Inc. personnel only, and shall be noted in the revision section of the document. The client should not use it to claim product endorsement by TAF or any government agencies. The test results of this report relate only to the tested sample identified in this report.



Revision History

Rev.	Issue Date	Revisions	Effect Page	Revised By
00	12/05/2014	Initial Issue	All Page 26	Michelle Chiu



TABLE OF CONTENTS

TITLE	PAGE NO.
1. TEST REPORT CERTIFICATION	4
2. EUT DESCRIPTION	5
3. DESCRIPTION OF TEST MODES	8
4. TEST METHODOLOGY	8
5. FACILITIES AND ACCREDITATION	9
5.1 FACILITIES	9
5.2 ACCREDITATIONS.....	9
5.3 MEASUREMENT UNCERTAINTY	10
6. SETUP OF EQUIPMENT UNDER TEST.....	11
7. DYNAMIC FREQUENCY SELECTION (DFS)	12
APPENDIX SETUP PHOTOS	26



1. TEST REPORT CERTIFICATION

Applicant : RuggON Corporation
Address : 3F., No.10, Ln. 181, Sec. 2, Jiuzong Rd., Neihu Dist., Taipei City 114, Taiwan (R.O.C.)
Equipment Under Test : Panel PC
Model : VM-521
Trade Name : RuggON
Tested Date : September 01 ~ November 25, 2014

APPLICABLE STANDARD	
Standard	Test Result
FCC Part 15 Subpart E	PASS

WE HEREBY CERTIFY THAT: The measurements shown in the attachment were made in accordance with the procedures indicated, and the energy emitted by the equipment was found to be within the limits applicable. We assume full responsibility for the accuracy and completeness of these measurements and vouch for the qualifications of all persons taking them.

Approved by:

Sb. Lu
Sr. Engineer

Reviewed by:

Gundam Lin
Sr. Engineer



2. EUT DESCRIPTION

Product Name	Panel PC
Model Number	VM-521
Identify Number	T140901D03
Received Date	September 01, 2014
Frequency Range	UNII Band 1:
	IEEE 802.11a, 802.11ac VHT20 : 5180 MHz ~ 5240 MHz
	IEEE 802.11ac VHT40 : 5190 MHz ~ 5230 MHz
	IEEE 802.11ac VHT80 : 5210 MHz
	UNII Band 2A:
	IEEE 802.11a, 802.11ac VHT20 : 5260 MHz ~ 5320 MHz
	IEEE 802.11ac VHT40 : 5270 MHz ~ 5310 MHz
	IEEE 802.11ac VHT80 : 5290 MHz
	UNII Band 2C:
	IEEE 802.11a, 802.11ac VHT20 : 5500 MHz ~ 5700 MHz
	IEEE 802.11ac VHT40 : 5510 MHz ~ 5670 MHz
	IEEE 802.11ac VHT80 : 5530 MHz
	UNII Band 3:
	IEEE 802.11a, 802.11ac VHT20 : 5745 MHz ~ 5825 MHz
IEEE 802.11ac VHT40 : 5755 MHz ~ 5795 MHz	
IEEE 802.11ac VHT80 : 5775 MHz	



Transmit Power	UNII Band 1:
	IEEE 802.11a : 15.00 dBm (0.0316 W)
	IEEE 802.11ac VHT20 : 16.91 dBm (0.00491 W)
	IEEE 802.11ac VHT40 : 16.65 dBm (0.0462 W)
	IEEE 802.11ac VHT80 : 11.80 dBm (0.0151 W)
	UNII Band 2A:
	IEEE 802.11a : 15.22 dBm (0.0333W)
	IEEE 802.11ac VHT20 : 17.40 dBm (0.0550 W)
	IEEE 802.11ac VHT40 : 17.38 dBm (0.0547 W)
	IEEE 802.11ac VHT80 : 13.48 dBm (0.0223 W)
	UNII Band 2C:
	IEEE 802.11a : 15.34 dBm (0.0342 W)
	IEEE 802.11ac VHT20 : 17.06 dBm (0.0508 W)
	IEEE 802.11ac VHT40 : 17.02 dBm (0.0504 W)
	IEEE 802.11ac VHT80 : 12.32 dBm (0.0171 W)
UNII Band 3:	
IEEE 802.11a : 15.08 dBm (0.0322 W)	
IEEE 802.11ac VHT20 : 16.94 dBm (0.0494 W)	
IEEE 802.11ac VHT40 : 17.11 dBm (0.0514 W)	
IEEE 802.11ac VHT80 : 17.24 dBm (0.0530 W)	
Channel Spacing	IEEE 802.11a, 802.11ac VHT20 : 20MHz
	IEEE 802.11ac VHT40 : 40MHz
	IEEE 802.11ac VHT80 : 80MHz
Channel Number	IEEE 802.11a, 802.11ac VHT20 :
	5150MHz ~ 5250MHz : 4 Channels
	5250MHz ~ 5350MHz : 4 Channels
	5500MHz ~ 5700MHz : 8 Channels
	5725MHz ~ 5850MHz : 5 Channels
	IEEE 802.11ac VHT40 : 5150MHz ~ 5250MHz : 2 Channels
	5250MHz ~ 5350MHz : 2 Channels
	5500MHz ~ 5700MHz : 3 Channels
	5725MHz ~ 5850MHz : 2 Channels
	IEEE 802.11ac VHT80 : 5150MHz ~ 5250MHz : 1 Channels
	5250MHz ~ 5350MHz : 1 Channels
	5500MHz ~ 5700MHz : 1 Channels
5725MHz ~ 5850MHz : 1 Channels	



Transmit Data Rate	IEEE 802.11a : up to 54 Mbps
	IEEE 802.11ac (VHT20,800ns GI) : up to 130 Mbps
	IEEE 802.11ac (VHT20,400ns GI) : up to 144.4 Mbps
	IEEE 802.11ac (VHT40,800ns GI) : up to 270 Mbps
	IEEE 802.11ac (VHT40,400ns GI) : up to 300 Mbps
	IEEE 802.11ac (VHT80,800ns GI) : up to 780 Mbps
	IEEE 802.11ac (VHT80,400ns GI) : up to 866.6 Mbps
Type of Modulation	IEEE 802.11a : OFDM (64QAM, 16QAM, QPSK, BPSK)
	IEEE 802.11ac VHT20/VHT40 : OFDM (64QAM, 16QAM, QPSK, BPSK)
	IEEE 802.11ac VHT80 : OFDM (256QAM, 64QAM, 16QAM, QPSK, BPSK)
Antenna Type	Dipole Antenna × 2 (External), Antenna 1(Chain A), Antenna Gain : 5.5 dBi Antenna 2(Chain B), Antenna Gain : 5.5 dBi
	PIFA Antenna × 2 (Internal), Antenna 1(Chain A), Antenna Gain : 4.73 dBi Antenna 2(Chain B), Antenna Gain : 5.39 dBi
Power Rating	24Vdc / 48Vdc 7.5Vdc from Battery
Test Voltage	120Vac, 60Hz
DC Power Cable Type	Shielded cable, 3.1 m × 1 (Detachable)
I/O Port	Audio In Port × 1, Audio Out Port × 1, RJ-45 Port × 2, USB(RS232) Port × 1, Expansion Port × 1, Canbus Port × 2, COM Port × 2, DIO Port × 1, Power Port × 1



3. DESCRIPTION OF TEST MODES

The EUT (VM-521) had been tested under operating condition.

Software used to control the EUT for staying in continuous transmitting mode was programmed.

IEEE 802.11ac VHT20:

Channel Low (5300MHz) and Channel Low (5500MHz).

IEEE 802.11ac VHT80:

Channel Low (5290MHz) and Channel Low (5530MHz).

No.	Antenna Position	Antenna Type	Antenna Gain (dBi)		Test item	
			1	2	Spurious emissions	Conducted
			1	External		
2	Internal	PIFA	4.73	5.39	V	

4. TEST METHODOLOGY

The tests documented in this report were performed in accordance with FCC 06-96 and the DFS portions of FCC CFR 47 Part 15.



5. FACILITIES AND ACCREDITATION

5.1 FACILITIES

All measurement facilities used to collect the measurement data are located at

NO. 989-1 Wen Shan Rd., Shang Shan Village,
Qionglin Shiang Hsinchu County 30741, Taiwan, R.O.C

The sites are constructed in conformance with the requirements of ANSI C63.4:2009 and CISPR 22. All receiving equipment conforms to CISPR 16-1-1, CISPR 16-1-2, CISPR 16-1-3, CISPR 16-1-4, CISPR 16-1-5.

5.2 ACCREDITATIONS

Our laboratories are accredited and approved by the following approval agencies according to ISO/IEC 17025.

Taiwan TAF

The measuring facility of laboratories has been authorized or registered by the following approval agencies.

Canada	INDUSTRY CANADA
Japan	VCCI
Taiwan	BSMI
USA	FCC MRA

Copies of granted accreditation certificates are available for downloading from our web site, <http://www.ccsrf.com>

Remark: FCC Designation Number TW1027.



5.3 MEASUREMENT UNCERTAINTY

The interpretation of the results for the measurements described in the present document shall be as follows:

- (1) The measured value related to the corresponding limit will be used to decide whether an equipment meets the requirements of the present document.
- (2) The measurement uncertainty value for the measurement of each parameter shall be recorded.
- (3) The recorded value of the measurement uncertainty shall be, for each measurement, equal to or lower than the figures under the table.

PARAMETER	UNCERTAINTY
RF frequency	+/-1 * 10 ⁻⁵
RF power conducted	+/- 1,5 dB
RF power radiated	+/- 6 dB
Spurious emissions, conducted	+/- 3 dB
Spurious emissions, radiated	+/- 6 dB
Humidity	+/- 5 %
Temperature	+/- 1°C
Time	+/-10 %

For the test methods, according to the present document, the measurement uncertainty figures shall be calculated in accordance with TR 100 028-1 [2] and shall correspond to an expansion factor (coverage factor) $k = 1.96$ or $k = 2$ (which provide confidence levels of respectively 95 % and 95.45 % in the case where the distributions characterizing the actual measurement uncertainties are normal (Gaussian)).



6. SETUP OF EQUIPMENT UNDER TEST

SUPPORT EQUIPMENT

No.	Product	Manufacturer	Model No.	Serial No.
1	Notebook PC	DELL	PP19L	CN-0MG532-70166-71G-03EC
2	Wireless AC1750 Dual Band Gigabit Cloud Router	D-Link	DIR-868L	R3WE1E1001943

Power Adapter :

No.	Manufacturer	Model No.	Power Input	Power Output
1	DELTA	ADP-60DH REV.B	100-240Vac, 1.5A, 50-60Hz	19Vdc 3.16A

No.	Signal Cable Description
1	Non-shielded RJ-45 cable, 1.2m × 1
2	Non-shielded AC power cable, 1.8m × 1

SETUP DIAGRAM FOR TESTS

EUT & peripherals setup diagram is shown in appendix setup photos.

EUT OPERATING CONDITION

1. EUT & peripherals setup diagram is shown in appendix setup photos.

2. Enter the web configuration:

⇒ **Select channel**

6.5 Mbps Bandwidth 20 (IEEE 802.11ac VHT20 mode)

29.3 Mbps Bandwidth 80 (IEEE 802.11ac VHT80 mode)

⇒ **Select channel**

IEEE 802.11ac VHT20 Channel Low (5300MHz)

IEEE 802.11ac VHT20 Channel Low (5500MHz)

IEEE 802.11ac VHT80 Channel Low (5290MHz)

IEEE 802.11ac VHT80 Channel Low (5530MHz)

3. All of the functions are under run.

4. Start testing



7. DYNAMIC FREQUENCY SELECTION (DFS)

Interference Threshold values, Master or Client incorporating In-Service

Maximum Transmit Power	Value (see note)
≥ 200 mW	-64 dBm
< 200 mW	-62 dBm

Note: 1. This is the level at the input of the receiver assuming a 0 dBi receive antenna.

2. Throughout these test procedures an additional 1 dB has been added to the amplitude of the test transmission waveforms to account for variations in measurement equipment. This will ensure that the test signal is at or above the detection threshold level to trigger a DFS response.

DFS Response requirement values

Parameter	Value
Non-occupancy period	Minimum 30 minutes
Channel Availability Check Time	60 seconds
Channel Move Time	10 seconds
Channel Closing Transmission Time	200 milliseconds + approx. 60 milliseconds over remaining 10 second period
U-NII Detection Bandwidth	Minimum 80% of the 99% transmission power bandwidth.

Note 1. The instant that the Channel Move Time and the Channel Closing Transmission Time begins is as follows:

- For the Short pulse radar Test Signals this instant is the end of the Burst.
- For the Frequency Hopping radar Test Signal, this instant is the end of the last radar burst generated.
- For the Long Pulse radar Test Signal this instant is the end of the 12 second period defining the radar transmission.

Note 2. The Channel Closing Transmission Time is comprised of 200 milliseconds starting at the beginning of the Channel Move Time plus any additional intermittent control signals required to facilitate channel changes (an aggregate of approximately 60 milliseconds) during the remainder of the 10 second period. The aggregate duration of control signals will not count quiet periods in between transmissions.

Note 3. During the U-NII Detection Bandwidth detection test, radar type 1 is used and for each frequency step the minimum percentage of detection is 90%. Measurements are performed with no data traffic.

Radar Test Waveforms Minimum Step

Step intervals of 0.1 microsecond for Pulse Width, 1 microsecond for PRI, 1 MHz for chirp width and 1 for the number of pulses will be utilized for the random determination of specific test waveforms.



Short Pulse Radar Test Waveforms

Radar Type	Pulse Width (Microseconds)	PRI (Microseconds)	Pulses	Minimum Percentage of Successful Detection	Minimum Trials
1	1	1428	18	60%	30
2	1-5	150-230	23-29	60%	30
3	6-10	200-500	16-18	60%	30
4	11-20	200-500	12-16	60%	30
Aggregate (Radar Types 1-4)				80%	120

A minimum of 30 unique waveforms are required for each of the short pulse radar types 2 through 4. For short pulse radar type 1, the same waveform is used a minimum of 30 times. If more than 30 waveforms are used for short pulse radar types 2 through 4, then each additional waveform must also be unique and not repeated from the previous waveforms. The aggregate is the average of the percentage of successful detections of short pulse radar types 1-4.

Long Pulse Radar Test Waveform

Radar Waveform	Pulse Width (µsec)	Chirp Width (µsec)	PRI (µsec)	Pulses per Burst	Bursts	Minimum Percentage of Successful Detection	Minimum Trials
5	50-100	5-20	1000-2000	1-3	8-20	80%	30

Frequency Hopping Radar Test Signal

Radar Waveform	Pulse Width (µsec)	PRI (µsec)	Pulses Per Hop	Hopping Rate (kHz)	Burst Length (ms)	Minimum Percentage of Successful Detection	Minimum Trials
6	1	333	9	0.33	300	70%	30



Applicability of DFS requirements prior to use of a channel

Requirement	Operational Mode		
	Master	Client (without radar detection)	Client(with radar detection)
Non-Occupancy Period	Yes	Yes	Yes
DFS Detection Threshold	Yes	Not Required	Yes
Channel Availability Check Time	Yes	Not Required	Not Required
Uniform Spreading	Yes	Not Required	Not Required
U-NII Detection Bandwidth	Yes	Not Required	Yes

Applicability of DFS requirements during normal operation

Requirement	Operational Mode		
	Master	Client (without radar detection)	Client(with radar detection)
DFS Detection Threshold	Yes	Not Required	Yes
Channel Closing Transmission Time	Yes	Yes	Yes
Channel Move Time	Yes	Yes	Yes
U-NII Detection Bandwidth	Yes	Not Required	Yes

CONDUCTED METHOD SYSTEM BLOCK DIAGRAM

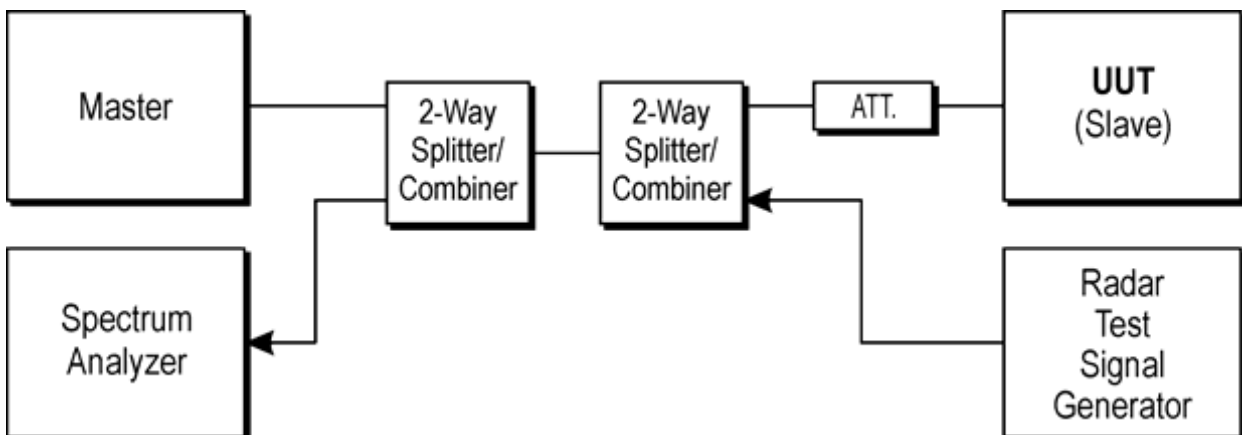



DESCRIPTION OF EUT

Overview Of EUT With Requirements

The firmware installed in the EUT during testing was:

Firmware Rev: 16.0.0.62

The EUT operates over the 5250-5350 MHz and 5470-5725MHz ranges.

The EUT is a Client without radar detection.

Two antennas are utilized to meet the system operational requirements.

TEST CHANNELS AND METHOD

All tests were performed at a channel center frequency of 5300MHz / 5290MHz;
5500MHz / 5530MHz.

Measurements were performed using conducted test methods.

TEST SETUP

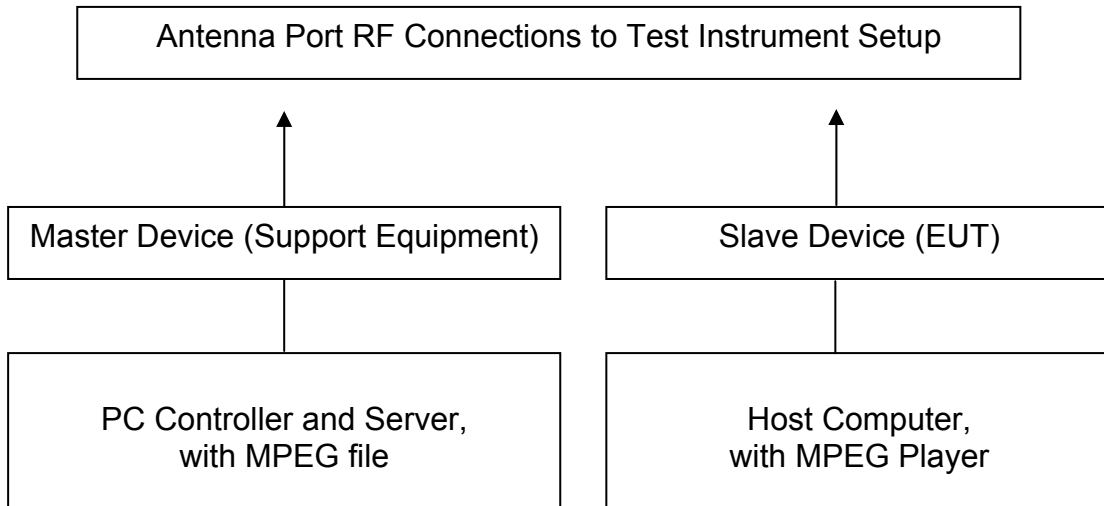



Radar Waveform calibration Plot

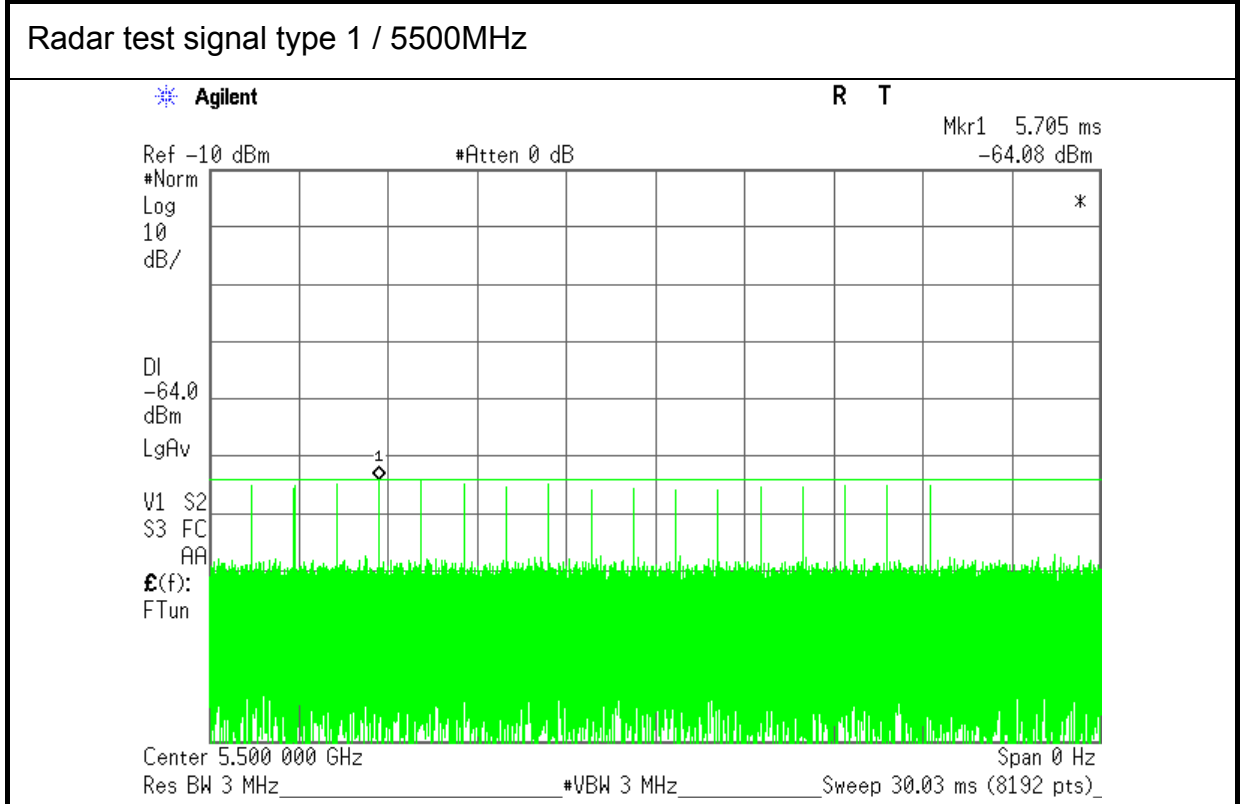
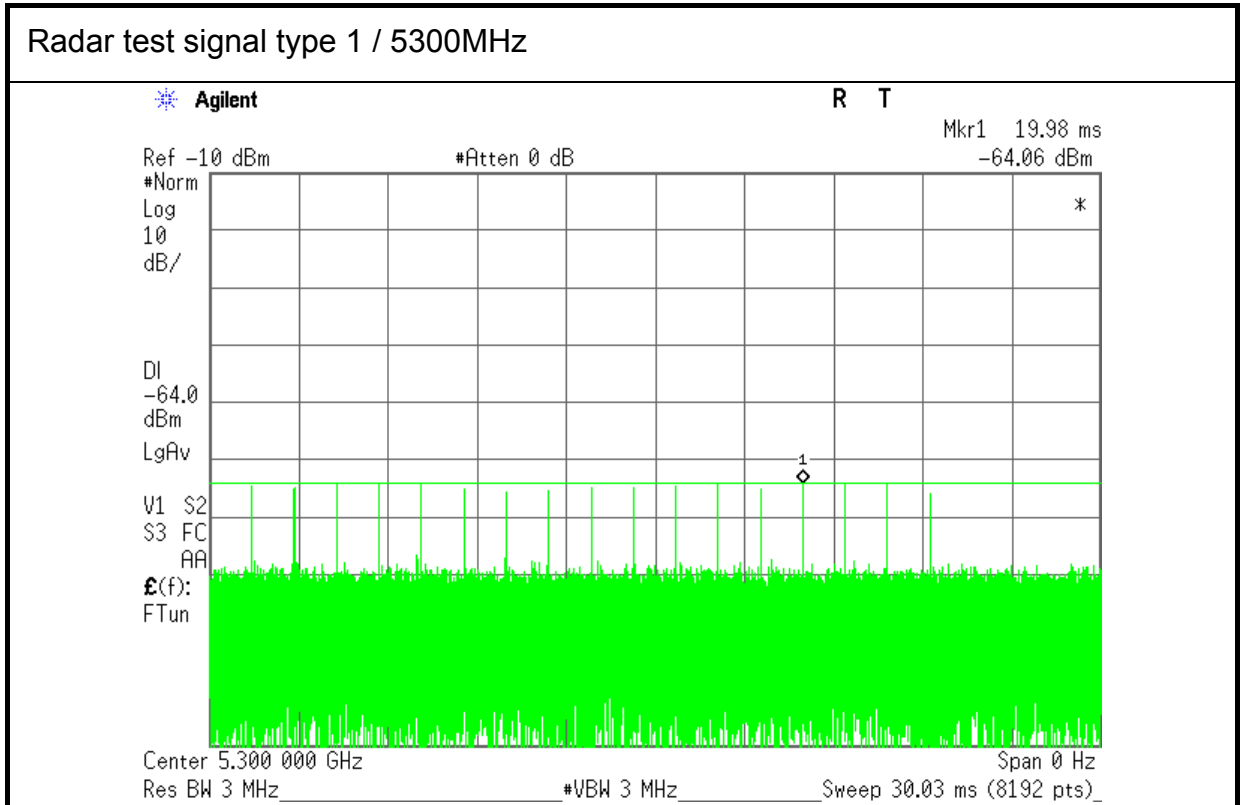



Radar test signal type 1 / 5290MHz

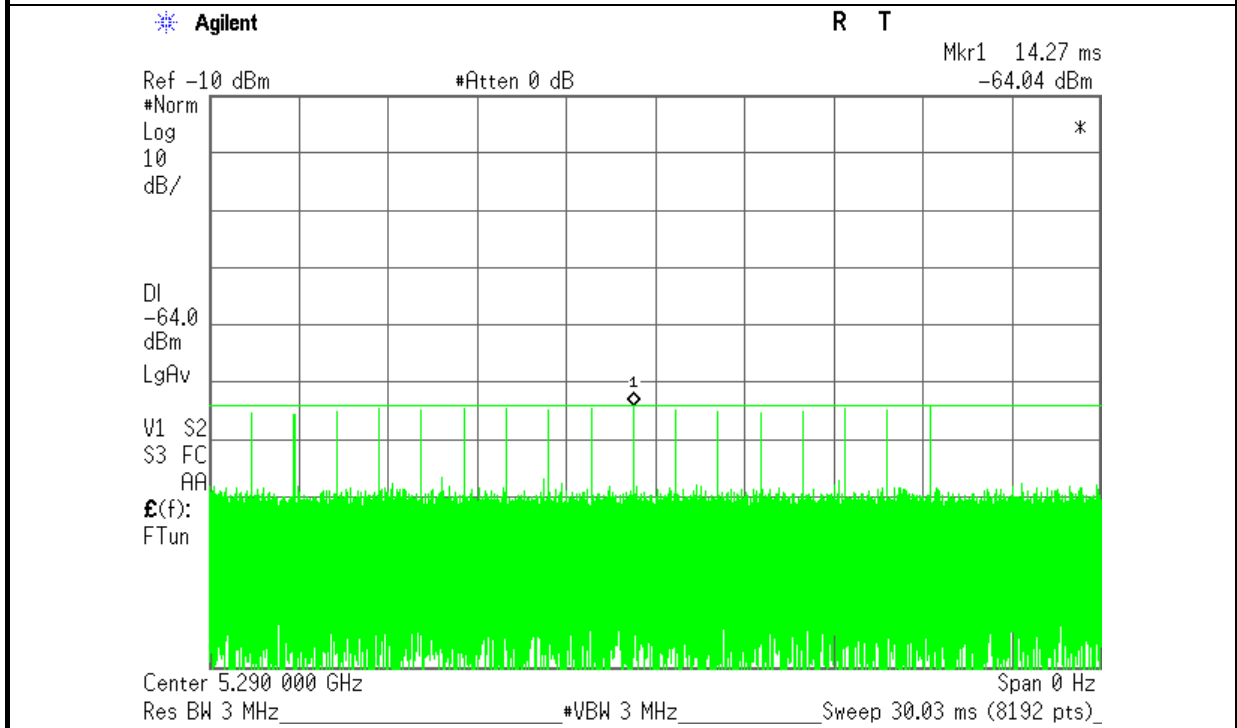

Radar test signal type 1 / 5530MHz

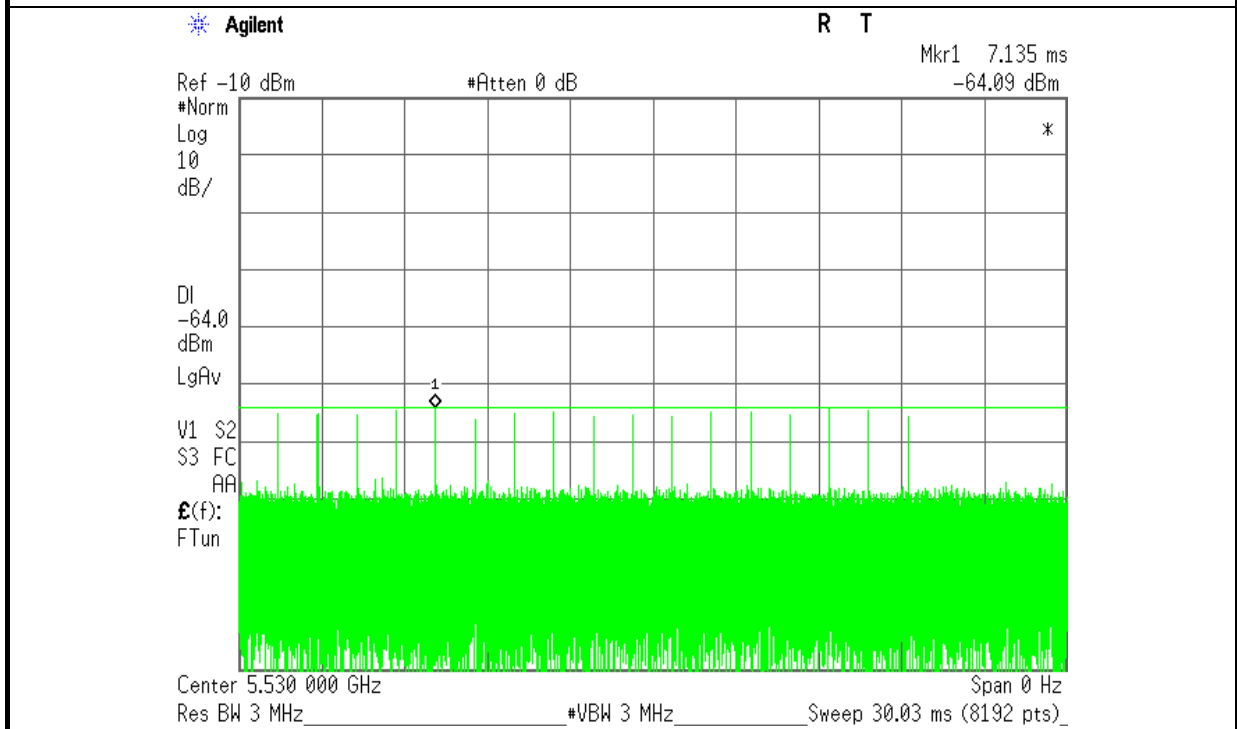



Test Result of Duty Plots

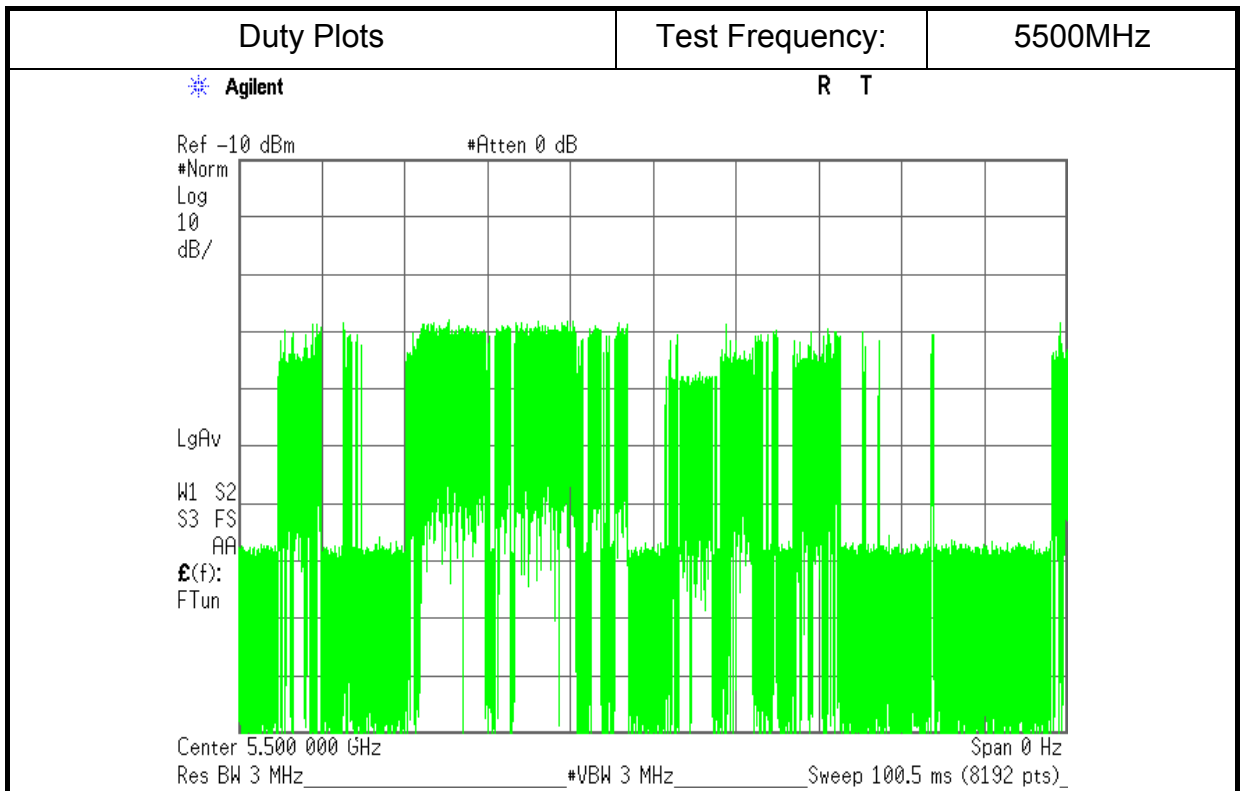
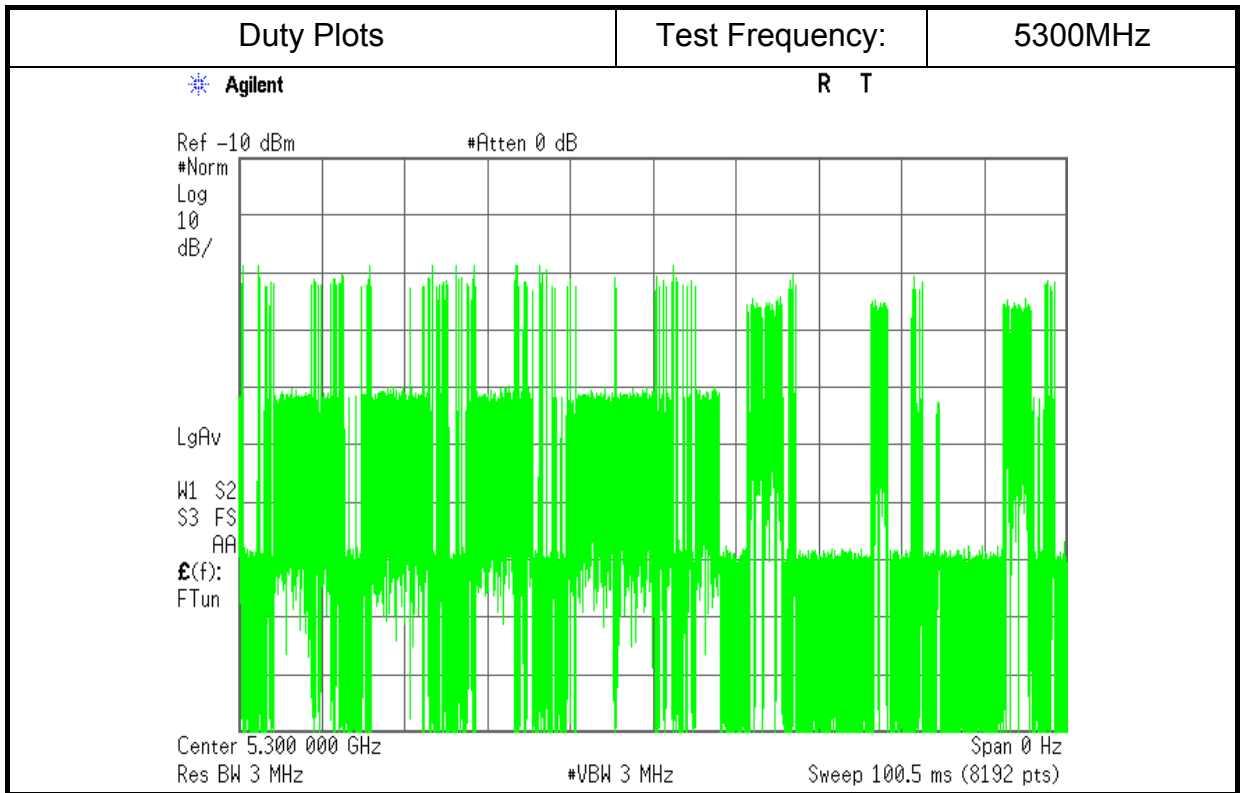

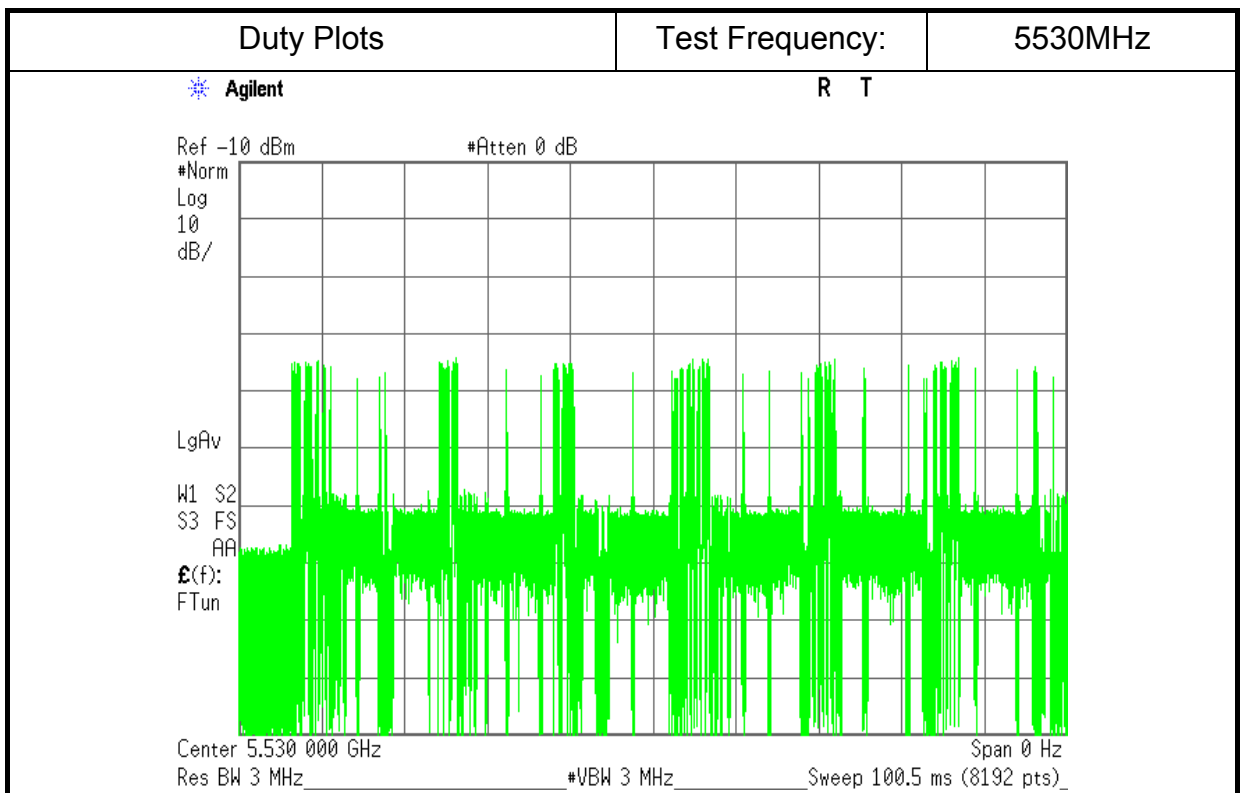
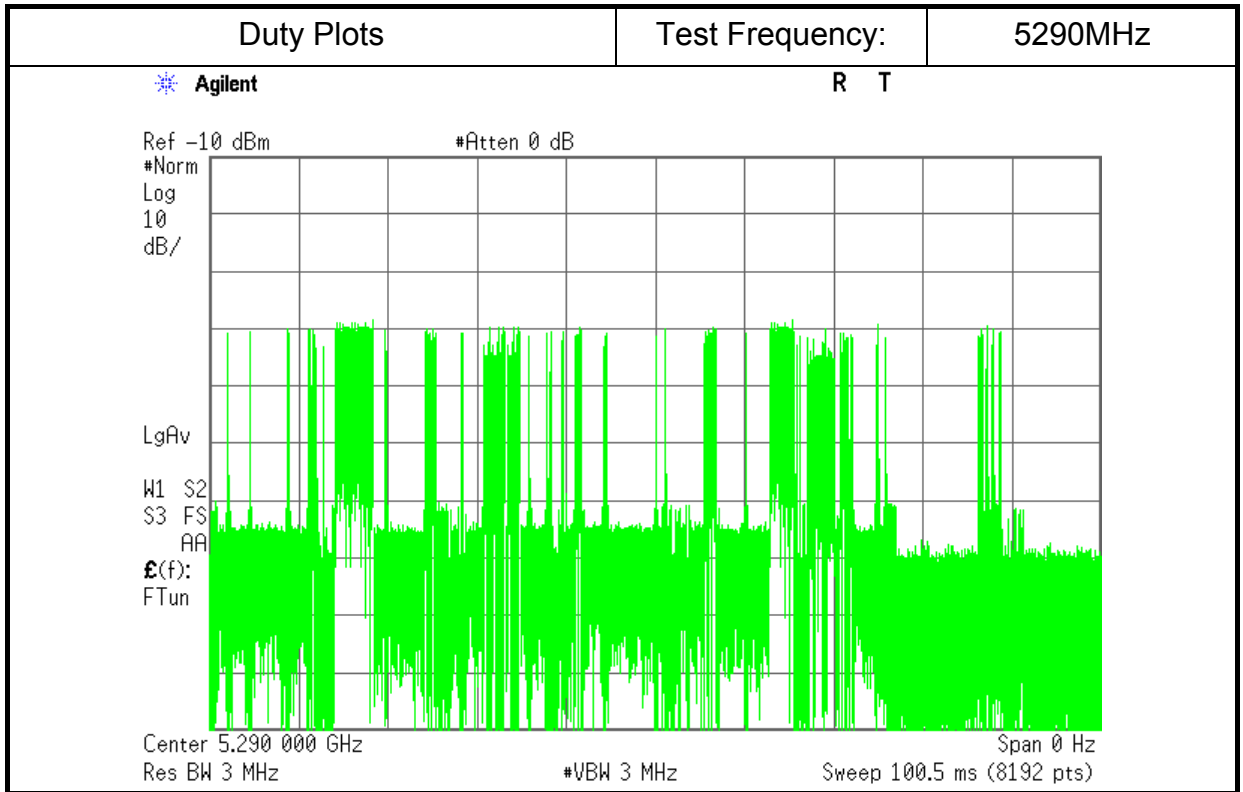



Test Result of Channel Shutdown Time Plots

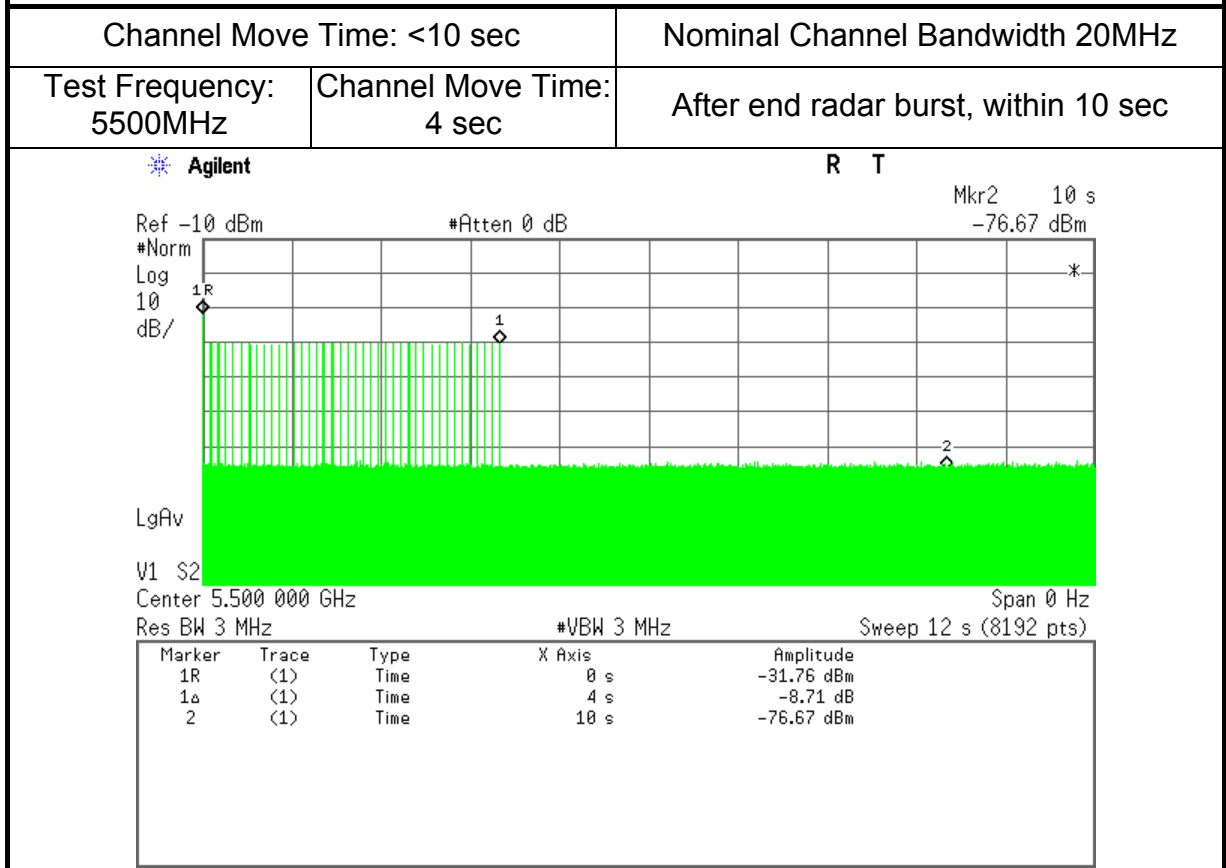
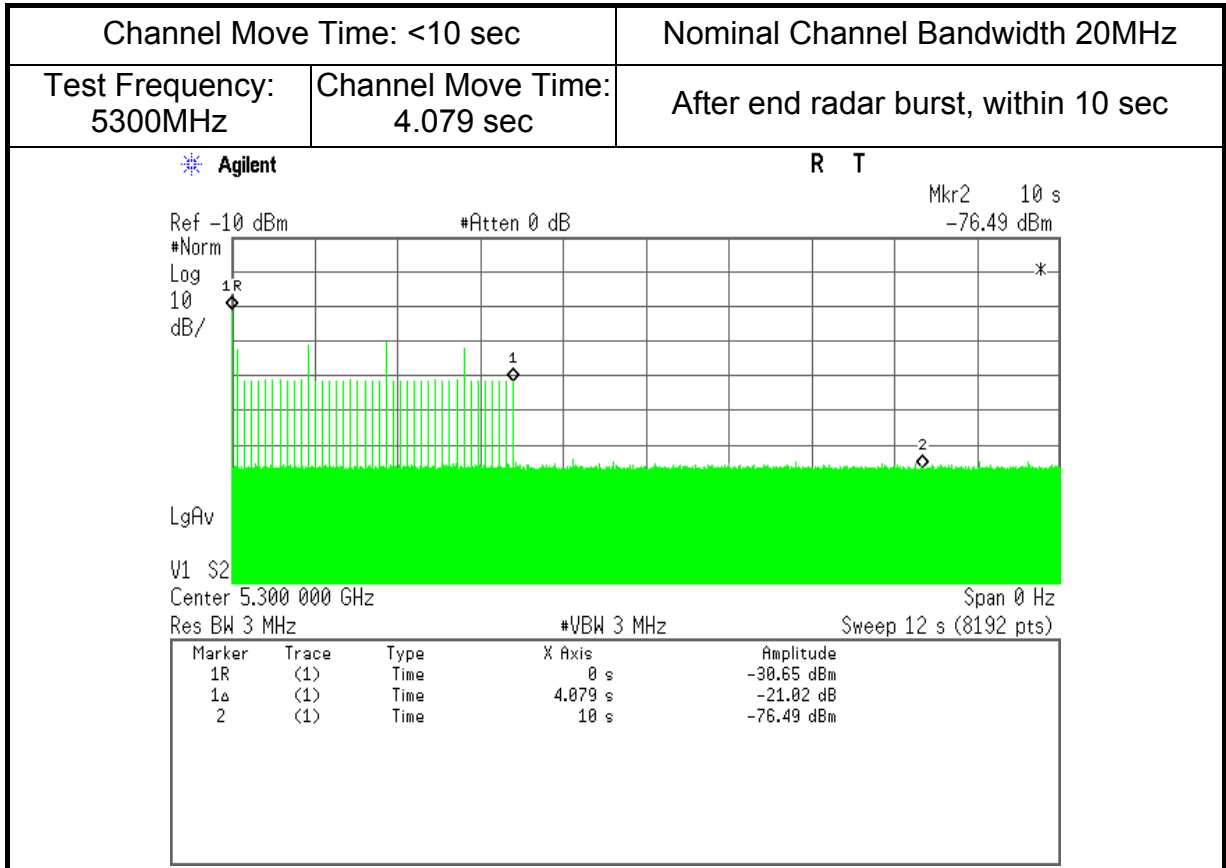

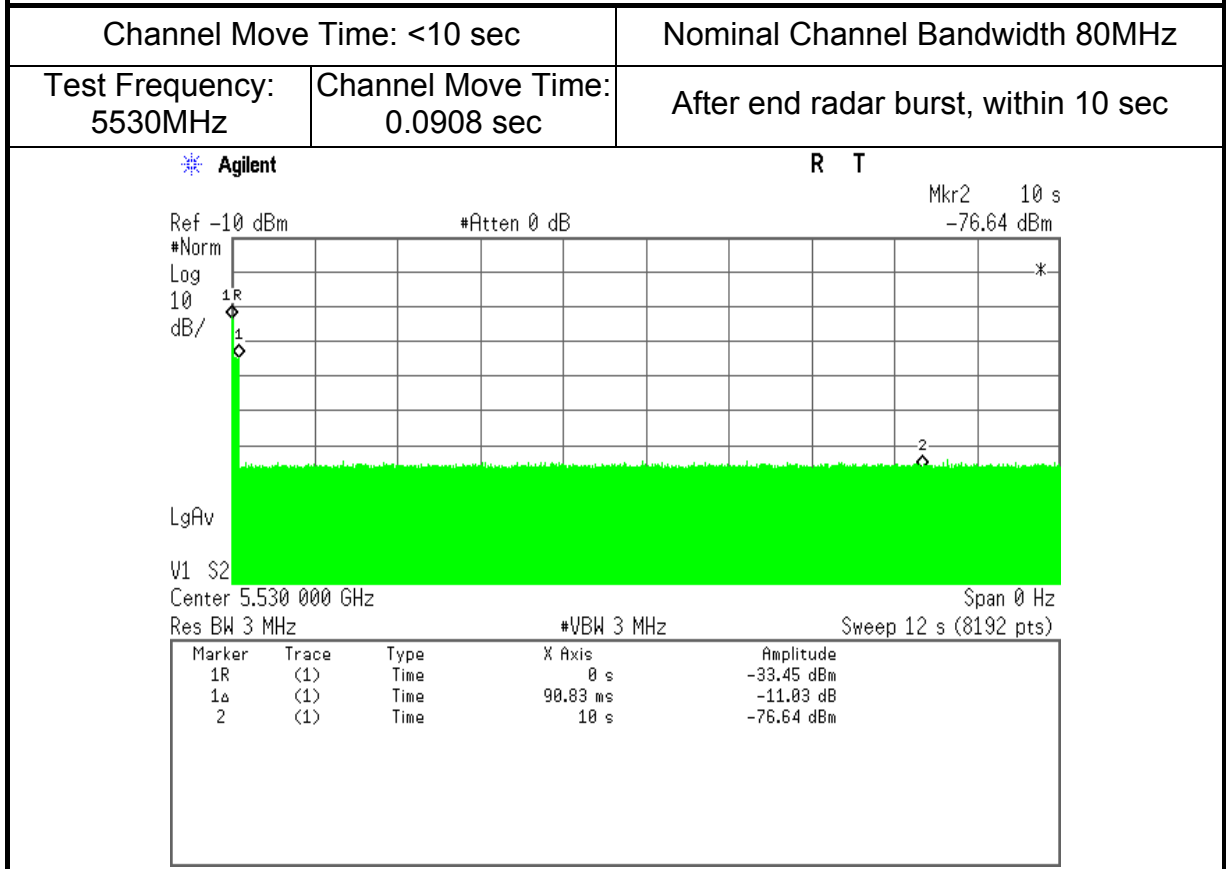
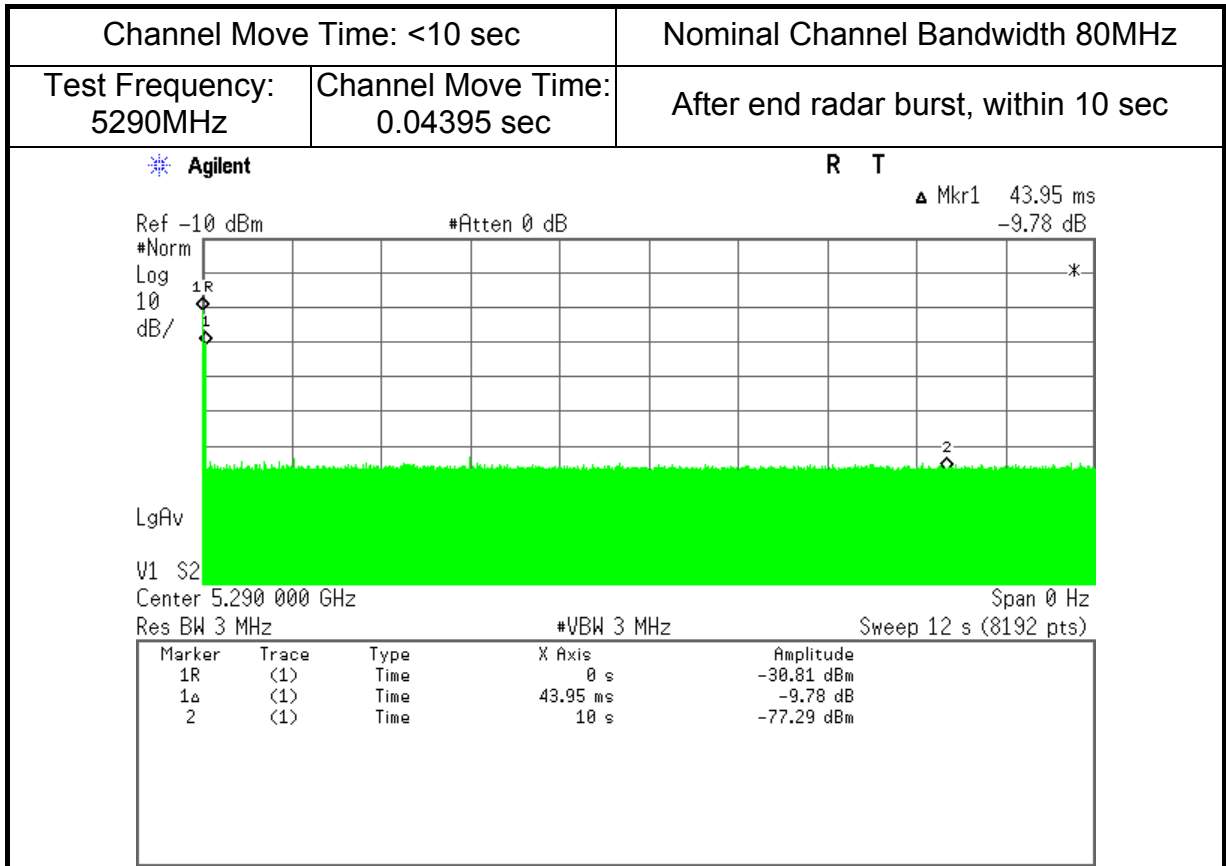

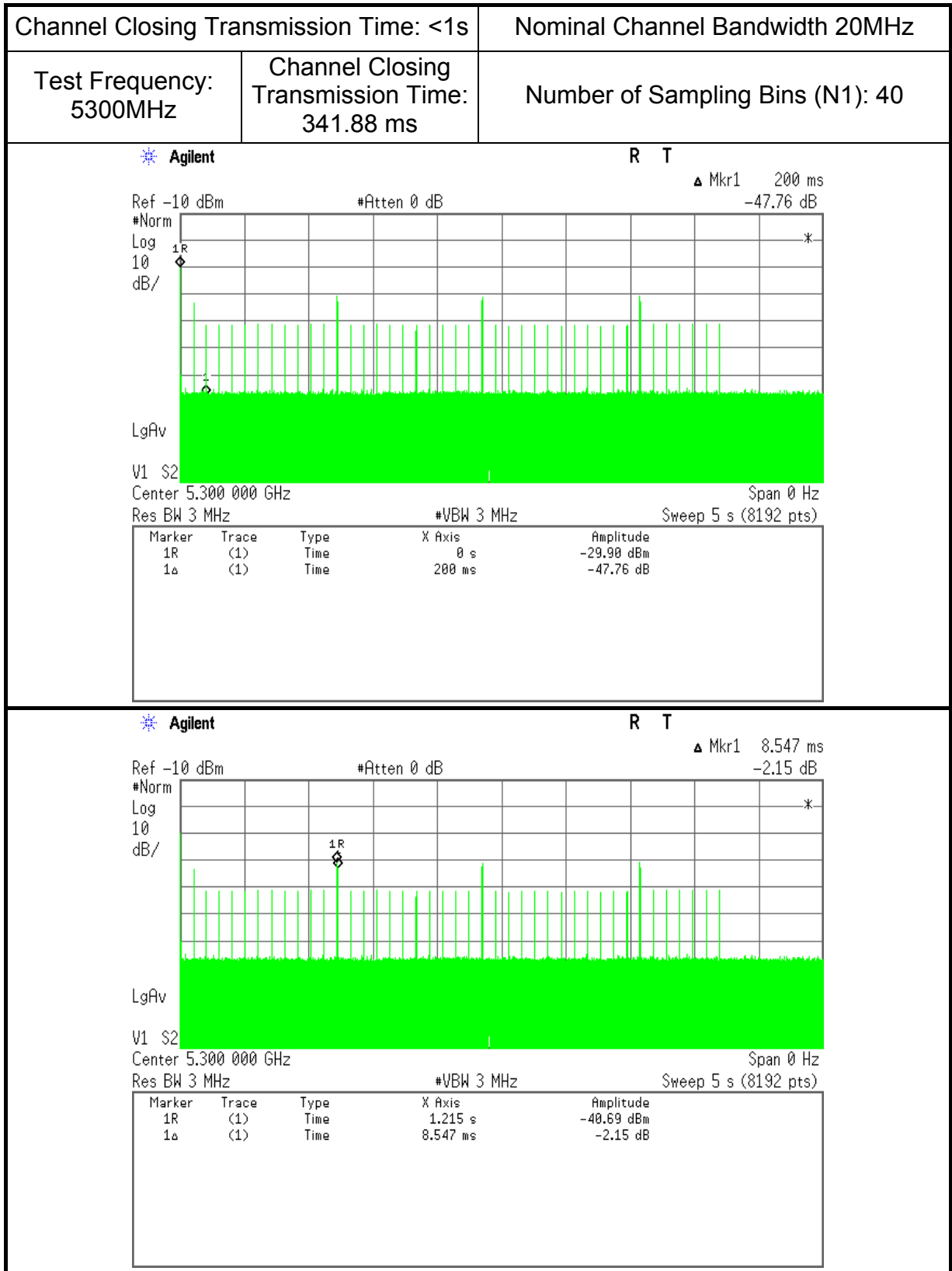

Note1: 5300 = N1 × Dwell1 = 8.547ms × 40 = 341.88ms

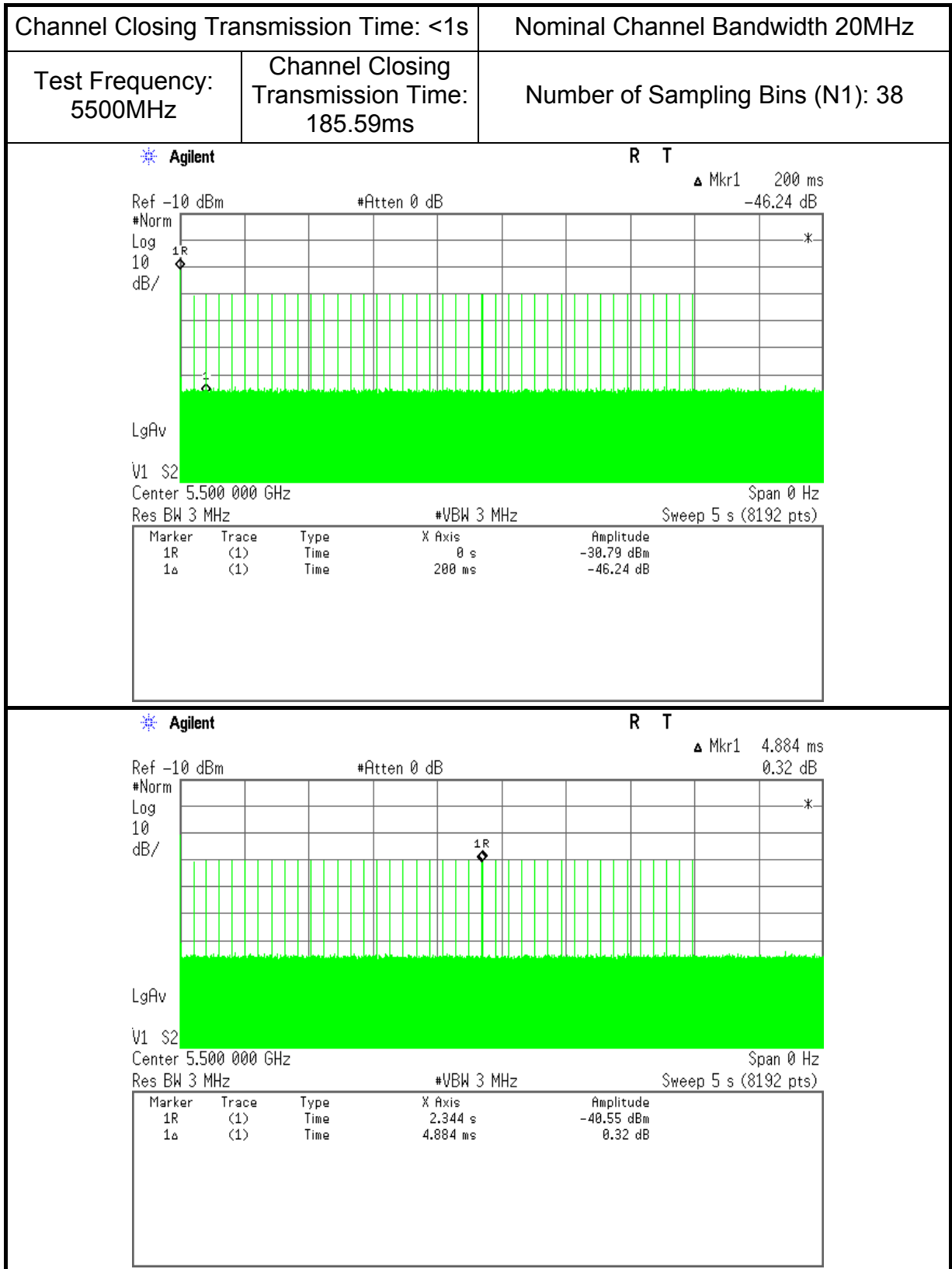

Note1: 5500 = N1 × Dwell1 = 4.884ms × 38 = 185.59ms

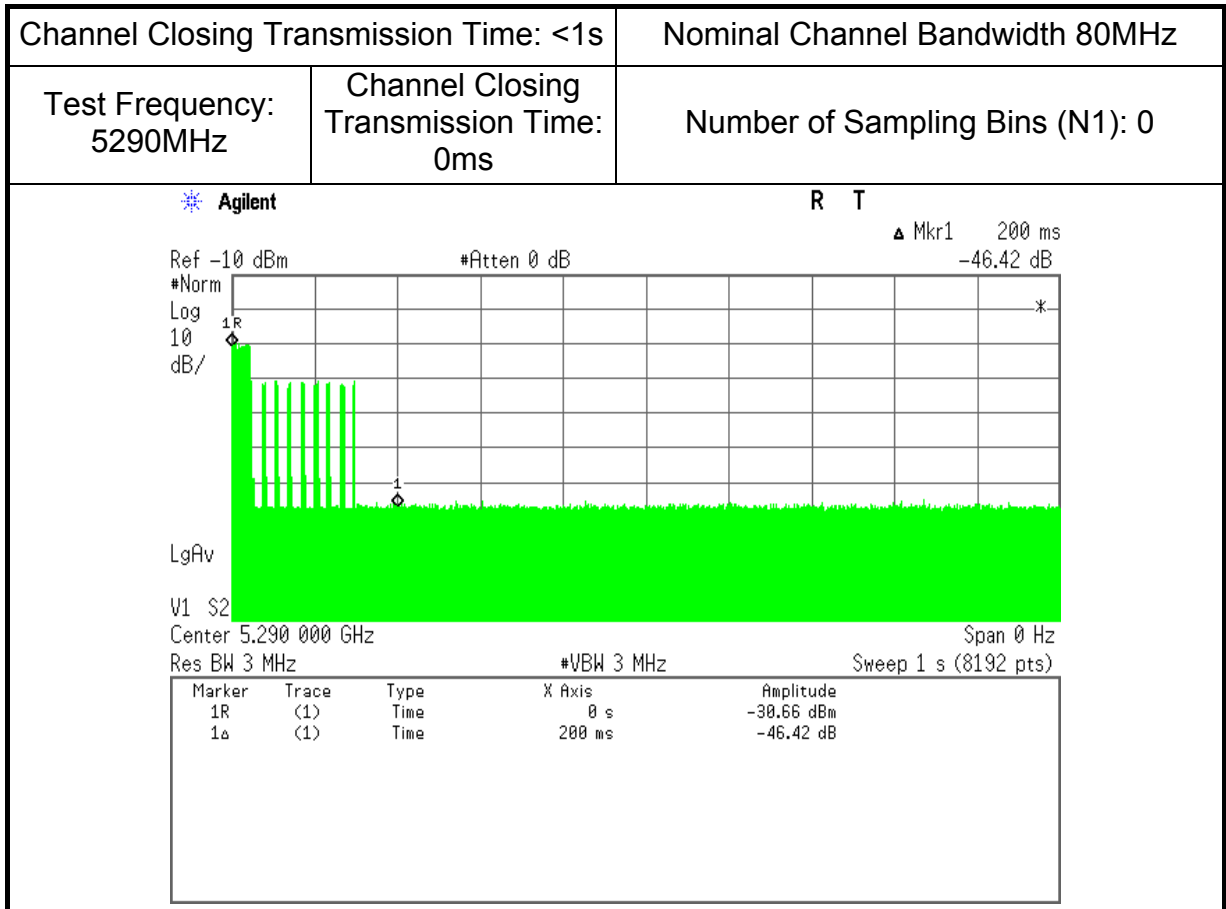

Note1: 5290 = N1 × Dwell1 = 0ms × 0 = 0ms

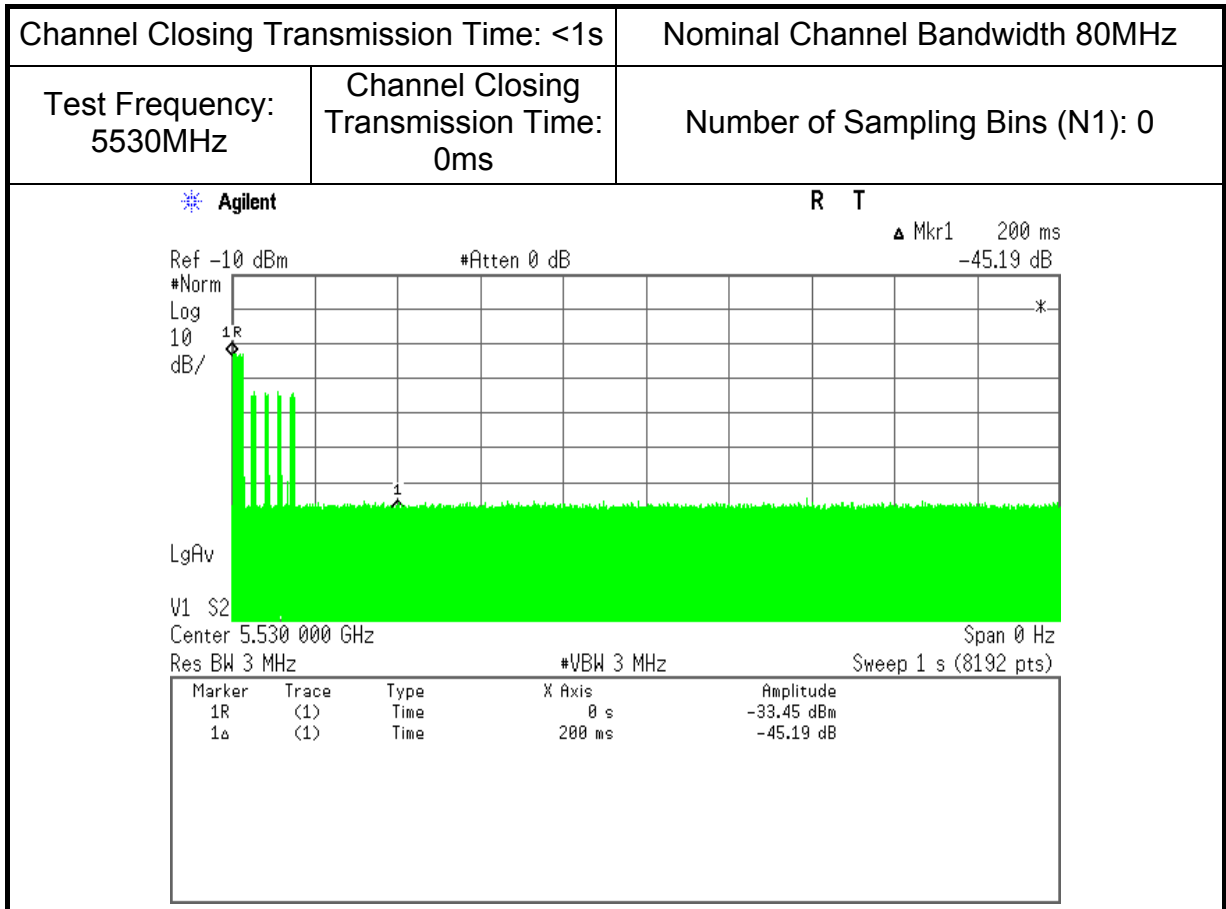

Note1: 5530 = N1 × Dwell1 = 0ms × 0 = 0ms