

FCC SAR Test Report

Product Name : TABLET PC
Model No. : PX-501

Applicant : RuggON Corporation
Address : 3F., No.10, Ln. 181, Sec. 2, Jiuzong Rd., Neihu Dist.,
Taipei City , Taiwan

Date of Receipt : 2015/01/06
Issued Date : 2015/02/24
Report No. : 1510381R-SAUSP01V00
Report Version : V1.0



The test results relate only to the samples tested.

The test results shown in the test report are traceable to the national/international standard through the calibration of the equipment and evaluated measurement uncertainty herein.

This report must not be used to claim product endorsement by TAF or any agency of the government.

The test report shall not be reproduced without the written approval of QuieTek Corporation.

Test Report

Issued Date: 2015/02/24

Report No.: 1510381R-SAUSP01V00



Product Name : TABLET PC
 Applicant : RuggON Corporation
 Address : 3F., No.10, Ln. 181, Sec. 2, Jiuzong Rd., Neihu Dist., Taipei City , Taiwan
 Manufacturer : Ubiquconn Technology, Inc.
 Model No. : PX-501
 Trade Name : RuggON
 FCC ID : 2ABTU-PX-501
 Applicable Standard : FCC Oet65 Supplement C June 2001
 IEEE Std. 1528-2003
 47CFR § 2.1093
 Measurement procedures : KDB 447498 D01 v05r02
 KDB 248227 D01 v01r02
 KDB 616217 D04 V01r01
 KDB 865664 D01 V01r01
 Test Result : Max. SAR Measurement (1g)
 802.11b/g(2.4GHz): **0.20** W/kg
 802.11a(5 GHz): **0.55** W/kg
 Application Type : Certification

Documented By : Anny Chou
 (Adm. Specialist / Anny Chou)

Tested By : wenLee
 (Engineer / Wen Lee)

Approved By : [Signature]
 (Director / Vincent Lin)

TABLE OF CONTENTS

Description	Page
1. General Information.....	5
1.1 EUT Description	5
1.2 Antenna List.....	5
1.3 Maximum output power and tolerance allowed for production units.....	6
1.4 SAR Test Exclusion Calculation	7
1.5 Test Environment.....	8
2. SAR Measurement System	9
2.1 DASY5 System Description	9
2.1.1 Applications	10
2.1.2 Area Scans.....	10
2.1.3 Zoom Scan (Cube Scan Averaging).....	10
2.1.4 Uncertainty of Inter-/Extrapolation and Averaging.....	10
2.2 DASY5 E-Field Probe	11
2.2.1 Isotropic E-Field Probe Specification.....	11
2.3 Boundary Detection Unit and Probe Mounting Device.....	12
2.4 DATA Acquisition Electronics (DAE) and Measurement Server.....	12
2.5 Robot.....	13
2.6 Light Beam Unit.....	13
2.7 Device Holder	14
2.8 SAM Twin Phantom	14
3. Tissue Simulating Liquid	15
3.1 The composition of the tissue simulating liquid.....	15
3.2 Tissue Calibration Result	15
3.3 Tissue Dielectric Parameters for Head and Body Phantoms	18
4. SAR Measurement Procedure	19
4.1 SAR System Check.....	19
4.1.1 Dipoles	19
4.1.2 System Check Result	19
4.2 SAR Measurement Procedure.....	21
5. SAR Exposure Limits	22
6. Test Equipment List.....	23
7. Measurement Uncertainty	24
8. Conducted Power Measurement	25
9. Test Results.....	27
9.1 SAR Test Results Summary	27

9.2 Simultaneous Transmission 29

10. SAR measurement variability 30

Appendix 31

Appendix A. SAR System Check Data

Appendix B. SAR measurement Data

Appendix C. Test Setup Photographs & EUT Photographs

Appendix D. Probe Calibration Data

Appendix E. Dipole Calibration Data

1. General Information

1.1 EUT Description

Product Name	TABLET PC
Trade Name	RuggON
Model No.	PX-501
FCC ID	2ABTU-PX-501
TX Frequency	802.11b/g/n-20MHz: 2412-2462MHz, 802.11n-40MHz: 2422-2452MHz 802.11a/n-20MHz: 5180-5320MHz,5500-5700MHz, 5745-5825MHz 802.11n-40MHz: 5190-5310, 5510-5670MHz, 5755-5795MHz 802.11ac-20MHz: 5720, 802.11ac-40MHz: 5710 802.11ac-80MHz: 5210-5290MHz, 5530-5690MHz, 5775MHz
Number of Channels	802.11b/g/n-20MHz: 11, n-40MHz: 7 802.11a/n-20MHz: 24, n-40MHz: 11 802.11ac-20MHz: 1, 802.11ac-40MHz: 1, 802.11ac-80MHz: 5
Data Rate	802.11b: 1-11Mbps, 802.11a/g: 6-54Mbps, 802.11n: up to 300Mbps 802.11ac-80MHz: up to 866.7MHz
Type of Modulation	802.11b:DSSS, DBPSK, DQPSK, CCK 802.11a/g/n/ac:OFDM,BPSK, QPSK, 16QAM, 64QAM, 256QAM
Contain Module	Intel / 7260HMW
Antenna Type	PCB
Device Category	Portable
RF Exposure Environment	Uncontrolled
Max. Output Power (Conducted)	802.11b: 15.50 dBm 802.11g/n-20M/n-40M: 16.50 dBm 802.11a/n-20M/n-40M: 16.50 dBm

1.2 Antenna List

No.	Manufacturer	Part No.	Peak Gain
1	ethertronics	5001791 (Main)(TX1) 5001799 (Aux)(TX2)	3.8dBi For 2.4GHz 5.1dBi For 5.15~5.25GHz 5.1dBi For 5.25~5.35GHz 4.2dBi For 5.47~5.725GHz 2.6dBi For 5.725~5.850GHz

1.3 Maximum output power and tolerance allowed for production units

Band	Mode	Nominal power (dBm)	Tolerance (dBm)	Upper Tolerance (dBm)
2.4G	802.11b Main (CH 1~11)/ 802.11g Aux (CH 6,CH10)	14	±1.5	15.5
2.4G	802.11b Aux (CH 1~11)	12.5	±1.5	14
2.4G	802.11g Main (CH 6)/ 802.11n-20M(CH6,CH11)	15	±1.5	16.5
2.4G	802.11g Main (CH 1,CH11)/ 802.11g Aux (CH11)	12	±1.5	13.5
2.4G	802.11g Main (CH 2,CH10)/ 802.11n-40M(CH6)	14.5	±1.5	16.0
2.4G	802.11g Aux (CH 2)/ 802.11n-40M(CH9)	13.5	±1.5	15
2.4G	802.11n-20M(CH1)	14	±1.5	15.5
2.4G	802.11n-40M(CH3)	10	±1.5	11.5
5G	802.11a Main/Aux (CH40~CH44,CH56~60)	14.5	±1.5	16
5G	802.11a Main/Aux (CH48)	13.5	±1.5	15
5G	802.11a Main (CH64)	12	±1.5	13.5
5G	802.11a Aux (CH64)	11.5	±1.5	13
5G	802.11a Main/Aux (CH104~136,CH149~165)	15	±1.5	16.5
5G	802.11n-20M (CH40~44,CH56~60)/ 802.11n-40M (CH137)	14.5	±1.5	16
5G	802.11n-20M (CH48) / 802.11n-40M (CH46)	14	±1.5	15.5
5G	802.11n-20M (CH64)	13	±1.5	14.5
5G	802.11n-20M(CH104~165)/802.11n-40M(CH110~118,CH151~159)	15	±1.5	16.5
5G	802.11n-40M(CH38,54)	9.5	±1.5	11
5G	802.11n-40M(CH62)	10.5	±1.5	12
5G	802.11n-40M(CH134)	14.5	±1.5	16
5G	802.11ac-80M(CH42,CH106)	8	±1.5	9.5
5G	802.11ac-80M(CH58)	10	±1.5	11.5
5G	802.11ac-80M(CH122,138,155)	15	±1.5	16.5

1.4 SAR Test Exclusion Calculation

According 447498 D01, SAR is not required base on below:

Main Antenna	Tx	Frequency (MHz)	Output Power		Separation distances (mm)					<50mm ,Calcaued Threshold Value (≤3.0 SAR is not required)				
			dBm	mW	Back	Right	Left	Top	Bottom	Back	Right	Left	Top	Bottom
2.4G	WiFi	2412	16.50	45	18	217	43	182	6	3.9	>50mm	1.6	>50mm	11.6
5G	WiFi	5150	16.00	40	18	217	43	182	6	5.0	>50mm	2.1	>50mm	15.1
5G	WiFi	5280	16.00	40	18	217	43	182	6	5.1	>50mm	2.1	>50mm	15.2
5G	WiFi	5520	16.50	45	18	217	43	182	6	5.8	>50mm	2.4	>50mm	17.5
5G	WiFi	5745	16.50	45	18	217	43	182	6	5.9	>50mm	2.5	>50mm	17.8
Main Antenna	Tx	Frequency (MHz)	Output Power		Separation distances (mm)					>50mm ,Calcaued Threshold Value (SAR test exclusion power,mW)				
			dBm	mW	Back	Right	Left	Top	Bottom	Back	Right	Left	Top	Bottom
2.4G	WiFi	2412	16.50	45	18	217	43	182	6	<50mm	1766.6	<50mm	1416.6	<50mm
5G	WiFi	5150	16.00	40	18	217	43	182	6	<50mm	1736.1	<50mm	1386.1	<50mm
5G	WiFi	5280	16.00	40	18	217	43	182	6	<50mm	1735.3	<50mm	1385.3	<50mm
5G	WiFi	5520	16.50	45	18	217	43	182	6	<50mm	1733.8	<50mm	1383.8	<50mm
5G	WiFi	5745	16.50	45	18	217	43	182	6	<50mm	1732.6	<50mm	1382.6	<50mm
Aux Antenna	Tx	Frequency (MHz)	Output Power		Separation distances (mm)					<50mm ,Calcaued Threshold Value (≤3.0 SAR is not required)				
			dBm	mW	Back	Right	Left	Top	Bottom	Back	Right	Left	Top	Bottom
2.4G	WiFi	2412	16.50	45	18	217	27	6	183	3.9	>50mm	2.6	11.6	>50mm
5G	WiFi	5150	16.00	40	18	217	27	6	183	5.0	>50mm	3.3	15.1	>50mm
5G	WiFi	5280	16.00	40	18	217	27	6	183	5.1	>50mm	3.4	15.2	>50mm
5G	WiFi	5520	16.50	45	18	217	27	6	183	5.8	>50mm	3.9	17.5	>50mm
5G	WiFi	5745	16.50	45	18	217	27	6	183	5.9	>50mm	4.0	17.8	>50mm
Aux Antenna	Tx	Frequency (MHz)	Output Power		Separation distances (mm)					>50mm ,Calcaued Threshold Value (SAR test exclusion power,mW)				
			dBm	mW	Back	Right	Left	Top	Bottom	Back	Right	Left	Top	Bottom
2.4G	WiFi	2412	16.50	45	18	217	27	6	183	<50mm	1766.6	<50mm	<50mm	1426.6
5G	WiFi	5150	16.00	40	18	217	27	6	183	<50mm	1736.1	<50mm	<50mm	1396.1
5G	WiFi	5280	16.00	40	18	217	27	6	183	<50mm	1735.3	<50mm	<50mm	1395.3
5G	WiFi	5520	16.50	45	18	217	27	6	183	<50mm	1733.8	<50mm	<50mm	1393.8
5G	WiFi	5745	16.50	45	18	217	27	6	183	<50mm	1732.6	<50mm	<50mm	1392.6

1.5 Test Environment

Ambient conditions in the laboratory:

Test Date: Jan 27, 2015

Items	Required	Actual
Temperature (°C)	18-25	22.3± 2
Humidity (%RH)	30-70	52

Test Date: Jan 28, 2015

Items	Required	Actual
Temperature (°C)	18-25	22.1± 2
Humidity (%RH)	30-70	53

Site Description:

Accredited by TAF
 Accredited Number: 3023
 Effective through: December 12, 2017

Site Name: Quietek Corporation

Site Address: No.5-22, Ruishukeng, Linkou Dist.,
 New Taipei City 24451,
 Taiwan, R.O.C.
 TEL: 886-2-8601-3788 / FAX: 886-2-8601-3789
 E-Mail: service@quietek.com

2. SAR Measurement System

2.1 DASY5 System Description

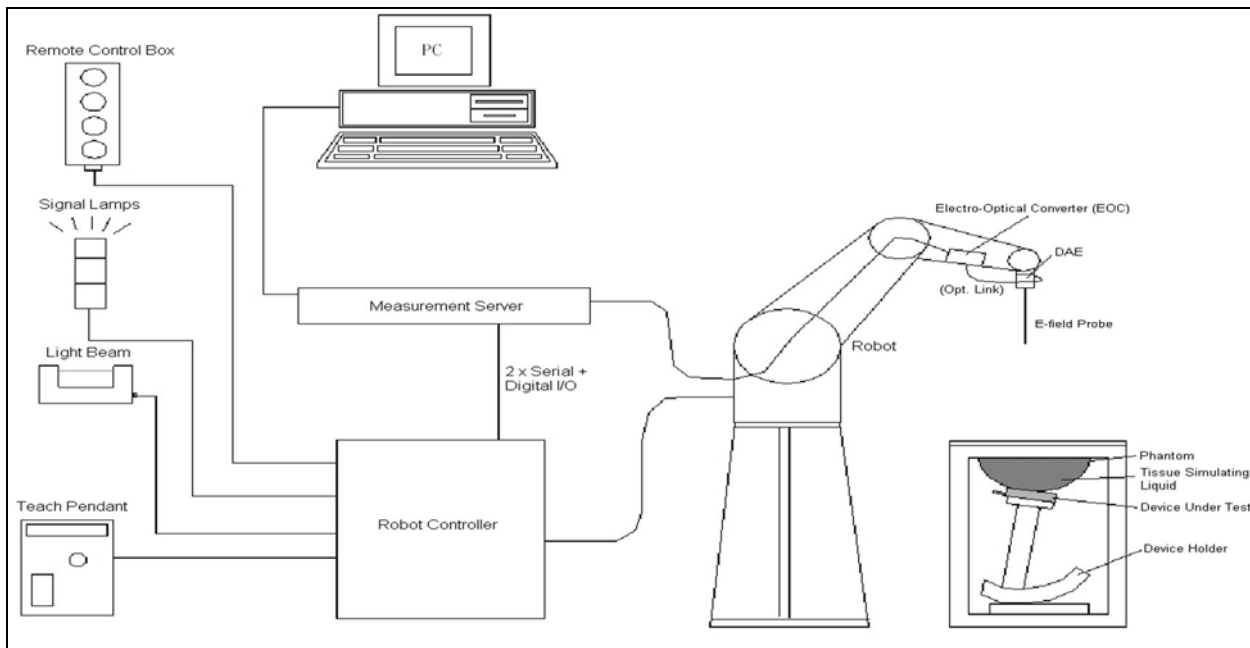

The DASY5 system for performing compliance tests consists of the following items:

- A standard high precision 6-axis robot with controller, teach pendant and software. An arm extension for accommodating the data acquisition electronics (DAE).
- A data acquisition electronics (DAE) which performs the signal amplification, signal multiplexing, AD-conversion, offset measurements, mechanical surface detection, collision detection, etc. The unit is battery powered with standard or rechargeable batteries. The signal is optically transmitted to the EOC.
- The Electro-optical converter (EOC) performs the conversion from optical to electrical signals for the digital communication to the DAE. To use optical surface detection, a special version of the EOC is required. The EOC signal is transmitted to the measurement server.
- The Light Beam used is for probe alignment. This improves the (absolute) accuracy of the probe positioning.
- A computer running WinXP and the DASY5 software.
- Remote control and teach pendant as well as additional circuitry for robot safety such as warning lamps, etc.
- The phantom, the device holder and other accessories according to the targeted measurement.

2.1.1 Applications

Predefined procedures and evaluations for automated compliance testing with all worldwide standards, e.g., IEEE 1528, OET 65, IEC 62209-1, IEC 62209-2, EN 50360, EN 50383 and others.

2.1.2 Area Scans

Area scans are defined prior to the measurement process being executed with a user defined variable spacing between each measurement point (integral) allowing low uncertainty measurements to be conducted. Scans defined for FCC applications utilize a 10mm² step integral, with 1mm interpolation used to locate the peak SAR area used for zoom scan assessments.

When an Area Scan has measured all reachable points, it computes the field maxima found in the scanned area, within a range of the global maximum. The range (in dB) is specified in the standards for compliance testing. For example, a 2 dB range is required in IEEE 1528-2003, EN 50361 and IEC 62209 standards, whereby 3 dB is a requirement when compliance is assessed in accordance with the ARIB standard (Japan).

2.1.3 Zoom Scan (Cube Scan Averaging)

Zoom Scans are used to assess the peak spatial SAR values within a cubic averaging volume containing 1 g and 10 g of simulated tissue. A density of 1000 kg/m³ is used to represent the head and body tissue density and not the phantom liquid density, in order to be consistent with the definition of the liquid dielectric properties, i.e. the side length of the 1 g cube is 10mm, with the side length of the 10 g cube 21,5mm.

The zoom scan integer steps can be user defined so as to reduce uncertainty, but normal practice for typical test applications (including FCC) utilize a physical step of 5x5x7 (8mmx8mmx5mm) providing a volume of 32mm in the X & Y axis, and 30mm in the Z axis.

2.1.4 Uncertainty of Inter-/Extrapolation and Averaging

In order to evaluate the uncertainty of the interpolation, extrapolation and averaged SAR calculation algorithms of the Postprocessor, DASY5 allows the generation of measurement grids which are artificially predefined by analytically based test functions. Therefore, the grids of area scans and zoom scans can be filled with uncertainty test data, according to the SAR benchmark functions of IEEE 1528. The three analytical functions shown in equations as below are used to describe the possible range of the expected SAR distributions for the tested handsets. The field gradients are covered by the spatially flat

distribution f1, the spatially steep distribution f3 and f2 accounts for H-field cancellation on the phantom/tissue surface.

$$f_1(x, y, z) = Ae^{-\frac{z}{2a}} \cos^2 \left(\frac{\pi \sqrt{x'^2 + y'^2}}{2 \cdot 5a} \right)$$

$$f_2(x, y, z) = Ae^{-\frac{z}{a}} \frac{a^2}{a^2 + x'^2} \left(3 - e^{-\frac{2z}{a}} \right) \cos^2 \left(\frac{\pi y'}{2 \cdot 3a} \right)$$

$$f_3(x, y, z) = A \frac{a^2}{\frac{a^2}{4} + x'^2 + y'^2} \left(e^{-\frac{2z}{a}} + \frac{a^2}{2(a + 2z)^2} \right)$$

2.2 DASY5 E-Field Probe

The SAR measurement is conducted with the dosimetric probe manufactured by SPEAG. The probe is specially designed and calibrated for use in liquid with high permittivity. The dosimetric probe has special calibration in liquid at different frequency. SPEAG conducts the probe calibration in compliance with international and national standards (e.g. IEEE 1528, EN 62209-1, IEC 62209, etc.) under ISO 17025. The calibration data are in Appendix D.

2.2.1 Isotropic E-Field Probe Specification

Model	Ex3DV4	
Construction	Symmetrical design with triangular core Built-in shielding against static charges PEEK enclosure material (resistant to organic solvents, e.g., DGBE)	
Frequency	10 MHz to 6 GHz Linearity: ± 0.2 dB (30 MHz to 6 GHz)	
Directivity	± 0.3 dB in HSL (rotation around probe axis) ± 0.5 dB in tissue material (rotation normal to probe axis)	
Dynamic Range	10 µW/g to 100 mW/g Linearity: ± 0.2 dB (noise: typically < 1 µW/g)	
Dimensions	Overall length: 330 mm (Tip: 20 mm) Tip diameter: 2.5 mm (Body: 12 mm) Typical distance from probe tip to dipole centers: 1 mm	
Application	High precision dosimetric measurements in any exposure scenario (e.g., very strong gradient fields). Only probe which enables compliance testing for frequencies up to 6 GHz with precision of better 30%.	

2.3 Boundary Detection Unit and Probe Mounting Device

The DASY probes use a precise connector and an additional holder for the probe, consisting of a plastic tube and a flexible silicon ring to center the probe. The connector at the DAE is flexibly mounted and held in the default position with magnets and springs. Two switching systems in the connector mount detect frontal and lateral probe collisions and trigger the necessary software response.



2.4 DATA Acquisition Electronics (DAE) and Measurement Server

The data acquisition electronics (DAE) consists of a highly sensitive electrometer-grade preamplifier with auto-zeroing, a channel and gain-switching multiplexer, a fast 16 bit AD-converter and a command decoder and control logic unit.

Transmission to the measurement server is accomplished through an optical downlink for data and status information as well as an optical uplink for commands and the clock.

The input impedance of the DAE4 is 200M Ohm; the inputs are symmetrical and floating. Common mode rejection is above 80dB.



The DASY5 measurement server is based on a PC/104 CPU board with a 400MHz intel ULV Celeron, 128MB chipdisk and 128MB RAM. The necessary circuits for communication with the DAE electronics box, as well as the 16 bit AD converter system for optical detection and digital I/O interface are contained on the DASY5 I/O board, which is directly connected to the PC/104 bus of the CPU board.



2.5 Robot

The DASY5 system uses the high precision robots TX90 XL type out of the newer series from Stäubli SA (France). For the 6-axis controller DASY5 system, the CS8C robot controller version from Stäubli is used.

The XL robot series have many features that are important for our application:

- High precision (repeatability 0.02 mm)
- High reliability (industrial design)
- Jerk-free straight movements
- Low ELF interference (the closed metallic construction shields against motor control fields)
- 6-axis controller



2.6 Light Beam Unit

The light beam switch allows automatic "tooling" of the probe. During the process, the actual position of the probe tip with respect to the robot arm is measured, as well as the probe length and the horizontal probe offset. The software then corrects all movements, such that the robot coordinates are valid for the probe tip.

The repeatability of this process is better than 0.1 mm. If a position has been taught with an aligned probe, the same position will be reached with another aligned probe within 0.1 mm, even if the other probe has different dimensions. During probe rotations, the probe tip will keep its actual position.



2.7 Device Holder

The DASY5 device holder is designed to cope with different positions given in the standard. It has two scales for the device rotation (with respect to the body axis) and the device inclination (with respect to the line between the ear reference points). The rotation center for both scales is the ear reference point (EPR).

Thus the device needs no repositioning when changing the angles.

The DASY5 device holder has been made out of low-loss POM material having the following dielectric parameters: relative permittivity $\epsilon_r = 3$ and loss tangent $\delta = 0.02$. The amount of dielectric material has been reduced in the closest vicinity of the device, since measurements have suggested that the influence of the clamp on the test results could thus be lowered.



2.8 SAM Twin Phantom

The SAM twin phantom is a fiberglass shell phantom with 2mm shell thickness (except the ear region where shell thickness increases to 6mm). It has three measurement areas:

- Left head
- Right head
- Flat phantom



The bottom plate contains three pair of bolts for locking the device holder. The device holder positions are adjusted to the standard measurement positions in the three sections. A white cover is provided to tap the phantom during off-periods to prevent water evaporation and changes in the liquid parameters. On the phantom top, three reference markers are provided to identify the phantom position with respect to the robot.

3. Tissue Simulating Liquid

3.1 The composition of the tissue simulating liquid

INGREDIENT (% Weight)	2450MHz Head	2450MHz Body	5200MHz Body	5800MHz Body
Water	46.7	73.2	76	75.68
Salt	0.00	0.04	0.00	0.43
Sugar	0.00	0.00	0.00	0.00
HEC	0.00	0.00	0.00	0.00
Preventol	0.00	0.00	0.00	0.00
DGBE	53.3	26.7	4.44	4.42

3.2 Tissue Calibration Result

The dielectric parameters of the liquids were verified prior to the SAR evaluation using APREL Dielectric Probe Kit and Agilent E5071C Vector Network Analyzer.

Body Tissue Simulate Measurement				
Frequency [MHz]	Description	Dielectric Parameters		Tissue Temp. [°C]
		ϵ_r	σ [s/m]	
2450 MHz	Reference result ± 5% window	52.7 50.065 to 55.335	1.95 1.8525 to 2.0475	N/A
	28-Jan-15	53.06	1.92	20.4
2412 MHz	Low channel	53.22	1.87	20.4
2437 MHz	Mid channel	53.11	1.90	20.4
2462 MHz	High channel	52.99	1.95	20.4

Body Tissue Simulate Measurement				
Frequency [MHz]	Description	Dielectric Parameters		Tissue Temp. [°C]
		ϵ_r	σ [s/m]	
5200MHz	Reference result ± 5% window	49 46.55 to 51.45	5.3 5.03 to 5.56	N/A
	27-Jan-15	49.5	5.34	20.5
5220 MHz	Low channel	49.45	5.37	20.5
5240 MHz	Mid channel	49.39	5.41	20.5
5280 MHz	High channel	49.27	5.49	20.5

Body Tissue Simulate Measurement				
Frequency [MHz]	Description	Dielectric Parameters		Tissue Temp. [°C]
		ϵ_r	σ [s/m]	
5300MHz	Reference result ± 5% window	48.9 46.45 to 51.34	5.42 5.15 to 5.69	N/A
	27-Jan-15	49.24	5.50	20.5
5320 MHz	Low channel	49.18	5.53	20.5

Body Tissue Simulate Measurement				
Frequency [MHz]	Description	Dielectric Parameters		Tissue Temp. [°C]
		ϵ_r	σ [s/m]	
5600MHz	Reference result ± 5% window	48.5 46.07 to 50.92	5.77 5.48 to 6.06	N/A
	27-Jan-15	48.39	5.87	20.5
5520 MHz	Low channel	48.60	5.75	20.5
5580 MHz	Mid channel	48.38	5.83	20.5
5680 MHz	High channel	48.14	5.99	20.5

Body Tissue Simulate Measurement				
Frequency [MHz]	Description	Dielectric Parameters		Tissue Temp. [°C]
		ϵ_r	σ [s/m]	
5800MHz	Reference result ± 5% window	48.2 45.79 to 50.61	6 5.7 to 6.3	N/A
	27-Jan-15	47.89	6.26	20.5
5745 MHz	Low channel	48.02	6.19	20.5
5785 MHz	Mid channel	47.92	6.24	20.5
5825 MHz	High channel	47.82	6.30	20.5

3.3 Tissue Dielectric Parameters for Head and Body Phantoms

The head tissue dielectric parameters recommended by the IEEE SCC-34/SC-2 in P1528 have been incorporated in the following table. These head parameters are derived from planar layer models simulating the highest expected SAR for the dielectric properties and tissue thickness variations in a human head. Other head and body tissue parameters that have not been specified in P1528 are derived from the tissue dielectric parameters computed from the 4-Cole-Cole equations described in Reference [12] and extrapolated according to the head parameters specified in P1528.

Target Frequency (MHz)	Head		Body	
	ϵ_r	σ (S/m)	ϵ_r	σ (S/m)
150	52.3	0.76	61.9	0.80
300	45.3	0.87	58.2	0.92
450	43.5	0.87	56.7	0.94
835	41.5	0.90	55.2	0.97
900	41.5	0.97	55.0	1.05
915	41.5	0.98	55.0	1.06
1450	40.5	1.20	54.0	1.30
1610	40.3	1.29	53.8	1.40
1800 – 2000	40.0	1.40	53.3	1.52
2450	39.2	1.80	52.7	1.95
3000	38.5	2.40	52.0	2.73
5800	35.3	5.27	48.2	6.00

(ϵ_r = relative permittivity, σ = conductivity and $\rho = 1000 \text{ kg/m}^3$)

4. SAR Measurement Procedure

4.1 SAR System Check

4.1.1 Dipoles

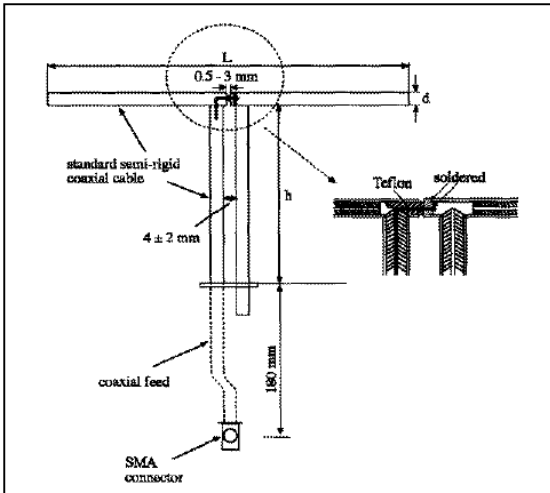

The dipoles used is based on the IEEE-1528 standard, and is complied with mechanical and electrical specifications in line with the requirements of both IEEE and FCC Supplement C. the table below provides details for the mechanical and electrical specifications for the dipoles.

Frequency	L (mm)	h (mm)	d (mm)
2450MHz	53.5	30.4	3.6
5200M~5800MHz	20.6	45.4	3.6

4.1.2 System Check Result

System Performance Check at 2450MHz				
Dipole Kit: ALS-D-2450				
Frequency [MHz]	Description	SAR [w/kg] 1g	SAR [w/kg] 10g	Tissue Temp. [°C]
2450 MHz	Reference result ± 10% window	50.4 445.36 to 55.44	23.44 21.1 to 25.78	N/A
	28-Jan-15	50	22.98	20.4

Note: (1) The power level is used 250mW
 (2) All SAR values are normalized to 1W forward power.
 (3) The reference result is from Appendix E.

System Performance Check at 5200MHz				
Dipole Kit: D5GHzV2				
Frequency [MHz]	Description	SAR [w/kg] 1g	SAR [w/kg] 10g	Tissue Temp. [°C]
5200 MHz	Reference result ± 10% window	74 66.6 to 81.4	20.7 18.63 to 22.77	N/A
	27-Jan-15	81.1	22.6	20.5
Note: (1) The power level is used 100mW (2) All SAR values are normalized to 1W forward power. (3) The reference result is from Appendix E.				

System Performance Check at 5300MHz				
Dipole Kit: D5GHzV2				
Frequency [MHz]	Description	SAR [w/kg] 1g	SAR [w/kg] 10g	Tissue Temp. [°C]
5300 MHz	Reference result ± 10% window	75.3 67.77 to 82.83	21.1 18.99 to 23.21	N/A
	27-Jan-15	82.7	22.9	20.5
Note: (1) The power level is used 100mW (2) All SAR values are normalized to 1W forward power. (3) The reference result is from Appendix E.				

System Performance Check at 5600MHz				
Dipole Kit: D5GHzV2				
Frequency [MHz]	Description	SAR [w/kg] 1g	SAR [w/kg] 10g	Tissue Temp. [°C]
5600 MHz	Reference result ± 10% window	79.4 71.46 to 87.34	22 19.8 to 24.2	N/A
	27-Jan-15	84.2	23.5	20.5
Note: (1) The power level is used 100mW (2) All SAR values are normalized to 1W forward power. (3) The reference result is from Appendix E.				

System Performance Check at 5800MHz				
Dipole Kit: D5GHzV2				
Frequency [MHz]	Description	SAR [w/kg] 1g	SAR [w/kg] 10g	Tissue Temp. [°C]
5800 MHz	Reference result ± 10% window	73.8 66.42 to 81.18	20.4 18.36 to 22.44	N/A
	27-Jan-15	80	22.1	20.5
Note: (1) The power level is used 100mW (2) All SAR values are normalized to 1W forward power. (3) The reference result is from Appendix E.				

4.2 SAR Measurement Procedure

The Dasy5 calculates SAR using the following equation,

$$SAR = \frac{\sigma |E|^2}{\rho}$$

- σ: represents the simulated tissue conductivity
- ρ: represents the tissue density

The EUT is set to transmit at the required power in line with product specification, at each frequency relating to the LOW, MID, and HIGH channel settings.

Pre-scans are made on the device to establish the location for the transmitting antenna, using a large area scan in either air or tissue simulation fluid.

The EUT is placed against the Universal Phantom where the maximum area scan dimensions are larger than the physical size of the resonating antenna. When the scan size is not large enough to cover the peak SAR distribution, it is modified by either extending the area scan size in both the X and Y directions, or the device is shifted within the predefined area.

The area scan is then run to establish the peak SAR location (interpolated resolution set at 1mm²) which is then used to orient the center of the zoom scan. The zoom scan is then executed and the 1g and 10g averages are derived from the zoom scan volume (interpolated resolution set at 1mm³).

5. SAR Exposure Limits

SAR assessments have been made in line with the requirements of IEEE-1528, FCC Supplement C, and comply with ANSI/IEEE C95.1-1992 “Uncontrolled Environments” limits. These limits apply to a location which is deemed as “Uncontrolled Environment” which can be described as a situation where the general public may be exposed to an RF source with no prior knowledge or control over their exposure.

Limits for General Population/Uncontrolled Exposure (W/kg)

Type Exposure	Uncontrolled Environment Limit
Spatial Peak SAR (1g cube tissue for brain or body)	1.60 W/kg
Spatial Average SAR (whole body)	0.08 W/kg
Spatial Peak SAR (10g for hands, feet, ankles and wrist)	4.00 W/kg

6. Test Equipment List

Instrument	Manufacturer	Model No.	Serial No.	Last Calibration	Next Calibration
Stäubli Robot TX60L	Stäubli	TX60L	F09/5BL1A1/A06	2009/05/18	only once
Controller	Speag	CS8c	N/A	2009/05/18	only once
Aprél Reference Dipole 2450MHz	Aprél	ALS-D-2450	QTK-319	2014/07/24	2016/07/23
Speag Reference Dipole 5GHz	Speag	D5GHzV2	1041	2013/05/31	2015/05/30
SAM Twin Phantom	Speag	QD000 P40 CA	Tp 1515	N/A	N/A
Device Holder	Speag	N/A	N/A	N/A	N/A
Data Acquisition Electronic	Speag	DAE4	1207	2014/05/19	2015/05/18
Data Acquisition Electronic	Speag	DAE4	1425	2014/11/13	2015/11/12
E-Field Probe	Speag	EX3DV4	3698	2014/07/25	2015/07/24
E-Field Probe	Speag	EX3DV4	3979	2014/11/21	2015/11/20
SAR Software	Speag	DASY52	V52.8 (8)	N/A	N/A
Aprél Dipole Spaccer	Aprél	ALS-DS-U	QTK-295	N/A	N/A
Power Amplifier	Mini-Circuit	ZHL-42	D051404-20	N/A	N/A
Directional Coupler	Agilent	778D-012	50550	N/A	N/A
Universal Radio Communication Tester	R&S	CMU 200	104846	2014/05/05	2015/05/04
Vector Network	Agilent	E5071C	MY46108013	2014/03/09	2015/03/08
Signal Generator	Anritsu	MG3694A	041902	2014/08/06	2015/08/05
Power Meter	Anritsu	ML2495A	143004	2014/09/05	2015/09/04
Wide Bandwidth Sensor	Anritsu	MA2411B	1339194	2014/09/12	2015/09/11

7. Measurement Uncertainty

DASY5 Uncertainty (According to IEC 62209-2/2010)								
Measurement uncertainty for 30 MHz to 6 GHz averaged over 1 gram / 10 gram.								
Error Description	Uncert. value	Prob. Dist.	Div.	(ci) 1g	(ci) 10g	Std. Unc. (1g)	Std. Unc. (10g)	(vi) V _{eff}
Measurement System								
Probe Calibration	±6.55%	N	1	1	1	±6.55%	±6.55%	∞
Axial Isotropy	±4.7%	R	$\sqrt{3}$	0.7	0.7	±1.9%	±1.9%	∞
Hemispherical Isotropy	±9.6%	R	$\sqrt{3}$	0.7	0.7	±3.9%	±3.9%	∞
Boundary Effects	±2.0%	R	$\sqrt{3}$	1	1	±1.2%	±1.2%	∞
Linearity	±4.7%	R	$\sqrt{3}$	1	1	±2.7%	±2.7%	∞
Modulation Response	±2.4%	R	$\sqrt{3}$	1	1	±1.4%	±1.4%	∞
System Detection Limits	±1.0%	R	$\sqrt{3}$	1	1	±0.6%	±0.6%	∞
Readout Electronics	±0.3%	N	1	1	1	±0.3%	±0.3%	∞
Response Time	±0.8%	R	$\sqrt{3}$	1	1	±0.5%	±0.5%	∞
Integration Time	±2.6%	R	$\sqrt{3}$	1	1	±1.5%	±1.5%	∞
RF Ambient Noise	±3.0%	R	$\sqrt{3}$	1	1	±1.7%	±1.7%	∞
RF Ambient Reflections	±3.0%	R	$\sqrt{3}$	1	1	±1.7%	±1.7%	∞
Probe Positioner	±0.8%	R	$\sqrt{3}$	1	1	±0.5%	±0.5%	∞
Probe Positioning	±6.7%	R	$\sqrt{3}$	1	1	±3.9%	±3.9%	∞
Post-processing	±4.0%	R	$\sqrt{3}$	1	1	±2.3%	±2.3%	∞
Test Sample Related								
Device Positioning	±2.9%	N	1	1	1	±2.9%	±2.9%	145
Device Holder	±3.6%	N	1	1	1	±3.6%	±3.6%	5
Power Scaling	±0%	R	$\sqrt{3}$	1	1	±0.0%	±0.0%	
Power Drift	±5.0%	R	$\sqrt{3}$	1	1	±2.9%	±2.9%	∞
Phantom and Setup								
Phantom Uncertainty	±7.9%	R	$\sqrt{3}$	1	1	±4.6%	±4.6%	∞
SAR correction	±1.9%	R	$\sqrt{3}$	1	0.84	±1.1%	±1.1%	∞
Liquid Conductivity (meas.)	±2.5%	N	1	0.78	0.71	±1.1%	±1.0%	∞
Liquid Permittivity (meas.)	±2.5%	N	1	0.26	0.26	±0.3%	±0.4%	∞
Temp. unc. - Conductivity	±3.4%	R	$\sqrt{3}$	0.78	0.71	±1.5%	±1.4%	∞
Temp. unc. - Permittivity	±0.4%	R	$\sqrt{3}$	0.23	0.26	±0.1%	±0.1%	∞
Combined Std. Uncertainty						±12.5%	±12.5%	748
Expanded STD Uncertainty						±25.1%	±25.1%	

8. Conducted Power Measurement

BT :

Mode	Frequency (MHz)	Channel	1Mbps	3Mbps	Frequency (MHz)	Channel	BLE
BT	2402	00	3.12	2.28	2402	00	8.69
BT	2441	39	3.28	2.36	2440	39	8.84
BT	2480	78	3.19	2.37	2480	78	8.82

WLAN :

Mode	Frequency (MHz)	Channel	Main (TX1) Average Power(dBm)	Aux (TX2) Average Power(dBm)
802.11b	2412	1	15.50	14.00
802.11b	2437	6	15.45	13.98
802.11b	2462	11	15.35	13.97
802.11g	2412	1	13.38	12.00
802.11g	2417	2	16.00	15.00
802.11g	2437	6	16.05	14.98
802.11g	2457	10	15.80	15.50
802.11g	2462	11	13.39	13.42
802.11a	5200	40	16.00	16.00
802.11a	5220	44	15.99	16.00
802.11a	5240	48	15.00	14.8
802.11a	5280	56	16.00	15.98
802.11a	5300	60	15.97	15.78
802.11a	5320	64	13.33	13.00
802.11a	5520	104	16.00	16.50
802.11a	5580	116	15.60	16.48
802.11a	5680	136	15.99	16.49
802.11a	5745	149	16.18	16.50
802.11a	5785	157	15.97	16.39
802.11a	5825	165	15.84	16.25

Mode	Frequency (MHz)	Channel	Main (TX1) Average Power(dBm)	Aux (TX2) Average Power(dBm)	Main (TX1)+ Aux (TX2) Average Power(dBm)
802.11n-20M	2412	1	12.09	12.50	15.31
802.11n-20M	2437	6	13.50	13.50	16.50
802.11n-20M	2462	11	13.26	13.50	16.39
802.11n-20M	5200	40	12.75	12.28	15.53
802.11n-20M	5220	44	12.71	13.00	15.87
802.11n-20M	5240	48	12.13	12.50	15.33
802.11n-20M	5280	56	12.84	12.49	15.68
802.11n-20M	5300	60	13.00	12.53	15.78
802.11n-20M	5320	64	11.25	10.75	14.02
802.11n-20M	5520	104	13.28	13.48	16.39
802.11n-20M	5580	116	13.37	13.50	16.45
802.11n-20M	5680	136	13.44	13.50	16.48
802.11n-20M	5745	149	12.86	13.42	16.16
802.11n-20M	5785	157	13.06	13.50	16.30
802.11n-20M	5825	165	12.65	13.48	16.10
802.11n-40M	2422	3	8.28	8.50	11.40
802.11n-40M	2437	6	12.88	13.00	15.95
802.11n-40M	2452	9	12.00	12.00	15.00
802.11n-40M	5190	38	7.47	7.85	10.67
802.11n-40M	5230	46	12.48	11.68	15.11
802.11n-40M	5270	54	8.00	7.59	10.81
802.11n-40M	5310	62	8.91	8.80	11.87
802.11n-40M	5550	110	13.50	13.45	16.49
802.11n-40M	5590	118	11.72	13.43	15.67
802.11n-40M	5670	134	12.87	13.00	15.95
802.11n-40M	5755	151	13.01	13.50	16.27
802.11n-40M	5795	159	12.91	13.50	16.23
802.11ac-80M	5210	42	6.05	6.32	9.20
802.11ac-80M	5290	58	8.45	8.48	11.48
802.11ac-80M	5530	106	6.19	6.50	9.36
802.11ac-80M	5610	122	13.27	13.48	16.39
802.11ac-80M	5690	138	11.97	13.50	15.81
802.11ac-80M	5775	155	12.90	13.50	16.22

9. Test Results

9.1 SAR Test Results Summary

SAR MEASUREMENT								
Ambient Temperature (°C) : 22.3 ±2					Relative Humidity (%) : 52			
Liquid Temperature (°C) : 20.4 ±2					Depth of Liquid (cm) : >15			
Test Mode: 802.11b - 2450 MHz (TX1)								
Test Position Body	Antenna Position	Frequency		Conducted Power (dBm)		SAR 1g (W/kg)		Limit (W/kg)
		Channel	MHz	Measurement	Tune-up Limit	Measurement	Tune-up Scaled	
Bottom	Fixed	1	2412	15.50	15.50	0.160	0.160	1.6
Test Mode: 802.11b - 2450 MHz (TX2)								
Top	Fixed	1	2412	13.98	14.00	0.115	0.116	1.6
Test Mode: 802.11g - 2450 MHz (TX1)								
Bottom	Fixed	2	2417	16.00	16.00	0.162	0.162	1.6
Bottom	Fixed	6	2437	16.05	16.50	0.180	0.200	1.6
Bottom	Fixed	10	2457	15.80	16.00	0.182	0.191	1.6
Back	Fixed	6	2437	16.05	16.50	0.065	0.072	1.6
Left-Side	Fixed	6	2437	16.05	16.50	0.033	0.037	1.6
Test Mode: 802.11g - 2450 MHz (TX2)								
Top	Fixed	6	2437	15.26	15.50	0.172	0.182	1.6
Back	Fixed	6	2437	15.26	15.50	0.157	0.166	1.6
Left-Side	Fixed	6	2437	15.26	15.50	0.054	0.057	1.6
Test Mode: 802.11n (20M)- 2450 MHz (TX1)								
Bottom	Fixed	6	2437	13.50	13.50	0.060	0.060	1.6
Test Mode: 802.11n (20M)- 2450 MHz (TX2)								
Top	Fixed	6	2437	13.50	13.50	0.105	0.105	1.6
Test Mode: 802.11n (40M)- 2450 MHz (TX1)								
Bottom	Fixed	6	2437	12.88	13.00	0.086	0.088	1.6
Test Mode: 802.11n (40M)- 2450 MHz (TX2)								
Top	Fixed	6	2437	13.00	13.00	0.121	0.121	1.6
Note : 1. According KDB 447498 D01, SAR can be excluded when test exclusion thresholds are applicable.(can refer P6) 2. When output power reduction is necessary for channels 1/11 to meet restricted band requirements the highest output channels closest to each of these channels must be test instead.								

SAR MEASUREMENT								
Ambient Temperature (°C) : 22.1 ±2				Relative Humidity (%) : 53				
Liquid Temperature (°C) : 20.5 ±2				Depth of Liquid (cm) : >15				
Test Mode: 802.11a - 5 GHz (TX1)								
Test Position Body	Antenna Position	Frequency		Conducted Power (dBm)		SAR 1g (W/kg)		Limit (W/kg)
		Channel	MHz	Measurement	Tune-up Limit	Measurement	Tune-up Scaled	
Back	Fixed	149	5745	16.18	16.50	0.078	0.084	1.6
Left-Side	Fixed	149	5745	16.18	16.50	0.089	0.096	1.6
Bottom	Fixed	40	5200	16.00	16.00	0.537	0.537	1.6
Bottom	Fixed	44	5220	15.99	16.00	0.465	0.466	1.6
Bottom	Fixed	48	5240	15.00	15.00	0.464	0.464	1.6
Bottom	Fixed	56	5280	16.00	16.00	0.463	0.463	1.6
Bottom	Fixed	60	5300	15.97	16.00	0.503	0.506	1.6
Bottom	Fixed	64	5320	13.33	13.50	0.440	0.458	1.6
Bottom	Fixed	104	5520	16.00	16.50	0.358	0.402	1.6
Bottom	Fixed	116	5580	15.60	16.50	0.337	0.415	1.6
Bottom	Fixed	136	5680	15.99	16.50	0.573	0.644	1.6
Bottom	Fixed	149	5745	16.18	16.50	0.478	0.515	1.6
Bottom	Fixed	159	5785	15.97	16.50	0.489	0.552	1.6
Bottom	Fixed	165	5825	15.84	16.50	0.471	0.548	1.6
Test Mode: 802.11a - 5 GHz (TX2)								
Top	Fixed	149	5745	16.50	16.50	0.406	0.406	1.6
Back	Fixed	149	5745	16.50	16.50	0.442	0.442	1.6
Left-Side	Fixed	149	5745	16.50	16.50	0.00581	0.00581	1.6
Test Mode: 802.11n (20M)- 2450 MHz (TX1)								
Bottom	Fixed	136	5680	13.44	13.50	0.240	0.243	1.6
Test Mode: 802.11n (20M)- 2450 MHz (TX2)								
Back	Fixed	136	5680	13.50	13.50	0.259	0.259	1.6
Test Mode: 802.11n (40M)- 2450 MHz (TX1)								
Bottom	Fixed	110	5550	13.50	13.50	0.182	0.182	1.6
Test Mode: 802.11n (40M)- 2450 MHz (TX2)								
Back	Fixed	110	5550	13.45	13.50	0.189	0.191	1.6
Test Mode: 802.11ac (80M)- 2450 MHz (TX1)								
Bottom	Fixed	122	5610	13.27	13.50	0.224	0.236	1.6
Test Mode: 802.11ac (80M)- 2450 MHz (TX2)								
Back	Fixed	122	5610	13.48	13.50	0.184	0.185	1.6
Note : 1. According KDB 447498 D01, SAR can be excluded when test exclusion thresholds are applicable.(can refer P6)								

9.2 Simultaneous Transmission

According the KDB 447498 D01 Section 4.3.2, the standalone SAR must be estimated according to the following to determine simultaneous transmission SAR test exclusion

$$(max. power of channel, mW)/(min. test separation distance, mm)] \cdot [\sqrt{f(GHz)}/7.5]$$

Frequency	Max. power (dBm)	Test separation distance ,(mm)	Estimated BT SAR (W/Kg)
2441	8.82	6	0.31

For UNII Band :

WLAN SAR (W/Kg)	BT SAR (W/Kg)	Simultaneous Transmission (W/Kg)	Antenna pair in mm	Peak location separation ratio
0.552	0.31	0.862	N/A	N/A

The sum of value is less than 1.6W/Kg, thus simultaneous SAR testing is no need.

For DTS Band :

WLAN SAR (W/Kg)	Estimated BT SAR (W/Kg)	Simultaneous Transmission (W/Kg)	Antenna pair in mm	Peak location separation ratio
0.537	0.31	0.847	N/A	N/A

The sum of value is less than 1.6W/Kg, thus simultaneous SAR testing is no need.

10. SAR measurement variability

- 1) Repeated measurement is not required when the original highest measured SAR is < 0.80 W/kg; steps 2) through 4) do not apply.
- 2) When the original highest measured SAR is ≥ 0.80 W/kg, repeat that measurement once.
- 3) Perform a second repeated measurement only if the ratio of largest to smallest SAR for the original and first repeated measurements is > 1.20 or when the original or repeated measurement is ≥ 1.45 W/kg (~ 10% from the 1-g SAR limit).
- 4) Perform a third repeated measurement only if the original, first or second repeated measurement is ≥ 1.5 W/kg and the ratio of largest to smallest SAR for the original, first and second repeated measurements is > 1.20.

Frequency		SAR 1g (W/kg)						
Channel	MHz	Original	First Repeated		Second Repeated		Third Repeated	
			Value	Ratio	Value	Ratio	Value	Ratio
N/A	N/A	N/A	N/A	N/A	N/A	N/A	N/A	N/A
N/A	N/A	N/A	N/A	N/A	N/A	N/A	N/A	N/A

Appendix**Appendix A. SAR System Check Data****Appendix B. SAR measurement Data****Appendix C. Test Setup Photographs & EUT Photographs****Appendix D. Probe Calibration Data****Appendix E. Dipole Calibration Data**

Appendix A. SAR System Check Data

Test Laboratory: QuieTek

Date/Time: 2015/1/28

System Performance Check_2450MHz-Body

DUT: Dipole 2450 MHz; Type: ALS-D-2450

Communication System: UID 10000, CW; Frequency: 2450 MHz;

Communication System PAR: 0 dB

Medium parameters used: $f = 2450$ MHz; $\sigma = 1.92$ S/m; $\epsilon_r = 53.06$; $\rho = 1000$ kg/m³

Phantom section: Flat Section

Ambient Temperature (°C) : 22.3, Liquid Temperature (°C) : 20.4

Measurement Standard: DASY5 (IEEE/IEC/ANSI C63.19-2007)

DASY5 Configuration:

- Probe: EX3DV4 - SN3979; ConvF(7.08, 7.08, 7.08); Calibrated: 2014/11/21;
- Sensor-Surface: 3mm (Mechanical Surface Detection)
- Electronics: DAE4 Sn1425; Calibrated: 2014/11/13
- Phantom: SAM with right table; Type: SAM;
- Measurement SW: DASY52, Version 52.8 (8); SEMCAD X Version 14.6.10 (7331)

Configuration/2450MHz_Body/Area Scan (8x9x1): Measurement grid: dx=12mm, dy=12mm

Maximum value of SAR (measured) = 16.4 W/kg

Configuration/2450MHz_Body/Zoom Scan (7x7x7) (7x7x7)/Cube 0:

Measurement grid: dx=5mm, dy=5mm, dz=5mm

Reference Value = 91.12 V/m; Power Drift = -0.01 dB

Peak SAR (extrapolated) = 26.3 W/kg

SAR(1 g) = 12.5 W/kg; SAR(10 g) = 5.77 W/kg

Maximum value of SAR (measured) = 16.5 W/kg

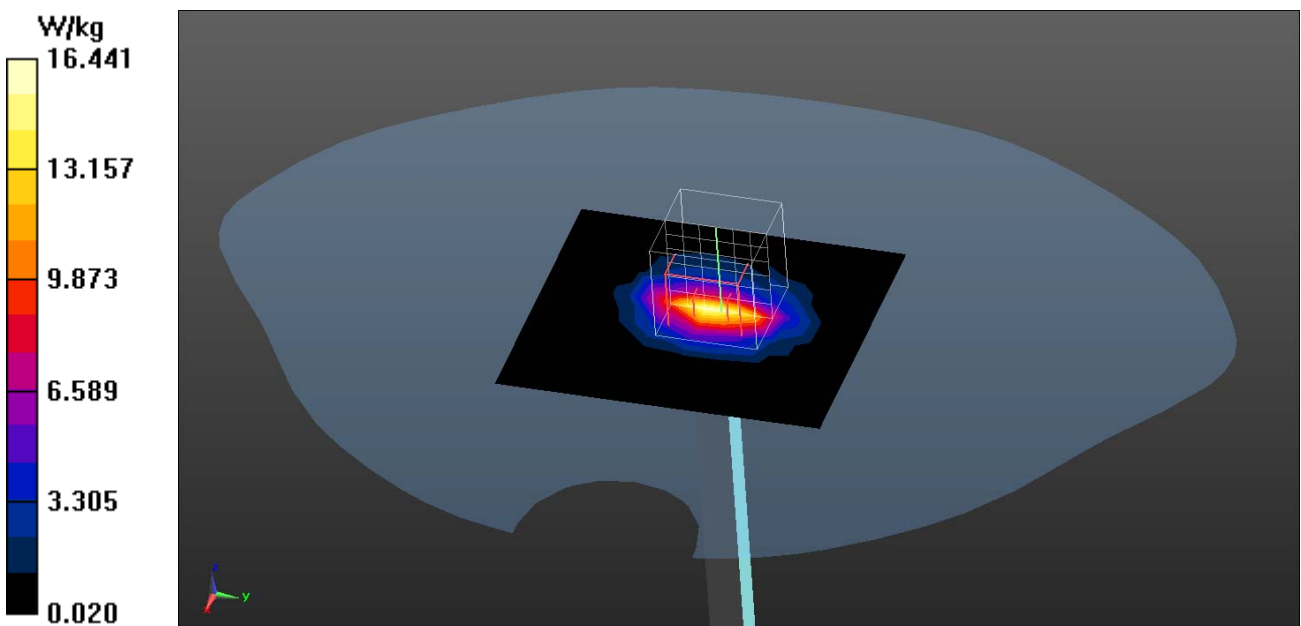

Test Laboratory: QuieTek

Date/Time: 2015/1/27

System Performance Check_5200MHz-Body

DUT: Dipole 5GHz; Type: D5GHzV2

Communication System: UID 0, WLAN 5G; Frequency: 5200 MHz;

Communication System PAR: 0 dB

Medium parameters used: $f = 5200$ MHz; $\sigma = 5.34$ S/m; $\epsilon_r = 49.5$; $\rho = 1000$ kg/m³

Phantom section: Flat Section

Ambient Temperature (°C) : 22.1, Liquid Temperature (°C) : 20.5

Measurement Standard: DASYS (IEEE/IEC/ANSI C63.19-2007)

DASY5 Configuration:

- Probe: EX3DV4 - SN3698; ConvF(4.23, 4.23, 4.23); Calibrated: 2014/7/25;
- Sensor-Surface: 2mm (Mechanical Surface Detection)
- Electronics: DAE4 Sn1207; Calibrated: 2014/5/19
- Phantom: SAM with left table; Type: SAM;
- Measurement SW: DASYS2, Version 52.8 (8); SEMCAD X Version 14.6.10 (7331)

Configuration/5200MHz-Body 100mW/Area Scan (8x8x1): Measurement grid:

$dx=10$ mm, $dy=10$ mm

Maximum value of SAR (measured) = 16.8 W/kg

Configuration/5200MHz-Body 100mW/Zoom Scan (7x7x12), dist=2mm

(7x7x12)/Cube 0: Measurement grid: $dx=4$ mm, $dy=4$ mm, $dz=2$ mm

Reference Value = 65.06 V/m; Power Drift = 0.09 dB

Peak SAR (extrapolated) = 33.0 W/kg

SAR(1 g) = 8.11 W/kg; SAR(10 g) = 2.26 W/kg

Maximum value of SAR (measured) = 19.7 W/kg

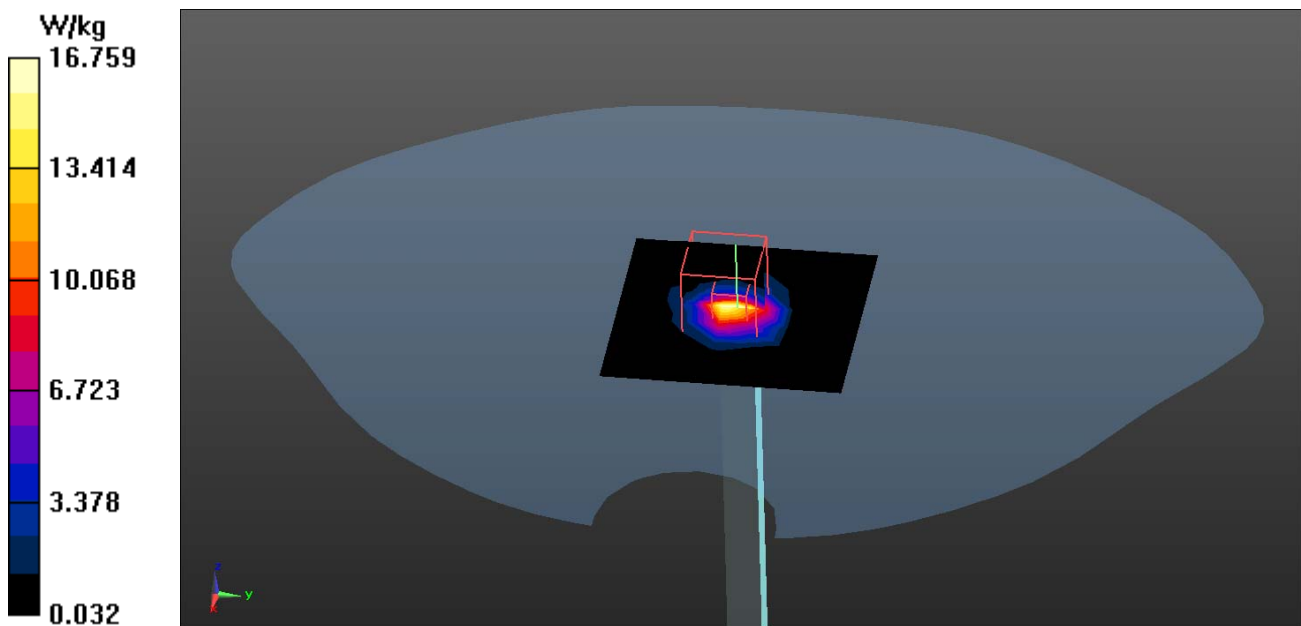

Test Laboratory: QuieTek

Date/Time: 2015/1/27

System Performance Check_5300MHz-Body

DUT: Dipole 5GHz; Type: D5GHzV2

Communication System: UID 0, CW; Frequency: 5300 MHz;

Communication System PAR: 0 dB

Medium parameters used: $f = 5300$ MHz; $\sigma = 5.5$ S/m; $\epsilon_r = 49.24$; $\rho = 1000$ kg/m³

Phantom section: Flat Section

Ambient Temperature (°C) : 22.1, Liquid Temperature (°C) : 20.5

Measurement Standard: DASY5 (IEEE/IEC/ANSI C63.19-2007)

DASY5 Configuration:

- Probe: EX3DV4 - SN3698; ConvF(4.13, 4.13, 4.13); Calibrated: 2014/7/25;
- Sensor-Surface: 2mm (Mechanical Surface Detection)
- Electronics: DAE4 Sn1207; Calibrated: 2014/5/19
- Phantom: SAM with left table; Type: SAM;
- Measurement SW: DASY52, Version 52.8 (8); SEMCAD X Version 14.6.10 (7331)

Configuration/5300MHz-Body 100mW/Area Scan (8x8x1): Measurement grid:

$dx=10$ mm, $dy=10$ mm

Maximum value of SAR (measured) = 17.0 W/kg

Configuration/5300MHz-Body 100mW/Zoom Scan (7x7x12), dist=2mm

(7x7x12)/Cube 0: Measurement grid: $dx=4$ mm, $dy=4$ mm, $dz=2$ mm

Reference Value = 65.28 V/m; Power Drift = 0.07 dB

Peak SAR (extrapolated) = 34.6 W/kg

SAR(1 g) = 8.27 W/kg; SAR(10 g) = 2.29 W/kg

Maximum value of SAR (measured) = 20.3 W/kg

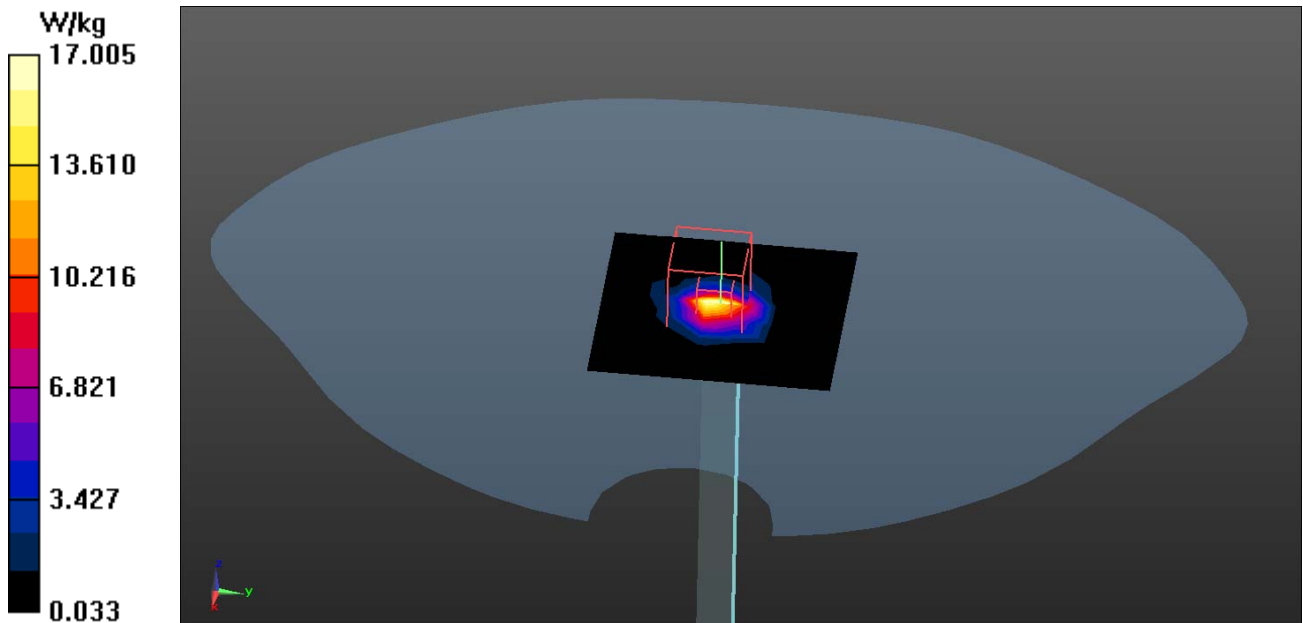

Test Laboratory: QuieTek

Date/Time: 2015/1/27

System Performance Check_5600MHz-Body

DUT: Dipole 5GHz; Type: D5GHzV2

Communication System: UID 0, CW; Frequency: 5600 MHz;

Communication System PAR: 0 dB

Medium parameters used: $f = 5600 \text{ MHz}$; $\sigma = 5.87 \text{ S/m}$; $\epsilon_r = 48.39$; $\rho = 1000 \text{ kg/m}^3$

Phantom section: Flat Section

Ambient Temperature ($^{\circ}\text{C}$) : 22.1, Liquid Temperature ($^{\circ}\text{C}$) : 20.5

Measurement Standard: DASYS (IEEE/IEC/ANSI C63.19-2007)

DASY5 Configuration:

- Probe: EX3DV4 - SN3698; ConvF(3.64, 3.64, 3.64); Calibrated: 2014/7/25;
- Sensor-Surface: 2mm (Mechanical Surface Detection)
- Electronics: DAE4 Sn1207; Calibrated: 2014/5/19
- Phantom: SAM with left table; Type: SAM;
- Measurement SW: DASYS2, Version 52.8 (8); SEMCAD X Version 14.6.10 (7331)

Configuration/5600MHz-Body 100mW/Area Scan (8x8x1): Measurement grid:

$dx=10\text{mm}$, $dy=10\text{mm}$

Maximum value of SAR (measured) = 17.6 W/kg

Configuration/5600MHz-Body 100mW/Zoom Scan (7x7x12), dist=2mm

(7x7x12)/Cube 0: Measurement grid: $dx=4\text{mm}$, $dy=4\text{mm}$, $dz=2\text{mm}$

Reference Value = 68.24 V/m; Power Drift = 0.08 dB

Peak SAR (extrapolated) = 37.1 W/kg

SAR(1 g) = 8.42 W/kg; SAR(10 g) = 2.35 W/kg

Maximum value of SAR (measured) = 20.7 W/kg

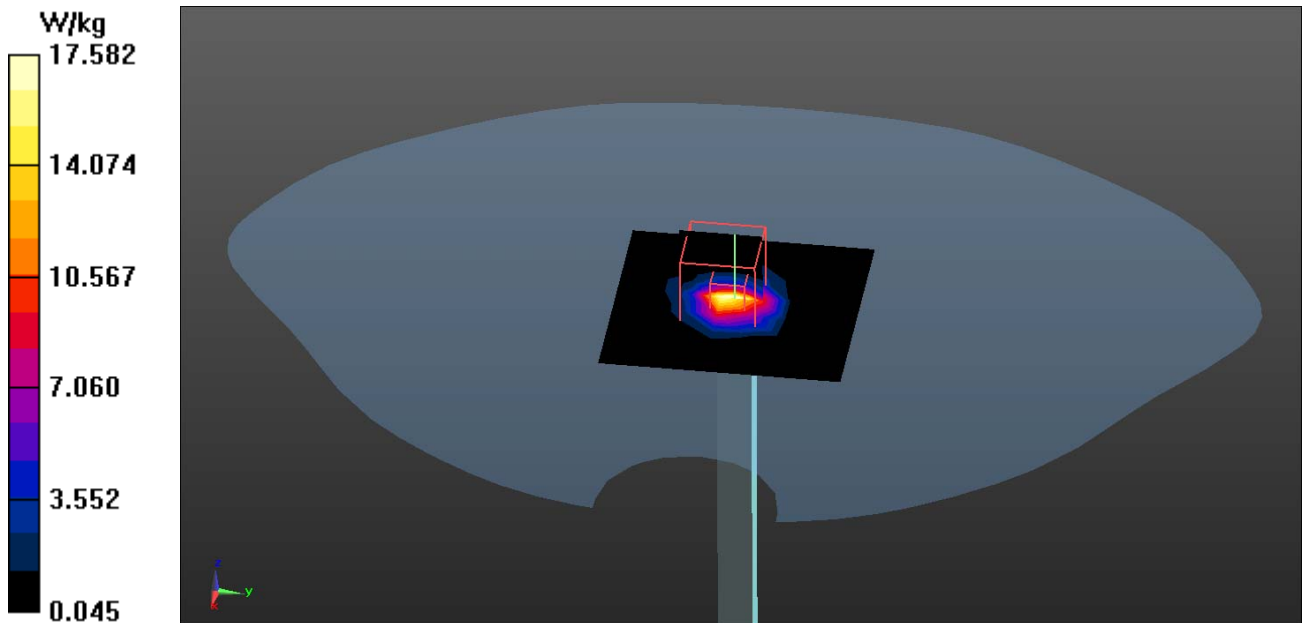

Test Laboratory: QuieTek

Date/Time: 2015/1/27

System Performance Check_5800MHz-Body

DUT: Dipole 5GHz; Type: D5GHzV2

Communication System: UID 0, CW; Frequency: 5800 MHz;

Communication System PAR: 0 dB

Medium parameters used: $f = 5800$ MHz; $\sigma = 6.26$ S/m; $\epsilon_r = 47.89$; $\rho = 1000$ kg/m³

Phantom section: Flat Section

Ambient Temperature (°C) : 22.1, Liquid Temperature (°C) : 20.5

Measurement Standard: DASYS (IEEE/IEC/ANSI C63.19-2007)

DASY5 Configuration:

- Probe: EX3DV4 - SN3698; ConvF(3.94, 3.94, 3.94); Calibrated: 2014/7/25;
- Sensor-Surface: 2mm (Mechanical Surface Detection)
- Electronics: DAE4 Sn1207; Calibrated: 2014/5/19
- Phantom: SAM with left table; Type: SAM;
- Measurement SW: DASYS2, Version 52.8 (8); SEMCAD X Version 14.6.10 (7331)

Configuration/5800MHz-Body 100mW/Area Scan (8x8x1): Measurement grid:

$dx=10$ mm, $dy=10$ mm

Maximum value of SAR (measured) = 15.1 W/kg

Configuration/5800MHz-Body 100mW/Zoom Scan (7x7x12), dist=2mm

(7x7x12)/Cube 0: Measurement grid: $dx=4$ mm, $dy=4$ mm, $dz=2$ mm

Reference Value = 65.27 V/m; Power Drift = 0.04 dB

Peak SAR (extrapolated) = 38.0 W/kg

SAR(1 g) = 8 W/kg; SAR(10 g) = 2.21 W/kg

Maximum value of SAR (measured) = 20.1 W/kg

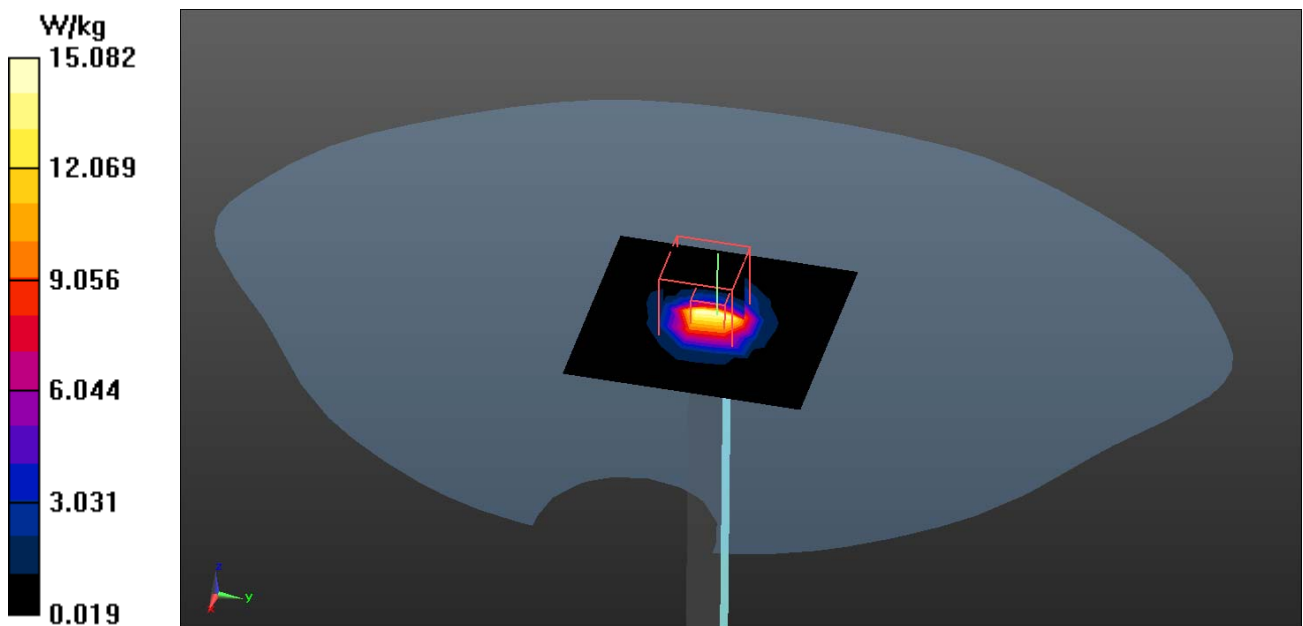

Appendix B. SAR measurement Data

Test Laboratory: QuieTek

Date/Time: 2015/1/28

802.11b_1-Bottom TX1

DUT: TABLET PC; Type: PX-501

Communication System: UID 0, WLAN 2.4G; Frequency: 2412 MHz;

Communication System PAR: 0 dB

Medium parameters used: $f = 2412$ MHz; $\sigma = 1.87$ S/m; $\epsilon_r = 53.22$; $\rho = 1000$ kg/m³

Phantom section: Flat Section

Ambient Temperature (°C) : 22.3, Liquid Temperature (°C) : 20.4

Measurement Standard: DASYS (IEEE/IEC/ANSI C63.19-2007)

DASY5 Configuration:

- Probe: EX3DV4 - SN3979; ConvF(7.08, 7.08, 7.08); Calibrated: 2014/11/21;
- Sensor-Surface: 3mm (Mechanical Surface Detection)
- Electronics: DAE4 Sn1425; Calibrated: 2014/11/13
- Phantom: SAM with right table; Type: SAM;
- Measurement SW: DASYS2, Version 52.8 (8); SEMCAD X Version 14.6.10 (7331)

Configuration/Body/Area Scan (6x17x1): Measurement grid: dx=12mm, dy=12mm
 Maximum value of SAR (measured) = 0.190 W/kg

Configuration/Body/Zoom Scan (5x5x7) (5x5x7)/Cube 0: Measurement grid:
 dx=8mm, dy=8mm, dz=5mm
 Reference Value = 4.532 V/m; Power Drift = 0.13 dB
 Peak SAR (extrapolated) = 0.294 W/kg
SAR(1 g) = 0.160 W/kg; SAR(10 g) = 0.081 W/kg
 Maximum value of SAR (measured) = 0.203 W/kg

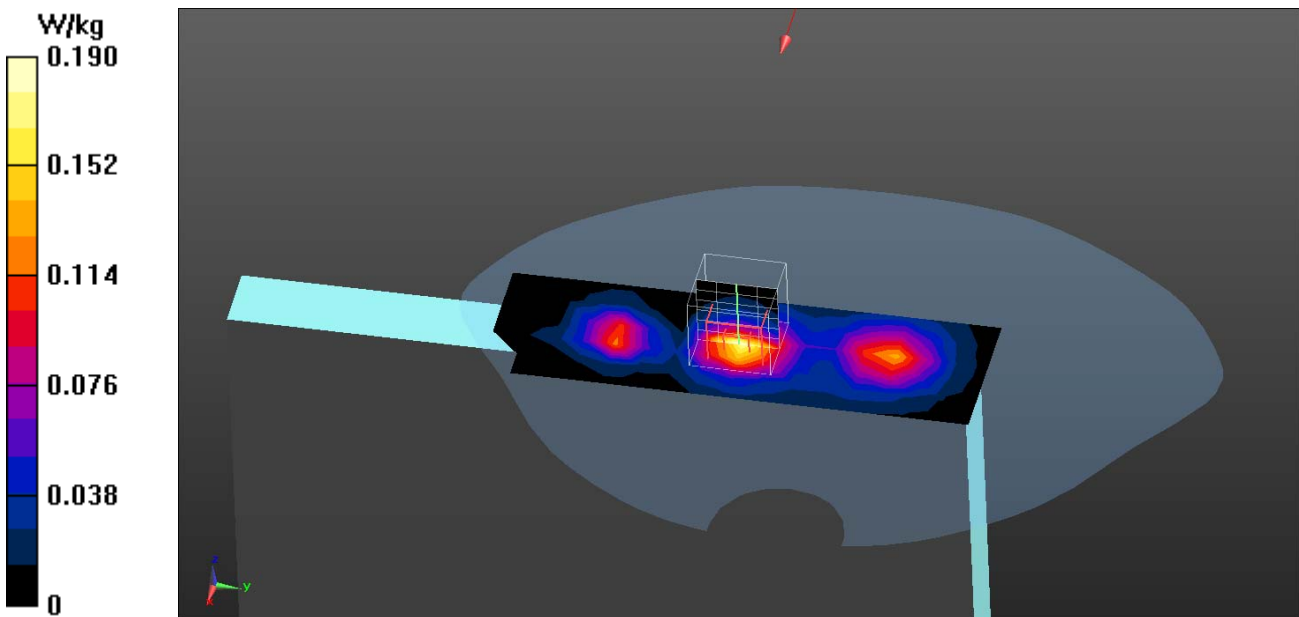

Test Laboratory: QuieTek

Date/Time: 2015/1/28

802.11b_1-Top TX2

DUT: TABLET PC; Type: PX-501

Communication System: UID 0, WLAN 2.4G; Frequency: 2412 MHz;

Communication System PAR: 0 dB

Medium parameters used: $f = 2412$ MHz; $\sigma = 1.87$ S/m; $\epsilon_r = 53.22$; $\rho = 1000$ kg/m³

Phantom section: Flat Section

Ambient Temperature (°C) : 22.3, Liquid Temperature (°C) : 20.4

Measurement Standard: DASY5 (IEEE/IEC/ANSI C63.19-2007)

DASY5 Configuration:

- Probe: EX3DV4 - SN3979; ConvF(7.08, 7.08, 7.08); Calibrated: 2014/11/21;
- Sensor-Surface: 3mm (Mechanical Surface Detection)
- Electronics: DAE4 Sn1425; Calibrated: 2014/11/13
- Phantom: SAM with right table; Type: SAM;
- Measurement SW: DASY52, Version 52.8 (8); SEMCAD X Version 14.6.10 (7331)

Configuration/Body/Area Scan (6x16x1): Measurement grid: dx=12mm, dy=12mm

Maximum value of SAR (measured) = 0.139 W/kg

Configuration/Body/Zoom Scan (5x5x7) (5x5x7)/Cube 0: Measurement grid:

dx=8mm, dy=8mm, dz=5mm

Reference Value = 2.956 V/m; Power Drift = -0.01 dB

Peak SAR (extrapolated) = 0.217 W/kg

SAR(1 g) = 0.115 W/kg; SAR(10 g) = 0.056 W/kg

Maximum value of SAR (measured) = 0.149 W/kg

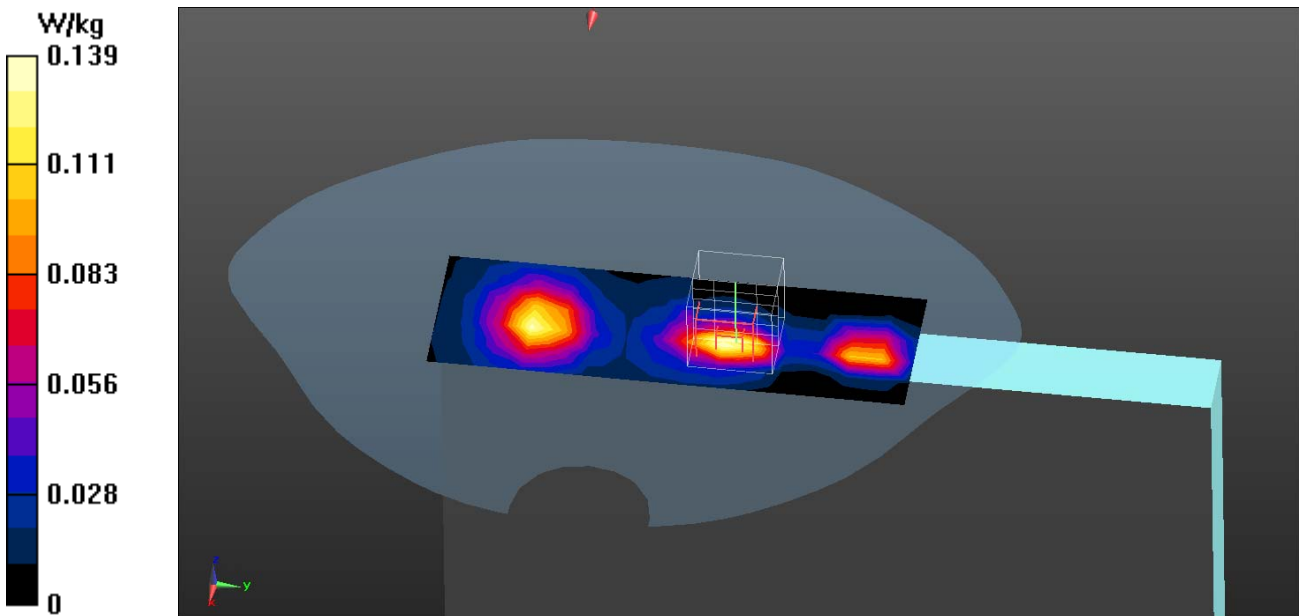

Test Laboratory: QuieTek

Date/Time: 2015/1/28

802.11g_2-Bottom TX1

DUT: TABLET PC; Type: PX-501

Communication System: UID 0, WLAN 2.4G; Frequency: 2417 MHz;

Communication System PAR: 0 dB

Medium parameters used: $f = 2417$ MHz; $\sigma = 1.88$ S/m; $\epsilon_r = 53.2$; $\rho = 1000$ kg/m³

Phantom section: Flat Section

Ambient Temperature (°C) : 22.3, Liquid Temperature (°C) : 20.4

Measurement Standard: DASY5 (IEEE/IEC/ANSI C63.19-2007)

DASY5 Configuration:

- Probe: EX3DV4 - SN3979; ConvF(7.08, 7.08, 7.08); Calibrated: 2014/11/21;
- Sensor-Surface: 3mm (Mechanical Surface Detection)
- Electronics: DAE4 Sn1425; Calibrated: 2014/11/13
- Phantom: SAM with right table; Type: SAM;
- Measurement SW: DASY52, Version 52.8 (8); SEMCAD X Version 14.6.10 (7331)

Configuration/Body/Area Scan (6x11x1): Measurement grid: dx=12mm, dy=12mm

Maximum value of SAR (measured) = 0.196 W/kg

Configuration/Body/Zoom Scan (5x5x7) (5x5x7)/Cube 0: Measurement grid:

dx=8mm, dy=8mm, dz=5mm

Reference Value = 4.543 V/m; Power Drift = 0.19 dB

Peak SAR (extrapolated) = 0.306 W/kg

SAR(1 g) = 0.162 W/kg; SAR(10 g) = 0.081 W/kg

Maximum value of SAR (measured) = 0.204 W/kg

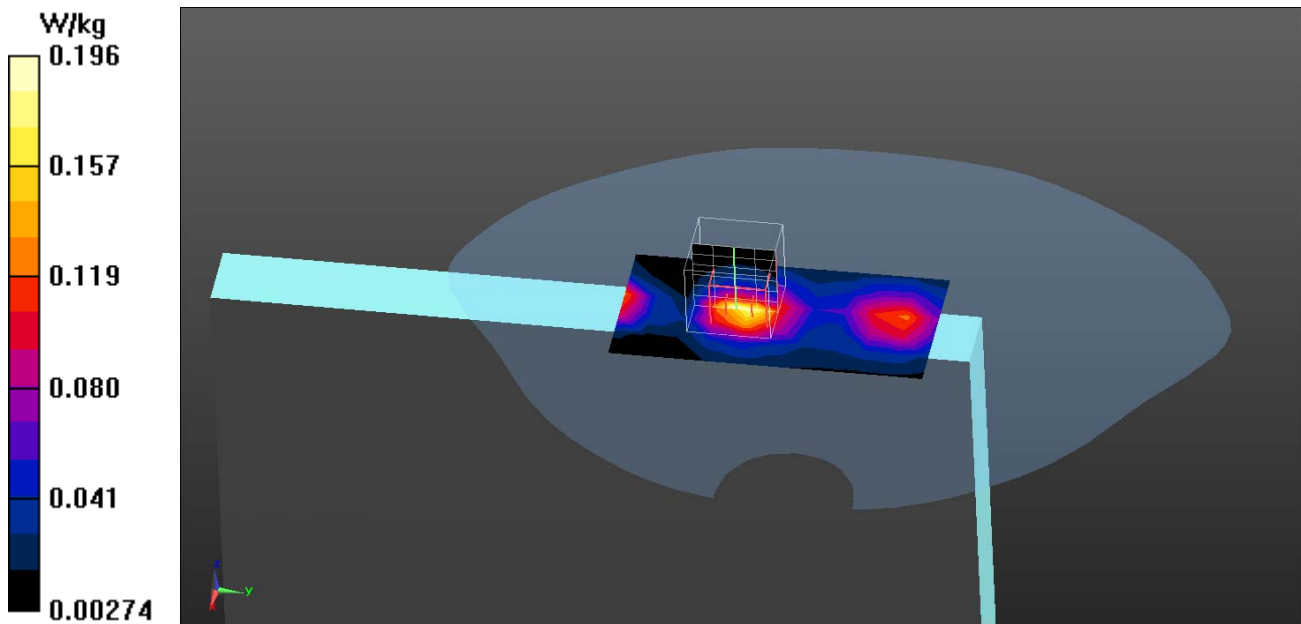

Test Laboratory: QuieTek

Date/Time: 2015/1/28

802.11g_6-Bottom TX1

DUT: TABLET PC; Type: PX-501

Communication System: UID 0, WLAN 2.4G; Frequency: 2437 MHz;

Communication System PAR: 0 dB

Medium parameters used: $f = 2437$ MHz; $\sigma = 1.9$ S/m; $\epsilon_r = 53.11$; $\rho = 1000$ kg/m³

Phantom section: Flat Section

Ambient Temperature (°C) : 22.3, Liquid Temperature (°C) : 20.4

Measurement Standard: DASYS (IEEE/IEC/ANSI C63.19-2007)

DASY5 Configuration:

- Probe: EX3DV4 - SN3979; ConvF(7.08, 7.08, 7.08); Calibrated: 2014/11/21;
- Sensor-Surface: 3mm (Mechanical Surface Detection)
- Electronics: DAE4 Sn1425; Calibrated: 2014/11/13
- Phantom: SAM with right table; Type: SAM;
- Measurement SW: DASYS2, Version 52.8 (8); SEMCAD X Version 14.6.10 (7331)

Configuration/Body/Area Scan (6x17x1): Measurement grid: dx=12mm, dy=12mm
 Maximum value of SAR (measured) = 0.220 W/kg

Configuration/Body/Zoom Scan (5x5x7) (5x5x7)/Cube 0: Measurement grid:
 dx=8mm, dy=8mm, dz=5mm
 Reference Value = 4.785 V/m; Power Drift = 0.13 dB
 Peak SAR (extrapolated) = 0.336 W/kg
SAR(1 g) = 0.180 W/kg; SAR(10 g) = 0.090 W/kg
 Maximum value of SAR (measured) = 0.228 W/kg

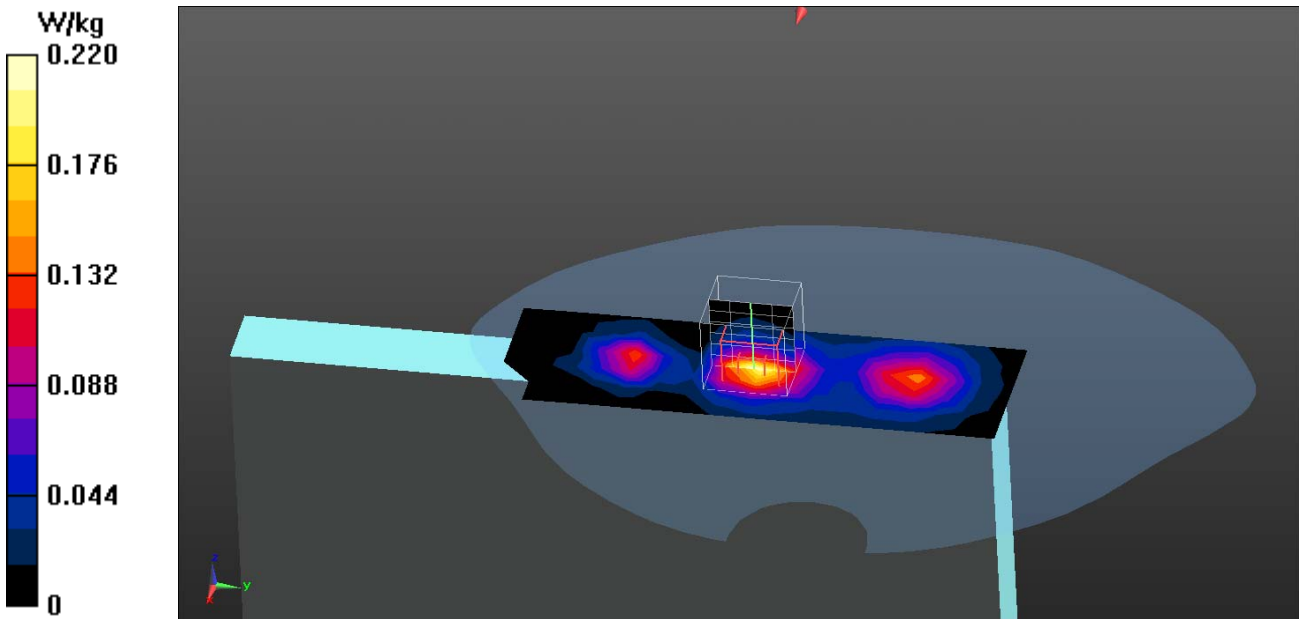

Test Laboratory: QuieTek

Date/Time: 2015/1/28

802.11g_10-Bottom TX1

DUT: TABLET PC; Type: PX-501

Communication System: UID 0, WLAN 2.4G; Frequency: 2457 MHz;

Communication System PAR: 0 dB

Medium parameters used: $f = 2457$ MHz; $\sigma = 1.94$ S/m; $\epsilon_r = 53.03$; $\rho = 1000$ kg/m³

Phantom section: Flat Section

Ambient Temperature (°C) : 22.3, Liquid Temperature (°C) : 20.4

Measurement Standard: DASYS (IEEE/IEC/ANSI C63.19-2007)

DASY5 Configuration:

- Probe: EX3DV4 - SN3979; ConvF(7.08, 7.08, 7.08); Calibrated: 2014/11/21;
- Sensor-Surface: 3mm (Mechanical Surface Detection)
- Electronics: DAE4 Sn1425; Calibrated: 2014/11/13
- Phantom: SAM with right table; Type: SAM;
- Measurement SW: DASYS2, Version 52.8 (8); SEMCAD X Version 14.6.10 (7331)

Configuration/Body/Area Scan (6x11x1): Measurement grid: dx=12mm, dy=12mm

Maximum value of SAR (measured) = 0.217 W/kg

Configuration/Body/Zoom Scan (5x5x7) (5x5x7)/Cube 0: Measurement grid:

dx=8mm, dy=8mm, dz=5mm

Reference Value = 4.765 V/m; Power Drift = 0.00 dB

Peak SAR (extrapolated) = 0.346 W/kg

SAR(1 g) = 0.182 W/kg; SAR(10 g) = 0.091 W/kg

Maximum value of SAR (measured) = 0.230 W/kg

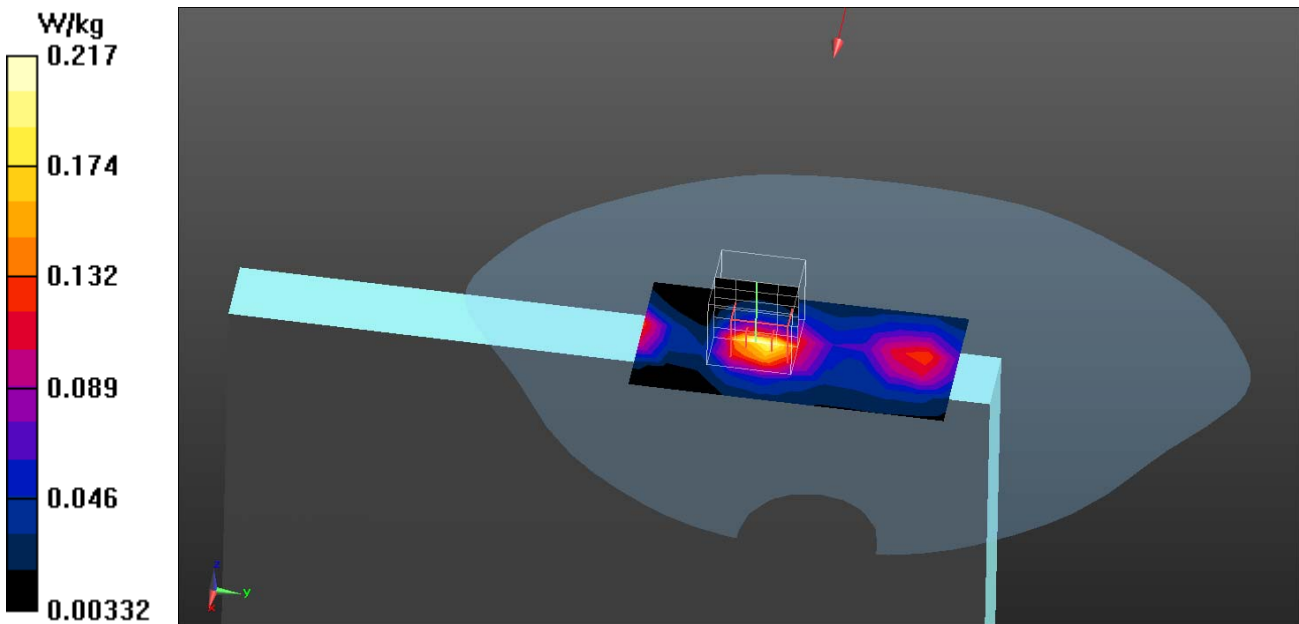

Test Laboratory: QuieTek

Date/Time: 2015/1/28

802.11g_6-Back TX1

DUT: TABLET PC; Type: PX-501

Communication System: UID 0, WLAN 2.4G; Frequency: 2437 MHz;

Communication System PAR: 0 dB

Medium parameters used: $f = 2437$ MHz; $\sigma = 1.9$ S/m; $\epsilon_r = 53.11$; $\rho = 1000$ kg/m³

Phantom section: Flat Section

Ambient Temperature (°C) : 22.3, Liquid Temperature (°C) : 20.4

Measurement Standard: DASYS (IEEE/IEC/ANSI C63.19-2007)

DASY5 Configuration:

- Probe: EX3DV4 - SN3979; ConvF(7.08, 7.08, 7.08); Calibrated: 2014/11/21;
- Sensor-Surface: 3mm (Mechanical Surface Detection)
- Electronics: DAE4 Sn1425; Calibrated: 2014/11/13
- Phantom: SAM with right table; Type: SAM;
- Measurement SW: DASYS2, Version 52.8 (8); SEMCAD X Version 14.6.10 (7331)

Configuration/Body/Area Scan (8x16x1): Measurement grid: dx=12mm, dy=12mm

Maximum value of SAR (measured) = 0.0784 W/kg

Configuration/Body/Zoom Scan (5x5x7) (5x5x7)/Cube 0: Measurement grid:

dx=8mm, dy=8mm, dz=5mm

Reference Value = 6.259 V/m; Power Drift = 0.12 dB

Peak SAR (extrapolated) = 0.119 W/kg

SAR(1 g) = 0.065 W/kg; SAR(10 g) = 0.036 W/kg

Maximum value of SAR (measured) = 0.0803 W/kg

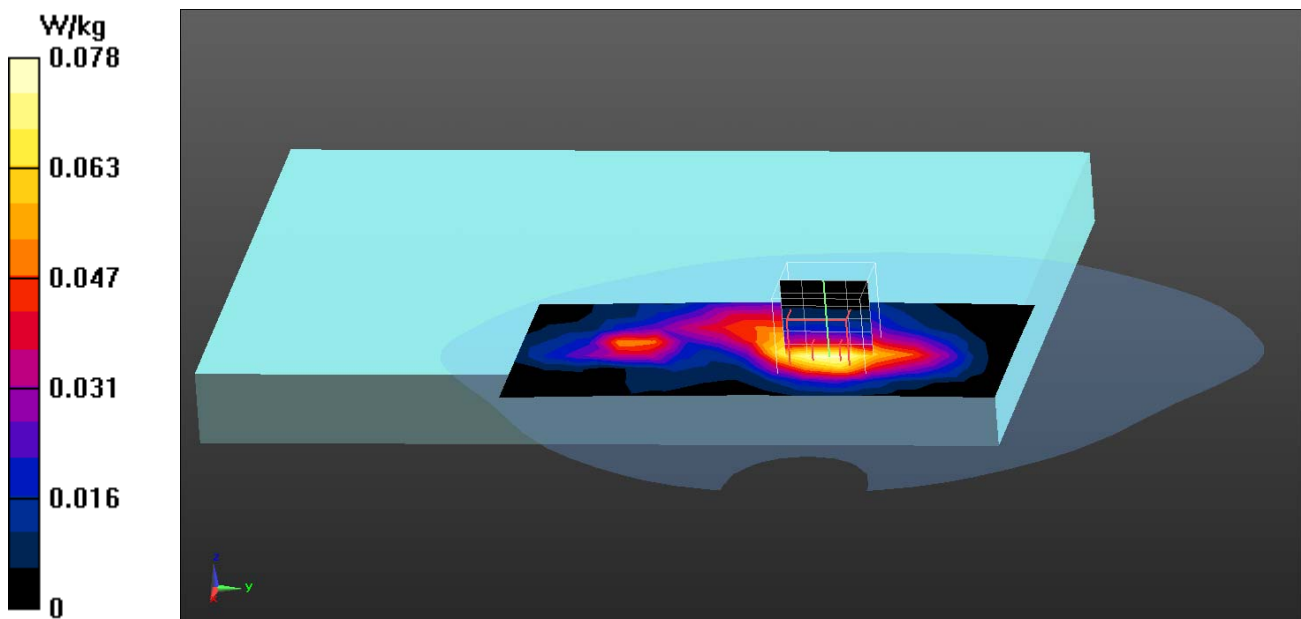

Test Laboratory: QuieTek

Date/Time: 2015/1/28

802.11g_6-Left-Side TX1

DUT: TABLET PC; Type: PX-501

Communication System: UID 0, WLAN 2.4G; Frequency: 2437 MHz;

Communication System PAR: 0 dB

Medium parameters used: $f = 2437$ MHz; $\sigma = 1.9$ S/m; $\epsilon_r = 53.11$; $\rho = 1000$ kg/m³

Phantom section: Flat Section

Ambient Temperature (°C) : 22.3, Liquid Temperature (°C) : 20.4

Measurement Standard: DASYS (IEEE/IEC/ANSI C63.19-2007)

DASY5 Configuration:

- Probe: EX3DV4 - SN3979; ConvF(7.08, 7.08, 7.08); Calibrated: 2014/11/21;
- Sensor-Surface: 3mm (Mechanical Surface Detection)
- Electronics: DAE4 Sn1425; Calibrated: 2014/11/13
- Phantom: SAM with right table; Type: SAM;
- Measurement SW: DASY52, Version 52.8 (8); SEMCAD X Version 14.6.10 (7331)

Configuration/Body/Area Scan (6x21x1): Measurement grid: dx=12mm, dy=12mm
 Maximum value of SAR (measured) = 0.0386 W/kg

Configuration/Body/Zoom Scan (5x5x7) (5x5x7)/Cube 0: Measurement grid:
 dx=8mm, dy=8mm, dz=5mm
 Reference Value = 0.4470 V/m; Power Drift = -0.07 dB
 Peak SAR (extrapolated) = 0.0610 W/kg
SAR(1 g) = 0.033 W/kg; SAR(10 g) = 0.018 W/kg
 Maximum value of SAR (measured) = 0.0405 W/kg

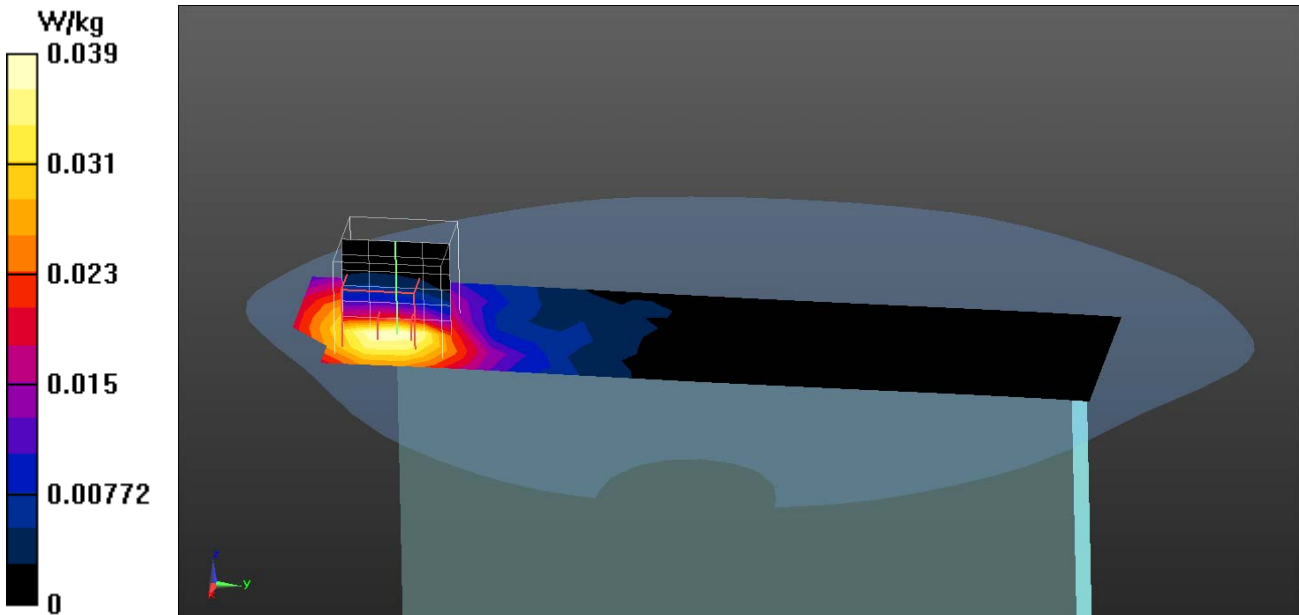

Test Laboratory: QuieTek

Date/Time: 2015/1/28

802.11g_6-Top TX2

DUT: TABLET PC; Type: PX-501

Communication System: UID 0, WLAN 2.4G; Frequency: 2437 MHz;

Communication System PAR: 0 dB

Medium parameters used: $f = 2437$ MHz; $\sigma = 1.9$ S/m; $\epsilon_r = 53.11$; $\rho = 1000$ kg/m³

Phantom section: Flat Section

Ambient Temperature (°C) : 22.3, Liquid Temperature (°C) : 20.4

Measurement Standard: DASYS (IEEE/IEC/ANSI C63.19-2007)

DASY5 Configuration:

- Probe: EX3DV4 - SN3979; ConvF(7.08, 7.08, 7.08); Calibrated: 2014/11/21;
- Sensor-Surface: 3mm (Mechanical Surface Detection)
- Electronics: DAE4 Sn1425; Calibrated: 2014/11/13
- Phantom: SAM with right table; Type: SAM;
- Measurement SW: DASYS2, Version 52.8 (8); SEMCAD X Version 14.6.10 (7331)

Configuration/Body/Area Scan (6x16x1): Measurement grid: dx=12mm, dy=12mm

Maximum value of SAR (measured) = 0.210 W/kg

Configuration/Body/Zoom Scan (5x5x7) (5x5x7)/Cube 0: Measurement grid:

dx=8mm, dy=8mm, dz=5mm

Reference Value = 4.089 V/m; Power Drift = 0.15 dB

Peak SAR (extrapolated) = 0.332 W/kg

SAR(1 g) = 0.172 W/kg; SAR(10 g) = 0.082 W/kg

Maximum value of SAR (measured) = 0.226 W/kg

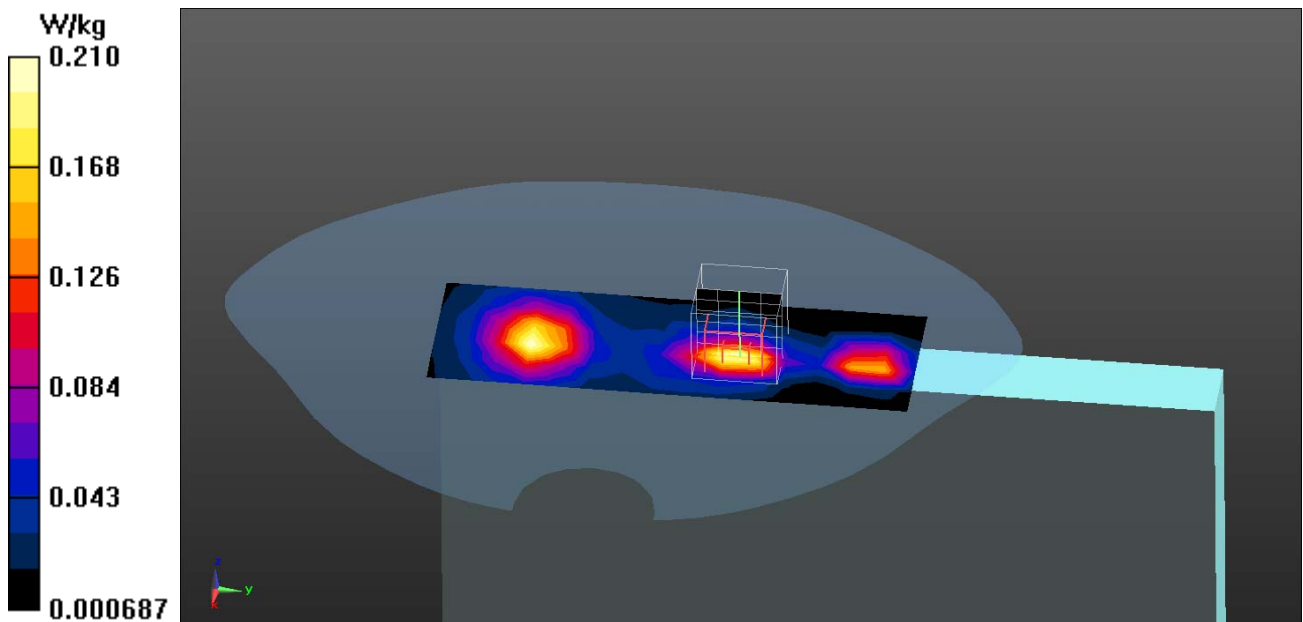

Test Laboratory: QuieTek

Date/Time: 2015/1/28

802.11g_6-Back TX2

DUT: TABLET PC; Type: PX-501

Communication System: UID 0, WLAN 2.4G; Frequency: 2437 MHz;

Communication System PAR: 0 dB

Medium parameters used: $f = 2437$ MHz; $\sigma = 1.9$ S/m; $\epsilon_r = 53.11$; $\rho = 1000$ kg/m³

Phantom section: Flat Section

Ambient Temperature (°C) : 22.3, Liquid Temperature (°C) : 20.4

Measurement Standard: DASY5 (IEEE/IEC/ANSI C63.19-2007)

DASY5 Configuration:

- Probe: EX3DV4 - SN3979; ConvF(7.08, 7.08, 7.08); Calibrated: 2014/11/21;
- Sensor-Surface: 3mm (Mechanical Surface Detection)
- Electronics: DAE4 Sn1425; Calibrated: 2014/11/13
- Phantom: SAM with right table; Type: SAM;
- Measurement SW: DASY52, Version 52.8 (8); SEMCAD X Version 14.6.10 (7331)

Configuration/Body/Area Scan (8x16x1): Measurement grid: dx=12mm, dy=12mm

Maximum value of SAR (measured) = 0.183 W/kg

Configuration/Body/Zoom Scan (5x5x7) (5x5x7)/Cube 0: Measurement grid:

dx=8mm, dy=8mm, dz=5mm

Reference Value = 9.203 V/m; Power Drift = -0.14 dB

Peak SAR (extrapolated) = 0.296 W/kg

SAR(1 g) = 0.157 W/kg; SAR(10 g) = 0.085 W/kg

Maximum value of SAR (measured) = 0.198 W/kg

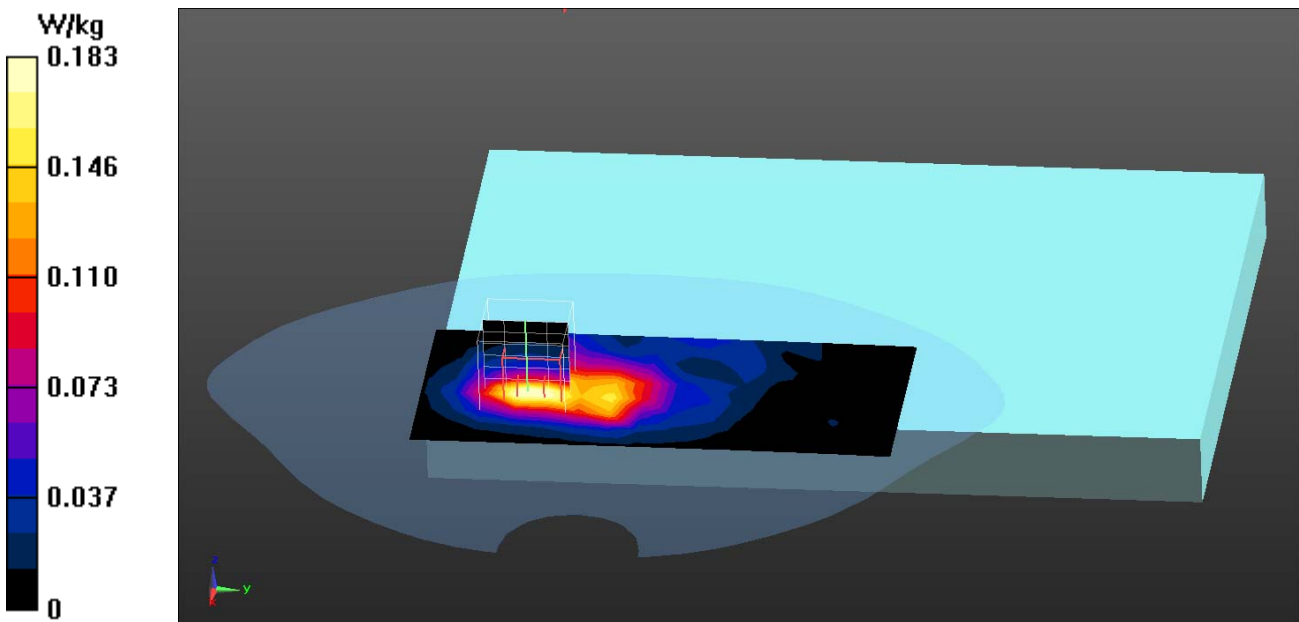

Test Laboratory: QuieTek

Date/Time: 2015/1/28

802.11g_6-Left-Side TX2

DUT: TABLET PC; Type: PX-501

Communication System: UID 0, WLAN 2.4G; Frequency: 2437 MHz;

Communication System PAR: 0 dB

Medium parameters used: $f = 2437$ MHz; $\sigma = 1.9$ S/m; $\epsilon_r = 53.11$; $\rho = 1000$ kg/m³

Phantom section: Flat Section

Ambient Temperature (°C) : 22.3, Liquid Temperature (°C) : 20.4

Measurement Standard: DASYS (IEEE/IEC/ANSI C63.19-2007)

DASY5 Configuration:

- Probe: EX3DV4 - SN3979; ConvF(7.08, 7.08, 7.08); Calibrated: 2014/11/21;
- Sensor-Surface: 3mm (Mechanical Surface Detection)
- Electronics: DAE4 Sn1425; Calibrated: 2014/11/13
- Phantom: SAM with right table; Type: SAM;
- Measurement SW: DASYS2, Version 52.8 (8); SEMCAD X Version 14.6.10 (7331)

Configuration/Body/Area Scan (6x21x1): Measurement grid: dx=12mm, dy=12mm
 Maximum value of SAR (measured) = 0.0628 W/kg

Configuration/Body/Zoom Scan (5x5x7) (5x5x7)/Cube 0: Measurement grid:
 dx=8mm, dy=8mm, dz=5mm
 Reference Value = 1.239 V/m; Power Drift = 0.18 dB
 Peak SAR (extrapolated) = 0.0990 W/kg
SAR(1 g) = 0.054 W/kg; SAR(10 g) = 0.030 W/kg
 Maximum value of SAR (measured) = 0.0664 W/kg

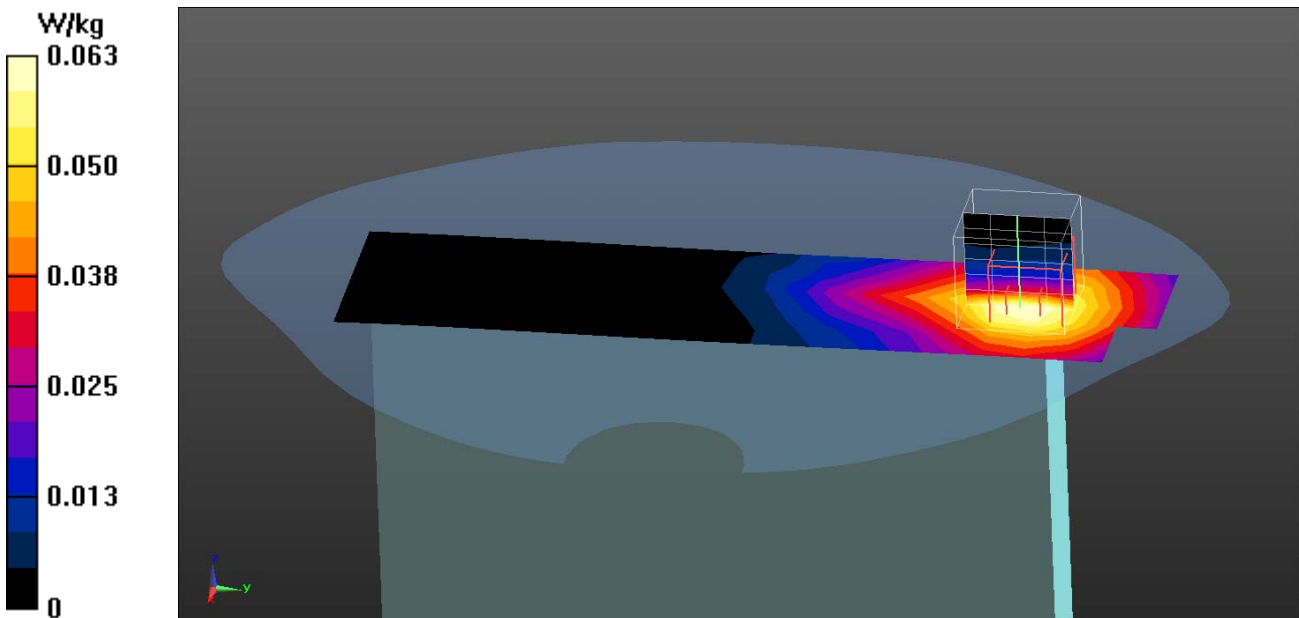

Test Laboratory: QuieTek

Date/Time: 2015/1/28

802.11n-20M_6-Bottom TX1

DUT: TABLET PC; Type: PX-501

Communication System: UID 0, WLAN 2.4G; Frequency: 2437 MHz;

Communication System PAR: 0 dB

Medium parameters used: $f = 2437$ MHz; $\sigma = 1.9$ S/m; $\epsilon_r = 53.11$; $\rho = 1000$ kg/m³

Phantom section: Flat Section

Ambient Temperature (°C) : 22.3, Liquid Temperature (°C) : 20.4

Measurement Standard: DASY5 (IEEE/IEC/ANSI C63.19-2007)

DASY5 Configuration:

- Probe: EX3DV4 - SN3979; ConvF(7.08, 7.08, 7.08); Calibrated: 2014/11/21;
- Sensor-Surface: 3mm (Mechanical Surface Detection)
- Electronics: DAE4 Sn1425; Calibrated: 2014/11/13
- Phantom: SAM with right table; Type: SAM;
- Measurement SW: DASY52, Version 52.8 (8); SEMCAD X Version 14.6.10 (7331)

Configuration/Body/Area Scan (6x17x1): Measurement grid: dx=12mm, dy=12mm

Maximum value of SAR (measured) = 0.0733 W/kg

Configuration/Body/Zoom Scan (5x5x7) (5x5x7)/Cube 0: Measurement grid:

dx=8mm, dy=8mm, dz=5mm

Reference Value = 2.739 V/m; Power Drift = -0.16 dB

Peak SAR (extrapolated) = 0.114 W/kg

SAR(1 g) = 0.060 W/kg; SAR(10 g) = 0.030 W/kg

Maximum value of SAR (measured) = 0.0753 W/kg

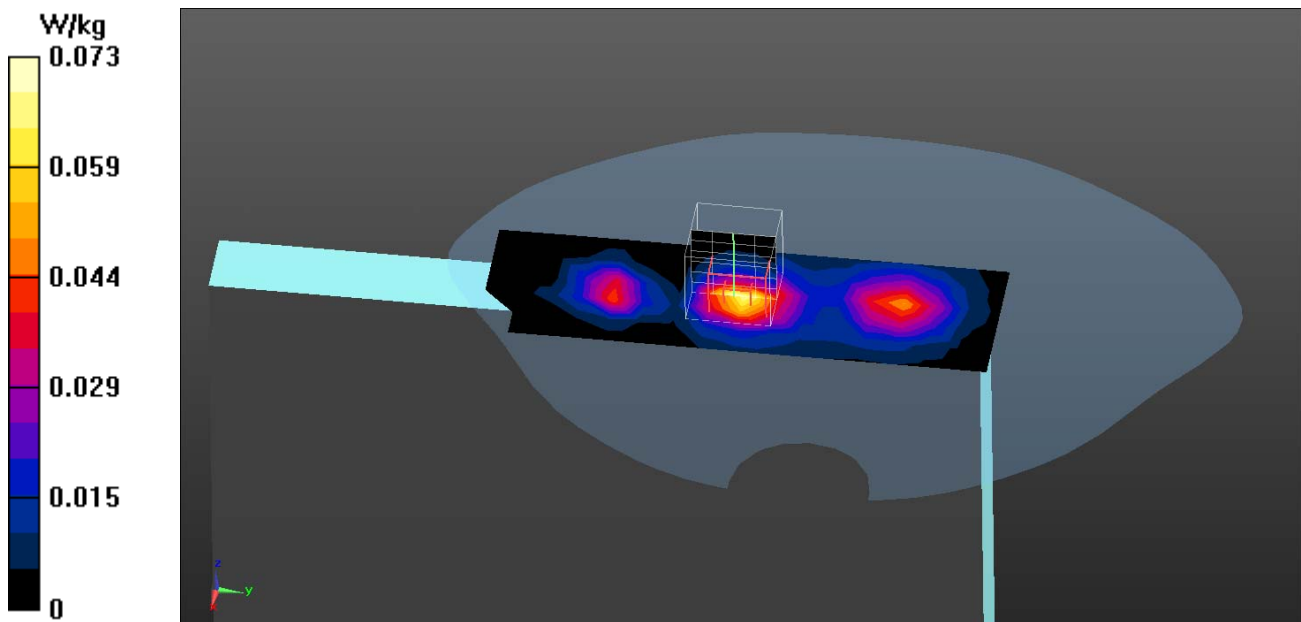

Test Laboratory: QuieTek

Date/Time: 2015/1/28

802.11n-20M_6-Top TX2

DUT: TABLET PC; Type: PX-501

Communication System: UID 0, WLAN 2.4G; Frequency: 2437 MHz;

Communication System PAR: 0 dB

Medium parameters used: $f = 2437$ MHz; $\sigma = 1.9$ S/m; $\epsilon_r = 53.11$; $\rho = 1000$ kg/m³

Phantom section: Flat Section

Ambient Temperature (°C) : 22.3, Liquid Temperature (°C) : 20.4

Measurement Standard: DASYS (IEEE/IEC/ANSI C63.19-2007)

DASY5 Configuration:

- Probe: EX3DV4 - SN3979; ConvF(7.08, 7.08, 7.08); Calibrated: 2014/11/21;
- Sensor-Surface: 3mm (Mechanical Surface Detection)
- Electronics: DAE4 Sn1425; Calibrated: 2014/11/13
- Phantom: SAM with right table; Type: SAM;
- Measurement SW: DASYS2, Version 52.8 (8); SEMCAD X Version 14.6.10 (7331)

Configuration/Body/Area Scan (6x16x1): Measurement grid: dx=12mm, dy=12mm
 Maximum value of SAR (measured) = 0.129 W/kg

Configuration/Body/Zoom Scan (5x5x7) (5x5x7)/Cube 0: Measurement grid:
 dx=8mm, dy=8mm, dz=5mm
 Reference Value = 3.138 V/m; Power Drift = -0.13 dB
 Peak SAR (extrapolated) = 0.201 W/kg
SAR(1 g) = 0.105 W/kg; SAR(10 g) = 0.050 W/kg
 Maximum value of SAR (measured) = 0.136 W/kg

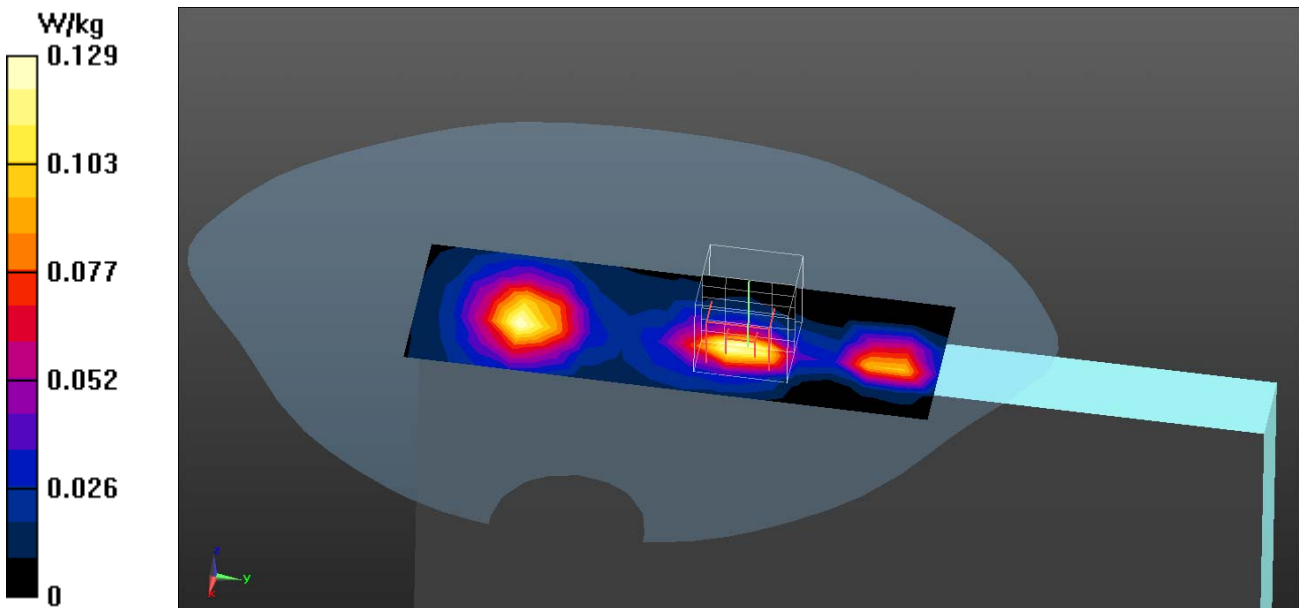

Test Laboratory: QuieTek

Date/Time: 2015/1/28

802.11n-40M_6-Bottom TX1

DUT: TABLET PC; Type: PX-501

Communication System: UID 0, WLAN 2.4G; Frequency: 2437 MHz;

Communication System PAR: 0 dB

Medium parameters used: $f = 2437$ MHz; $\sigma = 1.9$ S/m; $\epsilon_r = 53.11$; $\rho = 1000$ kg/m³

Phantom section: Flat Section

Ambient Temperature (°C) : 22.3, Liquid Temperature (°C) : 20.4

Measurement Standard: DASYS (IEEE/IEC/ANSI C63.19-2007)

DASY5 Configuration:

- Probe: EX3DV4 - SN3979; ConvF(7.08, 7.08, 7.08); Calibrated: 2014/11/21;
- Sensor-Surface: 3mm (Mechanical Surface Detection)
- Electronics: DAE4 Sn1425; Calibrated: 2014/11/13
- Phantom: SAM with right table; Type: SAM;
- Measurement SW: DASYS2, Version 52.8 (8); SEMCAD X Version 14.6.10 (7331)

Configuration/Body/Area Scan (6x17x1): Measurement grid: dx=12mm, dy=12mm

Maximum value of SAR (measured) = 0.104 W/kg

Configuration/Body/Zoom Scan (5x5x7) (5x5x7)/Cube 0: Measurement grid:

dx=8mm, dy=8mm, dz=5mm

Reference Value = 3.226 V/m; Power Drift = 0.13 dB

Peak SAR (extrapolated) = 0.159 W/kg

SAR(1 g) = 0.086 W/kg; SAR(10 g) = 0.043 W/kg

Maximum value of SAR (measured) = 0.109 W/kg

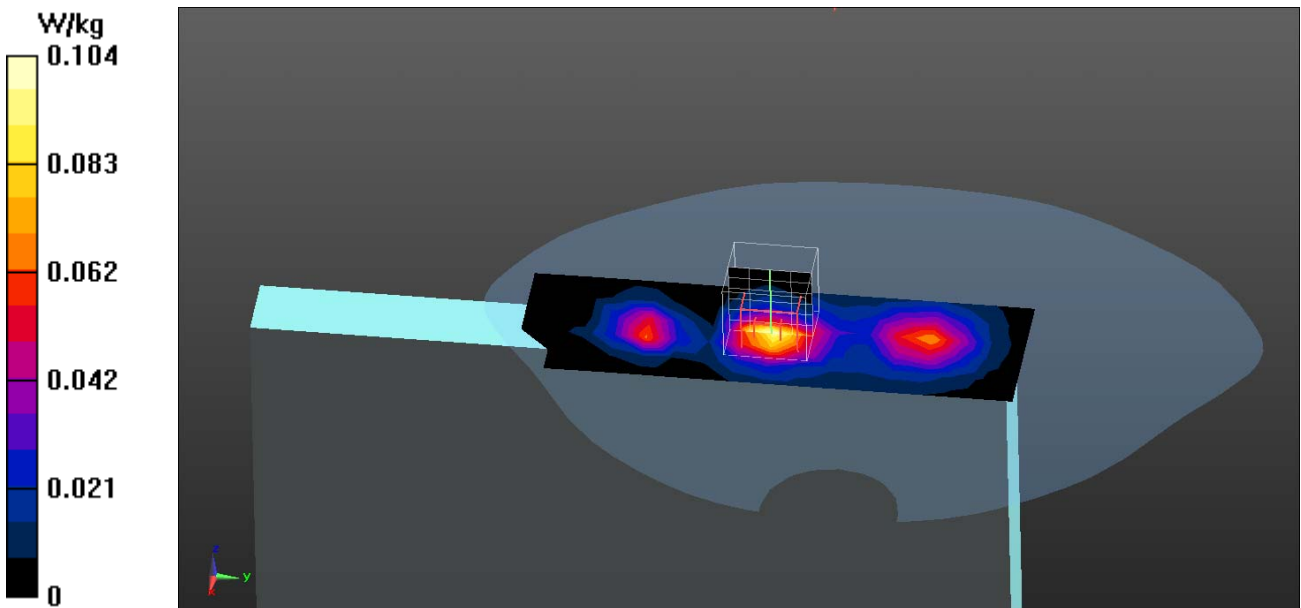

Test Laboratory: QuieTek

Date/Time: 2015/1/28

802.11n-40M_6-Top TX2

DUT: TABLET PC; Type: PX-501

Communication System: UID 0, WLAN 2.4G; Frequency: 2437 MHz;

Communication System PAR: 0 dB

Medium parameters used: $f = 2437$ MHz; $\sigma = 1.9$ S/m; $\epsilon_r = 53.11$; $\rho = 1000$ kg/m³

Phantom section: Flat Section

Ambient Temperature (°C) : 22.3, Liquid Temperature (°C) : 20.4

Measurement Standard: DASYS (IEEE/IEC/ANSI C63.19-2007)

DASY5 Configuration:

- Probe: EX3DV4 - SN3979; ConvF(7.08, 7.08, 7.08); Calibrated: 2014/11/21;
- Sensor-Surface: 3mm (Mechanical Surface Detection)
- Electronics: DAE4 Sn1425; Calibrated: 2014/11/13
- Phantom: SAM with right table; Type: SAM;
- Measurement SW: DASYS2, Version 52.8 (8); SEMCAD X Version 14.6.10 (7331)

Configuration/Body/Area Scan (6x16x1): Measurement grid: dx=12mm, dy=12mm
 Maximum value of SAR (measured) = 0.147 W/kg

Configuration/Body/Zoom Scan (5x5x7) (5x5x7)/Cube 0: Measurement grid:
 dx=8mm, dy=8mm, dz=5mm
 Reference Value = 3.305 V/m; Power Drift = -0.15 dB
 Peak SAR (extrapolated) = 0.228 W/kg
SAR(1 g) = 0.121 W/kg; SAR(10 g) = 0.058 W/kg
 Maximum value of SAR (measured) = 0.157 W/kg

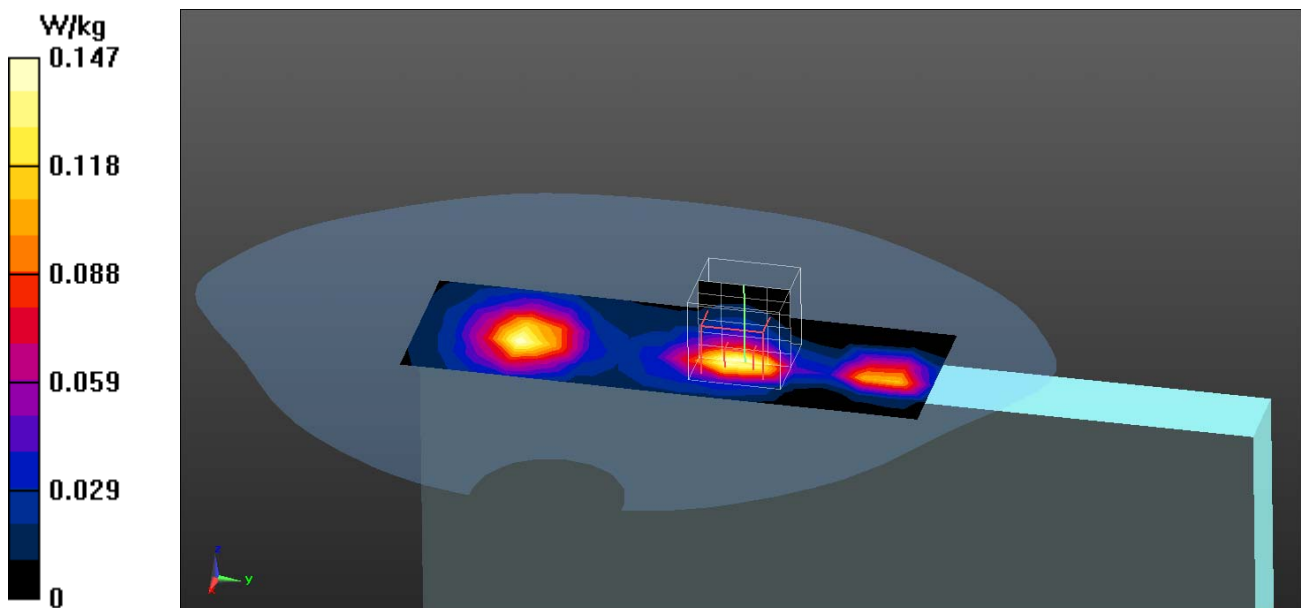

802.11g EUT Bottom (TX1), Z-Axis plot
Channel: 10

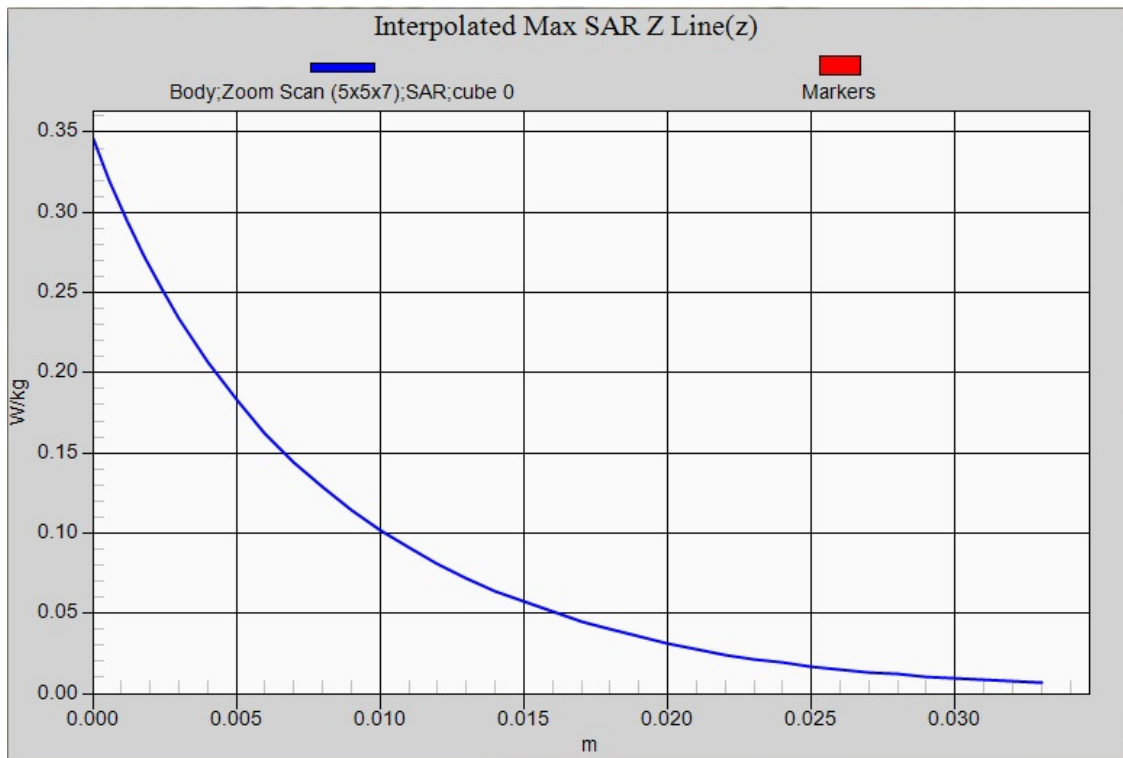

Test Laboratory: QuieTek

Date/Time: 2015/1/27

802.11a_149-Back TX1

DUT: TABLET PC; Type: PX-501

Communication System: UID 0, WLAN 5G; Frequency: 5745 MHz;

Communication System PAR: 0 dB

Medium parameters used: $f = 5745 \text{ MHz}$; $\sigma = 6.19 \text{ S/m}$; $\epsilon_r = 48.02$; $\rho = 1000 \text{ kg/m}^3$

Phantom section: Flat Section

Ambient Temperature ($^{\circ}\text{C}$) : 22.1, Liquid Temperature ($^{\circ}\text{C}$) : 20.5

Measurement Standard: DASY5 (IEEE/IEC/ANSI C63.19-2007)

DASY5 Configuration:

- Probe: EX3DV4 - SN3698; ConvF(3.94, 3.94, 3.94); Calibrated: 2014/7/25;
- Sensor-Surface: 2mm (Mechanical Surface Detection)
- Electronics: DAE4 Sn1207; Calibrated: 2014/5/19
- Phantom: SAM with left table; Type: SAM;
- Measurement SW: DASY52, Version 52.8 (8); SEMCAD X Version 14.6.10 (7331)

Configuration/Body/Area Scan (9x13x1): Measurement grid: dx=10mm, dy=10mm
 Maximum value of SAR (measured) = 0.150 W/kg

Configuration/Body/Zoom Scan (6x6x12) (6x6x12)/Cube 0: Measurement grid: dx=5mm, dy=5mm, dz=2mm
 Reference Value = 4.675 V/m; Power Drift = -0.10 dB
 Peak SAR (extrapolated) = 0.313 W/kg
SAR(1 g) = 0.078 W/kg; SAR(10 g) = 0.026 W/kg
 Maximum value of SAR (measured) = 0.172 W/kg

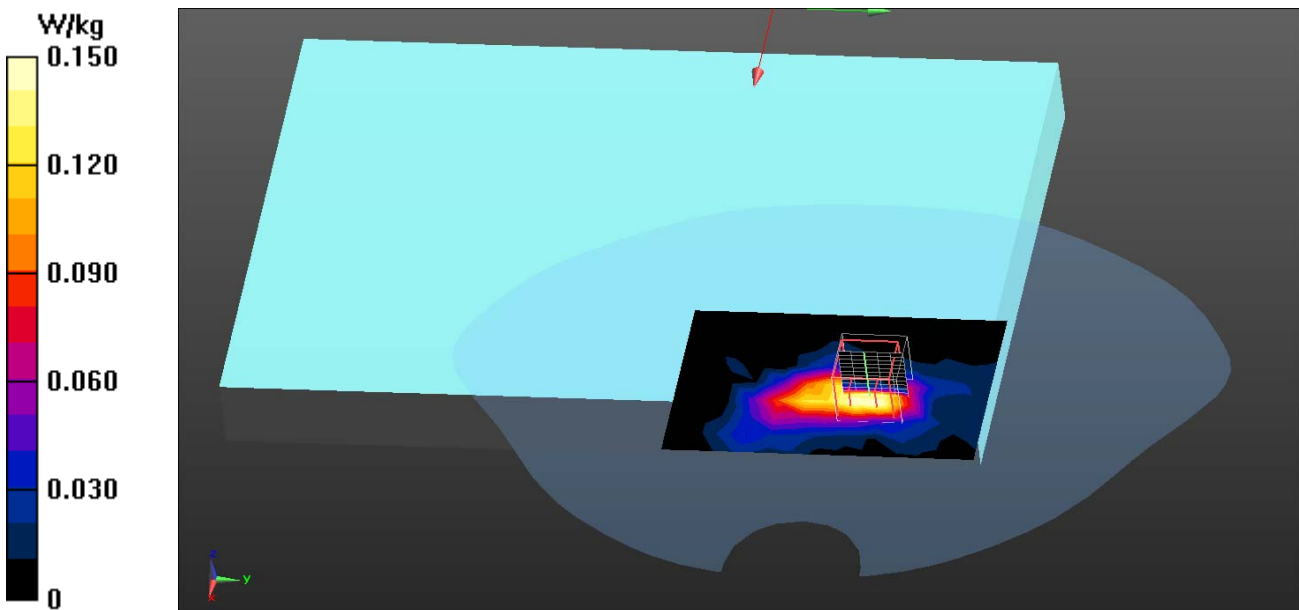

Test Laboratory: QuieTek

Date/Time: 2015/1/27

802.11a_149-Left-Side TX1

DUT: TABLET PC; Type: PX-501

Communication System: UID 0, WLAN 5G; Frequency: 5745 MHz;

Communication System PAR: 0 dB

Medium parameters used: $f = 5745 \text{ MHz}$; $\sigma = 6.19 \text{ S/m}$; $\epsilon_r = 48.02$; $\rho = 1000 \text{ kg/m}^3$

Phantom section: Flat Section

Ambient Temperature ($^{\circ}\text{C}$) : 22.1, Liquid Temperature ($^{\circ}\text{C}$) : 20.5

Measurement Standard: DASYS (IEEE/IEC/ANSI C63.19-2007)

DASY5 Configuration:

- Probe: EX3DV4 - SN3698; ConvF(3.94, 3.94, 3.94); Calibrated: 2014/7/25;
- Sensor-Surface: 2mm (Mechanical Surface Detection)
- Electronics: DAE4 Sn1207; Calibrated: 2014/5/19
- Phantom: SAM with left table; Type: SAM;
- Measurement SW: DASY52, Version 52.8 (8); SEMCAD X Version 14.6.10 (7331)

Configuration/Body/Area Scan (5x22x1): Measurement grid: $dx=10\text{mm}$, $dy=10\text{mm}$
 Maximum value of SAR (measured) = 0.197 W/kg

Configuration/Body/Zoom Scan (6x6x12) (6x6x12)/Cube 0: Measurement grid:
 $dx=5\text{mm}$, $dy=5\text{mm}$, $dz=2\text{mm}$
 Reference Value = 0 V/m; Power Drift = 0.12 dB
 Peak SAR (extrapolated) = 0.444 W/kg
SAR(1 g) = 0.089 W/kg; SAR(10 g) = 0.032 W/kg
 Maximum value of SAR (measured) = 0.211 W/kg

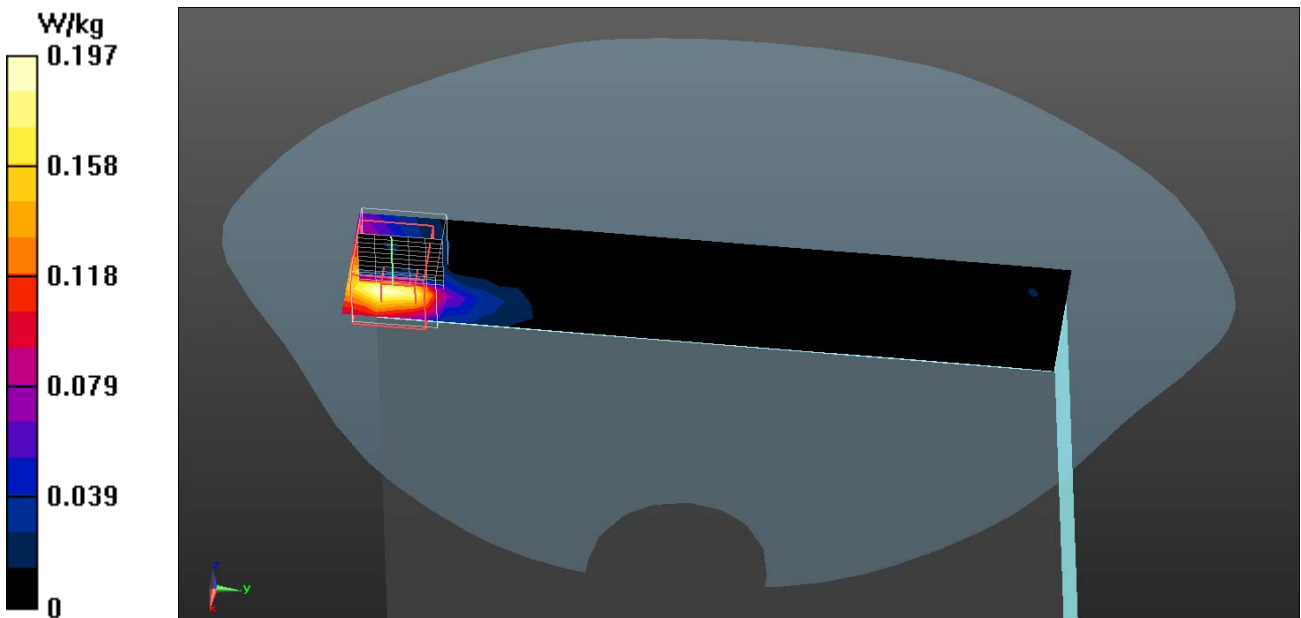

Test Laboratory: QuieTek

Date/Time: 2015/1/27

802.11a_40-Bottom TX1

DUT: TABLET PC; Type: PX-501

Communication System: UID 0, WLAN 5G; Frequency: 5200 MHz;

Communication System PAR: 0 dB

Medium parameters used: $f = 5200$ MHz; $\sigma = 5.34$ S/m; $\epsilon_r = 49.5$; $\rho = 1000$ kg/m³

Phantom section: Flat Section

Ambient Temperature (°C) : 22.1, Liquid Temperature (°C) : 20.5

Measurement Standard: DASYS (IEEE/IEC/ANSI C63.19-2007)

DASY5 Configuration:

- Probe: EX3DV4 - SN3698; ConvF(4.23, 4.23, 4.23); Calibrated: 2014/7/25;
- Sensor-Surface: 2mm (Mechanical Surface Detection)
- Electronics: DAE4 Sn1207; Calibrated: 2014/5/19
- Phantom: SAM with left table; Type: SAM;
- Measurement SW: DASY52, Version 52.8 (8); SEMCAD X Version 14.6.10 (7331)

Configuration/Body/Area Scan (6x10x1): Measurement grid: dx=10mm, dy=10mm
 Maximum value of SAR (measured) = 0.953 W/kg

Configuration/Body/Zoom Scan (6x6x12) (6x6x12)/Cube 0: Measurement grid:
 dx=5mm, dy=5mm, dz=2mm
 Reference Value = 11.81 V/m; Power Drift = -0.13 dB
 Peak SAR (extrapolated) = 2.37 W/kg
SAR(1 g) = 0.537 W/kg; SAR(10 g) = 0.169 W/kg
 Maximum value of SAR (measured) = 1.04 W/kg

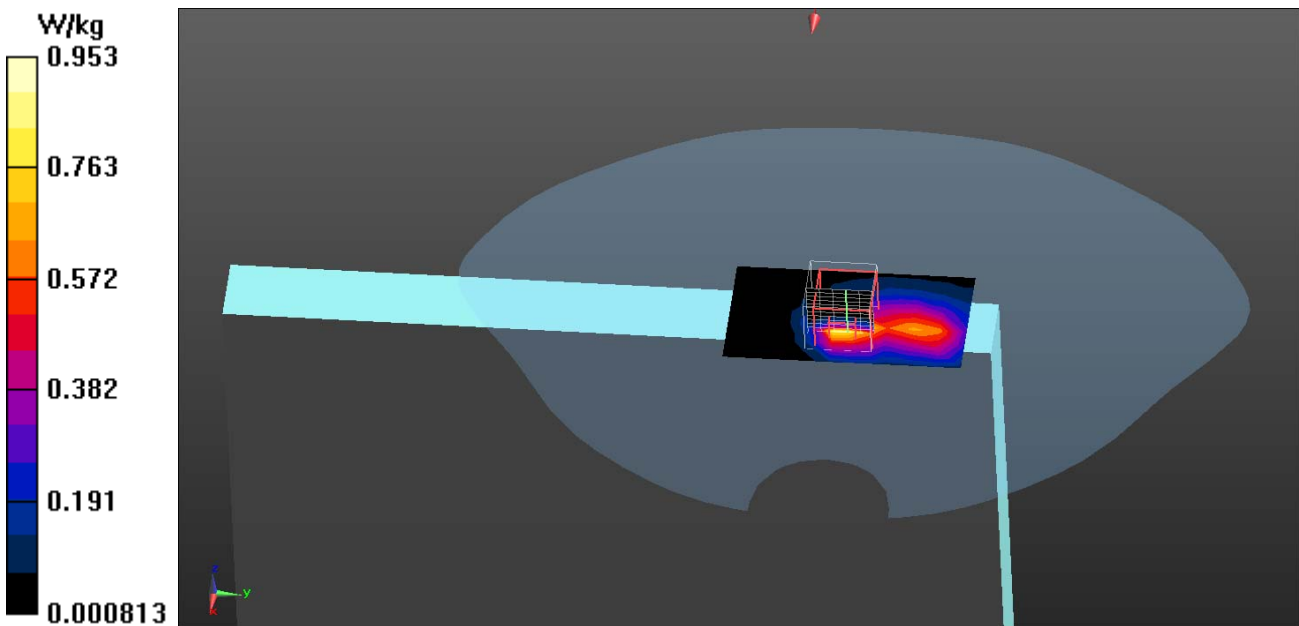

Test Laboratory: QuieTek

Date/Time: 2015/1/27

802.11a_44-Bottom TX1

DUT: TABLET PC; Type: PX-501

Communication System: UID 0, WLAN 5G; Frequency: 5220 MHz;

Communication System PAR: 0 dB

Medium parameters used: $f = 5220 \text{ MHz}$; $\sigma = 5.37 \text{ S/m}$; $\epsilon_r = 49.45$; $\rho = 1000 \text{ kg/m}^3$

Phantom section: Flat Section

Ambient Temperature ($^{\circ}\text{C}$) : 22.1, Liquid Temperature ($^{\circ}\text{C}$) : 20.5

Measurement Standard: DASYS (IEEE/IEC/ANSI C63.19-2007)

DASY5 Configuration:

- Probe: EX3DV4 - SN3698; ConvF(4.23, 4.23, 4.23); Calibrated: 2014/7/25;
- Sensor-Surface: 2mm (Mechanical Surface Detection)
- Electronics: DAE4 Sn1207; Calibrated: 2014/5/19
- Phantom: SAM with left table; Type: SAM;
- Measurement SW: DASYS2, Version 52.8 (8); SEMCAD X Version 14.6.10 (7331)

Configuration/Body/Area Scan (6x10x1): Measurement grid: dx=10mm, dy=10mm
 Maximum value of SAR (measured) = 0.711 W/kg

Configuration/Body/Zoom Scan (6x6x12) (6x6x12)/Cube 0: Measurement grid: dx=5mm, dy=5mm, dz=2mm
 Reference Value = 14.03 V/m; Power Drift = 0.13 dB
 Peak SAR (extrapolated) = 1.92 W/kg
SAR(1 g) = 0.465 W/kg; SAR(10 g) = 0.147 W/kg
 Maximum value of SAR (measured) = 0.875 W/kg

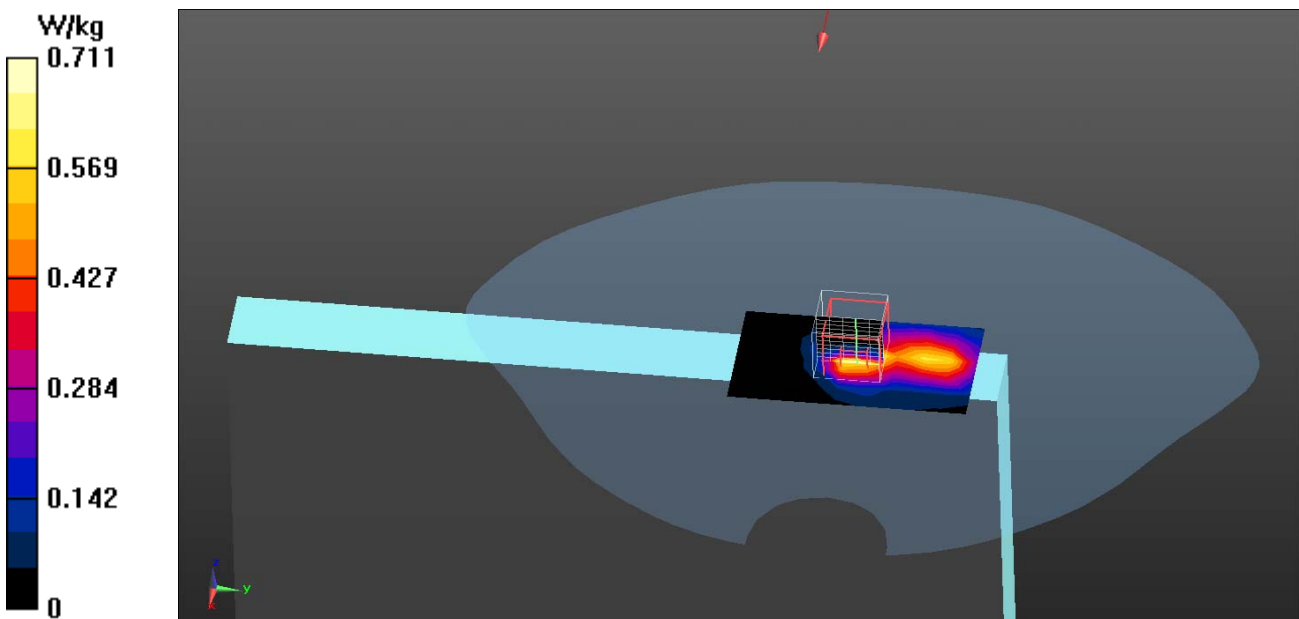

Test Laboratory: QuieTek

Date/Time: 2015/1/27

802.11a_48-Bottom TX1

DUT: TABLET PC; Type: PX-501

Communication System: UID 0, WLAN 5G; Frequency: 5240 MHz;

Communication System PAR: 0 dB

Medium parameters used: $f = 5240 \text{ MHz}$; $\sigma = 5.41 \text{ S/m}$; $\epsilon_r = 49.39$; $\rho = 1000 \text{ kg/m}^3$

Phantom section: Flat Section

Ambient Temperature ($^{\circ}\text{C}$) : 22.1, Liquid Temperature ($^{\circ}\text{C}$) : 20.5

Measurement Standard: DASYS (IEEE/IEC/ANSI C63.19-2007)

DASY5 Configuration:

- Probe: EX3DV4 - SN3698; ConvF(4.23, 4.23, 4.23); Calibrated: 2014/7/25;
- Sensor-Surface: 2mm (Mechanical Surface Detection)
- Electronics: DAE4 Sn1207; Calibrated: 2014/5/19
- Phantom: SAM with left table; Type: SAM;
- Measurement SW: DASYS2, Version 52.8 (8); SEMCAD X Version 14.6.10 (7331)

Configuration/Body/Area Scan (6x10x1): Measurement grid: $dx=10\text{mm}$, $dy=10\text{mm}$
 Maximum value of SAR (measured) = 0.705 W/kg

Configuration/Body/Zoom Scan (6x6x12) (6x6x12)/Cube 0: Measurement grid:
 $dx=5\text{mm}$, $dy=5\text{mm}$, $dz=2\text{mm}$
 Reference Value = 14.09 V/m; Power Drift = 0.04 dB
 Peak SAR (extrapolated) = 1.94 W/kg
SAR(1 g) = 0.464 W/kg; SAR(10 g) = 0.145 W/kg
 Maximum value of SAR (measured) = 0.878 W/kg

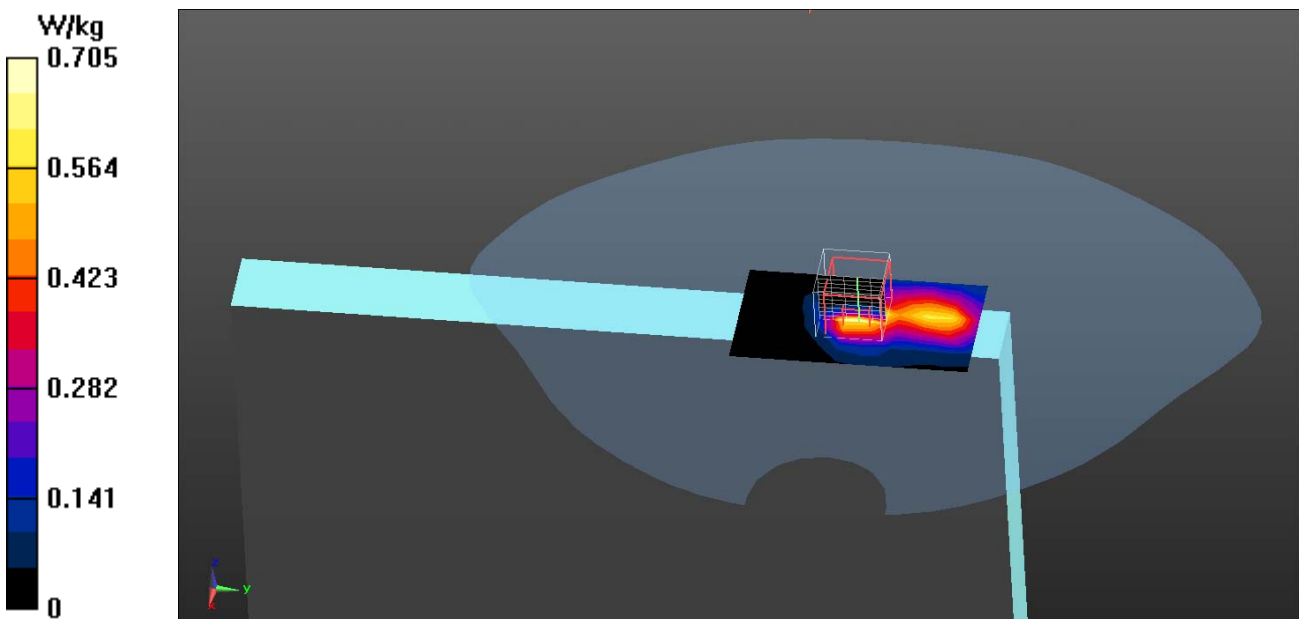

Test Laboratory: QuieTek

Date/Time: 2015/1/27

802.11a_56-Bottom TX1

DUT: TABLET PC; Type: PX-501

Communication System: UID 0, WLAN 5G; Frequency: 5280 MHz;

Communication System PAR: 0 dB

Medium parameters used: $f = 5280$ MHz; $\sigma = 5.49$ S/m; $\epsilon_r = 49.27$; $\rho = 1000$ kg/m³

Phantom section: Flat Section

Ambient Temperature (°C) : 22.1, Liquid Temperature (°C) : 20.5

Measurement Standard: DASYS (IEEE/IEC/ANSI C63.19-2007)

DASY5 Configuration:

- Probe: EX3DV4 - SN3698; ConvF(4.13, 4.13, 4.13); Calibrated: 2014/7/25;
- Sensor-Surface: 2mm (Mechanical Surface Detection)
- Electronics: DAE4 Sn1207; Calibrated: 2014/5/19
- Phantom: SAM with left table; Type: SAM;
- Measurement SW: DASYS2, Version 52.8 (8); SEMCAD X Version 14.6.10 (7331)

Configuration/Body/Area Scan (6x10x1): Measurement grid: dx=10mm, dy=10mm
 Maximum value of SAR (measured) = 0.851 W/kg

Configuration/Body/Zoom Scan (6x6x12) (6x6x12)/Cube 0: Measurement grid:
 dx=5mm, dy=5mm, dz=2mm
 Reference Value = 10.91 V/m; Power Drift = -0.14 dB
 Peak SAR (extrapolated) = 2.05 W/kg
SAR(1 g) = 0.463 W/kg; SAR(10 g) = 0.145 W/kg
 Maximum value of SAR (measured) = 0.904 W/kg

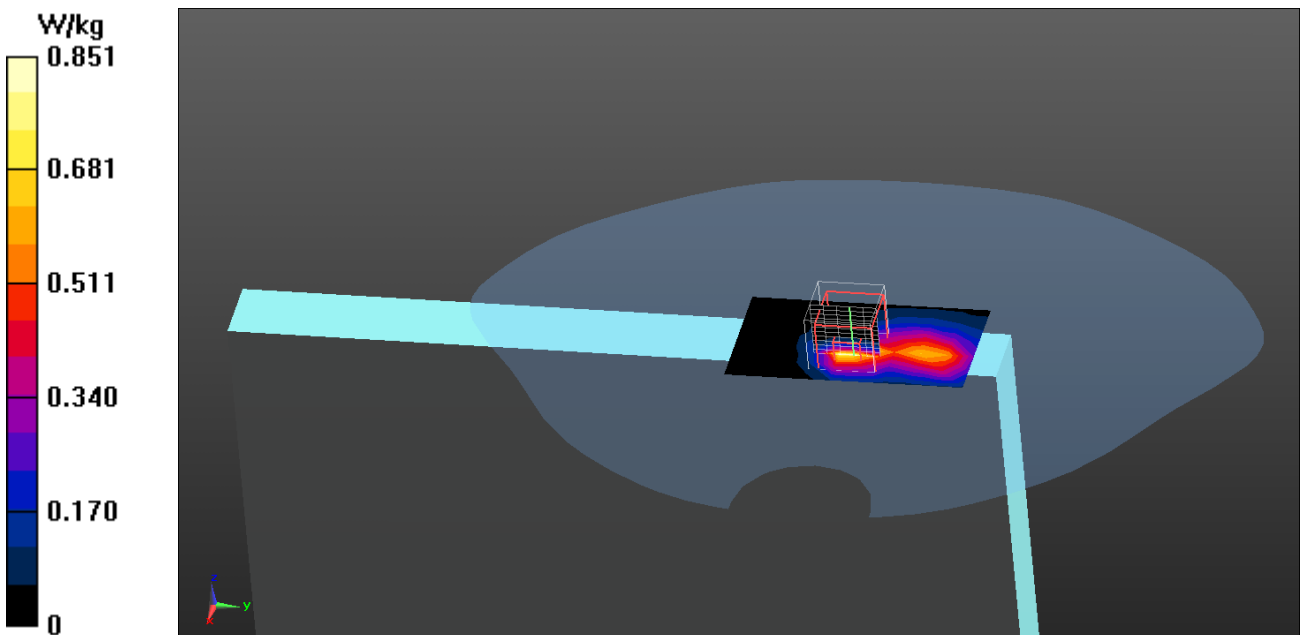

Test Laboratory: QuieTek

Date/Time: 2015/1/27

802.11a_60-Bottom TX1

DUT: TABLET PC; Type: PX-501

Communication System: UID 0, WLAN 5G; Frequency: 5300 MHz;

Communication System PAR: 0 dB

Medium parameters used: $f = 5300$ MHz; $\sigma = 5.5$ S/m; $\epsilon_r = 49.24$; $\rho = 1000$ kg/m³

Phantom section: Flat Section

Ambient Temperature (°C) : 22.1, Liquid Temperature (°C) : 20.5

Measurement Standard: DASYS (IEEE/IEC/ANSI C63.19-2007)

DASY5 Configuration:

- Probe: EX3DV4 - SN3698; ConvF(4.13, 4.13, 4.13); Calibrated: 2014/7/25;
- Sensor-Surface: 2mm (Mechanical Surface Detection)
- Electronics: DAE4 Sn1207; Calibrated: 2014/5/19
- Phantom: SAM with left table; Type: SAM;
- Measurement SW: DASYS2, Version 52.8 (8); SEMCAD X Version 14.6.10 (7331)

Configuration/Body/Area Scan (6x10x1): Measurement grid: dx=10mm, dy=10mm
 Maximum value of SAR (measured) = 0.783 W/kg

Configuration/Body/Zoom Scan (6x6x12) (6x6x12)/Cube 0: Measurement grid:
 dx=5mm, dy=5mm, dz=2mm
 Reference Value = 14.50 V/m; Power Drift = 0.06 dB
 Peak SAR (extrapolated) = 2.13 W/kg
SAR(1 g) = 0.503 W/kg; SAR(10 g) = 0.157 W/kg
 Maximum value of SAR (measured) = 0.943 W/kg

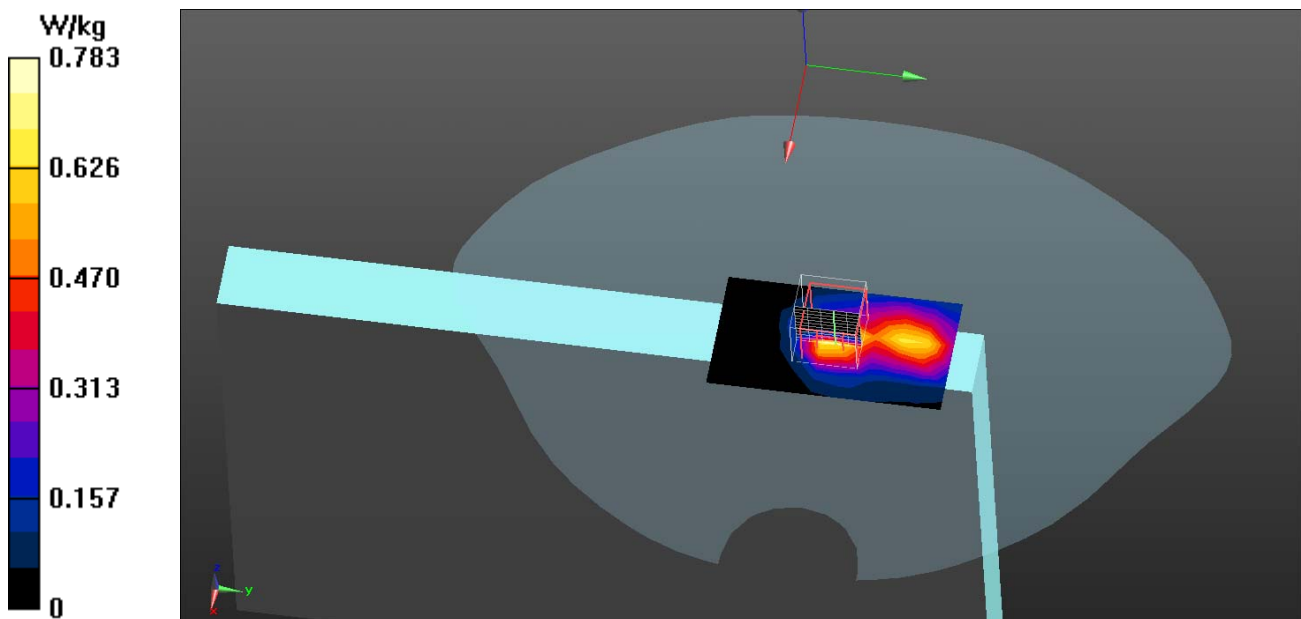

Test Laboratory: QuieTek

Date/Time: 2015/1/27

802.11a_64-Bottom TX1

DUT: TABLET PC; Type: PX-501

Communication System: UID 0, WLAN 5G; Frequency: 5320 MHz;

Communication System PAR: 0 dB

Medium parameters used: $f = 5320 \text{ MHz}$; $\sigma = 5.53 \text{ S/m}$; $\epsilon_r = 49.18$; $\rho = 1000 \text{ kg/m}^3$

Phantom section: Flat Section

Ambient Temperature ($^{\circ}\text{C}$) : 22.1, Liquid Temperature ($^{\circ}\text{C}$) : 20.5

Measurement Standard: DASYS (IEEE/IEC/ANSI C63.19-2007)

DASY5 Configuration:

- Probe: EX3DV4 - SN3698; ConvF(4.13, 4.13, 4.13); Calibrated: 2014/7/25;
- Sensor-Surface: 2mm (Mechanical Surface Detection)
- Electronics: DAE4 Sn1207; Calibrated: 2014/5/19
- Phantom: SAM with left table; Type: SAM;
- Measurement SW: DASYS2, Version 52.8 (8); SEMCAD X Version 14.6.10 (7331)

Configuration/Body/Area Scan (6x10x1): Measurement grid: $dx=10\text{mm}$, $dy=10\text{mm}$

Maximum value of SAR (measured) = 0.851 W/kg

Configuration/Body/Zoom Scan (6x6x12) (6x6x12)/Cube 0: Measurement grid:

$dx=5\text{mm}$, $dy=5\text{mm}$, $dz=2\text{mm}$

Reference Value = 11.16 V/m; Power Drift = -0.14 dB

Peak SAR (extrapolated) = 1.98 W/kg

SAR(1 g) = 0.440 W/kg; SAR(10 g) = 0.137 W/kg

Maximum value of SAR (measured) = 0.860 W/kg

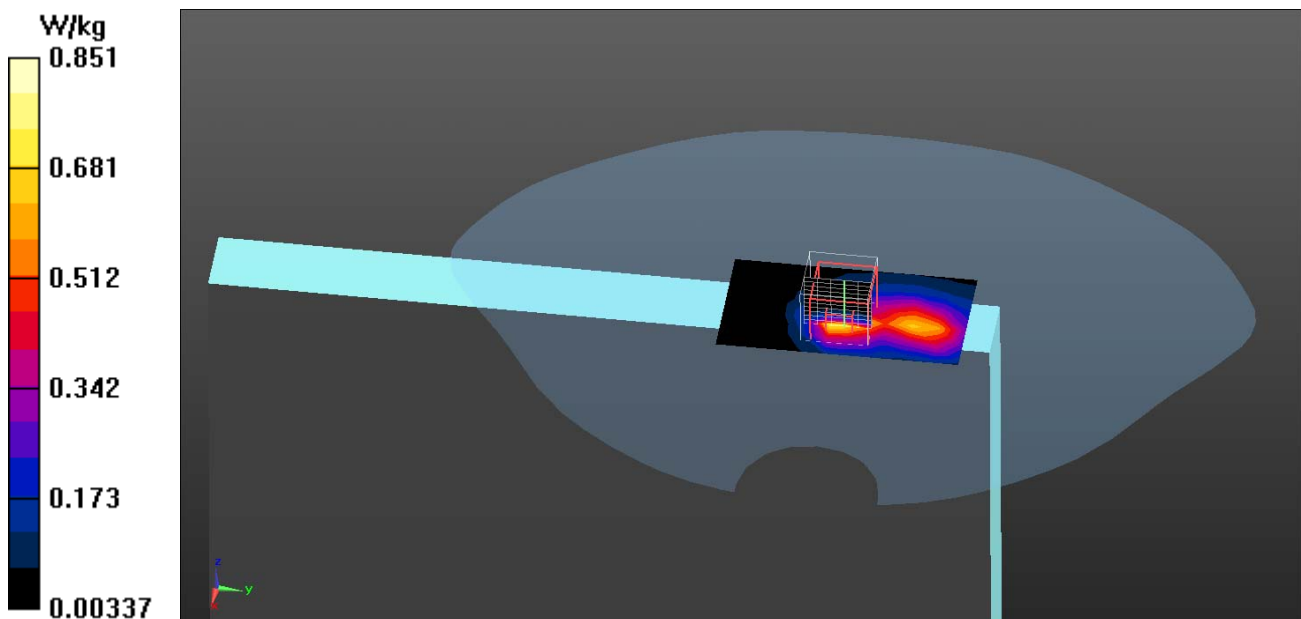

Test Laboratory: QuieTek

Date/Time: 2015/1/27

802.11a_104-Bottom TX1

DUT: TABLET PC; Type: PX-501

Communication System: UID 0, WLAN 5G; Frequency: 5520 MHz;

Communication System PAR: 0 dB

Medium parameters used: $f = 5520$ MHz; $\sigma = 5.75$ S/m; $\epsilon_r = 48.60$; $\rho = 1000$ kg/m³

Phantom section: Flat Section

Ambient Temperature (°C) : 22.1, Liquid Temperature (°C) : 20.5

Measurement Standard: DASYS (IEEE/IEC/ANSI C63.19-2007)

DASY5 Configuration:

- Probe: EX3DV4 - SN3698; ConvF(3.81, 3.81, 3.81); Calibrated: 2014/7/25;
- Sensor-Surface: 2mm (Mechanical Surface Detection)
- Electronics: DAE4 Sn1207; Calibrated: 2014/5/19
- Phantom: SAM with left table; Type: SAM;
- Measurement SW: DASYS2, Version 52.8 (8); SEMCAD X Version 14.6.10 (7331)

Configuration/Body/Area Scan (6x10x1): Measurement grid: dx=10mm, dy=10mm

Maximum value of SAR (measured) = 0.700 W/kg

Configuration/Body/Zoom Scan (6x6x12) (6x6x12)/Cube 0: Measurement grid:

dx=5mm, dy=5mm, dz=2mm

Reference Value = 8.717 V/m; Power Drift = -0.13 dB

Peak SAR (extrapolated) = 1.67 W/kg

SAR(1 g) = 0.358 W/kg; SAR(10 g) = 0.104 W/kg

Maximum value of SAR (measured) = 0.719 W/kg

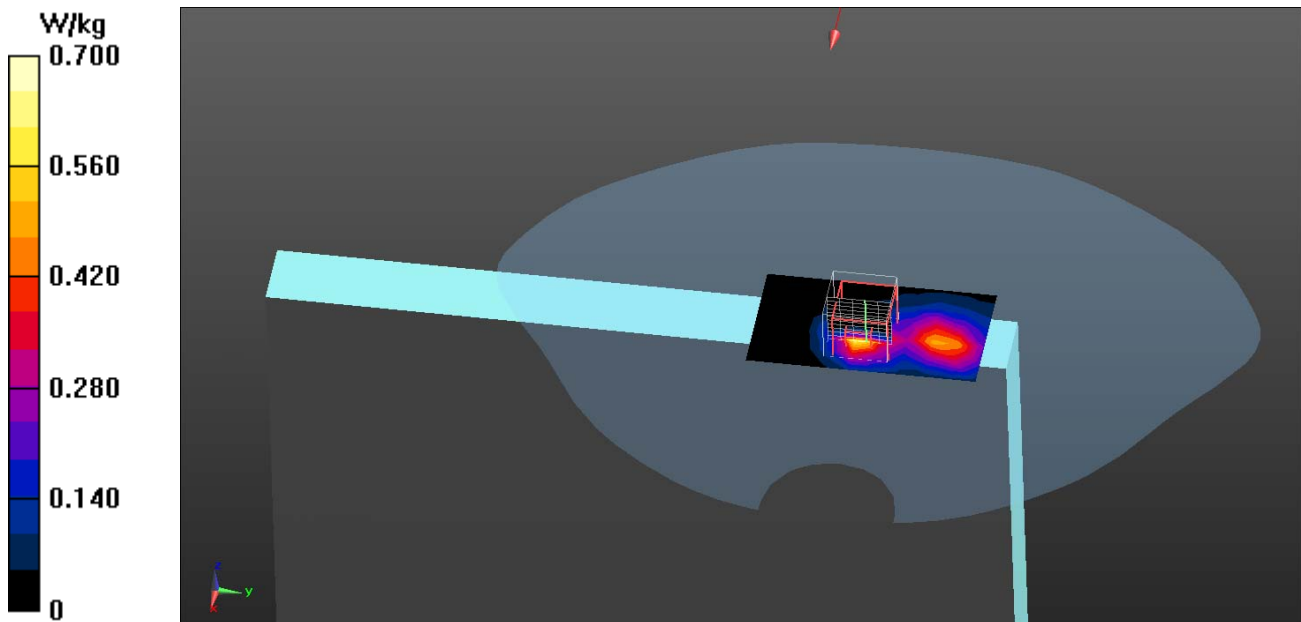

Test Laboratory: QuieTek

Date/Time: 2015/1/27

802.11a_116-Bottom TX1

DUT: TABLET PC; Type: PX-501

Communication System: UID 0, WLAN 5G; Frequency: 5580 MHz;

Communication System PAR: 0 dB

Medium parameters used: $f = 5580$ MHz; $\sigma = 5.83$ S/m; $\epsilon_r = 48.38$; $\rho = 1000$ kg/m³

Phantom section: Flat Section

Ambient Temperature (°C) : 22.1, Liquid Temperature (°C) : 20.5

Measurement Standard: DASY5 (IEEE/IEC/ANSI C63.19-2007)

DASY5 Configuration:

- Probe: EX3DV4 - SN3698; ConvF(3.64, 3.64, 3.64); Calibrated: 2014/7/25;
- Sensor-Surface: 2mm (Mechanical Surface Detection)
- Electronics: DAE4 Sn1207; Calibrated: 2014/5/19
- Phantom: SAM with left table; Type: SAM;
- Measurement SW: DASY52, Version 52.8 (8); SEMCAD X Version 14.6.10 (7331)

Configuration/Body/Area Scan (6x10x1): Measurement grid: dx=10mm, dy=10mm
 Maximum value of SAR (measured) = 0.654 W/kg

Configuration/Body/Zoom Scan (6x6x12) (6x6x12)/Cube 0: Measurement grid:
 dx=5mm, dy=5mm, dz=2mm
 Reference Value = 8.449 V/m; Power Drift = -0.12 dB
 Peak SAR (extrapolated) = 1.63 W/kg
SAR(1 g) = 0.337 W/kg; SAR(10 g) = 0.096 W/kg
 Maximum value of SAR (measured) = 0.662 W/kg

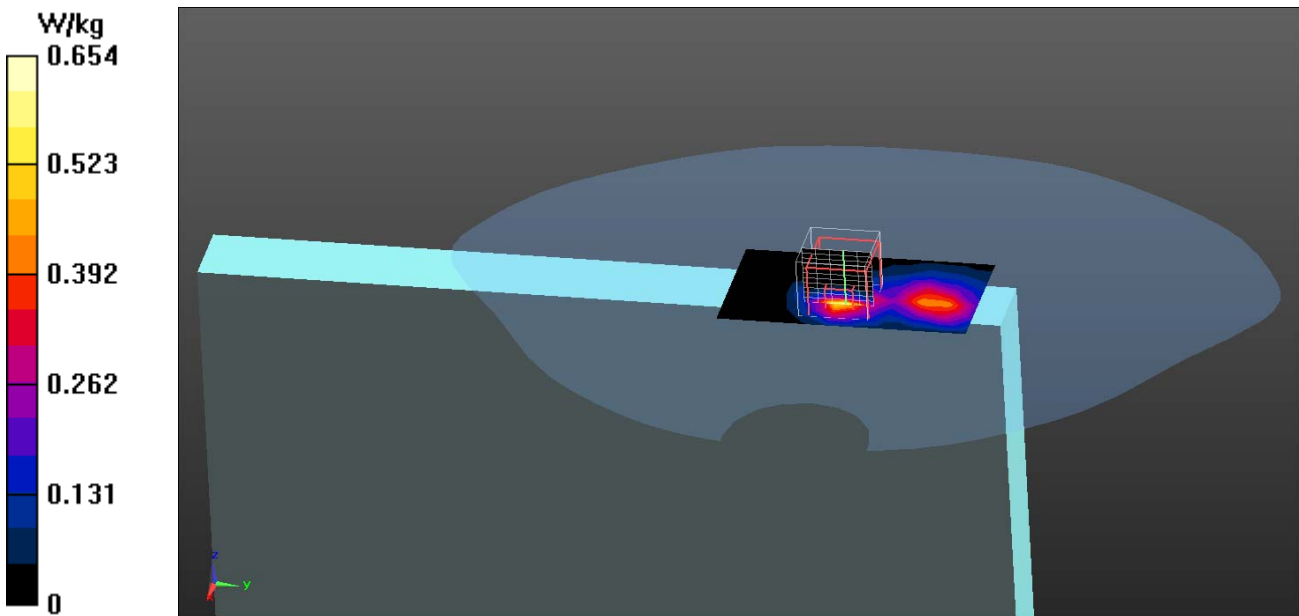

Test Laboratory: QuieTek

Date/Time: 2015/1/27

802.11a_136-Bottom TX1

DUT: TABLET PC; Type: PX-501

Communication System: UID 0, WLAN 5G; Frequency: 5680 MHz;

Communication System PAR: 0 dB

Medium parameters used: $f = 5680$ MHz; $\sigma = 5.99$ S/m; $\epsilon_r = 48.14$; $\rho = 1000$ kg/m³

Phantom section: Flat Section

Ambient Temperature (°C) : 22.1, Liquid Temperature (°C) : 20.5

Measurement Standard: DASYS (IEEE/IEC/ANSI C63.19-2007)

DASY5 Configuration:

- Probe: EX3DV4 - SN3698; ConvF(3.64, 3.64, 3.64); Calibrated: 2014/7/25;
- Sensor-Surface: 2mm (Mechanical Surface Detection)
- Electronics: DAE4 Sn1207; Calibrated: 2014/5/19
- Phantom: SAM with left table; Type: SAM;
- Measurement SW: DASYS2, Version 52.8 (8); SEMCAD X Version 14.6.10 (7331)

Configuration/Body/Area Scan (6x10x1): Measurement grid: dx=10mm, dy=10mm
 Maximum value of SAR (measured) = 1.15 W/kg

Configuration/Body/Zoom Scan (6x6x12) (6x6x12)/Cube 0: Measurement grid:
 dx=5mm, dy=5mm, dz=2mm
 Reference Value = 10.69 V/m; Power Drift = -0.18 dB
 Peak SAR (extrapolated) = 2.81 W/kg
SAR(1 g) = 0.573 W/kg; SAR(10 g) = 0.165 W/kg
 Maximum value of SAR (measured) = 1.16 W/kg

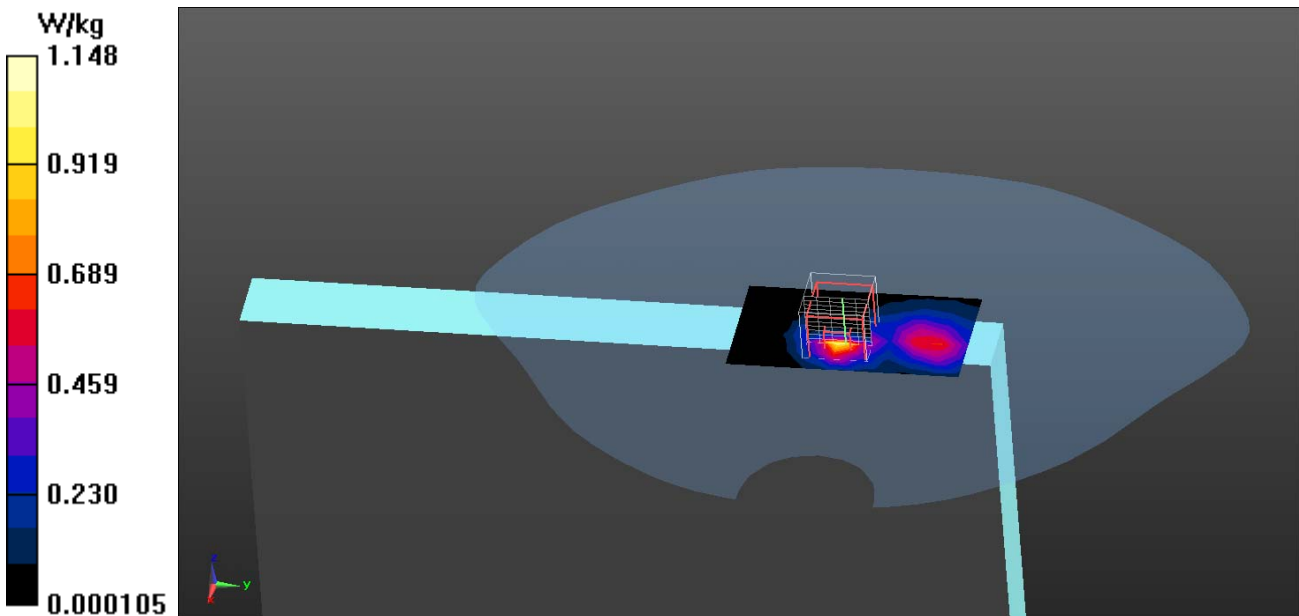

Test Laboratory: QuieTek

Date/Time: 2015/1/27

802.11a_149-Bottom TX1

DUT: TABLET PC; Type: PX-501

Communication System: UID 0, WLAN 5G; Frequency: 5745 MHz;

Communication System PAR: 0 dB

Medium parameters used: $f = 5745 \text{ MHz}$; $\sigma = 6.19 \text{ S/m}$; $\epsilon_r = 48.02$; $\rho = 1000 \text{ kg/m}^3$

Phantom section: Flat Section

Ambient Temperature ($^{\circ}\text{C}$) : 22.1, Liquid Temperature ($^{\circ}\text{C}$) : 20.5

Measurement Standard: DASYS (IEEE/IEC/ANSI C63.19-2007)

DASY5 Configuration:

- Probe: EX3DV4 - SN3698; ConvF(3.94, 3.94, 3.94); Calibrated: 2014/7/25;
- Sensor-Surface: 2mm (Mechanical Surface Detection)
- Electronics: DAE4 Sn1207; Calibrated: 2014/5/19
- Phantom: SAM with left table; Type: SAM;
- Measurement SW: DASYS2, Version 52.8 (8); SEMCAD X Version 14.6.10 (7331)

Configuration/Body/Area Scan (6x13x1): Measurement grid: $dx=10\text{mm}$, $dy=10\text{mm}$

Maximum value of SAR (measured) = 0.784 W/kg

Configuration/Body/Zoom Scan (6x6x12) (6x6x12)/Cube 0: Measurement grid:

$dx=5\text{mm}$, $dy=5\text{mm}$, $dz=2\text{mm}$

Reference Value = 13.56 V/m; Power Drift = -0.16 dB

Peak SAR (extrapolated) = 2.17 W/kg

SAR(1 g) = 0.478 W/kg; SAR(10 g) = 0.136 W/kg

Maximum value of SAR (measured) = 0.931 W/kg

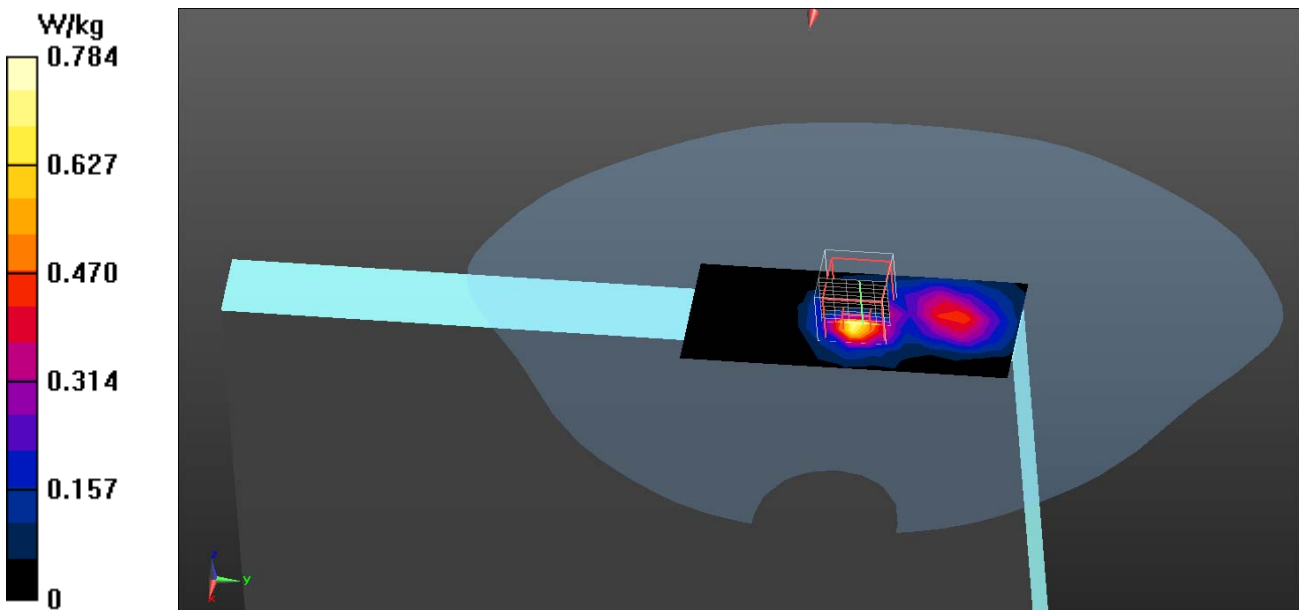

Test Laboratory: QuieTek

Date/Time: 2015/1/27

802.11a_157-Bottom TX1

DUT: TABLET PC; Type: PX-501

Communication System: UID 0, WLAN 5G; Frequency: 5785 MHz;

Communication System PAR: 0 dB

Medium parameters used: $f = 5785 \text{ MHz}$; $\sigma = 6.24 \text{ S/m}$; $\epsilon_r = 47.92$; $\rho = 1000 \text{ kg/m}^3$

Phantom section: Flat Section

Ambient Temperature ($^{\circ}\text{C}$) : 22.1, Liquid Temperature ($^{\circ}\text{C}$) : 20.5

Measurement Standard: DASYS (IEEE/IEC/ANSI C63.19-2007)

DASY5 Configuration:

- Probe: EX3DV4 - SN3698; ConvF(3.94, 3.94, 3.94); Calibrated: 2014/7/25;
- Sensor-Surface: 2mm (Mechanical Surface Detection)
- Electronics: DAE4 Sn1207; Calibrated: 2014/5/19
- Phantom: SAM with left table; Type: SAM;
- Measurement SW: DASYS2, Version 52.8 (8); SEMCAD X Version 14.6.10 (7331)

Configuration/Body/Area Scan (6x10x1): Measurement grid: $dx=10\text{mm}$, $dy=10\text{mm}$
 Maximum value of SAR (measured) = 0.959 W/kg

Configuration/Body/Zoom Scan (6x6x12) (6x6x12)/Cube 0: Measurement grid:
 $dx=5\text{mm}$, $dy=5\text{mm}$, $dz=2\text{mm}$
 Reference Value = 12.93 V/m; Power Drift = -0.13 dB
 Peak SAR (extrapolated) = 2.30 W/kg
SAR(1 g) = 0.489 W/kg; SAR(10 g) = 0.140 W/kg
 Maximum value of SAR (measured) = 0.946 W/kg

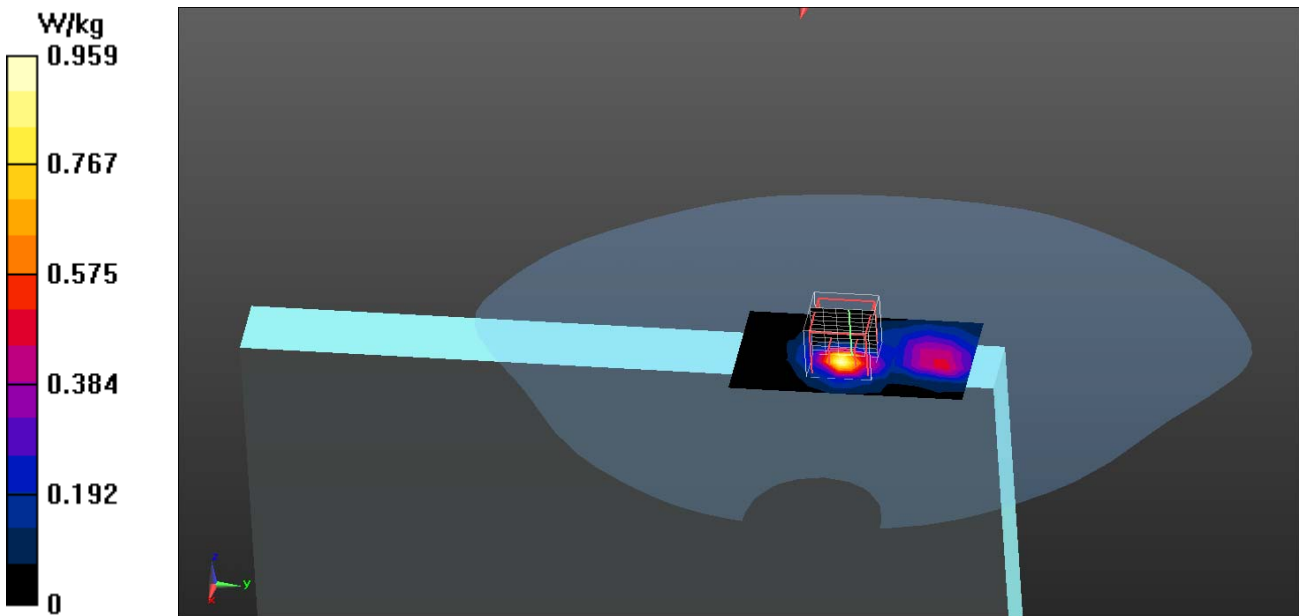

Test Laboratory: QuieTek

Date/Time: 2015/1/27

802.11a_165-Bottom TX1

DUT: TABLET PC; Type: PX-501

Communication System: UID 0, WLAN 5G; Frequency: 5825 MHz;

Communication System PAR: 0 dB

Medium parameters used: $f = 5825 \text{ MHz}$; $\sigma = 6.3 \text{ S/m}$; $\epsilon_r = 47.82$; $\rho = 1000 \text{ kg/m}^3$

Phantom section: Flat Section

Ambient Temperature ($^{\circ}\text{C}$) : 22.1, Liquid Temperature ($^{\circ}\text{C}$) : 20.5

Measurement Standard: DASYS (IEEE/IEC/ANSI C63.19-2007)

DASY5 Configuration:

- Probe: EX3DV4 - SN3698; ConvF(3.94, 3.94, 3.94); Calibrated: 2014/7/25;
- Sensor-Surface: 2mm (Mechanical Surface Detection)
- Electronics: DAE4 Sn1207; Calibrated: 2014/5/19
- Phantom: SAM with left table; Type: SAM;
- Measurement SW: DASYS2, Version 52.8 (8); SEMCAD X Version 14.6.10 (7331)

Configuration/Body/Area Scan (6x10x1): Measurement grid: dx=10mm, dy=10mm
 Maximum value of SAR (measured) = 0.921 W/kg

Configuration/Body/Zoom Scan (6x6x12) (6x6x12)/Cube 0: Measurement grid:
 dx=5mm, dy=5mm, dz=2mm
 Reference Value = 12.49 V/m; Power Drift = -0.05 dB
 Peak SAR (extrapolated) = 2.17 W/kg
SAR(1 g) = 0.471 W/kg; SAR(10 g) = 0.134 W/kg
 Maximum value of SAR (measured) = 0.933 W/kg

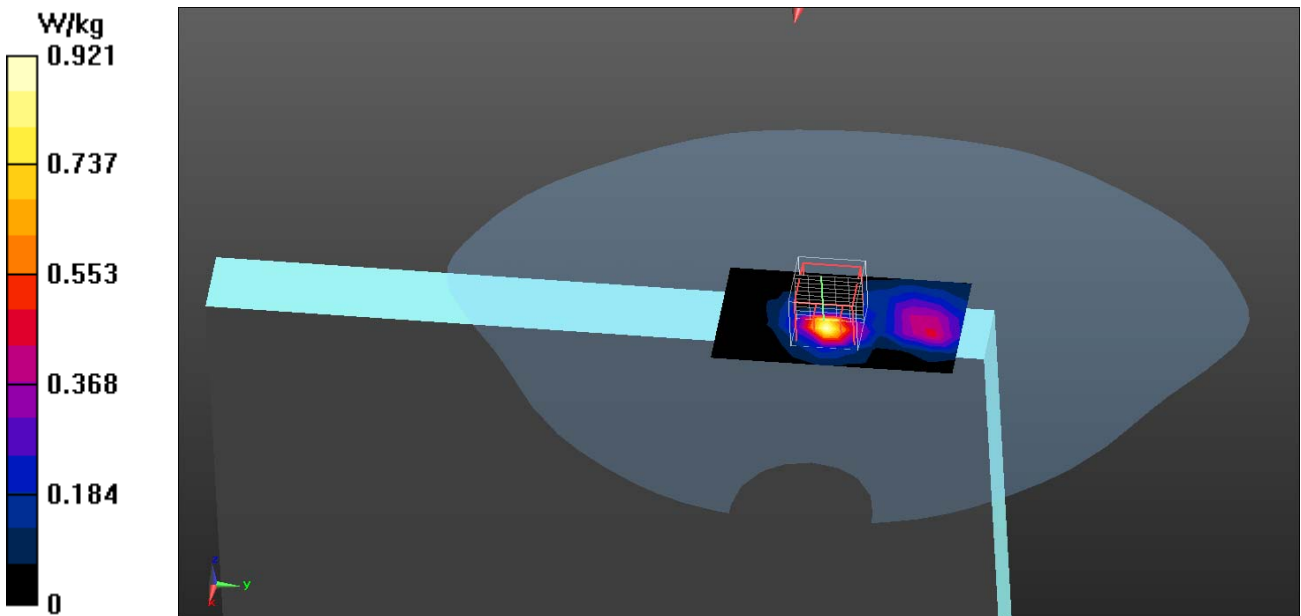

Test Laboratory: QuieTek

Date/Time: 2015/1/27

802.11a_149-Top TX2

DUT: TABLET PC; Type: PX-501

Communication System: UID 0, WLAN 5G; Frequency: 5745 MHz;

Communication System PAR: 0 dB

Medium parameters used: $f = 5745$ MHz; $\sigma = 6.19$ S/m; $\epsilon_r = 48.02$; $\rho = 1000$ kg/m³

Phantom section: Flat Section

Ambient Temperature (°C) : 22.1, Liquid Temperature (°C) : 20.5

Measurement Standard: DASY5 (IEEE/IEC/ANSI C63.19-2007)

DASY5 Configuration:

- Probe: EX3DV4 - SN3698; ConvF(3.94, 3.94, 3.94); Calibrated: 2014/7/25;
- Sensor-Surface: 2mm (Mechanical Surface Detection)
- Electronics: DAE4 Sn1207; Calibrated: 2014/5/19
- Phantom: SAM with left table; Type: SAM;
- Measurement SW: DASY52, Version 52.8 (8); SEMCAD X Version 14.6.10 (7331)

Configuration/Body/Area Scan (7x12x1): Measurement grid: dx=10mm, dy=10mm
 Maximum value of SAR (measured) = 0.734 W/kg

Configuration/Body/Zoom Scan (6x6x12) (6x6x12)/Cube 0: Measurement grid:
 dx=5mm, dy=5mm, dz=2mm
 Reference Value = 5.263 V/m; Power Drift = 0.15 dB
 Peak SAR (extrapolated) = 1.55 W/kg
SAR(1 g) = 0.406 W/kg; SAR(10 g) = 0.152 W/kg
 Maximum value of SAR (measured) = 0.746 W/kg

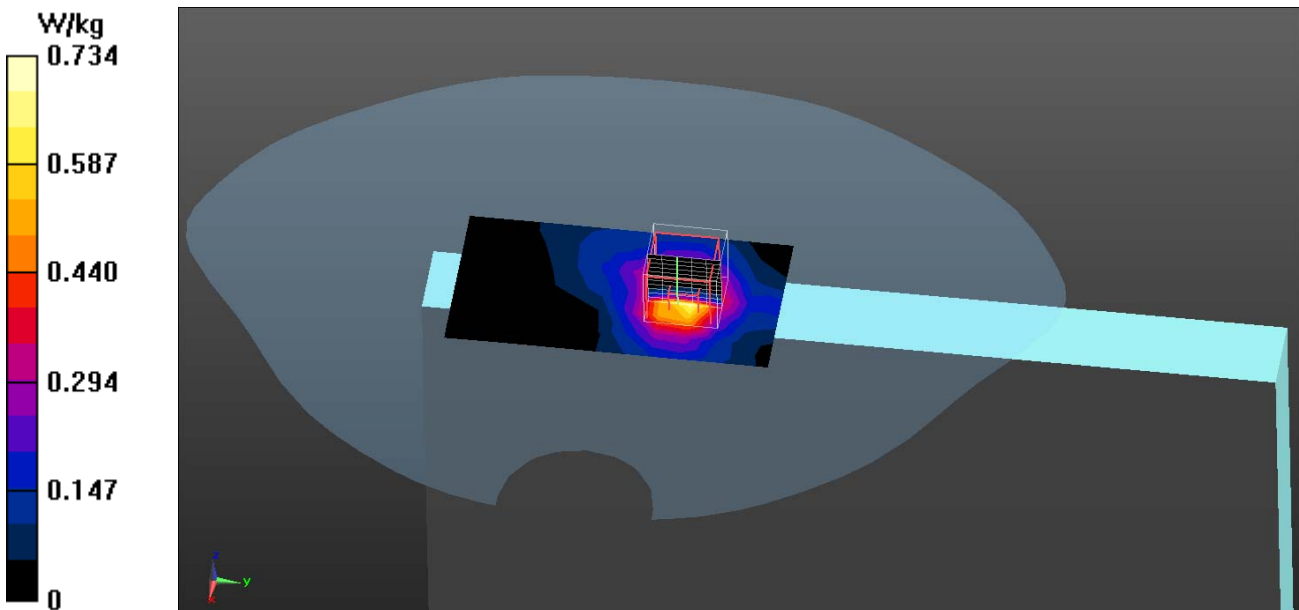

Test Laboratory: QuieTek

Date/Time: 2015/1/27

802.11a_149-Back TX2

DUT: TABLET PC; Type: PX-501

Communication System: UID 0, WLAN 5G; Frequency: 5745 MHz;

Communication System PAR: 0 dB

Medium parameters used: $f = 5745 \text{ MHz}$; $\sigma = 6.19 \text{ S/m}$; $\epsilon_r = 48.02$; $\rho = 1000 \text{ kg/m}^3$

Phantom section: Flat Section

Ambient Temperature ($^{\circ}\text{C}$) : 22.1, Liquid Temperature ($^{\circ}\text{C}$) : 20.5

Measurement Standard: DASYS (IEEE/IEC/ANSI C63.19-2007)

DASY5 Configuration:

- Probe: EX3DV4 - SN3698; ConvF(3.94, 3.94, 3.94); Calibrated: 2014/7/25;
- Sensor-Surface: 2mm (Mechanical Surface Detection)
- Electronics: DAE4 Sn1207; Calibrated: 2014/5/19
- Phantom: SAM with left table; Type: SAM;
- Measurement SW: DASYS2, Version 52.8 (8); SEMCAD X Version 14.6.10 (7331)

Configuration/Body/Area Scan (11x18x1): Measurement grid: $dx=10\text{mm}$, $dy=10\text{mm}$

Maximum value of SAR (measured) = 0.798 W/kg

Configuration/Body/Zoom Scan (6x6x12) (6x6x12)/Cube 0: Measurement grid: $dx=5\text{mm}$, $dy=5\text{mm}$, $dz=2\text{mm}$

Reference Value = 6.310 V/m; Power Drift = 0.13 dB

Peak SAR (extrapolated) = 1.92 W/kg

SAR(1 g) = 0.442 W/kg; SAR(10 g) = 0.138 W/kg

Maximum value of SAR (measured) = 0.862 W/kg

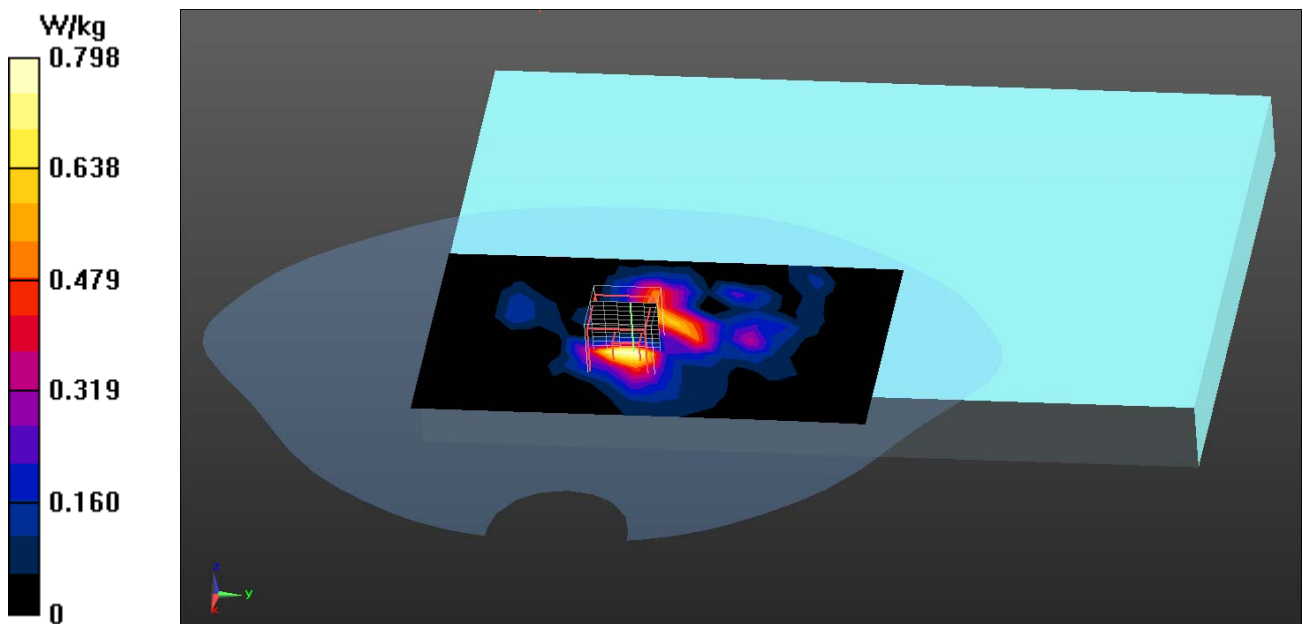

Test Laboratory: QuieTek

Date/Time: 2015/1/27

802.11a_149-Left-Side TX2

DUT: TABLET PC; Type: PX-501

Communication System: UID 0, WLAN 5G; Frequency: 5745 MHz;

Communication System PAR: 0 dB

Medium parameters used: $f = 5745 \text{ MHz}$; $\sigma = 6.19 \text{ S/m}$; $\epsilon_r = 48.02$; $\rho = 1000 \text{ kg/m}^3$

Phantom section: Flat Section

Ambient Temperature ($^{\circ}\text{C}$) : 22.1, Liquid Temperature ($^{\circ}\text{C}$) : 20.5

Measurement Standard: DASYS (IEEE/IEC/ANSI C63.19-2007)

DASY5 Configuration:

- Probe: EX3DV4 - SN3698; ConvF(3.94, 3.94, 3.94); Calibrated: 2014/7/25;
- Sensor-Surface: 2mm (Mechanical Surface Detection)
- Electronics: DAE4 Sn1207; Calibrated: 2014/5/19
- Phantom: SAM with left table; Type: SAM;
- Measurement SW: DASYS2, Version 52.8 (8); SEMCAD X Version 14.6.10 (7331)

Configuration/Body/Area Scan (4x21x1): Measurement grid: $dx=10\text{mm}$, $dy=10\text{mm}$

Maximum value of SAR (measured) = 0.0243 W/kg

Configuration/Body/Zoom Scan (6x6x12) (6x6x12)/Cube 0: Measurement grid:

$dx=5\text{mm}$, $dy=5\text{mm}$, $dz=2\text{mm}$

Reference Value = 0 V/m; Power Drift = 0.03 dB

Peak SAR (extrapolated) = 0.0810 W/kg

SAR(1 g) = 0.00581 W/kg; SAR(10 g) = 0.00146 W/kg

Maximum value of SAR (measured) = 0.0360 W/kg

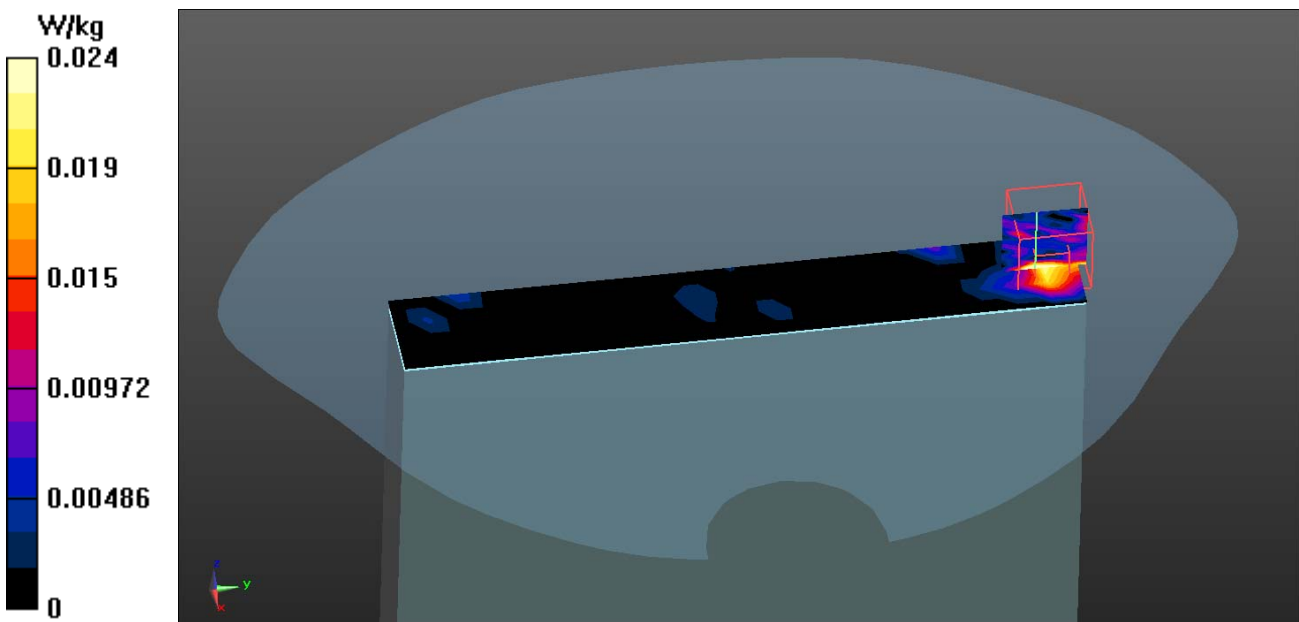

Test Laboratory: QuieTek

Date/Time: 2015/1/27

802.11n-20M_136-Bottom TX1

DUT: TABLET PC; Type: PX-501

Communication System: UID 0, WLAN 5G; Frequency: 5680 MHz;

Communication System PAR: 0 dB

Medium parameters used: $f = 5680$ MHz; $\sigma = 5.99$ S/m; $\epsilon_r = 48.14$; $\rho = 1000$ kg/m³

Phantom section: Flat Section

Ambient Temperature (°C) : 22.1, Liquid Temperature (°C) : 20.5

Measurement Standard: DASYS (IEEE/IEC/ANSI C63.19-2007)

DASY5 Configuration:

- Probe: EX3DV4 - SN3698; ConvF(3.64, 3.64, 3.64); Calibrated: 2014/7/25;
- Sensor-Surface: 2mm (Mechanical Surface Detection)
- Electronics: DAE4 Sn1207; Calibrated: 2014/5/19
- Phantom: SAM with left table; Type: SAM;
- Measurement SW: DASYS2, Version 52.8 (8); SEMCAD X Version 14.6.10 (7331)

Configuration/Body/Area Scan (6x13x1): Measurement grid: dx=10mm, dy=10mm
 Maximum value of SAR (measured) = 0.460 W/kg

Configuration/Body/Zoom Scan (6x6x12) (6x6x12)/Cube 0: Measurement grid:
 dx=5mm, dy=5mm, dz=2mm
 Reference Value = 9.352 V/m; Power Drift = -0.12 dB
 Peak SAR (extrapolated) = 1.37 W/kg
SAR(1 g) = 0.240 W/kg; SAR(10 g) = 0.067 W/kg
 Maximum value of SAR (measured) = 0.498 W/kg

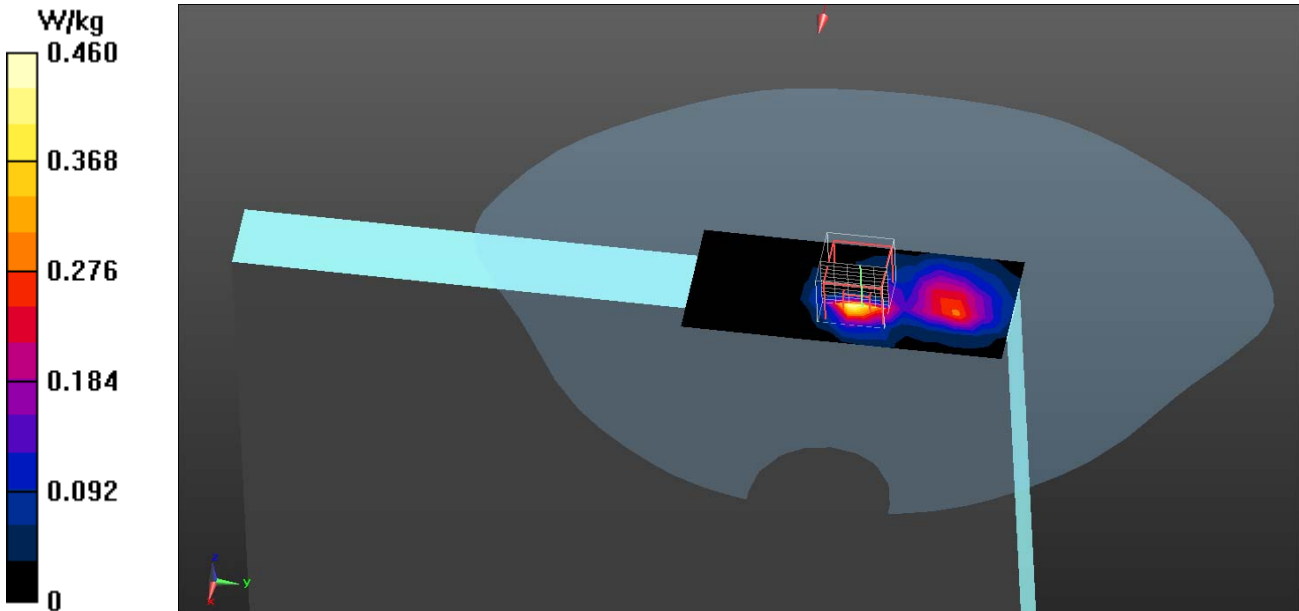

Test Laboratory: QuieTek

Date/Time: 2015/1/27

802.11n-20M_136-Back TX2

DUT: TABLET PC; Type: PX-501

Communication System: UID 0, WLAN 5G; Frequency: 5680 MHz;

Communication System PAR: 0 dB

Medium parameters used: $f = 5680$ MHz; $\sigma = 5.99$ S/m; $\epsilon_r = 48.14$; $\rho = 1000$ kg/m³

Phantom section: Flat Section

Ambient Temperature (°C) : 22.1, Liquid Temperature (°C) : 20.5

Measurement Standard: DASY5 (IEEE/IEC/ANSI C63.19-2007)

DASY5 Configuration:

- Probe: EX3DV4 - SN3698; ConvF(3.64, 3.64, 3.64); Calibrated: 2014/7/25;
- Sensor-Surface: 2mm (Mechanical Surface Detection)
- Electronics: DAE4 Sn1207; Calibrated: 2014/5/19
- Phantom: SAM with left table; Type: SAM;
- Measurement SW: DASY52, Version 52.8 (8); SEMCAD X Version 14.6.10 (7331)

Configuration/Body/Area Scan (9x15x1): Measurement grid: dx=10mm, dy=10mm
 Maximum value of SAR (measured) = 0.457 W/kg

Configuration/Body/Zoom Scan (6x6x12) (6x6x12)/Cube 0: Measurement grid:
 dx=5mm, dy=5mm, dz=2mm
 Reference Value = 8.253 V/m; Power Drift = -0.11 dB
 Peak SAR (extrapolated) = 0.988 W/kg
SAR(1 g) = 0.259 W/kg; SAR(10 g) = 0.086 W/kg
 Maximum value of SAR (measured) = 0.516 W/kg

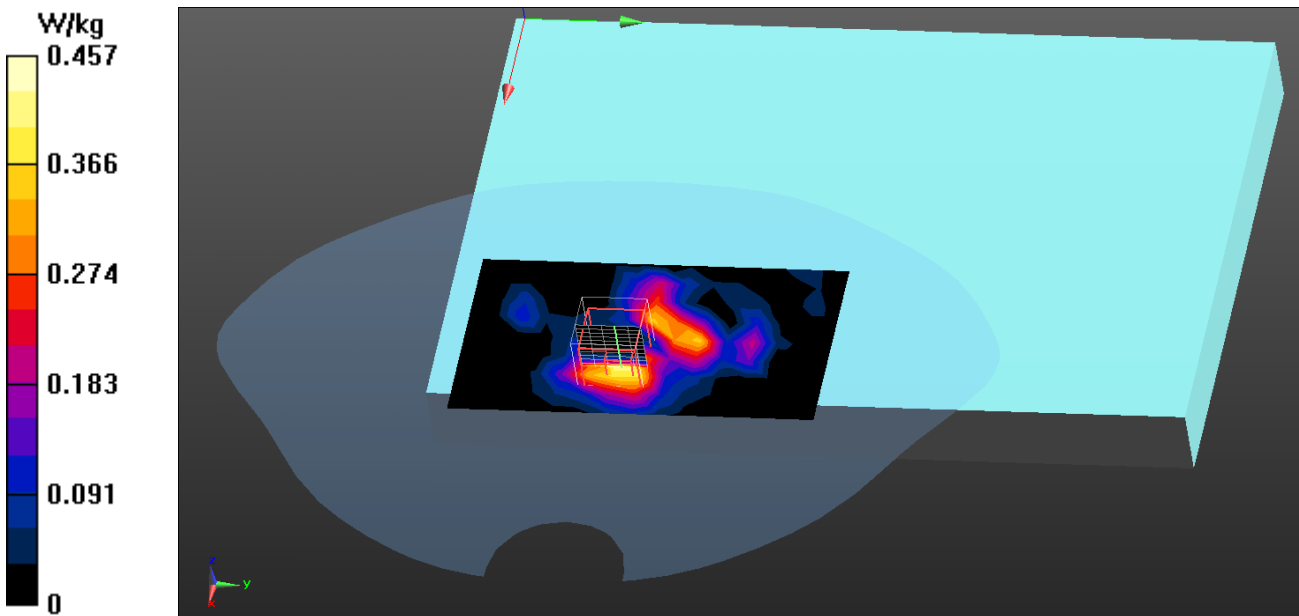

Test Laboratory: QuieTek

Date/Time: 2015/1/27

802.11n-40M_110-Bottom TX1

DUT: TABLET PC; Type: PX-501

Communication System: UID 0, WLAN 5G; Frequency: 5550 MHz;

Communication System PAR: 0 dB

Medium parameters used: $f = 5550 \text{ MHz}$; $\sigma = 5.81 \text{ S/m}$; $\epsilon_r = 48.54$; $\rho = 1000 \text{ kg/m}^3$

Phantom section: Flat Section

Ambient Temperature ($^{\circ}\text{C}$) : 22.1, Liquid Temperature ($^{\circ}\text{C}$) : 20.5

Measurement Standard: DASYS (IEEE/IEC/ANSI C63.19-2007)

DASY5 Configuration:

- Probe: EX3DV4 - SN3698; ConvF(3.64, 3.64, 3.64); Calibrated: 2014/7/25;
- Sensor-Surface: 2mm (Mechanical Surface Detection)
- Electronics: DAE4 Sn1207; Calibrated: 2014/5/19
- Phantom: SAM with left table; Type: SAM;
- Measurement SW: DASYS2, Version 52.8 (8); SEMCAD X Version 14.6.10 (7331)

Configuration/Body/Area Scan (6x13x1): Measurement grid: $dx=10\text{mm}$, $dy=10\text{mm}$
 Maximum value of SAR (measured) = 0.375 W/kg

Configuration/Body/Zoom Scan (6x6x12) (6x6x12)/Cube 0: Measurement grid:
 $dx=5\text{mm}$, $dy=5\text{mm}$, $dz=2\text{mm}$
 Reference Value = 5.956 V/m; Power Drift = -0.11 dB
 Peak SAR (extrapolated) = 0.715 W/kg
SAR(1 g) = 0.182 W/kg; SAR(10 g) = 0.053 W/kg
 Maximum value of SAR (measured) = 0.388 W/kg

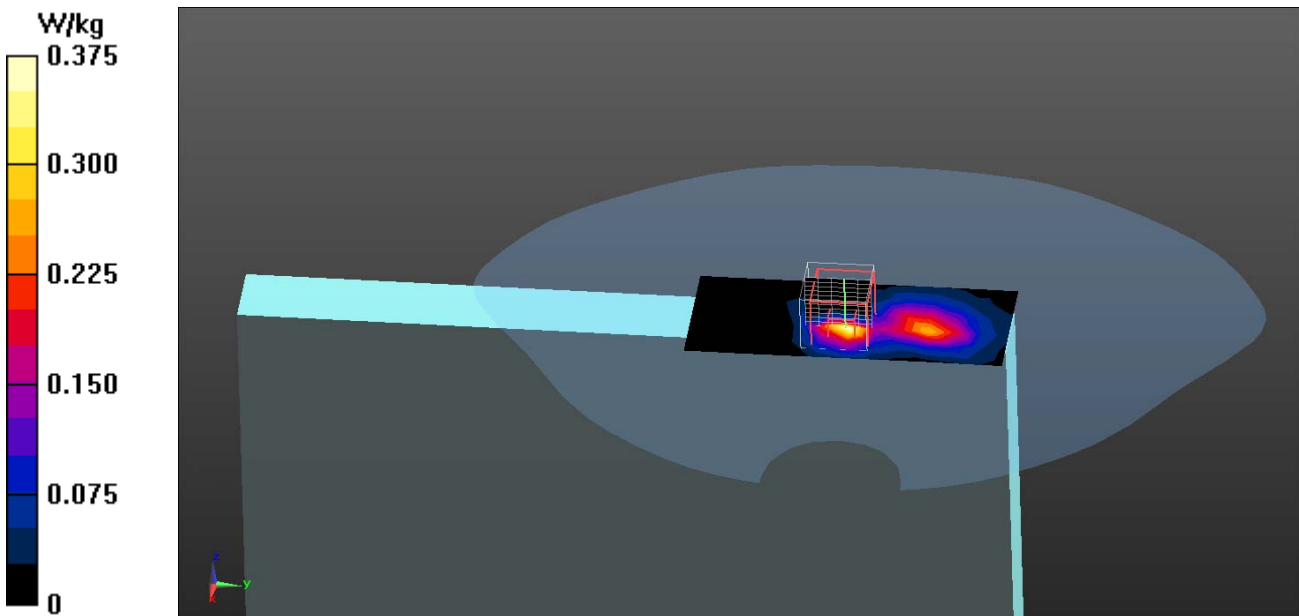

Test Laboratory: QuieTek

Date/Time: 2015/1/27

802.11n-40M_110-Back TX2

DUT: TABLET PC; Type: PX-501

Communication System: UID 0, WLAN 5G; Frequency: 5550 MHz;

Communication System PAR: 0 dB

Medium parameters used: $f = 5550$ MHz; $\sigma = 5.81$ S/m; $\epsilon_r = 48.54$; $\rho = 1000$ kg/m³

Phantom section: Flat Section

Ambient Temperature (°C) : 22.1, Liquid Temperature (°C) : 20.5

Measurement Standard: DASYS (IEEE/IEC/ANSI C63.19-2007)

DASY5 Configuration:

- Probe: EX3DV4 - SN3698; ConvF(3.64, 3.64, 3.64); Calibrated: 2014/7/25;
- Sensor-Surface: 2mm (Mechanical Surface Detection)
- Electronics: DAE4 Sn1207; Calibrated: 2014/5/19
- Phantom: SAM with left table; Type: SAM;
- Measurement SW: DASYS2, Version 52.8 (8); SEMCAD X Version 14.6.10 (7331)

Configuration/Body/Area Scan (9x15x1): Measurement grid: dx=10mm, dy=10mm

Maximum value of Ux (measured) = 78.24 uV

Configuration/Body/Zoom Scan (6x6x12) (6x6x12)/Cube 0: Measurement grid:

dx=5mm, dy=5mm, dz=2mm

Reference Value = 8.793 V/m; Power Drift = 0.04 dB

Peak SAR (extrapolated) = 0.758 W/kg

SAR(1 g) = 0.189 W/kg; SAR(10 g) = 0.064 W/kg

Maximum value of SAR (measured) = 0.414 W/kg

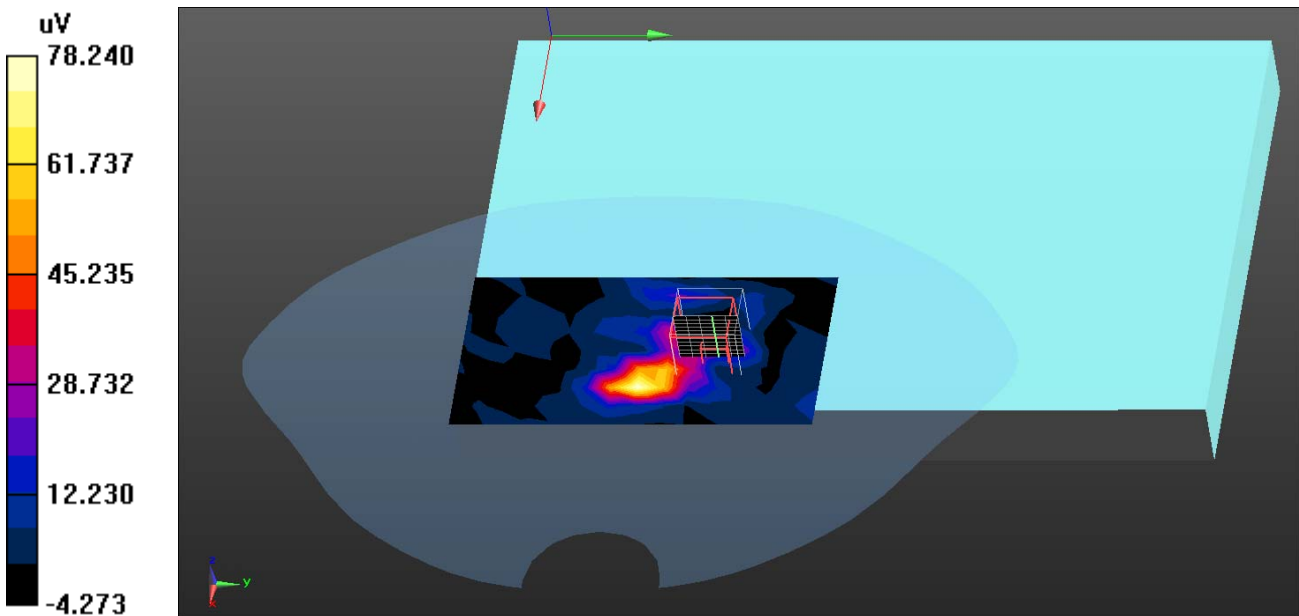

Test Laboratory: QuieTek

Date/Time: 2015/1/27

802.11ac-80M_122-Bottom TX1

DUT: TABLET PC; Type: PX-501

Communication System: UID 0, WLAN 5G; Frequency: 5610 MHz;

Communication System PAR: 0 dB

Medium parameters used: $f = 5610$ MHz; $\sigma = 5.87$ S/m; $\epsilon_r = 48.29$; $\rho = 1000$ kg/m³

Phantom section: Flat Section

Ambient Temperature (°C) : 22.1, Liquid Temperature (°C) : 20.5

Measurement Standard: DASYS (IEEE/IEC/ANSI C63.19-2007)

DASY5 Configuration:

- Probe: EX3DV4 - SN3698; ConvF(3.64, 3.64, 3.64); Calibrated: 2014/7/25;
- Sensor-Surface: 2mm (Mechanical Surface Detection)
- Electronics: DAE4 Sn1207; Calibrated: 2014/5/19
- Phantom: SAM with left table; Type: SAM;
- Measurement SW: DASYS2, Version 52.8 (8); SEMCAD X Version 14.6.10 (7331)

Configuration/Body/Area Scan (6x13x1): Measurement grid: dx=10mm, dy=10mm

Maximum value of SAR (measured) = 0.394 W/kg

Configuration/Body/Zoom Scan (6x6x12) (6x6x12)/Cube 0: Measurement grid:

dx=5mm, dy=5mm, dz=2mm

Reference Value = 9.418 V/m; Power Drift = 0.08 dB

Peak SAR (extrapolated) = 1.03 W/kg

SAR(1 g) = 0.224 W/kg; SAR(10 g) = 0.062 W/kg

Maximum value of SAR (measured) = 0.447 W/kg

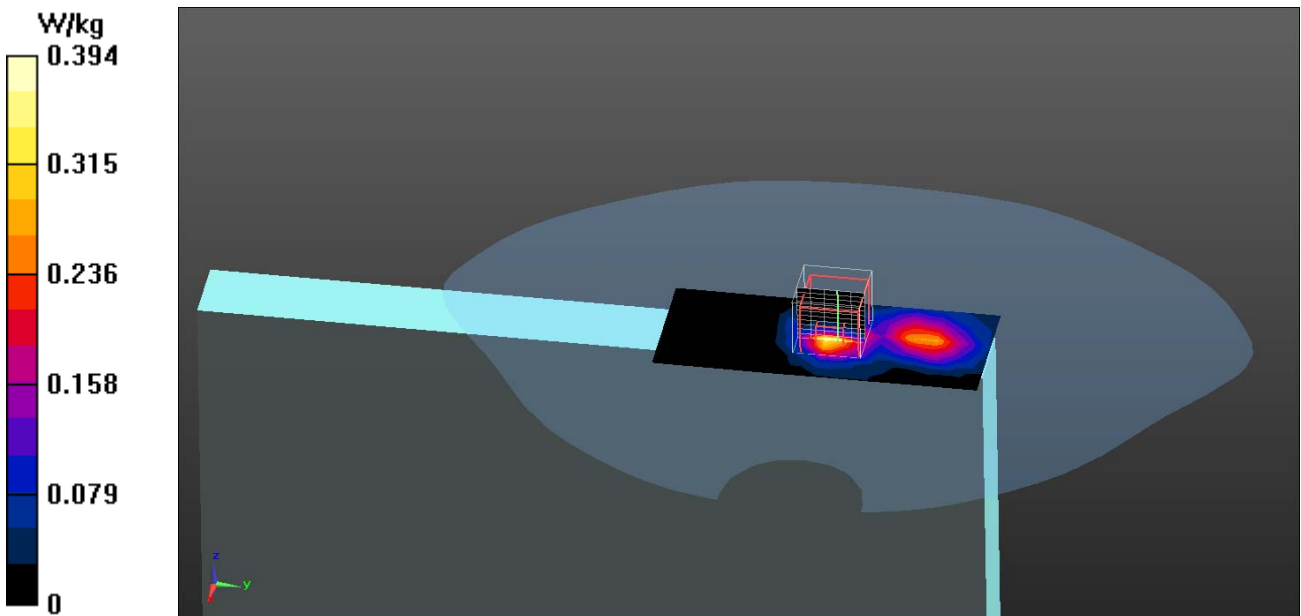

Test Laboratory: QuieTek

Date/Time: 2015/1/27

802.11ac-80M_122-Back TX2

DUT: TABLET PC; Type: PX-501

Communication System: UID 0, WLAN 5G; Frequency: 5610 MHz;

Communication System PAR: 0 dB

Medium parameters used: $f = 5610$ MHz; $\sigma = 5.87$ S/m; $\epsilon_r = 48.29$; $\rho = 1000$ kg/m³

Phantom section: Flat Section

Ambient Temperature (°C) : 22.1, Liquid Temperature (°C) : 20.5

Measurement Standard: DASYS (IEEE/IEC/ANSI C63.19-2007)

DASY5 Configuration:

- Probe: EX3DV4 - SN3698; ConvF(3.64, 3.64, 3.64); Calibrated: 2014/7/25;
- Sensor-Surface: 2mm (Mechanical Surface Detection)
- Electronics: DAE4 Sn1207; Calibrated: 2014/5/19
- Phantom: SAM with left table; Type: SAM;
- Measurement SW: DASY52, Version 52.8 (8); SEMCAD X Version 14.6.10 (7331)

Configuration/Body/Area Scan (9x15x1): Measurement grid: dx=10mm, dy=10mm
 Maximum value of SAR (measured) = 0.308 W/kg

Configuration/Body/Zoom Scan (6x6x12) (6x6x12)/Cube 0: Measurement grid:
 dx=5mm, dy=5mm, dz=2mm
 Reference Value = 6.310 V/m; Power Drift = 0.13 dB
 Peak SAR (extrapolated) = 0.744 W/kg
SAR(1 g) = 0.184 W/kg; SAR(10 g) = 0.061 W/kg
 Maximum value of SAR (measured) = 0.359 W/kg

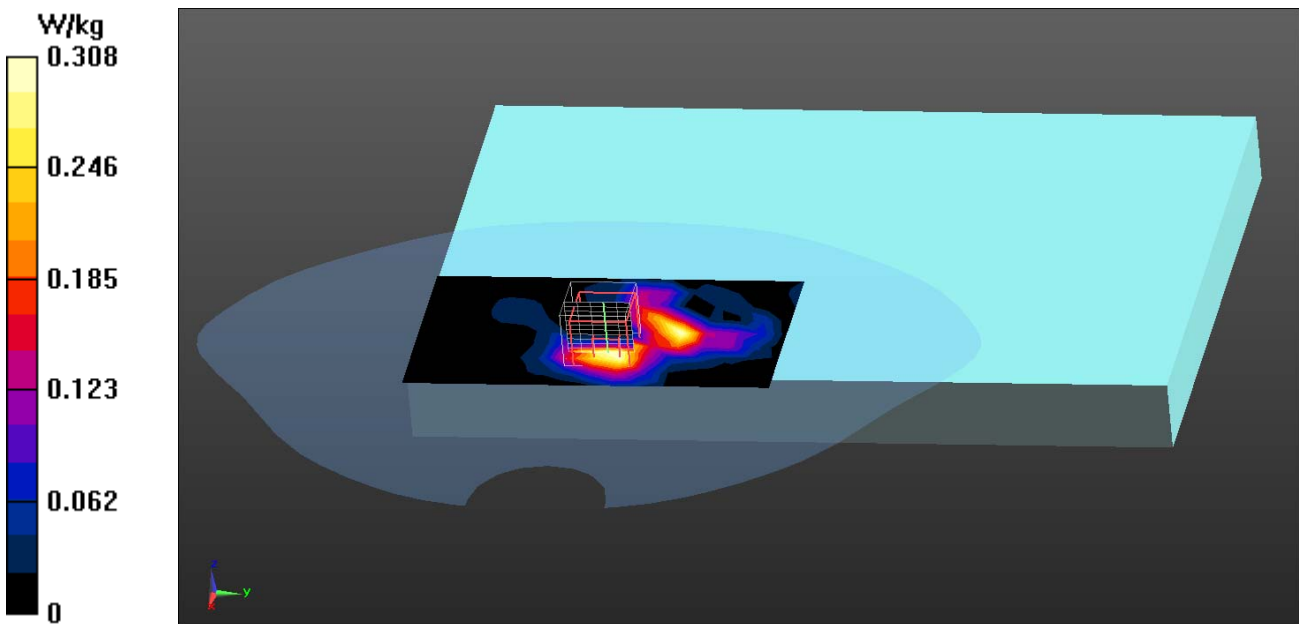

802.11a EUT Bottom (TX1), Z-Axis plot

Channel: 136

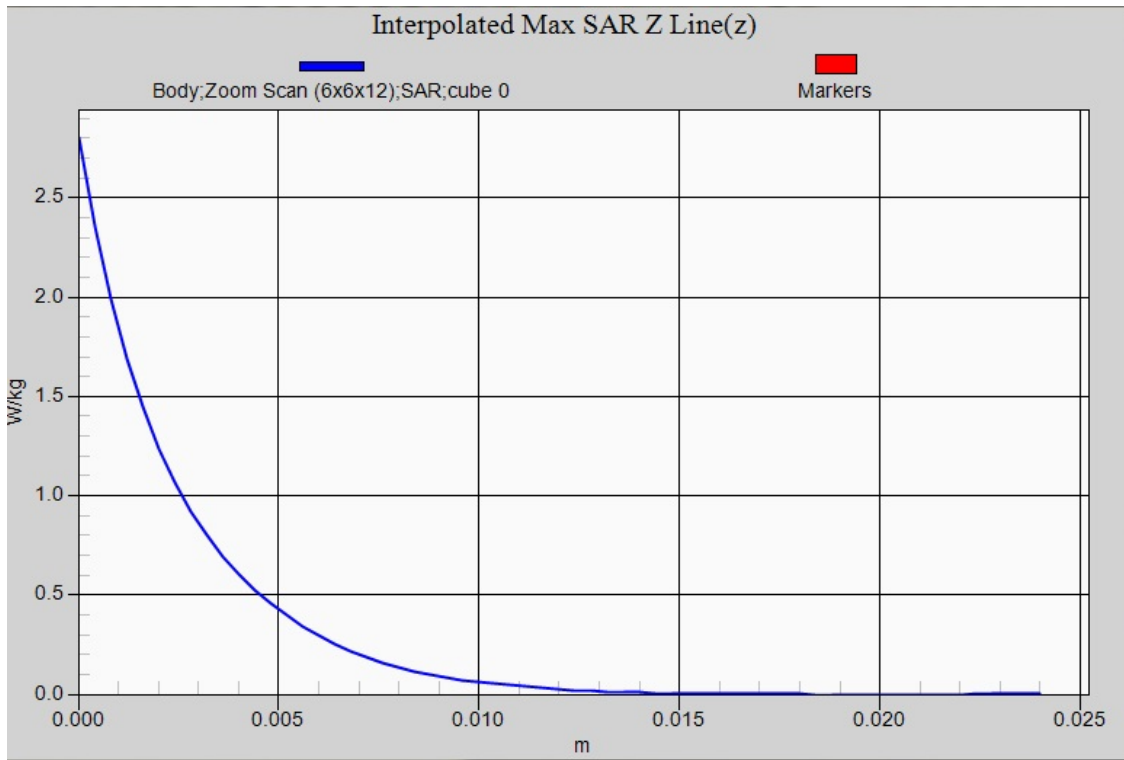



Appendix D. Probe Calibration Data

Object: EX3DV4- SN: 3979



Accredited by the Swiss Accreditation Service (SAS)
The Swiss Accreditation Service is one of the signatories to the EA
Multilateral Agreement for the recognition of calibration certificates

Accreditation No.: **SCS 108**

Client **Quietek-TW (Auden)**

Certificate No: **EX3-3979_Nov14**

CALIBRATION CERTIFICATE

Object **EX3DV4 - SN:3979**

Calibration procedure(s) **QA CAL-01.v9, QA CAL-14.v4, QA CAL-23.v5, QA CAL-25.v6
Calibration procedure for dosimetric E-field probes**

Calibration date: **November 21, 2014**

This calibration certificate documents the traceability to national standards, which realize the physical units of measurements (SI).
The measurements and the uncertainties with confidence probability are given on the following pages and are part of the certificate.

All calibrations have been conducted in the closed laboratory facility: environment temperature (22 ± 3)°C and humidity < 70%.

Calibration Equipment used (M&TE critical for calibration)

Primary Standards	ID	Cal Date (Certificate No.)	Scheduled Calibration
Power meter E4419B	GB41293874	03-Apr-14 (No. 217-01911)	Apr-15
Power sensor E4412A	MY41498087	03-Apr-14 (No. 217-01911)	Apr-15
Reference 3 dB Attenuator	SN: S5054 (3c)	03-Apr-14 (No. 217-01915)	Apr-15
Reference 20 dB Attenuator	SN: S5277 (20x)	03-Apr-14 (No. 217-01919)	Apr-15
Reference 30 dB Attenuator	SN: S5129 (30b)	03-Apr-14 (No. 217-01920)	Apr-15
Reference Probe ES3DV2	SN: 3013	30-Dec-13 (No. ES3-3013_Dec13)	Dec-14
DAE4	SN: 660	13-Dec-13 (No. DAE4-660_Dec13)	Dec-14
Secondary Standards	ID	Check Date (in house)	Scheduled Check
RF generator HP 8648C	US3642U01700	4-Aug-99 (in house check Apr-13)	In house check: Apr-16
Network Analyzer HP 8753E	US37390585	18-Oct-01 (in house check Oct-14)	In house check: Oct-15

Calibrated by:	Name Jeton Kastrati	Function Laboratory Technician	Signature
Approved by:	Name Katja Pokovic	Function Technical Manager	

Issued: November 24, 2014

This calibration certificate shall not be reproduced except in full without written approval of the laboratory.



Accredited by the Swiss Accreditation Service (SAS)
The Swiss Accreditation Service is one of the signatories to the EA
Multilateral Agreement for the recognition of calibration certificates

Accreditation No.: **SCS 108**

Glossary:

TSL	tissue simulating liquid
NORM _{x,y,z}	sensitivity in free space
ConvF	sensitivity in TSL / NORM _{x,y,z}
DCP	diode compression point
CF	crest factor (1/duty_cycle) of the RF signal
A, B, C, D	modulation dependent linearization parameters
Polarization φ	φ rotation around probe axis
Polarization ϑ	ϑ rotation around an axis that is in the plane normal to probe axis (at measurement center), i.e., $\vartheta = 0$ is normal to probe axis
Connector Angle	information used in DASY system to align probe sensor X to the robot coordinate system

Calibration is Performed According to the Following Standards:

- IEEE Std 1528-2013, "IEEE Recommended Practice for Determining the Peak Spatial-Averaged Specific Absorption Rate (SAR) in the Human Head from Wireless Communications Devices: Measurement Techniques", June 2013
- IEC 62209-1, "Procedure to measure the Specific Absorption Rate (SAR) for hand-held devices used in close proximity to the ear (frequency range of 300 MHz to 3 GHz)", February 2005

Methods Applied and Interpretation of Parameters:

- NORM_{x,y,z}**: Assessed for E-field polarization $\vartheta = 0$ ($f \leq 900$ MHz in TEM-cell; $f > 1800$ MHz: R22 waveguide). NORM_{x,y,z} are only intermediate values, i.e., the uncertainties of NORM_{x,y,z} does not affect the E²-field uncertainty inside TSL (see below ConvF).
- NORM(f)_{x,y,z} = NORM_{x,y,z} * frequency_response** (see Frequency Response Chart). This linearization is implemented in DASY4 software versions later than 4.2. The uncertainty of the frequency response is included in the stated uncertainty of ConvF.
- DCP_{x,y,z}**: DCP are numerical linearization parameters assessed based on the data of power sweep with CW signal (no uncertainty required). DCP does not depend on frequency nor media.
- PAR**: PAR is the Peak to Average Ratio that is not calibrated but determined based on the signal characteristics
- A_{x,y,z}; B_{x,y,z}; C_{x,y,z}; D_{x,y,z}; VR_{x,y,z}; A, B, C, D** are numerical linearization parameters assessed based on the data of power sweep for specific modulation signal. The parameters do not depend on frequency nor media. VR is the maximum calibration range expressed in RMS voltage across the diode.
- ConvF and Boundary Effect Parameters**: Assessed in flat phantom using E-field (or Temperature Transfer Standard for $f \leq 800$ MHz) and inside waveguide using analytical field distributions based on power measurements for $f > 800$ MHz. The same setups are used for assessment of the parameters applied for boundary compensation (alpha, depth) of which typical uncertainty values are given. These parameters are used in DASY4 software to improve probe accuracy close to the boundary. The sensitivity in TSL corresponds to NORM_{x,y,z} * ConvF whereby the uncertainty corresponds to that given for ConvF. A frequency dependent ConvF is used in DASY version 4.4 and higher which allows extending the validity from ± 50 MHz to ± 100 MHz.
- Spherical isotropy (3D deviation from isotropy)**: in a field of low gradients realized using a flat phantom exposed by a patch antenna.
- Sensor Offset**: The sensor offset corresponds to the offset of virtual measurement center from the probe tip (on probe axis). No tolerance required.
- Connector Angle**: The angle is assessed using the information gained by determining the NORM_x (no uncertainty required).

Probe EX3DV4

SN:3979

Manufactured: November 5, 2013
Calibrated: November 21, 2014

Calibrated for DASY/EASY Systems
(Note: non-compatible with DASY2 system!)

DASY/EASY - Parameters of Probe: EX3DV4 - SN:3979

Basic Calibration Parameters

	Sensor X	Sensor Y	Sensor Z	Unc (k=2)
Norm ($\mu\text{V}/(\text{V}/\text{m})^2$) ^A	0.48	0.50	0.48	$\pm 10.1 \%$
DCP (mV) ^B	99.8	99.9	100.5	

Modulation Calibration Parameters

UID	Communication System Name		A dB	B dB $\sqrt{\mu\text{V}}$	C	D dB	VR mV	Unc ^E (k=2)
0	CW	X	0.0	0.0	1.0	0.00	193.1	$\pm 3.8 \%$
		Y	0.0	0.0	1.0		190.4	
		Z	0.0	0.0	1.0		184.4	

The reported uncertainty of measurement is stated as the standard uncertainty of measurement multiplied by the coverage factor $k=2$, which for a normal distribution corresponds to a coverage probability of approximately 95%.

^A The uncertainties of NormX,Y,Z do not affect the E^2 -field uncertainty inside TSL (see Pages 5 and 6).

^B Numerical linearization parameter: uncertainty not required.

^E Uncertainty is determined using the max. deviation from linear response applying rectangular distribution and is expressed for the square of the field value.

DASY/EASY - Parameters of Probe: EX3DV4 - SN:3979

Calibration Parameter Determined in Head Tissue Simulating Media

f (MHz) ^C	Relative Permittivity ^F	Conductivity (S/m) ^F	ConvF X	ConvF Y	ConvF Z	Alpha ^G	Depth (mm) ^G	Unct. (k=2)
750	41.9	0.89	9.94	9.94	9.94	0.64	0.70	± 12.0 %
835	41.5	0.90	9.50	9.50	9.50	0.27	1.16	± 12.0 %
900	41.5	0.97	9.29	9.29	9.29	0.26	1.19	± 12.0 %
1450	40.5	1.20	8.36	8.36	8.36	0.80	0.58	± 12.0 %
1640	40.3	1.29	8.08	8.08	8.08	0.68	0.78	± 12.0 %
1750	40.1	1.37	8.02	8.02	8.02	0.71	0.73	± 12.0 %
1810	40.0	1.40	7.81	7.81	7.81	0.67	0.74	± 12.0 %
1900	40.0	1.40	7.76	7.76	7.76	0.56	0.83	± 12.0 %
2000	40.0	1.40	7.78	7.78	7.78	0.62	0.76	± 12.0 %
2300	39.5	1.67	7.38	7.38	7.38	0.44	0.87	± 12.0 %
2450	39.2	1.80	7.09	7.09	7.09	0.43	0.88	± 12.0 %
2600	39.0	1.96	6.90	6.90	6.90	0.42	0.97	± 12.0 %
3500	37.9	2.91	7.19	7.19	7.19	0.77	0.66	± 13.1 %
5200	36.0	4.66	4.88	4.88	4.88	0.35	1.80	± 13.1 %
5300	35.9	4.76	4.69	4.69	4.69	0.35	1.80	± 13.1 %
5500	35.6	4.96	4.57	4.57	4.57	0.40	1.80	± 13.1 %
5600	35.5	5.07	4.45	4.45	4.45	0.40	1.80	± 13.1 %
5800	35.3	5.27	4.40	4.40	4.40	0.40	1.80	± 13.1 %

^C Frequency validity above 300 MHz of ± 100 MHz only applies for DASY v4.4 and higher (see Page 2), else it is restricted to ± 50 MHz. The uncertainty is the RSS of the ConvF uncertainty at calibration frequency and the uncertainty for the indicated frequency band. Frequency validity below 300 MHz is ± 10, 25, 40, 50 and 70 MHz for ConvF assessments at 30, 64, 128, 150 and 220 MHz respectively. Above 5 GHz frequency validity can be extended to ± 110 MHz.

^F At frequencies below 3 GHz, the validity of tissue parameters (ϵ and σ) can be relaxed to ± 10% if liquid compensation formula is applied to measured SAR values. At frequencies above 3 GHz, the validity of tissue parameters (ϵ and σ) is restricted to ± 5%. The uncertainty is the RSS of the ConvF uncertainty for indicated target tissue parameters.

^G Alpha/Depth are determined during calibration. SPEAG warrants that the remaining deviation due to the boundary effect after compensation is always less than ± 1% for frequencies below 3 GHz and below ± 2% for frequencies between 3-6 GHz at any distance larger than half the probe tip diameter from the boundary.

DASY/EASY - Parameters of Probe: EX3DV4 - SN:3979

Calibration Parameter Determined in Body Tissue Simulating Media

f (MHz) ^C	Relative Permittivity ^F	Conductivity (S/m) ^F	ConvF X	ConvF Y	ConvF Z	Alpha ^G	Depth ^G (mm)	Unct. (k=2)
750	55.5	0.96	9.79	9.79	9.79	0.44	0.85	± 12.0 %
835	55.2	0.97	9.68	9.68	9.68	0.66	0.69	± 12.0 %
900	55.0	1.05	9.43	9.43	9.43	0.35	0.99	± 12.0 %
1450	54.0	1.30	8.11	8.11	8.11	0.74	0.62	± 12.0 %
1640	53.8	1.40	8.25	8.25	8.25	0.60	0.71	± 12.0 %
1750	53.4	1.49	7.77	7.77	7.77	0.65	0.69	± 12.0 %
1810	53.3	1.52	7.64	7.64	7.64	0.52	0.77	± 12.0 %
1900	53.3	1.52	7.51	7.51	7.51	0.63	0.70	± 12.0 %
2000	53.3	1.52	7.61	7.61	7.61	0.45	0.79	± 12.0 %
2300	52.9	1.81	7.30	7.30	7.30	0.67	0.64	± 12.0 %
2450	52.7	1.95	7.08	7.08	7.08	0.80	0.61	± 12.0 %
2600	52.5	2.16	6.81	6.81	6.81	0.80	0.50	± 12.0 %
3500	51.3	3.31	6.40	6.40	6.40	0.57	0.85	± 13.1 %
5200	49.0	5.30	4.60	4.60	4.60	0.40	1.90	± 13.1 %
5300	48.9	5.42	4.42	4.42	4.42	0.40	1.90	± 13.1 %
5500	48.6	5.65	4.04	4.04	4.04	0.45	1.90	± 13.1 %
5600	48.5	5.77	4.01	4.01	4.01	0.45	1.90	± 13.1 %
5800	48.2	6.00	4.18	4.18	4.18	0.50	1.90	± 13.1 %

^C Frequency validity above 300 MHz of ± 100 MHz only applies for DASY v4.4 and higher (see Page 2), else it is restricted to ± 50 MHz. The uncertainty is the RSS of the ConvF uncertainty at calibration frequency and the uncertainty for the indicated frequency band. Frequency validity below 300 MHz is ± 10, 25, 40, 50 and 70 MHz for ConvF assessments at 30, 64, 128, 150 and 220 MHz respectively. Above 5 GHz frequency validity can be extended to ± 110 MHz.

^F At frequencies below 3 GHz, the validity of tissue parameters (ϵ and σ) can be relaxed to ± 10% if liquid compensation formula is applied to measured SAR values. At frequencies above 3 GHz, the validity of tissue parameters (ϵ and σ) is restricted to ± 5%. The uncertainty is the RSS of the ConvF uncertainty for indicated target tissue parameters.

^G Alpha/Depth are determined during calibration. SPEAG warrants that the remaining deviation due to the boundary effect after compensation is always less than ± 1% for frequencies below 3 GHz and below ± 2% for frequencies between 3-6 GHz at any distance larger than half the probe tip diameter from the boundary.

Frequency Response of E-Field (TEM-Cell:ifi110 EXX, Waveguide: R22)

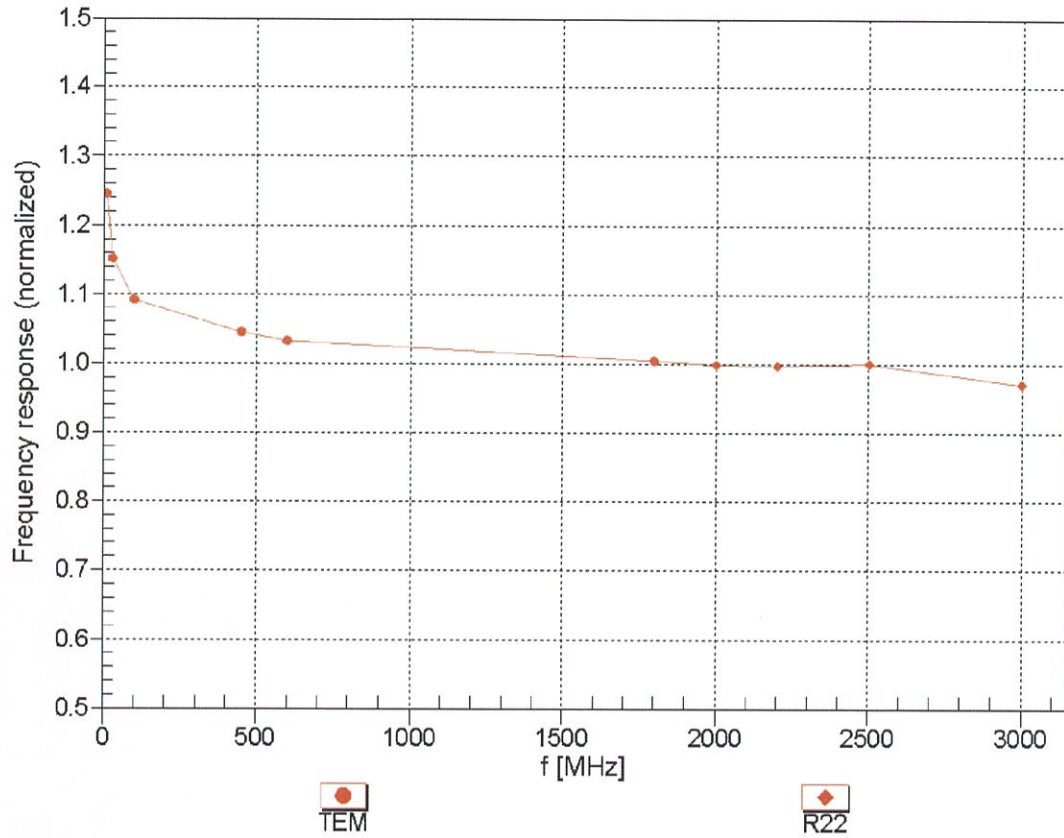

Uncertainty of Frequency Response of E-field: $\pm 6.3\%$ (k=2)

Receiving Pattern (ϕ), $\vartheta = 0^\circ$

f=600 MHz,TEM

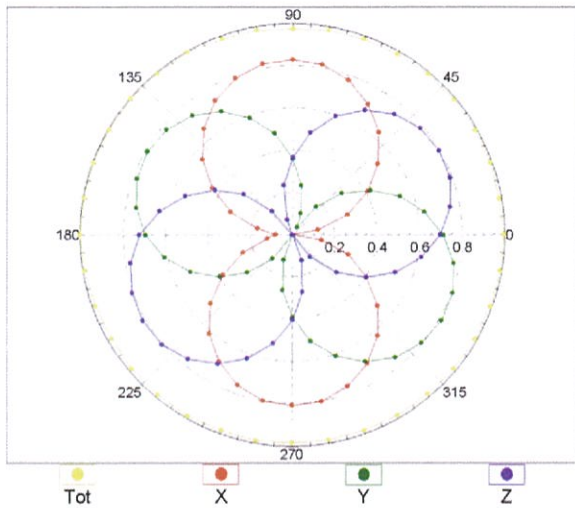

f=1800 MHz,R22

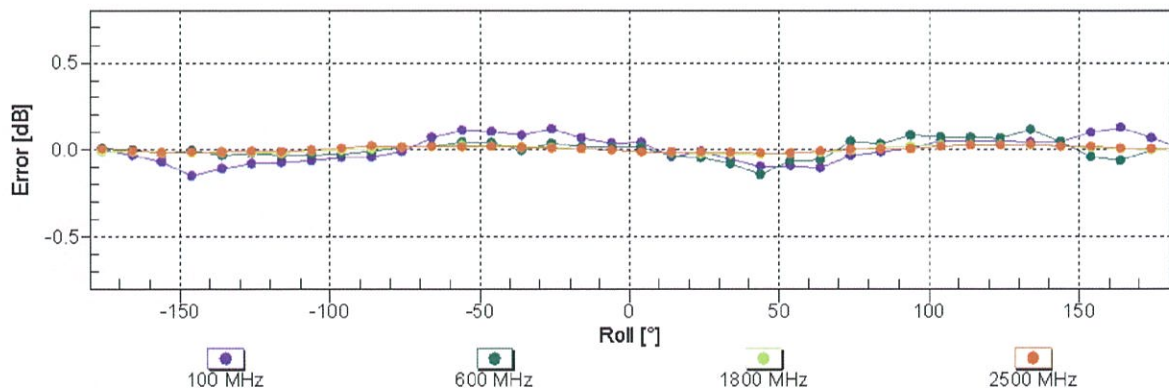
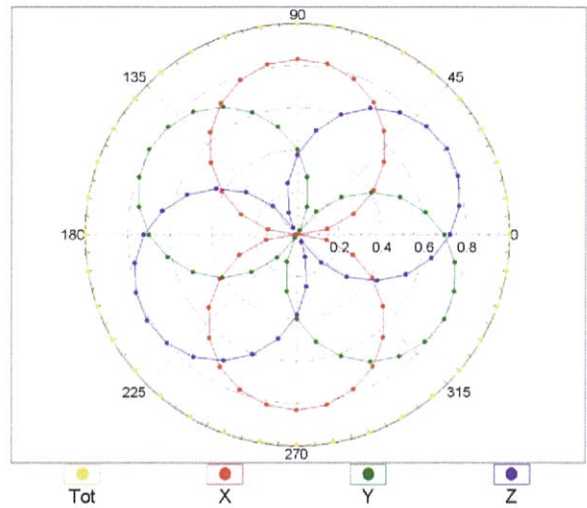

Uncertainty of Axial Isotropy Assessment: $\pm 0.5\%$ ($k=2$)

Dynamic Range f(SAR_{head}) (TEM cell , f_{eval}= 1900 MHz)

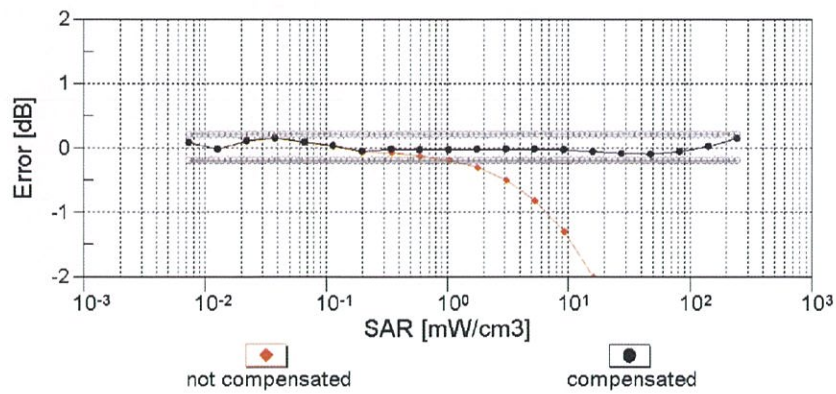
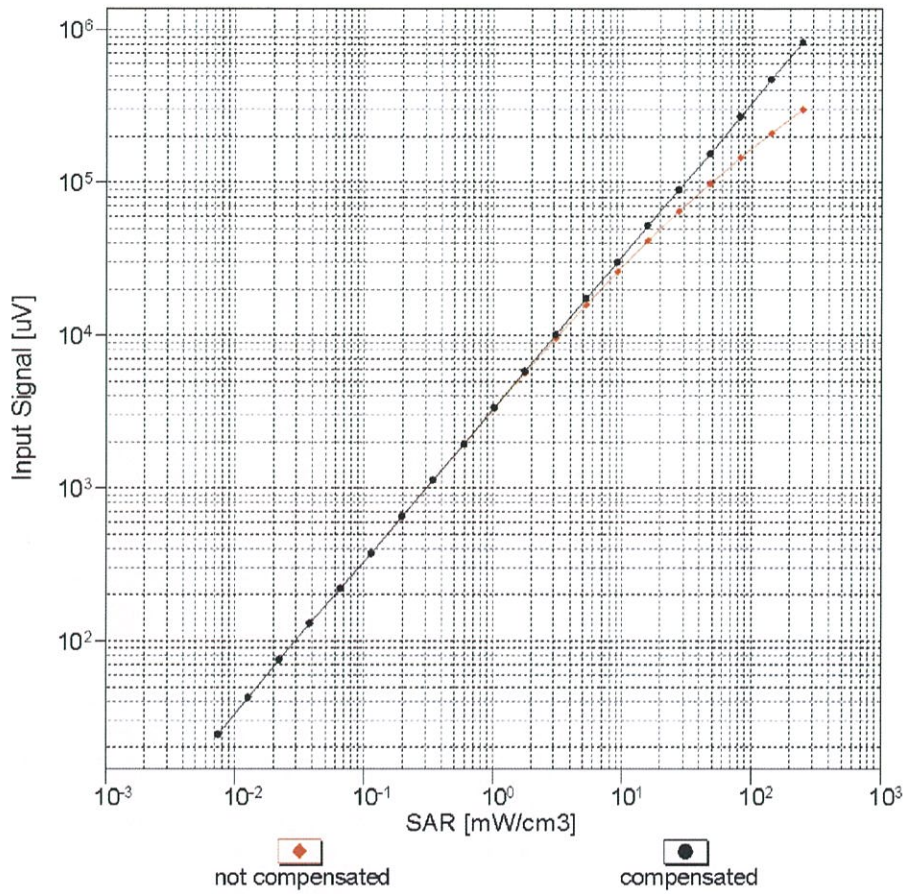

Uncertainty of Linearity Assessment: ± 0.6% (k=2)

Conversion Factor Assessment

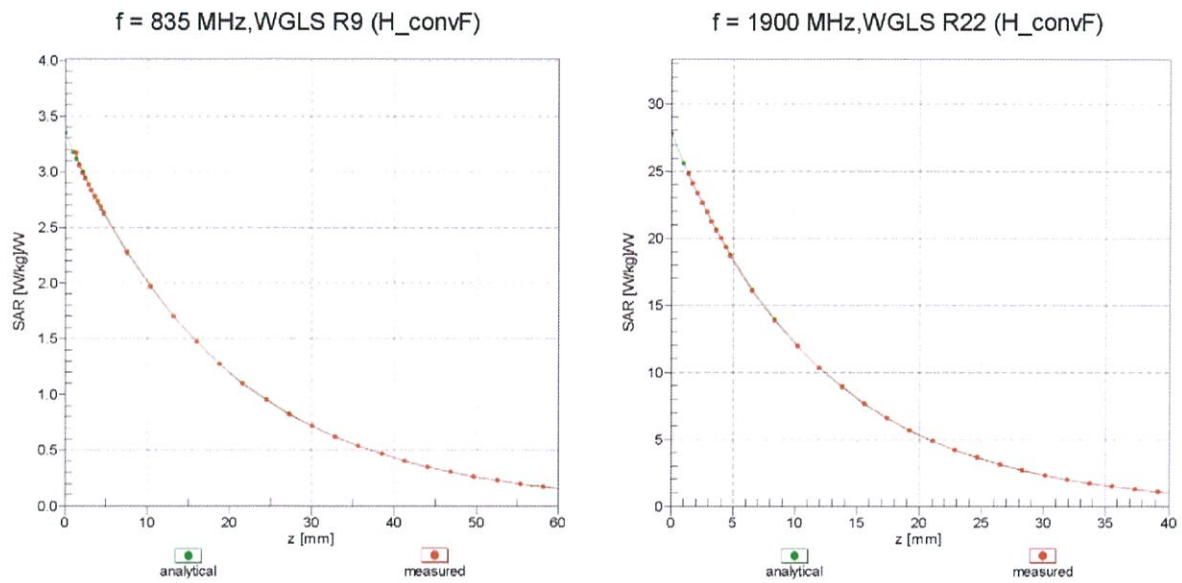

Deviation from Isotropy in Liquid Error (ϕ, θ), f = 900 MHz

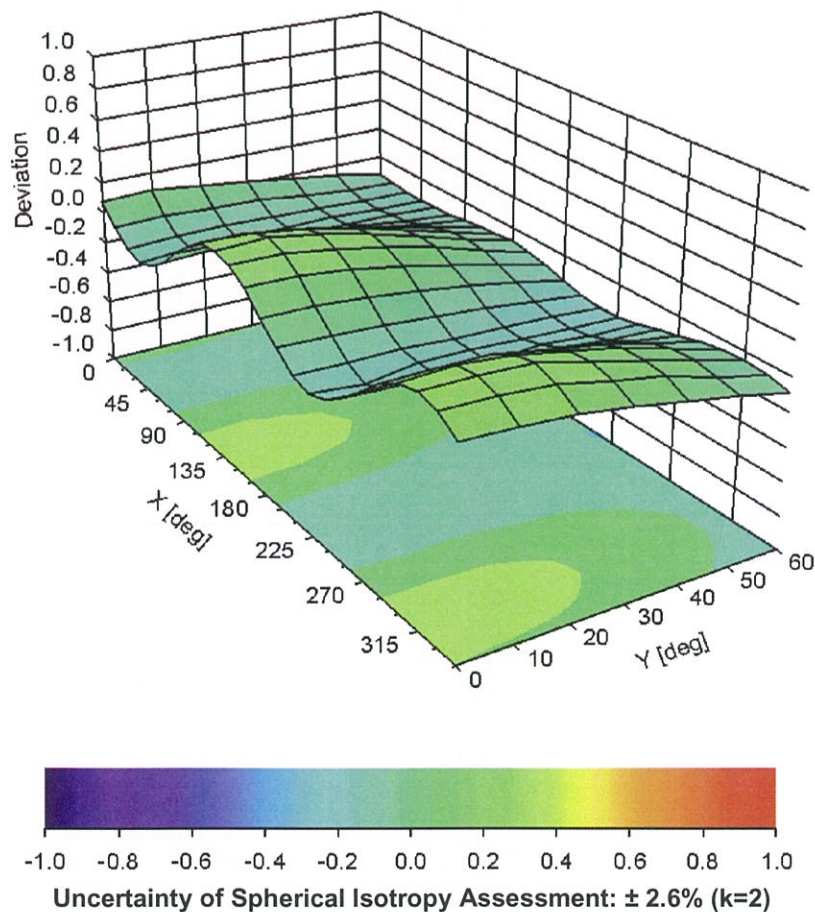

DASY/EASY - Parameters of Probe: EX3DV4 - SN:3979**Other Probe Parameters**

Sensor Arrangement	Triangular
Connector Angle (°)	-46.1
Mechanical Surface Detection Mode	enabled
Optical Surface Detection Mode	disabled
Probe Overall Length	337 mm
Probe Body Diameter	10 mm
Tip Length	9 mm
Tip Diameter	2.5 mm
Probe Tip to Sensor X Calibration Point	1 mm
Probe Tip to Sensor Y Calibration Point	1 mm
Probe Tip to Sensor Z Calibration Point	1 mm
Recommended Measurement Distance from Surface	1.4 mm



Appendix D. Probe Calibration Data

Object: EX3DV4- SN: 3698

1159

**Calibration Laboratory of
Schmid & Partner
Engineering AG**
Zeughausstrasse 43, 8004 Zurich, Switzerland



S Schweizerischer Kalibrierdienst
C Service suisse d'étalonnage
S Servizio svizzero di taratura
Swiss Calibration Service

Accredited by the Swiss Accreditation Service (SAS)
The Swiss Accreditation Service is one of the signatories to the EA
Multilateral Agreement for the recognition of calibration certificates

Accreditation No.: **SCS 108**

Client **Quietek-TW (Auden)**

Certificate No: **EX3-3698_Jul14**

CALIBRATION CERTIFICATE

Object **EX3DV4 - SN:3698**

Calibration procedure(s) **QA CAL-01.v9, QA CAL-14.v4, QA CAL-23.v5, QA CAL-25.v6
Calibration procedure for dosimetric E-field probes**

Calibration date: **July 25, 2014**

This calibration certificate documents the traceability to national standards, which realize the physical units of measurements (SI).
The measurements and the uncertainties with confidence probability are given on the following pages and are part of the certificate.

All calibrations have been conducted in the closed laboratory facility: environment temperature (22 ± 3)°C and humidity < 70%.

Calibration Equipment used (M&TE critical for calibration)

Primary Standards	ID	Cal Date (Certificate No.)	Scheduled Calibration
Power meter E4419B	GB41293874	03-Apr-14 (No. 217-01911)	Apr-15
Power sensor E4412A	MY41498087	03-Apr-14 (No. 217-01911)	Apr-15
Reference 3 dB Attenuator	SN: S5054 (3c)	03-Apr-14 (No. 217-01915)	Apr-15
Reference 20 dB Attenuator	SN: S5277 (20x)	03-Apr-14 (No. 217-01919)	Apr-15
Reference 30 dB Attenuator	SN: S5129 (30b)	03-Apr-14 (No. 217-01920)	Apr-15
Reference Probe ES3DV2	SN: 3013	30-Dec-13 (No. ES3-3013_Dec13)	Dec-14
DAE4	SN: 660	13-Dec-13 (No. DAE4-660_Dec13)	Dec-14
Secondary Standards	ID	Check Date (in house)	Scheduled Check
RF generator HP 8648C	US3642U01700	4-Aug-99 (in house check Apr-13)	In house check: Apr-16
Network Analyzer HP 8753E	US37390585	18-Oct-01 (in house check Oct-13)	In house check: Oct-14

	Name	Function	Signature
Calibrated by:	Israe El-Naouq	Laboratory Technician	
Approved by:	Katja Pokovic	Technical Manager	
			Issued: July 26, 2014

This calibration certificate shall not be reproduced except in full without written approval of the laboratory.



Accredited by the Swiss Accreditation Service (SAS)

Accreditation No.: **SCS 108**

The Swiss Accreditation Service is one of the signatories to the EA
Multilateral Agreement for the recognition of calibration certificates

Glossary:

TSL	tissue simulating liquid
NORM _{x,y,z}	sensitivity in free space
ConvF	sensitivity in TSL / NORM _{x,y,z}
DCP	diode compression point
CF	crest factor (1/duty_cycle) of the RF signal
A, B, C, D	modulation dependent linearization parameters
Polarization φ	φ rotation around probe axis
Polarization ϑ	ϑ rotation around an axis that is in the plane normal to probe axis (at measurement center), i.e., $\vartheta = 0$ is normal to probe axis
Connector Angle	information used in DASY system to align probe sensor X to the robot coordinate system

Calibration is Performed According to the Following Standards:

- IEEE Std 1528-2013, "IEEE Recommended Practice for Determining the Peak Spatial-Averaged Specific Absorption Rate (SAR) in the Human Head from Wireless Communications Devices: Measurement Techniques", June 2013
- IEC 62209-1, "Procedure to measure the Specific Absorption Rate (SAR) for hand-held devices used in close proximity to the ear (frequency range of 300 MHz to 3 GHz)", February 2005

Methods Applied and Interpretation of Parameters:

- NORM_{x,y,z}**: Assessed for E-field polarization $\vartheta = 0$ ($f \leq 900$ MHz in TEM-cell; $f > 1800$ MHz: R22 waveguide). NORM_{x,y,z} are only intermediate values, i.e., the uncertainties of NORM_{x,y,z} does not affect the E²-field uncertainty inside TSL (see below *ConvF*).
- NORM(f)_{x,y,z}** = NORM_{x,y,z} * frequency_response (see Frequency Response Chart). This linearization is implemented in DASY4 software versions later than 4.2. The uncertainty of the frequency response is included in the stated uncertainty of *ConvF*.
- DCP_{x,y,z}**: DCP are numerical linearization parameters assessed based on the data of power sweep with CW signal (no uncertainty required). DCP does not depend on frequency nor media.
- PAR**: PAR is the Peak to Average Ratio that is not calibrated but determined based on the signal characteristics
- A_{x,y,z}; B_{x,y,z}; C_{x,y,z}; D_{x,y,z}; VR_{x,y,z}; A, B, C, D** are numerical linearization parameters assessed based on the data of power sweep for specific modulation signal. The parameters do not depend on frequency nor media. VR is the maximum calibration range expressed in RMS voltage across the diode.
- ConvF and Boundary Effect Parameters**: Assessed in flat phantom using E-field (or Temperature Transfer Standard for $f \leq 800$ MHz) and inside waveguide using analytical field distributions based on power measurements for $f > 800$ MHz. The same setups are used for assessment of the parameters applied for boundary compensation (alpha, depth) of which typical uncertainty values are given. These parameters are used in DASY4 software to improve probe accuracy close to the boundary. The sensitivity in TSL corresponds to NORM_{x,y,z} * ConvF whereby the uncertainty corresponds to that given for ConvF. A frequency dependent ConvF is used in DASY version 4.4 and higher which allows extending the validity from ± 50 MHz to ± 100 MHz.
- Spherical isotropy (3D deviation from isotropy)**: in a field of low gradients realized using a flat phantom exposed by a patch antenna.
- Sensor Offset**: The sensor offset corresponds to the offset of virtual measurement center from the probe tip (on probe axis). No tolerance required.
- Connector Angle**: The angle is assessed using the information gained by determining the NORM_x (no uncertainty required).

Probe EX3DV4

SN:3698

Manufactured: April 22, 2009
Calibrated: July 25, 2014

Calibrated for DASY/EASY Systems
(Note: non-compatible with DASY2 system!)

DASY/EASY - Parameters of Probe: EX3DV4 - SN:3698

Basic Calibration Parameters

	Sensor X	Sensor Y	Sensor Z	Unc (k=2)
Norm ($\mu\text{V}/(\text{V}/\text{m})^2$) ^A	0.41	0.36	0.36	$\pm 10.1 \%$
DCP (mV) ^B	100.1	100.4	101.1	

Modulation Calibration Parameters

UID	Communication System Name		A dB	B dB $\sqrt{\mu\text{V}}$	C	D dB	VR mV	Unc ^E (k=2)
0	CW	X	0.0	0.0	1.0	0.00	142.4	$\pm 3.8 \%$
		Y	0.0	0.0	1.0		132.4	
		Z	0.0	0.0	1.0		134.9	

The reported uncertainty of measurement is stated as the standard uncertainty of measurement multiplied by the coverage factor $k=2$, which for a normal distribution corresponds to a coverage probability of approximately 95%.

^A The uncertainties of NormX,Y,Z do not affect the E^2 -field uncertainty inside TSL (see Pages 5 and 6).

^B Numerical linearization parameter: uncertainty not required.

^E Uncertainty is determined using the max. deviation from linear response applying rectangular distribution and is expressed for the square of the field value.

DASY/EASY - Parameters of Probe: EX3DV4 - SN:3698

Calibration Parameter Determined in Head Tissue Simulating Media

f (MHz) ^C	Relative Permittivity ^F	Conductivity (S/m) ^F	ConvF X	ConvF Y	ConvF Z	Alpha ^G	Depth ^G (mm)	Unct. (k=2)
750	41.9	0.89	9.19	9.19	9.19	0.80	0.50	± 12.0 %
835	41.5	0.90	8.77	8.77	8.77	0.75	0.50	± 12.0 %
900	41.5	0.97	8.58	8.58	8.58	0.43	0.84	± 12.0 %
1750	40.1	1.37	7.50	7.50	7.50	0.49	0.71	± 12.0 %
1900	40.0	1.40	7.20	7.20	7.20	0.51	0.72	± 12.0 %
2450	39.2	1.80	6.59	6.59	6.59	0.30	0.98	± 12.0 %
2600	39.0	1.96	6.41	6.41	6.41	0.30	1.00	± 12.0 %
3500	37.9	2.91	6.29	6.29	6.29	0.25	1.92	± 13.1 %
5200	36.0	4.66	4.67	4.67	4.67	0.45	1.80	± 13.1 %
5300	35.9	4.76	4.46	4.46	4.46	0.45	1.80	± 13.1 %
5500	35.6	4.96	4.43	4.43	4.43	0.45	1.80	± 13.1 %
5600	35.5	5.07	4.16	4.16	4.16	0.50	1.80	± 13.1 %
5800	35.3	5.27	4.24	4.24	4.24	0.50	1.80	± 13.1 %

^C Frequency validity above 300 MHz of ± 100 MHz only applies for DASY v4.4 and higher (see Page 2), else it is restricted to ± 50 MHz. The uncertainty is the RSS of the ConvF uncertainty at calibration frequency and the uncertainty for the indicated frequency band. Frequency validity below 300 MHz is ± 10, 25, 40, 50 and 70 MHz for ConvF assessments at 30, 64, 128, 150 and 220 MHz respectively. Above 5 GHz frequency validity can be extended to ± 110 MHz.

^F At frequencies below 3 GHz, the validity of tissue parameters (ϵ and σ) can be relaxed to ± 10% if liquid compensation formula is applied to measured SAR values. At frequencies above 3 GHz, the validity of tissue parameters (ϵ and σ) is restricted to ± 5%. The uncertainty is the RSS of the ConvF uncertainty for indicated target tissue parameters.

^G Alpha/Depth are determined during calibration. SPEAG warrants that the remaining deviation due to the boundary effect after compensation is always less than ± 1% for frequencies below 3 GHz and below ± 2% for frequencies between 3-6 GHz at any distance larger than half the probe tip diameter from the boundary.

DASY/EASY - Parameters of Probe: EX3DV4 - SN:3698

Calibration Parameter Determined in Body Tissue Simulating Media

f (MHz) ^C	Relative Permittivity ^F	Conductivity (S/m) ^F	ConvF X	ConvF Y	ConvF Z	Alpha ^G	Depth ^G (mm)	Unct. (k=2)
750	55.5	0.96	9.03	9.03	9.03	0.50	0.70	± 12.0 %
835	55.2	0.97	8.86	8.86	8.86	0.80	0.50	± 12.0 %
900	55.0	1.05	8.51	8.51	8.51	0.80	0.64	± 12.0 %
1750	53.4	1.49	7.44	7.44	7.44	0.37	0.89	± 12.0 %
1900	53.3	1.52	6.81	6.81	6.81	0.45	0.90	± 12.0 %
2450	52.7	1.95	6.50	6.50	6.50	0.70	0.65	± 12.0 %
2600	52.5	2.16	6.31	6.31	6.31	0.80	0.60	± 12.0 %
3500	51.3	3.31	5.84	5.84	5.84	0.27	1.74	± 13.1 %
5200	49.0	5.30	4.23	4.23	4.23	0.50	1.90	± 13.1 %
5300	48.9	5.42	4.13	4.13	4.13	0.50	1.80	± 13.1 %
5500	48.6	5.65	3.81	3.81	3.81	0.50	1.90	± 13.1 %
5600	48.5	5.77	3.64	3.64	3.64	0.50	1.90	± 13.1 %
5800	48.2	6.00	3.94	3.94	3.94	0.50	1.90	± 13.1 %

^C Frequency validity above 300 MHz of ± 100 MHz only applies for DASY v4.4 and higher (see Page 2), else it is restricted to ± 50 MHz. The uncertainty is the RSS of the ConvF uncertainty at calibration frequency and the uncertainty for the indicated frequency band. Frequency validity below 300 MHz is ± 10, 25, 40, 50 and 70 MHz for ConvF assessments at 30, 64, 128, 150 and 220 MHz respectively. Above 5 GHz frequency validity can be extended to ± 110 MHz.

^F At frequencies below 3 GHz, the validity of tissue parameters (ϵ and σ) can be relaxed to ± 10% if liquid compensation formula is applied to measured SAR values. At frequencies above 3 GHz, the validity of tissue parameters (ϵ and σ) is restricted to ± 5%. The uncertainty is the RSS of the ConvF uncertainty for indicated target tissue parameters.

^G Alpha/Depth are determined during calibration. SPEAG warrants that the remaining deviation due to the boundary effect after compensation is always less than ± 1% for frequencies below 3 GHz and below ± 2% for frequencies between 3-6 GHz at any distance larger than half the probe tip diameter from the boundary.

Frequency Response of E-Field (TEM-Cell:ifi110 EXX, Waveguide: R22)

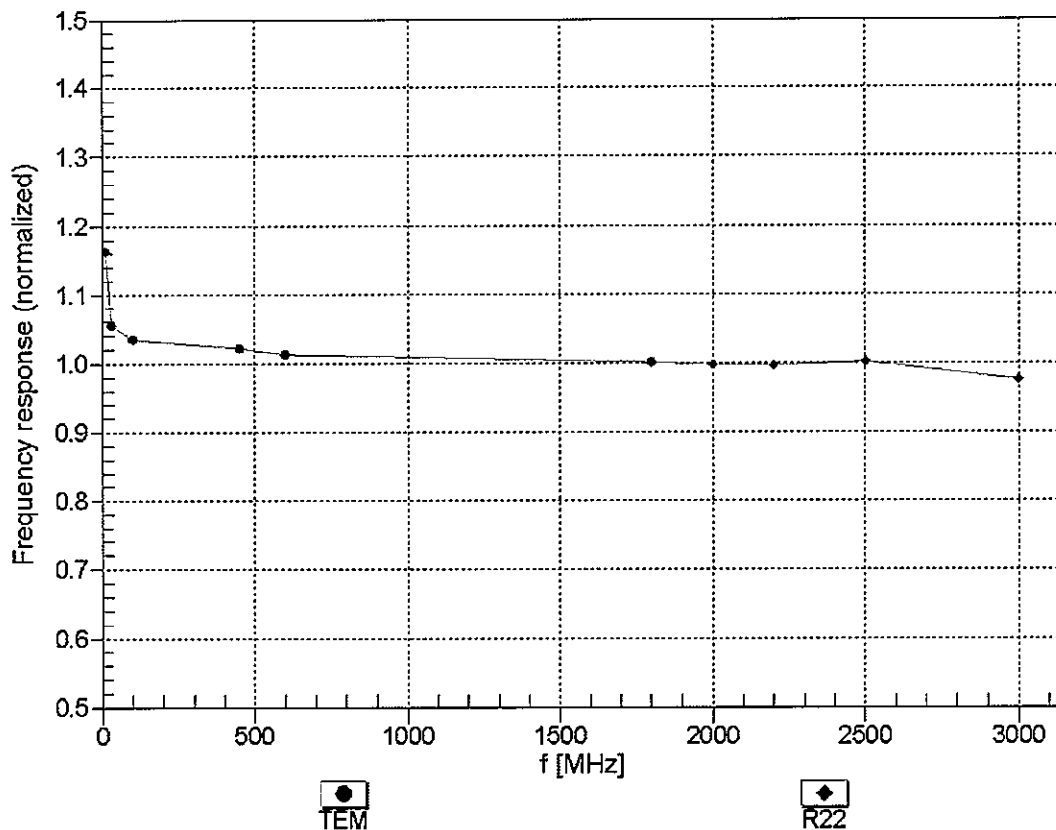

Uncertainty of Frequency Response of E-field: $\pm 6.3\%$ (k=2)

Receiving Pattern (ϕ), $\vartheta = 0^\circ$

f=600 MHz, TEM

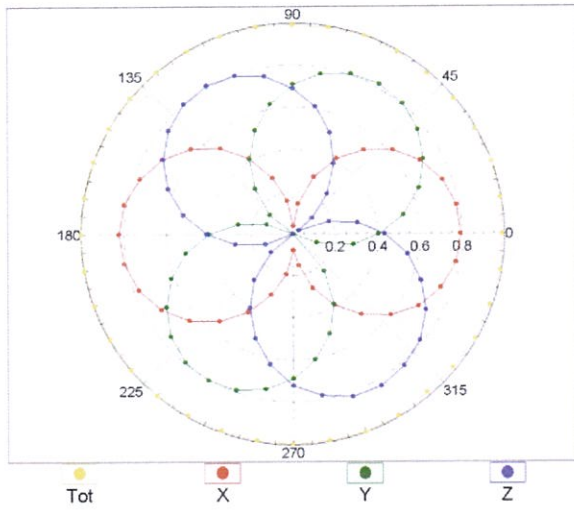

f=1800 MHz, R22

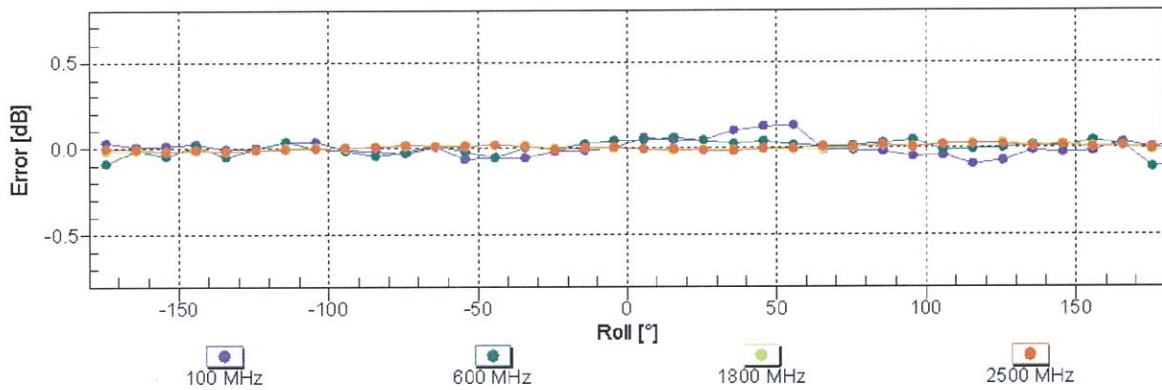
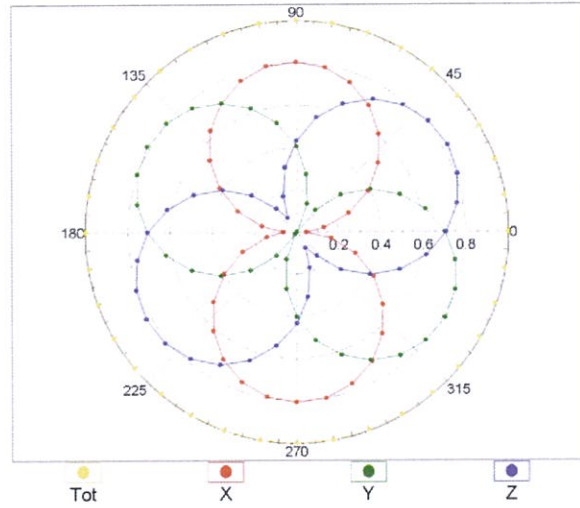

Uncertainty of Axial Isotropy Assessment: $\pm 0.5\%$ (k=2)

Dynamic Range f(SAR_{head}) (TEM cell , f_{eval}= 1900 MHz)

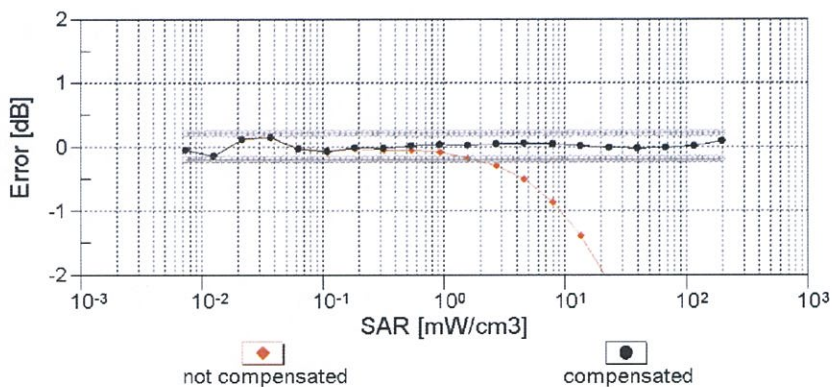
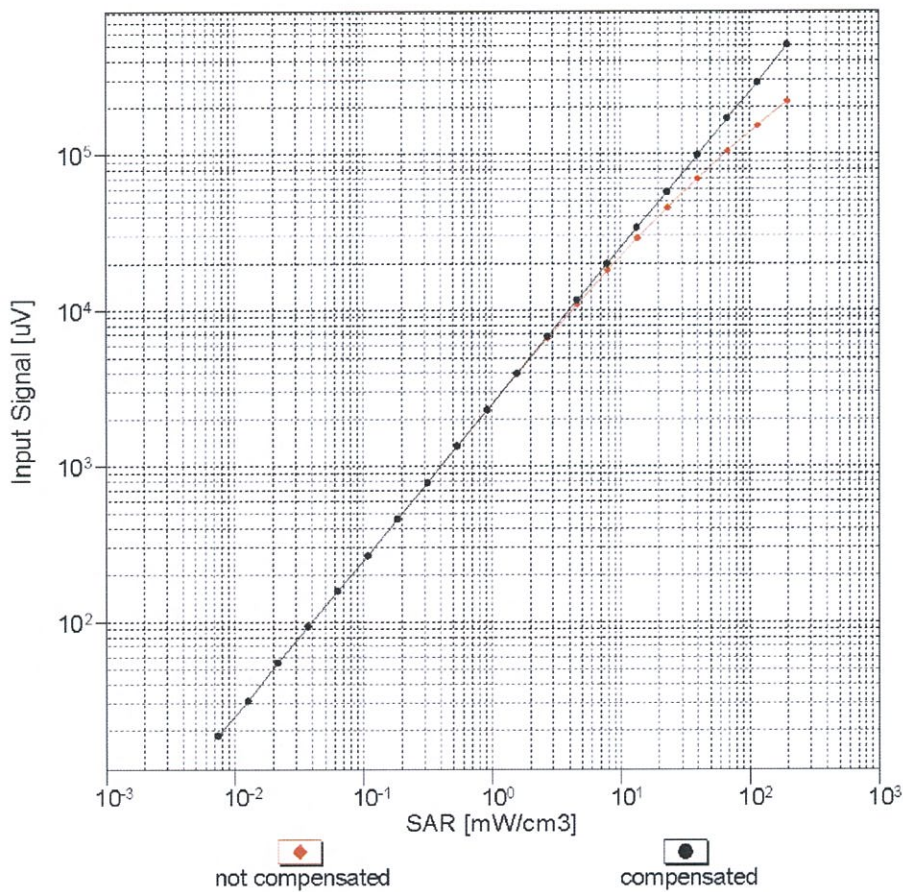

Uncertainty of Linearity Assessment: ± 0.6% (k=2)

Conversion Factor Assessment

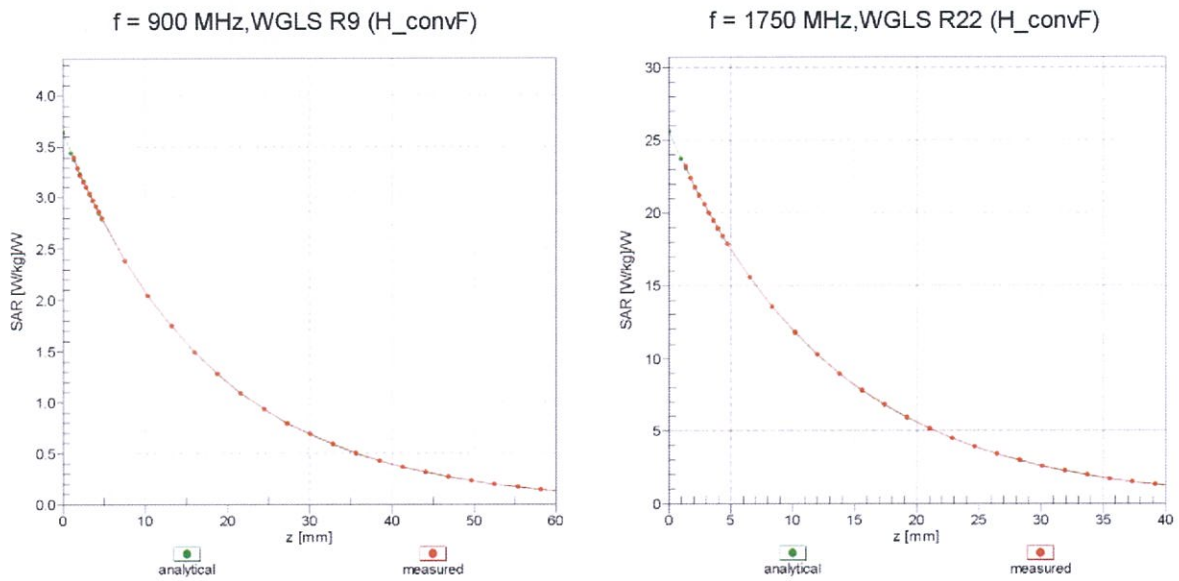

Deviation from Isotropy in Liquid Error (ϕ, ϑ), f = 900 MHz

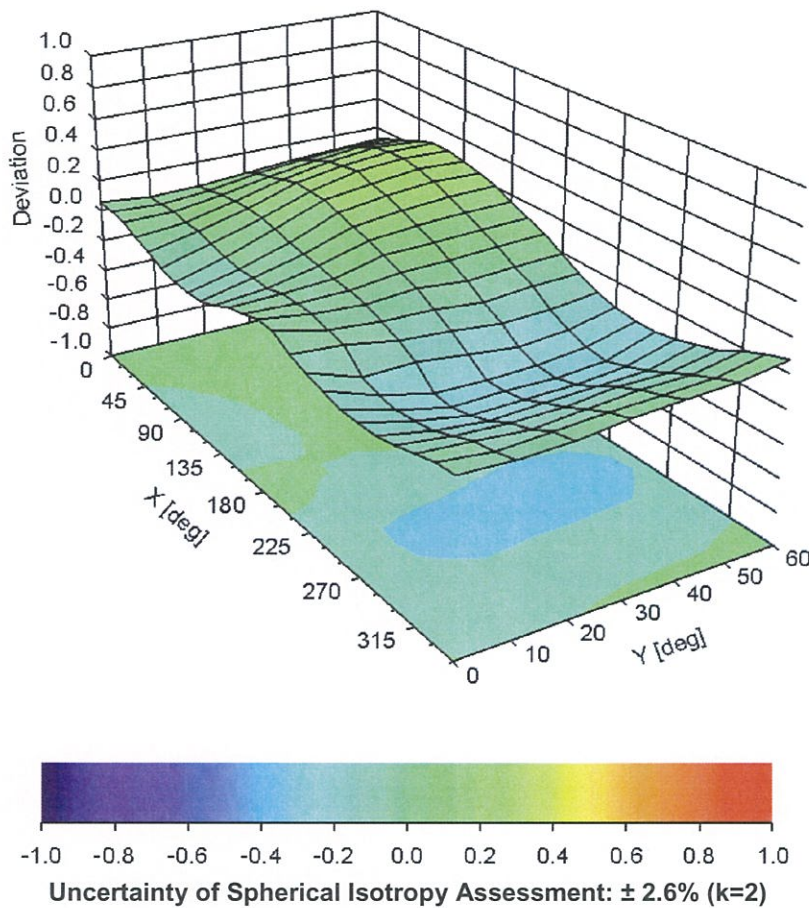

DASY/EASY - Parameters of Probe: EX3DV4 - SN:3698**Other Probe Parameters**

Sensor Arrangement	Triangular
Connector Angle (°)	-134.3
Mechanical Surface Detection Mode	enabled
Optical Surface Detection Mode	disabled
Probe Overall Length	337 mm
Probe Body Diameter	10 mm
Tip Length	9 mm
Tip Diameter	2.5 mm
Probe Tip to Sensor X Calibration Point	1 mm
Probe Tip to Sensor Y Calibration Point	1 mm
Probe Tip to Sensor Z Calibration Point	1 mm
Recommended Measurement Distance from Surface	1.4 mm