

FCC Test Report

Product Name	TABLET PC
Model No	PM-311B
FCC ID.	2ABTU-PM311B

Applicant	RuggON Corporation
Address	3F., No.10, Ln. 181, Sec. 2, Jiuzong Rd., Neihu Dist., Taipei City 114, Taiwan (R.O.C.)

Date of Receipt	Mar. 25, 2016
Issue Date	May 10, 2016
Report No.	1630475R-RFUSP26V00
Report Version	V1.0



The test results relate only to the samples tested.

The test results shown in the test report are traceable to the national/international standard through the calibration of the equipment and evaluated measurement uncertainty herein.

This report must not be used to claim product endorsement by TAF or any agency of the government.

The test report shall not be reproduced without the written approval of QuieTek Corporation.

Test Report

Issue Date: May 10, 2016

Report No.: 1630475R-RFUSP26V00

Quietek

a  DEKRA company

Product Name	TABLET PC
Applicant	RuggON Corporation
Address	3F., No.10, Ln. 181, Sec. 2, Jiuzong Rd., Neihu Dist., Taipei City 114, Taiwan (R.O.C.)
Model No.	PM-311B
EUT Rated Voltage	AC 100-240V, 50-60Hz
EUT Test Voltage	AC 120V/60Hz
Trade Name	RuggON
Applicable Standard	FCC CFR Title 47 Part 15 Subpart C: 2015 ANSI C63.4: 2014, ANSI C63.10: 2013 KDB 558074 D01 DTS Meas Guidance v03r05
Test Result	Complied

Documented By : Jinn Chen
(Senior Adm. Specialist / Jinn Chen)

Tested By : Nick Chen
(Engineer / Nick Chen)

Approved By : 
(Director / Vincent Lin)

TABLE OF CONTENTS

Description	Page
1. GENERAL INFORMATION	5
1.1. EUT Description.....	5
1.2. Operational Description	7
1.3. Tested System Details.....	8
1.4. Configuration of Tested System	8
1.5. EUT Exercise Software	9
1.6. Test Facility	10
2. Conducted Emission.....	11
2.1. Test Equipment.....	11
2.2. Test Setup	11
2.3. Limits	12
2.4. Test Procedure	12
2.5. Uncertainty	12
2.6. Test Result of Conducted Emission.....	13
3. Maximum Conducted Power.....	15
3.1. Test Equipment.....	15
3.2. Test Setup	15
3.3. Limits	15
3.4. Test Procedure	15
3.5. Uncertainty	15
3.6. Test Result of Maximum Conducted Power.....	16
4. Radiated Emission.....	20
4.1. Test Equipment.....	20
4.2. Test Setup	21
4.3. Limits	22
4.4. Test Procedure	23
4.5. Uncertainty	23
4.6. Test Result of Radiated Emission.....	24
5. RF Antenna conducted test.....	40
5.1. Test Equipment.....	40
5.2. Test Setup	40
5.3. Limits	40
5.4. Test Procedure	41
5.5. Uncertainty	41
5.6. Test Result of RF antenna conducted test.....	42
6. Band Edge	48
6.1. Test Equipment.....	48
6.2. Test Setup	49
6.3. Limits	50
6.4. Test Procedure	50
6.5. Uncertainty	50
6.6. Test Result of Band Edge	51

7.	6dB Bandwidth	67
7.1.	Test Equipment.....	67
7.2.	Test Setup	67
7.3.	Limits	67
7.4.	Test Procedure	67
7.5.	Uncertainty	67
7.6.	Test Result of 6dB Bandwidth.....	68
8.	Power Density	80
8.1.	Test Equipment.....	80
8.2.	Test Setup	80
8.3.	Limits	80
8.4.	Test Procedure	80
8.5.	Uncertainty	80
8.6.	Test Result of Power Density	81
9.	EMI Reduction Method During Compliance Testing	93

Attachment 1: EUT Test Photographs

Attachment 2: EUT Detailed Photographs

1. GENERAL INFORMATION

1.1. EUT Description

Product Name	TABLET PC
Trade Name	RuggON
Model No.	PM-311B
FCC ID.	2ABTU-PM311B
Frequency Range	802.11b/g/n-20MHz:2412-2462MHz,802.11n-40MHz:2422-2452MHz
Number of Channels	802.11b/g/n-20MHz: 11, n-40MHz: 7
Data Speed	802.11b: 1-11Mbps, 802.11a/g: 6-54Mbps, 802.11n: up to 300Mbps
Type of Modulation	802.11b:DSSS, DBPSK, DQPSK, CCK 802.11g/n: OFDM, BPSK, QPSK, 16QAM, 64QAM
Antenna Type	PIFA Antenna
Antenna Gain	Refer to the table "Antenna List"
Channel Control	Auto
Power Adapter	MFR: FSP, M/N: FSP065-REB Input: 100-240V~1.5A, 50-60Hz Output: 19V $\overline{=}$ 3.42A Cable Out: Shielded, 1.2m, with one ferrite core bonded.
Power Cable	Non-shielded, 1.5m
Contain Module	Intel / 7265NGW

Antenna List

No.	Manufacturer	Part No.	Antenna Type	Peak Gain
1	Taiwan Anjie Electronics Co., Ltd	AJDP1J-B0006(Main) AJDP1J-W0006(Aux)	PIFA Antenna	2.60 dBi for 2.4 GHz

Note: The antenna of EUT is conform to FCC 15.203

802.11b/g/n-20MHz Center Frequency of Each Channel:

Channel	Frequency	Channel	Frequency	Channel	Frequency	Channel	Frequency
Channel 01:	2412 MHz	Channel 02:	2417 MHz	Channel 03:	2422 MHz	Channel 04:	2427 MHz
Channel 05:	2432 MHz	Channel 06:	2437 MHz	Channel 07:	2442 MHz	Channel 08:	2447 MHz
Channel 09:	2452 MHz	Channel 10:	2457 MHz	Channel 11:	2462 MHz		

802.11n-40MHz (2.4G Band) Center Working Frequency of Each Channel:

Channel	Frequency	Channel	Frequency	Channel	Frequency	Channel	Frequency
Channel 03:	2422 MHz	Channel 04:	2427 MHz	Channel 05:	2432 MHz	Channel 06:	2437 MHz
Channel 07:	2442 MHz	Channel 08:	2447 MHz	Channel 09:	2452 MHz		

Note:

1. This device is an TABLET PC with a built-in WLAN 、 Bluetooth and NFC transceiver, this report for WLAN.
2. Regarding to the operation frequency, the lowest, middle and highest frequency are selected to perform the test.
3. Lowest and highest data rates are tested in each mode. Only worst case is shown in the report. (802.11b is 1Mbps 、 802.11g is 6Mbps 、 802.11n(20M-BW) is 14.4Mbps and, 802.11n(40M-BW) is 30Mbps).
4. At result of pretests, module supports dual-channel transmission, only the worst case is shown in the report. (802.11b is chain B, 802.11g is chain B)
5. These tests are conducted on a sample for the purpose of demonstrating compliance of 802.11b/g/n transmitter with Part 15 Subpart C Paragraph 15.247 of spread spectrum devices.
6. The radiation measurements are performed in X, Y, Z axis positioning. Only the worst case is shown in the report.

Test Mode:	Mode 1: Transmit (802.11b 1Mbps)
	Mode 2: Transmit (802.11g 6Mbps)
	Mode 3: Transmit - 802.11n-20BW_14.4Mbps(2.4G Band)
	Mode 4: Transmit - 802.11n-40BW_30Mbps(2.4G Band)

1.3. Tested System Details

The types for all equipment, plus descriptions of all cables used in the tested system (including inserted cards) are:

	Product	Manufacturer	Model No.	Serial No.	Power Cord
(1)	Microphone & Earphone	Ergotech	E201	N/A	N/A
(2)	Keyboard	Logitech	Y-UR83	SY848UK	N/A
(3)	USB Mouse	Logitech	M-BZ96C	LZ128HR	N/A
(4)	Modem	ACEEX	DM-1414	0102027550	Non-Shielded, 1.8m

Signal Cable Type	Signal cable Description
A LAN Cable	Shielded, 1.5m
B USB Cable	Shielded, 1.7m
C Earphone Cable	Non-Shielded, 2.0m
D USB Cable	Shielded, 2.0m
E Modem Cable	Shielded, 2.0m

1.4. Configuration of Tested System

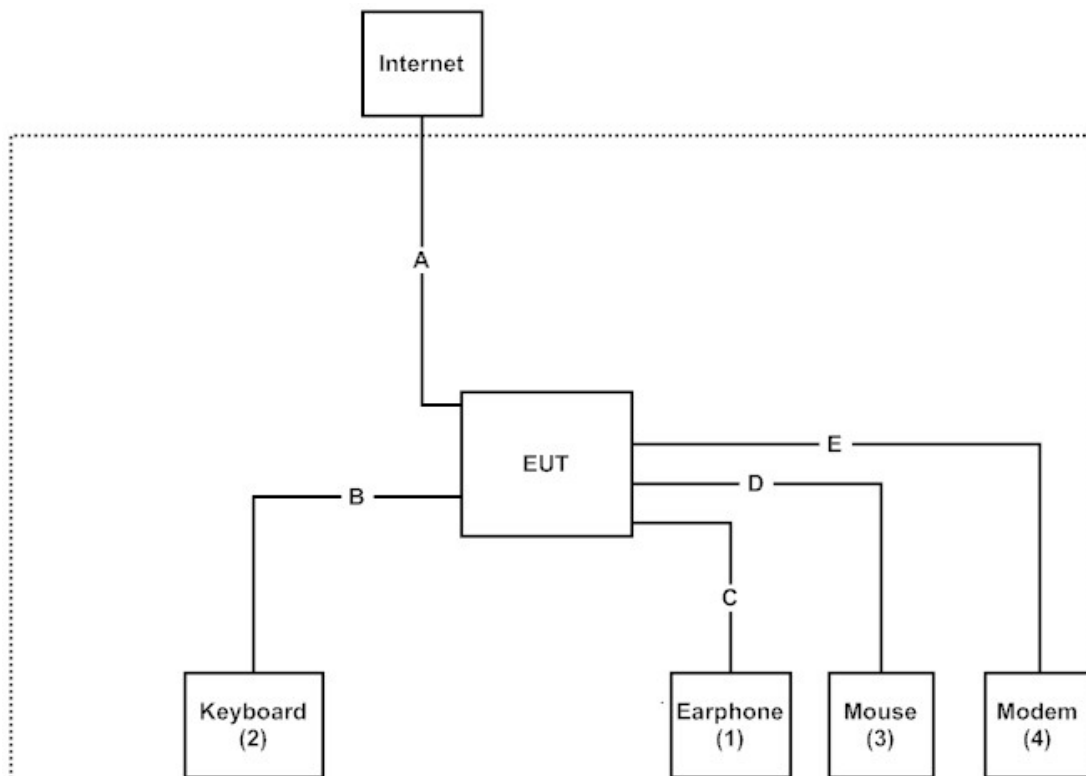

1.5. EUT Exercise Software

- (1) Setup the EUT as shown on 1.4
- (2) Execute “DRTU v1.7.4-1041” program on the Notebook PC.
- (3) Configure the test mode, the test channel, and the data rate.
- (4) Start the continuous transmission.
- (5) Verify that the EUT works properly.

1.6. Test Facility

Ambient conditions in the laboratory:

Items	Required (IEC 68-1)	Actual
Temperature (°C)	15-35	20-35
Humidity (%RH)	25-75	50-65
Barometric pressure (mbar)	860-1060	950-1000

The related certificate for our laboratories about the test site and management system can be downloaded from Quietek Corporation's Web Site : <http://www.quietek.com/chinese/about/certificates.aspx?bval=5>
 The address and introduction of Quietek Corporation's laboratories can be founded in our Web site : <http://www.quietek.com/>

Site Description: File on
 Federal Communications Commission
 FCC Engineering Laboratory
 7435 Oakland Mills Road
 Columbia, MD 21046
 Registration Number: 92195

Site Name: Quietek Corporation
 Site Address: No.5-22, Ruishukeng,
 Linkou Dist. New Taipei City 24451,
 Taiwan, R.O.C.
 TEL: 886-2-8601-3788 / FAX : 886-2-8601-3789
 E-Mail : service@quietek.com

FCC Accreditation Number: TW1014

2. Conducted Emission

2.1. Test Equipment

	Equipment	Manufacturer	Model No. / Serial No.	Last Cal.	Remark
X	Test Receiver	R & S	ESCS 30 / 825442/018	Sep., 2015	
X	Artificial Mains Network	R & S	ENV4200 / 848411/10	Feb., 2016	Peripherals
X	LISN	R & S	ESH3-Z5 / 825562/002	Feb., 2016	EUT
	DC LISN	Schwarzbeck	8226 / 176	Mar, 2016	EUT
X	Pulse Limiter	R & S	ESH3-Z2 / 357.8810.52	Feb., 2016	
	No.1 Shielded Room				

Note:

1. All equipments are calibrated every one year.
2. The test instruments marked by "X" are used to measure the final test results.

2.2. Test Setup

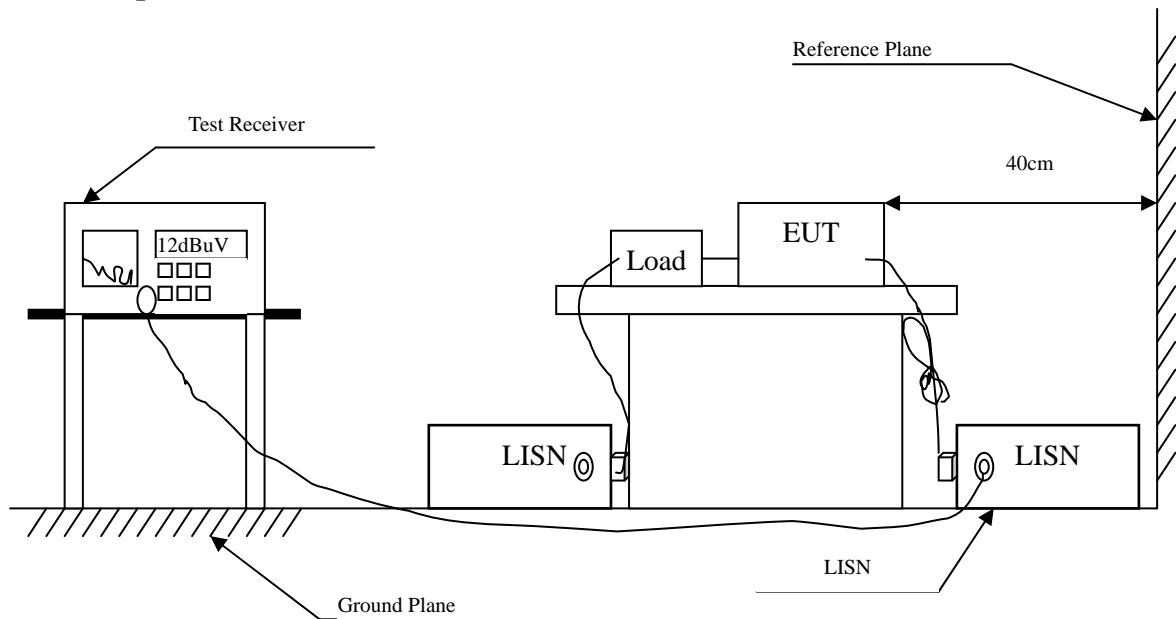

2.3. Limits

FCC Part 15 Subpart C Paragraph 15.207 (dBuV) Limit		
Frequency MHz	Limits	
	QP	AVG
0.15 - 0.50	66-56	56-46
0.50-5.0	56	46
5.0 - 30	60	50

2.4. Test Procedure

The EUT and simulators are connected to the main power through a line impedance stabilization network (L.I.S.N.). This provides a 50 ohm /50uH coupling impedance for the measuring equipment. The peripheral devices are also connected to the main power through a LISN that provides a 50ohm /50uH coupling impedance with 50ohm termination. (Please refers to the block diagram of the test setup and photographs.)

Both sides of A.C. line are checked for maximum conducted interference. In order to find the maximum emission, the relative positions of equipment and all of the interface cables must be changed according to ANSI C63.4: 2014 on conducted measurement.

Conducted emissions were invested over the frequency range from 0.15MHz to 30MHz using a receiver bandwidth of 9kHz.

2.5. Uncertainty

± 2.26 dB

2.6. Test Result of Conducted Emission

Product : TABLET PC
Test Item : Conducted Emission Test
Power Line : Line 1
Test Mode : Mode 4: Transmit - 802.11n-40BW_30Mbps(2.4G Band) (2437MHz)

Frequency MHz	Correct Factor dB	Reading Level dBuV	Measurement Level dBuV	Margin dB	Limit dBuV
Line 1					
Quasi-Peak					
0.154	9.783	33.190	42.973	-22.913	65.886
0.275	9.781	26.830	36.611	-25.818	62.429
0.388	9.779	24.050	33.829	-25.371	59.200
0.744	9.817	22.530	32.347	-23.653	56.000
3.189	9.968	29.760	39.728	-16.272	56.000
9.619	10.087	32.700	42.787	-17.213	60.000
Average					
0.154	9.783	9.550	19.333	-36.553	55.886
0.275	9.781	10.950	20.731	-31.698	52.429
0.388	9.779	11.620	21.399	-27.801	49.200
0.744	9.817	14.610	24.427	-21.573	46.000
3.189	9.968	24.460	34.428	-11.572	46.000
9.619	10.087	27.410	37.497	-12.503	50.000

Note:

1. All Reading Levels are Quasi-Peak and average value.
2. “█” means the worst emission level.
3. Measurement Level = Reading Level + Correct Factor

Product : TABLET PC
Test Item : Conducted Emission Test
Power Line : Line 2
Test Mode : Mode 4: Transmit - 802.11n-40BW_30Mbps(2.4G Band) (2437MHz)

Frequency MHz	Correct Factor dB	Reading Level dBuV	Measurement Level dBuV	Margin dB	Limit dBuV
Line 2					
Quasi-Peak					
0.150	9.831	35.600	45.431	-20.569	66.000
0.275	9.841	24.800	34.641	-27.788	62.429
0.767	9.879	25.610	35.489	-20.511	56.000
3.236	10.029	27.250	37.279	-18.721	56.000
9.552	10.177	28.740	38.917	-21.083	60.000
17.658	10.340	22.320	32.660	-27.340	60.000
Average					
0.150	9.831	14.950	24.781	-31.219	56.000
0.275	9.841	12.560	22.401	-30.028	52.429
0.767	9.879	16.570	26.449	-19.551	46.000
3.236	10.029	22.030	32.059	-13.941	46.000
9.552	10.177	21.990	32.167	-17.833	50.000
17.658	10.340	16.470	26.810	-23.190	50.000

Note:

1. All Reading Levels are Quasi-Peak and average value.
2. "■" means the worst emission level.
3. Measurement Level = Reading Level + Correct Factor

3. Maximum Conducted Power

3.1. Test Equipment

	Equipment	Manufacturer	Model No./Serial No.	Last Cal.
X	Power Meter	Anritsu	ML2495A/6K00003357	May, 2016
X	Power Sensor	Anritsu	MA2411B/0738448	Jun, 2015
	Spectrum Analyzer	R&S	FSP40 / 100170	Jun, 2015
	Spectrum Analyzer	Agilent	E4407B / US39440758	Jun, 2015
	Spectrum Analyzer	Agilent	N9010A / MY48030495	Apr., 2016

Note:

1. All equipments are calibrated with traceable calibrations. Each calibration is traceable to the national or international standards.
2. The test instruments marked with “X” are used to measure the final test results.

3.2. Test Setup

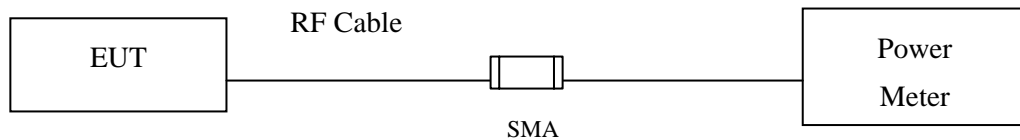

3.3. Limits

The maximum average power shall be less 1 Watt. (Section 15.247 (b)(3))

3.4. Test Procedure

The EUT was tested according to DTS test procedure of KDB 558074 for compliance to FCC 47CFR 15.247 requirements. The maximum peak conducted output power using KDB 558074 D01 DTS Meas Guidance v03r04 section 9.1.2 PKPM1 Peak power meter method.

3.5. Uncertainty

± 1.27 dB

3.6. Test Result of Maximum Conducted Power

Product : TABLET PC
 Test Item : Maximum Conducted Power
 Test Site : No.3 OATS
 Test Mode : Mode 1: Transmit (802.11b 1Mbps)

CHAIN A

Channel No	Frequency (MHz)	Average Power For different Data Rate (Mbps)				Peak Power	Required Limit	Result
		1	2	5.5	11			
		Measurement Level (dBm)						
01	2412	14.88	--	--	--	18.21	<30dBm	Pass
06	2437	15.53	15.51	15.48	15.46	19.44	<30dBm	Pass
11	2462	12.61	--	--	--	16.01	<30dBm	Pass

Note: Peak Power Output Value =Reading value on power meter + cable loss

CHAIN B

Channel No	Frequency (MHz)	Average Power For different Data Rate (Mbps)				Peak Power	Required Limit	Result
		1	2	5.5	11			
		Measurement Level (dBm)						
01	2412	15.09	--	--	--	18.34	<30dBm	Pass
06	2437	15.86	15.83	15.79	15.76	19.18	<30dBm	Pass
11	2462	12.88	--	--	--	16.18	<30dBm	Pass

Note: Peak Power Output Value =Reading value on power meter + cable loss

Product : TABLET PC
 Test Item : Maximum Conducted Power
 Test Site : No.3 OATS
 Test Mode : Mode 2: Transmit (802.11g 6Mbps)

CHAIN A

Channel No	Frequency (MHz)	Average Power For different Data Rate (Mbps)								Peak Power	Required Limit	Result
		6	9	12	18	24	36	48	54			
		Measurement Level (dBm)										
01	2412	12.76	--	--	--	--	--	--	--	18.26	<30dBm	Pass
06	2437	15.71	15.68	15.66	15.63	15.6	15.56	15.52	15.48	20.82	<30dBm	Pass
11	2462	10.81	--	--	--	--	--	--	--	14.31	<30dBm	Pass

Note: Peak Power Output Value =Reading value on power meter + cable loss

CHAIN B

Channel No	Frequency (MHz)	Average Power For different Data Rate (Mbps)								Peak Power	Required Limit	Result
		6	9	12	18	24	36	48	54			
		Measurement Level (dBm)										
01	2412	12.97	--	--	--	--	--	--	--	18.43	<30dBm	Pass
06	2437	15.94	15.91	15.89	15.87	15.84	15.82	15.78	15.75	21.1	<30dBm	Pass
11	2462	11.06	--	--	--	--	--	--	--	16.57	<30dBm	Pass

Note: Peak Power Output Value =Reading value on power meter + cable loss

Product : TABLET PC
 Test Item : Maximum Conducted Power
 Test Site : No.3 OATS
 Test Mode : Mode 3: Transmit - 802.11n-20BW_14.4Mbps(2.4G Band)

CHAIN A

Channel No	Frequency (MHz)	Average Power								Peak Power
		For different Data Rate (Mbps)								
		14.4	28.9	43.3	57.8	86.7	115.6	130	144.4	
		Measurement Level (dBm)								
01	2412	10	--	--	--	--	--	--	--	15.46
06	2437	14.22	14.19	14.16	14.14	14.12	14.09	14.07	14.03	19.91
11	2462	14.11	--	--	--	--	--	--	--	15.72

Note: Peak Power Output Value =Reading value on power meter + cable loss

CHAIN B

Channel No	Frequency (MHz)	Average Power								Peak Power
		For different Data Rate (Mbps)								
		14.4	28.9	43.3	57.8	86.7	115.6	130	144.4	
		Measurement Level (dBm)								
01	2412	10.7	--	--	--	--	--	--	--	16.36
06	2437	10.25	10.23	10.19	10.16	10.13	10.11	10.08	10.05	20.46
11	2462	10.61	--	--	--	--	--	--	--	16.27

Note: Peak Power Output Value =Reading value on power meter + cable loss

CHAIN A+B

Channel	Frequency (MHz)	Data Rata (Mbps)	Chain A Power (dBm)	Chain B Power (dBm)	Chain A+B Power (dBm)	Limit (dBm)	Result
1	2412	HT8	15.46	16.36	18.94	<30dBm	Pass
6	2437	HT8	19.91	20.46	23.20	<30dBm	Pass
11	2462	HT8	15.72	16.27	19.01	<30dBm	Pass

Note: Peak Power Output Value (dBm) = 10*LOG (Chain A (mW)+ Chain B (mW))

Product : TABLET PC
 Test Item : Maximum Conducted Power
 Test Site : No.3 OATS
 Test Mode : Mode 4: Transmit - 802.11n-40BW_30Mbps(2.4G Band)

CHAIN A

Channel No	Frequency (MHz)	Average Power								Peak Power
		For different Data Rate (Mbps)								
		30	60	90	120	180	240	270	300	
Measurement Level (dBm)										
3	2422	7.59	--	--	--	--	--	--	--	12.23
6	2437	11.97	11.93	11.91	11.88	11.86	11.83	11.79	11.77	17.07
9	2452	6.46	--	--	--	--	--	--	--	11.28

Note: Peak Power Output Value =Reading value on power meter + cable loss

CHAIN B

Channel No	Frequency (MHz)	Average Power								Peak Power
		For different Data Rate (Mbps)								
		30	60	90	120	180	240	270	300	
Measurement Level (dBm)										
3	2422	8.16	--	--	--	--	--	--	--	12.9
6	2437	11.95	11.93	11.9	11.88	11.85	11.82	11.78	11.75	17.3
9	2452	6.69	--	--	--	--	--	--	--	11.81

Note: Peak Power Output Value =Reading value on power meter + cable loss

CHAIN A+B

Channel	Frequency (MHz)	Data Rata (Mbps)	Chain A Power (dBm)	Chain B Power (dBm)	Chain A+B Power (dBm)	Limit (dBm)	Result
3	2422	30	12.23	12.90	15.59	<30dBm	Pass
6	2437	30	17.07	17.30	20.20	<30dBm	Pass
9	2452	30	11.28	11.81	14.56	<30dBm	Pass

Note: Peak Power Output Value (dBm) = 10*LOG (Chain A (mW)+ Chain B (mW))

4. Radiated Emission

4.1. Test Equipment

The following test equipments are used during the radiated emission test:

Test Site		Equipment	Manufacturer	Model No./Serial No.	Last Cal.
☒ Site # 3	X	Magnetic Loop Antenna	Teseq	HLA6121/ 37133	Sep, 2015
	X	Bilog Antenna	Schaffner Chase	CBL6112B/ 2707	Jun, 2015
	X	EMI Test Receiver	R&S	ESCS 30/838251/ 001	Jun, 2015
	X	Coaxial Cable	QTK(Arnist)	RG 214/ LC003-RG	Jun, 2015
	X	Coaxial signal switch	Arnist	MP59B/ 6200798682	Jun, 2015

Test Site		Equipment	Manufacturer	Model No./Serial No.	Last Cal.
☒ CB # 8	X	Spectrum Analyzer	R&S	FSP40/ 100339	Oct, 2015
	X	Horn Antenna	ETS-Lindgren	3117/ 35205	Mar, 2016
	X	Horn Antenna	Schwarzbeck	BBHA9170/209	Jan, 2016
	X	Horn Antenna	TRC	AH-0801/95051	Aug, 2015
	X	Pre-Amplifier	EMCI	EMC012630SE/980210	Jan, 2016
	X	Pre-Amplifier	MITEQ	JS41-001040000-58-5P/153945	Jul, 2015
	X	Pre-Amplifier	NARDA	DBL-1840N506/013	Jul, 2015

- Note:
1. All equipments are calibrated with traceable calibrations. Each calibration is traceable to the national or international standards.
 2. The test instruments marked with "X" are used to measure the final test results.

4.2. Test Setup

Radiated Emission Below 1GHz

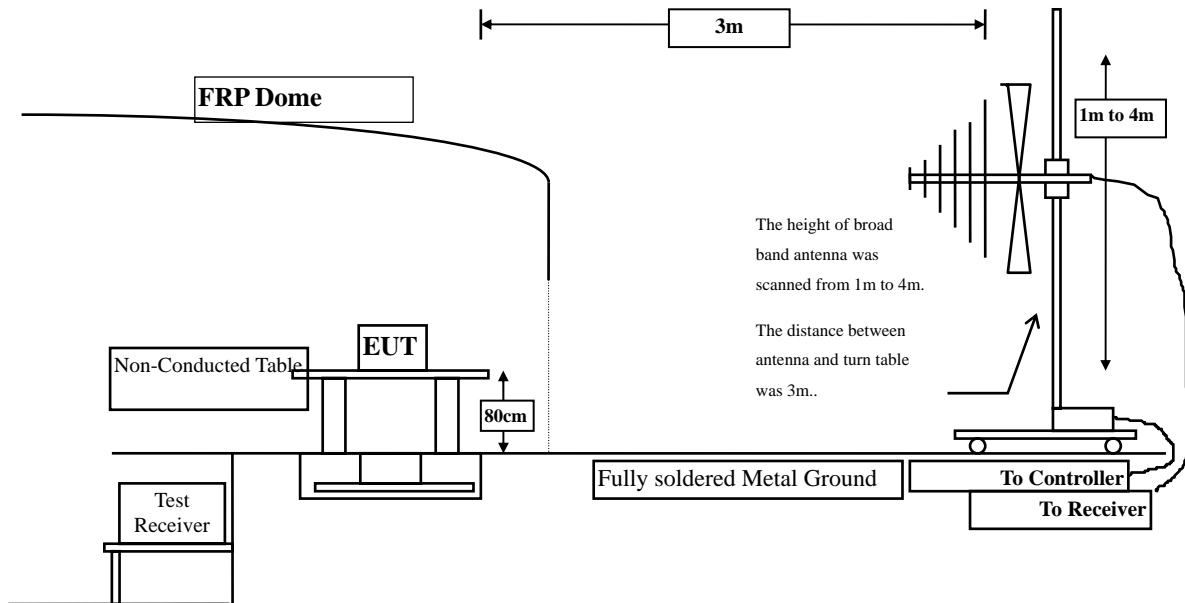

Radiated Emission Above 1GHz

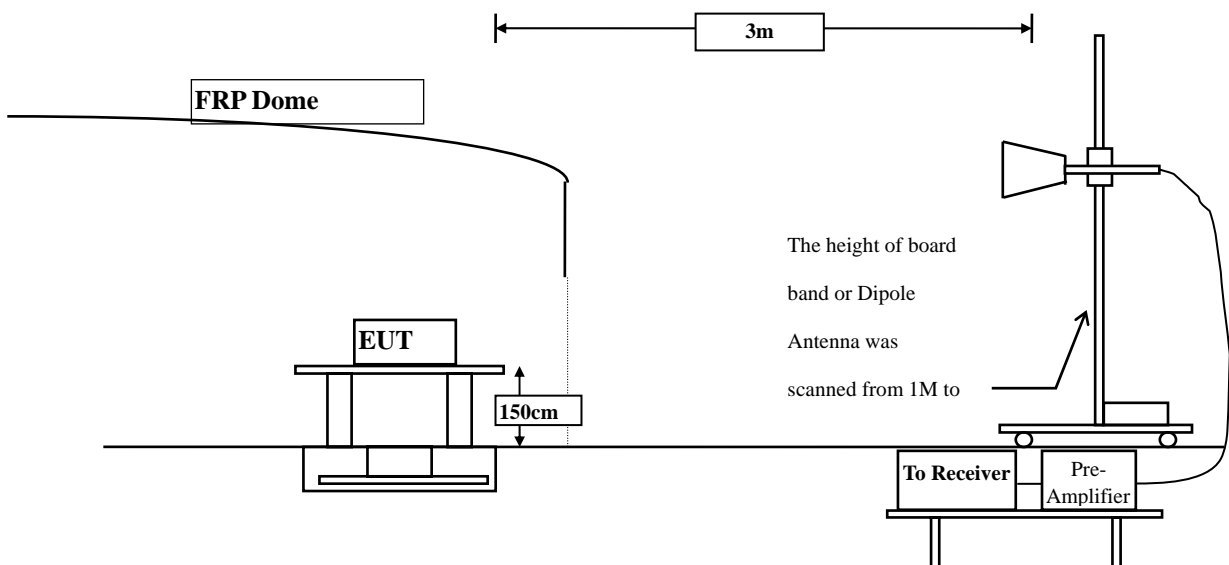

4.3. Limits

Emissions radiated outside of the specified frequency bands, except for harmonics, shall be attenuated by at least 30dB below the level of the fundamental or to the general radiated emission limits in paragraph 15.209, whichever is the lesser attenuation.

FCC Part 15 Subpart C Paragraph 15.209(a) Limits		
Frequency MHz	Field strength (microvolts/meter)	Measurement distance (meter)
0.009-0.490	2400/F(kHz)	300
0.490-1.705	24000/F(kHz)	30
1.705-30	30	30
30-88	100	3
88-216	150	3
216-960	200	3
Above 960	500	3

Remarks: E field strength (dBuV/m) = 20 log E field strength (uV/m)

4.4. Test Procedure

The EUT was setup according to ANSI C63.10: 2013 and tested according to DTS test procedure of KDB558074 for compliance to FCC 47CFR 15.247 requirements.

Measuring the frequency range below 1GHz, the EUT is placed on a turn table which is 0.8 meter above ground, when measuring the frequency range above 1GHz, the EUT is placed on a turn table which is 1.5 meter above ground.

The turn table is rotated 360 degrees to determine the position of the maximum emission level.

The EUT was positioned such that the distance from antenna to the EUT was 3 meters.

The antenna is scanned between 1 meter and 4 meters to find out the maximum emission level. This is repeated for both horizontal and vertical polarization of the antenna. In order to find the maximum emission, all of the interface cables were manipulated according to ANSI C63.10: 2013 on radiated measurement.

The resolution bandwidth below 30MHz setting on the field strength meter is 9kHz and 30MHz~1GHz is 120kHz and above 1GHz is 1MHz.

Radiated emission measurements below 30MHz are made using Loop Antenna and 30MHz~1GHz are made using broadband Bilog antenna and above 1GHz are made using Horn Antennas.

The measurement is divided into the Preliminary Measurement and the Final Measurement.

The suspected frequencies are searched for in Preliminary Measurement with the measurement antenna kept pointed at the source of the emission both in azimuth and elevation, with the polarization of the antenna oriented for maximum response. The antenna is pointed at an angle towards the source of the emission, and the EUT is rotated in both height and polarization to maximize the measured emission. The emission is kept within the illumination area of the 3 dB bandwidth of the antenna.

The worst radiated emission is measured in the Open Area Test Site on the Final Measurement.

The measurement frequency range from 9kHz - 10th Harmonic of fundamental was investigated.

4.5. Uncertainty

± 3.9 dB above 1GHz

± 3.8 dB below 1GHz

4.6. Test Result of Radiated Emission

Product : TABLET PC
Test Item : Harmonic Radiated Emission Data
Test Site : No.3 OATS
Test Mode : Mode 1: Transmit (802.11b 1Mbps) (2412MHz)

Frequency MHz	Correct Factor dB	Reading Level dBuV	Measurement Level dBuV/m	Margin dB	Limit dBuV/m
Horizontal					
Peak Detector:					
4824.000	2.428	30.528	32.957	-41.043	74.000
7236.000	9.177	29.251	38.428	-35.572	74.000
9648.000	10.019	36.552	46.572	-27.428	74.000
Average Detector:					
--					
Vertical					
Peak Detector:					
4824.000	2.836	41.891	44.728	-29.272	74.000
7236.000	9.676	36.150	45.826	-28.174	74.000
9648.000	10.556	38.960	49.517	-24.483	74.000
Average Detector:					
--					

Note:

1. All Readings below 1GHz are Quasi-Peak, above 1GHz are performed with peak and/or average measurements as necessary.
2. Peak measurements: RBW = 1MHz, VBW = 3 MHz, Sweep: Auto.
3. Average measurements: RBW = 1MHz, VBW = 10 Hz, Sweep: Auto.
4. Measurement Level = Reading Level + Correct Factor.
5. Correct Factor = Antenna factor + Cable loss – Amplifier gain.
6. The average measurement was not performed when the peak measured data under the limit of average detection.
7. The emission levels of other frequencies are very lower than the limit and not show in test report.

Product : TABLET PC
Test Item : Harmonic Radiated Emission Data
Test Site : No.3 OATS
Test Mode : Mode 1: Transmit (802.11b 1Mbps) (2437 MHz)

Frequency	Correct	Reading	Measurement	Margin	Limit
MHz	Factor	Level	Level	dB	dBuV/m
	dB	dBuV	dBuV/m		

Horizontal

Peak Detector:

4874.000	2.076	30.818	32.895	-41.105	74.000
7311.000	9.512	28.632	38.144	-35.856	74.000
9748.000	9.630	36.372	46.002	-27.998	74.000

**Average
Detector:**

--

Vertical

Peak Detector:

4874.000	2.532	41.875	44.407	-29.593	74.000
7311.000	10.089	35.459	45.548	-28.452	74.000
9748.000	10.266	39.102	49.369	-24.631	74.000

**Average
Detector:**

--

Note:

1. All Readings below 1GHz are Quasi-Peak, above 1GHz are performed with peak and/or average measurements as necessary.
2. Peak measurements: RBW = 1MHz, VBW = 3 MHz, Sweep: Auto.
3. Average measurements: RBW = 1MHz, VBW = 10 Hz, Sweep: Auto.
4. Measurement Level = Reading Level + Correct Factor.
5. Correct Factor = Antenna factor + Cable loss –Amplifier gain.
6. The average measurement was not performed when the peak measured data under the limit of average detection.
7. The emission levels of other frequencies are very lower than the limit and not show in test report.

Product : TABLET PC
Test Item : Harmonic Radiated Emission Data
Test Site : No.3 OATS
Test Mode : Mode 1: Transmit (802.11b 1Mbps) (2462 MHz)

Frequency MHz	Correct Factor dB	Reading Level dBuV	Measurement Level dBuV/m	Margin dB	Limit dBuV/m
Horizontal					
Peak Detector:					
4924.000	2.191	30.282	32.473	-41.527	74.000
7386.000	10.373	29.053	39.427	-34.573	74.000
9848.000	9.964	37.890	47.854	-26.146	74.000
Average Detector:					
--					
Vertical					
Peak Detector:					
4924.000	2.805	41.231	44.036	-29.964	74.000
7386.000	11.180	35.175	46.355	-27.645	74.000
9848.000	10.801	39.692	50.493	-23.507	74.000
Average Detector:					
--					

Note:

1. All Readings below 1GHz are Quasi-Peak, above 1GHz are performed with peak and/or average measurements as necessary.
2. Peak measurements: RBW = 1MHz, VBW = 3 MHz, Sweep: Auto.
3. Average measurements: RBW = 1MHz, VBW = 10 Hz, Sweep: Auto.
4. Measurement Level = Reading Level + Correct Factor.
5. Correct Factor = Antenna factor + Cable loss – Amplifier gain.
6. The average measurement was not performed when the peak measured data under the limit of average detection.
7. The emission levels of other frequencies are very lower than the limit and not show in test report.

Product : TABLET PC
Test Item : Harmonic Radiated Emission Data
Test Site : No.3 OATS
Test Mode : Mode 2: Transmit (802.11g 6Mbps) (2412MHz)

Frequency MHz	Correct Factor dB	Reading Level dBuV	Measurement Level dBuV/m	Margin dB	Limit dBuV/m
Horizontal					
Peak Detector:					
4824.000	2.428	30.588	33.017	-40.983	74.000
7236.000	9.177	29.023	38.200	-35.800	74.000
9648.000	10.019	36.111	46.131	-27.869	74.000
Average Detector:					
--					
Vertical					
Peak Detector:					
4824.000	2.836	42.486	45.323	-28.677	74.000
7236.000	9.676	36.351	46.027	-27.973	74.000
9648.000	10.556	39.219	49.776	-24.224	74.000
Average Detector:					
--					

Note:

1. All Readings below 1GHz are Quasi-Peak, above 1GHz are performed with peak and/or average measurements as necessary.
2. Peak measurements: RBW = 1MHz, VBW = 3 MHz, Sweep: Auto.
3. Average measurements: RBW = 1MHz, VBW = 10 Hz, Sweep: Auto.
4. Measurement Level = Reading Level + Correct Factor.
5. Correct Factor = Antenna factor + Cable loss – Amplifier gain.
6. The average measurement was not performed when the peak measured data under the limit of average detection.
7. The emission levels of other frequencies are very lower than the limit and not show in test report.

Product : TABLET PC
Test Item : Harmonic Radiated Emission Data
Test Site : No.3 OATS
Test Mode : Mode 2: Transmit (802.11g 6Mbps) (2437 MHz)

Frequency MHz	Correct Factor dB	Reading Level dBuV	Measurement Level dBuV/m	Margin dB	Limit dBuV/m
Horizontal					
Peak Detector:					
4874.000	2.076	31.015	33.092	-40.908	74.000
7311.000	9.512	29.246	38.758	-35.242	74.000
9748.000	9.630	37.386	47.016	-26.984	74.000
Average Detector:					
--					
Vertical					
Peak Detector:					
4874.000	2.532	42.734	45.266	-28.734	74.000
7311.000	10.089	35.877	45.966	-28.034	74.000
9748.000	10.266	39.529	49.796	-24.204	74.000
Average Detector:					
--					

Note:

1. All Readings below 1GHz are Quasi-Peak, above 1GHz are performed with peak and/or average measurements as necessary.
2. Peak measurements: RBW = 1MHz, VBW = 3 MHz, Sweep: Auto.
3. Average measurements: RBW = 1MHz, VBW = 10 Hz, Sweep: Auto.
4. Measurement Level = Reading Level + Correct Factor.
5. Correct Factor = Antenna factor + Cable loss – Amplifier gain.
6. The average measurement was not performed when the peak measured data under the limit of average detection.
7. The emission levels of other frequencies are very lower than the limit and not show in test report.

Product : TABLET PC
 Test Item : Harmonic Radiated Emission Data
 Test Site : No.3 OATS
 Test Mode : Mode 2: Transmit (802.11g 6Mbps) (2462 MHz)

Frequency MHz	Correct Factor dB	Reading Level dBuV	Measurement Level dBuV/m	Margin dB	Limit dBuV/m
Horizontal					
Peak Detector:					
4924.000	2.191	30.782	32.973	-41.027	74.000
7386.000	10.373	29.201	39.575	-34.425	74.000
9848.000	9.964	36.429	46.393	-27.607	74.000
Average Detector:					
--					
Vertical					
Peak Detector:					
4924.000	2.805	42.306	45.111	-28.889	74.000
7386.000	11.180	35.127	46.307	-27.693	74.000
9848.000	10.801	40.287	51.088	-22.912	74.000
Average Detector:					
--					

Note:

1. All Readings below 1GHz are Quasi-Peak, above 1GHz are performed with peak and/or average measurements as necessary.
2. Peak measurements: RBW = 1MHz, VBW = 3 MHz, Sweep: Auto.
3. Average measurements: RBW = 1MHz, VBW = 10 Hz, Sweep: Auto.
4. Measurement Level = Reading Level + Correct Factor.
5. Correct Factor = Antenna factor + Cable loss – Amplifier gain.
6. The average measurement was not performed when the peak measured data under the limit of average detection.
7. The emission levels of other frequencies are very lower than the limit and not show in test report.

Product : TABLET PC
Test Item : Harmonic Radiated Emission Data
Test Site : No.3 OATS
Test Mode : Mode 3: Transmit - 802.11n-20BW_14.4Mbps(2.4G Band) (2412MHz)

Frequency MHz	Correct Factor dB	Reading Level dBuV	Measurement Level dBuV/m	Margin dB	Limit dBuV/m
Horizontal					
Peak Detector:					
4824.000	2.428	30.956	33.385	-40.615	74.000
7236.000	9.177	28.865	38.042	-35.958	74.000
9648.000	10.019	36.107	46.127	-27.873	74.000
Average Detector:					
--					
Vertical					
Peak Detector:					
4824.000	2.836	42.099	44.936	-29.064	74.000
7236.000	9.676	36.839	46.515	-27.485	74.000
9648.000	10.556	39.716	50.273	-23.727	74.000
Average Detector:					
--					

Note:

1. All Readings below 1GHz are Quasi-Peak, above 1GHz are performed with peak and/or average measurements as necessary.
2. Peak measurements: RBW = 1MHz, VBW = 3 MHz, Sweep: Auto.
3. Average measurements: RBW = 1MHz, VBW = 10 Hz, Sweep: Auto.
4. Measurement Level = Reading Level + Correct Factor.
5. Correct Factor = Antenna factor + Cable loss – Amplifier gain.
6. The average measurement was not performed when the peak measured data under the limit of average detection.
7. The emission levels of other frequencies are very lower than the limit and not show in test report.

Product : TABLET PC
 Test Item : Harmonic Radiated Emission Data
 Test Site : No.3 OATS
 Test Mode : Mode 3: Transmit - 802.11n-20BW_14.4Mbps(2.4G Band) (2437 MHz)

Frequency MHz	Correct Factor dB	Reading Level dBuV	Measurement Level dBuV/m	Margin dB	Limit dBuV/m
Horizontal					
Peak Detector:					
4874.000	2.076	31.289	33.366	-40.634	74.000
7311.000	9.512	29.347	38.859	-35.141	74.000
9748.000	9.630	37.392	47.022	-26.978	74.000
Average Detector:					
--					
Vertical					
Peak Detector:					
4874.000	2.532	42.415	44.947	-29.053	74.000
7311.000	10.089	35.989	46.078	-27.922	74.000
9748.000	10.266	39.444	49.711	-24.289	74.000
Average Detector:					
--					

Note:

1. All Readings below 1GHz are Quasi-Peak, above 1GHz are performed with peak and/or average measurements as necessary.
2. Peak measurements: RBW = 1MHz, VBW = 3 MHz, Sweep: Auto.
3. Average measurements: RBW = 1MHz, VBW = 10 Hz, Sweep: Auto.
4. Measurement Level = Reading Level + Correct Factor.
5. Correct Factor = Antenna factor + Cable loss – Amplifier gain.
6. The average measurement was not performed when the peak measured data under the limit of average detection.
7. The emission levels of other frequencies are very lower than the limit and not show in test report.

Product : TABLET PC
Test Item : Harmonic Radiated Emission Data
Test Site : No.3 OATS
Test Mode : Mode 3: Transmit - 802.11n-20BW_14.4Mbps(2.4G Band) (2462 MHz)

Frequency MHz	Correct Factor dB	Reading Level dBuV	Measurement Level dBuV/m	Margin dB	Limit dBuV/m
Horizontal					
Peak Detector:					
4924.000	2.191	31.162	33.353	-40.647	74.000
7386.000	10.373	28.141	38.515	-35.485	74.000
9848.000	9.964	38.553	48.517	-25.483	74.000
Average Detector:					
--					
Vertical					
Peak Detector:					
4924.000	2.805	42.164	44.969	-29.031	74.000
7386.000	11.180	35.272	46.452	-27.548	74.000
9848.000	10.801	40.269	51.070	-22.930	74.000
Average Detector:					
--					

Note:

1. All Readings below 1GHz are Quasi-Peak, above 1GHz are performed with peak and/or average measurements as necessary.
2. Peak measurements: RBW = 1MHz, VBW = 3 MHz, Sweep: Auto.
3. Average measurements: RBW = 1MHz, VBW = 10 Hz, Sweep: Auto.
4. Measurement Level = Reading Level + Correct Factor.
5. Correct Factor = Antenna factor + Cable loss – Amplifier gain.
6. The average measurement was not performed when the peak measured data under the limit of average detection.
7. The emission levels of other frequencies are very lower than the limit and not show in test report.

Product : TABLET PC
Test Item : Harmonic Radiated Emission Data
Test Site : No.3 OATS
Test Mode : Mode 4: Transmit - 802.11n-40BW_30Mbps(2.4G Band) (2422MHz)

Frequency MHz	Correct Factor dB	Reading Level dBuV	Measurement Level dBuV/m	Margin dB	Limit dBuV/m
Horizontal					
Peak Detector:					
4844.000	2.280	31.707	33.988	-40.012	74.000
7266.000	9.106	28.703	37.809	-36.191	74.000
9688.000	9.663	36.474	46.137	-27.863	74.000
Average Detector:					
--					
Vertical					
Peak Detector:					
4844.000	2.707	42.958	45.666	-28.334	74.000
7266.000	9.626	36.632	46.258	-27.742	74.000
9688.000	10.284	39.571	49.855	-24.145	74.000
Average Detector:					
--					
--					

Note:

1. All Readings below 1GHz are Quasi-Peak, above 1GHz are performed with peak and/or average measurements as necessary.
2. Peak measurements: RBW = 1MHz, VBW = 3 MHz, Sweep: Auto.
3. Average measurements: RBW = 1MHz, VBW = 10 Hz, Sweep: Auto.
4. Measurement Level = Reading Level + Correct Factor.
5. Correct Factor = Antenna factor + Cable loss – Amplifier gain.
6. The average measurement was not performed when the peak measured data under the limit of average detection.
7. The emission levels of other frequencies are very lower than the limit and not show in test report.

Product : TABLET PC
 Test Item : Harmonic Radiated Emission Data
 Test Site : No.3 OATS
 Test Mode : Mode 4: Transmit - 802.11n-40BW_30Mbps(2.4G Band) (2437 MHz)

Frequency MHz	Correct Factor dB	Reading Level dBuV	Measurement Level dBuV/m	Margin dB	Limit dBuV/m
Horizontal					
Peak Detector:					
4874.000	2.076	31.368	33.445	-40.555	74.000
7311.000	9.512	28.429	37.941	-36.059	74.000
9748.000	9.630	37.372	47.002	-26.998	74.000
Average Detector:					
--					
Vertical					
Peak Detector:					
4874.000	2.532	42.695	45.227	-28.773	74.000
7311.000	10.089	36.112	46.201	-27.799	74.000
9748.000	10.266	39.764	50.031	-23.969	74.000
Average Detector:					
--					

Note:

1. All Readings below 1GHz are Quasi-Peak, above 1GHz are performed with peak and/or average measurements as necessary.
2. Peak measurements: RBW = 1MHz, VBW = 3 MHz, Sweep: Auto.
3. Average measurements: RBW = 1MHz, VBW = 10 Hz, Sweep: Auto.
4. Measurement Level = Reading Level + Correct Factor.
5. Correct Factor = Antenna factor + Cable loss – Amplifier gain.
6. The average measurement was not performed when the peak measured data under the limit of average detection.
7. The emission levels of other frequencies are very lower than the limit and not show in test report.

Product : TABLET PC
Test Item : Harmonic Radiated Emission Data
Test Site : No.3 OATS
Test Mode : Mode 4: Transmit - 802.11n-40BW_30Mbps(2.4G Band) (2452 MHz)

Frequency MHz	Correct Factor dB	Reading Level dBuV	Measurement Level dBuV/m	Margin dB	Limit dBuV/m
Horizontal					
Peak Detector:					
4904.000	2.000	31.777	33.778	-40.222	74.000
7356.000	10.308	28.187	38.495	-35.505	74.000
9808.000	9.850	38.443	48.293	-25.707	74.000
Average Detector:					
--					
Vertical					
Peak Detector:					
4904.000	2.513	42.910	45.424	-28.576	74.000
7356.000	11.022	34.953	45.975	-28.025	74.000
9808.000	10.512	39.722	50.234	-23.766	74.000
Average Detector:					
--					

Note:

1. All Readings below 1GHz are Quasi-Peak, above 1GHz are performed with peak and/or average measurements as necessary.
2. Peak measurements: RBW = 1MHz, VBW = 3 MHz, Sweep: Auto.
3. Average measurements: RBW = 1MHz, VBW = 10 Hz, Sweep: Auto.
4. Measurement Level = Reading Level + Correct Factor.
5. Correct Factor = Antenna factor + Cable loss –Amplifier gain.
6. The average measurement was not performed when the peak measured data under the limit of average detection.
7. The emission levels of other frequencies are very lower than the limit and not show in test report.

Product : TABLET PC
 Test Item : General Radiated Emission Data
 Test Site : No.3 OATS
 Test Mode : Mode 1: Transmit (802.11b 1Mbps) (2437 MHz)

Frequency MHz	Correct Factor dB	Reading Level dBuV	Measurement Level dBuV/m	Margin dB	Limit dBuV/m
Horizontal					
239.520	-6.878	36.848	29.970	-16.030	46.000
405.390	0.794	24.906	25.700	-20.300	46.000
523.730	3.158	27.627	30.785	-15.215	46.000
661.470	1.880	26.938	28.818	-17.182	46.000
805.030	6.223	25.367	31.590	-14.410	46.000
929.190	7.420	26.103	33.523	-12.477	46.000
Vertical					
178.410	-0.966	26.292	25.326	-18.174	43.500
378.230	0.769	27.329	28.098	-17.902	46.000
540.220	2.169	25.473	27.642	-18.358	46.000
677.960	0.840	26.077	26.917	-19.083	46.000
826.370	2.879	24.176	27.055	-18.945	46.000
959.260	3.100	24.981	28.081	-17.919	46.000

Note:

1. All Readings below 1GHz are Quasi-Peak, above 1GHz are performed with peak and/or average measurements as necessary.
2. Peak measurements: RBW = 1MHz, VBW = 3 MHz, Sweep: Auto.
3. Average measurements: RBW = 1MHz, VBW = 10 Hz, Sweep: Auto.
4. Measurement Level = Reading Level + Correct Factor.
5. Correct Factor = Antenna factor + Cable loss – Amplifier gain.
6. The average measurement was not performed when the peak measured data under the limit of average detection.
7. The emission levels of other frequencies are very lower than the limit and not show in test report.
8. No emission found between lowest internal used/generated frequency to 30MHz.

Product : TABLET PC
 Test Item : General Radiated Emission Data
 Test Site : No.3 OATS
 Test Mode : Mode 2: Transmit (802.11g 6Mbps) (2437 MHz)

Frequency MHz	Correct Factor dB	Reading Level dBuV	Measurement Level dBuV/m	Margin dB	Limit dBuV/m
Horizontal					
239.520	-6.878	34.899	28.021	-17.979	46.000
383.080	1.305	27.479	28.784	-17.216	46.000
523.730	3.158	27.328	30.486	-15.514	46.000
626.550	1.363	25.633	26.995	-19.005	46.000
757.500	5.107	25.991	31.098	-14.902	46.000
918.520	6.718	27.379	34.097	-11.903	46.000
Vertical					
179.380	-0.824	25.927	25.103	-18.397	43.500
373.380	0.043	23.071	23.114	-22.886	46.000
532.460	1.209	22.170	23.379	-22.621	46.000
687.660	2.292	24.533	26.825	-19.175	46.000
838.980	1.961	22.943	24.904	-21.096	46.000
969.930	3.896	25.240	29.136	-24.864	54.000

Note:

1. All Readings below 1GHz are Quasi-Peak, above 1GHz are performed with peak and/or average measurements as necessary.
2. Peak measurements: RBW = 1MHz, VBW = 3 MHz, Sweep: Auto.
3. Average measurements: RBW = 1MHz, VBW = 10 Hz, Sweep: Auto.
4. Measurement Level = Reading Level + Correct Factor.
5. Correct Factor = Antenna factor + Cable loss – Amplifier gain.
6. The average measurement was not performed when the peak measured data under the limit of average detection.
7. The emission levels of other frequencies are very lower than the limit and not show in test report.
8. No emission found between lowest internal used/generated frequency to 30MHz.

Product : TABLET PC
 Test Item : General Radiated Emission Data
 Test Site : No.3 OATS
 Test Mode : Mode 3: Transmit - 802.11n-20BW_14.4Mbps(2.4G Band) (2437 MHz)

Frequency MHz	Correct Factor dB	Reading Level dBuV	Measurement Level dBuV/m	Margin dB	Limit dBuV/m
Horizontal					
307.420	-4.120	31.668	27.548	-18.452	46.000
429.640	0.630	24.276	24.905	-21.095	46.000
549.920	3.662	25.636	29.297	-16.703	46.000
677.960	2.830	22.645	25.475	-20.525	46.000
794.360	6.387	25.871	32.258	-13.742	46.000
913.670	6.430	23.421	29.851	-16.149	46.000
Vertical					
176.470	-1.530	27.509	25.979	-17.521	43.500
338.460	-1.640	27.486	25.845	-20.155	46.000
460.680	-1.930	26.764	24.834	-21.166	46.000
635.280	-1.412	27.809	26.397	-19.603	46.000
753.620	2.730	25.932	28.662	-17.338	46.000
903.970	1.199	26.092	27.291	-18.709	46.000

Note:

1. All Readings below 1GHz are Quasi-Peak, above 1GHz are performed with peak and/or average measurements as necessary.
2. Peak measurements: RBW = 1MHz, VBW = 3 MHz, Sweep: Auto.
3. Average measurements: RBW = 1MHz, VBW = 10 Hz, Sweep: Auto.
4. Measurement Level = Reading Level + Correct Factor.
5. Correct Factor = Antenna factor + Cable loss – Amplifier gain.
6. The average measurement was not performed when the peak measured data under the limit of average detection.
7. The emission levels of other frequencies are very lower than the limit and not show in test report.
8. No emission found between lowest internal used/generated frequency to 30MHz.

Product : TABLET PC
Test Item : General Radiated Emission Data
Test Site : No.3 OATS
Test Mode : Mode 4: Transmit - 802.11n-40BW_30Mbps(2.4G Band) (2437 MHz)

Frequency MHz	Correct Factor dB	Reading Level dBuV	Measurement Level dBuV/m	Margin dB	Limit dBuV/m
Horizontal					
261.830	-5.466	31.073	25.607	-20.393	46.000
370.470	0.839	27.538	28.377	-17.623	46.000
499.480	1.991	25.902	27.892	-18.108	46.000
629.460	1.212	26.884	28.096	-17.904	46.000
770.110	5.122	23.572	28.694	-17.306	46.000
897.180	5.487	24.955	30.442	-15.558	46.000
Vertical					
174.530	-2.247	26.233	23.985	-19.515	43.500
391.810	-0.963	27.016	26.053	-19.947	46.000
553.800	-1.923	27.393	25.470	-20.530	46.000
672.140	-0.561	26.653	26.092	-19.908	46.000
805.030	3.583	26.761	30.344	-15.656	46.000
931.130	3.650	21.433	25.083	-20.917	46.000

Note:

1. All Readings below 1GHz are Quasi-Peak, above 1GHz are performed with peak and/or average measurements as necessary.
2. Peak measurements: RBW = 1MHz, VBW = 3 MHz, Sweep: Auto.
3. Average measurements: RBW = 1MHz, VBW = 10 Hz, Sweep: Auto.
4. Measurement Level = Reading Level + Correct Factor.
5. Correct Factor = Antenna factor + Cable loss – Amplifier gain.
6. The average measurement was not performed when the peak measured data under the limit of average detection.
7. The emission levels of other frequencies are very lower than the limit and not show in test report.
8. No emission found between lowest internal used/generated frequency to 30MHz.

5. RF Antenna conducted test

5.1. Test Equipment

	Equipment	Manufacturer	Model No./Serial No.	Last Cal.
X	Spectrum Analyzer	R&S	FSP40 / 100170	Jun, 2015
	Spectrum Analyzer	Agilent	E4407B / US39440758	Jun, 2015
X	Spectrum Analyzer	Agilent	N9010A / MY48030495	Apr., 2016

- Note:
1. All equipments are calibrated with traceable calibrations. Each calibration is traceable to the national or international standards.
 2. The test instruments marked with “X” are used to measure the final test results.

5.2. Test Setup

RF antenna Conducted Measurement:

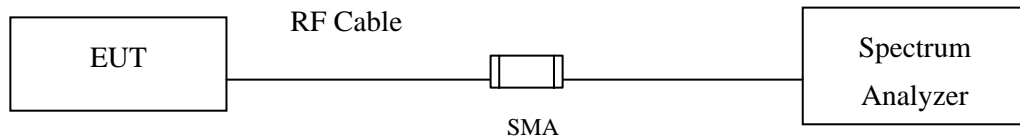

5.3. Limits

In any 100 kHz bandwidth outside the frequency band in which the spread spectrum intentional radiator is operating, the radio frequency power that is produced by the intentional radiator shall be at least 30 dB below that in the 100 kHz bandwidth within the band that contains the highest level of the desired power, based on either an RF conducted or a radiated measurement. Attenuation below the general limits specified in Section 15.209(a) is not required. In addition, radiated emissions which fall in the restricted bands, as defined in Section 15.205(a), must also comply with the radiated emission limits specified in Section 15.209(a) (see Section 15.205(c)).

5.4. Test Procedure

The EUT was tested according to DTS test procedure of KDB558074 for compliance to FCC 47CFR 15.247 requirements.

Set RBW = 100 kHz, Set VBW > RBW, scan up through 10th harmonic.

5.5. Uncertainty

The measurement uncertainty

Conducted is defined as $\pm 1.27\text{dB}$

5.6. Test Result of RF antenna conducted test

Product : TABLET PC
 Test Item : RF antenna conducted test
 Test Site : No.3 OATS
 Test Mode : Mode 1: Transmit (802.11b 1Mbps)

Channel 01 (2412MHz) 30MHz-25GHz

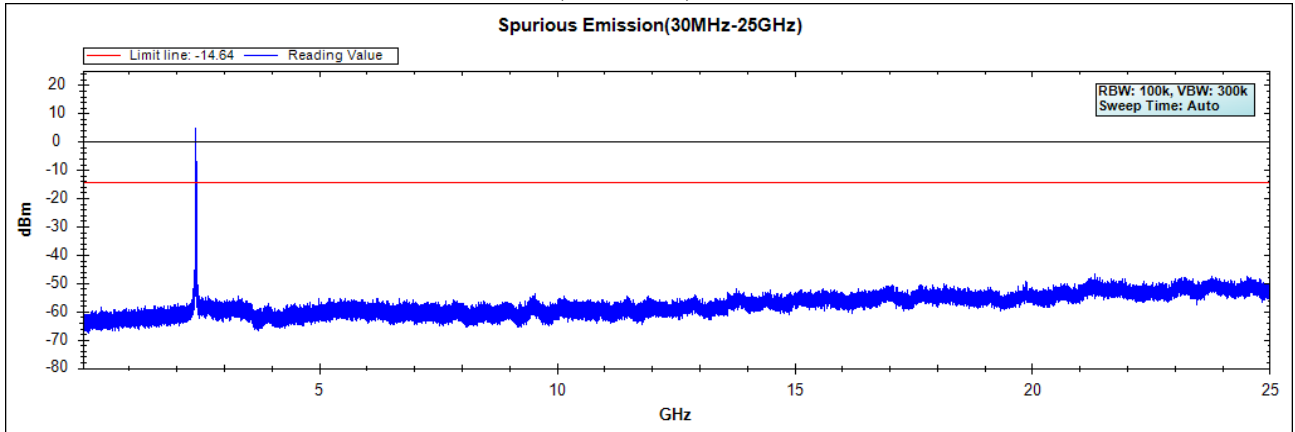

Channel 06 (2437MHz) 30MHz -25GHz

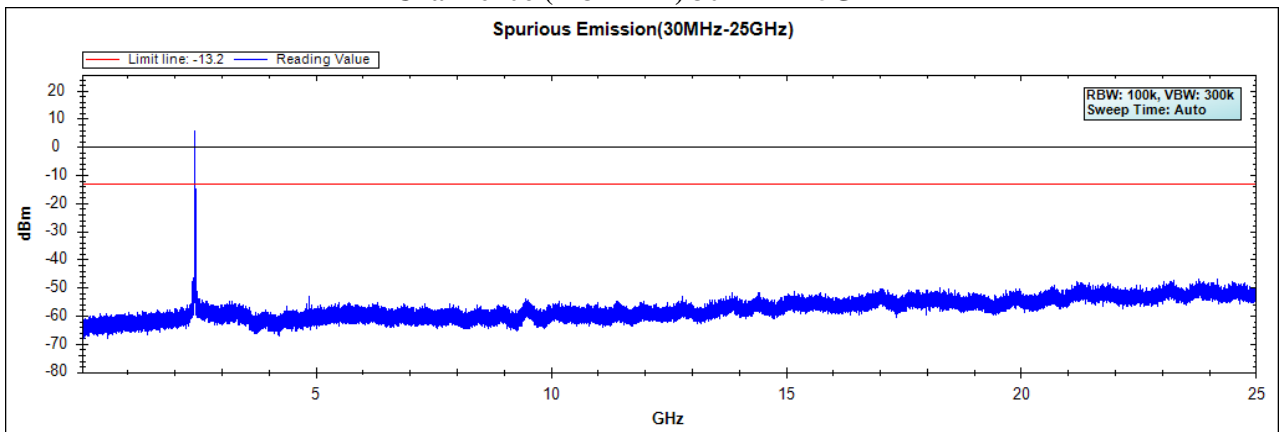

Channel 11 (2462MHz) 30MHz -25GHz

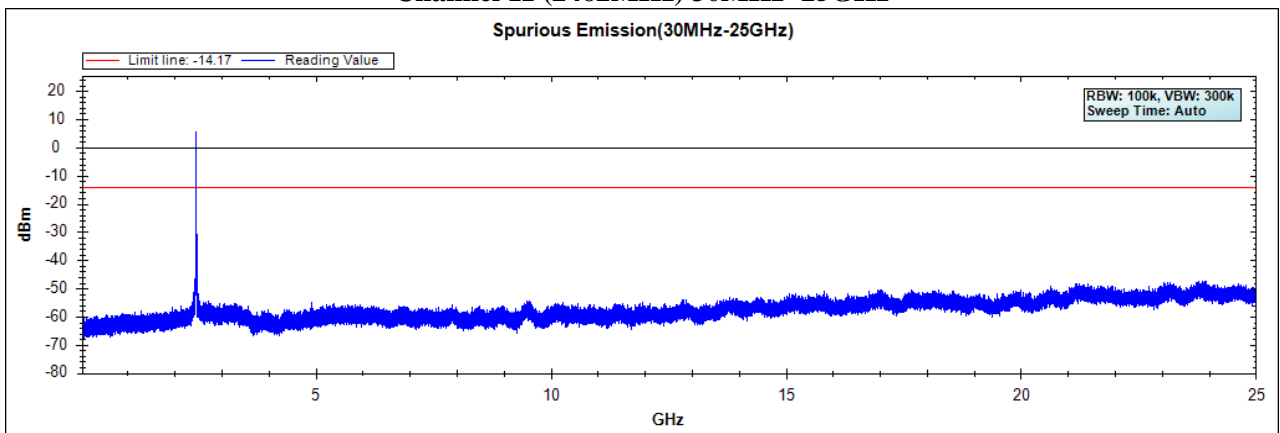

Note: The above test pattern is synthesized by multiple of the frequency range.

Product : TABLET PC
 Test Item : RF Antenna Conducted Spurious
 Test Site : No.3 OATS
 Test Mode : Mode 2: Transmit (802.11g 6Mbps)

Channel 01 (2412MHz) 30MHz -25GHz

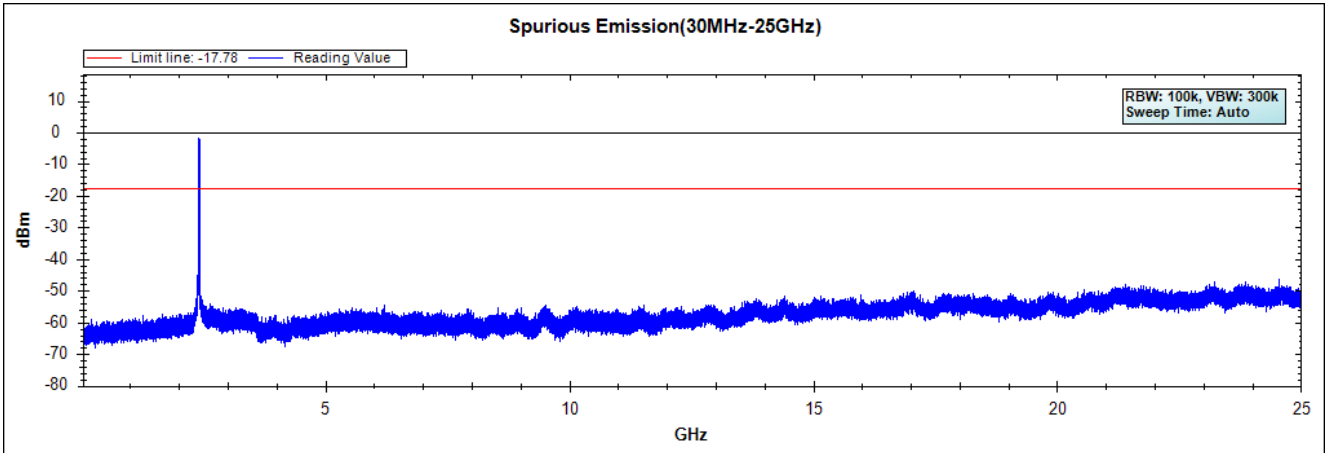

Channel 06 (2437MHz) 30MHz -25GHz

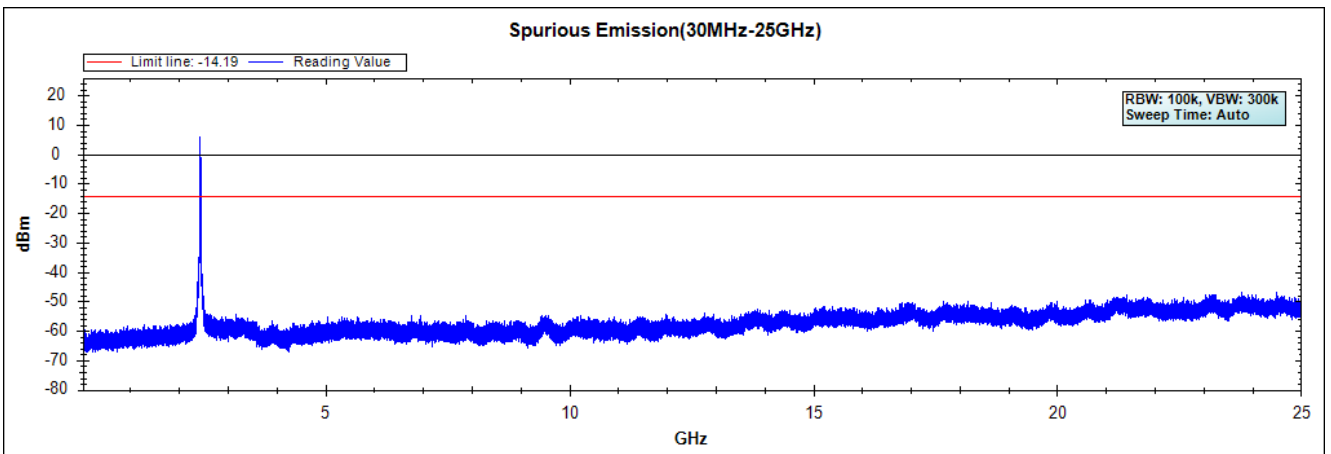

Channel 11 (2462MHz) 30MHz -25GHz

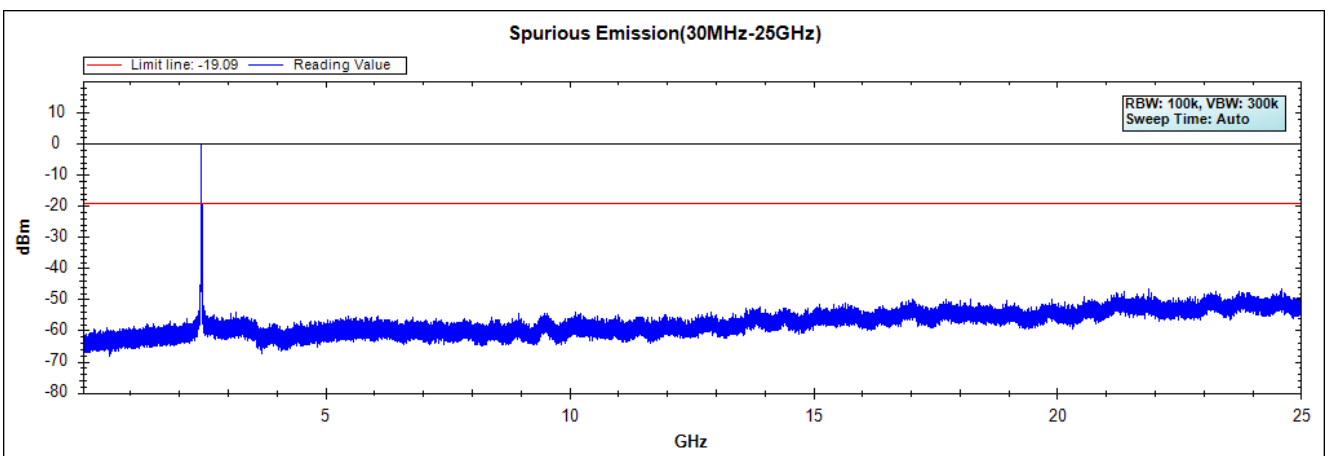

Note: The above test pattern is synthesized by multiple of the frequency range.

Product : TABLET PC
Test Item : RF Antenna Conducted Spurious
Test Site : No.3 OATS
Test Mode : Mode 3: Transmit - 802.11n-20BW_14.4Mbps(2.4G Band)

Channel 01 (2412MHz) 30MHz -25GHz-Chain A

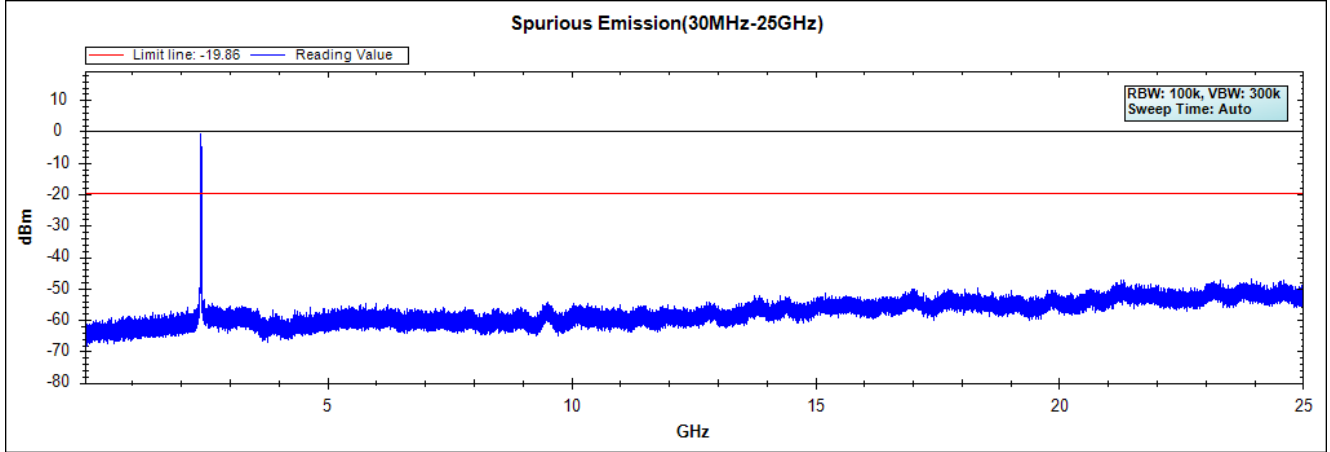

Channel 06 (2437MHz) 30MHz -25GHz-Chain A

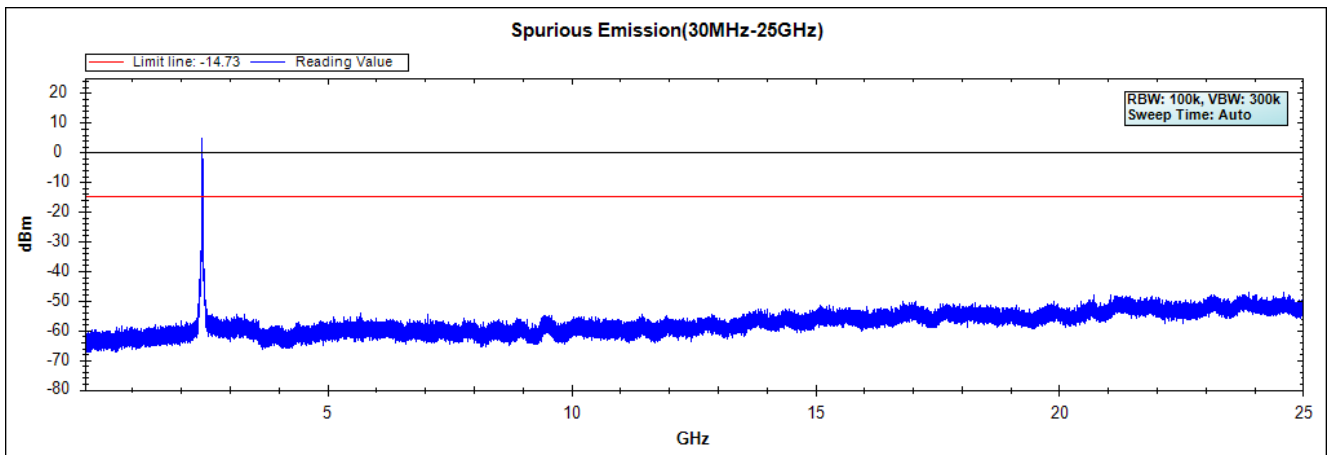

Channel 11 (2462MHz) 30MHz -25GHz-Chain A

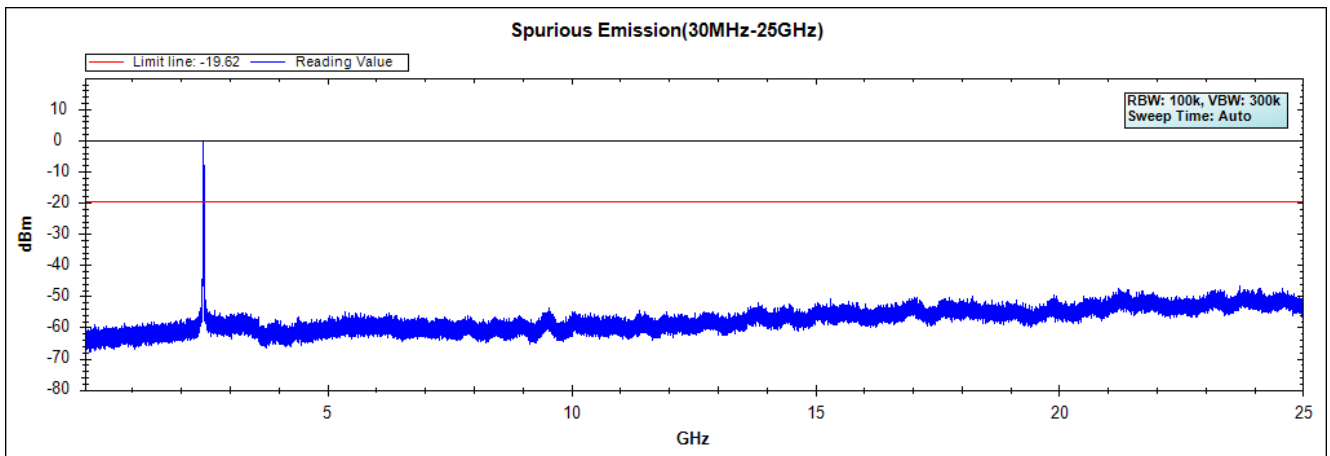

Note: The above test pattern is synthesized by multiple of the frequency range.

Channel 01 (2412MHz) 30MHz -25GHz-Chain B

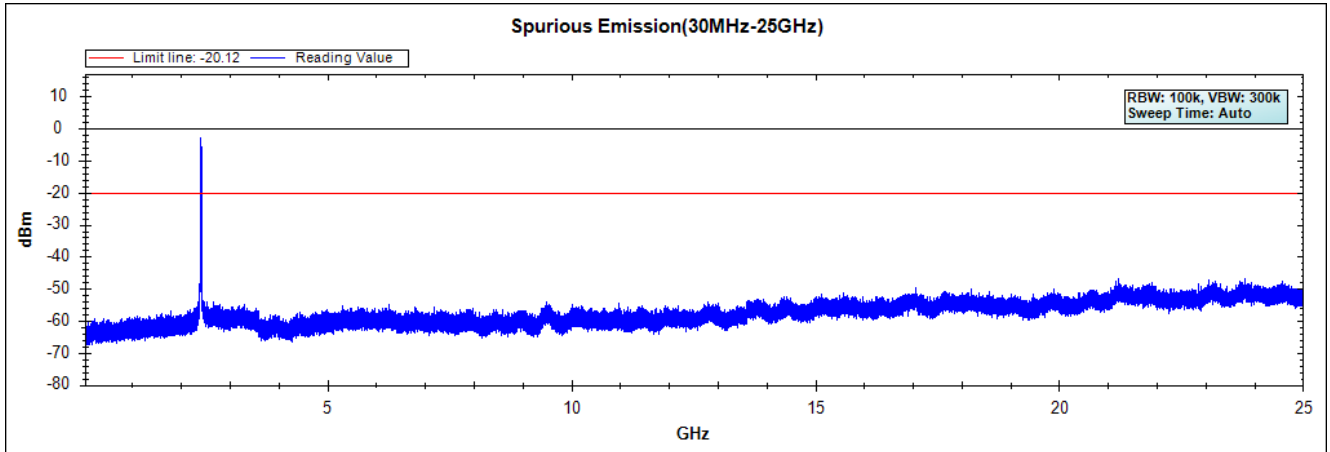

Channel 06 (2437MHz) 30MHz -25GHz-Chain B

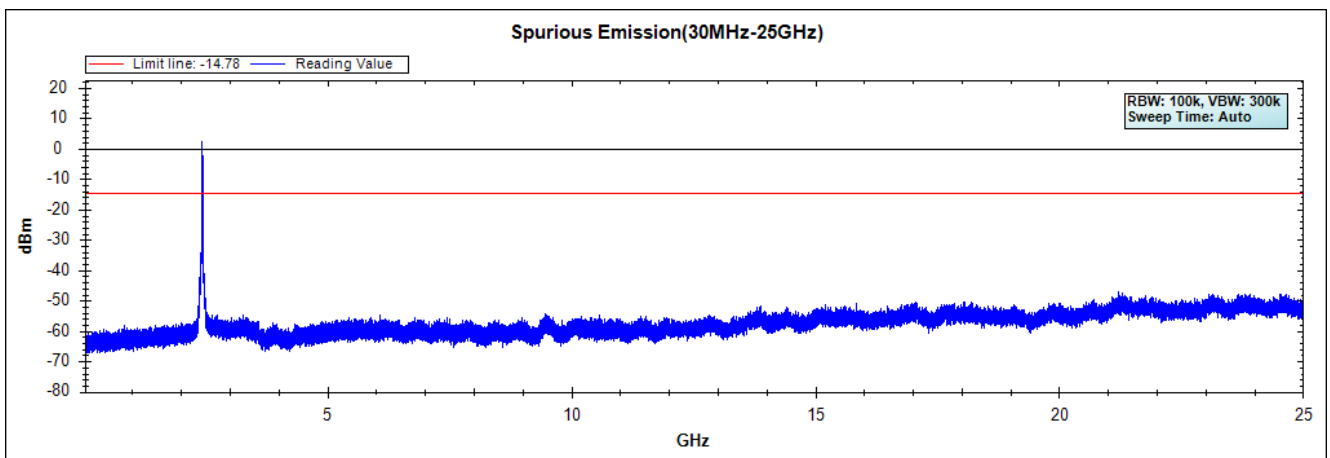

Channel 11 (2462MHz) 30MHz -25GHz-Chain B

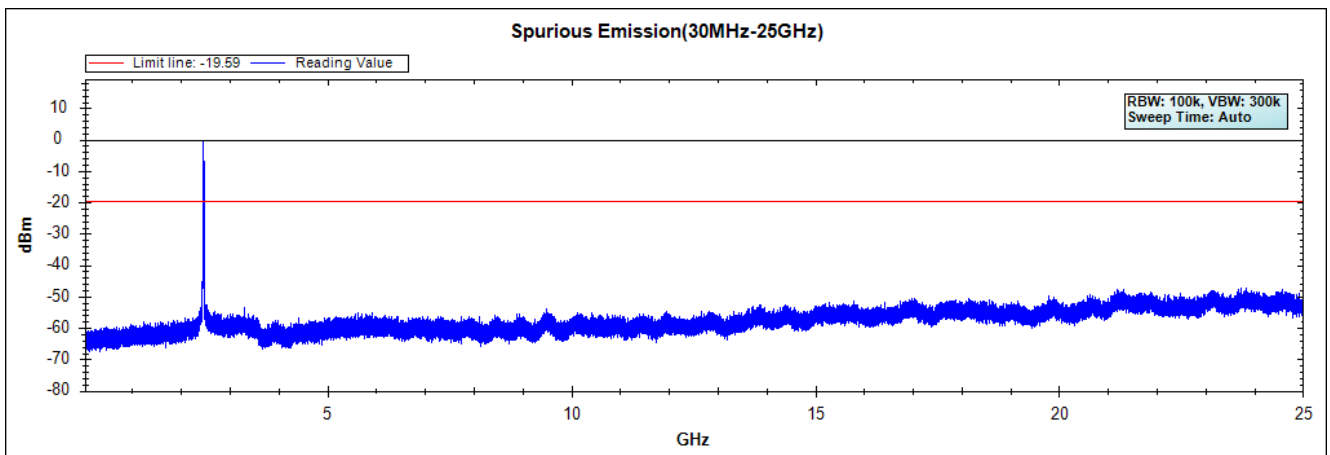

Note: The above test pattern is synthesized by multiple of the frequency range.

Product : TABLET PC
Test Item : RF Antenna Conducted Spurious
Test Site : No.3 OATS
Test Mode : Mode 4: Transmit - 802.11n-40BW_30Mbps(2.4G Band)

Channel 03 (2422MHz) 30MHz -25GHz-Chain A

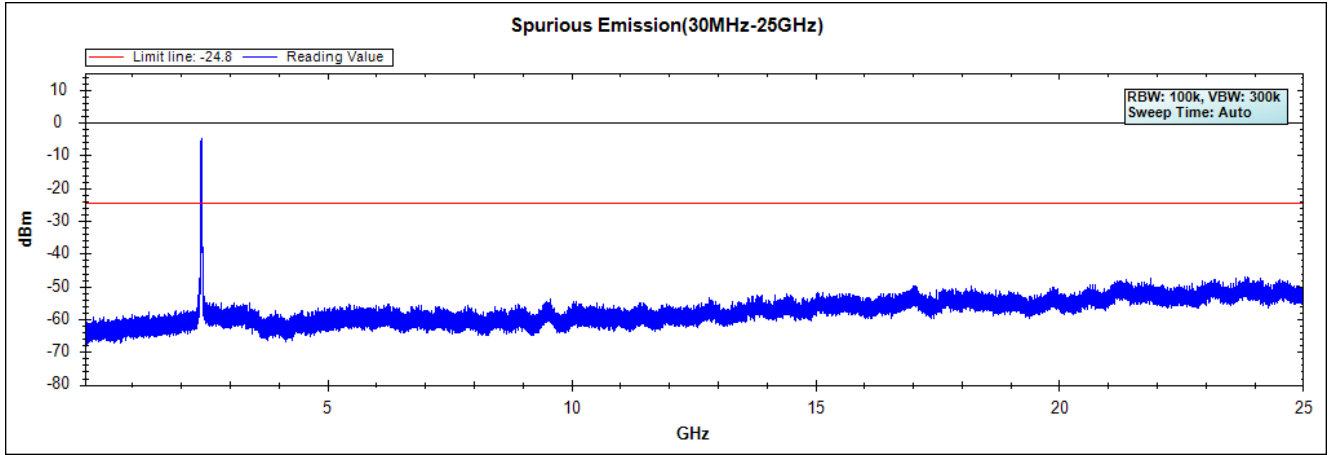

Channel 06 (2437MHz) 30MHz -25GHz-Chain A

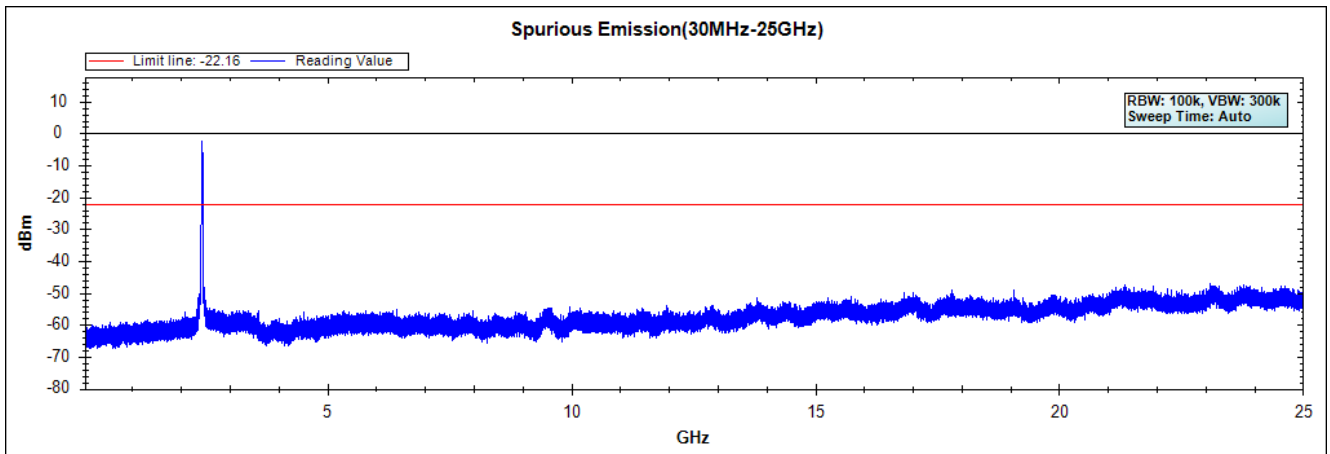

Channel 09 (2452MHz) 30MHz -25GHz-Chain A

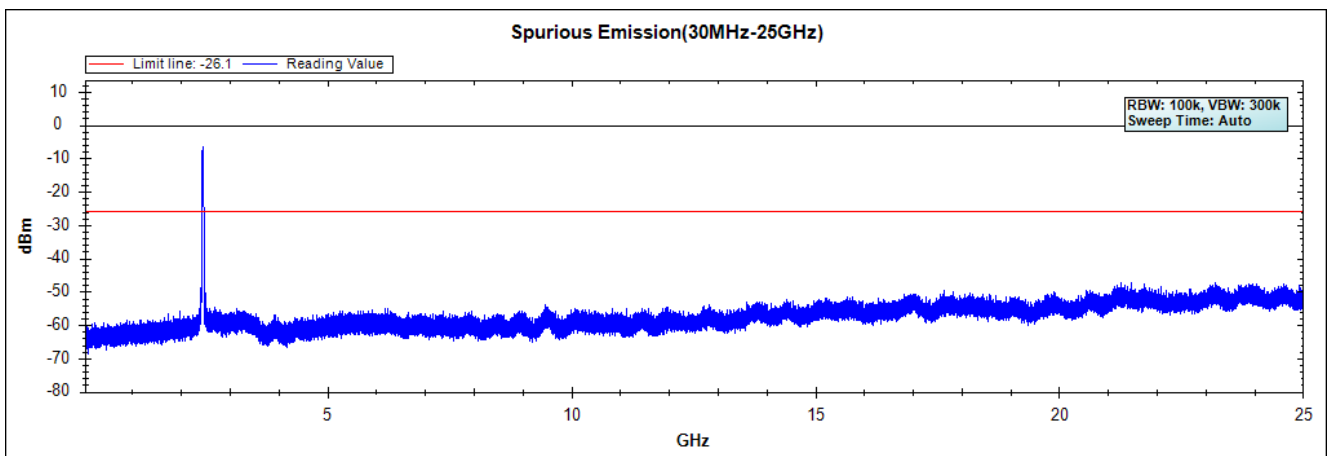

Note: The above test pattern is synthesized by multiple of the frequency range.

Channel 03 (2422MHz) 30MHz -25GHz-Chain B

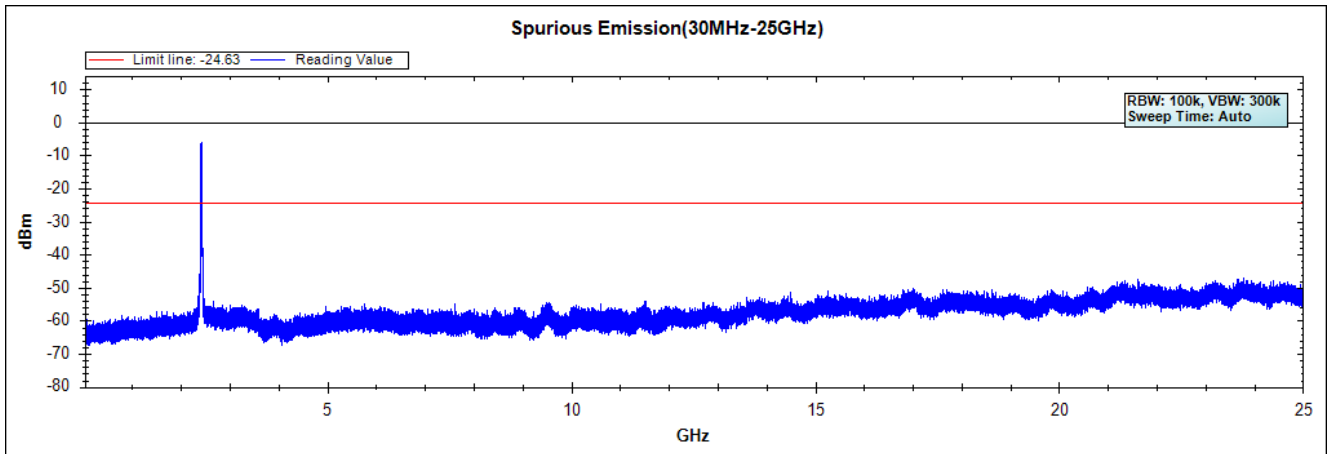

Channel 06 (2437MHz) 30MHz -25GHz-Chain B

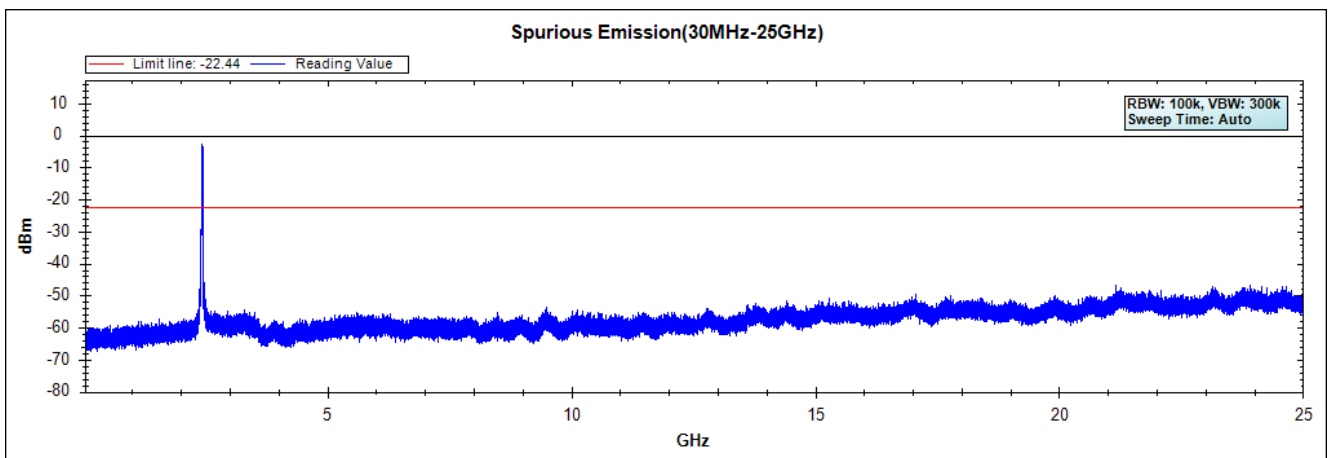

Channel 09 (2452MHz) 30MHz -25GHz-Chain B

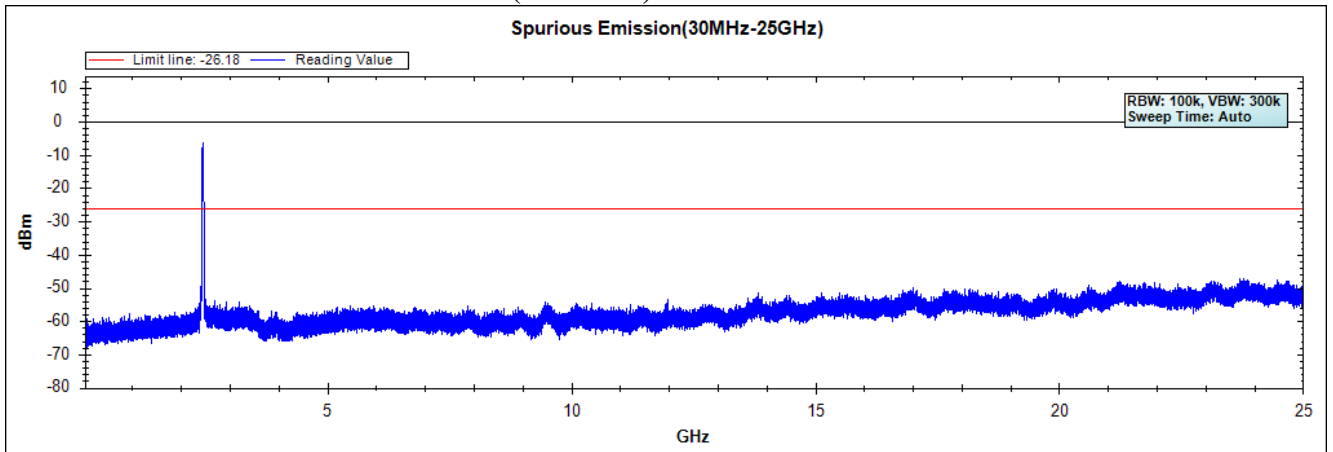

Note: The above test pattern is synthesized by multiple of the frequency range.

6. Band Edge

6.1. Test Equipment

RF Conducted Measurement

The following test equipments are used during the band edge tests:

	Equipment	Manufacturer	Model No./Serial No.	Last Cal.
	Spectrum Analyzer	R&S	FSP40 / 100170	Jun, 2015
	Spectrum Analyzer	Agilent	E4407B / US39440758	Jun, 2015
X	Spectrum Analyzer	Agilent	N9010A / MY48030495	Apr., 2016

Note:

1. All equipments are calibrated with traceable calibrations. Each calibration is traceable to the national or international standards.
2. The test instruments marked with “X” are used to measure the final test results.

RF Radiated Measurement:

The following test equipments are used during the band edge tests:

Test Site		Equipment	Manufacturer	Model No./Serial No.	Last Cal.
☒ CB # 8	X	Spectrum Analyzer	R&S	FSP40/ 100339	Oct, 2015
	X	Horn Antenna	ETS-Lindgren	3117/ 35205	Mar, 2016
	X	Horn Antenna	Schwarzbeck	BBHA9170/209	Jan, 2016
	X	Horn Antenna	TRC	AH-0801/95051	Aug, 2015
	X	Pre-Amplifier	EMCI	EMC012630SE/980210	Jan, 2016
	X	Pre-Amplifier	MITEQ	JS41-001040000-58-5P/153945	Jul, 2015
	X	Pre-Amplifier	NARDA	DBL-1840N506/013	Jul, 2015

- Note:
1. All equipments are calibrated with traceable calibrations. Each calibration is traceable to the national or international standards.
 2. The test instruments marked with “X” are used to measure the final test results.

6.2. Test Setup

RF Conducted Measurement

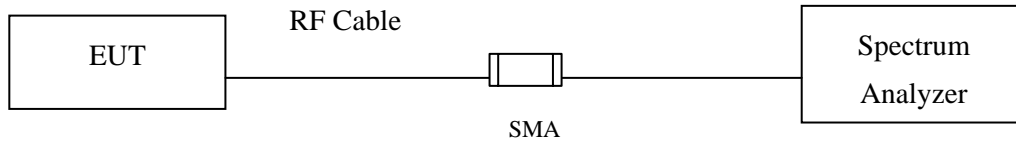

RF Radiated Measurement:

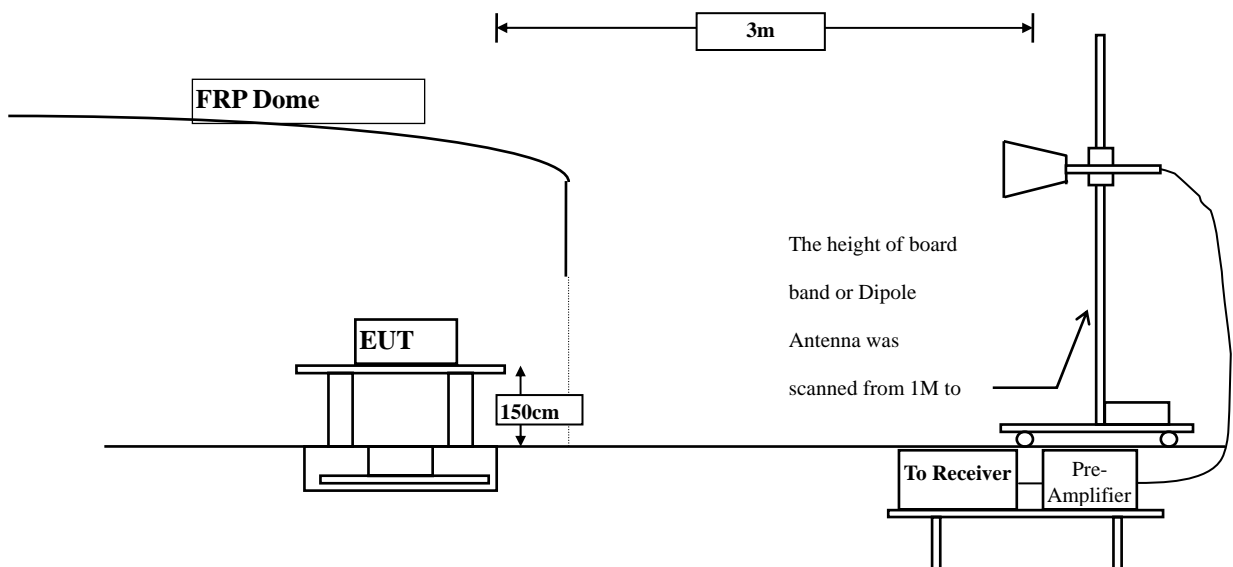

6.3. Limits

Emissions radiated outside of the specified frequency bands, except for harmonics, shall be attenuated by at least 30dB below the level of the fundamental or to the general radiated emission limits in paragraph 15.209, whichever is the lesser attenuation.

6.4. Test Procedure

The EUT was setup according to ANSI C63.10, 2013 and tested according to DTS test procedure of KDB558074 for compliance to FCC 47CFR 15.247 requirements.

The EUT is placed on a turn table which is 1.5 meter above ground. The turn table is rotated 360 degrees to determine the position of the maximum emission level. The EUT was positioned such that the distance from antenna to the EUT was 3 meters.

The antenna is scanned from 1 meter to 4 meters to find out the maximum emission level. This is repeated for both horizontal and vertical polarization of the antenna. In order to find the maximum emission, all of the interface cables were manipulated according to ANSI C63.10:2013 on radiated measurement.

6.5. Uncertainty

± 3.9 dB above 1GHz

± 3.8 dB below 1GHz

6.6. Test Result of Band Edge

Product : TABLET PC
 Test Item : Band Edge
 Test Site : No.3 OATS
 Test Mode : Mode 1: Transmit (802.11b 1Mbps)

RF Radiated Measurement (Horizontal):

Channel No.	Frequency (MHz)	Correct Factor (dB)	Reading Level (dBuV)	Emission Level (dBuV/m)	Peak Limit (dBuV/m)	Average Limit (dBuV/m)	Result
01 (Peak)	2386.232	31.494	28.321	59.815	74.00	54.00	Pass
01 (Peak)	2390.000	31.509	27.628	59.137	74.00	54.00	Pass
01 (Peak)	2397.102	31.544	33.812	65.356	--	--	--
01 (Peak)	2400.000	31.561	28.668	60.229	--	--	--
01 (Peak)	2411.014	31.630	68.007	99.638	--	--	--
01 (Average)	2386.087	31.494	16.278	47.772	74.00	54.00	Pass
01 (Average)	2390.000	31.509	16.055	47.564	74.00	54.00	Pass
01 (Average)	2396.667	31.541	27.276	58.817	--	--	--
01 (Average)	2400.000	31.561	20.689	52.250	--	--	--
01 (Average)	2412.754	31.644	64.516	96.160	--	--	--

Figure Channel 01: Horizontal (Peak)

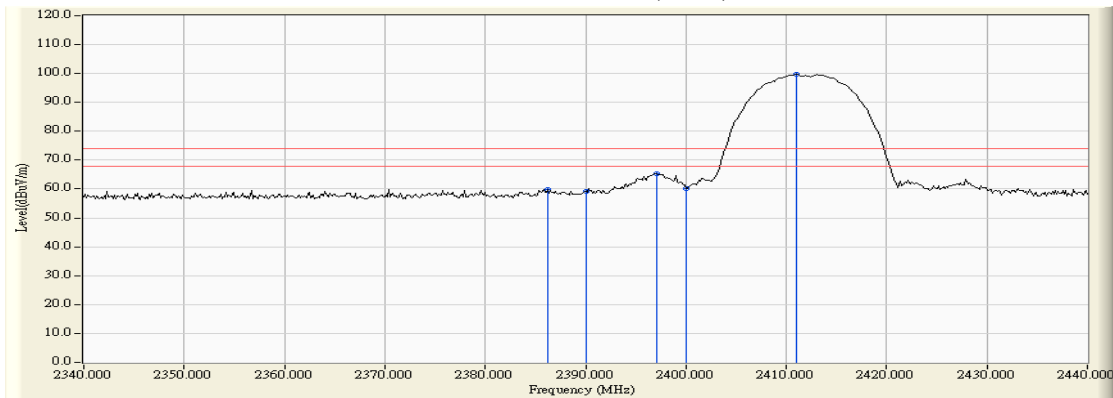
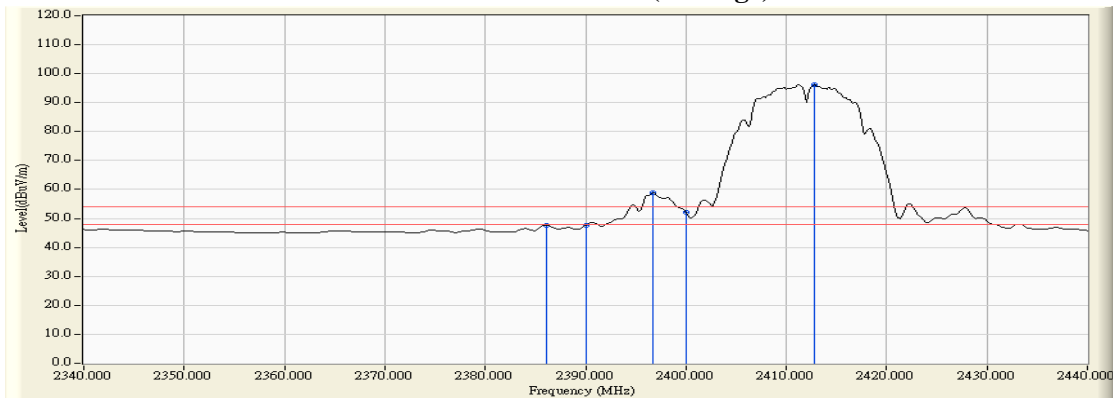

Figure Channel 01: Horizontal (Average)



- Note: 1. All readings above 1GHz are performed with peak and/or average measurements as necessary.
 2. Peak measurements: RBW = 1MHz, VBW = 3 MHz, Sweep: Auto.
 3. Average measurements: RBW = 1MHz, VBW = 10 Hz, Sweep: Auto.
 4. “ * ”, means this data is the worst emission level.
 5. Measurement Level = Reading Level + Correct Factor.
 6. The average measurement was not performed when the peak measured data under the limit of average detection.

Product : TABLET PC
 Test Item : Band Edge
 Test Site : No.3 OATS
 Test Mode : Mode 1: Transmit (802.11b 1Mbps)

RF Radiated Measurement (Vertical):

Channel No.	Frequency (MHz)	Correct Factor (dB)	Reading Level (dBuV)	Emission Level (dBuV/m)	Peak Limit (dBuV/m)	Average Limit (dBuV/m)	Result
01 (Peak)	2389.565	30.917	29.609	60.526	74.00	54.00	Pass
01 (Peak)	2390.000	30.915	29.084	59.999	74.00	54.00	Pass
01 (Peak)	2397.101	30.905	36.421	67.326	--	--	--
01 (Peak)	2400.000	30.912	31.437	62.349	--	--	--
01 (Peak)	2413.043	30.957	73.474	104.430	--	--	--
01 (Average)	2388.696	30.921	18.767	49.688	74.00	54.00	Pass
01 (Average)	2390.000	30.915	17.482	48.397	74.00	54.00	Pass
01 (Average)	2396.812	30.904	30.104	61.008	--	--	--
01 (Average)	2400.000	30.912	24.346	55.258	--	--	--
01 (Average)	2412.754	30.955	69.982	100.936	--	--	--

Figure Channel 01: Vertical (Peak)

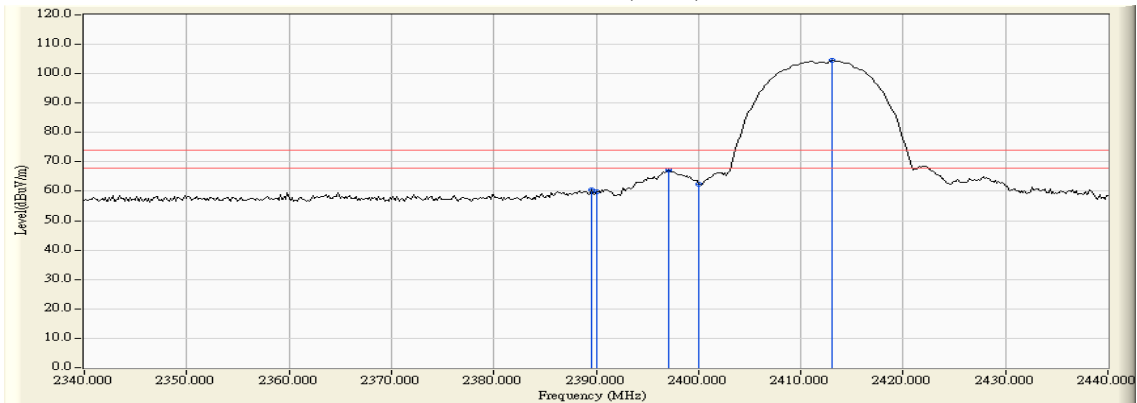

Figure Channel 01: Vertical (Average)



Note:

1. All readings above 1GHz are performed with peak and/or average measurements as necessary.
2. Peak measurements: RBW = 1MHz, VBW = 3 MHz, Sweep: Auto.
3. Average measurements: RBW = 1MHz, VBW = 10 Hz, Sweep: Auto.
4. “ * ”, means this data is the worst emission level.
5. Measurement Level = Reading Level + Correct Factor.
6. The average measurement was not performed when the peak measured data under the limit of average detection.

Product : TABLET PC
 Test Item : Band Edge
 Test Site : No.3 OATS
 Test Mode : Mode 1: Transmit (802.11b 1Mbps)

RF Radiated Measurement (Horizontal):

Channel No.	Frequency (MHz)	Correct Factor (dB)	Reading Level (dBuV)	Emission Level (dBuV/m)	Peak Limit (dBuV/m)	Average Limit (dBuV/m)	Result
11 (Peak)	2460.891	32.011	70.023	102.034	--	--	--
11 (Peak)	2483.500	32.182	28.368	60.550	74.00	54.00	Pass
11 (Peak)	2494.514	32.265	29.231	61.496	74.00	54.00	Pass
11 (Average)	2461.181	32.014	66.476	98.489	--	--	--
11 (Average)	2483.500	32.182	16.401	48.583	74.00	54.00	Pass
11 (Average)	2486.688	32.207	16.447	48.653	74.00	54.00	Pass

Figure Channel 11: Horizontal (Peak)

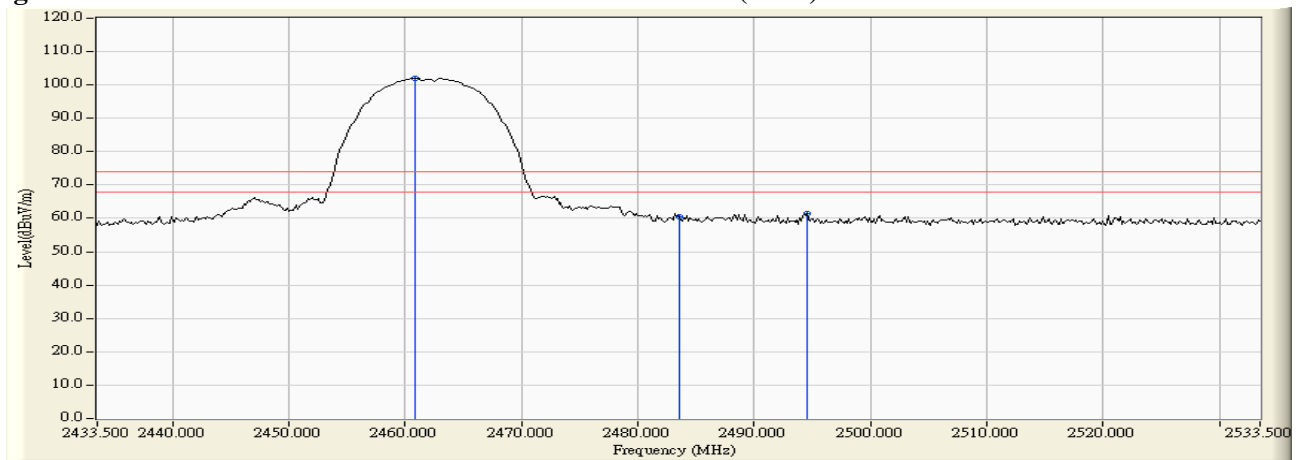
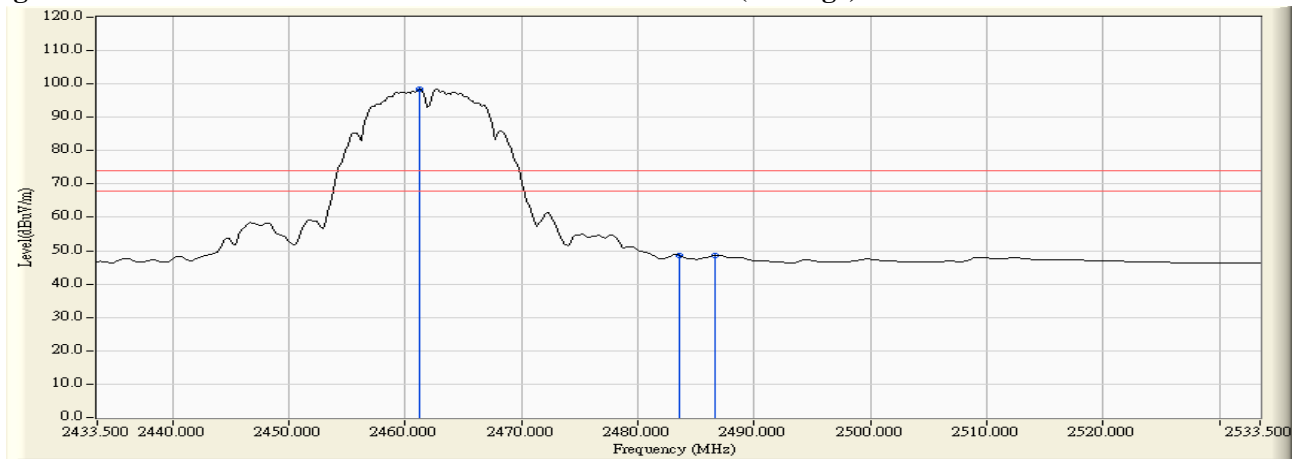

Figure Channel 11: Horizontal (Average)



Note:

1. All readings above 1GHz are performed with peak and/or average measurements as necessary.
2. Peak measurements: RBW = 1MHz, VBW = 3 MHz, Sweep: Auto.
3. Average measurements: RBW = 1MHz, VBW = 10 Hz, Sweep: Auto.
4. “ * ”, means this data is the worst emission level.
5. Measurement Level = Reading Level + Correct Factor.
6. The average measurement was not performed when the peak measured data under the limit of average detection.

Product : TABLET PC
 Test Item : Band Edge
 Test Site : No.3 OATS
 Test Mode : Mode 1: Transmit (802.11b 1Mbps)

RF Radiated Measurement (Vertical):

Channel No.	Frequency (MHz)	Correct Factor (dB)	Reading Level (dBuV)	Emission Level (dBuV/m)	Peak Limit (dBuV/m)	Average Limit (dBuV/m)	Result
11 (Peak)	2460.891	31.283	70.427	101.710	--	--	--
11 (Peak)	2483.500	31.435	29.957	61.392	74.00	54.00	Pass
11 (Peak)	2488.138	31.467	30.040	61.507	74.00	54.00	Pass
11 (Average)	2462.630	31.295	66.729	98.024	--	--	--
11 (Average)	2483.500	31.435	17.850	49.285	74.00	54.00	Pass

Figure Channel 11: Vertical (Peak)

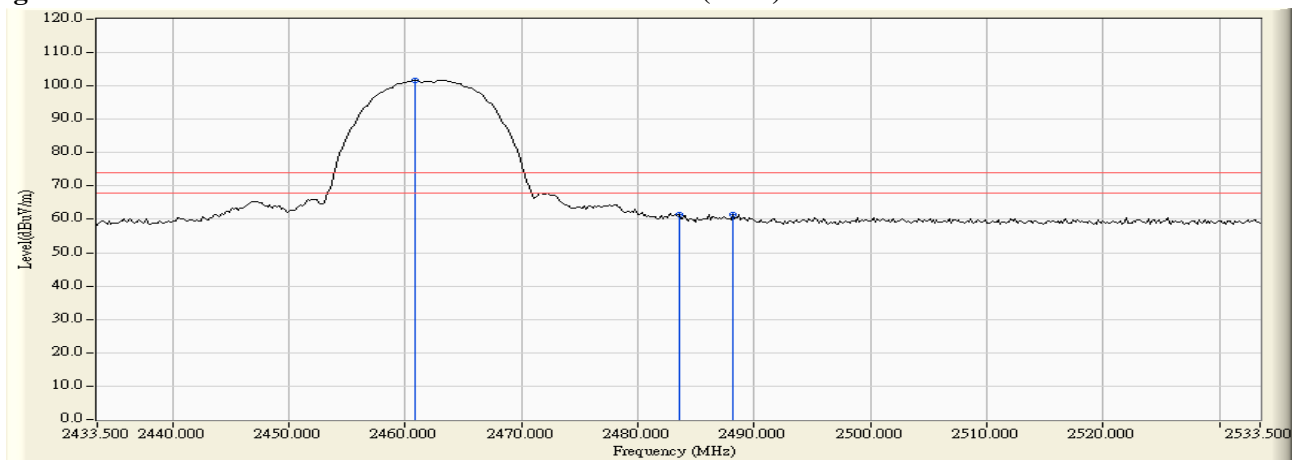
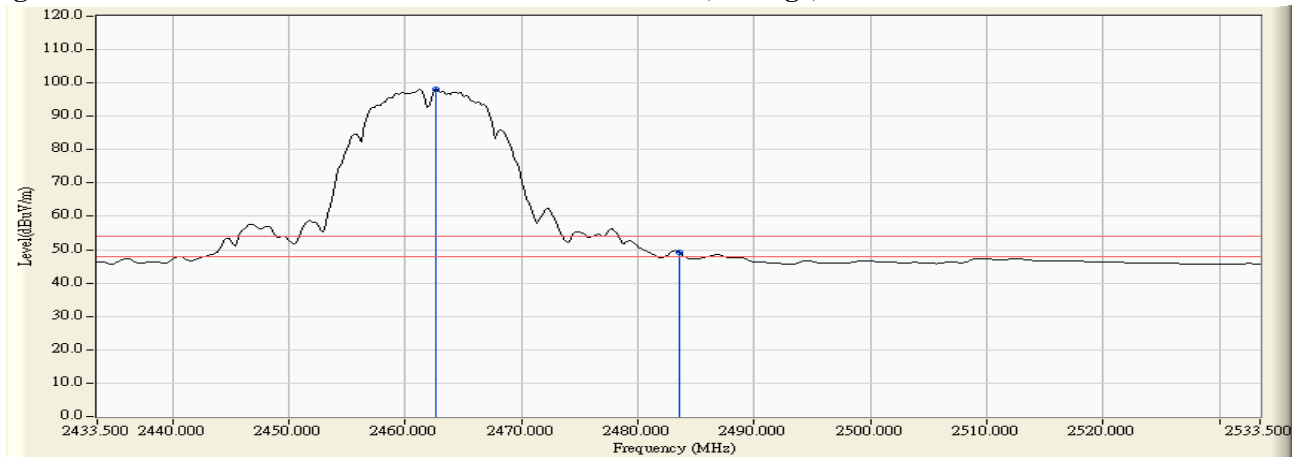

Figure Channel 11: Vertical (Average)



Note:

1. All readings above 1GHz are performed with peak and/or average measurements as necessary.
2. Peak measurements: RBW = 1MHz, VBW = 3 MHz, Sweep: Auto.
3. Average measurements: RBW = 1MHz, VBW = 10 Hz, Sweep: Auto.
4. “ * ”, means this data is the worst emission level.
5. Measurement Level = Reading Level + Correct Factor.
6. The average measurement was not performed when the peak measured data under the limit of average detection.

Product : TABLET PC
 Test Item : Band Edge
 Test Site : No.3 OATS
 Test Mode : Mode 2: Transmit (802.11g 6Mbps)

RF Radiated Measurement (Horizontal):

Channel No.	Frequency (MHz)	Correct Factor (dB)	Reading Level (dBuV)	Emission Level (dBuV/m)	Peak Limit (dBuV/m)	Average Limit (dBuV/m)	Result
01 (Peak)	2390.000	31.509	31.614	63.123	74.00	54.00	Pass
01 (Peak)	2400.000	31.561	48.143	79.704	--	--	--
01 (Peak)	2409.710	31.623	69.670	101.292	--	--	--
01(Average)	2390.000	31.509	17.069	48.578	74.00	54.00	Pass
01(Average)	2400.000	31.561	27.821	59.382	--	--	--
01(Average)	2413.188	31.647	58.439	90.086	--	--	--

Figure Channel 01: Horizontal (Peak)

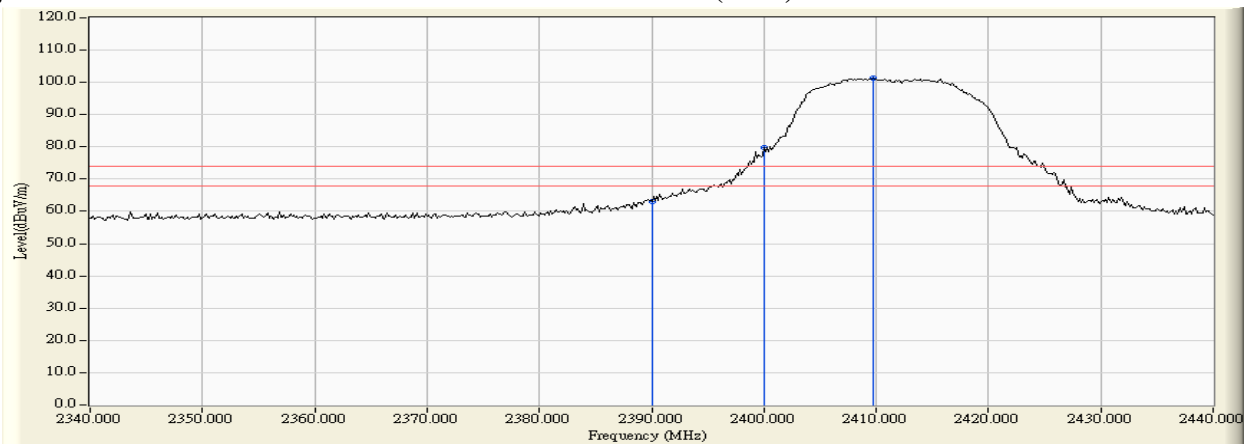
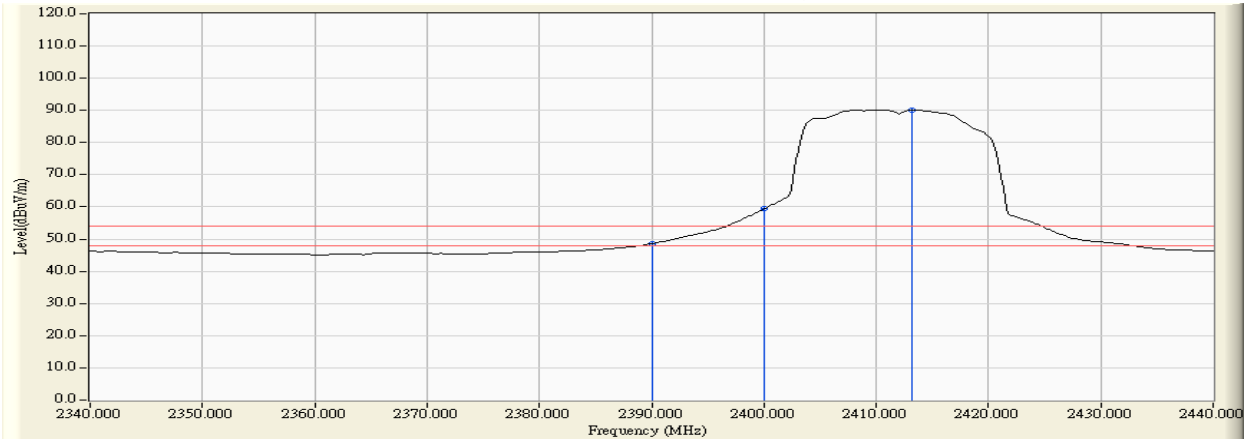

Figure Channel 01: Horizontal (Average)



Note:

1. All readings above 1GHz are performed with peak and/or average measurements as necessary.
2. Peak measurements: RBW = 1MHz, VBW = 3 MHz, Sweep: Auto.
3. Average measurements: RBW = 1MHz, VBW = 10 Hz, Sweep: Auto.
4. “ * ”, means this data is the worst emission level.
5. Measurement Level = Reading Level + Correct Factor.
6. The average measurement was not performed when the peak measured data under the limit of average detection.

Product : TABLET PC
 Test Item : Band Edge
 Test Site : No.3 OATS
 Test Mode : Mode 2: Transmit (802.11g 6Mbps)

RF Radiated Measurement (Vertical):

Channel No.	Frequency (MHz)	Correct Factor (dB)	Reading Level (dBuV)	Emission Level (dBuV/m)	Peak Limit (dBuV/m)	Average Limit (dBuV/m)	Result
01 (Peak)	2389.855	30.916	34.417	65.333	74.00	54.00	Pass
01 (Peak)	2390.000	30.915	33.535	64.450	74.00	54.00	Pass
01 (Peak)	2400.000	30.912	48.328	79.240	--	--	--
01 (Peak)	2410.000	30.940	74.493	105.433	--	--	--
01 (Average)	2390.000	30.915	18.530	49.445	74.00	54.00	Pass
01 (Average)	2400.000	30.912	31.563	62.475	--	--	--
01 (Average)	2413.478	30.959	63.488	94.447	--	--	--

Figure Channel 01: Vertical (Peak)

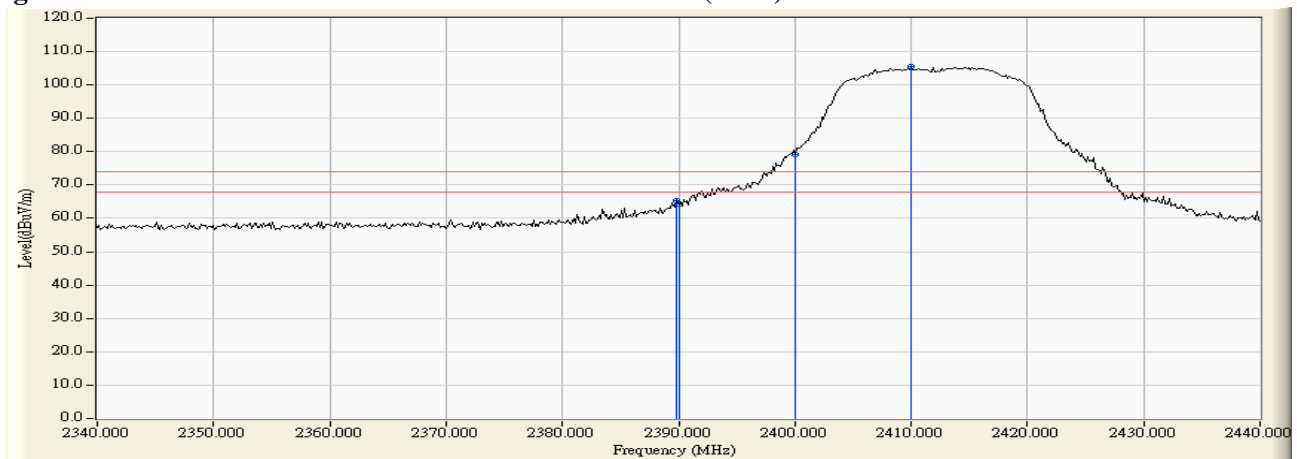
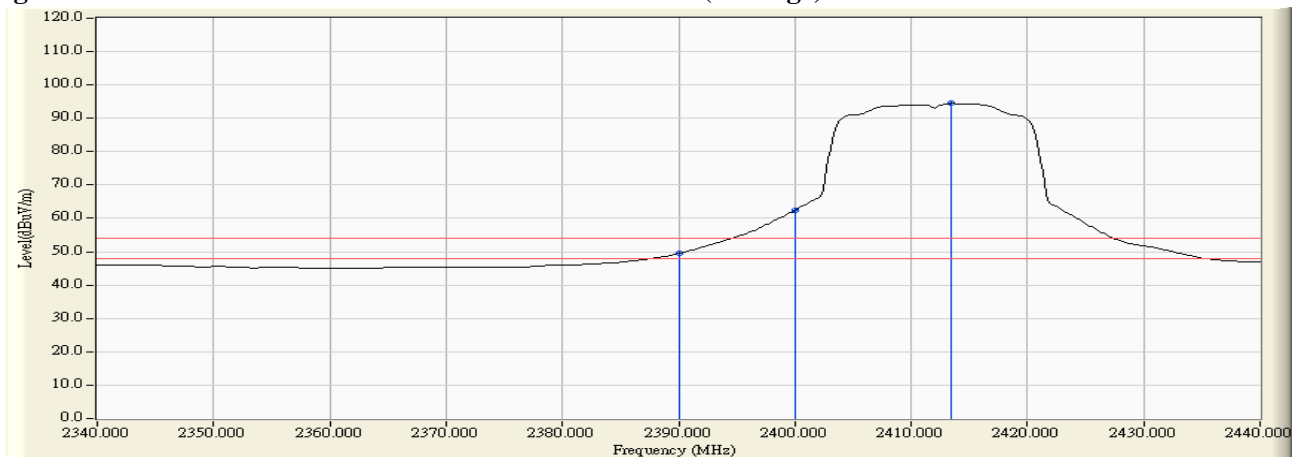

Figure Channel 01: Vertical (Average)



Note:

1. All readings above 1GHz are performed with peak and/or average measurements as necessary.
2. Peak measurements: RBW = 1MHz, VBW = 3 MHz, Sweep: Auto.
3. Average measurements: RBW = 1MHz, VBW = 10 Hz, Sweep: Auto.
4. “ * ”, means this data is the worst emission level.
5. Measurement Level = Reading Level + Correct Factor.
6. The average measurement was not performed when the peak measured data under the limit of average detection.

Product : TABLET PC
 Test Item : Band Edge
 Test Site : No.3 OATS
 Test Mode : Mode 2: Transmit (802.11g 6Mbps)

RF Radiated Measurement (Horizontal):

Channel No.	Frequency (MHz)	Correct Factor (dB)	Reading Level (dBuV)	Emission Level (dBuV/m)	Peak Limit (dBuV/m)	Average Limit (dBuV/m)	Result
11 (Peak)	2459.877	32.003	69.944	101.947	--	--	--
11 (Peak)	2483.500	32.182	28.859	61.041	74.00	54.00	Pass
11 (Average)	2460.457	32.008	58.659	90.667	--	--	--
11 (Average)	2483.500	32.182	15.702	47.884	74.00	54.00	Pass

Figure Channel 11: Horizontal (Peak)

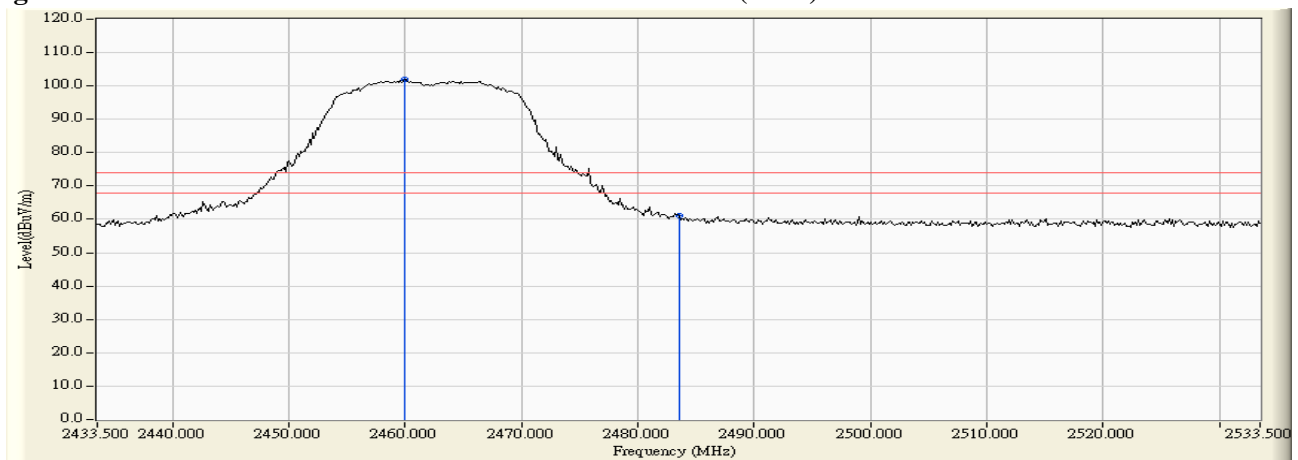
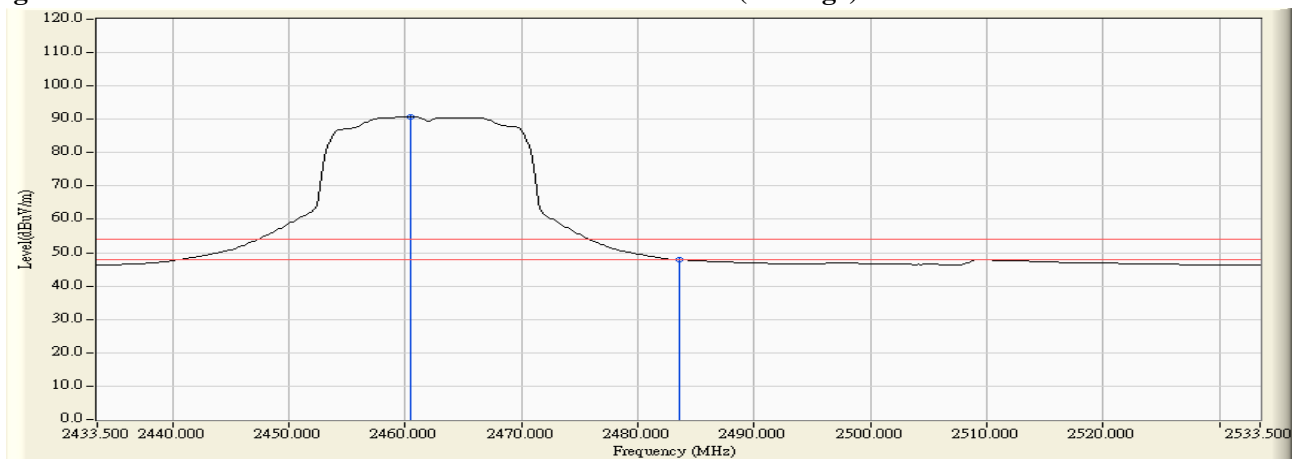

Figure Channel 11: Horizontal (Average)



Note:

1. All readings above 1GHz are performed with peak and/or average measurements as necessary.
2. Peak measurements: RBW = 1MHz, VBW = 3 MHz, Sweep: Auto.
3. Average measurements: RBW = 1MHz, VBW = 10 Hz, Sweep: Auto.
4. “ * ”, means this data is the worst emission level.
5. Measurement Level = Reading Level + Correct Factor.
6. The average measurement was not performed when the peak measured data under the limit of average detection.

Product : TABLET PC
 Test Item : Band Edge
 Test Site : No.3 OATS
 Test Mode : Mode 2: Transmit (802.11g 6Mbps)

RF Radiated Measurement (Vertical):

Channel No.	Frequency (MHz)	Correct Factor (dB)	Reading Level (dBuV)	Emission Level (dBuV/m)	Peak Limit (dBuV/m)	Average Limit (dBuV/m)	Result
11 (Peak)	2464.370	31.306	70.034	101.340	--	--	--
11 (Peak)	2483.500	31.435	29.536	60.971	74.00	54.00	Pass
11 (Peak)	2484.514	31.442	29.805	61.247	74.00	54.00	Pass
11 (Average)	2466.254	31.319	58.918	90.237	--	--	--
11 (Average)	2483.500	31.435	16.126	47.561	74.00	54.00	Pass

Figure Channel 11: Vertical (Peak)

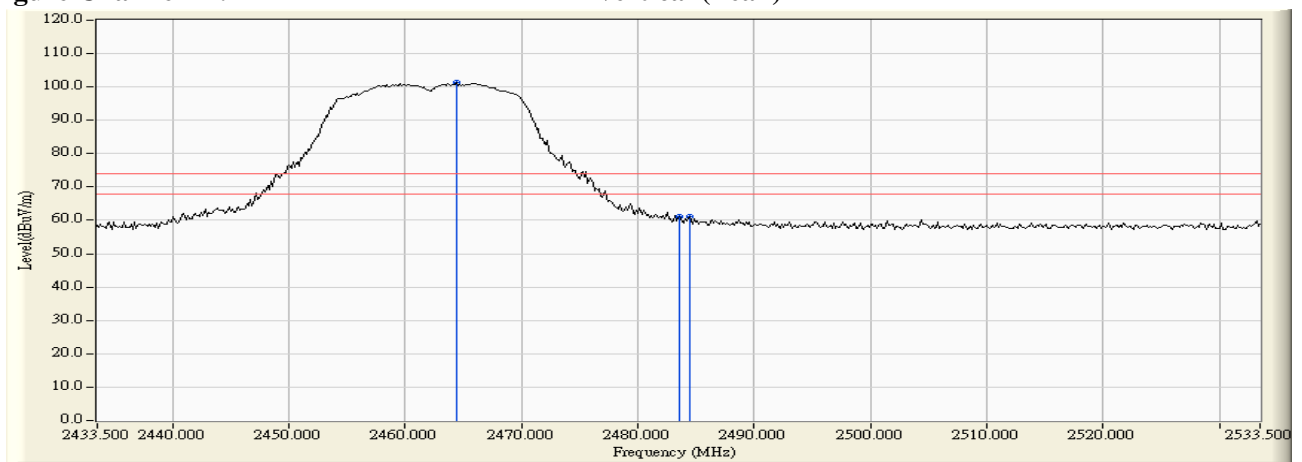
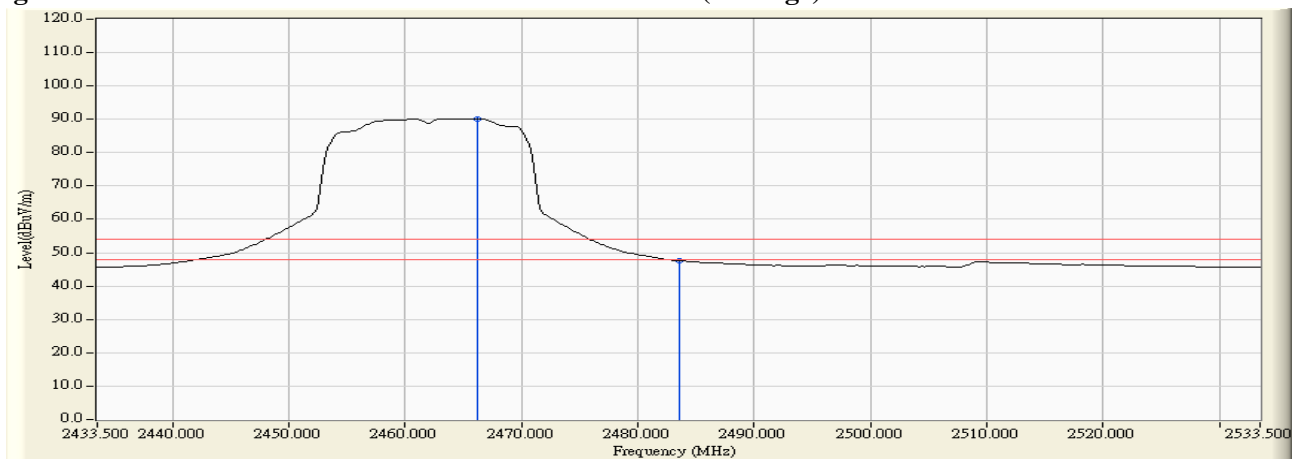

Figure Channel 11: Vertical (Average)



Note:

1. All readings above 1GHz are performed with peak and/or average measurements as necessary.
2. Peak measurements: RBW = 1MHz, VBW = 3 MHz, Sweep: Auto.
3. Average measurements: RBW = 1MHz, VBW = 10 Hz, Sweep: Auto.
4. “ * ”, means this data is the worst emission level.
5. Measurement Level = Reading Level + Correct Factor.
6. The average measurement was not performed when the peak measured data under the limit of average detection.

Product : TABLET PC
 Test Item : Band Edge
 Test Site : No.3 OATS
 Test Mode : Mode 3: Transmit - 802.11n-20BW_14.4Mbps(2.4G Band)

RF Radiated Measurement (Horizontal):

Channel No.	Frequency (MHz)	Correct Factor (dB)	Reading Level (dBuV)	Emission Level (dBuV/m)	Peak Limit (dBuV/m)	Average Limit (dBuV/m)	Result
01 (Peak)	2390.000	31.509	30.323	61.832	74.00	54.00	Pass
01 (Peak)	2400.000	31.561	45.070	76.631	--	--	--
01 (Peak)	2413.623	31.650	68.520	100.171	--	--	--
01 (Average)	2390.000	31.509	16.116	47.625	74.00	54.00	Pass
01 (Average)	2400.000	31.561	25.776	57.337	--	--	--
01 (Average)	2413.333	31.648	55.283	86.931	--	--	--

Figure Channel 01: Horizontal (Peak)

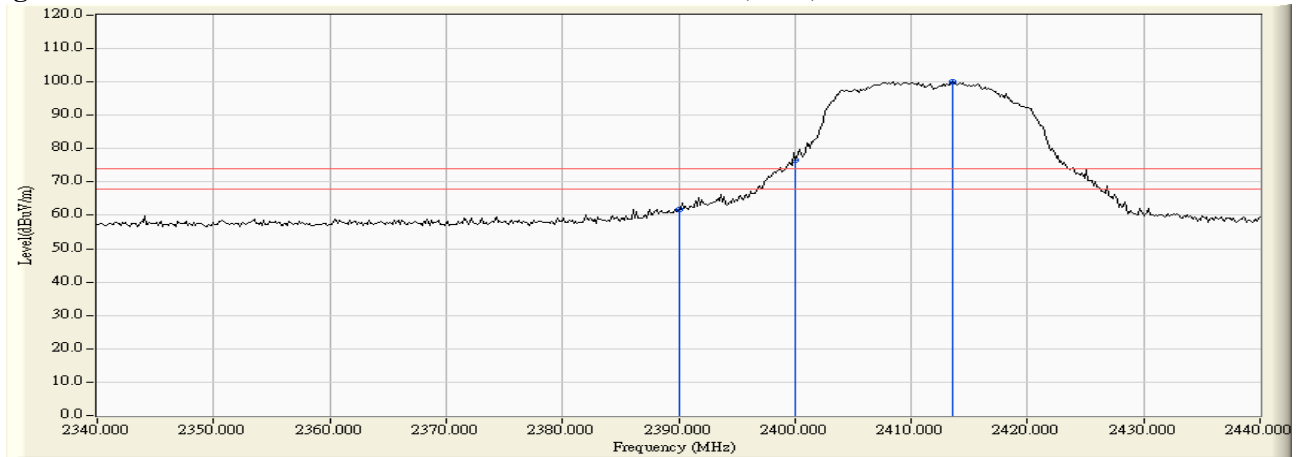
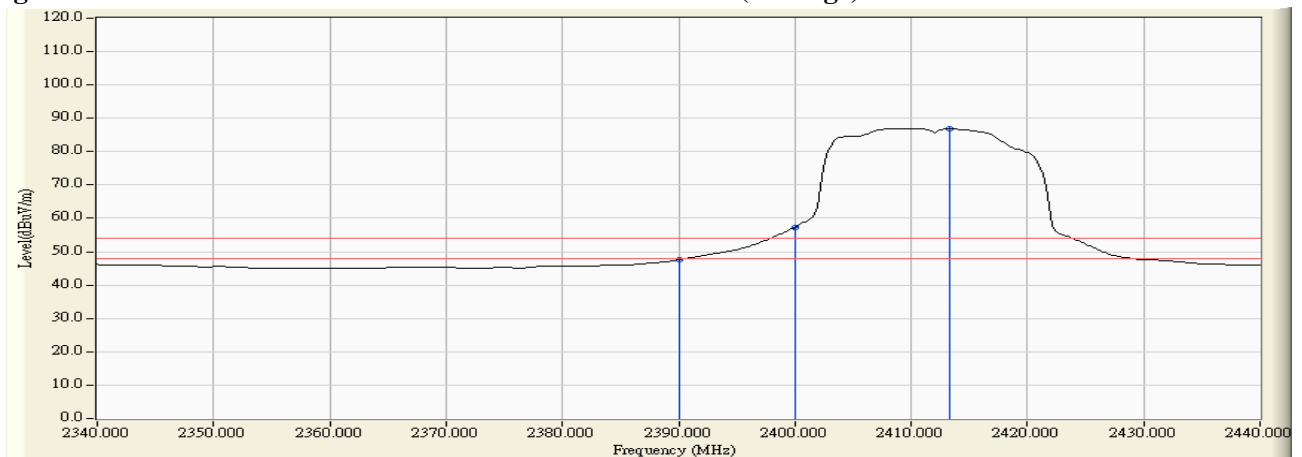

Figure Channel 01: Horizontal (Average)



Note:

1. All readings above 1GHz are performed with peak and/or average measurements as necessary.
2. Peak measurements: RBW = 1MHz, VBW = 3 MHz, Sweep: Auto.
3. Average measurements: RBW = 1MHz, VBW = 10 Hz, Sweep: Auto.
4. “ * ”, means this data is the worst emission level.
5. Measurement Level = Reading Level + Correct Factor.
6. The average measurement was not performed when the peak measured data under the limit of average detection.

Product : TABLET PC
 Test Item : Band Edge
 Test Site : No.3 OATS
 Test Mode : Mode 3: Transmit - 802.11n-20BW_14.4Mbps(2.4G Band)

RF Radiated Measurement (Vertical):

Channel No.	Frequency (MHz)	Correct Factor (dB)	Reading Level (dBuV)	Emission Level (dBuV/m)	Peak Limit (dBuV/m)	Average Limit (dBuV/m)	Result
01 (Peak)	2389.130	30.919	32.689	63.608	74.00	54.00	Pass
01 (Peak)	2390.000	30.915	32.149	63.064	74.00	54.00	Pass
01 (Peak)	2399.565	30.911	50.178	81.089	--	--	--
01 (Peak)	2400.000	30.912	48.375	79.287	--	--	--
01 (Peak)	2413.478	30.959	73.694	104.653	--	--	--
01 (Average)	2390.000	30.915	17.370	48.285	74.00	54.00	Pass
01 (Average)	2400.000	30.912	29.655	60.567	--	--	--
01 (Average)	2413.623	30.960	60.323	91.283	--	--	--

Figure Channel 01: Vertical (Peak)

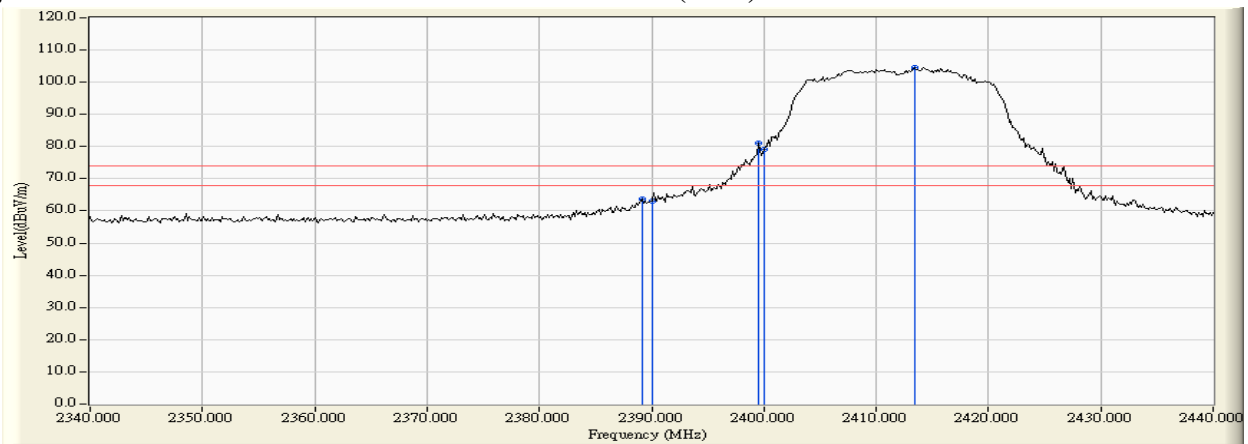
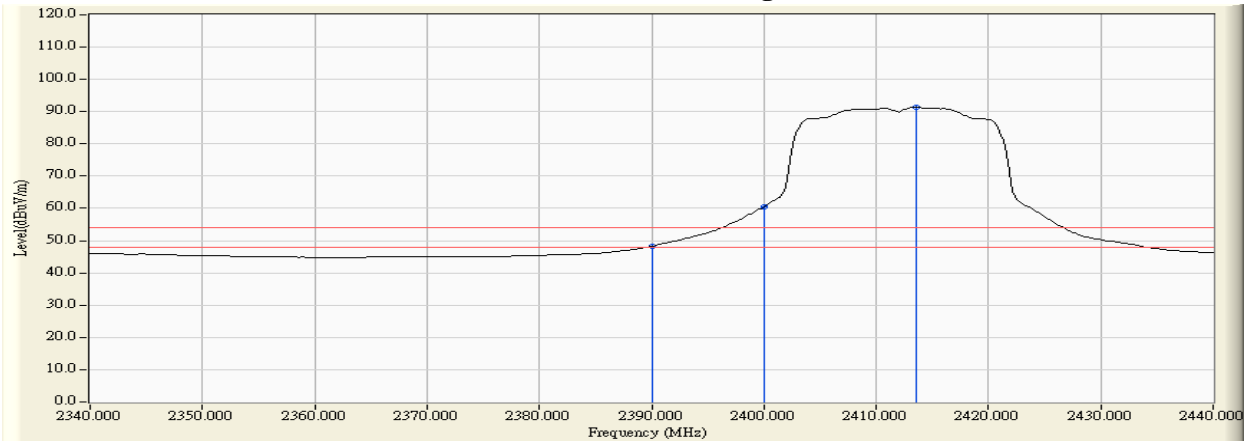

Figure Channel 01: Vertical (Average)



Note:

1. All readings above 1GHz are performed with peak and/or average measurements as necessary.
2. Peak measurements: RBW = 1MHz, VBW = 3 MHz, Sweep: Auto.
3. Average measurements: RBW = 1MHz, VBW = 10 Hz, Sweep: Auto.
4. “ * ”, means this data is the worst emission level.
5. Measurement Level = Reading Level + Correct Factor.
6. The average measurement was not performed when the peak measured data under the limit of average detection.

Product : TABLET PC
 Test Item : Band Edge
 Test Site : No.3 OATS
 Test Mode : Mode 3: Transmit - 802.11n-20BW_14.4Mbps(2.4G Band)

RF Radiated Measurement (Horizontal):

Channel No.	Frequency (MHz)	Correct Factor (dB)	Reading Level (dBuV)	Emission Level (dBuV/m)	Peak Limit (dBuV/m)	Average Limit (dBuV/m)	Result
11 (Peak)	2465.529	32.046	70.073	102.119	--	--	--
11 (Peak)	2483.500	32.182	27.629	59.811	74.00	54.00	Pass
11 (Peak)	2492.486	32.249	29.288	61.538	74.00	54.00	Pass
11 (Average)	2460.601	32.009	56.626	88.635	--	--	--
11 (Average)	2483.500	32.182	15.545	47.727	74.00	54.00	Pass
11 (Average)	2509.007	32.253	15.518	47.772	74.00	54.00	Pass

Figure Channel 11: Horizontal (Peak)

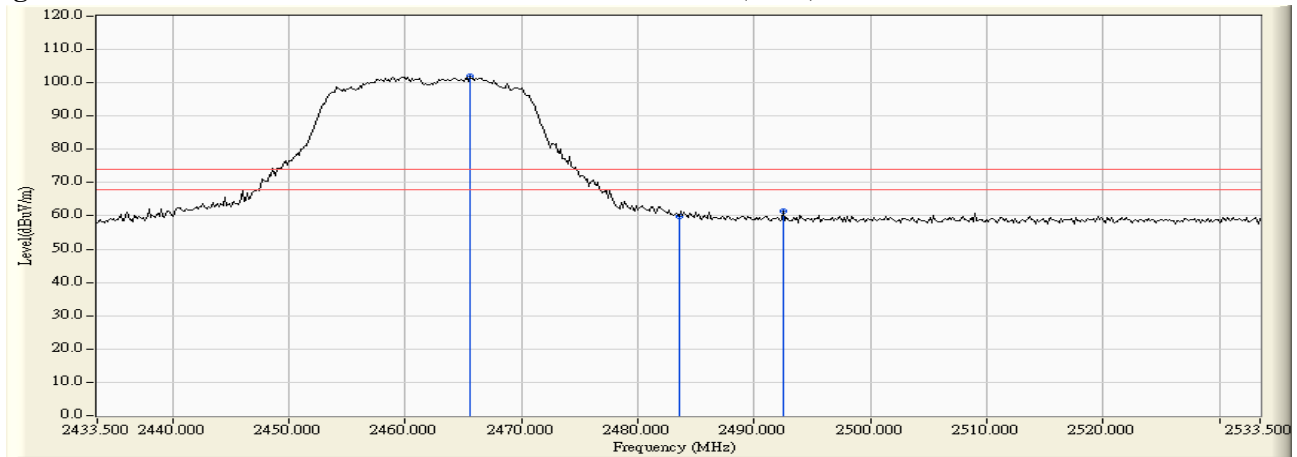
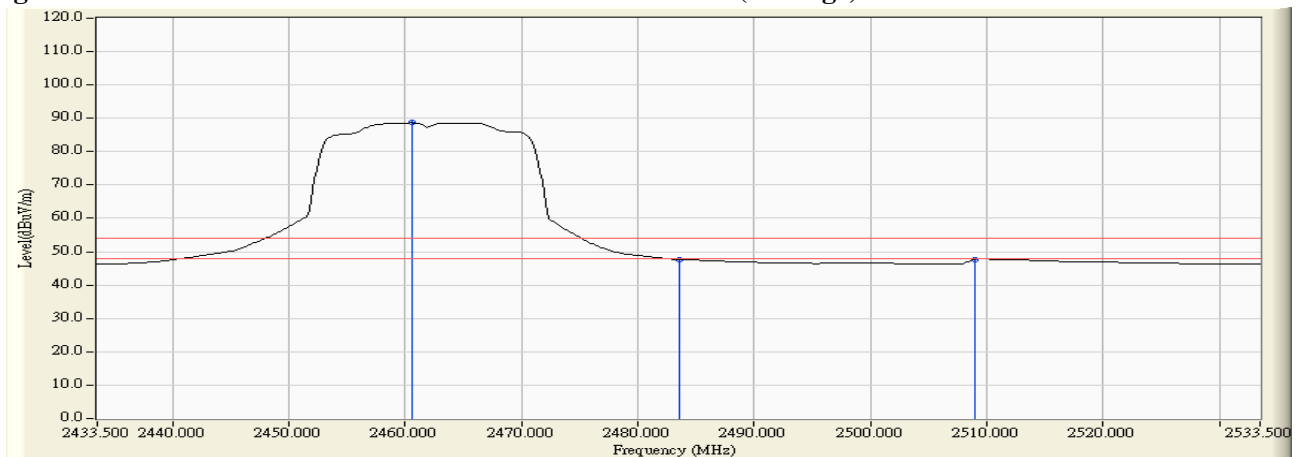

Figure Channel 11: Horizontal (Average)



Note:

1. All readings above 1GHz are performed with peak and/or average measurements as necessary.
2. Peak measurements: RBW = 1MHz, VBW = 3 MHz, Sweep: Auto.
3. Average measurements: RBW = 1MHz, VBW = 10 Hz, Sweep: Auto.
4. “ * ”, means this data is the worst emission level.
5. Measurement Level = Reading Level + Correct Factor.
6. The average measurement was not performed when the peak measured data under the limit of average detection.

Product : TABLET PC
 Test Item : Band Edge
 Test Site : No.3 OATS
 Test Mode : Mode 3: Transmit - 802.11n-20BW_14.4Mbps(2.4G Band)

RF Radiated Measurement (Vertical):

Channel No.	Frequency (MHz)	Correct Factor (dB)	Reading Level (dBuV)	Emission Level (dBuV/m)	Peak Limit (dBuV/m)	Average Limit (dBuV/m)	Result
11 (Peak)	2464.080	31.305	70.760	102.064	--	--	--
11 (Peak)	2483.500	31.435	29.788	61.223	74.00	54.00	Pass
11 (Average)	2466.109	31.318	57.730	89.048	--	--	--
11 (Average)	2483.500	31.435	16.145	47.580	74.00	54.00	Pass

Figure Channel 11: Vertical (Peak)

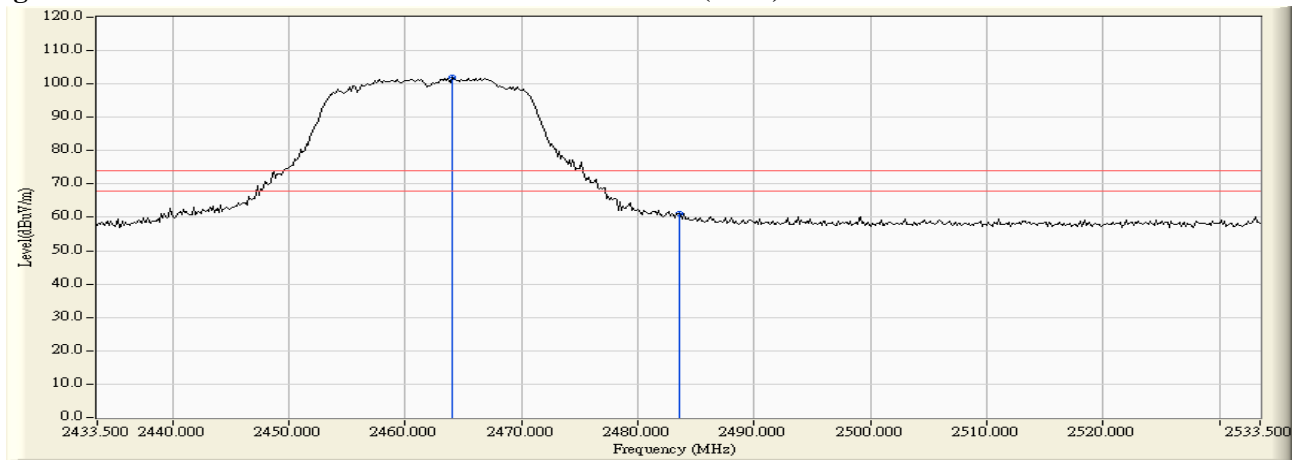
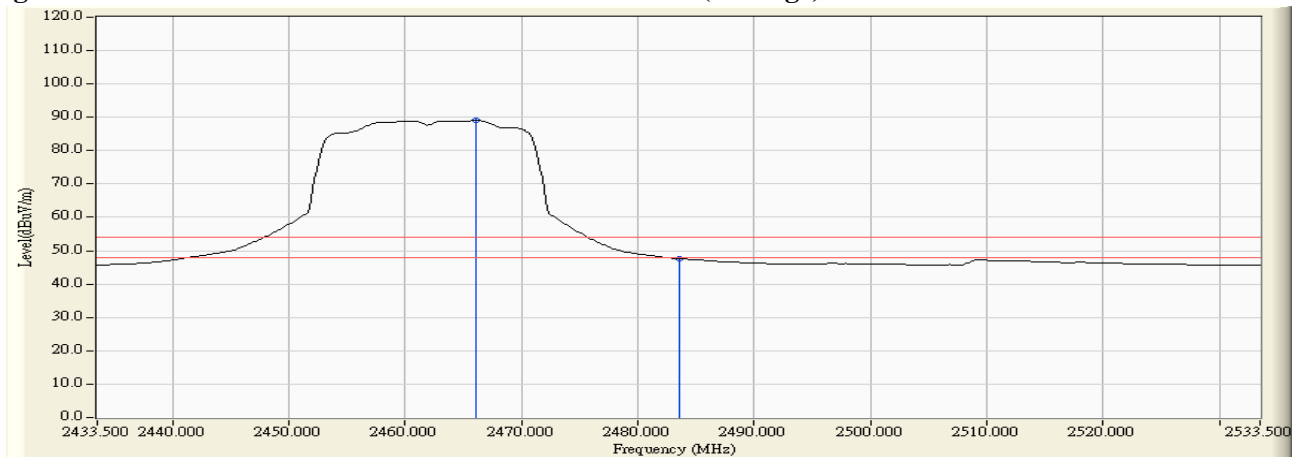

Figure Channel 11: Vertical (Average)



Note:

1. All readings above 1GHz are performed with peak and/or average measurements as necessary.
2. Peak measurements: RBW = 1MHz, VBW = 3 MHz, Sweep: Auto.
3. Average measurements: RBW = 1MHz, VBW = 10 Hz, Sweep: Auto.
4. “ * ”, means this data is the worst emission level.
5. Measurement Level = Reading Level + Correct Factor.
6. The average measurement was not performed when the peak measured data under the limit of average detection.

Product : TABLET PC
 Test Item : Band Edge
 Test Site : No.3 OATS
 Test Mode : Mode 4: Transmit - 802.11n-40BW_30Mbps(2.4G Band)

RF Radiated Measurement (Horizontal):

Channel No.	Frequency (MHz)	Correct Factor (dB)	Reading Level (dBuV)	Emission Level (dBuV/m)	Peak Limit (dBuV/m)	Average Limit (dBuV/m)	Result
03 (Peak)	2387.246	31.498	28.317	59.815	74.00	54.00	Pass
03 (Peak)	2390.000	31.509	28.121	59.630	74.00	54.00	Pass
03 (Peak)	2400.000	31.561	37.144	68.705	--	--	--
03 (Peak)	2413.188	31.647	63.497	95.144	--	--	--
03 (Average)	2390.000	31.509	15.177	46.686	74.00	54.00	Pass
03 (Average)	2400.000	31.561	21.615	53.176	--	--	--
03 (Average)	2430.725	31.782	49.862	81.644	--	--	--

Figure Channel 03: Horizontal (Peak)

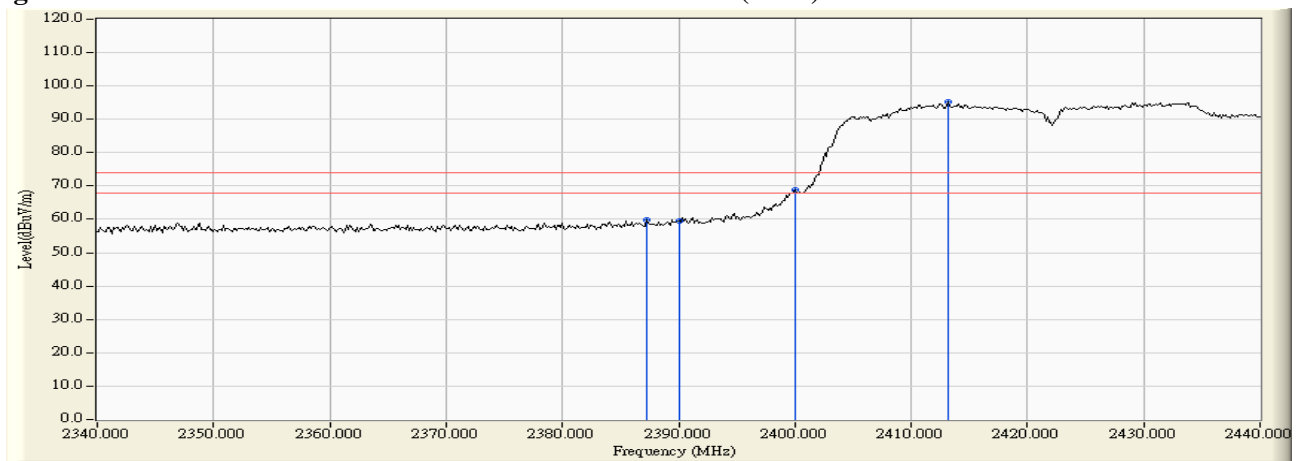
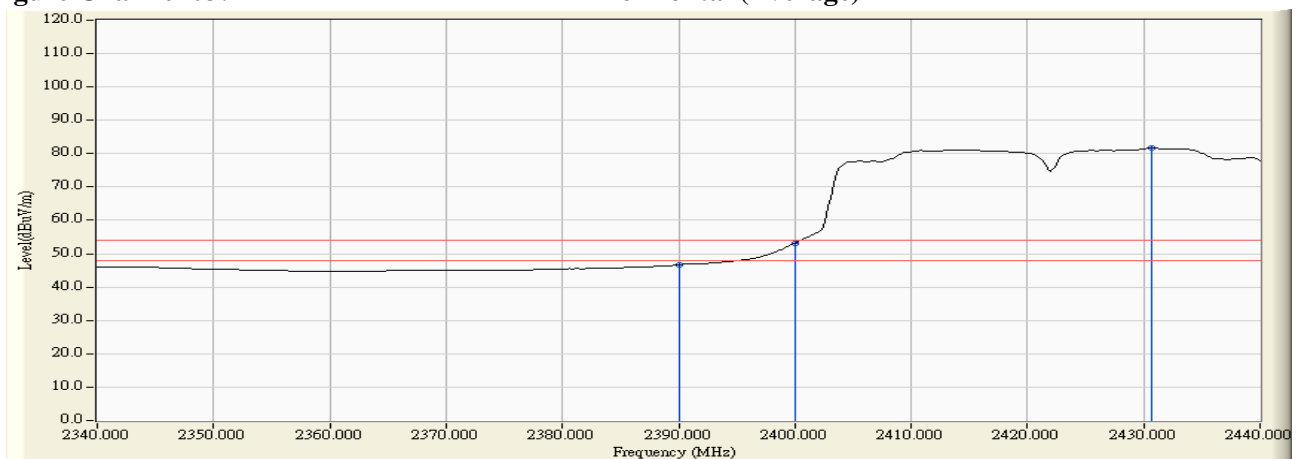

Figure Channel 03: Horizontal (Average)



Note:

1. All readings above 1GHz are performed with peak and/or average measurements as necessary.
2. Peak measurements: RBW = 1MHz, VBW = 3 MHz, Sweep: Auto.
3. Average measurements: RBW = 1MHz, VBW = 10 Hz, Sweep: Auto.
4. “ * ”, means this data is the worst emission level.
5. Measurement Level = Reading Level + Correct Factor.
6. The average measurement was not performed when the peak measured data under the limit of average detection.

Product : TABLET PC
 Test Item : Band Edge
 Test Site : No.3 OATS
 Test Mode : Mode 4: Transmit - 802.11n-40BW_30Mbps(2.4G Band)

RF Radiated Measurement (Vertical):

Channel No.	Frequency (MHz)	Correct Factor (dB)	Reading Level (dBuV)	Emission Level (dBuV/m)	Peak Limit (dBuV/m)	Average Limit (dBuV/m)	Result
03 (Peak)	2389.710	30.917	34.624	65.541	74.00	54.00	Pass
03 (Peak)	2390.000	30.915	34.008	64.923	74.00	54.00	Pass
03 (Peak)	2400.000	30.912	39.211	70.123	--	--	--
03 (Peak)	2429.710	31.070	67.245	98.314	--	--	--
03 (Average)	2390.000	30.915	19.146	50.061	74.00	54.00	Pass
03 (Average)	2400.000	30.912	25.388	56.300	--	--	--
03 (Average)	2413.478	30.959	53.463	84.422	--	--	--

Figure Channel 03: Vertical (Peak)

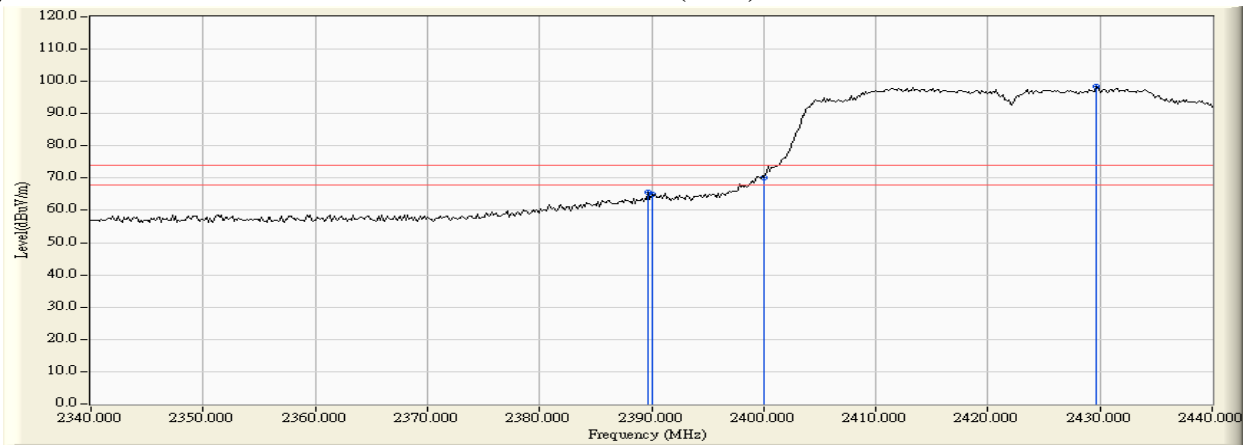
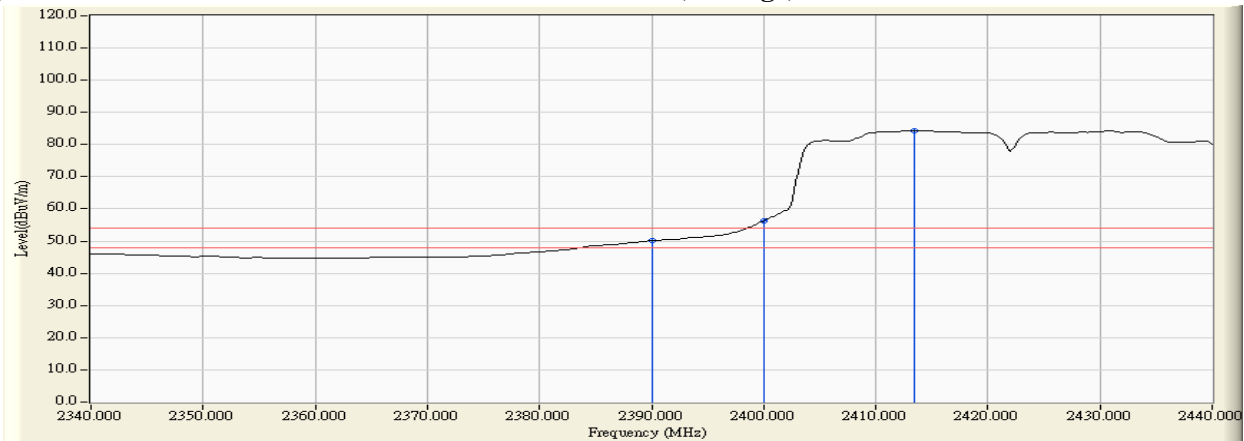

Figure Channel 03: Vertical (Average)



Note:

1. All readings above 1GHz are performed with peak and/or average measurements as necessary.
2. Peak measurements: RBW = 1MHz, VBW = 3 MHz, Sweep: Auto.
3. Average measurements: RBW = 1MHz, VBW = 10 Hz, Sweep: Auto.
4. “ * ”, means this data is the worst emission level.
5. Measurement Level = Reading Level + Correct Factor.
6. The average measurement was not performed when the peak measured data under the limit of average detection.

Product : TABLET PC
 Test Item : Band Edge
 Test Site : No.3 OATS
 Test Mode : Mode 4: Transmit - 802.11n-40BW_30Mbps(2.4G Band)

RF Radiated Measurement (Horizontal):

Channel No.	Frequency (MHz)	Correct Factor (dB)	Reading Level (dBuV)	Emission Level (dBuV/m)	Peak Limit (dBuV/m)	Average Limit (dBuV/m)	Result
09 (Peak)	2456.688	31.979	61.944	93.923	--	--	--
09 (Peak)	2483.500	32.182	26.744	58.926	74.00	54.00	Pass
09 (Peak)	2487.558	32.212	28.499	60.712	74.00	54.00	Pass
09 (Average)	2459.732	32.002	48.418	80.420	--	--	--
09 (Average)	2483.500	32.182	14.830	47.012	74.00	54.00	Pass
09 (Average)	2509.152	32.254	15.522	47.776	74.00	54.00	Pass

Figure Channel 09: Horizontal (Peak)

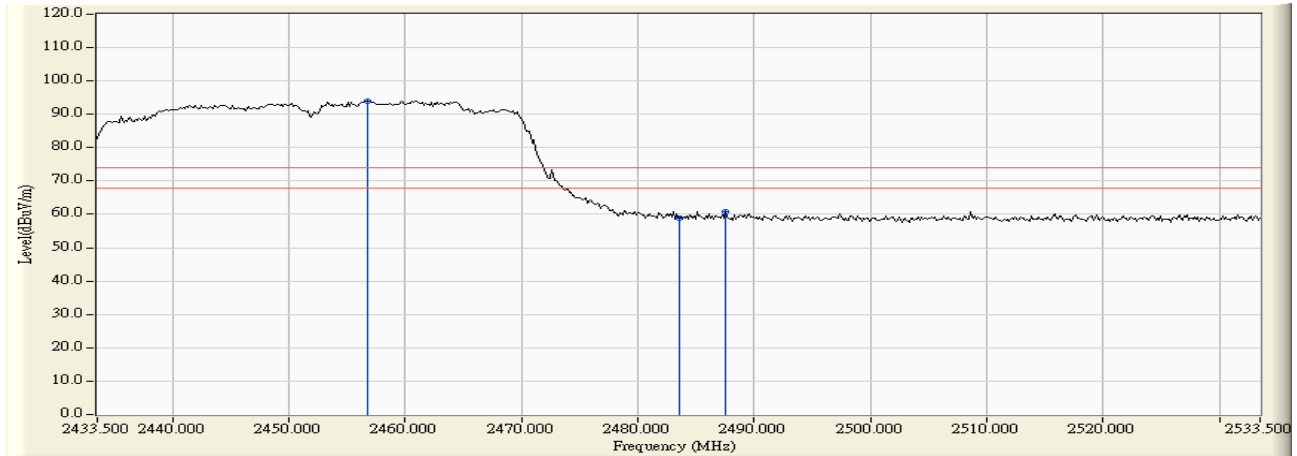
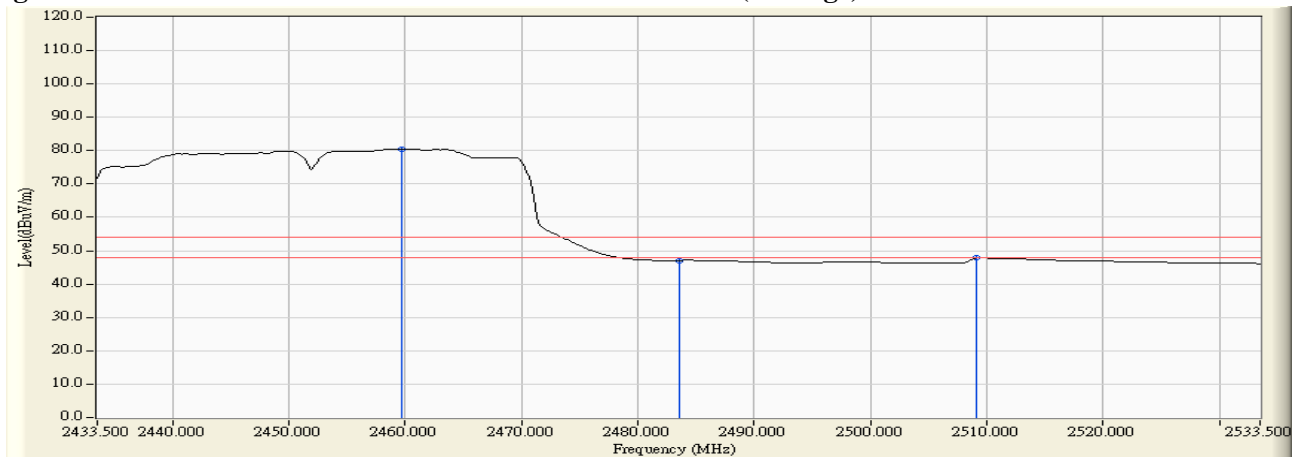

Figure Channel 09: Horizontal (Average)



Note:

1. All readings above 1GHz are performed with peak and/or average measurements as necessary.
2. Peak measurements: RBW = 1MHz, VBW = 3 MHz, Sweep: Auto.
3. Average measurements: RBW = 1MHz, VBW = 10 Hz, Sweep: Auto.
4. “ * ”, means this data is the worst emission level.
5. Measurement Level = Reading Level + Correct Factor.
6. The average measurement was not performed when the peak measured data under the limit of average detection.

Product : TABLET PC
 Test Item : Band Edge
 Test Site : No.3 OATS
 Test Mode : Mode 4: Transmit - 802.11n-40BW_30Mbps(2.4G Band)

RF Radiated Measurement (Vertical):

Channel No.	Frequency (MHz)	Correct Factor (dB)	Reading Level (dBuV)	Emission Level (dBuV/m)	Peak Limit (dBuV/m)	Average Limit (dBuV/m)	Result
09 (Peak)	2459.297	31.272	66.767	98.039	--	--	--
09 (Peak)	2483.500	31.435	28.221	59.656	74.00	54.00	Pass
09 (Peak)	2484.080	31.439	29.321	60.760	74.00	54.00	Pass
09 (Average)	2440.457	31.143	52.156	83.298	--	--	--
09 (Average)	2483.500	31.435	16.026	47.461	74.00	54.00	Pass

Figure Channel 09: Vertical (Peak)

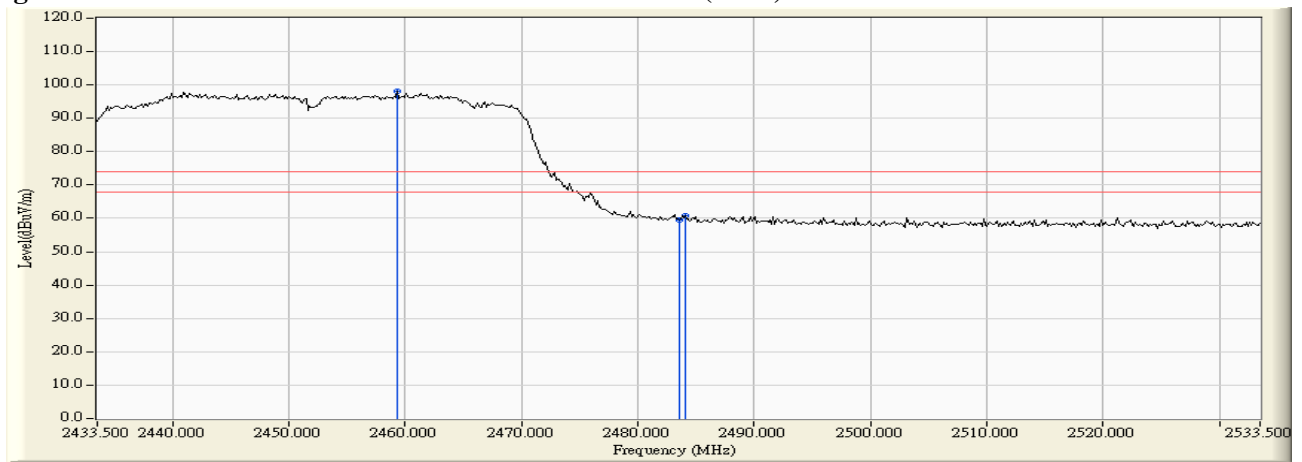
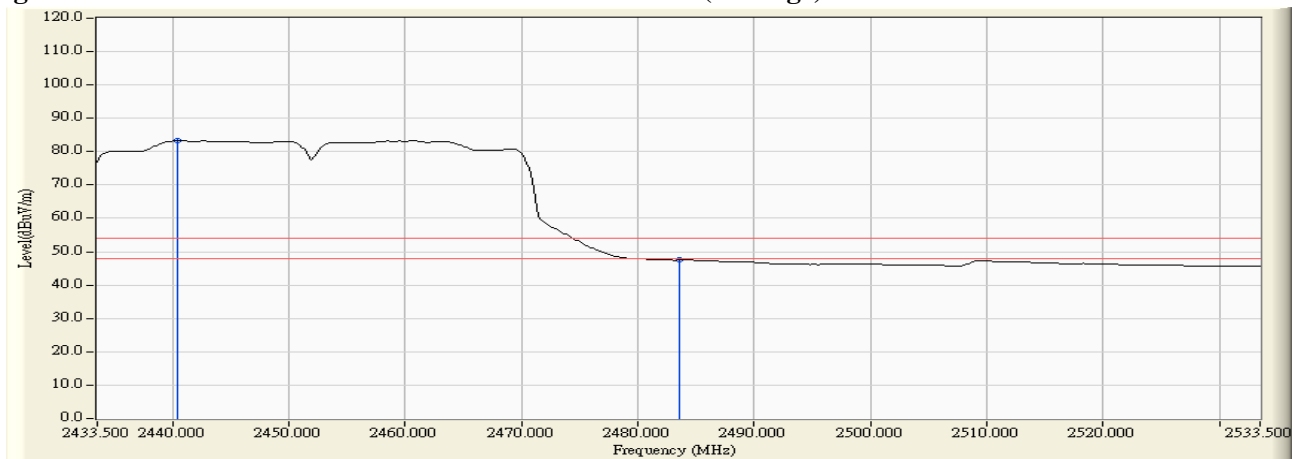

Figure Channel 09: Vertical (Average)



Note:

1. All readings above 1GHz are performed with peak and/or average measurements as necessary.
2. Peak measurements: RBW = 1MHz, VBW = 3 MHz, Sweep: Auto.
3. Average measurements: RBW = 1MHz, VBW = 10 Hz, Sweep: Auto.
4. “ * ”, means this data is the worst emission level.
5. Measurement Level = Reading Level + Correct Factor.
6. The average measurement was not performed when the peak measured data under the limit of average detection.

7. 6dB Bandwidth

7.1. Test Equipment

	Equipment	Manufacturer	Model No./Serial No.	Last Cal.
	Spectrum Analyzer	R&S	FSP40 / 100170	Jun, 2015
	Spectrum Analyzer	Agilent	E4407B / US39440758	Jun, 2015
X	Spectrum Analyzer	Agilent	N9010A / MY48030495	Apr., 2016

Note:

1. All equipments are calibrated with traceable calibrations. Each calibration is traceable to the national or international standards.
2. The test instruments marked with “X” are used to measure the final test results.

7.2. Test Setup

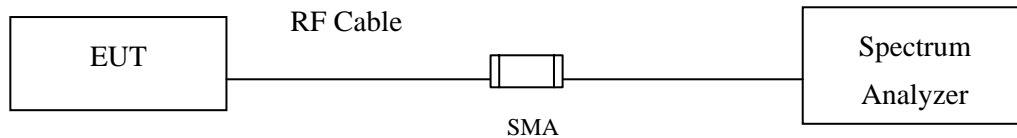

7.3. Limits

The minimum bandwidth shall be at least 500 kHz.

7.4. Test Procedure

The EUT was setup according to ANSI C63.10, 2013; tested according to DTS test procedure of KDB558074 for compliance to FCC 47CFR 15.247 requirements.

Set RBW = 1-5% of the emission bandwidth, $VBW \geq 3 * RBW$

7.5. Uncertainty

$\pm 150\text{Hz}$

7.6. Test Result of 6dB Bandwidth

Product : TABLET PC
 Test Item : 6dB Bandwidth Data
 Test Site : No.3 OATS
 Test Mode : Mode 1: Transmit (802.11b 1Mbps) (2412MHz)

Channel No.	Frequency (MHz)	Measurement Level (kHz)	Required Limit (kHz)	Result
1	2412.00	10150	>500	Pass

Figure Channel 1:

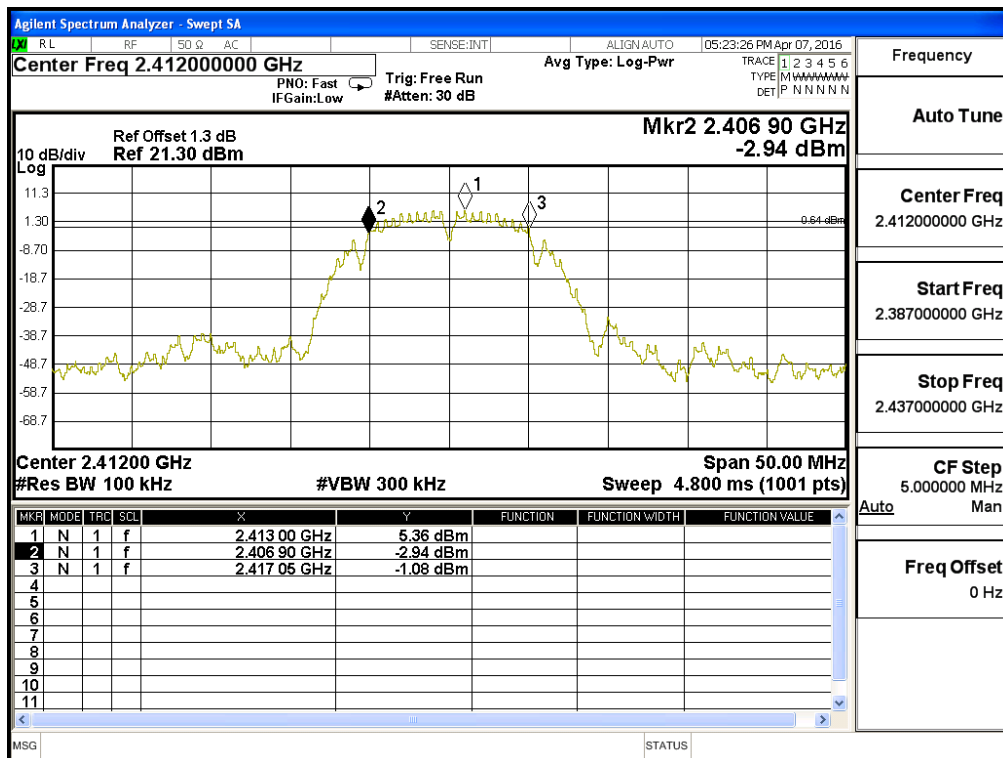

Product : TABLET PC
 Test Item : 6dB Bandwidth Data
 Test Site : No.3 OATS
 Test Mode : Mode 1: Transmit (802.11b 1Mbps) (2437MHz)

Channel No.	Frequency (MHz)	Measurement Level (kHz)	Required Limit (kHz)	Result
6	2437.00	10150	>500	Pass

Figure Channel 6:

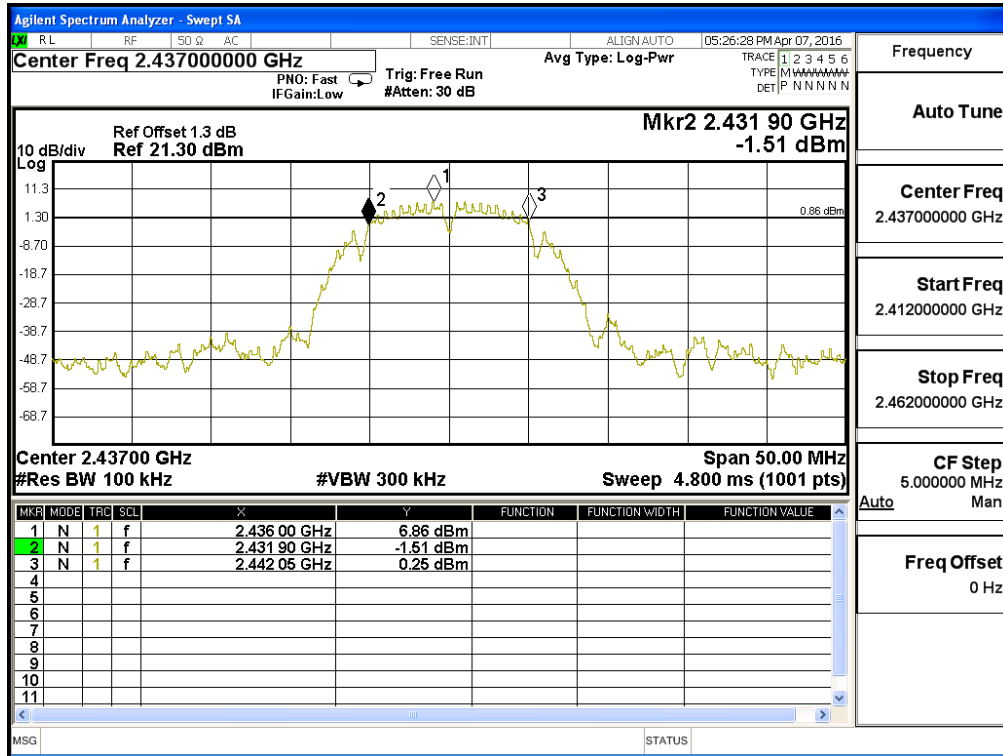

Product : TABLET PC
 Test Item : 6dB Bandwidth Data
 Test Site : No.3 OATS
 Test Mode : Mode 1: Transmit (802.11b 1Mbps) (2462MHz)

Channel No.	Frequency (MHz)	Measurement Level (kHz)	Required Limit (kHz)	Result
11	2462.00	10150	>500	Pass

Figure Channel 11:

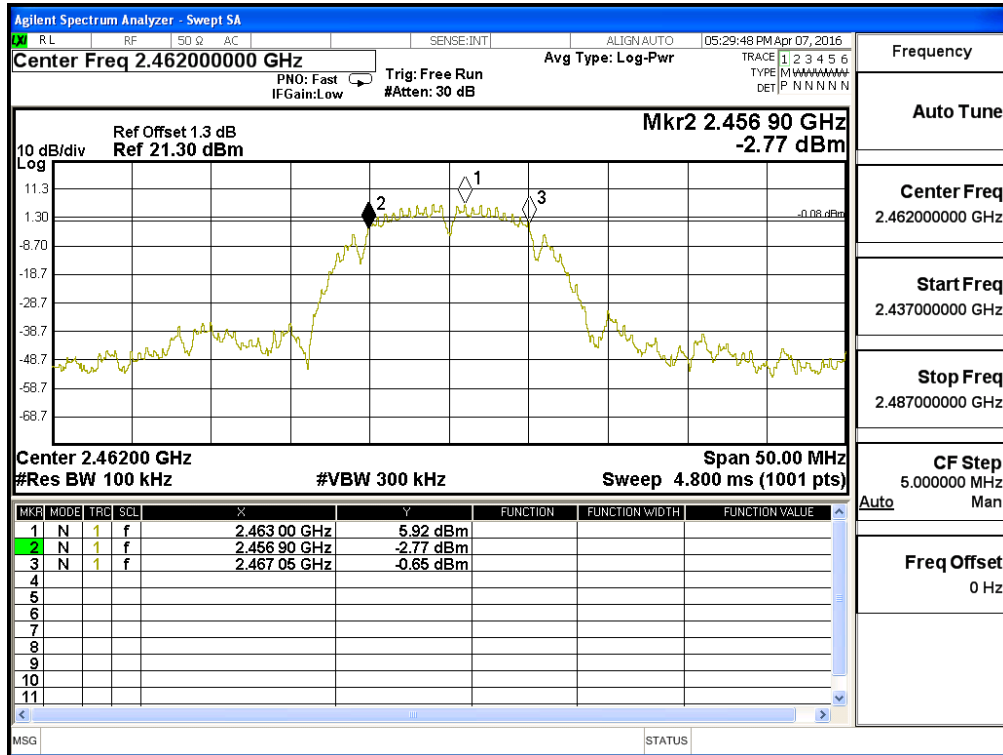

Product : TABLET PC
 Test Item : 6dB Bandwidth Data
 Test Site : No.3 OATS
 Test Mode : Mode 2: Transmit (802.11g 6Mbps) (2412MHz)

Channel No.	Frequency (MHz)	Measurement Level (kHz)	Required Limit (kHz)	Result
1	2412.00	15200	>500	Pass

Figure Channel 1:

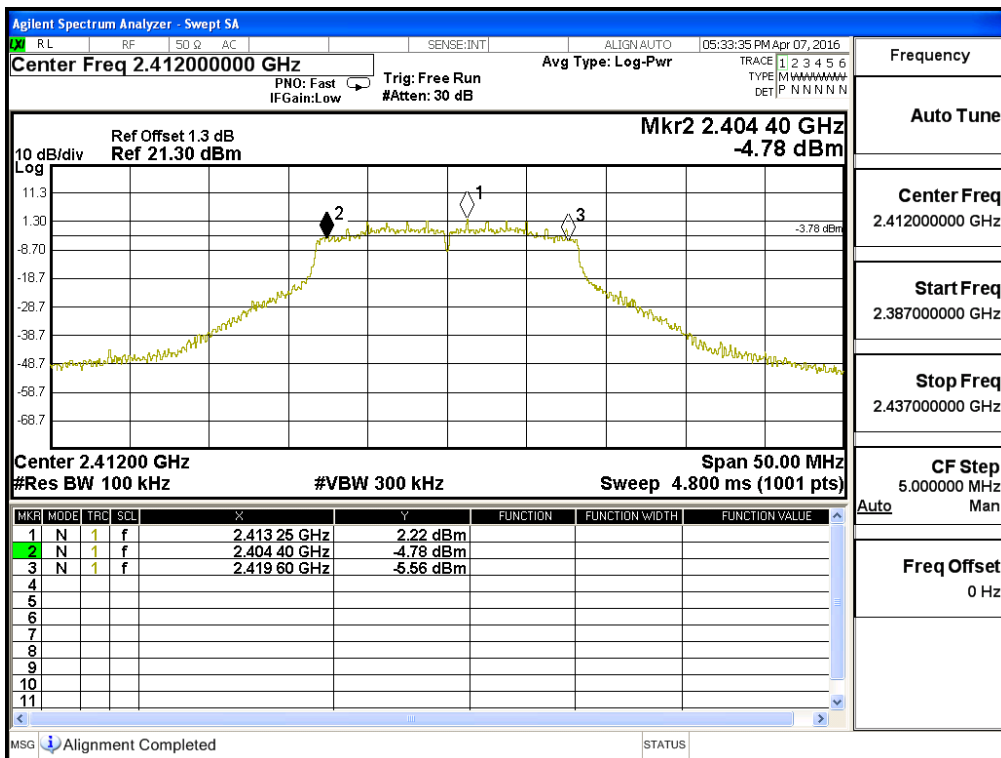

Product : TABLET PC
 Test Item : 6dB Bandwidth Data
 Test Site : No.3 OATS
 Test Mode : Mode 2: Transmit (802.11g 6Mbps) (2437MHz)

Channel No.	Frequency (MHz)	Measurement Level (kHz)	Required Limit (kHz)	Result
6	2437.00	15200	>500	Pass

Figure Channel 6:

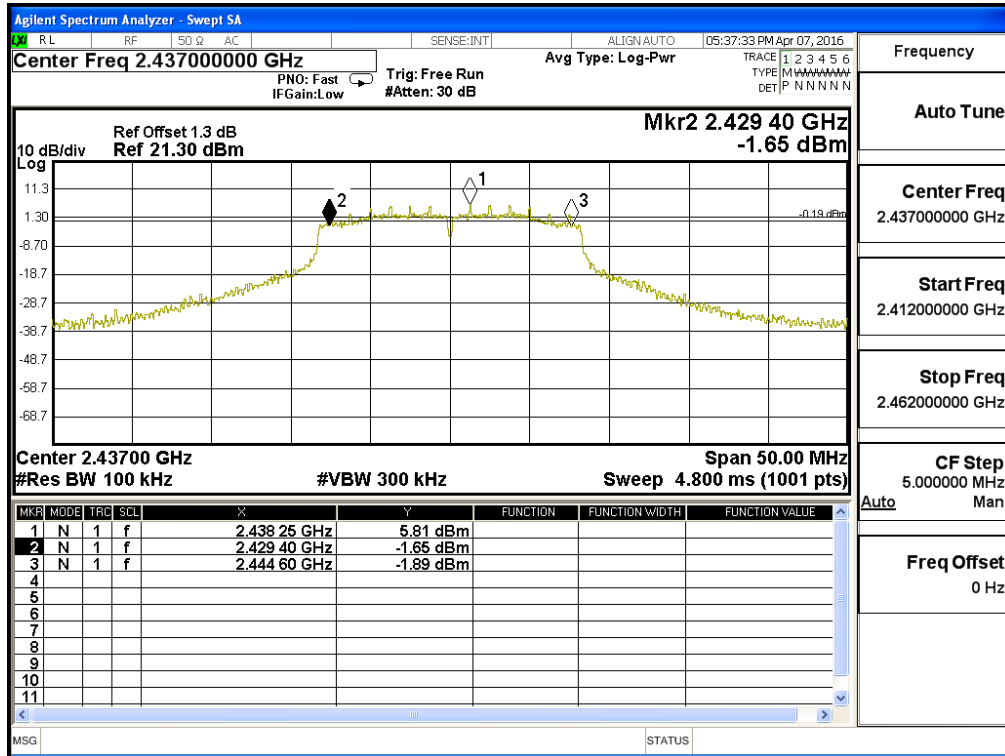

Product : TABLET PC
 Test Item : 6dB Bandwidth Data
 Test Site : No.3 OATS
 Test Mode : Mode 2: Transmit (802.11g 6Mbps) (2462MHz)

Channel No.	Frequency (MHz)	Measurement Level (kHz)	Required Limit (kHz)	Result
11	2462.00	15200	>500	Pass

Figure Channel 11:

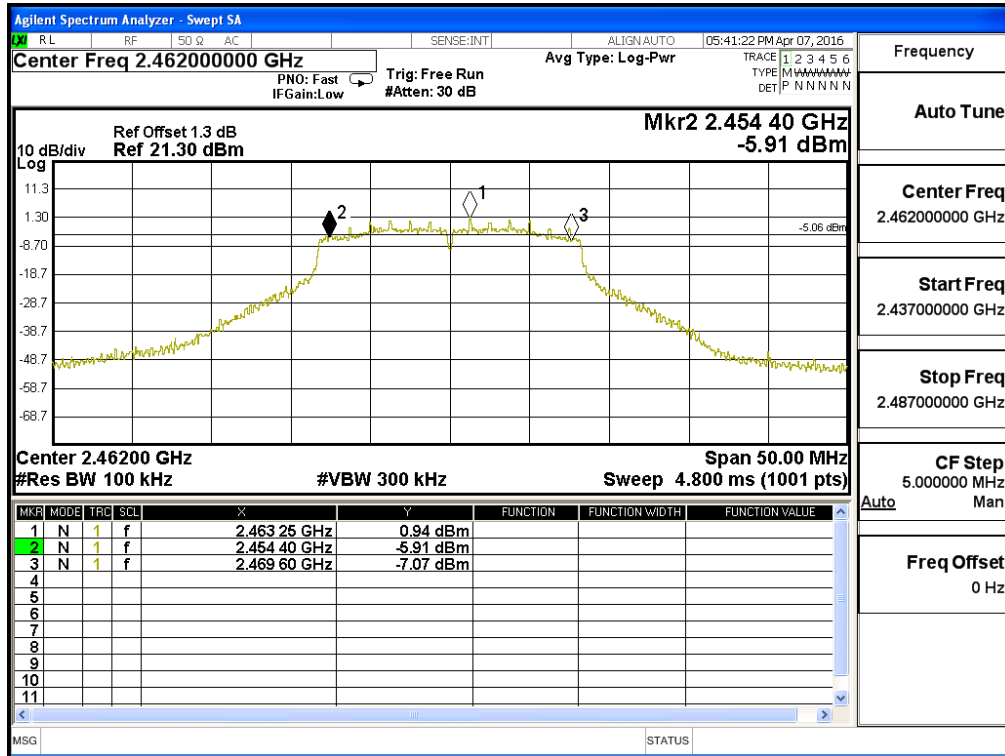

Product : TABLET PC
 Test Item : 6dB Bandwidth Data
 Test Site : No.3 OATS
 Test Mode : Mode 3: Transmit - 802.11n-20BW_14.4Mbps(2.4G Band) (2412MHz)

Channel No.	Frequency (MHz)	Measurement Level (kHz)	Required Limit (kHz)	Result
1	2412.00	15800	>500	Pass

Figure Channel 1: (Chain A)

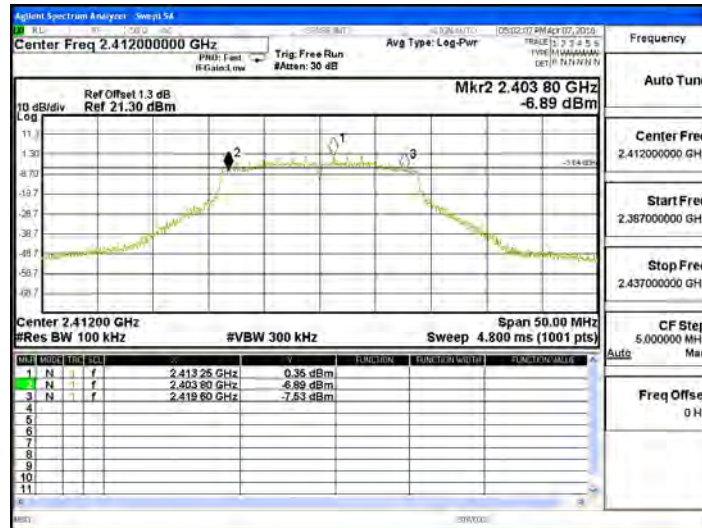

Channel No.	Frequency (MHz)	Measurement Level (kHz)	Required Limit (kHz)	Result
1	2412.00	16400	>500	Pass

Figure Channel 1: (Chain B)

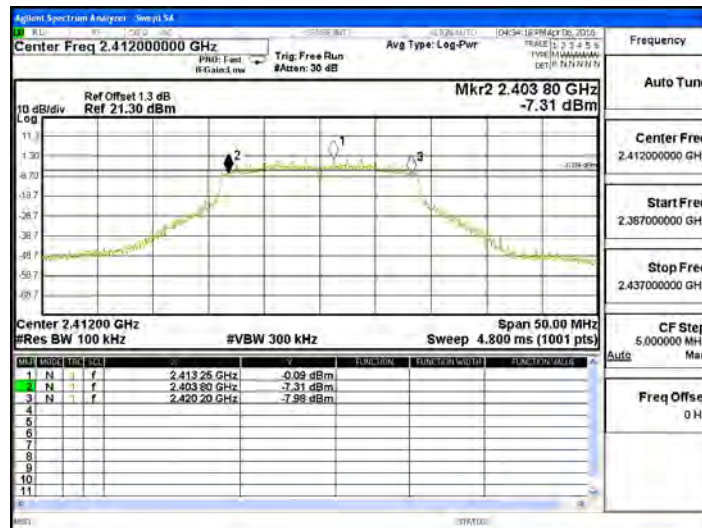

Product : TABLET PC
 Test Item : 6dB Bandwidth Data
 Test Site : No.3 OATS
 Test Mode : Mode 3: Transmit - 802.11n-20BW_14.4Mbps(2.4G Band) (2437MHz)

Channel No.	Frequency (MHz)	Measurement Level (kHz)	Required Limit (kHz)	Result
6	2437.00	15800	>500	Pass

Figure Channel 6: (Chain A)

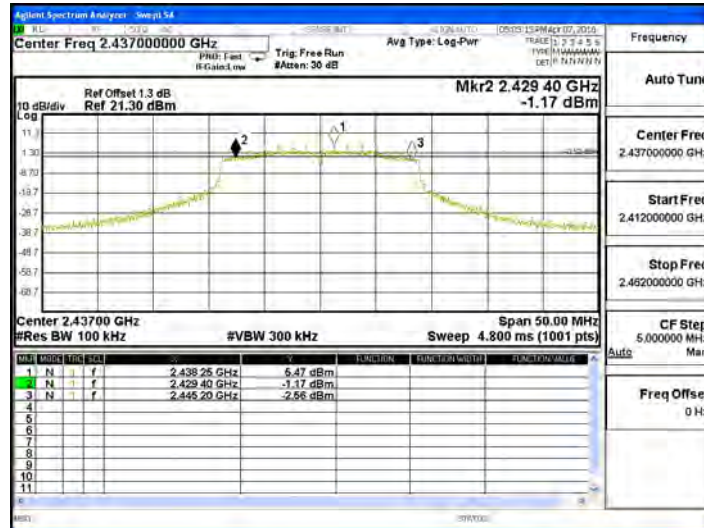

Channel No.	Frequency (MHz)	Measurement Level (kHz)	Required Limit (kHz)	Result
6	2437.00	16650	>500	Pass

Figure Channel 6: (Chain B)

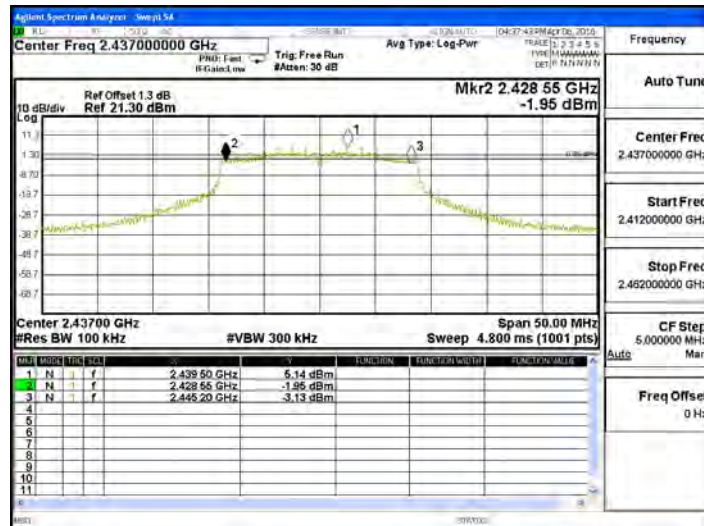

Product : TABLET PC
 Test Item : 6dB Bandwidth Data
 Test Site : No.3 OATS
 Test Mode : Mode 3: Transmit - 802.11n-20BW_14.4Mbps(2.4G Band) (2462MHz)

Channel No.	Frequency (MHz)	Measurement Level (kHz)	Required Limit (kHz)	Result
11	2462.00	15200	>500	Pass

Figure Channel 11: (Chain A)

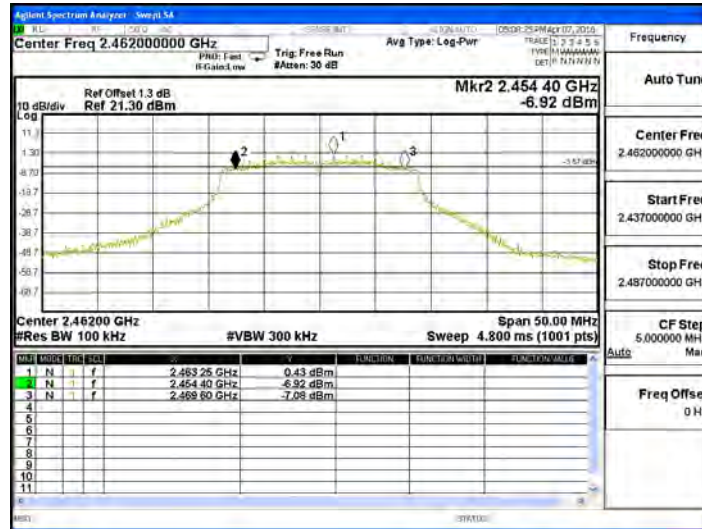

Channel No.	Frequency (MHz)	Measurement Level (kHz)	Required Limit (kHz)	Result
11	2462.00	15800	>500	Pass

Figure Channel 11: (Chain B)

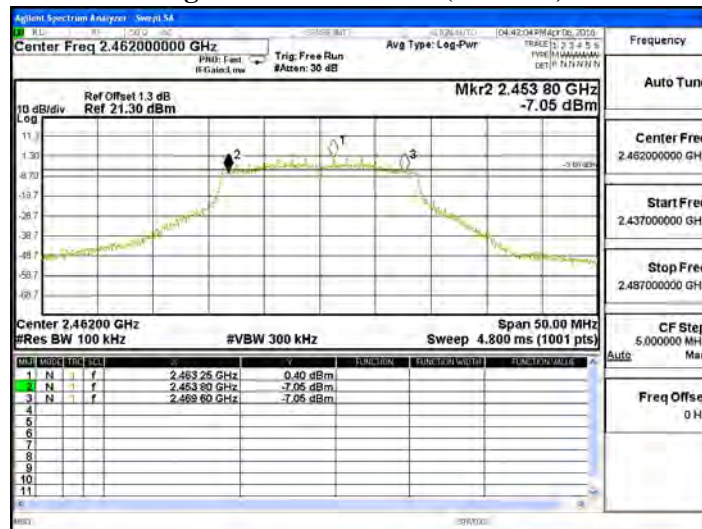

Product : TABLET PC
 Test Item : 6dB Bandwidth Data
 Test Site : No.3 OATS
 Test Mode : Mode 4: Transmit - 802.11n-40BW_30Mbps(2.4G Band) (2422MHz)

Channel No.	Frequency (MHz)	Measurement Level (kHz)	Required Limit (kHz)	Result
3	2422.00	35300	>500	Pass

Figure Channel 1: (Chain A)

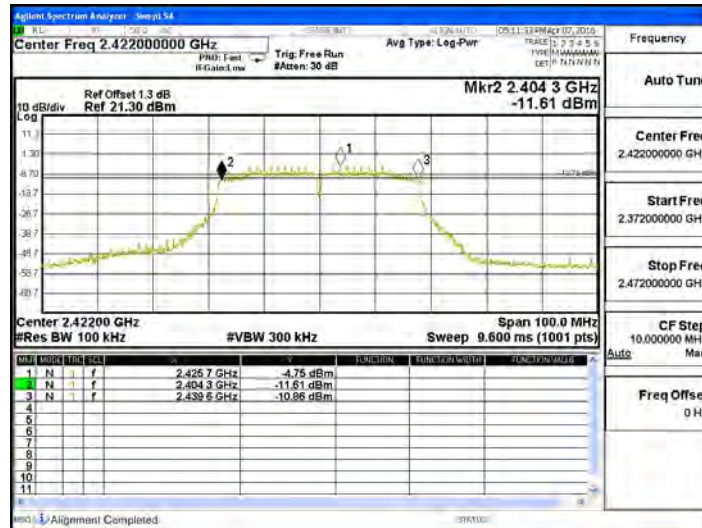

Channel No.	Frequency (MHz)	Measurement Level (kHz)	Required Limit (kHz)	Result
3	2422.00	35400	>500	Pass

Figure Channel 1: (Chain B)



Product : TABLET PC
 Test Item : 6dB Bandwidth Data
 Test Site : No.3 OATS
 Test Mode : Mode 4: Transmit - 802.11n-40BW_30Mbps(2.4G Band) (2437MHz)

Channel No.	Frequency (MHz)	Measurement Level (kHz)	Required Limit (kHz)	Result
6	2437.00	35300	>500	Pass

Figure Channel 4: (Chain A)



Channel No.	Frequency (MHz)	Measurement Level (kHz)	Required Limit (kHz)	Result
6	2437.00	35300	>500	Pass

Figure Channel 4: (Chain B)

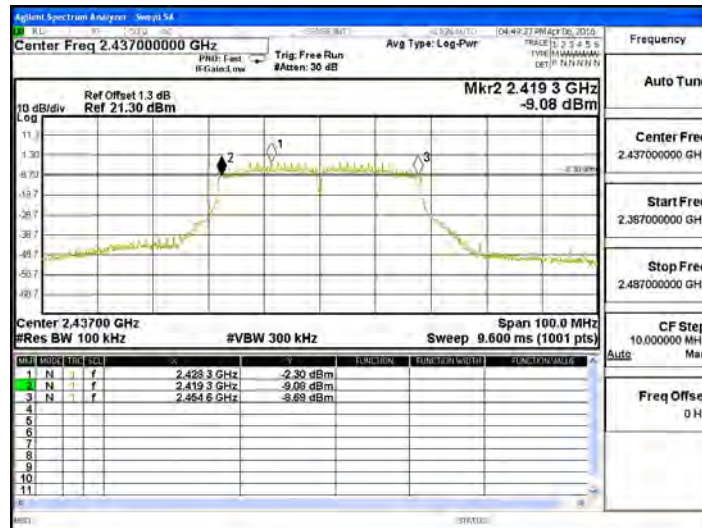

Product : TABLET PC
 Test Item : 6dB Bandwidth Data
 Test Site : No.3 OATS
 Test Mode : Mode 4: Transmit - 802.11n-40BW_30Mbps(2.4G Band) (2452MHz)

Channel No.	Frequency (MHz)	Measurement Level (kHz)	Required Limit (kHz)	Result
9	2452.00	35400	>500	Pass

Figure Channel 7: (Chain A)



Channel No.	Frequency (MHz)	Measurement Level (kHz)	Required Limit (kHz)	Result
9	2452.00	35400	>500	Pass

Figure Channel 7: (Chain B)



8. Power Density

8.1. Test Equipment

	Equipment	Manufacturer	Model No./Serial No.	Last Cal.
	Spectrum Analyzer	R&S	FSP40 / 100170	Jun, 2015
	Spectrum Analyzer	Agilent	E4407B / US39440758	Jun, 2015
X	Spectrum Analyzer	Agilent	N9010A / MY48030495	Apr., 2016

Note:

1. All equipments are calibrated with traceable calibrations. Each calibration is traceable to the national or international standards.
2. The test instruments marked with “X” are used to measure the final test results.

8.2. Test Setup

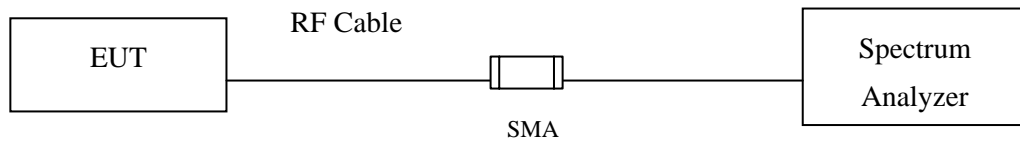

8.3. Limits

The transmitted power density averaged over any 1 second interval shall not be greater +8dBm in any 3kHz bandwidth.

8.4. Test Procedure

The EUT was setup according to ANSI C63.10, 2013; tested according to DTS test procedure of KDB 558074 for compliance to FCC 47CFR 15.247 requirements.

The maximum power spectral density using KDB 558074 section 10.2 PKPSD (peak PSD) method.

8.5. Uncertainty

± 1.27 dB

8.6. Test Result of Power Density

Product : TABLET PC
 Test Item : Power Density Data
 Test Site : No.3 OATS
 Test Mode : Mode 1: Transmit (802.11b 1Mbps) (2412MHz)

Channel No.	Frequency (MHz)	Measure Level (dBm)	Limit (dBm)	Result
1	2412	5.360	≤ 8dBm	Pass

Figure Channel 1:

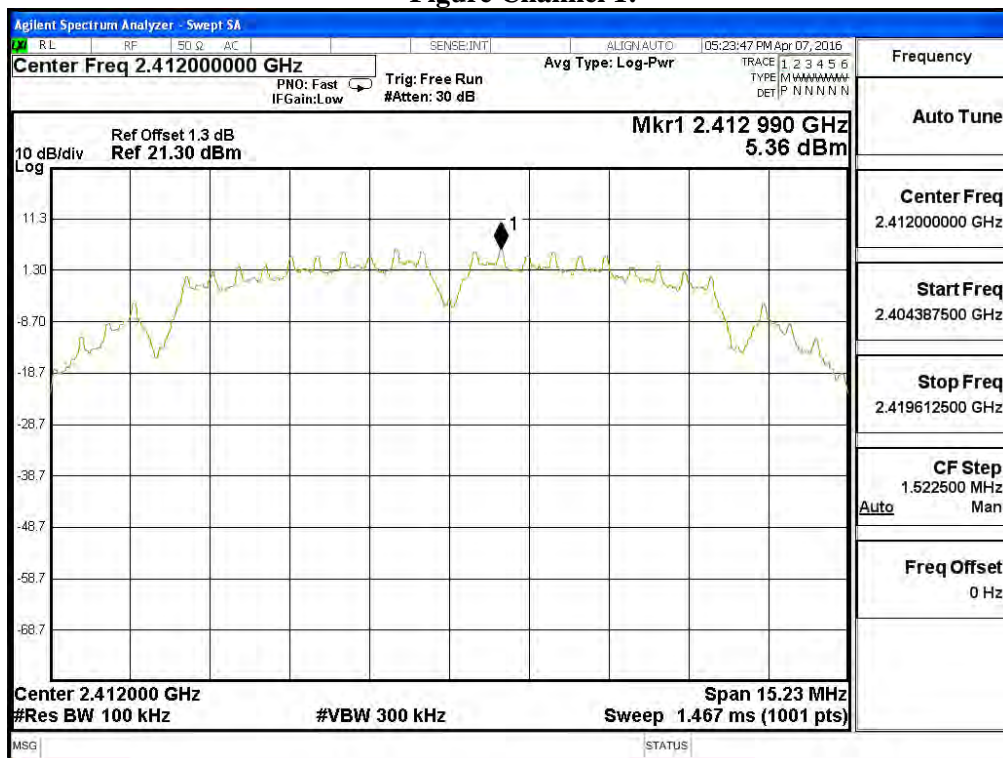

Product : TABLET PC
 Test Item : Power Density Data
 Test Site : No.3OATS
 Test Mode : Mode 1: Transmit (802.11b 1Mbps) (2437MHz)

Channel No.	Frequency (MHz)	Measure Level (dBm)	Limit (dBm)	Result
6	2437	6.800	≤ 8dBm	Pass

Figure Channel 6:

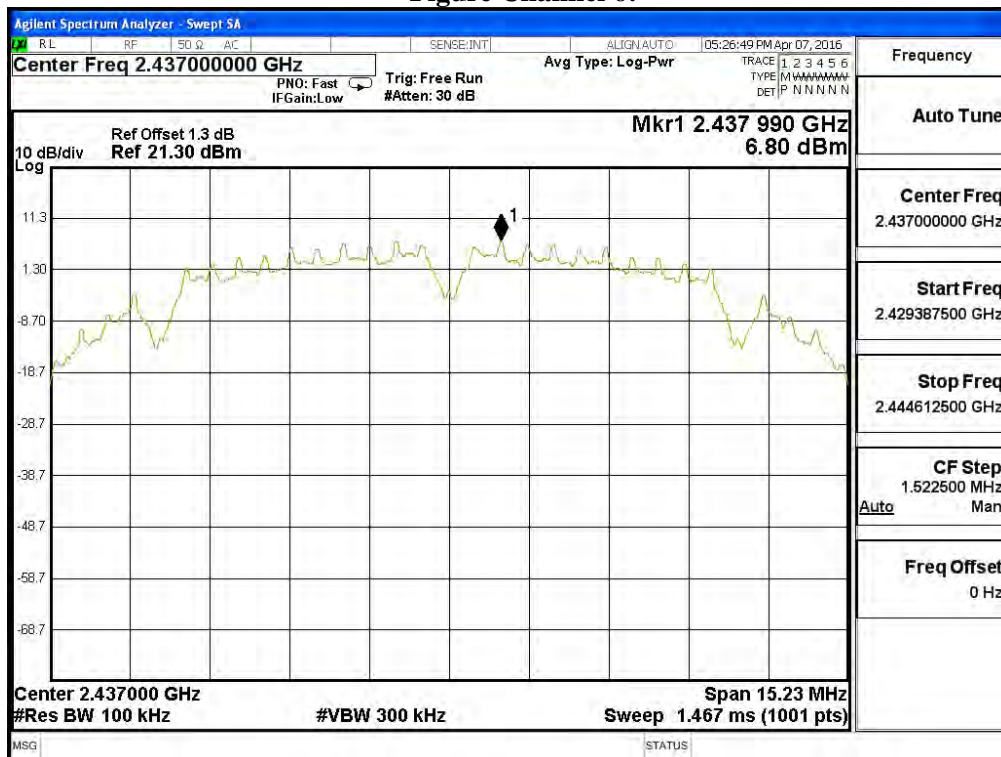

Product : TABLET PC
 Test Item : Power Density Data
 Test Site : No.3 OATS
 Test Mode : Mode 1: Transmit (802.11b 1Mbps) (2462MHz)

Channel No.	Frequency (MHz)	Measure Level (dBm)	Limit (dBm)	Result
11	2462	5.830	≤ 8dBm	Pass

Figure Channel 11:

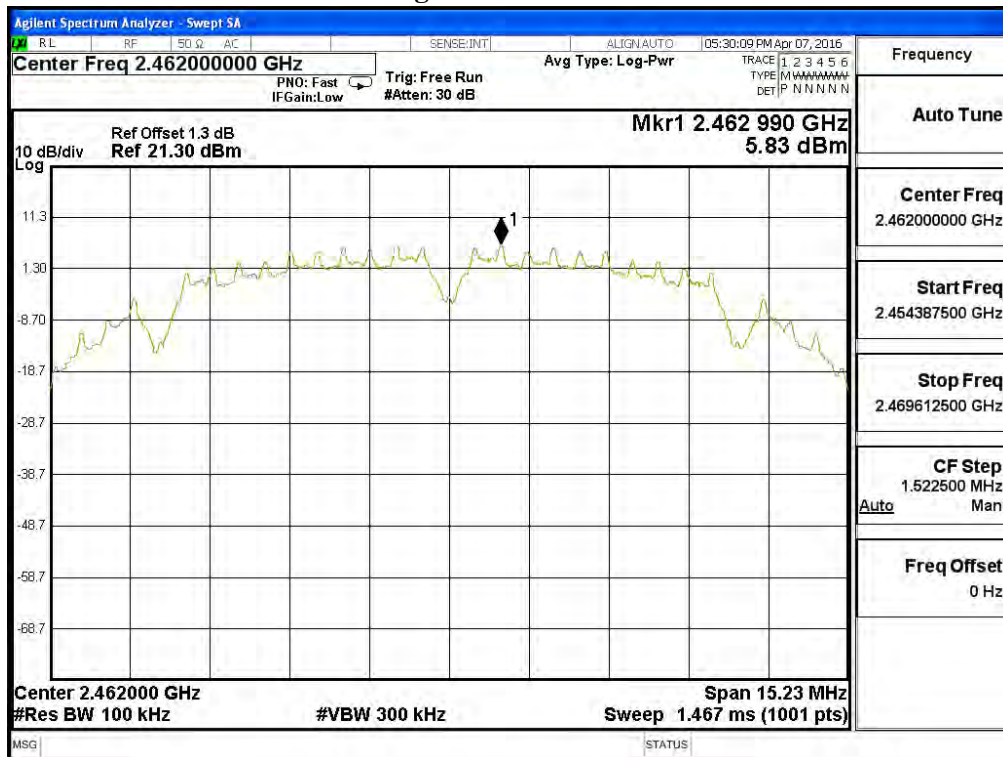

Product : TABLET PC
 Test Item : Power Density Data
 Test Site : No.3 OATS
 Test Mode : Mode 2: Transmit (802.11g 6Mbps) (2412MHz)

Channel No.	Frequency (MHz)	Measure Level (dBm)	Limit (dBm)	Result
1	2412	2.220	≤ 8dBm	Pass

Figure Channel 1:

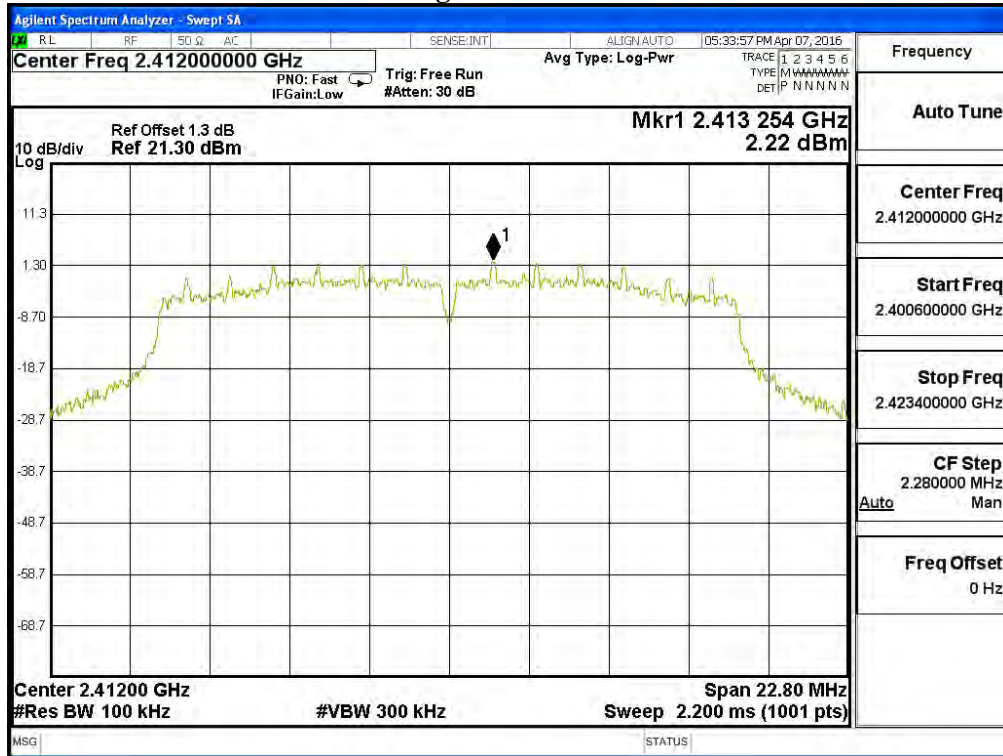

Product : TABLET PC
 Test Item : Power Density Data
 Test Site : No.3OATS
 Test Mode : Mode 2: Transmit (802.11g 6Mbps) (2437MHz)

Channel No.	Frequency (MHz)	Measure Level (dBm)	Limit (dBm)	Result
6	2437	5.810	≤ 8dBm	Pass

Figure Channel 6:

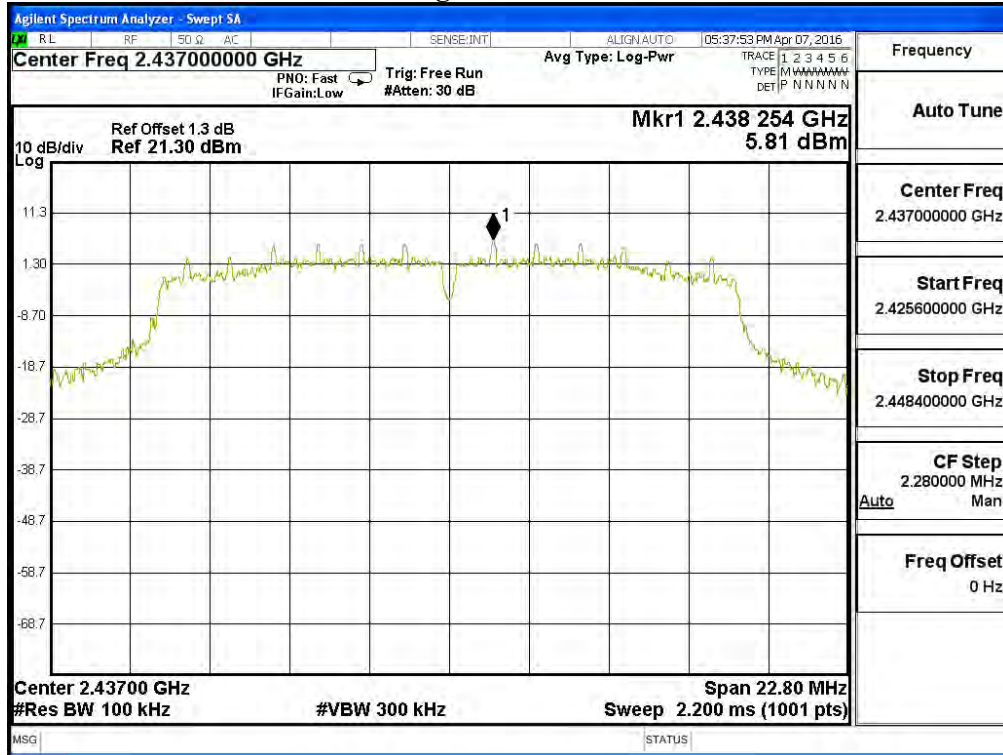

Product : TABLET PC
 Test Item : Power Density Data
 Test Site : No.3 OATS
 Test Mode : Mode 2: Transmit (802.11g 6Mbps) (2462MHz)

Channel No.	Frequency (MHz)	Measure Level (dBm)	Limit (dBm)	Result
11	2462	0.910	≤ 8dBm	Pass

Figure Channel 11:

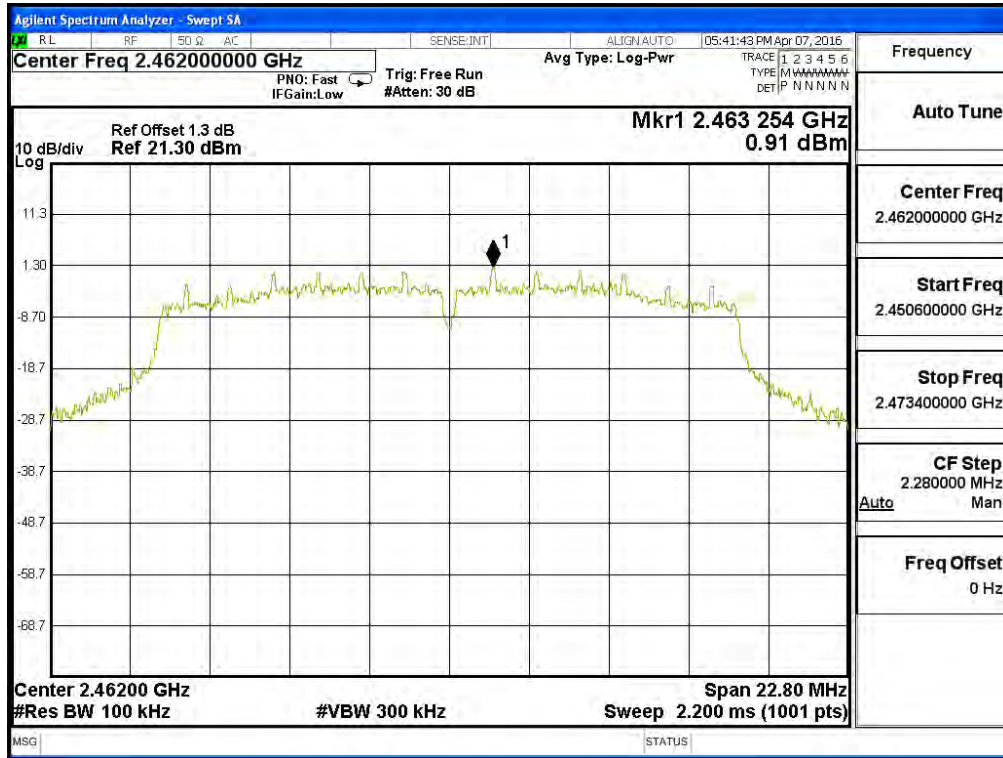

Product : TABLET PC
 Test Item : Power Density Data
 Test Site : No.3 OATS
 Test Mode : Mode 3: Transmit - 802.11n-20BW_14.4Mbps(2.4G Band) (2412MHz)

CHAIN	PPSD/MHz (dBm)	Total PPSD/MHz (dBm)1	Limit	Result
A	0.140	3.150	≤ 8dBm	Pass
B	-0.120	2.890	≤ 8dBm	Pass

Note 1: The quantity 10*log 2 (two antennas) is added to the spectrum peak value according to document 662911 D01.

Figure Channel 1: (Chain A)

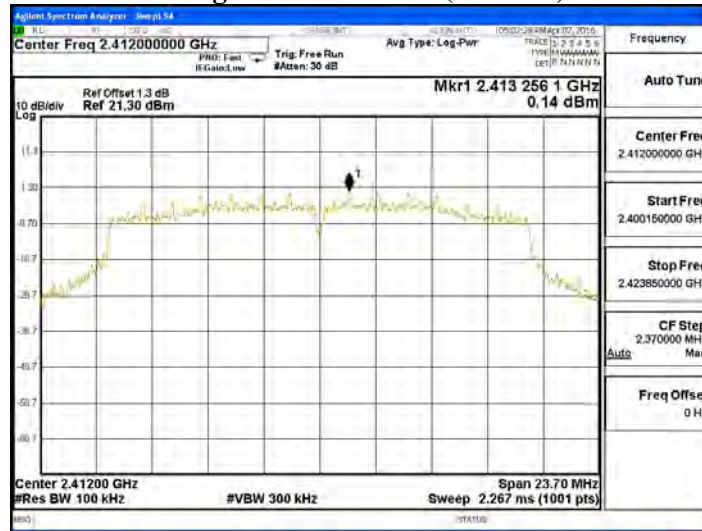
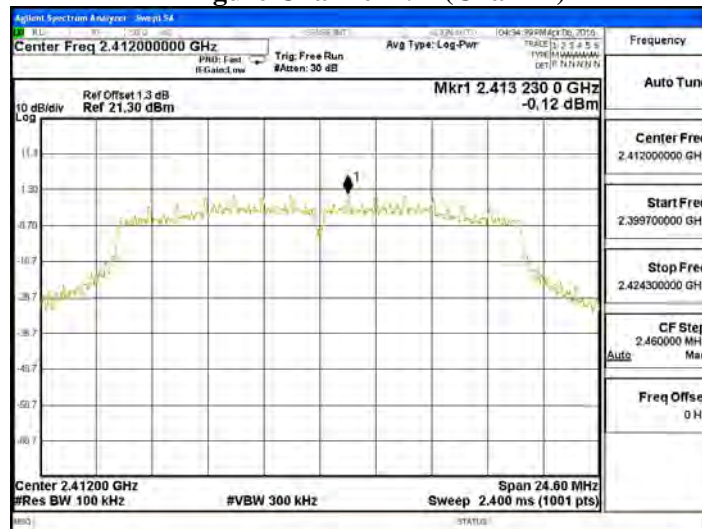

Figure Channel 1: (Chain B)



Product : TABLET PC
 Test Item : Power Density Data
 Test Site : No.3OATS
 Test Mode : Mode 3: Transmit - 802.11n-20BW_14.4Mbps(2.4G Band) (2437MHz)

CHAIN	PPSD/MHz (dBm)	Total PPSD/MHz (dBm)1	Limit	Result
A	4.523	7.533	≤ 8dBm	Pass
B	4.047	7.057	≤ 8dBm	Pass

Note 1: The quantity $10 \cdot \log 2$ (two antennas) is added to the spectrum peak value according to document 662911 D01.

Figure Channel 6: (Chain A)

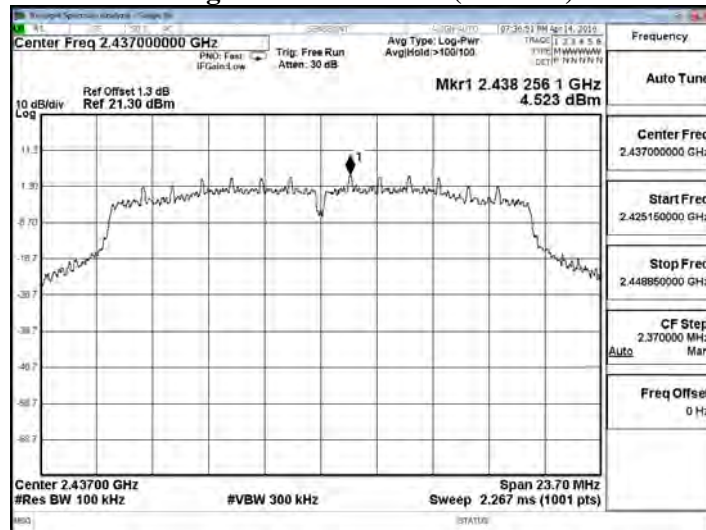
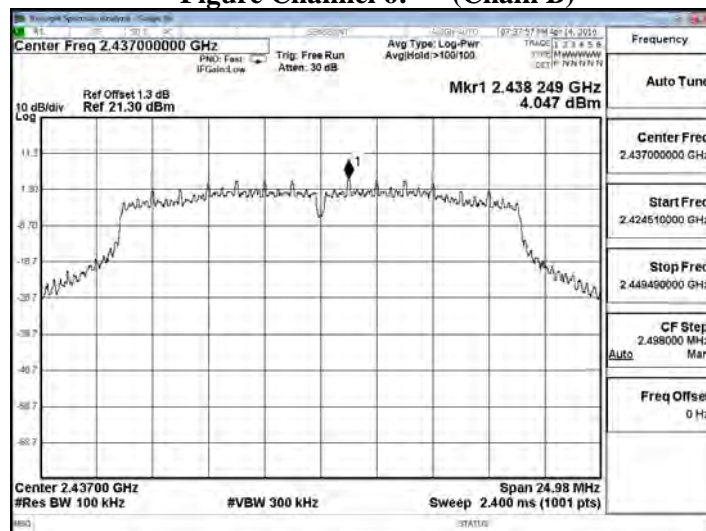

Figure Channel 6: (Chain B)



Product : TABLET PC
 Test Item : Power Density Data
 Test Site : No.3 OATS
 Test Mode : Mode 3: Transmit - 802.11n-20BW_14.4Mbps(2.4G Band) (2462MHz)

CHAIN	PPSD/MHz (dBm)	Total PPSD/MHz (dBm)1	Limit	Result
A	0.380	3.390	≤ 8dBm	Pass
B	0.410	3.420	≤ 8dBm	Pass

Note 1: The quantity 10*log 2 (two antennas) is added to the spectrum peak value according to document 662911 D01.

Figure Channel 11: (Chain A)

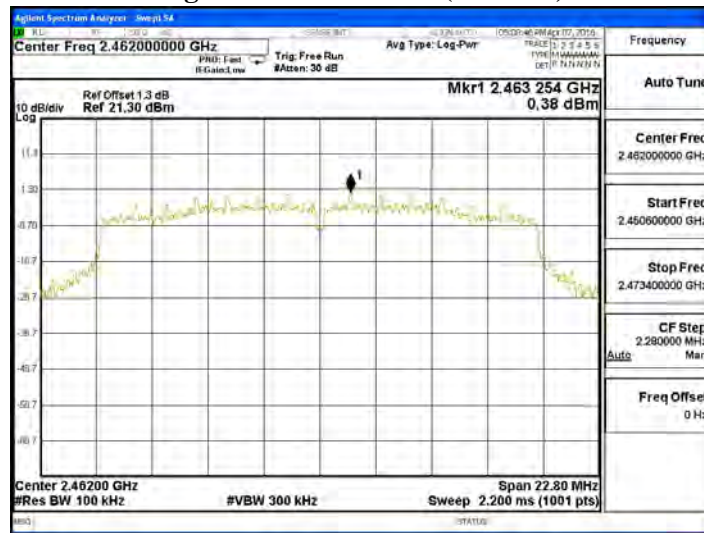
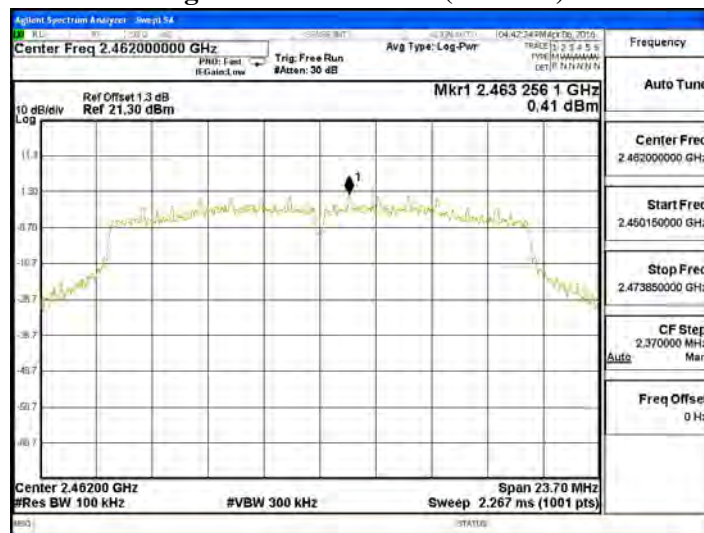

Figure Channel 11: (Chain B)



Product : TABLET PC
 Test Item : Power Density Data
 Test Site : No.3 OATS
 Test Mode : Mode 4: Transmit - 802.11n-40BW_30Mbps(2.4G Band) (2422MHz)

CHAIN	PPSD/MHz (dBm)	Total PPSD/MHz (dBm)1	Limit	Result
A	-4.800	-1.790	≤ 8dBm	Pass
B	-4.630	-1.620	≤ 8dBm	Pass

Note 1: The quantity 10*log 2 (two antennas) is added to the spectrum peak value according to document 662911 D01.

Figure Channel 3: (Chain A)

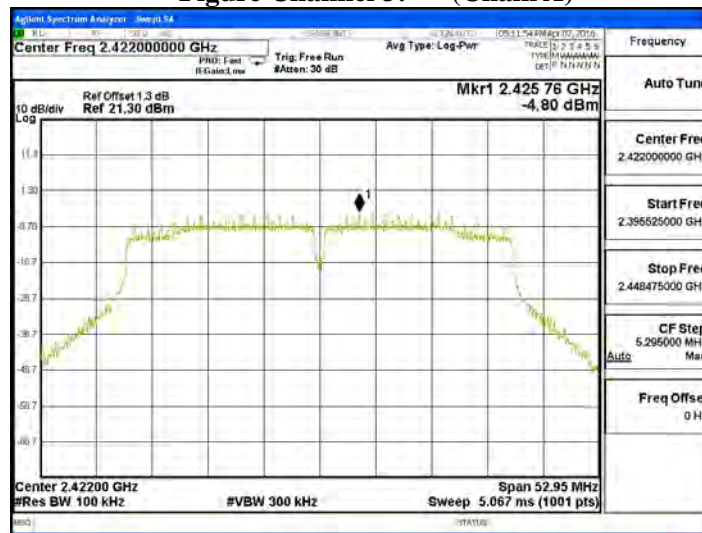
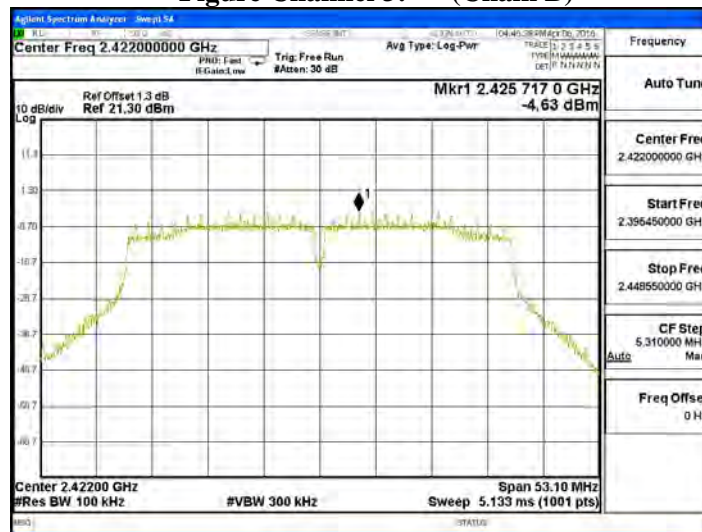

Figure Channel 3: (Chain B)



Product : TABLET PC
 Test Item : Power Density Data
 Test Site : No.3OATS
 Test Mode : Mode 4: Transmit - 802.11n-40BW_30Mbps(2.4G Band) (2437MHz)

CHAIN	PPSD/MHz (dBm)	Total PPSD/MHz (dBm)1	Limit	Result
A	-2.160	0.850	≤ 8dBm	Pass
B	-2.440	0.570	≤ 8dBm	Pass

Note 1: The quantity 10*log 2 (two antennas) is added to the spectrum peak value according to document 662911 D01.

Figure Channel 6: (Chain A)



Figure Channel 6: (Chain B)



Product : TABLET PC
 Test Item : Power Density Data
 Test Site : No.3 OATS
 Test Mode : Mode 4: Transmit - 802.11n-40BW_30Mbps(2.4G Band) (2452MHz)

CHAIN	PPSD/MHz (dBm)	Total PPSD/MHz (dBm)1	Limit	Result
A	-6.100	-3.090	≤ 8dBm	Pass
B	-6.180	-3.170	≤ 8dBm	Pass

Note 1: The quantity 10*log 2 (two antennas) is added to the spectrum peak value according to document 662911 D01.

Figure Channel 9: (Chain A)

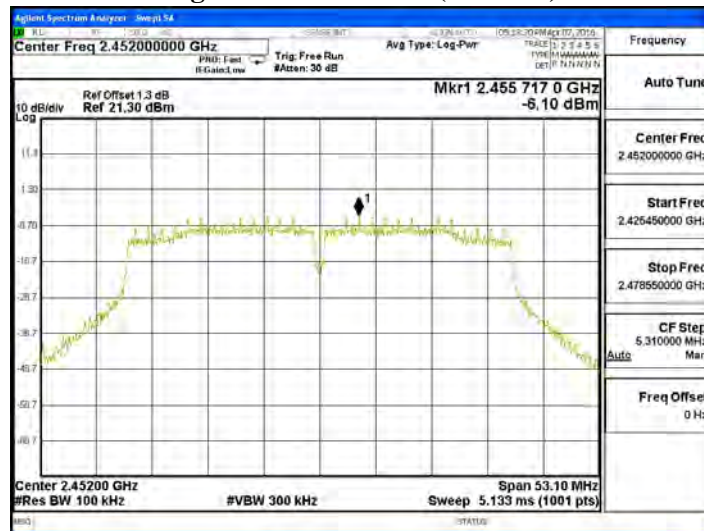
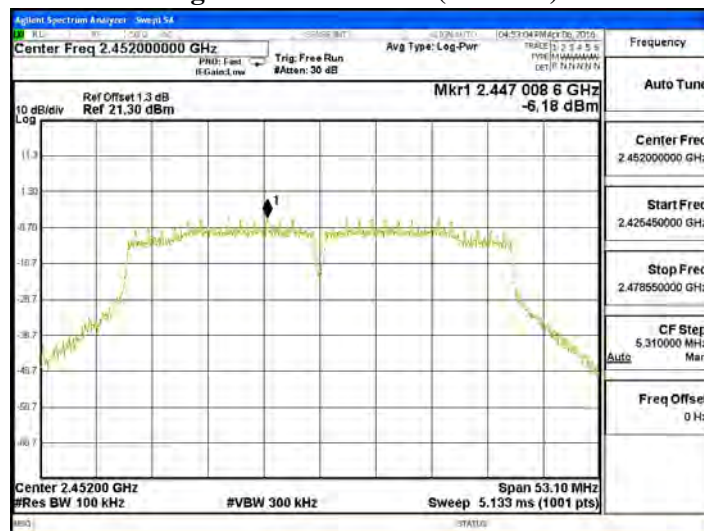

Figure Channel 9: (Chain B)



9. EMI Reduction Method During Compliance Testing

No modification was made during testing.