

FCC Test Report

Product Name	TABLET PC
Model No.	PM-311B
FCC ID	2ABTU-PM311B

Applicant	RuggON Corporation
Address	3F., No.10, Ln. 181, Sec. 2, Jiuzong Rd., Neihu Dist., Taipei City 114, Taiwan (R.O.C.)

Date of Receipt	Mar. 25, 2016
Issued Date	May 10, 2016
Report No.	1630475R-RFUSP17V00
Report Version	V1.0



The test results relate only to the samples tested.

The test results shown in the test report are traceable to the national/international standard through the calibration report of the equipment and evaluated measurement uncertainty herein.

This report must not be used to claim product endorsement by TAF or any agency of the government.

The test report shall not be reproduced without the written approval of QuieTek Corporation.

Test Report

Issued Date: May 10, 2016

Report No.: 1630475R-RFUSP17V00



Product Name	TABLET PC
Applicant	RuggON Corporation
Address	3F., No.10, Ln. 181, Sec. 2, Jiuzong Rd., Neihu Dist., Taipei City 114, Taiwan (R.O.C.)
Model No.	PM-311B
FCC ID.	2ABTU-PM311B
EUT Rated Voltage	AC 100-240V, 50-60Hz
EUT Test Voltage	AC 120V/60Hz
Trade Name	RuggON
Applicable Standard	FCC CFR Title 47 Part 15 Subpart C: 2015 ANSI C63.4: 2014, ANSI C63.10: 2013
Test Result	Complied

Documented By : Jinn Chen
(Senior Adm. Specialist / Jinn Chen)

Tested By : Nick Chen
(Engineer / Nick Chen)

Approved By : 
(Director / Vincent Lin)

TABLE OF CONTENTS

Description	Page
1. GENERAL INFORMATION	4
1.1. EUT Description.....	4
1.2. Operational Description	5
1.3. Tested System Details.....	6
1.4. Configuration of tested System	6
1.5. EUT Exercise Software	7
1.6. Test Facility	8
2. Conducted Emission.....	9
2.1. Test Equipment.....	9
2.2. Test Setup	9
2.3. Limits	10
2.4. Test Procedure	10
2.5. Uncertainty	10
2.6. Test Result of Conducted Emission.....	11
3. Radiated Emission.....	13
3.1. Test Equipment.....	13
3.2. Test Setup	13
3.3. Limits	14
3.4. Test Procedure	15
3.5. Uncertainty	16
3.6. Test Result of Radiated Emission.....	17
4. Band Edge	20
4.1. Test Equipment.....	20
4.2. Test Setup	20
4.3. Limits	21
4.4. Test Procedure	21
4.5. Uncertainty	21
4.6. Test Result of Band Edge	22
5. Frequency Tolerance	23
5.1. Test Equipment.....	23
5.2. Test Setup	23
5.3. Limits	23
5.4. Test Procedure	23
5.5. Uncertainty	23
5.6. Test Result of Frequency Stability.....	24
6. EMI Reduction Method During Compliance Testing	26
Attachment 1: EUT Test Photographs	
Attachment 2: EUT Detailed Photographs	

1. GENERAL INFORMATION

1.1. EUT Description

Product Name	TABLET PC
Trade Name	RuggON
Model No.	PM-311B
FCC ID	2ABTU-PM311B
Frequency Range	13.56MHz
Modulation	ASK
Antenna Type	Loop Antenna
Power Adapter	MFR: FSP, M/N: FSP065-REB Input: 100-240V~1.5A, 50-60Hz Output: 19V $\overline{\text{---}}$ 3.42A Cable Out: Shielded, 1.2m, with one ferrite core bonded.

Frequency of Each Channel:

Channel	Frequency
Channel 1:	13.56 MHz

Note:

1. This device is an TABLET PC with a built-in 13.56MHz transceiver.
2. These tests were conducted on a sample of the equipment for the purpose of demonstrating compliance with Part 15 Subpart C Paragraph 15.225
3. The radiation measurements are performed in X, Y, Z axis positioning. Only the worst case is shown in the report.

Test Mode	Mode 1: Transmit mode
-----------	-----------------------

1.3. Tested System Details

The types for all equipment, plus descriptions of all cables used in the tested system (including inserted cards) are:

	Product	Manufacturer	Model No.	Serial No.	Power Cord
(1)	Microphone & Earphone	Ergotech	E201	N/A	N/A
(2)	Keyboard	Logitech	Y-UR83	SY848UK	N/A
(3)	USB Mouse	Logitech	M-BZ96C	LZ128HR	N/A
(4)	Modem	ACEEX	DM-1414	0102027550	Non-Shielded, 1.8m

Signal Cable Type	Signal cable Description
A LAN Cable	Shielded, 1.5m
B USB Cable	Shielded, 1.7m
C Earphone Cable	Non-Shielded, 2.0m
D USB Cable	Shielded, 2.0m
E Modem Cable	Shielded, 2.0m

1.4. Configuration of tested System

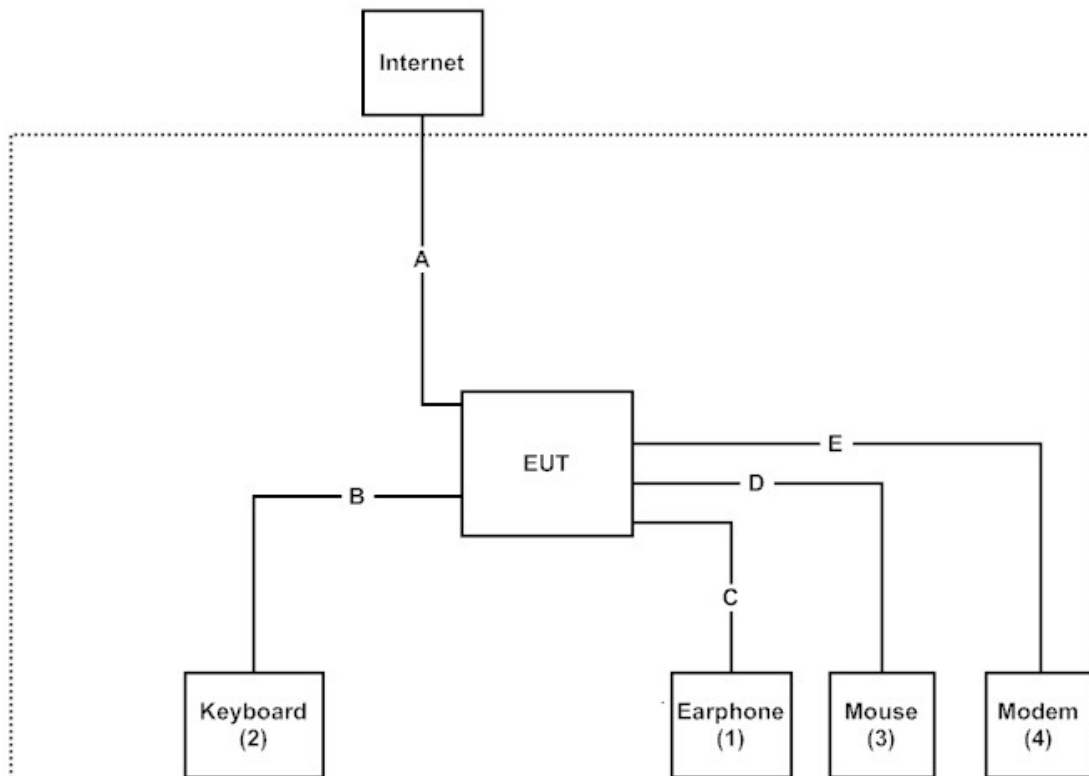

1.5. EUT Exercise Software

- (1) Setup the EUT as shown in Section 1.4
- (2) Turn on the power of the EUT.
- (3) Start the continuous transmitter.
- (4) Verify that the EUT works properly.

1.6. Test Facility

Ambient conditions in the laboratory:

Items	Required (IEC 68-1)	Actual
Temperature (°C)	15-35	20-35
Humidity (%RH)	25-75	50-65
Barometric pressure (mbar)	860-1060	950-1000

The related certificate for our laboratories about the test site and management system can be downloaded from QuieTek Corporation's Web Site: <http://www.quietek.com/chinese/about/certificates.aspx?bval=5>

The address and introduction of QuieTek Corporation's laboratories can be founded in our Web site: <http://www.quietek.com/>

Site Description: File on
 Federal Communications Commission
 FCC Engineering Laboratory
 7435 Oakland Mills Road
 Columbia, MD 21046
 Registration Number: 92195

Site Name: Quietek Corporation
 Site Address: No.5-22, Ruishukeng,
 Linkou Dist. New Taipei City 24451,
 Taiwan, R.O.C.
 TEL: 886-2-8601-3788 / FAX : 886-2-8601-3789
 E-Mail : service@quietek.com

FCC Accreditation Number: TW1014

2. Conducted Emission

2.1. Test Equipment

	Equipment	Manufacturer	Model No. / Serial No.	Last Cal.	Remark
X	Test Receiver	R & S	ESCS 30 / 825442/018	Sep., 2015	
X	Artificial Mains Network	R & S	ENV4200 / 848411/10	Feb., 2016	Peripherals
X	LISN	R & S	ESH3-Z5 / 825562/002	Feb., 2016	EUT
	DC LISN	Schwarzbeck	8226 / 176	Mar, 2016	EUT
X	Pulse Limiter	R & S	ESH3-Z2 / 357.8810.52	Feb., 2016	
	No.1 Shielded Room				

Note:

1. All equipments are calibrated every one year.
2. The test instruments marked by "X" are used to measure the final test results.

2.2. Test Setup

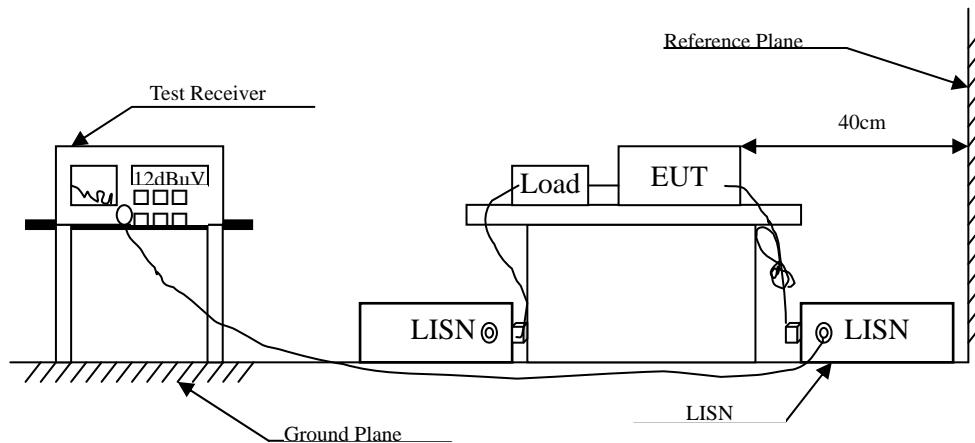

2.3. Limits

FCC Part 15 Subpart C Paragraph 15.207 (dBuV) Limit		
Frequency MHz	Limits	
	QP	AV
0.15 - 0.50	66-56 _(註)	56-46 _(註)
0.50-5.0	56	46
5.0 - 30	60	50

2.4. Test Procedure

The EUT and simulators are connected to the main power through a line impedance stabilization network (L.I.S.N.). This provides a 50 ohm /50uH coupling impedance for the measuring equipment. The peripheral devices are also connected to the main power through a LISN that provides a 50ohm /50uH coupling impedance with 50ohm termination. (Please refers to the block diagram of the test setup and photographs.)

Both sides of A.C. line are checked for maximum conducted interference. In order to find the maximum emission, the relative positions of equipment and all of the interface cables must be changed according to ANSI C63.4: 2014 on conducted measurement.

Conducted emissions were invested over the frequency range from 0.15MHz to 30MHz using a receiver bandwidth of 9kHz.

2.5. Uncertainty

± 2.26 dB

2.6. Test Result of Conducted Emission

Product : TABLET PC
 Test Item : Conducted Emission Test
 Power Line : Line 1
 Test Mode : Mode 1: Transmit mode

Frequency MHz	Correct Factor dB	Reading Level dBuV	Measurement Level dBuV	Margin dB	Limit dBuV
LINE 1					
Quasi-Peak					
0.162	9.667	37.660	47.327	-18.330	65.657
0.193	9.660	36.660	46.320	-18.451	64.771
0.216	9.661	29.810	39.471	-24.643	64.114
0.298	9.666	22.070	31.736	-30.035	61.771
0.650	9.685	23.170	32.855	-23.145	56.000
12.759	9.986	15.550	25.536	-34.464	60.000
Average					
0.162	9.667	28.940	38.607	-17.050	55.657
0.193	9.660	28.890	38.550	-16.221	54.771
0.216	9.661	24.550	34.211	-19.903	54.114
0.298	9.666	14.930	24.596	-27.175	51.771
0.650	9.685	22.150	31.835	-14.165	46.000
12.759	9.986	9.330	19.316	-30.684	50.000

Note:

1. All Reading Levels are Quasi-Peak and average value.
2. “” means the worst emission level.
3. Measurement Level = Reading Level + Correct Factor

Product : TABLET PC
 Test Item : Conducted Emission Test
 Power Line : Line 2
 Test Mode : Mode 1: Transmit mode

Frequency MHz	Correct Factor dB	Reading Level dBuV	Measurement Level dBuV	Margin dB	Limit dBuV
LINE 2					
Quasi-Peak					
0.162	9.667	40.540	50.207	-15.450	65.657
0.189	9.660	36.880	46.540	-18.346	64.886
0.216	9.661	33.590	43.251	-20.863	64.114
0.244	9.663	30.460	40.123	-23.191	63.314
0.646	9.685	17.800	27.485	-28.515	56.000
3.595	9.822	11.640	21.462	-34.538	56.000
Average					
0.162	9.667	25.910	35.577	-20.080	55.657
0.189	9.660	28.460	38.120	-16.766	54.886
0.216	9.661	14.100	23.761	-30.353	54.114
0.244	9.663	23.350	33.013	-20.301	53.314
0.646	9.685	-2.390	7.295	-38.705	46.000
3.595	9.822	10.880	20.702	-25.298	46.000

Note:

1. All Reading Levels are Quasi-Peak and average value.
2. "■" means the worst emission level.
3. Measurement Level = Reading Level + Correct Factor

3. Radiated Emission

3.1. Test Equipment

The following test equipments are used during the radiated emission test:

Test Site	Equipment	Manufacturer	Model No./Serial No.	Last Cal.	
☒ Site # 3	X	Magnetic Loop Antenna	Teseq	HLA6121/ 37133	Sep, 2015
	X	Bilog Antenna	Schaffner Chase	CBL6112B/ 2707	Jun, 2015
	X	EMI Test Receiver	R&S	ESCS 30/838251/ 001	Jun, 2015
	X	Coaxial Cable	QTK(Arnist)	RG 214/ LC003-RG	Jun, 2015
	X	Coaxial signal switch	Arnist	MP59B/ 6200798682	Jun, 2015

Test Site	Equipment	Manufacturer	Model No./Serial No.	Last Cal.	
☒ CB # 8	X	Spectrum Analyzer	R&S	FSP40/ 100339	Oct, 2015
	X	Horn Antenna	ETS-Lindgren	3117/ 35205	Mar, 2016
	X	Horn Antenna	Schwarzbeck	BBHA9170/209	Jan, 2016
	X	Horn Antenna	TRC	AH-0801/95051	Aug, 2015
	X	Pre-Amplifier	EMCI	EMC012630SE/980210	Jan, 2016
	X	Pre-Amplifier	MITEQ	JS41-001040000-58-5P/153945	Jul, 2015
	X	Pre-Amplifier	NARDA	DBL-1840N506/013	Jul, 2015

- Note: 1. All equipments are calibrated with traceable calibrations. Each calibration is traceable to the national or international standards.
2. The test instruments marked with "X" are used to measure the final test results.

3.2. Test Setup

9kHz~30MHz

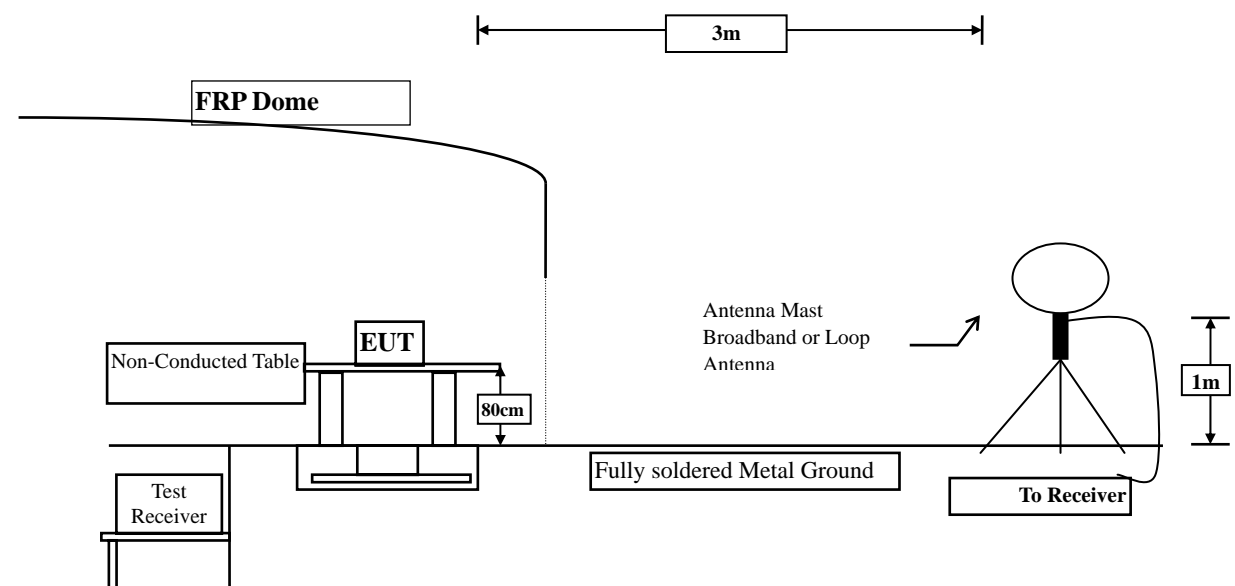

30MHz~1GHz

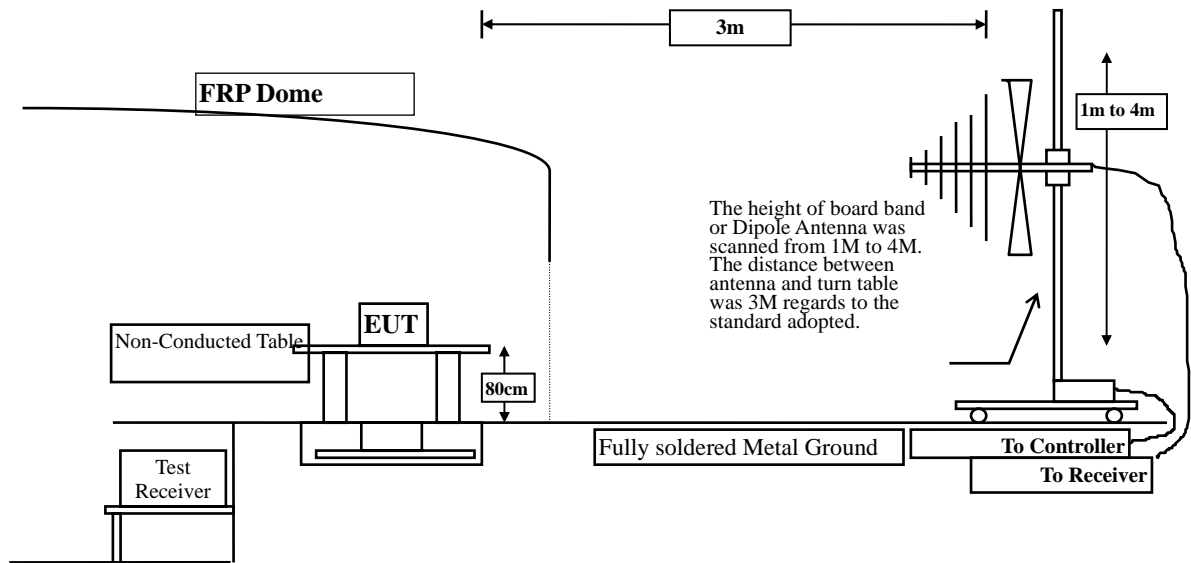

3.3. Limits

➤ Fundamental electric field strength Limit

FCC Part 15 Subpart C Paragraph 15.225 Limits				
Fundamental Frequency MHz	Field strength of fundamental			
	uV/m	Distance (meter)	dBuV/m	Distance (meter)
13.553 – 13.567	15848	30	124	3
13.410 – 13.553 and 13.567 – 13.710	334	30	90.47	3
13.110 – 13.410 and 13.710 – 14.010	106	30	80.50	3
Outside of the 13.110 – 14.010	See 15.209 Limits			

Remarks : 1. RF Voltage (dBuV) = 20 log RF Voltage (uV)

2. Distance refers to the distance in meters between the measuring instrument antenna and the closed point of any part of the device or system.

3. The emission limit in this paragraph is based on measurement instrumentation employing an average detector.

► Spurious electric field strength Limit

FCC Part 15 Subpart C Paragraph 15.209 Limits			
Frequency MHz	uV/m	dBuV/m	Measurement distance (meter)
0.009-0.490	2400/F(kHz)	See Remark ¹	300
0.490-1.705	24000/F(kHz)	See Remark ¹	30
1.705-30	30	29.5	30
30-88	100	40	3
88-216	150	43.5	3
216-960	200	46	3
Above 960	500	54	3

- Remarks :
1. RF Voltage (dBuV) = 20 log RF Voltage (uV)
 2. In the Above Table, the tighter limit applies at the band edges.
 3. Distance refers to the distance in meters between the measuring instrument antenna and the closed point of any part of the device or system.

3.4. Test Procedure

Fundamental electric field strength:

The EUT and its simulators are placed on a turn table which is 1 meter above ground. The turn table can rotate 360 degrees to determine the position of the maximum electric field strength.

The EUT was positioned such that the distance from antenna to the EUT was 3 meters.

The antenna which is 1 meter above ground. All X-axis, Y-axis and Z-axis polarization of the antenna are set on measurement.

Spurious electric field strength:

The EUT and its simulators are placed on a turn table which is 0.8 meter above ground. The turn table can rotate 360 degrees to determine the position of the maximum emission level.

The antenna can move up and down between 1 meter and 4 meters to find out the maximum emission level. The EUT was positioned such that the distance from antenna to the EUT was 3 meters.

Both horizontal and vertical polarization of the antenna are set on measurement. In order to find the maximum emission, all of the interface cables must be manipulated according to ANSI C6310: 2013 on radiated measurement.

On any frequency the radiated limits shown are based upon the use of measurement instrumentation employing an average detector function. When average radiated emission measurement are included emission measurement below 1000 MHz, there also is a limit on the radio frequency emissions, as

measured using instrumentation with a peak detector function, corresponding to 20 dB above the maximum permitted average limit.

The bandwidth below 30MHz setting on the field strength meter is 9kHz and above 30MHz is 120kHz.

The frequency range from 9kHz to 10th harmonics is checked.

3.5. Uncertainty

± 2.6 dB below 30MHz

± 3.8 dB above 30MHz

3.6. Test Result of Radiated Emission

Product : TABLET PC
 Test Item : Fundamental Radiated Emission
 Test Site : No.3 OATS
 Test Mode : Mode 1: Transmit mode

Frequency MHz	Correct Factor dB	Reading Level dBuV	Measurement Level dBuV/m	Margin dB	Limit dBuV/m
X-axis					
Quasi-Peak					
Horizontal					
13.560	20.410	22.600	43.010	-80.990	124.000
Vertical					
13.560	20.410	25.100	45.510	-78.490	124.000
Y-axis					
Quasi-Peak					
Horizontal					
13.560	20.410	22.700	43.110	-80.890	124.000
Vertical					
13.560	20.410	25.200	45.610	-78.390	124.000
Z-axis					
Quasi-Peak					
Horizontal					
13.560	20.410	23.260	43.670	-80.330	124.000
Vertical					
13.560	20.410	24.920	45.330	-78.670	124.000

Note:

1. Limit=84dBuV/m + 40*Log (30(m)/3(m))=124dBuV/m
2. All Readings below 1GHz are Quasi-Peak, above are average value.
3. Measurement Level = Reading Level + Correct Factor.
4. The average measurement was not performed when the peak measured data under the limit of average detection. If the readings given are average, peak measurement should also be supplied.

Product : TABLET PC
 Test Item : General Radiated Emission Data (below 30MHz)
 Test Site : No.3 OATS
 Test Mode : Mode 1: Transmit mode

Frequency MHz	Correct Factor dB	Reading Level dBuV	Measurement Level dBuV/m	Margin dB	Limit dBuV/m
Horizontal					
27.120	19.950	3.740	23.690	-45.850	69.540
Vertical					
27.120	19.950	7.900	27.850	-41.690	69.540

Note:

1. $Limit = 29.54 \text{ dBuV/m} + 40 * \text{Log} (30(\text{m})/3(\text{m})) = 69.54 \text{ dBuV/m}$
2. All Readings below 1GHz are Quasi-Peak, above are average value.
3. "█" means the worst emission level.
4. Measurement Level = Reading Level + Correct Factor.

Product : TABLET PC
 Test Item : General Radiated Emission Data (above 30MHz)
 Test Site : No.3 OATS
 Test Mode : Mode 1: Transmit mode

Frequency MHz	Correct Factor dB	Reading Level dBuV	Measurement Level dBuV/m	Margin dB	Limit dBuV/m
Horizontal					
QP Detector					
107.600	-7.597	34.232	26.635	-16.865	43.500
379.200	1.301	36.768	38.069	-7.931	46.000
460.680	4.030	31.299	35.329	-10.671	46.000
542.160	3.925	31.592	35.517	-10.483	46.000
774.960	5.153	30.419	35.572	-10.428	46.000
854.500	7.380	29.598	36.978	-9.022	46.000
Vertical					
QP Detector					
107.600	-4.027	33.241	29.214	-14.286	43.500
352.040	-1.292	30.433	29.141	-16.859	46.000
542.160	1.855	37.473	39.328	-6.672	46.000
596.480	0.907	31.816	32.723	-13.277	46.000
827.340	2.711	35.760	38.471	-7.529	46.000
922.400	3.200	32.679	35.879	-10.121	46.000

Note:

1. All Readings below 1GHz are Quasi-Peak, above are average value.
2. “█” means the worst emission level.
3. Measurement Level = Reading Level + Correct Factor

4. Band Edge

4.1. Test Equipment

Test Site	Equipment	Manufacturer	Model No./Serial No.	Last Cal.
Site # 3	X Magnetic Loop Antenna	Teseq	HLA6121/ 37133	Sep, 2015
	X Bilog Antenna	Schaffner Chase	CBL6112B/ 2707	Jun, 2015
	X EMI Test Receiver	R&S	ESCS 30/838251/ 001	Jun, 2015
	X Coaxial Cable	QTK(Arnist)	RG 214/ LC003-RG	Jun, 2015
	X Coaxial signal switch	Arnist	MP59B/ 6200798682	Jun, 2015

- Note: 1. All equipments are calibrated with traceable calibrations. Each calibration is traceable to the national or international standards.
2. The test instruments marked with "X" are used to measure the final test results.

4.2. Test Setup

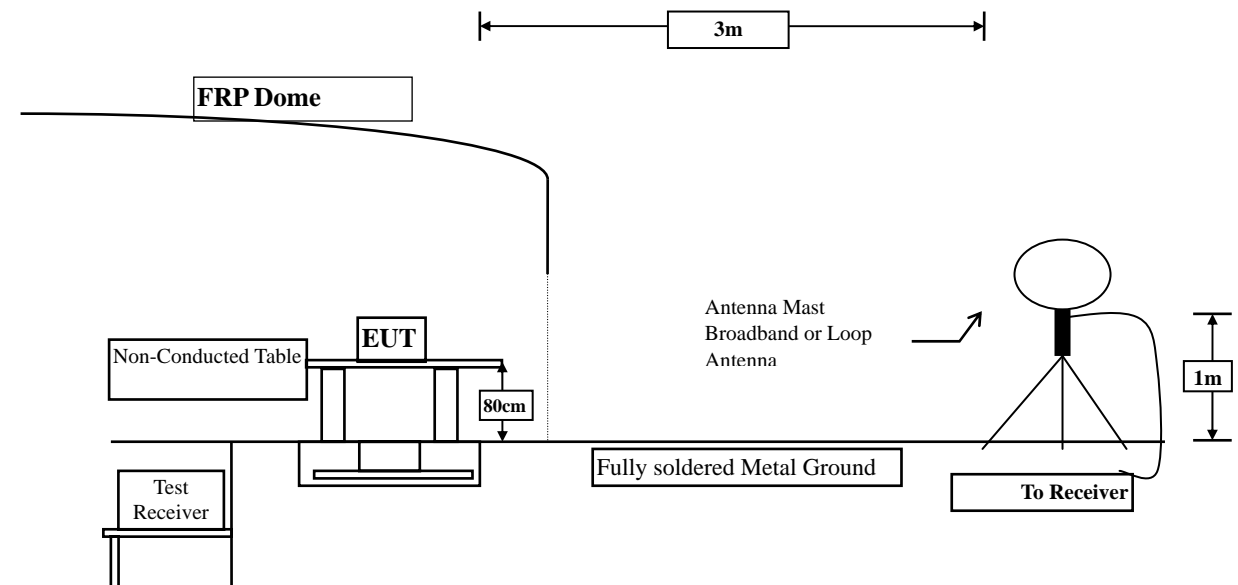

4.3. Limits

In any 9 kHz bandwidth outside the frequency band in which the spread spectrum intentional radiator is operating, the radio frequency power that is produced by the intentional radiator shall be at least 50 dB below that in the 9 kHz bandwidth within the band that contains the highest level of the desired power, based on either an RF conducted or a radiated measurement. Attenuation below the general limits specified in Section 15.209(a) is not required. In addition, radiated emissions which fall in the restricted bands, as defined in Section 15.205(a), must also comply with the radiated emission limits specified in Section 15.209(a) (see Section 15.205(c)).

4.4. Test Procedure

The EUT and its simulators are placed on a turn table which is 0.8 meter above ground. The turn table can rotate 360 degrees to determine the position of the maximum emission level. The EUT was positioned such that the distance from antenna to the EUT was 3 meters.

The antenna can move up and down between 1 meter and 4 meters to find out the maximum emission level.

Both horizontal and vertical polarization of the antenna are set on measurement. In order to find the maximum emission, all of the interface cables must be manipulated according to ANSI C63.10: 2013 on radiated measurement.

The bandwidth below 30MHz setting on the field strength meter is 9kHz and above 30MHz is 120kHz.

4.5. Uncertainty

Radiated is ± 2.6 dB

4.6. Test Result of Band Edge

Product : TABLET PC
 Test Item : Band Edge Data
 Test Site : No.3 OATS
 Test Mode : Mode 1: Transmit mode

RF Radiated Measurement

(Horizontal)

Frequency (MHz)	Correct Factor (dB)	Reading Level (dBuV)	Emission Level (dBuV/m)	QP Limit (dBuV/m)	Result
13.110	20.430	3.800	24.230	69.540	Pass
13.360	20.420	2.900	23.320	69.540	Pass
13.410	20.420	1.700	22.120	69.540	Pass
14.010	20.400	3.300	23.700	69.540	Pass

Note:

1. All Readings below 1GHz are Quasi-Peak, above are average value.
2. "■" means the worst emission level.
3. Measurement Level = Reading Level + Correct Factor

(Vertical)

Frequency (MHz)	Correct Factor (dB)	Reading Level (dBuV)	Emission Level (dBuV/m)	QP Limit (dBuV/m)	Result
13.110	20.430	14.400	34.830	69.540	Pass
13.360	20.420	13.400	33.820	69.540	Pass
13.410	20.420	12.100	32.520	69.540	Pass
14.010	20.400	15.000	35.400	69.540	Pass

Note:

1. All Readings below 1GHz are Quasi-Peak, above are average value.
2. "■" means the worst emission level.
3. Measurement Level = Reading Level + Correct Factor

5. Frequency Tolerance

5.1. Test Equipment

	Equipment	Manufacturer	Model No./Serial No.	Last Cal.
	Spectrum Analyzer	R&S	FSP40 / 100170	Jun, 2015
	Spectrum Analyzer	Agilent	E4407B / US39440758	Jun, 2015
X	Spectrum Analyzer	Agilent	N9010A / MY48030495	Apr., 2015
X	Temperature Chamber	TDE	CHM 150CT	March, 2016

Note: All equipments are calibrated every one year.

5.2. Test Setup

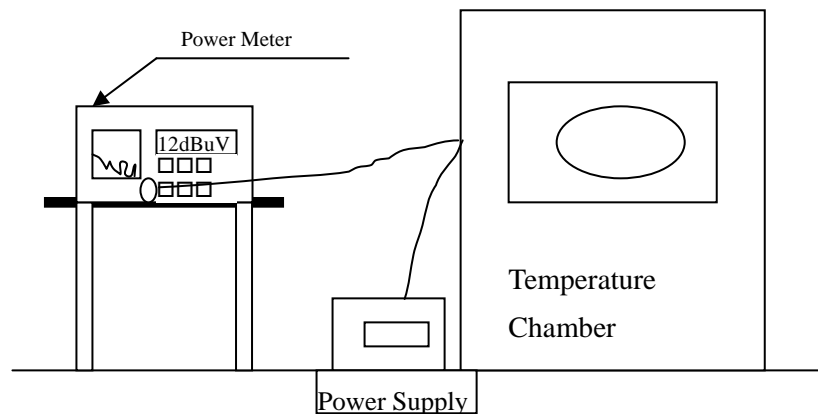

5.3. Limits

The frequency tolerance of the carrier signal shall be maintained within $\pm 0.01\%$ of the operating frequency.

5.4. Test Procedure

The over operating frequency over a temperature variation of -20 degrees to +50 degrees C at normal supply voltage, and for a variation in the primary supply voltage from 85% to 115% of the rated supply voltage at a temperature of 20 degrees C. For battery operated equipment, the equipment tests shall be performed using a new battery.

5.5. Uncertainty

± 150 Hz

5.6. Test Result of Frequency Stability

Product : TABLET PC
 Test Item : Frequency Tolerance
 Test Site : Temperature Chamber
 Test Mode : Mode 1: Transmit mode

Temperature (°C)	Voltage (V)	Observe Time	Declared Frequency (MHz)	Read Frequency (MHz)	Tolerance (%)	Limit (%)
20	120	start	13.56	13.56019	0.001401	± 0.01 %
		2mins	13.56	13.56019	0.001401	
		5mins	13.56	13.56019	0.001401	
		10mins	13.56	13.56019	0.001401	
20	138	start	13.56	13.56019	0.001401	± 0.01 %
		2mins	13.56	13.56019	0.001401	
		5mins	13.56	13.56019	0.001401	
		10mins	13.56	13.56019	0.001401	
20	102	start	13.56	13.56019	0.001401	± 0.01 %
		2mins	13.56	13.56019	0.001401	
		5mins	13.56	13.56019	0.001401	
		10mins	13.56	13.56019	0.001401	
50	120	start	13.56	13.56013	0.000959	± 0.01 %
		2mins	13.56	13.56013	0.000959	
		5mins	13.56	13.56013	0.000959	
		10mins	13.56	13.56013	0.000959	
40	120	start	13.56	13.56015	0.001106	± 0.01 %
		2mins	13.56	13.56015	0.001106	
		5mins	13.56	13.56015	0.001106	
		10mins	13.56	13.56015	0.001106	
30	120	start	13.56	13.56017	0.001254	± 0.01 %
		2mins	13.56	13.56017	0.001254	
		5mins	13.56	13.56017	0.001254	
		10mins	13.56	13.56017	0.001254	

10	120	start	13.56	13.55998	-0.000147	± 0.01 %
		2mins	13.56	13.55998	-0.000147	
		5mins	13.56	13.55998	-0.000147	
		10mins	13.56	13.55998	-0.000147	
0	120	start	13.56	13.55989	-0.000811	± 0.01 %
		2mins	13.56	13.55989	-0.000811	
		5mins	13.56	13.55989	-0.000811	
		10mins	13.56	13.55989	-0.000811	
-10	120	start	13.56	13.55997	-0.000221	± 0.01 %
		2mins	13.56	13.55997	-0.000221	
		5mins	13.56	13.55997	-0.000221	
		10mins	13.56	13.55997	-0.000221	
-20	120	start	13.56	13.55986	-0.001032	± 0.01 %
		2mins	13.56	13.55986	-0.001032	
		5mins	13.56	13.55986	-0.001032	
		10mins	13.56	13.55986	-0.001032	

6. EMI Reduction Method During Compliance Testing

No modification was made during testing.