

# FCC Test Report

Product Name	TABLET PC
Model No.	PM-521
FCC ID.	2ABTU-PM-521

Applicant	RuggON Corporation
Address	3F., No.10, Ln. 181, Sec. 2, Jiuzong Rd., Neihu Dist., Taipei City, Taiwan

Date of Receipt	Jan. 06, 2015
Issued Date	Feb. 16, 2015
Report No.	1510151R-RFUSP23V00-A
Report Version	V1.0



The test results relate only to the samples tested.

The test results shown in the test report are traceable to the national/international standard through the calibration report of the equipment and evaluated measurement uncertainty herein.

This report must not be used to claim product endorsement by TAF or any agency of the government.

The test report shall not be reproduced without the written approval of QuieTek Corporation.

# Test Report

Issued Date: Feb. 16, 2015

Report No.: 1510151R-RFUSP23V00-A



Product Name	TABLET PC
Applicant	RuggON Corporation
Address	3F., No.10, Ln. 181, Sec. 2, Jiuzong Rd., Neihu Dist., Taipei City, Taiwan
Manufacturer	Ubiquconn Technology, Inc.
Model No.	PM-521
FCC ID.	2ABTU-PM-521
EUT Rated Voltage	AC 100-240V, 50-60Hz
EUT Test Voltage	AC 120V/60Hz
Trade Name	RuggON
Applicable Standard	FCC CFR Title 47 Part 15 Subpart C: 2014 ANSI C63.4: 2014, ANSI C63.10: 2009 KDB 558074 D01 DTS Meas Guidance v03r02
Test Result	Complied

Documented By :

( Senior Adm. Specialist / Joanne Lin )

Tested By :

( Engineer / Eason Chen )

Approved By :

( Director / Vincent Lin )

**TABLE OF CONTENTS**

Description	Page
<b>1. GENERAL INFORMATION .....</b>	<b>4</b>
1.1. EUT Description.....	4
1.2. Operational Description.....	6
1.3. Tested System Details.....	7
1.4. Configuration of Tested System .....	7
1.5. EUT Exercise Software .....	8
1.6. Test Facility .....	9
<b>2. CONDUCTED EMISSION .....</b>	<b>10</b>
2.1. Test Equipment .....	10
2.2. Test Setup .....	10
2.3. Limits.....	11
2.4. Test Procedure .....	11
2.5. Uncertainty .....	11
2.6. Test Result of Conducted Emission.....	12
<b>3. PEAK POWER OUTPUT .....</b>	<b>14</b>
3.1. Test Equipment .....	14
3.2. Test Setup .....	14
3.3. Limit .....	14
3.4. Test Procedure .....	14
3.5. Uncertainty .....	14
3.6. Test Result of Peak Power Output .....	15
<b>4. RADIATED EMISSION .....</b>	<b>16</b>
4.1. Test Equipment .....	16
4.2. Test Setup .....	17
4.3. Limits.....	18
4.4. Test Procedure .....	19
4.5. Uncertainty .....	19
4.6. Test Result of Radiated Emission.....	20
<b>5. RF ANTENNA CONDUCTED TEST .....</b>	<b>24</b>
5.1. Test Equipment .....	24
5.2. Test Setup .....	24
5.3. Limits.....	24
5.4. Test Procedure .....	24
5.5. Uncertainty .....	24
5.6. Test Result of RF Antenna Conducted Test .....	25
<b>6. BAND EDGE .....</b>	<b>26</b>
6.1. Test Equipment .....	26
6.2. Test Setup .....	27
6.3. Limit .....	28
6.4. Test Procedure .....	28
6.5. Uncertainty .....	28
6.6. Test Result of Band Edge .....	29
<b>7. OCCUPIED BANDWIDTH (6DB BW).....</b>	<b>33</b>
7.1. Test Equipment .....	33
7.2. Test Setup .....	33
7.3. Limits.....	33
7.4. Test Procedure .....	33
7.5. Uncertainty .....	33
7.6. Test Result of Occupied Bandwidth .....	34
<b>8. POWER DENSITY .....</b>	<b>36</b>
8.1. Test Equipment .....	36
8.2. Test Setup .....	36
8.3. Limits.....	36
8.4. Test Procedure .....	36
8.5. Uncertainty .....	36
8.6. Test Result of Power Density .....	37
<b>9. EMI REDUCTION METHOD DURING COMPLIANCE TESTING .....</b>	<b>39</b>
Attachment 1: EUT Test Photographs	
Attachment 2: EUT Detailed Photographs	

**1. GENERAL INFORMATION**

**1.1. EUT Description**

Product Name	TABLET PC
Trade Name	RuggON
Model No.	PM-521
FCC ID.	2ABTU-PM-521
Frequency Range	2402 – 2480MHz
Channel Number	V4.0: 40CH
Type of Modulation	V4.0: GFSK(1Mbps)
Antenna Type	PIFA Antenna
Channel Control	Auto
Antenna Gain	Refer to the table “Antenna List”
Power Adapter	MFR: FSP, M/N: FSP065-REB Input: AC 100-240V~1.5A, 50-60Hz Output: 19V $\overline{=}$ 3.42A Cable Out: Shielded, 1.5m, with one ferrite core bonded.
Contain Module	Intel / 7260HMW

**Antenna List**

No.	Manufacturer	Part No.	Antenna Type	Peak Gain
1	ethertronics	5001791 (Main) 5001799 (Aux)	PIFA Antenna	3.8dBi for 2.4GHz

Note: The antenna of EUT is conforming to FCC 15.203.

Center Frequency of Each Channel: (For V4.0)

Channel	Frequency	Channel	Frequency	Channel	Frequency	Channel	Frequency
Channel 00:	2402 MHz	Channel 01:	2404 MHz	Channel 02:	2406 MHz	Channel 03:	2408 MHz
Channel 04:	2410 MHz	Channel 05:	2412 MHz	Channel 06:	2414 MHz	Channel 07:	2416 MHz
Channel 08:	2418 MHz	Channel 09:	2420 MHz	Channel 10:	2422 MHz	Channel 11:	2424 MHz
Channel 12:	2426 MHz	Channel 13:	2428 MHz	Channel 14:	2430 MHz	Channel 15:	2432 MHz
Channel 16:	2434 MHz	Channel 17:	2436 MHz	Channel 18:	2438 MHz	Channel 19:	2440 MHz
Channel 20:	2442 MHz	Channel 21:	2444 MHz	Channel 22:	2446 MHz	Channel 23:	2448 MHz
Channel 24:	2450 MHz	Channel 25:	2452 MHz	Channel 26:	2454 MHz	Channel 27:	2456 MHz
Channel 28:	2458 MHz	Channel 29:	2460 MHz	Channel 30:	2462 MHz	Channel 31:	2464 MHz
Channel 32:	2466 MHz	Channel 33:	2468 MHz	Channel 34:	2470 MHz	Channel 35:	2472 MHz
Channel 36:	2474 MHz	Channel 37:	2476 MHz	Channel 38:	2478 MHz	Channel 39:	2480 MHz

Note:

1. The EUT is a TABLET PC with a built-in WiFi 、Bluetooth 、GPS transceiver, this report for Bluetooth V4.0.
2. These tests were conducted on a sample for the purpose of demonstrating compliance of Bluetooth transmitter with Part 15 Subpart C Paragraph 15.247 for spread spectrum devices.
3. Regarding to the operation frequency, the lowest, middle and highest frequency are selected to perform the test.
4. The radiation measurements are performed in X, Y, Z axis positioning. Only the worst case is shown in the report.

Test Mode	Mode 1: Transmit - BLE (GFSK)
-----------	-------------------------------

**1.3. Tested System Details**

The types for all equipment, plus descriptions of all cables used in the tested system (including inserted cards) are:

Product	Manufacturer	Model No.	Serial No.	Power Cord
1 Monitor	DELL	ST2320L	N/A	Non-Shielded, 1.8m
2 Earphone	AIWA	N/A	N/A	N/A
3 IPod nano	Apple	A1199	YM708A72VQ5	N/A
4 Modem	ACEEX	DM-1414	0102027553	N/A
5 USB Dongle	Transcend	JF V30	N/A	Non-Shielded, 1.8m

Signal Cable Type	Signal cable Description
A HDMI Cable	Shielded, 1.8m
B Earphone Cable	Shielded, 1.8m
C IPod Cable	Shielded, 1.2m
D RS-232 Cable	Shielded, 1.8m
E RJ45 Cable	Shielded, 2.0m

**1.4. Configuration of Tested System**

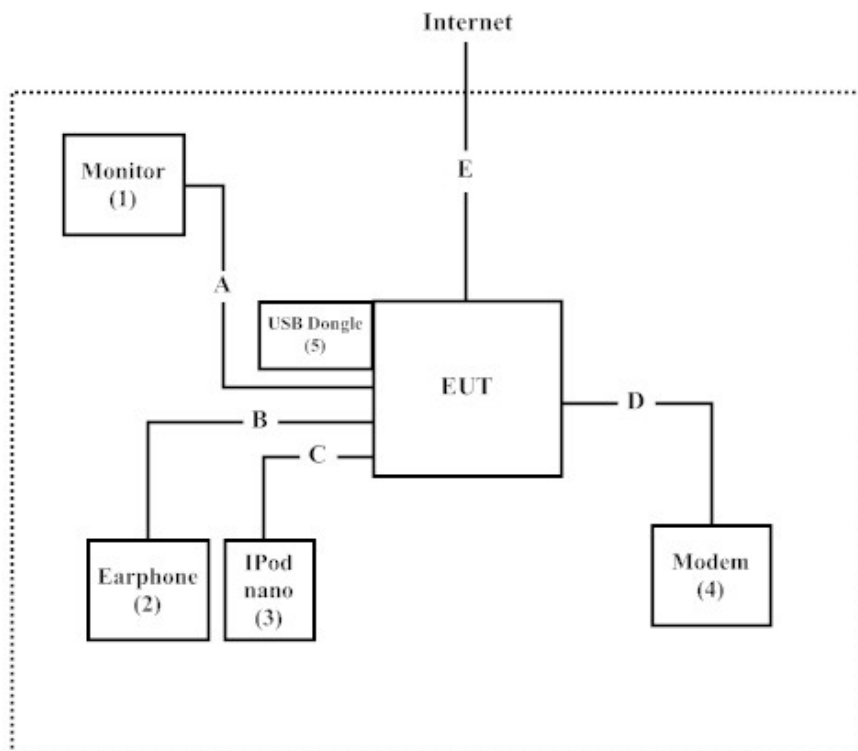

**1.5. EUT Exercise Software**

1. Setup the EUT as shown in Section 1.4.
2. Execute software “DRTU-v1.7.3.859” on the EUT
3. Configure the test mode, the test channel, and the data rate.
4. Press “OK” to start the continuous Transmit.
5. Verify that the EUT works properly.

**1.6. Test Facility**

Ambient conditions in the laboratory:

Items	Required (IEC 68-1)	Actual
Temperature (°C)	15-35	20-35
Humidity (%RH)	25-75	30-65
Barometric pressure (mbar)	860-1060	950-1000

The related certificate for our laboratories about the test site and management system can be downloaded from

QuieTek Corporation's Web Site: <http://www.quietek.com/tw/ctg/cts/accreditations.htm>

The address and introduction of Quietek Corporation's laboratories can be founded in our Web site: <http://www.quietek.com/>

Site Description: File on  
 Federal Communications Commission  
 FCC Engineering Laboratory  
 7435 Oakland Mills Road  
 Columbia, MD 21046  
 Registration Number: 92195

Site Name: Quietek Corporation  
 Site Address: No.5-22, Ruishukeng,  
 Linkou Dist. New Taipei City 24451,  
 Taiwan, R.O.C.  
 TEL: 886-2-8601-3788 / FAX : 886-2-8601-3789  
 E-Mail : [service@quietek.com](mailto:service@quietek.com)

FCC Accreditation Number: TW1014



**2. Conducted Emission**

**2.1. Test Equipment**

	Equipment	Manufacturer	Model No. / Serial No.	Last Cal.	Remark
X	Test Receiver	R & S	ESCS 30 / 825442/018	Sep., 2014	
X	Artificial Mains Network	R & S	ENV4200 / 848411/10	Feb., 2015	Peripherals
X	LISN	R & S	ESH3-Z5 / 825562/002	Feb., 2015	EUT
	DC LISN	Schwarzbeck	8226 / 176	Mar., 2014	EUT
X	Pulse Limiter	R & S	ESH3-Z2 / 357.8810.52	Feb., 2015	
	No.1 Shielded Room				

Note:

1. All equipments are calibrated every one year.
2. The test instruments marked by “X” are used to measure the final test results.

**2.2. Test Setup**

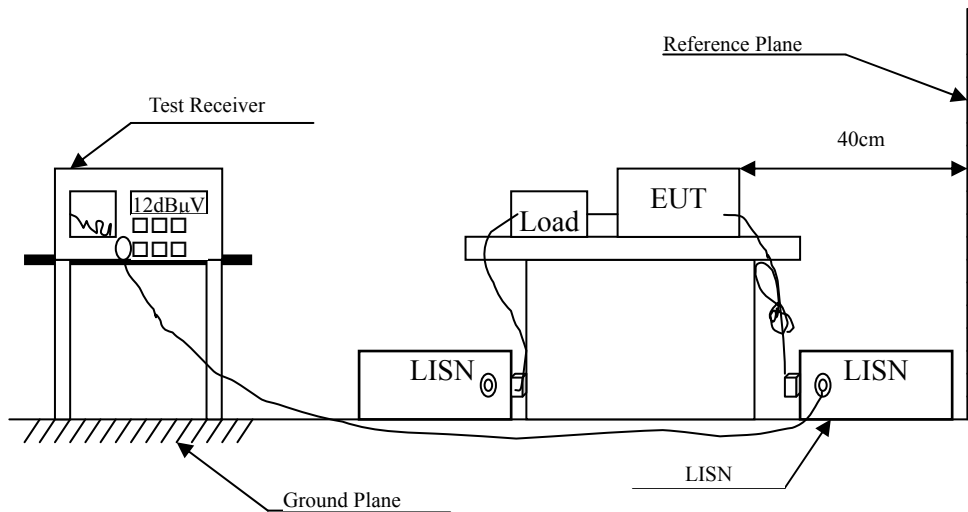

**2.3. Limits**

<b>FCC Part 15 Subpart C Paragraph 15.207 (dBµV) Limit</b>		
Frequency MHz	Limits	
	QP	AV
0.15 - 0.50	66-56	56-46
0.50-5.0	56	46
5.0 - 30	60	50

Remarks: In the above table, the tighter limit applies at the band edges.

**2.4. Test Procedure**

The EUT and Peripherals are connected to the main power through a line impedance stabilization network (L.I.S.N.). This provides a 50 ohm /50uH coupling impedance for the measuring equipment. The peripheral devices are also connected to the main power through a LISN that provides a 50ohm /50uH coupling impedance with 50ohm termination. (Please refer to the block diagram of the test setup and photographs.)

Both sides of A.C. line are checked for maximum conducted interference. In order to find the maximum emission, the relative positions of equipment and all the interface cables must be changed according to ANSI C63.10: 2009 on conducted measurement.

Conducted emissions were investigated over the frequency range from 0.15MHz to 30MHz using a receiver bandwidth of 9kHz.

The EUT was setup to ANSI C63.10, 2009; tested to FHSS test procedure of FCC Public Notice DA 00-705 for compliance to FCC 47CFR 15.247 requirements.

**2.5. Uncertainty**

± 2.26 dB

**2.6. Test Result of Conducted Emission**

Product : TABLET PC  
 Test Item : Conducted Emission Test  
 Power Line : Line 1  
 Test Mode : Mode 1: Transmit - BLE (GFSK) (2440MHz)

Frequency MHz	Correct Factor dB	Reading Level dBμV	Measurement Level dBμV	Margin dB	Limit dBμV
<b>LINE 1</b>					
<b>Quasi-Peak</b>					
0.197	9.650	38.050	47.700	-16.957	64.657
0.291	9.655	25.430	35.085	-26.886	61.971
0.416	9.662	20.210	29.872	-28.528	58.400
0.486	9.666	25.210	34.876	-21.524	56.400
0.658	9.675	33.260	42.935	-13.065	56.000
1.341	9.723	26.820	36.543	-19.457	56.000
<b>Average</b>					
0.197	9.650	28.730	38.380	-16.277	54.657
0.291	9.655	13.050	22.705	-29.266	51.971
0.416	9.662	10.010	19.672	-28.728	48.400
0.486	9.666	15.450	25.116	-21.284	46.400
0.658	9.675	26.200	35.875	-10.125	46.000
1.341	9.723	16.090	25.813	-20.187	46.000

Note:

1. All Reading Levels are Quasi-Peak and average value.
2. "█" means the worst emission level.
3. Measurement Level = Reading Level + Correct Factor

Product : TABLET PC  
 Test Item : Conducted Emission Test  
 Power Line : Line 2  
 Test Mode : Mode 1: Transmit - BLE (GFSK) (2440MHz)

Frequency MHz	Correct Factor dB	Reading Level dBμV	Measurement Level dBμV	Margin dB	Limit dBμV
<b>LINE 2</b>					
<b>Quasi-Peak</b>					
0.205	9.661	34.960	44.621	-19.808	64.429
0.283	9.664	24.510	34.174	-28.026	62.200
0.380	9.660	22.540	32.200	-27.229	59.429
0.502	9.667	26.390	36.057	-19.943	56.000
0.650	9.675	34.010	43.685	-12.315	56.000
1.384	9.725	27.120	36.845	-19.155	56.000
<b>Average</b>					
0.205	9.661	26.980	36.641	-17.788	54.429
0.283	9.664	15.600	25.264	-26.936	52.200
0.380	9.660	13.430	23.090	-26.339	49.429
0.502	9.667	17.660	27.327	-18.673	46.000
0.650	9.675	24.770	34.445	-11.555	46.000
1.384	9.725	14.500	24.225	-21.775	46.000

Note:

1. All Reading Levels are Quasi-Peak and average value.
2. "■" means the worst emission level.
3. Measurement Level = Reading Level + Correct Factor

**3. Peak Power Output**

**3.1. Test Equipment**

	Equipment	Manufacturer	Model No./Serial No.	Last Cal.
X	Power Meter	Anritsu	ML2495A/6K00003357	May, 2014
X	Power Sensor	Anritsu	MA2411B/0738448	Jun., 2014

Note: 1. All equipments are calibrated every one year.  
 2. The test instruments marked by “X” are used to measure the final test results.

**3.2. Test Setup**

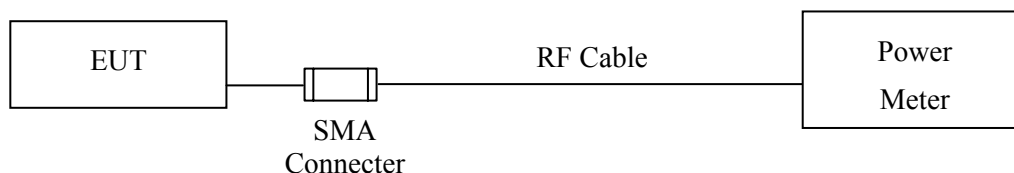

**3.3. Limit**

The maximum peak power shall be less 1Watt.

**3.4. Test Procedure**

Tested according to DTS test procedure of KDB 558074 for compliance to FCC 47CFR 15.247 requirements. The maximum peak conducted output power using KDB 558074 section 9.1.2 PKPM1 Peak power meter method.

**3.5. Uncertainty**

± 1.27 dB

**3.6. Test Result of Peak Power Output**

Product : TABLET PC  
Test Item : Peak Power Output  
Test Site : No.3 OATS  
Test Mode : Mode 1: Transmit - BLE (GFSK)

Channel No.	Frequency (MHz)	Measurement (dBm)	Required Limit	Result
Channel 00	2402.00	8.69	1 Watt= 30 dBm	Pass
Channel 19	2440.00	8.84	1 Watt= 30 dBm	Pass
Channel 39	2480.00	8.82	1 Watt= 30 dBm	Pass

**4. Radiated Emission**

**4.1. Test Equipment**

The following test equipments are used during the radiated emission test:

Test Site		Equipment	Manufacturer	Model No./Serial No.	Last Cal.
☒ Site # 3	X	Loop Antenna	Teseq	HLA6120 / 26739	Jul., 2014
	X	Bilog Antenna	Schaffner Chase	CBL6112B/2673	Sep., 2014
	X	Horn Antenna	Schwarzbeck	BBHA9120D/D305	Sep., 2014
	X	Horn Antenna	Schwarzbeck	BBHA9170/208	Jul., 2014
	X	Pre-Amplifier	Agilent	8447D/2944A09549	Sep., 2014
	X	Spectrum Analyzer	Agilent	E4407B / US39440758	May, 2014
	X	Test Receiver	R & S	ESCS 30/ 825442/018	Sep., 2014
	X	Coaxial Cable	QuieTek	QTK-CABLE/ CAB5	Feb., 2015
	X	Controller	QuieTek	QTK-CONTROLLER/ CTRL3	N/A
X	Coaxial Switch	Anritsu	MP59B/6200265729	N/A	

Test Site		Equipment	Manufacturer	Model No./Serial No.	Last Cal.
☒ CB # 8	X	Spectrum Analyzer	R&S	FSP40/ 100339	Oct, 2014
	X	Horn Antenna	ETS-Lindgren	3117/ 35205	Mar, 2014
	X	Horn Antenna	Schwarzbeck	BBHA9170/209	Jan, 2015
	X	Horn Antenna	TRC	AH-0801/95051	Aug, 2014
	X	Pre-Amplifier	EMCI	EMC012630SE/980210	Jan, 2015
	X	Pre-Amplifier	MITEQ	JS41-001040000-58-5P/153945	Jul, 2014
	X	Pre-Amplifier	NARDA	DBL-1840N506/013	Jul, 2014

- Note:
1. All equipments are calibrated with traceable calibrations. Each calibration is traceable to the national or international standards.
  2. The test instruments marked with “X” are used to measure the final test results.

4.2. Test Setup

Below 1GHz

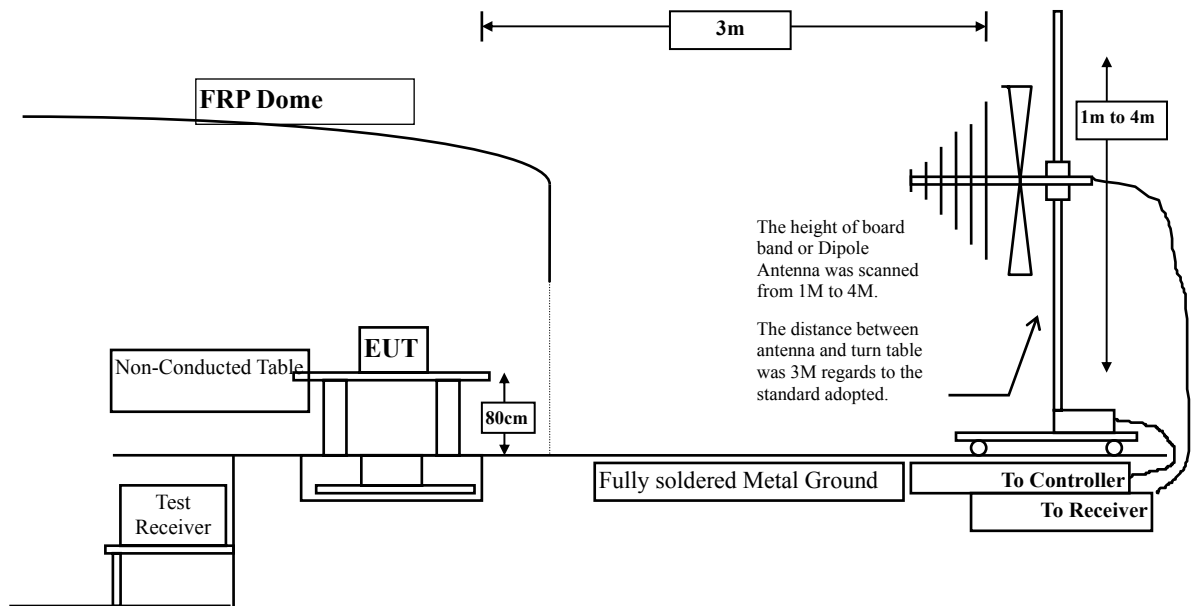

Above 1GHz

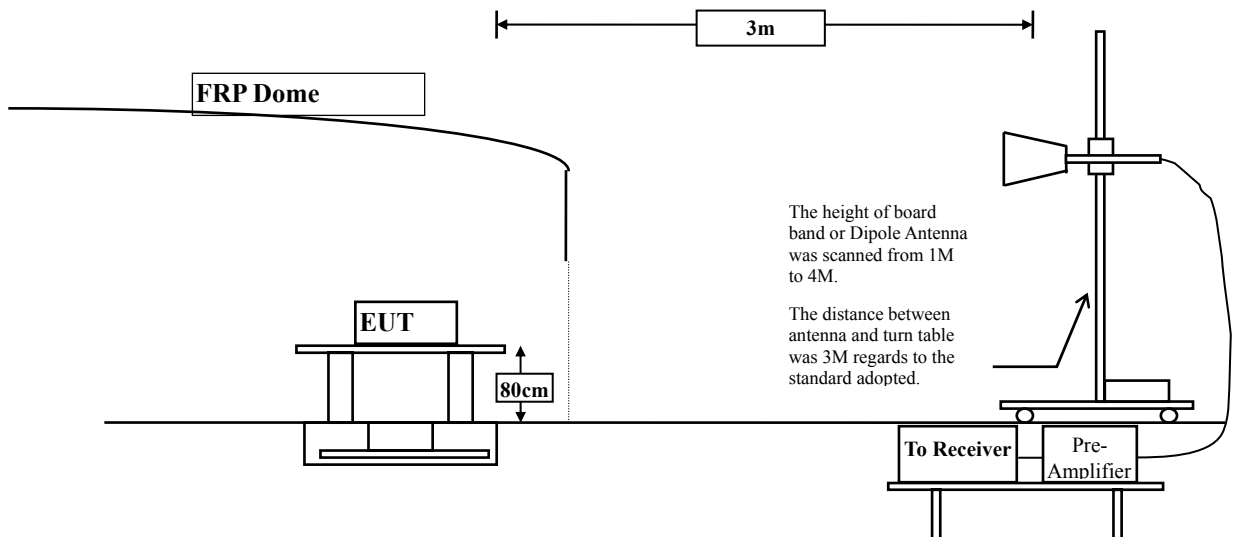



**4.3. Limits**

➤ **General Radiated Emission Limits**

Emissions radiated outside of the specified frequency bands, except for harmonics, shall be attenuated by at least 20dB below the level of the fundamental or to the general radiated emission limits in paragraph 15.209, whichever is the lesser attenuation.

<b>FCC Part 15 Subpart C Paragraph 15.209 Limits</b>		
Frequency MHz	Field strength (microvolts/meter)	Measurement distance (meter)
0.009-0.490	2400/F(kHz)	300
0.490-1.705	24000/F(kHz)	30
1.705-30	30	30
30-88	100	3
88-216	150	3
216-960	200	3
Above 960	500	3

- Remarks:
1. RF Voltage (dBμV) = 20 log RF Voltage (uV)
  2. In the Above Table, the tighter limit applies at the band edges.
  3. Distance refers to the distance in meters between the measuring instrument antenna and the closed point of any part of the device or system.

#### **4.4. Test Procedure**

The EUT was setup according to ANSI C63.10, 2009 and tested according to FHSS test procedure of FCC Public Notice DA 00-705 for compliance to FCC 47CFR 15.247 requirements.

The EUT is placed on a turn table which is 0.8 meter above ground. The turn table is rotated 360 degrees to determine the position of the maximum emission level. The EUT was positioned such that the distance from antenna to the EUT was 3 meters.

The antenna is scanned from 1 meter to 4 meters to find out the maximum emission level. This is repeated for both horizontal and vertical polarization of the antenna. In order to find the maximum emission, all of the interface cables were manipulated according to ANSI C63.10:2009 on radiated measurement.

The resolution bandwidth below 30MHz setting on the field strength meter is 9kHz and 30MHz~1GHz is 120kHz and above 1GHz is 1MHz.

Radiated emission measurements below 30MHz are made using Loop Antenna and 30MHz~1GHz are made using broadband Bilog antenna and above 1GHz are made using Horn Antennas.

The measurement is divided into the Preliminary Measurement and the Final Measurement.

The suspected frequencies are searched for in Preliminary Measurement with the measurement antenna kept pointed at the source of the emission both in azimuth and elevation, with the polarization of the antenna oriented for maximum response. The antenna is pointed at an angle towards the source of the emission, and the EUT is rotated in both height and polarization to maximize the measured emission. The emission is kept within the illumination area of the 3 dB bandwidth of the antenna.

The worst radiated emission is measured on the Final Measurement.

The measurement frequency range form 9kHz - 10th Harmonic of fundamental was investigated.

#### **4.5. Uncertainty**

± 3.9 dB above 1GHz

± 3.8 dB below 1GHz

**4.6. Test Result of Radiated Emission**

Product : TABLET PC  
 Test Item : Harmonic Radiated Emission  
 Test Site : No.3 OATS  
 Test Mode : Mode 1: Transmit - BLE (GFSK)(2402MHz)

Frequency MHz	Correct Factor dB	Reading Level dBμV	Measurement Level dBμV/m	Margin dB	Limit dBμV/m
<b>Horizontal</b>					
<b>Peak Detector:</b>					
4804.000	2.511	56.190	58.700	-15.300	74.000
7206.000	9.511	40.300	49.811	-24.189	74.000
9608.000	10.394	39.540	49.934	-24.066	74.000
<b>Average Detector:</b>					
4804.000	2.511	43.420	45.930	-8.070	54.000
<b>Vertical</b>					
<b>Peak Detector:</b>					
4804.000	2.923	56.610	59.532	-14.468	74.000
7206.000	9.988	40.180	50.169	-23.831	74.000
9608.000	10.847	39.740	50.587	-23.413	74.000
<b>Average Detector:</b>					
4804.000	2.923	43.790	46.712	-7.288	54.000

Note:

1. All Readings below 1GHz are Quasi-Peak, above 1GHz are performed with peak and/or average measurements as necessary.
2. Peak measurements: RBW = 1MHz, VBW = 3 MHz, Sweep: Auto.
3. Average measurements: RBW = 1MHz, VBW = 10 Hz, Sweep: Auto.
4. Measurement Level = Reading Level + Correct Factor.
5. Correct Factor = Antenna factor + Cable loss – Amplifier gain.
6. The average measurement was not performed when the peak measured data under the limit of average detection.
7. The emission levels of other frequencies are very lower than the limit and not show in test report.

Product : TABLET PC  
 Test Item : Harmonic Radiated Emission  
 Test Site : No.3 OATS  
 Test Mode : Mode 1: Transmit - BLE (GFSK) (2440MHz)

Frequency MHz	Correct Factor dB	Reading Level dB $\mu$ V	Measurement Level dB $\mu$ V/m	Margin dB	Limit dB $\mu$ V/m
<b>Horizontal</b>					
<b>Peak Detector:</b>					
4880.000	2.038	56.660	58.698	-15.302	74.000
7320.000	9.699	42.850	52.549	-21.451	74.000
9760.000	9.665	39.410	49.075	-24.925	74.000
<b>Average Detector:</b>					
4880.000	2.038	44.150	46.188	-7.812	54.000
<b>Vertical</b>					
<b>Peak Detector:</b>					
4880.000	2.499	56.510	59.009	-14.991	74.000
7320.000	10.303	42.190	52.493	-21.507	74.000
9760.000	10.299	39.530	49.830	-24.170	74.000
<b>Average Detector:</b>					
4880.000	2.499	43.740	46.239	-7.761	54.000

Note:

1. All Readings below 1GHz are Quasi-Peak, above 1GHz are performed with peak and/or average measurements as necessary.
2. Peak measurements: RBW = 1MHz, VBW = 3 MHz, Sweep: Auto.
3. Average measurements: RBW = 1MHz, VBW = 10 Hz, Sweep: Auto.
4. Measurement Level = Reading Level + Correct Factor.
5. Correct Factor = Antenna factor + Cable loss – Amplifier gain.
6. The average measurement was not performed when the peak measured data under the limit of average detection.
7. The emission levels of other frequencies are very lower than the limit and not show in test report.

Product : TABLET PC  
 Test Item : Harmonic Radiated Emission  
 Test Site : No.3 OATS  
 Test Mode : Mode 1: Transmit - BLE (GFSK) (2480MHz)

Frequency MHz	Correct Factor dB	Reading Level dB $\mu$ V	Measurement Level dB $\mu$ V/m	Margin dB	Limit dB $\mu$ V/m
<b>Horizontal</b>					
<b>Peak Detector:</b>					
4960.000	2.582	54.670	57.252	-16.748	74.000
7440.000	10.555	42.440	52.995	-21.005	74.000
9920.000	10.206	38.690	48.896	-25.104	74.000
<b>Average Detector:</b>					
4960.000	2.582	42.410	44.992	-9.008	54.000
<b>Vertical</b>					
<b>Peak Detector:</b>					
4960.000	3.398	55.550	58.949	-15.051	74.000
7440.000	11.214	42.520	53.734	-20.266	74.000
9920.000	11.245	39.450	50.695	-23.305	74.000
<b>Average Detector:</b>					
4960.000	3.398	42.890	46.289	-7.711	54.000

Note:

1. All Readings below 1GHz are Quasi-Peak, above 1GHz are performed with peak and/or average measurements as necessary.
2. Peak measurements: RBW = 1MHz, VBW = 3 MHz, Sweep: Auto.
3. Average measurements: RBW = 1MHz, VBW = 10 Hz, Sweep: Auto.
4. Measurement Level = Reading Level + Correct Factor.
5. Correct Factor = Antenna factor + Cable loss – Amplifier gain.
6. The average measurement was not performed when the peak measured data under the limit of average detection.
7. The emission levels of other frequencies are very lower than the limit and not show in test report.

Product : TABLET PC  
 Test Item : General Radiated Emission  
 Test Site : No.3 OATS  
 Test Mode : Mode 1: Transmit - BLE (GFSK) (2440MHz)

Frequency MHz	Correct Factor dB	Reading Level dB $\mu$ V	Measurement Level dB $\mu$ V/m	Margin dB	Limit dB $\mu$ V/m
<b>Horizontal</b>					
39.700	-3.625	31.508	27.883	-12.117	40.000
192.960	-10.095	47.916	37.821	-5.679	43.500
386.960	1.112	32.084	33.196	-12.804	46.000
608.120	3.925	30.133	34.058	-11.942	46.000
792.420	6.391	23.124	29.515	-16.485	46.000
928.220	7.230	22.927	30.157	-15.843	46.000
<b>Vertical</b>					
47.460	-11.425	41.416	29.991	-10.009	40.000
181.320	-1.910	31.085	29.175	-14.325	43.500
326.820	-2.759	38.462	35.703	-10.297	46.000
610.060	2.087	26.493	28.580	-17.420	46.000
804.060	3.371	23.742	27.113	-18.887	46.000
937.920	3.110	31.836	34.946	-11.054	46.000

Note:

1. All Readings below 1GHz are Quasi-Peak, above 1GHz are performed with peak and/or average measurements as necessary.
2. Peak measurements: RBW = 1MHz, VBW = 3 MHz, Sweep: Auto.
3. Average measurements: RBW = 1MHz, VBW = 10 Hz, Sweep: Auto.
4. Measurement Level = Reading Level + Correct Factor.
5. Correct Factor = Antenna factor + Cable loss – Amplifier gain.
6. The average measurement was not performed when the peak measured data under the limit of average detection.
7. The emission levels of other frequencies are very lower than the limit and not show in test report.
8. No emission found between lowest internal used/generated frequency to 30MHz.

**5. RF Antenna Conducted Test**

**5.1. Test Equipment**

Equipment	Manufacturer	Model No./Serial No.	Last Cal.
Spectrum Analyzer	R&S	FSP40 / 100170	Jun., 2014
Spectrum Analyzer	Agilent	E4407B / US39440758	Jun., 2014
X Spectrum Analyzer	Agilent	N9010A / MY48030495	Apr., 2014

Note: 1. All equipments are calibrated every one year.  
 2. The test instruments Marked “X” are used to measure the final test results.

**5.2. Test Setup**

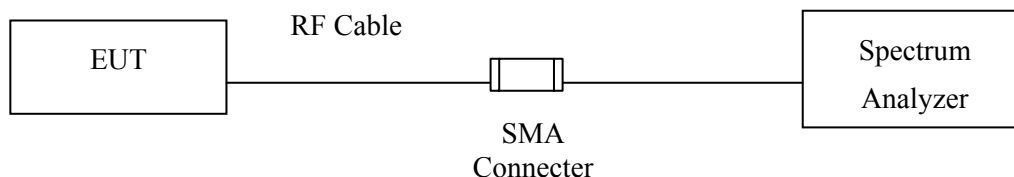

**5.3. Limits**

According to FCC Section 15.247(d). In any 100 kHz bandwidth outside the frequency band in which the spread spectrum or digitally modulated intentional radiator is operating, the radio frequency power that is produced by the intentional radiator shall be at least 20 dB below that in the 100 kHz bandwidth within the band that contains the highest level of the desired power, based on either an RF conducted or measurement, provided the transmitter demonstrates compliance with the peak conducted power limits. If the transmitter complies with the conducted power limits based on the use of RMS averaging over a time interval, the attenuation required under this paragraph shall be 30 dB instead of 20 dB.

**5.4. Test Procedure**

The EUT was tested according to DTS test procedure of KDB558074 for compliance to FCC 47CFR 15.247 requirements.

**5.5. Uncertainty**

± 150Hz

5.6. Test Result of RF Antenna Conducted Test

Product : TABLET PC  
Test Item : RF Antenna Conducted Test  
Test Site : No.3 OATS  
Test Mode : Mode 1: Transmit - BLE (GFSK)

Figure Channel 00:

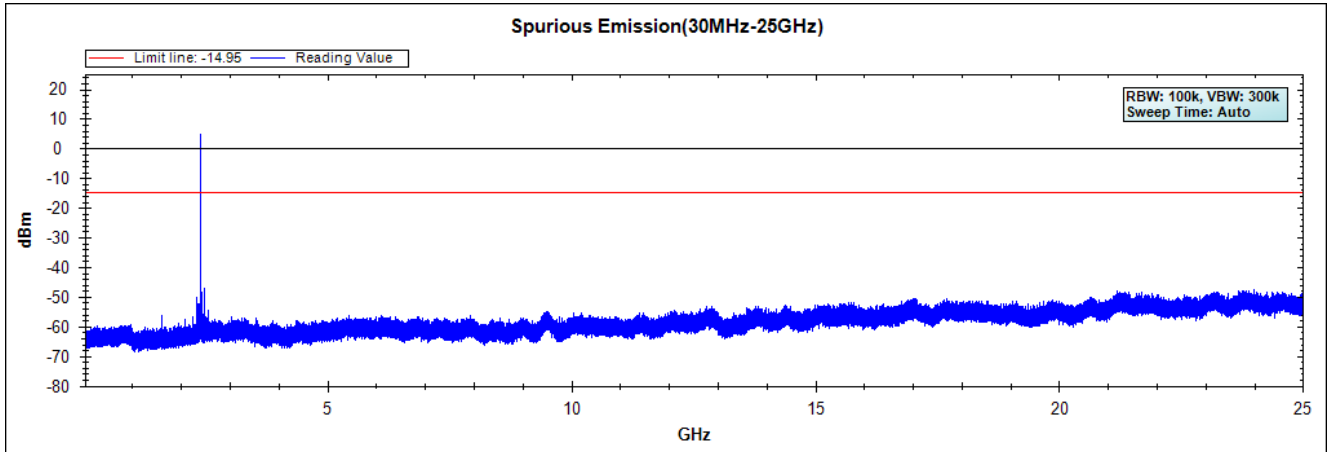

Figure Channel 19:

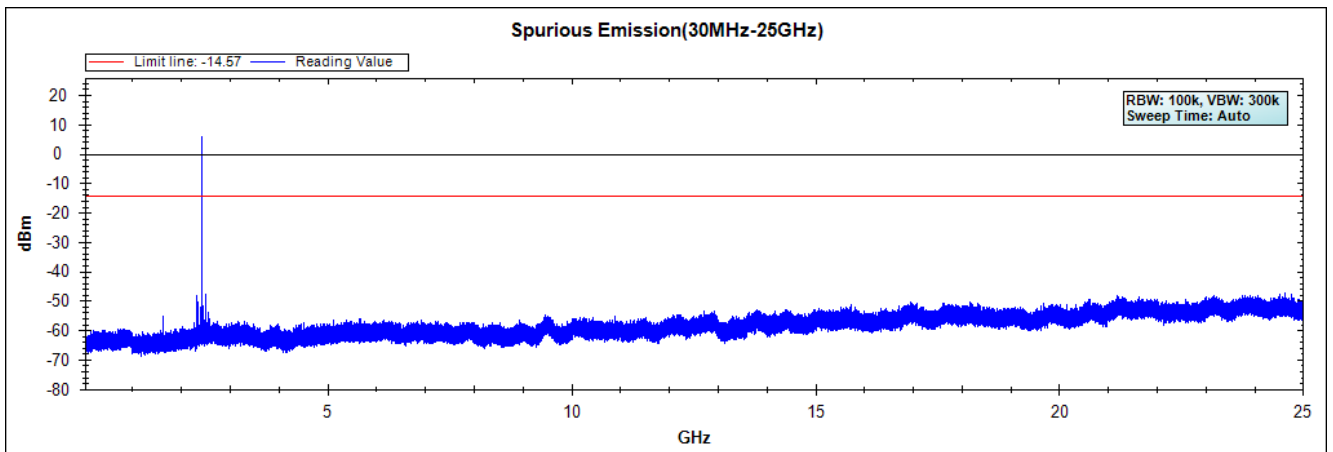
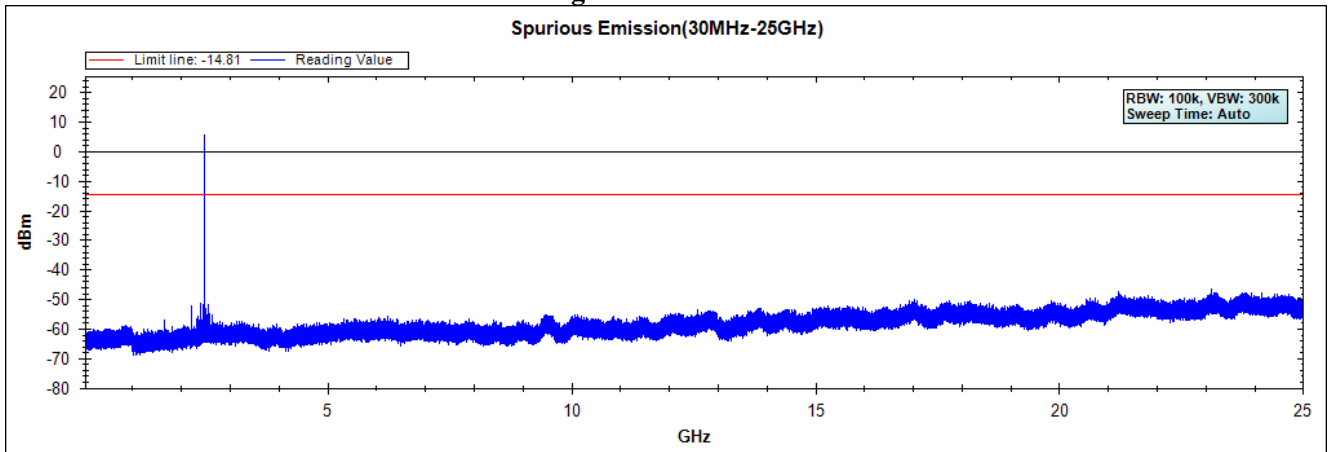

Figure Channel 39:





**6. Band Edge**

**6.1. Test Equipment**

**RF Conducted Measurement**

The following test equipments are used during the band edge tests:

	Equipment	Manufacturer	Model No./Serial No.	Last Cal.
	Spectrum Analyzer	R&S	FSP40 / 100170	Jun., 2014
	Spectrum Analyzer	Agilent	E4407B / US39440758	Jun., 2014
X	Spectrum Analyzer	Agilent	N9010A / MY48030495	Apr., 2014

**RF Radiated Measurement:**

The following test equipments are used during the band edge tests:

Test Site	Equipment	Manufacturer	Model No./Serial No.	Last Cal.
<input checked="" type="checkbox"/> Site # 3	Bilog Antenna	Schaffner Chase	CBL6112B/2673	Sep., 2014
X	Horn Antenna	Schwarzbeck	BBHA9120D/D305	Sep., 2014
	Horn Antenna	Schwarzbeck	BBHA9170/208	Jul., 2014
X	Pre-Amplifier	Agilent	8447D/2944A09549	Sep., 2014
X	Spectrum Analyzer	Agilent	E4407B / US39440758	Jul., 2014
	Test Receiver	R & S	ESCS 30/ 825442/018	Sep., 2014
X	Coaxial Cable	QuieTek	QTK-CABLE/ CAB5	Feb., 2015
X	Controller	QuieTek	QTK-CONTROLLER/ CTRL3	N/A
X	Coaxial Switch	Anritsu	MP59B/6200265729	N/A

- Note:
1. All equipments are calibrated every one year.
  2. The test instruments marked by “X” are used to measure the final test results.

## 6.2. Test Setup

### RF Conducted Measurement

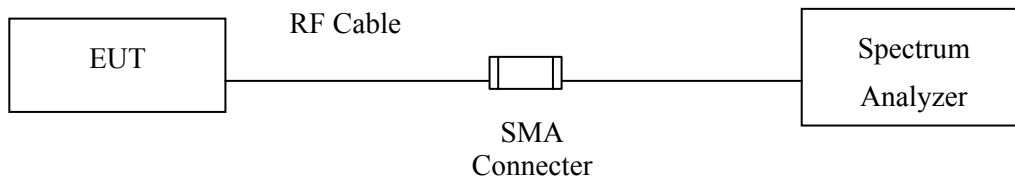

### RF Radiated Measurement:

Above 1GHz

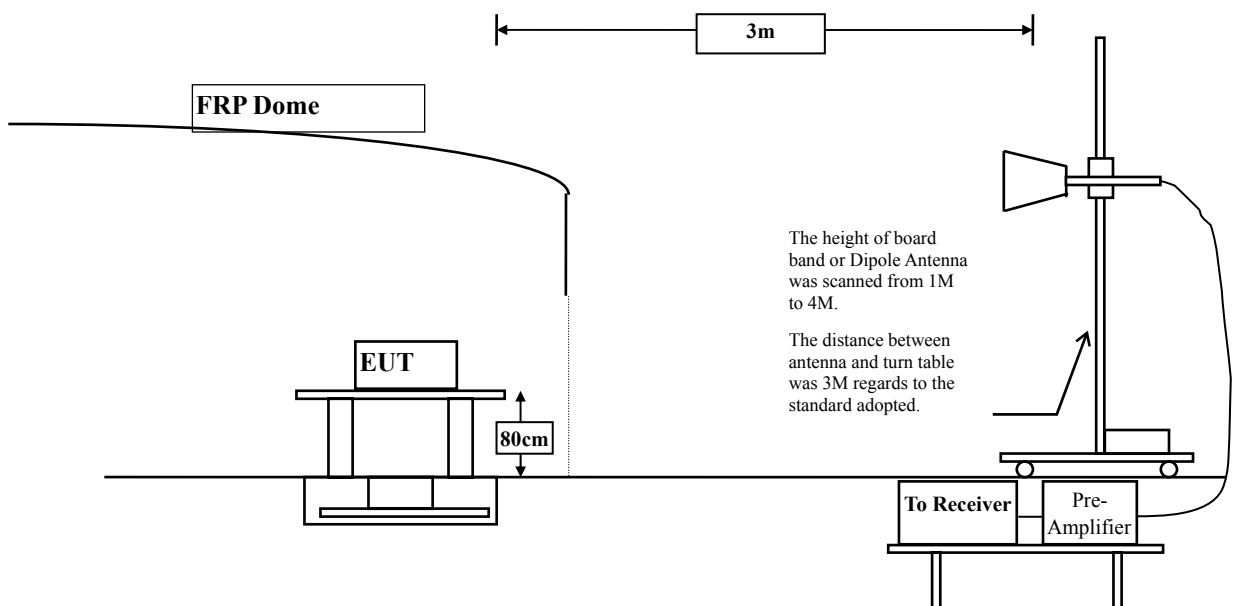

**6.3. Limit**

In any 100 kHz bandwidth outside the frequency band in which the spread spectrum intentional radiator is operating, the radio frequency power that is produced by the intentional radiator shall be at least 20 dB below that in the 100 kHz bandwidth within the band that contains the highest level of the desired power, based on either an RF conducted or a radiated measurement. Attenuation below the general limits specified in Section 15.209(a) is not required. In addition, radiated emissions which fall in the restricted bands, as defined in Section 15.205(a), must also comply with the radiated emission limits specified in Section 15.209(a) (see Section 15.205(c)).

**6.4. Test Procedure**

The EUT and its simulators are placed on a turn table which is 0.8 meter above ground. The turn table can rotate 360 degrees to determine the position of the maximum emission level. The EUT was positioned such that the distance from antenna to the EUT was 3 meters.

The antenna can move up and down between 1 meter and 4 meters to find out the maximum emission level.

Both horizontal and vertical polarization of the antenna are set on measurement. In order to find the maximum emission, all of the interface cables must be manipulated according to ANSI C63.10:2009 on radiated measurement.

The bandwidth below 1GHz setting on the field strength meter is 120 kHz, above 1GHz are 1 MHz. The EUT was setup to ANSI C63.10, 2009.

**6.5. Uncertainty**

- ± 3.9 dB above 1GHz
- ± 3.8 dB below 1GHz

6.6. Test Result of Band Edge

Product : TABLET PC  
 Test Item : Band Edge  
 Test Site : No.3 OATS  
 Test Mode : Mode 1: Transmit - BLE (GFSK) (2402MHz)

RF Radiated Measurement (Horizontal):

Channel No.	Frequency (MHz)	Correct Factor (dB)	Reading Level (dBμV)	Emission Level (dBμV/m)	Peak Limit (dBμV/m)	Average Limit (dBμV/m)	Result
00 (Peak)	2390.000	-1.131	42.767	41.636	74.00	54.00	Pass
00 (Peak)	2400.000	-1.084	80.247	79.164	--	--	--
00 (Peak)	2402.200	-1.072	100.970	99.899	--	--	--
00 (Average)	2390.000	-1.131	29.571	28.440	74.00	54.00	Pass
00 (Average)	2400.000	-1.084	55.443	54.360	--	--	--
00 (Average)	2402.000	-1.073	75.601	74.529	--	--	--

Figure Channel 00: Horizontal (Peak)

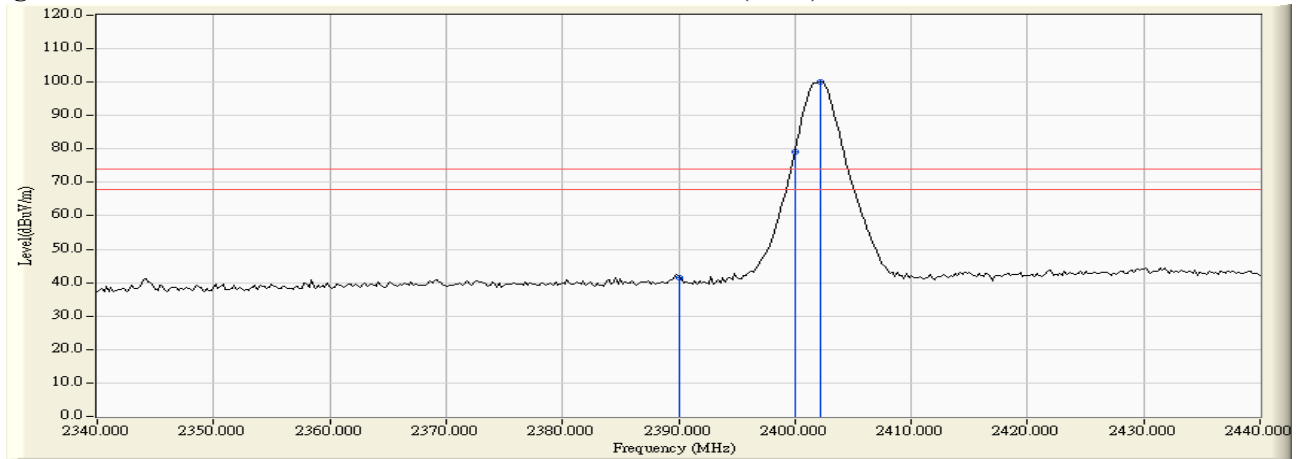
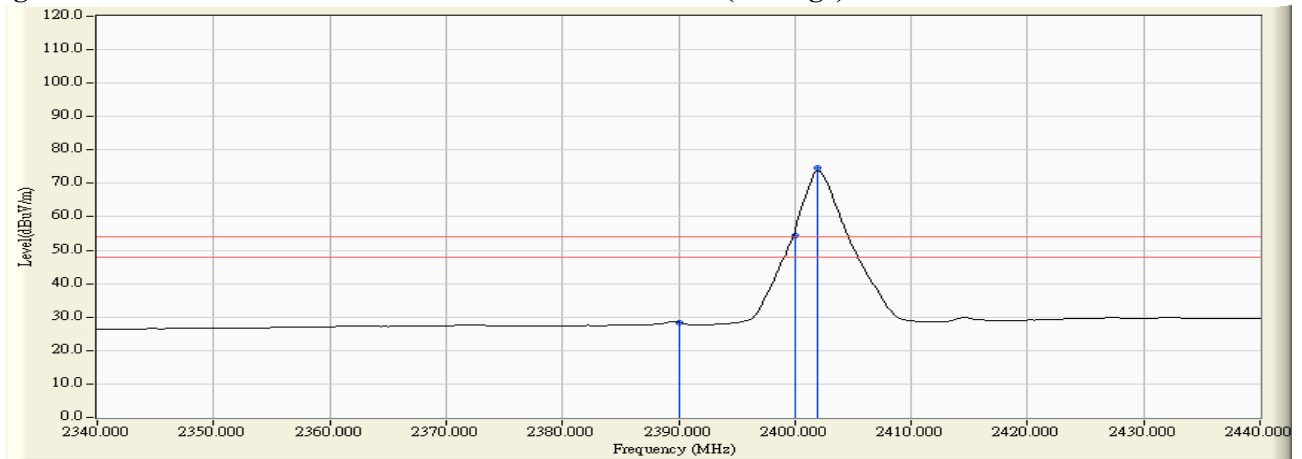

Figure Channel 00: Horizontal (Average)



Note:

1. All readings above 1GHz are performed with peak and/or average measurements as necessary.
2. Peak measurements: RBW = 1MHz, VBW = 3 MHz, Sweep: Auto.
3. Average measurements: RBW = 1MHz, VBW = 10 Hz, Sweep: Auto.
4. “ \* ”, means this data is the worst emission level.
5. Measurement Level = Reading Level + Correct Factor.
6. The average measurement was not performed when the peak measured data under the limit of average detection.

Product : TABLET PC  
 Test Item : Band Edge  
 Test Site : No.3 OATS  
 Test Mode : Mode 1: Transmit - BLE (GFSK) (2402MHz)

**RF Radiated Measurement (Vertical):**

Channel No.	Frequency (MHz)	Correct Factor (dB)	Reading Level (dBμV)	Emission Level (dBμV/m)	Peak Limit (dBμV/m)	Average Limit (dBμV/m)	Result
00 (Peak)	2390.000	-1.725	40.485	38.760	74.00	54.00	Pass
00 (Peak)	2400.000	-1.733	73.605	71.873	--	--	--
00 (Peak)	2402.200	-1.729	94.375	92.647	--	--	--
00 (Average)	2389.600	-1.723	26.327	24.604	74.00	54.00	Pass
00 (Average)	2390.000	-1.725	25.467	23.742	74.00	54.00	Pass
00 (Average)	2400.000	-1.733	49.395	47.663	--	--	--
00 (Average)	2402.200	-1.729	76.087	74.359	--	--	--

**Figure Channel 00: Vertical (Peak)**

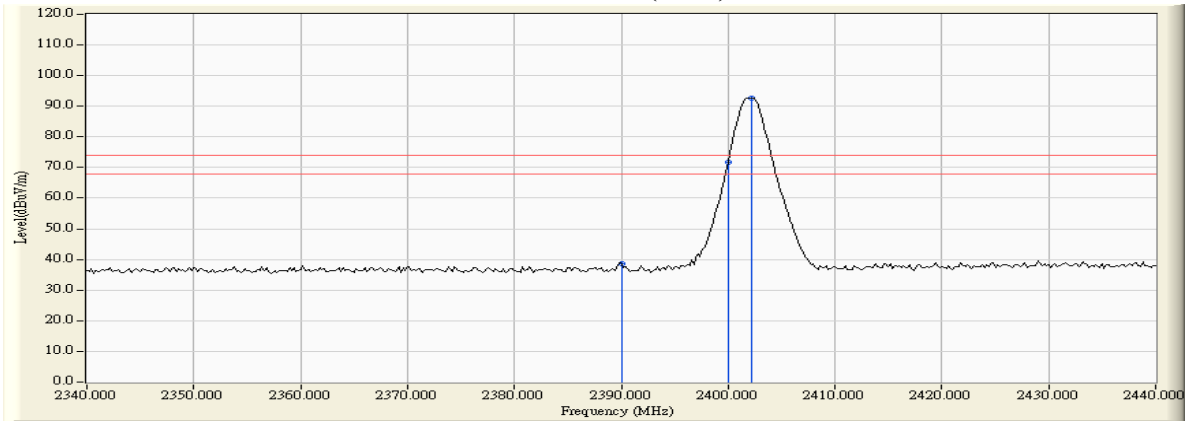

**Figure Channel 00: Vertical (Average)**

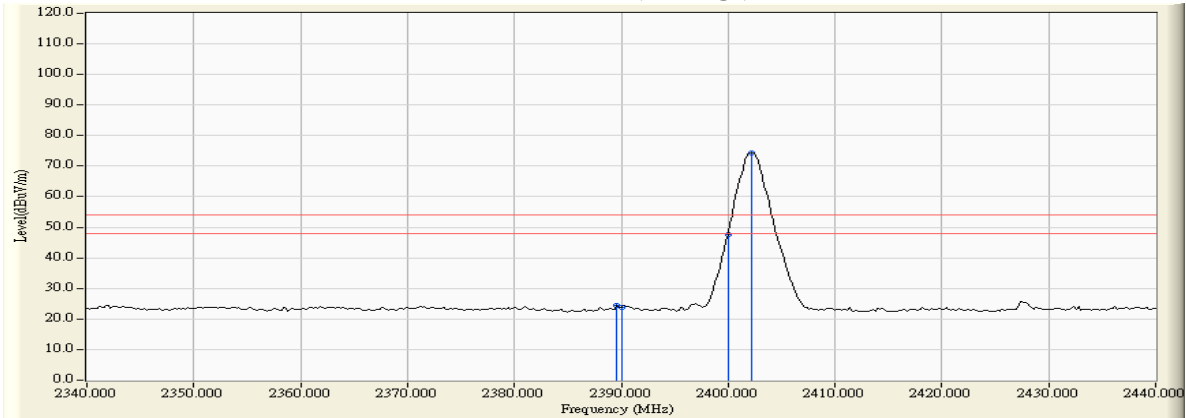

Note:

1. All readings above 1GHz are performed with peak and/or average measurements as necessary.
2. Peak measurements: RBW = 1MHz, VBW = 3 MHz, Sweep: Auto.
3. Average measurements: RBW = 1MHz, VBW = 10 Hz, Sweep: Auto.
4. “ \* ”, means this data is the worst emission level.
5. Measurement Level = Reading Level + Correct Factor.
6. The average measurement was not performed when the peak measured data under the limit of average detection.

Product : TABLET PC  
 Test Item : Band Edge  
 Test Site : No.3 OATS  
 Test Mode : Mode 1: Transmit - BLE (GFSK) (2480MHz)

**RF Radiated Measurement (Horizontal):**

Channel No.	Frequency (MHz)	Correct Factor (dB)	Reading Level (dBμV)	Emission Level (dBμV/m)	Peak Limit (dBμV/m)	Average Limit (dBμV/m)	Result
39 (Peak)	2479.700	-0.581	103.752	103.170	--	--	--
39 (Peak)	2483.500	-0.558	66.372	65.814	74.00	54.00	Pass
39 (Average)	2480.100	-0.580	75.862	75.282	--	--	--
39 (Average)	2483.500	-0.558	50.133	49.575	74.00	54.00	Pass

**Figure Channel 39: Horizontal (Peak)**

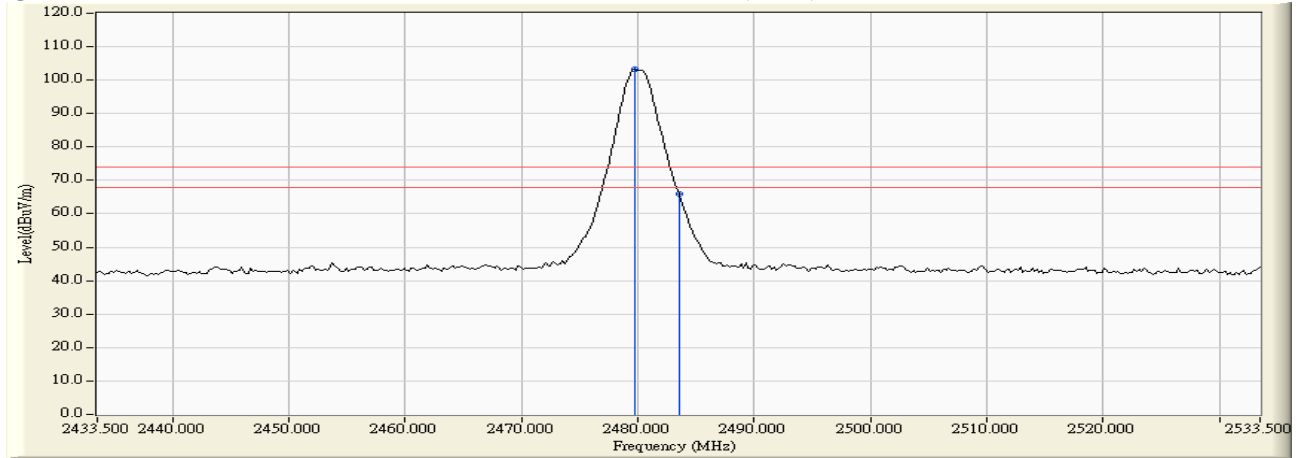

**Figure Channel 39: Horizontal (Average)**

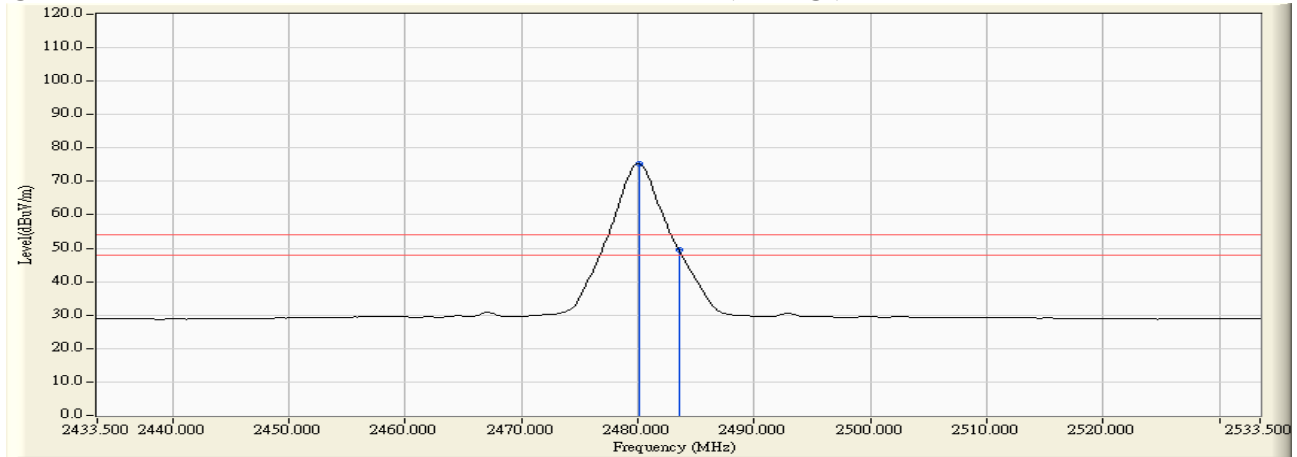

**Note:**

1. All readings above 1GHz are performed with peak and/or average measurements as necessary.
2. Peak measurements: RBW = 1MHz, VBW = 3 MHz, Sweep: Auto.
3. Average measurements: RBW = 1MHz, VBW = 10 Hz, Sweep: Auto.
4. “ \* ”, means this data is the worst emission level.
5. Measurement Level = Reading Level + Correct Factor.
6. The average measurement was not performed when the peak measured data under the limit of average detection.

Product : TABLET PC  
 Test Item : Band Edge  
 Test Site : No.3 OATS  
 Test Mode : Mode 1: Transmit - BLE (GFSK) (2480MHz)

**RF Radiated Measurement (Vertical):**

Channel No.	Frequency (MHz)	Correct Factor (dB)	Reading Level (dBμV)	Emission Level (dBμV/m)	Peak Limit (dBμV/m)	Average Limit (dBμV/m)	Result
39 (Peak)	2480.100	-1.324	102.785	101.461	--	--	--
39 (Peak)	2483.500	-1.305	65.263	63.958	74.00	54.00	Pass
39 (Average)	2480.100	-1.324	75.408	74.084	--	--	--
39 (Average)	2483.500	-1.305	49.603	48.298	74.00	54.00	Pass

**Figure Channel 39: Vertical (Peak)**

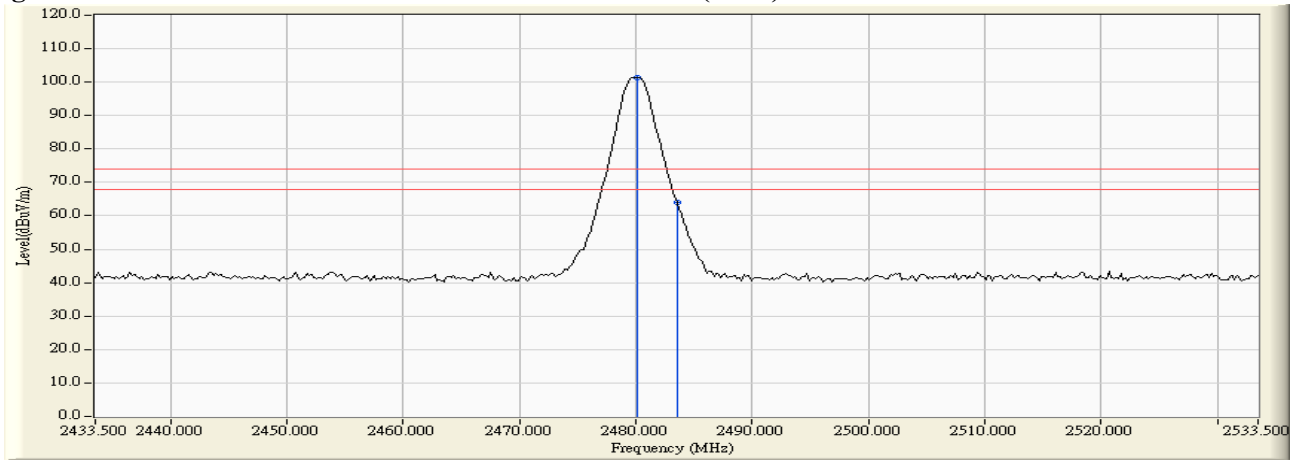

**Figure Channel 39: Vertical (Average)**

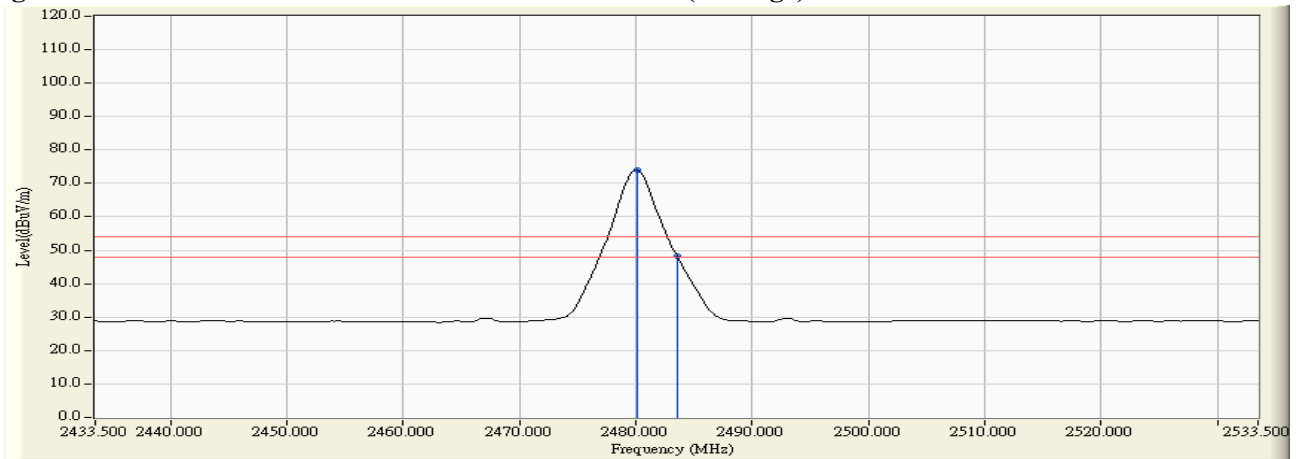

**Note:**

1. All readings above 1GHz are performed with peak and/or average measurements as necessary.
2. Peak measurements: RBW = 1MHz, VBW = 3 MHz, Sweep: Auto.
3. Average measurements: RBW = 1MHz, VBW = 10 Hz, Sweep: Auto.
4. “ \* ”, means this data is the worst emission level.
5. Measurement Level = Reading Level + Correct Factor.
6. The average measurement was not performed when the peak measured data under the limit of average detection.

**7. Occupied Bandwidth (6dB BW)**

**7.1. Test Equipment**

	Equipment	Manufacturer	Model No./Serial No.	Last Cal.
	Spectrum Analyzer	R&S	FSP40 / 100170	Jun., 2014
	Spectrum Analyzer	Agilent	E4407B / US39440758	Jun., 2014
X	Spectrum Analyzer	Agilent	N9010A / MY48030495	Apr., 2014

Note:

1. All equipments are calibrated with traceable calibrations. Each calibration is traceable to the national or international standards.
2. The test instruments marked with “X” are used to measure the final test results.

**7.2. Test Setup**

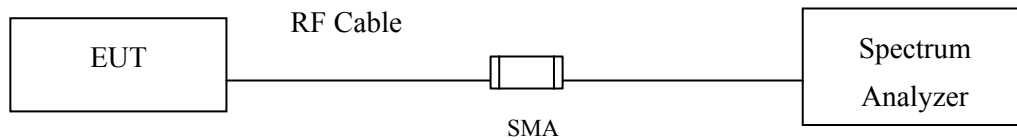

**7.3. Limits**

The minimum bandwidth shall be at least 500 kHz.

**7.4. Test Procedure**

The EUT was setup according to ANSI C63.10 2009; tested according to DTS test procedure of KDB558074 for compliance to FCC 47CFR 15.247 requirements.

Set RBW = 1-5% of the emission bandwidth, VBW ≥ 3\*RBW

**7.5. Uncertainty**

± 150Hz



7.6. Test Result of Occupied Bandwidth

Product : TABLET PC  
 Test Item : Occupied Bandwidth Data  
 Test Site : No.3 OATS  
 Test Mode : Mode 1: Transmit - BLE (GFSK) (2402MHz)

Channel No.	Frequency (MHz)	Measurement Level (kHz)	Required Limit (kHz)	Result
00	2402	830.0	>500	Pass
19	2440	830.0	>500	Pass
39	2480	830.0	>500	Pass

Figure Channel 00:

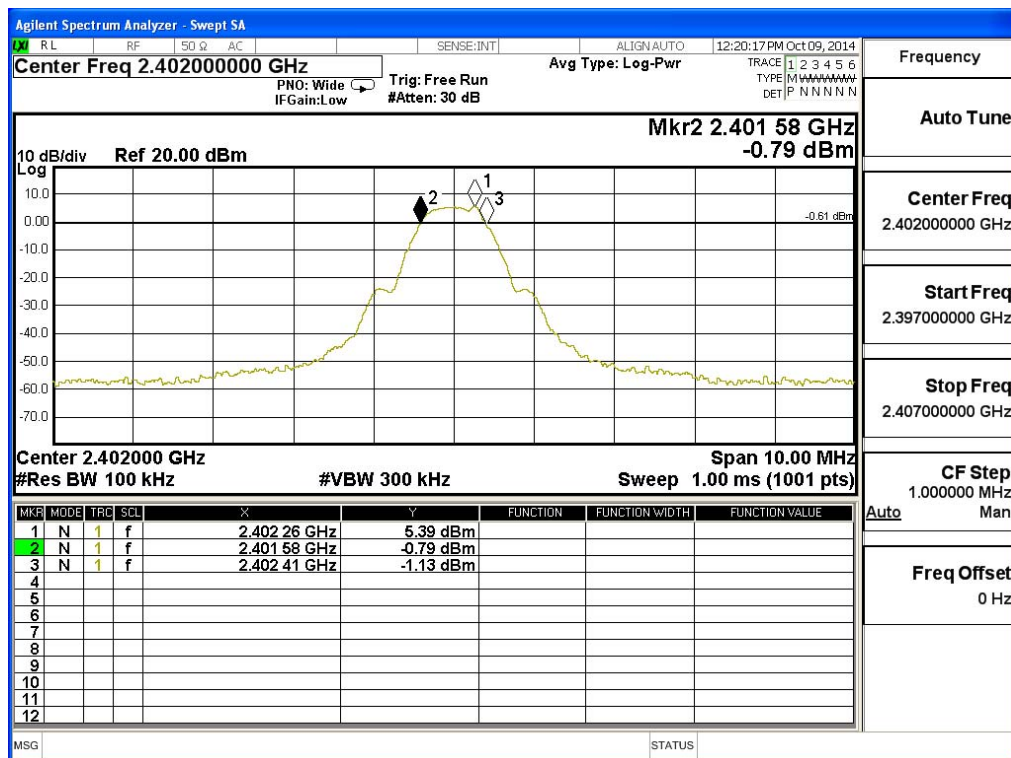

Figure Channel 19:

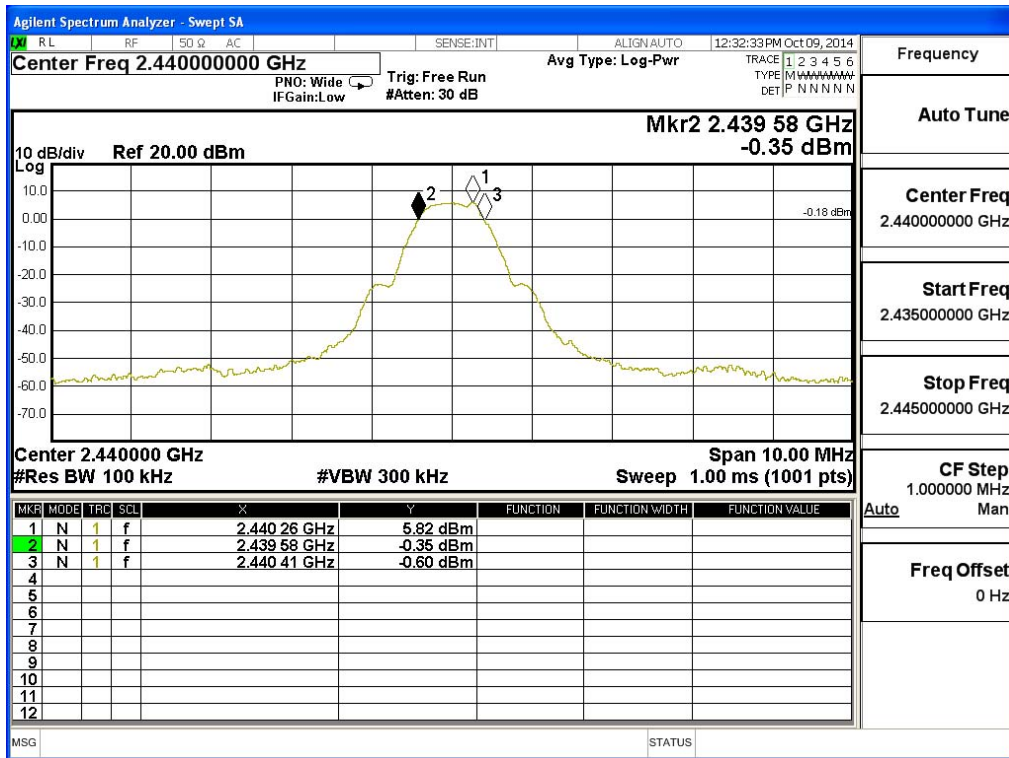
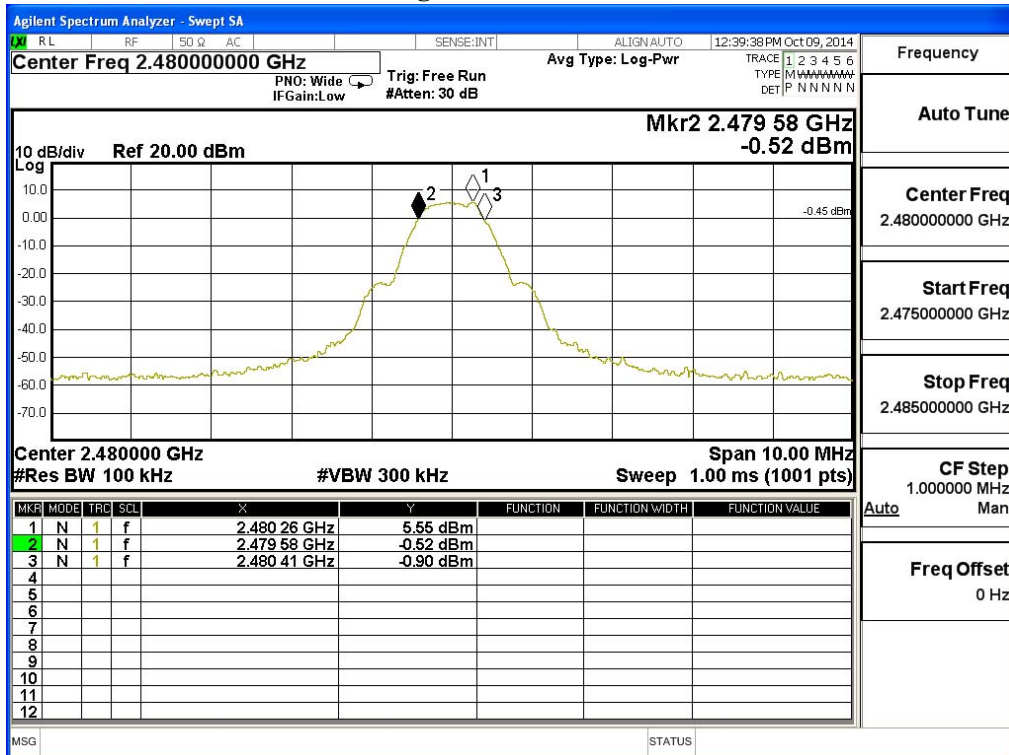

Figure Channel 39:



**8. Power Density**

**8.1. Test Equipment**

	Equipment	Manufacturer	Model No./Serial No.	Last Cal.
	Spectrum Analyzer	R&S	FSP40 / 100170	Jun., 2014
	Spectrum Analyzer	Agilent	E4407B / US39440758	Jun., 2014
X	Spectrum Analyzer	Agilent	N9010A / MY48030495	Apr., 2014

Note:

1. All equipments are calibrated with traceable calibrations. Each calibration is traceable to the national or international standards.
2. The test instruments marked with “X” are used to measure the final test results.

**8.2. Test Setup**

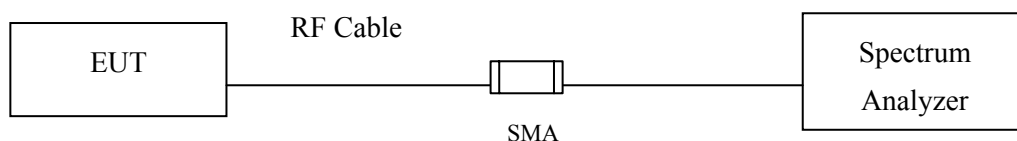

**8.3. Limits**

The transmitted power density averaged over any 1 second interval shall not be greater +8dBm in any 3kHz bandwidth.

**8.4. Test Procedure**

The EUT was setup according to ANSI C63.10: 2009, the maximum power spectral density using KDB 558074 section 10.2 PKPSD (peak PSD) method.

**8.5. Uncertainty**

± 1.27 dB

8.6. Test Result of Power Density

Product : TABLET PC  
 Test Item : Power Density Data  
 Test Site : No.3 OATS  
 Test Mode : Mode 1: Transmit - BLE (GFSK) (2402MHz)

Channel No.	Frequency (MHz)	Measure Level (dBm)	Limit (dBm)	Result
00	2402	5.050	< 8dBm	Pass
19	2440	5.430	< 8dBm	Pass
39	2480	5.190	< 8dBm	Pass

Figure Channel 00:

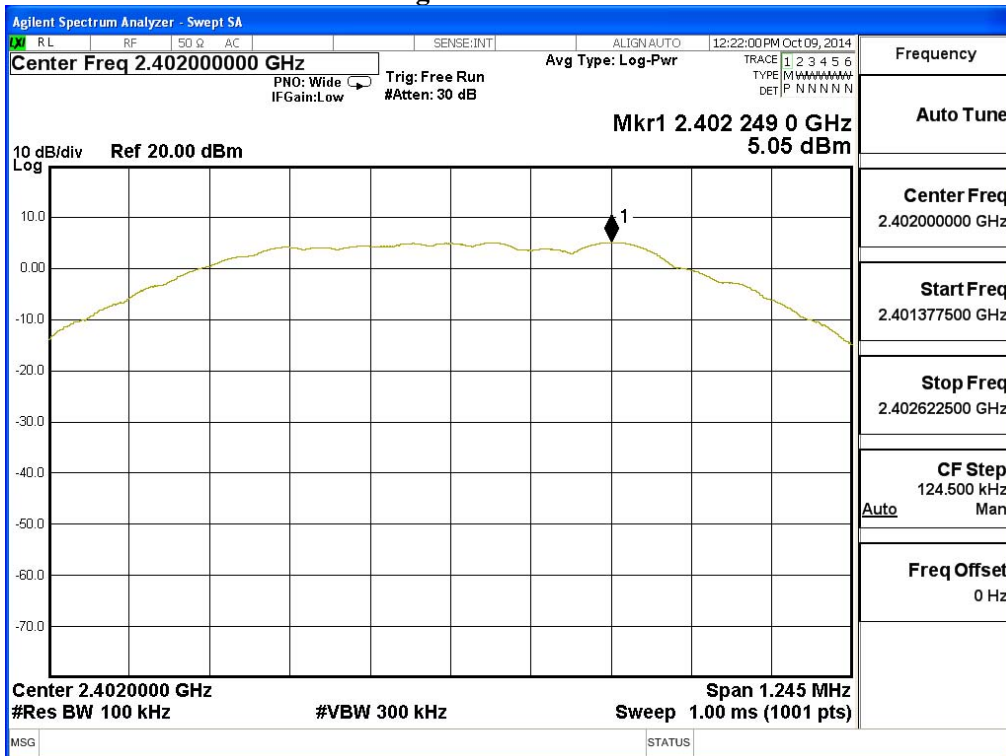

Figure Channel 19:

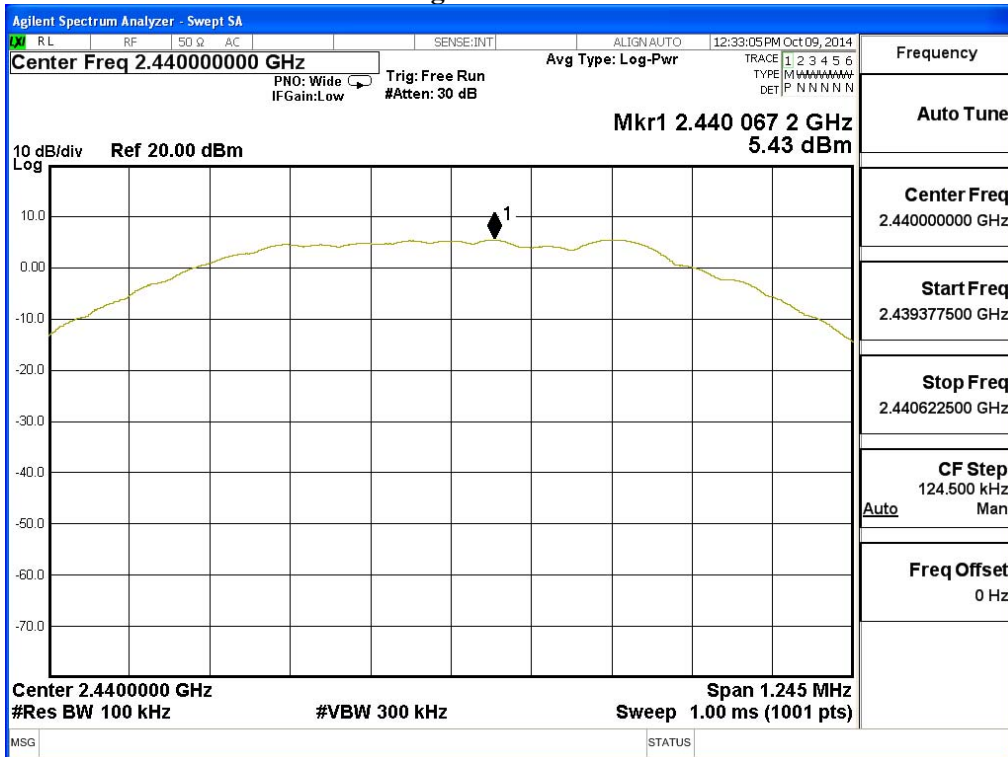
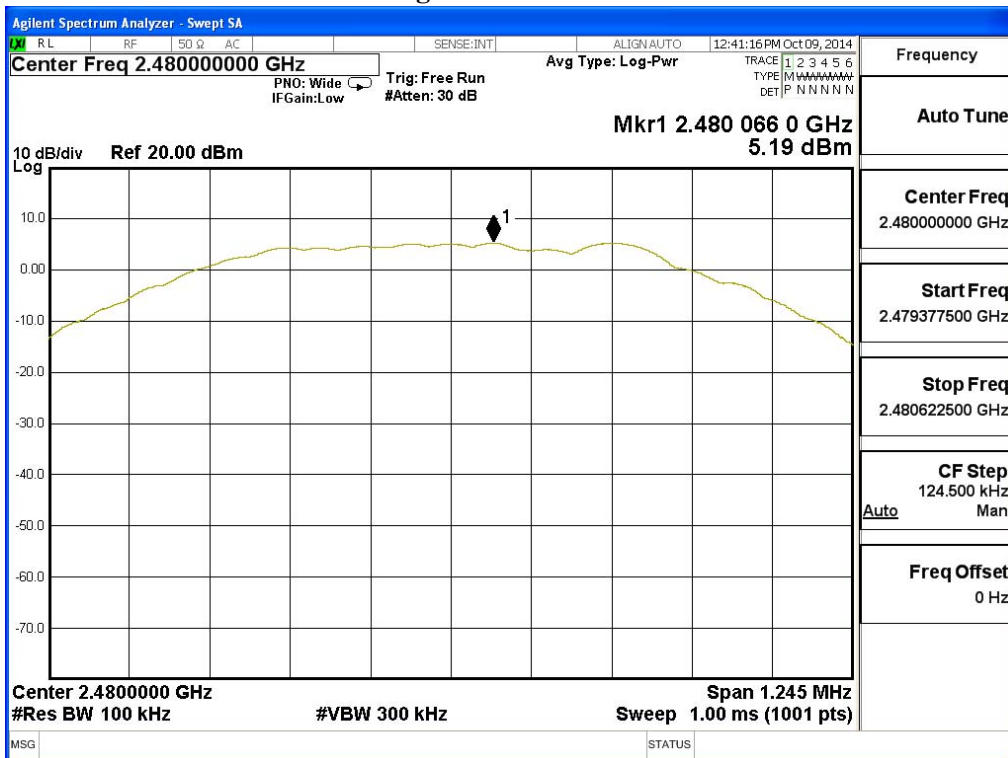

Figure Channel 39:



**9. EMI Reduction Method During Compliance Testing**

No modification was made during testing.

Attachment 1: EUT Test Photographs

Attachment 2: EUT Detailed Photographs