

FCC SAR Test Report

Product Name : TABLET PC
Model No. : PA-501

Applicant : RuggON Corporation
Address : 3F., No.10, Ln. 181, Sec. 2, Jiuzong Rd., Neihu Dist., Taipei City , Taiwan

Date of Receipt : 2015/04/10
Issued Date : 2015/06/18
Report No. : 1540249R-SAUSP02V00
Report Version : V1.0



The test results relate only to the samples tested.

The test results shown in the test report are traceable to the national/international standard through the calibration of the equipment and evaluated measurement uncertainty herein.

This report must not be used to claim product endorsement by TAF or any agency of the government.

The test report shall not be reproduced without the written approval of QuieTek Corporation.

Test Report

Issued Date: 2015/06/18

Report No.: 1540249R-SAUSP02V00



Product Name : TABLET PC
Applicant : RuggON Corporation
Address : 3F., No.10, Ln. 181, Sec. 2, Jiuzong Rd., Neihu Dist., Taipei
City , Taiwan
Manufacturer : Ubiqconn Technology,Inc.
Model No. : PA-501
Trade Name : RuggON
FCC ID : 2ABTU-PA-501
Applicable Standard : FCC Oet65 Supplement C June 2001
IEEE Std. 1528-2003
47CFR § 2.1093
Measurement : KDB 447498 D01 v05r02
procedures : KDB 248227 D01 v02r01
KDB 616217 D04 V01r01
KDB 865664 D01 V01r01
Test Result : Max. SAR Measurement (1g)
802.11b/g(2.4GHz): **0.15** W/kg
802.11a(5 GHz): **0.23** W/kg
Application Type : Certification

Documented By : Anny Chou
(Senior Adm. Specialist / Anny Chou)

Tested By : Vorana Chen
(Senior Engineer / Vorana Chen)

Approved By : [Signature]
(Director / Vincent Lin)

TABLE OF CONTENTS

Description	Page
1. General Information.....	5
1.1 EUT Description	5
1.2 Antenna List.....	5
1.3 Maximum output power and tolerance allowed for production units.....	6
1.4 SAR Test Exclusion Calculation	6
1.5 Test Environment.....	7
2. SAR Measurement System	8
2.1 DASY5 System Description	8
2.1.1 Applications	9
2.1.2 Area Scans.....	9
2.1.3 Zoom Scan (Cube Scan Averaging).....	9
2.1.4 Uncertainty of Inter-/Extrapolation and Averaging.....	9
2.2 DASY5 E-Field Probe	10
2.2.1 Isotropic E-Field Probe Specification	10
2.3 Boundary Detection Unit and Probe Mounting Device	11
2.4 DATA Acquisition Electronics (DAE) and Measurement Server	11
2.5 Robot.....	12
2.6 Light Beam Unit.....	12
2.7 Device Holder	13
2.8 SAM Twin Phantom	13
3. Tissue Simulating Liquid	14
3.1 The composition of the tissue simulating liquid	14
3.2 Tissue Calibration Result	14
3.3 Tissue Dielectric Parameters for Head and Body Phantoms	17
4. SAR Measurement Procedure	18
4.1 SAR System Check.....	18
4.1.1 Dipoles	18
4.1.2 System Check Result	18
4.2 SAR Measurement Procedure.....	20
5. SAR Exposure Limits	21
6. Test Equipment List.....	22
7. Measurement Uncertainty	23
8. Conducted Power Measurement	25
9. Test Results.....	26
9.1 SAR Test Results Summary	26

9.2 Simultaneous Transmission	28
10. SAR measurement variability	29
Appendix	30
Appendix A. SAR System Check Data	
Appendix B. SAR measurement Data	
Appendix C. Test Setup Photographs & EUT Photographs	
Appendix D. Probe Calibration Data	
Appendix E. Dipole Calibration Data	

1. General Information

1.1 EUT Description

Product Name	TABLET PC
Trade Name	RuggON
Model No.	PA-501
FCC ID	2ABTU-PA-501
TX Frequency	802.11b/g/n-20MHz: 2412-2462MHz, 802.11a/n-20MHz: 5180-5320MHz,5500-5700MHz, 5745-5825MHz
Number of Channels	802.11b/g/n-20MHz: 11 802.11a/n-20MHz: 24,
Data Rate	802.11b: 1-11Mbps, 802.11a/g: 6-54Mbps, 802.11n: up to 72.2Mbps
Type of Modulation	802.11b:DSSS, DBPSK, DQPSK, CCK 802.11a/g/n:OFDM,(BPSK, QPSK, 16QAM, 64QAM)
Contain Module	JORJIN / WG7550
Antenna Type	PIFA
Device Category	Portable
RF Exposure Environment	Uncontrolled
Max. Output Power (Conducted)	802.11b: 13.95 dBm 802.11g/n-20M: 13.98 dBm 802.11a/n-20M 14.57 dBm

*Note: (1) Per FCC KDB 447498 D01. The output power of BT is less than 10mW, so SAR not required.

(2) BT & WLAN can't work simultaneously, thus simultaneous mode is no need.

1.2 Antenna List

No.	Manufacturer	Part No.	Peak Gain
1	ethertronics	5001791 (Main)(TX1) 5001799 (Aux)(TX2)	3.8dBi For 2.4GHz 5.1dBi For 5.15~5.25GHz 5.1dBi For 5.25~5.35GHz 4.2dBi For 5.47~5.725GHz 2.6dBi For 5.725~5.850GHz

1.3 Maximum output power and tolerance allowed for production units

Band	Mode	Nominal power (dBm)	Tolerance (dBm)	Upper Tolerance (dBm)
2.4G	80.11b/g/n-20	13	±1	14
5G	802.11 a/n-20	13.5	±1	14.5
5G	802.11 n-20	13	±1	14
BT	1M/3M	-2	±2	0

1.4 SAR Test Exclusion Calculation

According 447498 D01, SAR is not required base on below:

Main Antenna	Tx	Frequency (MHz)	Output Power		Separation distances (mm)					<50mm ,Calcaued Threshold Value (≤3.0 SAR is not required)				
			dBm	mW	Back	Right	Left	Top	Bottom	Back	Right	Left	Top	Bottom
2.4G	WiFi	2437	14.00	25	18	217	43	182	6	2.2	>50mm	0.9	>50mm	6.5
Main Antenna	Tx	Frequency (MHz)	Output Power		Separation distances (mm)					>50mm ,Calcaued Threshold Value (SAR test exclusion power,mW)				
			dBm	mW	Back	Right	Left	Top	Bottom	Back	Right	Left	Top	Bottom
2.4G	WiFi	2412	14.00	25	18	217	43	182	6	<50mm	1766.6	<50mm	1416.6	<50mm
Aux Antenna	Tx	Frequency (MHz)	Output Power		Separation distances (mm)					<50mm ,Calcaued Threshold Value (≤3.0 SAR is not required)				
			dBm	mW	Back	Right	Left	Top	Bottom	Back	Right	Left	Top	Bottom
5G	WiFi	5150	14.50	28	18	217	27	6	183	3.6	>50mm	2.4	10.7	>50mm
5G	WiFi	5280	14.50	28	18	217	27	6	183	3.6	>50mm	2.4	10.8	>50mm
5G	WiFi	5520	14.50	28	18	217	27	6	183	3.7	>50mm	2.5	11.0	>50mm
5G	WiFi	5745	14.50	28	18	217	27	6	183	3.8	>50mm	2.5	11.3	>50mm
Aux Antenna	Tx	Frequency (MHz)	Output Power		Separation distances (mm)					>50mm ,Calcaued Threshold Value (SAR test exclusion power,mW)				
			dBm	mW	Back	Right	Left	Top	Bottom	Back	Right	Left	Top	Bottom
5G	WiFi	5150	14.50	28	18	217	27	6	183	<50mm	1736.1	<50mm	<50mm	1396.1
5G	WiFi	5280	14.50	28	18	217	27	6	183	<50mm	1735.3	<50mm	<50mm	1395.3
5G	WiFi	5520	14.50	28	18	217	27	6	183	<50mm	1733.8	<50mm	<50mm	1393.8
5G	WiFi	5745	14.50	28	18	217	27	6	183	<50mm	1732.6	<50mm	<50mm	1392.6

1.5 Test Environment

Ambient conditions in the laboratory:

Test Date: June 10, 2015

Items	Required	Actual
Temperature (°C)	18-25	22.1± 2
Humidity (%RH)	30-70	48

Test Date: June 11, 2015

Items	Required	Actual
Temperature (°C)	18-25	21.9± 2
Humidity (%RH)	30-70	51

Site Description:

Accredited by TAF
 Accredited Number: 3023
 Effective through: December 12, 2017

Site Name: Quietek Corporation

Site Address: No.5-22, Ruishukeng, Linkou Dist.,
 New Taipei City 24451,
 Taiwan, R.O.C.
 TEL: 886-2-8601-3788 / FAX: 886-2-8601-3789
 E-Mail: service@quietek.com

2. SAR Measurement System

2.1 DASYS System Description

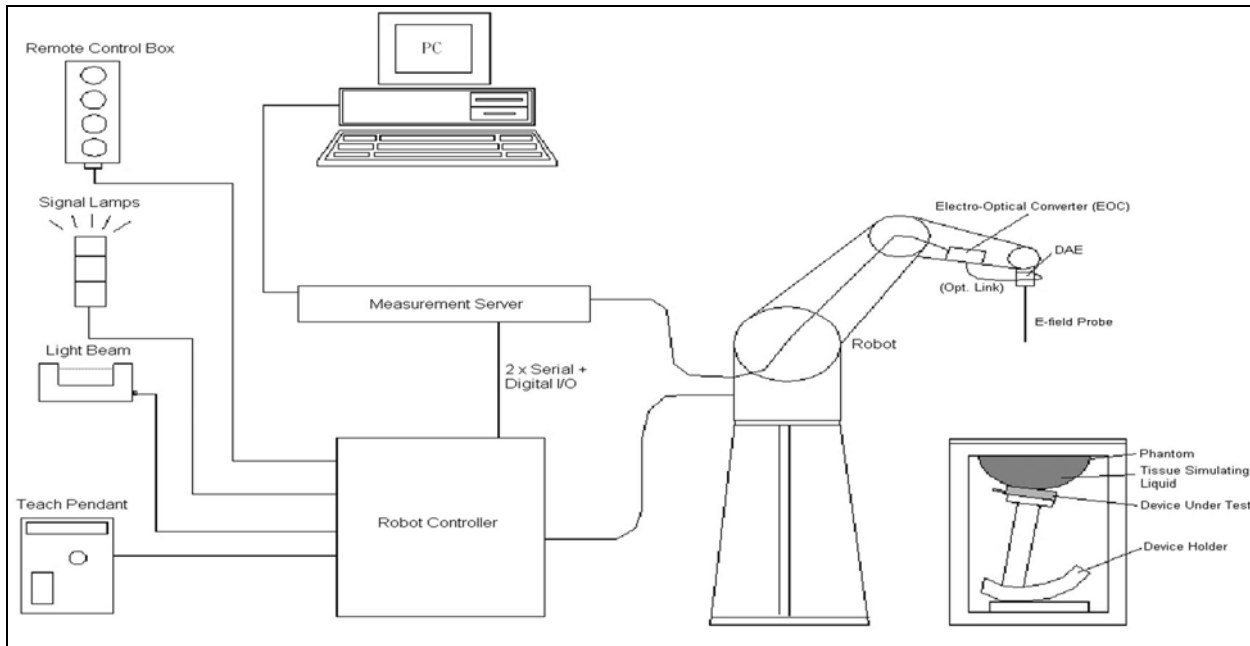

The DASYS system for performing compliance tests consists of the following items:

- A standard high precision 6-axis robot with controller, teach pendant and software. An arm extension for accommodating the data acquisition electronics (DAE).
- A data acquisition electronics (DAE) which performs the signal amplification, signal multiplexing, AD-conversion, offset measurements, mechanical surface detection, collision detection, etc. The unit is battery powered with standard or rechargeable batteries. The signal is optically transmitted to the EOC.
- The Electro-optical converter (EOC) performs the conversion from optical to electrical signals for the digital communication to the DAE. To use optical surface detection, a special version of the EOC is required. The EOC signal is transmitted to the measurement server.
- The Light Beam used is for probe alignment. This improves the (absolute) accuracy of the probe positioning.
- A computer running WinXP and the DASYS software.
- Remote control and teach pendant as well as additional circuitry for robot safety such as warning lamps, etc.
- The phantom, the device holder and other accessories according to the targeted measurement.

2.1.1 Applications

Predefined procedures and evaluations for automated compliance testing with all worldwide standards, e.g., IEEE 1528, OET 65, IEC 62209-1, IEC 62209-2, EN 50360, EN 50383 and others.

2.1.2 Area Scans

Area scans are defined prior to the measurement process being executed with a user defined variable spacing between each measurement point (integral) allowing low uncertainty measurements to be conducted. Scans defined for FCC applications utilize a 10mm² step integral, with 1mm interpolation used to locate the peak SAR area used for zoom scan assessments.

When an Area Scan has measured all reachable points, it computes the field maxima found in the scanned area, within a range of the global maximum. The range (in dB) is specified in the standards for compliance testing. For example, a 2 dB range is required in IEEE 1528-2003, EN 50361 and IEC 62209 standards, whereby 3 dB is a requirement when compliance is assessed in accordance with the ARIB standard (Japan).

2.1.3 Zoom Scan (Cube Scan Averaging)

Zoom Scans are used to assess the peak spatial SAR values within a cubic averaging volume containing 1 g and 10 g of simulated tissue. A density of 1000 kg/m³ is used to represent the head and body tissue density and not the phantom liquid density, in order to be consistent with the definition of the liquid dielectric properties, i.e. the side length of the 1 g cube is 10mm, with the side length of the 10 g cube 21,5mm.

The zoom scan integer steps can be user defined so as to reduce uncertainty, but normal practice for typical test applications (including FCC) utilize a physical step of 5x5x7 (8mmx8mmx5mm) providing a volume of 32mm in the X & Y axis, and 30mm in the Z axis.

2.1.4 Uncertainty of Inter-/Extrapolation and Averaging

In order to evaluate the uncertainty of the interpolation, extrapolation and averaged SAR calculation algorithms of the Postprocessor, DASY5 allows the generation of measurement grids which are artificially predefined by analytically based test functions. Therefore, the grids of area scans and zoom scans can be filled with uncertainty test data, according to the SAR benchmark functions of IEEE 1528. The three analytical functions shown in equations as below are used to describe the possible range of the expected SAR distributions for the tested handsets. The field gradients are covered by the spatially flat

distribution f1, the spatially steep distribution f3 and f2 accounts for H-field cancellation on the phantom/tissue surface.

$$f_1(x, y, z) = Ae^{-\frac{z}{2a}} \cos^2 \left(\frac{\pi \sqrt{x'^2 + y'^2}}{2 \cdot 5a} \right)$$

$$f_2(x, y, z) = Ae^{-\frac{z}{a}} \frac{a^2}{a^2 + x'^2} \left(3 - e^{-\frac{2z}{a}} \right) \cos^2 \left(\frac{\pi y'}{2 \cdot 3a} \right)$$

$$f_3(x, y, z) = A \frac{a^2}{\frac{a^2}{4} + x'^2 + y'^2} \left(e^{-\frac{2z}{a}} + \frac{a^2}{2(a + 2z)^2} \right)$$

2.2 DASY5 E-Field Probe

The SAR measurement is conducted with the dosimetric probe manufactured by SPEAG. The probe is specially designed and calibrated for use in liquid with high permittivity. The dosimetric probe has special calibration in liquid at different frequency.

SPEAG conducts the probe calibration in compliance with international and national standards (e.g. IEEE 1528, EN 62209-1, IEC 62209, etc.) under ISO 17025. The calibration data are in Appendix D.

2.2.1 Isotropic E-Field Probe Specification

Model	Ex3DV4	
Construction	Symmetrical design with triangular core Built-in shielding against static charges PEEK enclosure material (resistant to organic solvents, e.g., DGBE)	
Frequency	10 MHz to 6 GHz Linearity: ± 0.2 dB (30 MHz to 6 GHz)	
Directivity	± 0.3 dB in HSL (rotation around probe axis) ± 0.5 dB in tissue material (rotation normal to probe axis)	
Dynamic Range	10 µW/g to 100 mW/g Linearity: ± 0.2 dB (noise: typically < 1 µW/g)	
Dimensions	Overall length: 330 mm (Tip: 20 mm) Tip diameter: 2.5 mm (Body: 12 mm) Typical distance from probe tip to dipole centers: 1 mm	
Application	High precision dosimetric measurements in any exposure scenario (e.g., very strong gradient fields). Only probe which enables compliance testing for frequencies up to 6 GHz with precision of better 30%.	

2.3 Boundary Detection Unit and Probe Mounting Device

The DASY probes use a precise connector and an additional holder for the probe, consisting of a plastic tube and a flexible silicon ring to center the probe. The connector at the DAE is flexibly mounted and held in the default position with magnets and springs. Two switching systems in the connector mount detect frontal and lateral probe collisions and trigger the necessary software response.



2.4 DATA Acquisition Electronics (DAE) and Measurement Server

The data acquisition electronics (DAE) consists of a highly sensitive electrometer-grade preamplifier with auto-zeroing, a channel and gain-switching multiplexer, a fast 16 bit AD-converter and a command decoder and control logic unit.

Transmission to the measurement server is accomplished through an optical downlink for data and status information as well as an optical uplink for commands and the clock.

The input impedance of the DAE4 is 200M Ohm; the inputs are symmetrical and floating. Common mode rejection is above 80dB.



The DASY5 measurement server is based on a PC/104 CPU board with a 400MHz intel ULV Celeron, 128MB chipdisk and 128MB RAM. The necessary circuits for communication with the DAE electronics box, as well as the 16 bit AD converter system for optical detection and digital I/O interface are contained on the DASY5 I/O board, which is directly connected to the PC/104 bus of the CPU board.



2.5 Robot

The DASY5 system uses the high precision robots TX90 XL type out of the newer series from Stäubli SA (France). For the 6-axis controller DASY5 system, the CS8C robot controller version from Stäubli is used.

The XL robot series have many features that are important for our application:

- High precision (repeatability 0.02 mm)
- High reliability (industrial design)
- Jerk-free straight movements
- Low ELF interference (the closed metallic construction shields against motor control fields)
- 6-axis controller



2.6 Light Beam Unit

The light beam switch allows automatic "tooling" of the probe. During the process, the actual position of the probe tip with respect to the robot arm is measured, as well as the probe length and the horizontal probe offset. The software then corrects all movements, such that the robot coordinates are valid for the probe tip.

The repeatability of this process is better than 0.1 mm. If a position has been taught with an aligned probe, the same position will be reached with another aligned probe within 0.1 mm, even if the other probe has different dimensions. During probe rotations, the probe tip will keep its actual position.



2.7 Device Holder

The DASY5 device holder is designed to cope with different positions given in the standard. It has two scales for the device rotation (with respect to the body axis) and the device inclination (with respect to the line between the ear reference points). The rotation center for both scales is the ear reference point (EPR).

Thus the device needs no repositioning when changing the angles.

The DASY5 device holder has been made out of low-loss POM material having the following dielectric parameters: relative permittivity $\epsilon_r = 3$ and loss tangent $\delta = 0.02$. The amount of dielectric material has been reduced in the closest vicinity of the device, since measurements have suggested that the influence of the clamp on the test results could thus be lowered.



2.8 SAM Twin Phantom

The SAM twin phantom is a fiberglass shell phantom with 2mm shell thickness (except the ear region where shell thickness increases to 6mm). It has three measurement areas:

- Left head
- Right head
- Flat phantom



The bottom plate contains three pair of bolts for locking the device holder. The device holder positions are adjusted to the standard measurement positions in the three sections. A white cover is provided to tap the phantom during off-periods to prevent water evaporation and changes in the liquid parameters. On the phantom top, three reference markers are provided to identify the phantom position with respect to the robot.

3. Tissue Simulating Liquid

3.1 The composition of the tissue simulating liquid

INGREDIENT (% Weight)	2450MHz Head	2450MHz Body	5200MHz Body	5800MHz Body
Water	46.7	73.2	76	75.68
Salt	0.00	0.04	0.00	0.43
Sugar	0.00	0.00	0.00	0.00
HEC	0.00	0.00	0.00	0.00
Preventol	0.00	0.00	0.00	0.00
DGBE	53.3	26.7	4.44	4.42

3.2 Tissue Calibration Result

The dielectric parameters of the liquids were verified prior to the SAR evaluation using APREL Dielectric Probe Kit and Agilent E5071C Vector Network Analyzer.

Body Tissue Simulate Measurement				
Frequency [MHz]	Description	Dielectric Parameters		Tissue Temp. [°C]
		ϵ_r	σ [s/m]	
2450 MHz	Reference result ± 5% window	52.7 50.065 to 55.335	1.95 1.8525 to 2.0475	N/A
	10-June-15	52.87	1.95	20.8
2412 MHz	Low channel	53.02	1.89	20.8
2437 MHz	Mid channel	52.94	1.93	20.8
2462 MHz	High channel	52.83	1.97	20.8

Body Tissue Simulate Measurement				
Frequency [MHz]	Description	Dielectric Parameters		Tissue Temp. [°C]
		ϵ_r	σ [s/m]	
5200MHz	Reference result ± 5% window	49 46.55 to 51.45	5.3 5.03 to 5.56	N/A
	11-June-15	49.18	5.31	19.8
5220 MHz	Low channel	49.12	5.33	19.8
5240 MHz	High channel	49.07	5.35	19.8

Body Tissue Simulate Measurement				
Frequency [MHz]	Description	Dielectric Parameters		Tissue Temp. [°C]
		ϵ_r	σ [s/m]	
5300MHz	Reference result ± 5% window	48.9 46.45 to 51.34	5.42 5.15 to 5.69	N/A
	11-June-15	48.92	5.45	19.8
5260 MHz	Low channel	49.01	5.39	19.8
5320 MHz	High channel	48.85	5.48	19.8

Body Tissue Simulate Measurement				
Frequency [MHz]	Description	Dielectric Parameters		Tissue Temp. [°C]
		ϵ_r	σ [s/m]	
5600MHz	Reference result ± 5% window	48.5 46.07 to 50.92	5.77 5.48 to 6.06	N/A
	11-June-15	48.11	5.91	19.8
5520 MHz	Low channel	48.36	5.75	19.8
5580 MHz	High channel	48.14	5.88	19.8

Body Tissue Simulate Measurement				
Frequency [MHz]	Description	Dielectric Parameters		Tissue Temp. [°C]
		ϵ_r	σ [s/m]	
5800MHz	Reference result ± 5% window	48.2 45.79 to 50.61	6 5.7 to 6.3	N/A
	11-June-15	47.52	6.21	19.8
5745 MHz	Low channel	47.73	6.13	19.8
5825 MHz	High channel	47.46	6.25	19.8

3.3 Tissue Dielectric Parameters for Head and Body Phantoms

The head tissue dielectric parameters recommended by the IEEE SCC-34/SC-2 in P1528 have been incorporated in the following table. These head parameters are derived from planar layer models simulating the highest expected SAR for the dielectric properties and tissue thickness variations in a human head. Other head and body tissue parameters that have not been specified in P1528 are derived from the tissue dielectric parameters computed from the 4-Cole-Cole equations described in Reference [12] and extrapolated according to the head parameters specified in P1528.

Target Frequency (MHz)	Head		Body	
	ϵ_r	σ (S/m)	ϵ_r	σ (S/m)
150	52.3	0.76	61.9	0.80
300	45.3	0.87	58.2	0.92
450	43.5	0.87	56.7	0.94
835	41.5	0.90	55.2	0.97
900	41.5	0.97	55.0	1.05
915	41.5	0.98	55.0	1.06
1450	40.5	1.20	54.0	1.30
1610	40.3	1.29	53.8	1.40
1800 – 2000	40.0	1.40	53.3	1.52
2450	39.2	1.80	52.7	1.95
3000	38.5	2.40	52.0	2.73
5800	35.3	5.27	48.2	6.00

(ϵ_r = relative permittivity, σ = conductivity and $\rho = 1000 \text{ kg/m}^3$)

4. SAR Measurement Procedure

4.1 SAR System Check

4.1.1 Dipoles

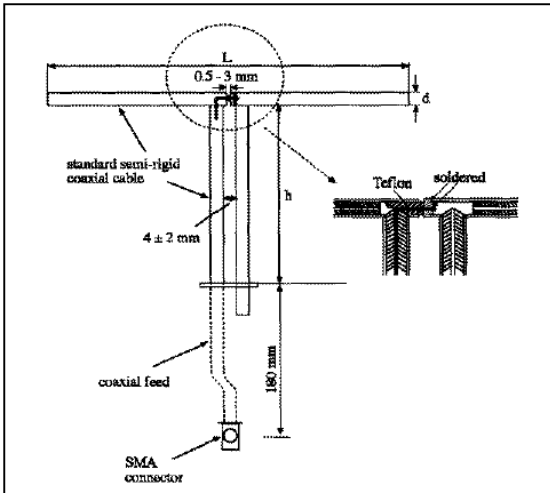

The dipoles used is based on the IEEE-1528 standard, and is complied with mechanical and electrical specifications in line with the requirements of both IEEE and FCC Supplement C. the table below provides details for the mechanical and electrical specifications for the dipoles.

Frequency	L (mm)	h (mm)	d (mm)
2450MHz	53.5	30.4	3.6
5200M~5800MHz	20.6	45.4	3.6

4.1.2 System Check Result

System Performance Check at 2450MHz 、 5200MHz ~ 5800MHz				
Dipole Kit: ALS-D-2450				
Frequency [MHz]	Description	SAR [w/kg] 1g	SAR [w/kg] 10g	Tissue Temp. [°C]
2450 MHz	Reference result ± 10% window	50.4 445.36 to 55.44	23.44 21.1 to 25.78	N/A
	10-June-15	52.8	24.24	20.8
Note: (1) The power level is used 250mW (2) All SAR values are normalized to 1W forward power. (3) The reference result is from Appendix E.				

System Performance Check at 5200MHz				
Dipole Kit: D5GHzV2				
Frequency [MHz]	Description	SAR [w/kg] 1g	SAR [w/kg] 10g	Tissue Temp. [°C]
5200 MHz	Reference result ± 10% window	74.3 66.87 to 81.73	20.8 18.72 to 22.88	N/A
	11-June-15	79.4	21.8	19.8
Note: (1) The power level is used 100mW (2) All SAR values are normalized to 1W forward power. (3) The reference result is from Appendix E.				

System Performance Check at 5300MHz				
Dipole Kit: D5GHzV2				
Frequency [MHz]	Description	SAR [w/kg] 1g	SAR [w/kg] 10g	Tissue Temp. [°C]
5300 MHz	Reference result ± 10% window	74.4 66.96 to 81.84	20.8 18.72 to 22.88	N/A
	11-June-15	74.8	20.3	19.8
Note: (1) The power level is used 100mW (2) All SAR values are normalized to 1W forward power. (3) The reference result is from Appendix E.				

System Performance Check at 5600MHz				
Dipole Kit: D5GHzV2				
Frequency [MHz]	Description	SAR [w/kg] 1g	SAR [w/kg] 10g	Tissue Temp. [°C]
5600 MHz	Reference result ± 10% window	79.1 71.19 to 87.01	21.9 19.71 to 24.09	N/A
	11-June-15	86.7	23.1	19.8
Note: (1) The power level is used 100mW (2) All SAR values are normalized to 1W forward power. (3) The reference result is from Appendix E.				

System Performance Check at 5800MHz				
Dipole Kit: D5GHzV2				
Frequency [MHz]	Description	SAR [w/kg] 1g	SAR [w/kg] 10g	Tissue Temp. [°C]
5800 MHz	Reference result ± 10% window	77.2 69.48 to 84.92	21.4 19.26 to 23.54	N/A
	11-June-15	78.8	21.5	19.8
Note: (1) The power level is used 100mW (2) All SAR values are normalized to 1W forward power. (3) The reference result is from Appendix E.				

4.2 SAR Measurement Procedure

The Dasy5 calculates SAR using the following equation,

$$SAR = \frac{\sigma |E|^2}{\rho}$$

σ : represents the simulated tissue conductivity

ρ : represents the tissue density

The EUT is set to transmit at the required power in line with product specification, at each frequency relating to the LOW, MID, and HIGH channel settings.

Pre-scans are made on the device to establish the location for the transmitting antenna, using a large area scan in either air or tissue simulation fluid.

The EUT is placed against the Universal Phantom where the maximum area scan dimensions are larger than the physical size of the resonating antenna. When the scan size is not large enough to cover the peak SAR distribution, it is modified by either extending the area scan size in both the X and Y directions, or the device is shifted within the predefined area.

The area scan is then run to establish the peak SAR location (interpolated resolution set at 1mm²) which is then used to orient the center of the zoom scan. The zoom scan is then executed and the 1g and 10g averages are derived from the zoom scan volume (interpolated resolution set at 1mm³).

5. SAR Exposure Limits

SAR assessments have been made in line with the requirements of IEEE-1528, FCC Supplement C, and comply with ANSI/IEEE C95.1-1992 “Uncontrolled Environments” limits. These limits apply to a location which is deemed as “Uncontrolled Environment” which can be described as a situation where the general public may be exposed to an RF source with no prior knowledge or control over their exposure.

Limits for General Population/Uncontrolled Exposure (W/kg)

Type Exposure	Uncontrolled Environment Limit
Spatial Peak SAR (1g cube tissue for brain or body)	1.60 W/kg
Spatial Average SAR (whole body)	0.08 W/kg
Spatial Peak SAR (10g for hands, feet, ankles and wrist)	4.00 W/kg

6. Test Equipment List

Instrument	Manufacturer	Model No.	Serial No.	Last Calibration	Next Calibration
Stäubli Robot TX60L	Stäubli	TX60L	F09/5BL1A1/A06	2009/05/18	only once
Controller	Speag	CS8c	N/A	2009/05/18	only once
Reference Dipole 2450MHz	Aprél	ALS-D-2450	QTK-319	2014/07/24	2016/07/23
Reference Dipole 5GHz	Speag	D5GHzV2	1041	2015/05/22	2016/05/21
SAM Twin Phantom	Speag	QD000 P40 CA	TP 1515	N/A	N/A
Device Holder	Speag	N/A	N/A	N/A	N/A
Data Acquisition Electronic	Speag	DAE4	1425	2014/11/13	2015/11/12
E-Field Probe	Speag	EX3DV4	3698	2014/07/25	2015/07/24
SAR Software	Speag	DASY52	V52.8 (8)	N/A	N/A
Aprél Dipole Spaccer	Aprél	ALS-DS-U	QTK-295	N/A	N/A
Power Amplifier	Mini-Circuit	ZHL-42	D051404-20	N/A	N/A
Directional Coupler	Agilent	778D-012	50550	N/A	N/A
Universal Radio Communication Tester	R&S	CMU200	104846	2014/07/05	2015/07/04
Vector Network	Agilent	E5071C	MY46108013	2015/03/30	2016/03/28
Signal Generator	Anritsu	MG3694A	041902	2014/08/06	2015/08/05
Power Meter	Anritsu	ML2495A	143004	2014/09/05	2015/09/04
Wide Bandwidth Sensor	Anritsu	MA2411B	1339194	2014/09/12	2015/09/11

7. Measurement Uncertainty

DASY5 Uncertainty(According to IEEE 1528-2013)								
Measurement uncertainty for 30 MHz to 3 GHz								
Error Description	Uncert. value	Prob. Dist.	Div.	(ci) 1g	(ci) 10g	Std. Unc. (1g)	Std. Unc. (10g)	(vi) Veff
Measurement System								
Probe Calibration	±6%	N	1	1	1	±6.0%	±6.0%	∞
Axial Isotropy	±4.7%	R	$\sqrt{3}$	0.7	0.7	±1.9%	±1.9%	∞
Hemispherical Isotropy	±9.6%	R	$\sqrt{3}$	0.7	0.7	±3.9%	±3.9%	∞
Boundary Effects	±1.0%	R	$\sqrt{3}$	1	1	±0.6%	±0.6%	∞
Linearity	±4.7%	R	$\sqrt{3}$	1	1	±2.7%	±2.7%	∞
System Detection Limits	±1.0%	R	$\sqrt{3}$	1	1	±0.6%	±0.6%	∞
Modulation Response	±2.4%	R	$\sqrt{3}$	1	1	±1.4%	±1.4%	∞
Readout Electronics	±0.3%	N	1	1	1	±0.3%	±0.3%	∞
Response Time	±0.8%	R	$\sqrt{3}$	1	1	±0.5%	±0.5%	∞
Integration Time	±2.6%	R	$\sqrt{3}$	1	1	±1.5%	±1.5%	∞
RF Ambient Noise	±3.0%	R	$\sqrt{3}$	1	1	±1.7%	±1.7%	∞
RF Ambient Reflections	±3.0%	R	$\sqrt{3}$	1	1	±1.7%	±1.7%	∞
Probe Positioner	±0.4%	R	$\sqrt{3}$	1	1	±0.2%	±0.2%	∞
Probe Positioning	±2.9%	R	$\sqrt{3}$	1	1	±1.7%	±1.7%	∞
Max. SAR Eval.	±4.0%	R	$\sqrt{3}$	1	1	±1.2%	±1.2%	∞
Test Sample Related								
Device Positioning	±2.9%	N	1	1	1	±2.9%	±2.9%	145
Device Holder	±3.6%	N	1	1	1	±3.6%	±3.6%	5
Power Drift	±5.0%	R	$\sqrt{3}$	1	1	±2.9%	±2.9%	∞
Power Scaling	±0%	R	$\sqrt{3}$	1	1	±0.0%	±0.0%	
Phantom and Setup								
Phantom Uncertainty	±6.1%	R	$\sqrt{3}$	1	1	±3.5%	±3.5%	∞
SAR correction	±1.9%	R	$\sqrt{3}$	1	0.84	±1.1%	±0.9%	∞
Liquid Conductivity (meas.)	±2.5%	R	$\sqrt{3}$	0.78	0.71	±1.1%	±1.0%	∞
Liquid Permittivity (meas.)	±2.5%	R	$\sqrt{3}$	0.26	0.26	±0.3%	±0.4%	∞
Temp. unc. - Conductivity	±3.4%	R	$\sqrt{3}$	0.78	0.71	±1.5%	±1.4%	∞
Temp. unc. - Permittivity	±0.4%	R	$\sqrt{3}$	0.23	0.26	±0.1%	±0.1%	∞
Combined Std. Uncertainty						±11.2%	±11.1%	361
Expanded STD Uncertainty						±22.3%	±22.2%	

DASY5 Uncertainty(According to IEEE 1528-2013) Measurement uncertainty for 3GHz to 6 GHz								
Error Description	Uncert. value	Prob. Dist.	Div.	(ci) 1g	(ci) 10g	Std. Unc. (1g)	Std. Unc. (10g)	(vi) V _{eff}
Measurement System								
Probe Calibration	±6.55%	N	1	1	1	±6.55%	±6.55%	∞
Axial Isotropy	±4.7%	R	√3	0.7	0.7	±1.9%	±1.9%	∞
Hemispherical Isotropy	±9.6%	R	√3	0.7	0.7	±3.9%	±3.9%	∞
Boundary Effects	±2.0%	R	√3	1	1	±1.2%	±1.2%	∞
Linearity	±4.7%	R	√3	1	1	±2.7%	±2.7%	∞
System Detection Limits	±1.0%	R	√3	1	1	±0.6%	±0.6%	∞
Modulation Response	±2.4%	R	√3	1	1	±1.4%	±1.4%	∞
Readout Electronics	±0.3%	N	1	1	1	±0.3%	±0.3%	∞
Response Time	±0.8%	R	√3	1	1	±0.5%	±0.5%	∞
Integration Time	±2.6%	R	√3	1	1	±1.5%	±1.5%	∞
RF Ambient Noise	±3.0%	R	√3	1	1	±1.7%	±1.7%	∞
RF Ambient Reflections	±3.0%	R	√3	1	1	±1.7%	±1.7%	∞
Probe Positioner	±0.8%	R	√3	1	1	±0.5%	±0.5%	∞
Probe Positioning	±6.7%	R	√3	1	1	±3.9%	±3.9%	∞
Post-processing	±4.0%	R	√3	1	1	±2.3%	±2.3%	∞
Test Sample Related								
Device Positioning	±2.9%	N	1	1	1	±2.9%	±2.9%	145
Device Holder	±3.6%	N	1	1	1	±3.6%	±3.6%	5
Power Drift	±5.0%	R	√3	1	1	±2.9%	±2.9%	∞
Power Scaling	±0%	R	√3	1	1	±0.0%	±0.0%	
Phantom and Setup								
Phantom Uncertainty	±6.6%	R	√3	1	1	±3.8%	±3.8%	∞
SAR correction	±1.9%	R	√3	1	1	±1.1%	±0.9%	∞
Liquid Conductivity (meas.)	±2.5%	R	√3	1	0.84	±1.1%	±1.0%	∞
Liquid Permittivity (meas.)	±2.5%	R	√3	0.26	0.26	±0.3%	±0.4%	∞
Temp. unc. - Conductivity	±3.4%	R	√3	0.78	0.71	±1.5%	±1.4%	∞
Temp. unc. - Permittivity	±0.4%	R	√3	0.23	0.26	±0.1%	±0.1%	∞
Combined Std. Uncertainty						±12.3%	±12.2%	748
Expanded STD Uncertainty						±24.6%	±24.5%	

8. Conducted Power Measurement

Mode	BW	15.247 (2.4GHz)			U-NII-1 (5150~5250MHz)			U-NII-2A (5250~5350MHz)			U-NII-2C (5470~5725MHz)			U-NII-3 (5725~5850MHz)			
		CH	Target	Power	CH	Target	Power	CH	Target	Power	CH	Target	Power	CH	Target	Power	
DSSS/OFDM mode specified maximum output power at an antenna port	b	20	1	14	13.64												
			6	14	13.95												
			11	14	13.8												
	g	20	1	14	13.98												
			6	14	13.83												
			11	14	13.98												
	a	20				36	14.5	14.29	52	14.5	14.22	100	14.5	14.48	132	14.5	13.89
						40	14.5	14.12	56	14.5	14.23	108	14.5	14.32	149	14.5	13.77
						44	14.5	14.57	60	14.5	14.47	116	14.5	14.29	165	14.5	14.02
						48	14.5	14.36	64	14.5	14.58	128	14.5	14.45			
	n(HT)	20	1	14	13.84	36	14.5	14.3	52	14.5	14.23	100	14.5	14.54	132	14.5	14.31
			6	14	13.64	40	14.5	14.32	56	14.5	14.34	108	14.5	14.35	149	14.5	14.06
11			14	13.92	44	14.5	14.53	60	14.5	14.24	116	14.5	14.53	165	14.5	13.97	
					48	14.5	14.35	64	14.5	14.55	128	14.5	14.43				
Bluetooth	Normal	GFSK	0	0	-1.79												
			39	0	-1.61												
			78	0	-1.38												
	EDR	8DPSK	0	0	-3.31												
			39	0	-3.13												
			78	0	-2.92												
	BLE	GFSK	0	0	-1.13												
			19	0	-0.84												
			39	0	-0.59												

9. Test Results

9.1 SAR Test Results Summary

SAR MEASUREMENT								
Ambient Temperature (°C) : 22.1 ±2				Relative Humidity (%) : 48				
Liquid Temperature (°C) : 20.8 ±2				Depth of Liquid (cm) : >15				
Test Mode: 802.11b - 2450 MHz								
Test Position Body	Antenna Position	Frequency		Conducted Power (dBm)		SAR 1g (W/kg)		Limit (W/kg)
		Channel	MHz	Measurement	Tune-up Limit	Measurement	Tune-up Scaled	
Bottom	Fixed	1	2412	13.64	14	0.116	0.126	1.6
Bottom	Fixed	6	2437	13.95	14	0.152	0.154	1.6
Bottom	Fixed	11	2462	13.80	14	0.147	0.154	1.6
Top	Fixed	6	2437	13.95	14	0.0000181	0.000	1.6
Back	Fixed	6	2437	13.95	14	0.047	0.048	1.6
Left-Side	Fixed	6	2437	13.95	14	0.046	0.047	1.6

Note : 1. According KDB 447498 D01, SAR can be excluded when test exclusion thresholds are applicable.(can refer P6) .
2. When the highest reported SAR for DSSS is adjusted by the ratio of OFDM to DSSS specified maximum output power and the adjusted SAR is ≤ 1.2 W/kg. SAR is not required
3. The duty cycle has almost 100% in SAR measurement.

SAR MEASUREMENT								
Ambient Temperature (°C) : 21.9 ±2				Relative Humidity (%) : 51				
Liquid Temperature (°C) : 19.8 ±2				Depth of Liquid (cm) : >15				
Test Mode: 802.11a - 5 GHz								
Test Position Body	Antenna Position	Frequency		Conducted Power (dBm)		SAR 1g (W/kg)		Limit (W/kg)
		Channel	MHz	Measurement	Tune-up Limit	Measurement	Tune-up Scaled	
Top	Fixed	36	5180	14.29	14.50	0.169	0.177	1.6
Top	Fixed	44	5220	14.57	14.50	0.165	0.165	1.6
Top	Fixed	48	5240	14.36	14.50	0.151	0.156	1.6
Top	Fixed	52	5260	14.22	14.50	0.146	0.156	1.6
Top	Fixed	60	5300	14.58	14.50	0.150	0.147	1.6
Top	Fixed	64	5320	14.48	14.50	0.160	0.161	1.6
Top	Fixed	100	5500	14.48	14.50	0.215	0.216	1.6
Top	Fixed	116	5580	14.32	14.50	0.221	0.230	1.6
Top	Fixed	149	5745	13.77	14.50	0.133	0.157	1.6
Top	Fixed	165	5825	14.02	14.50	0.117	0.013	1.6
Bottom	Fixed	64	5320	14.58	14.50	0.00701	0.007	1.6
Back	Fixed	64	5320	14.58	14.50	0.069	0.069	1.6
Left-Side	Fixed	64	5320	14.58	14.50	0.033	0.033	1.6

Note : 1. According KDB 447498 D01, SAR can be excluded when test exclusion thresholds are applicable.(can refer P6)
2. When multiple transmission modes (802.11 n) have the same specified maximum output power, largest channel bandwidth, lowest order modulation and lowest data rate, the lowest order 802.11 mode is selected
3. The duty cycle has almost 100% in SAR measurement.

9.2 Simultaneous Transmission

According the KDB 447498 D01 Section 4.3.2, the standalone SAR must be estimated according to the following to determine simultaneous transmission SAR test exclusion

$$(max. power of channel, mW)/(min. test separation distance, mm) \cdot [\sqrt{f(GHz)}/7.5]$$

Frequency	Max. power (dBm)	Test separation distance ,(mm)	Estimated BT SAR (W/Kg)
N/A	N/A	N/A	N/A

When the sum of SAR is larger than the limit, The ratio is determined by $(SAR1 + SAR2)^{1.5/R_i}$, rounded to two decimal digits, and must be ≤ 0.04 for all antenna pairs in the configuration to qualify for 1-g SAR test exclusion . The estimation result as below :

For UNII Band :

WLAN SAR (W/Kg)	BT SAR (W/Kg)	Simultaneous Transmission (W/Kg)	Antenna pair in mm	Peak location separation ratio
N/A	N/A	N/A	N/A	N/A

BT & WLAN can't work simultaneously, thus simultaneous mode is no need.

For DTS Band :

WLAN SAR (W/Kg)	Estimated BT SAR (W/Kg)	Simultaneous Transmission (W/Kg)	Antenna pair in mm	Peak location separation ratio
N/A	N/A	N/A	N/A	N/A

The sum of value is less than 1.6W/Kg, thus simultaneous SAR testing is no need.

10. SAR measurement variability

- 1) Repeated measurement is not required when the original highest measured SAR is < 0.80 W/kg; steps 2) through 4) do not apply.
- 2) When the original highest measured SAR is ≥ 0.80 W/kg, repeat that measurement once.
- 3) Perform a second repeated measurement only if the ratio of largest to smallest SAR for the original and first repeated measurements is > 1.20 or when the original or repeated measurement is ≥ 1.45 W/kg (~ 10% from the 1-g SAR limit).
- 4) Perform a third repeated measurement only if the original, first or second repeated measurement is ≥ 1.5 W/kg and the ratio of largest to smallest SAR for the original, first and second repeated measurements is > 1.20.

Frequency		SAR 1g (W/kg)						
Channel	MHz	Original	First Repeated		Second Repeated		Third Repeated	
			Value	Ratio	Value	Ratio	Value	Ratio
N/A	N/A	N/A	N/A	N/A	N/A	N/A	N/A	N/A
N/A	N/A	N/A	N/A	N/A	N/A	N/A	N/A	N/A

Appendix

Appendix A. SAR System Check Data

Appendix B. SAR measurement Data

Appendix C. Test Setup Photographs & EUT Photographs

Appendix D. Probe Calibration Data

Appendix E. Dipole Calibration Data

Appendix A. SAR System Check Data

Test Laboratory: QuieTek

Date/Time: 2015/6/10

System Performance Check_2450MHz-Body

DUT: Dipole 2450 MHz; Type: ALS-D-2450

Communication System: UID 10000, CW; Frequency: 2450 MHz;

Communication System PAR: 0 dB

Medium parameters used: $f = 2450$ MHz; $\sigma = 1.95$ S/m; $\epsilon_r = 52.87$; $\rho = 1000$ kg/m³

Phantom section: Flat Section

Ambient Temperature (°C) : 22.1, Liquid Temperature (°C) : 20.8

Measurement Standard: DASYS (IEEE/IEC/ANSI C63.19-2007)

DASY5 Configuration:

- Probe: EX3DV4 - SN3979; ConvF(7.08, 7.08, 7.08); Calibrated: 2014/11/21;
- Sensor-Surface: 3mm (Mechanical Surface Detection)
- Electronics: DAE4 Sn1425; Calibrated: 2014/11/13
- Phantom: SAM with left table; Type: SAM;
- Measurement SW: DASYS2, Version 52.8 (8); SEMCAD X Version 14.6.10 (7331)

Configuration/2450MHz_Body/Area Scan (8x9x1): Measurement grid: dx=12mm, dy=12mm

Maximum value of SAR (measured) = 15.7 W/kg

Configuration/2450MHz_Body/Zoom Scan (7x7x7) (7x7x7)/Cube 0:

Measurement grid: dx=5mm, dy=5mm, dz=5mm

Reference Value = 85.87 V/m; Power Drift = 0.05 dB

Peak SAR (extrapolated) = 27.4 W/kg

SAR(1 g) = 13.2 W/kg; SAR(10 g) = 6.06 W/kg

Maximum value of SAR (measured) = 17.6 W/kg

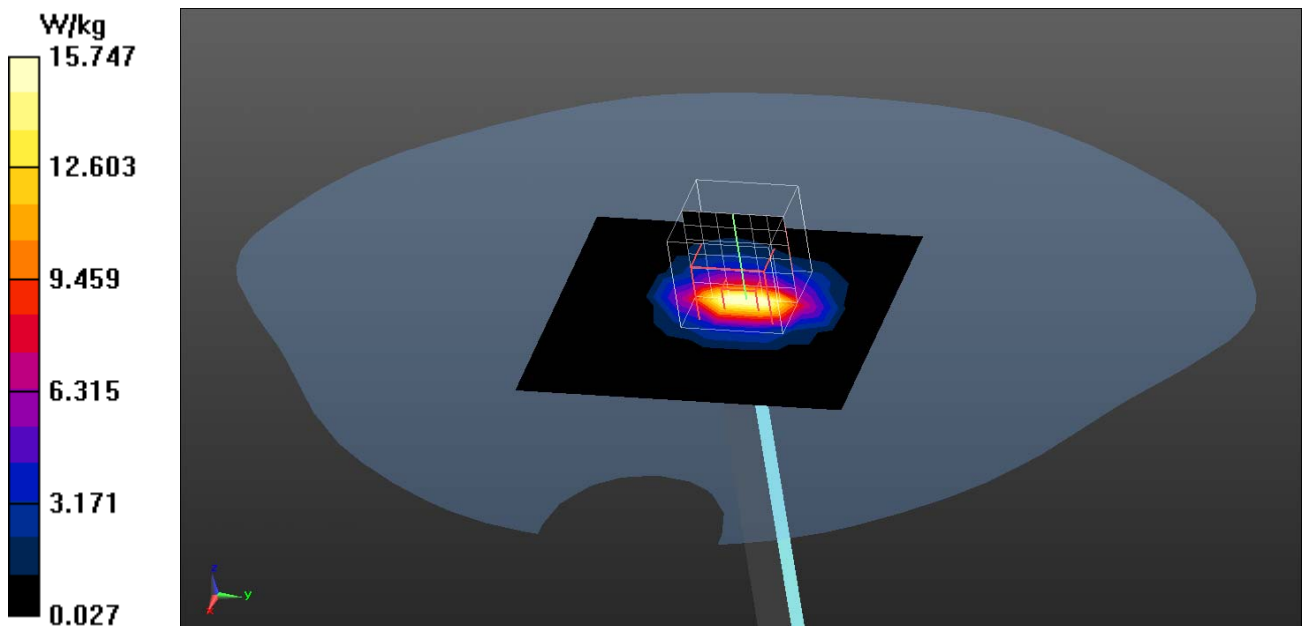

Test Laboratory: QuieTek

Date/Time: 2015/6/11

System Performance Check_5200MHz-Body

DUT: Dipole 5GHz; Type: D5GHzV2

Communication System: UID 0, WLAN 5G; Frequency: 5200 MHz;

Communication System PAR: 0 dB

Medium parameters used: $f = 5200$ MHz; $\sigma = 5.31$ S/m; $\epsilon_r = 49.18$; $\rho = 1000$ kg/m³

Phantom section: Flat Section

Ambient Temperature (°C) : 21.9, Liquid Temperature (°C) : 19.8

Measurement Standard: DASY5 (IEEE/IEC/ANSI C63.19-2007)

DASY5 Configuration:

- Probe: EX3DV4 - SN3979; ConvF(4.6, 4.6, 4.6); Calibrated: 2014/11/21;
- Sensor-Surface: 1.4mm (Mechanical Surface Detection)
- Electronics: DAE4 Sn1425; Calibrated: 2014/11/13
- Phantom: SAM with left table; Type: SAM;
- Measurement SW: DASY52, Version 52.8 (8); SEMCAD X Version 14.6.10 (7331)

Configuration/5200MHz-Body 100mW/Area Scan (8x8x1): Measurement grid:

$dx=10$ mm, $dy=10$ mm

Maximum value of SAR (measured) = 13.7 W/kg

Configuration/5200MHz-Body 100mW/Zoom Scan (7x7x12), dist=2mm

(7x7x12)/Cube 0: Measurement grid: $dx=4$ mm, $dy=4$ mm, $dz=2$ mm

Reference Value = 63.41 V/m; Power Drift = -0.05 dB

Peak SAR (extrapolated) = 33.1 W/kg

SAR(1 g) = 7.94 W/kg; SAR(10 g) = 2.18 W/kg

Maximum value of SAR (measured) = 19.3 W/kg

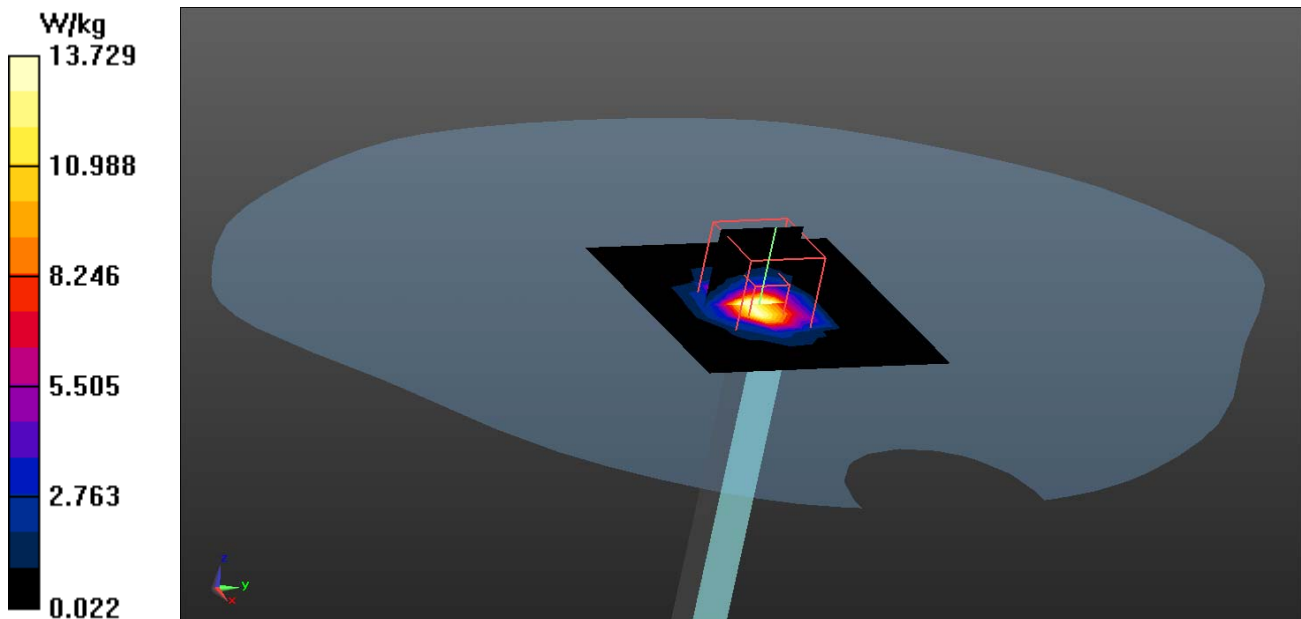

Test Laboratory: QuieTek

Date/Time: 2015/6/11

System Performance Check_5300MHz-Body

DUT: Dipole 5GHz; Type: D5GHzV2

Communication System: UID 0, CW; Frequency: 5300 MHz;

Communication System PAR: 0 dB

Medium parameters used: $f = 5300$ MHz; $\sigma = 5.45$ S/m; $\epsilon_r = 48.92$; $\rho = 1000$ kg/m³

Phantom section: Flat Section

Ambient Temperature (°C) : 21.9, Liquid Temperature (°C) : 19.8

Measurement Standard: DASYS (IEEE/IEC/ANSI C63.19-2007)

DASY5 Configuration:

- Probe: EX3DV4 - SN3979; ConvF(4.42, 4.42, 4.42); Calibrated: 2014/11/21;
- Sensor-Surface: 1.4mm (Mechanical Surface Detection)
- Electronics: DAE4 Sn1425; Calibrated: 2014/11/13
- Phantom: SAM with left table; Type: SAM;
- Measurement SW: DASYS2, Version 52.8 (8); SEMCAD X Version 14.6.10 (7331)

Configuration/5300MHz-Body 100mW/Area Scan (8x8x1): Measurement grid:

$dx=10$ mm, $dy=10$ mm

Maximum value of SAR (measured) = 13.7 W/kg

Configuration/5300MHz-Body 100mW/Zoom Scan (7x7x12), dist=2mm

(7x7x12)/Cube 0: Measurement grid: $dx=4$ mm, $dy=4$ mm, $dz=2$ mm

Reference Value = 54.48 V/m; Power Drift = -0.01 dB

Peak SAR (extrapolated) = 32.6 W/kg

SAR(1 g) = 7.48 W/kg; SAR(10 g) = 2.03 W/kg

Maximum value of SAR (measured) = 18.9 W/kg

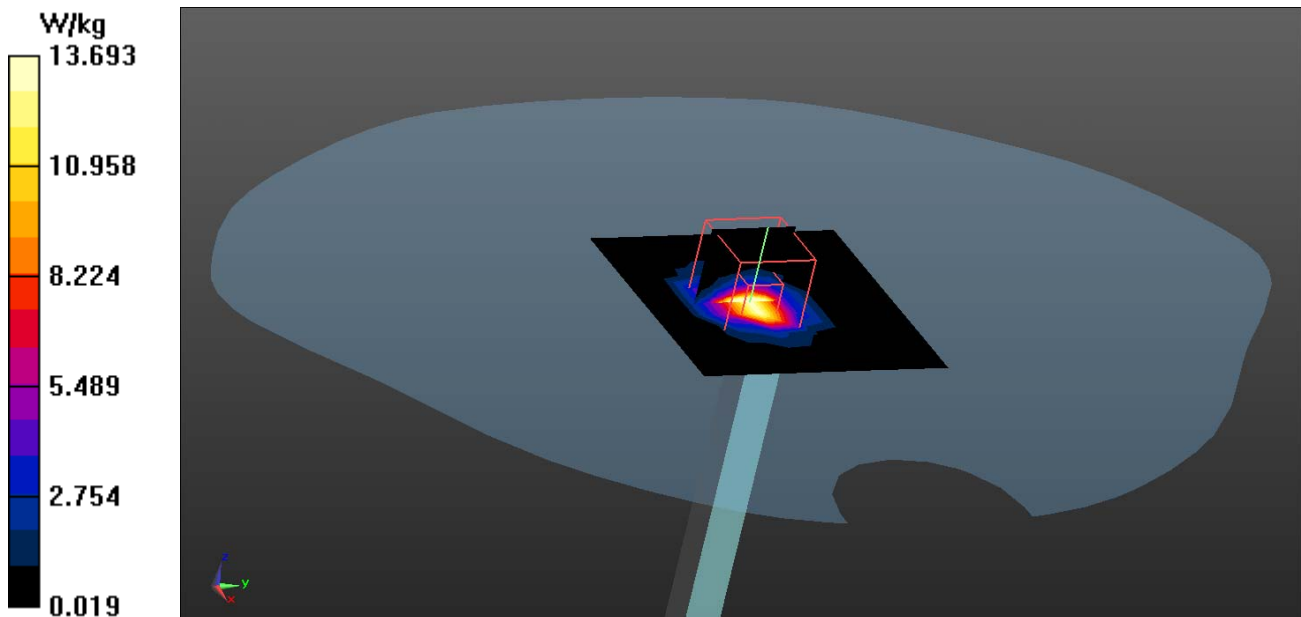

Test Laboratory: QuieTek

Date/Time: 2015/6/11

System Performance Check_5600MHz-Body

DUT: Dipole 5GHz; Type: D5GHzV2

Communication System: UID 0, CW; Frequency: 5600 MHz;

Communication System PAR: 0 dB

Medium parameters used: $f = 5600$ MHz; $\sigma = 5.91$ S/m; $\epsilon_r = 48.11$; $\rho = 1000$ kg/m³

Phantom section: Flat Section

Ambient Temperature (°C) : 21.9, Liquid Temperature (°C) : 19.8

Measurement Standard: DASY5 (IEEE/IEC/ANSI C63.19-2007)

DASY5 Configuration:

- Probe: EX3DV4 - SN3979; ConvF(4.01, 4.01, 4.01); Calibrated: 2014/11/21;
- Sensor-Surface: 1.4mm (Mechanical Surface Detection)
- Electronics: DAE4 Sn1425; Calibrated: 2014/11/13
- Phantom: SAM with left table; Type: SAM;
- Measurement SW: DASY52, Version 52.8 (8); SEMCAD X Version 14.6.10 (7331)

Configuration/5600MHz-Body 100mW/Area Scan (8x8x1): Measurement grid:

$dx=10$ mm, $dy=10$ mm

Maximum value of SAR (measured) = 17.4 W/kg

Configuration/5600MHz-Body 100mW/Zoom Scan (7x7x12), dist=2mm

(7x7x12)/Cube 0: Measurement grid: $dx=4$ mm, $dy=4$ mm, $dz=2$ mm

Reference Value = 61.70 V/m; Power Drift = -0.15 dB

Peak SAR (extrapolated) = 39.2 W/kg

SAR(1 g) = 8.67 W/kg; SAR(10 g) = 2.31 W/kg

Maximum value of SAR (measured) = 22.6 W/kg

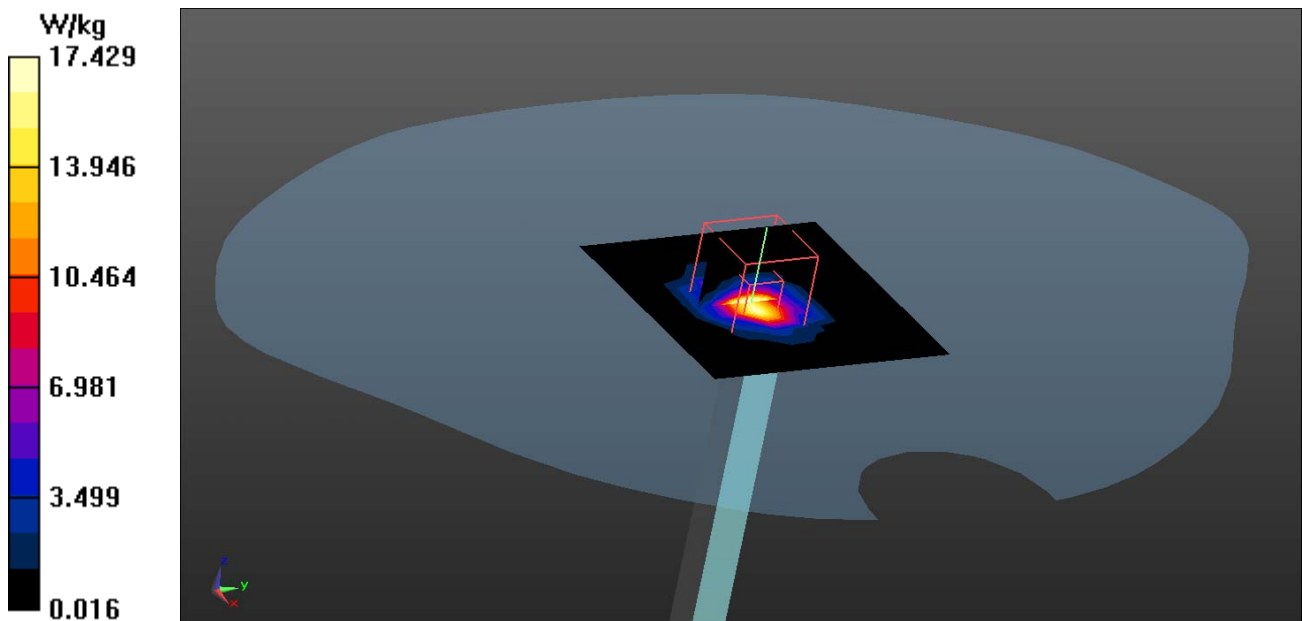

Test Laboratory: QuieTek

Date/Time: 2015/6/11

System Performance Check_5800MHz-Body

DUT: Dipole 5GHz; Type: D5GHzV2

Communication System: UID 0, CW; Frequency: 5800 MHz;

Communication System PAR: 0 dB

Medium parameters used: $f = 5800$ MHz; $\sigma = 6.21$ S/m; $\epsilon_r = 47.52$; $\rho = 1000$ kg/m³

Phantom section: Flat Section

Ambient Temperature (°C) : 21.9, Liquid Temperature (°C) : 19.8

Measurement Standard: DASY5 (IEEE/IEC/ANSI C63.19-2007)

DASY5 Configuration:

- Probe: EX3DV4 - SN3979; ConvF(4.18, 4.18, 4.18); Calibrated: 2014/11/21;
- Sensor-Surface: 1.4mm (Mechanical Surface Detection)
- Electronics: DAE4 Sn1425; Calibrated: 2014/11/13
- Phantom: SAM with left table; Type: SAM;
- Measurement SW: DASY52, Version 52.8 (8); SEMCAD X Version 14.6.10 (7331)

Configuration/5800MHz-Body 100mW/Area Scan (8x8x1): Measurement grid:

$dx=10$ mm, $dy=10$ mm

Maximum value of SAR (measured) = 15.1 W/kg

Configuration/5800MHz-Body 100mW/Zoom Scan (7x7x12), dist=2mm

(7x7x12)/Cube 0: Measurement grid: $dx=4$ mm, $dy=4$ mm, $dz=2$ mm

Reference Value = 53.43 V/m; Power Drift = -0.08 dB

Peak SAR (extrapolated) = 36.0 W/kg

SAR(1 g) = 7.88 W/kg; SAR(10 g) = 2.15 W/kg

Maximum value of SAR (measured) = 20.2 W/kg

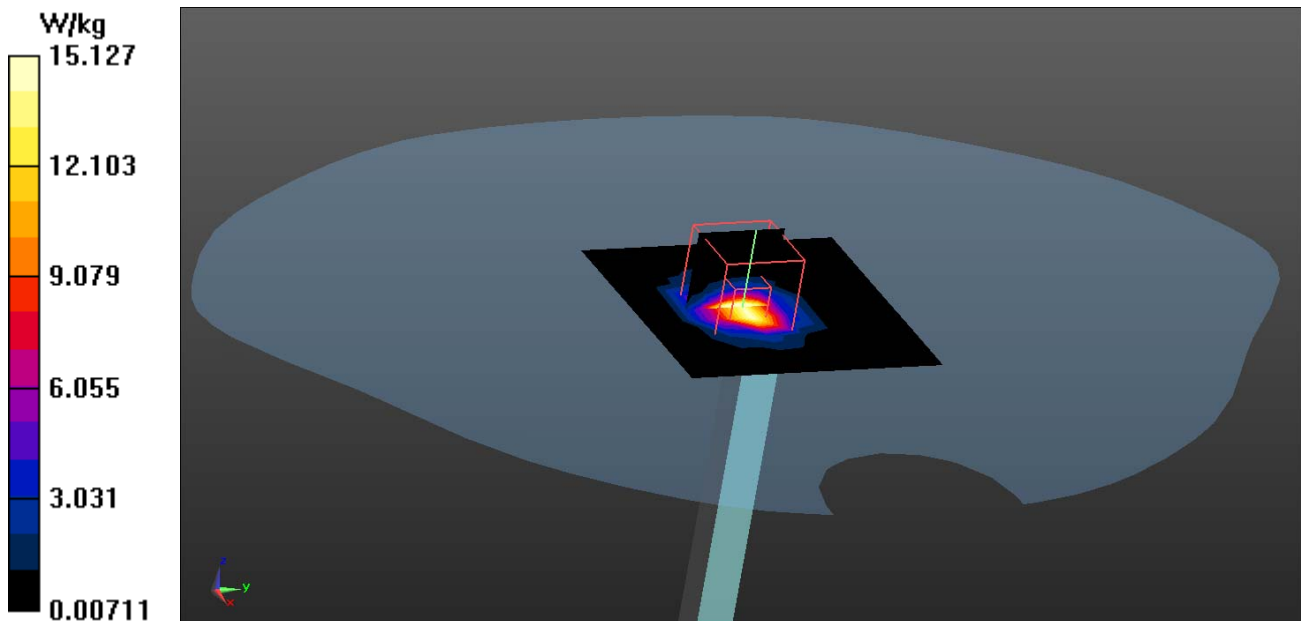

Appendix B. SAR measurement Data

Test Laboratory: QuieTek

Date/Time: 2015/6/10

802.11b_1-Bottom

DUT: TABLET PC; Type: PA-501

Communication System: UID 0, WLAN 2.4G; Frequency: 2412 MHz;

Communication System PAR: 0 dB

Medium parameters used: $f = 2412$ MHz; $\sigma = 1.89$ S/m; $\epsilon_r = 53.02$; $\rho = 1000$ kg/m³

Phantom section: Flat Section

Ambient Temperature (°C) : 22.1, Liquid Temperature (°C) : 20.8

Measurement Standard: DASYS (IEEE/IEC/ANSI C63.19-2007)

DASY5 Configuration:

- Probe: EX3DV4 - SN3979; ConvF(7.08, 7.08, 7.08); Calibrated: 2014/11/21;
- Sensor-Surface: 3mm (Mechanical Surface Detection)
- Electronics: DAE4 Sn1425; Calibrated: 2014/11/13
- Phantom: SAM with left table; Type: SAM;
- Measurement SW: DASYS2, Version 52.8 (8); SEMCAD X Version 14.6.10 (7331)

Configuration/Body/Area Scan (7x11x1): Measurement grid: dx=12mm, dy=12mm
Maximum value of SAR (measured) = 0.133 W/kg

Configuration/Body/Zoom Scan (5x5x7) (5x5x7)/Cube 0: Measurement grid:
dx=8mm, dy=8mm, dz=5mm
Reference Value = 2.851 V/m; Power Drift = -0.06 dB
Peak SAR (extrapolated) = 0.224 W/kg
SAR(1 g) = 0.116 W/kg; SAR(10 g) = 0.056 W/kg
Maximum value of SAR (measured) = 0.150 W/kg

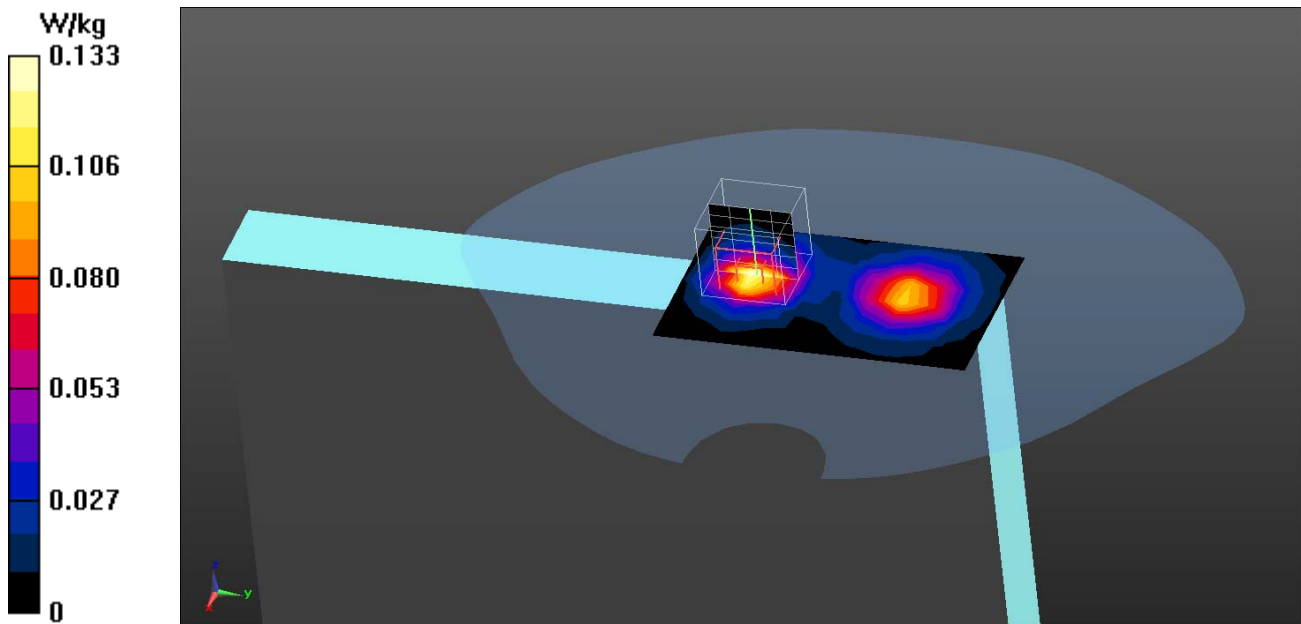

Test Laboratory: QuieTek

Date/Time: 2015/6/10

802.11b_6-Bottom

DUT: TABLET PC; Type: PA-501

Communication System: UID 0, WLAN 2.4G; Frequency: 2437 MHz;

Communication System PAR: 0 dB

Medium parameters used: $f = 2437$ MHz; $\sigma = 1.93$ S/m; $\epsilon_r = 52.94$; $\rho = 1000$ kg/m³

Phantom section: Flat Section

Ambient Temperature (°C) : 22.1, Liquid Temperature (°C) : 20.8

Measurement Standard: DASYS (IEEE/IEC/ANSI C63.19-2007)

DASY5 Configuration:

- Probe: EX3DV4 - SN3979; ConvF(7.08, 7.08, 7.08); Calibrated: 2014/11/21;
- Sensor-Surface: 3mm (Mechanical Surface Detection)
- Electronics: DAE4 Sn1425; Calibrated: 2014/11/13
- Phantom: SAM with left table; Type: SAM;
- Measurement SW: DASYS2, Version 52.8 (8); SEMCAD X Version 14.6.10 (7331)

Configuration/Body/Area Scan (7x11x1): Measurement grid: dx=12mm, dy=12mm

Maximum value of SAR (measured) = 0.173 W/kg

Configuration/Body/Zoom Scan (5x5x7) (5x5x7)/Cube 0: Measurement grid:

dx=8mm, dy=8mm, dz=5mm

Reference Value = 3.013 V/m; Power Drift = 0.15 dB

Peak SAR (extrapolated) = 0.288 W/kg

SAR(1 g) = 0.152 W/kg; SAR(10 g) = 0.072 W/kg

Maximum value of SAR (measured) = 0.195 W/kg

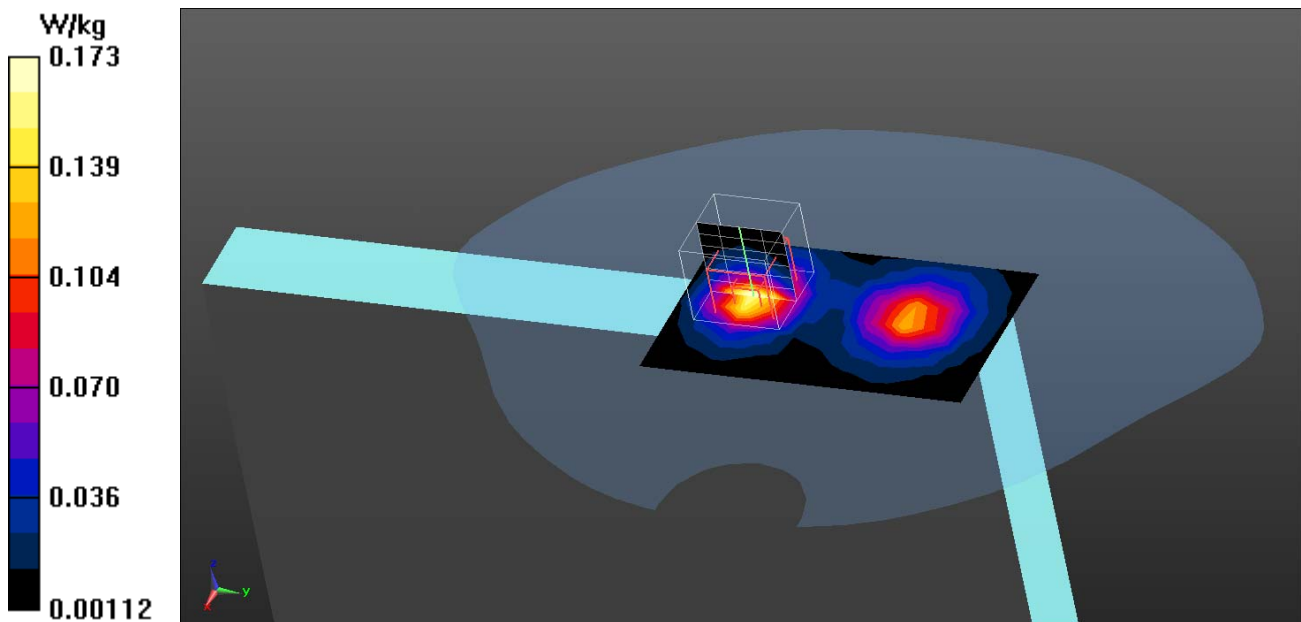

Test Laboratory: QuieTek

Date/Time: 2015/6/10

802.11b_11-Bottom

DUT: TABLET PC; Type: PA-501

Communication System: UID 0, WLAN 2.4G; Frequency: 2462 MHz;

Communication System PAR: 0 dB

Medium parameters used: $f = 2462$ MHz; $\sigma = 1.97$ S/m; $\epsilon_r = 52.83$; $\rho = 1000$ kg/m³

Phantom section: Flat Section

Ambient Temperature (°C) : 22.1, Liquid Temperature (°C) : 20.8

Measurement Standard: DASYS (IEEE/IEC/ANSI C63.19-2007)

DASY5 Configuration:

- Probe: EX3DV4 - SN3979; ConvF(7.08, 7.08, 7.08); Calibrated: 2014/11/21;
- Sensor-Surface: 3mm (Mechanical Surface Detection)
- Electronics: DAE4 Sn1425; Calibrated: 2014/11/13
- Phantom: SAM with left table; Type: SAM;
- Measurement SW: DASYS2, Version 52.8 (8); SEMCAD X Version 14.6.10 (7331)

Configuration/Body/Area Scan (7x11x1): Measurement grid: dx=12mm, dy=12mm
Maximum value of SAR (measured) = 0.174 W/kg

Configuration/Body/Zoom Scan (5x5x7) (5x5x7)/Cube 0: Measurement grid:
dx=8mm, dy=8mm, dz=5mm
Reference Value = 2.988 V/m; Power Drift = 0.14 dB
Peak SAR (extrapolated) = 0.290 W/kg
SAR(1 g) = 0.147 W/kg; SAR(10 g) = 0.070 W/kg
Maximum value of SAR (measured) = 0.193 W/kg

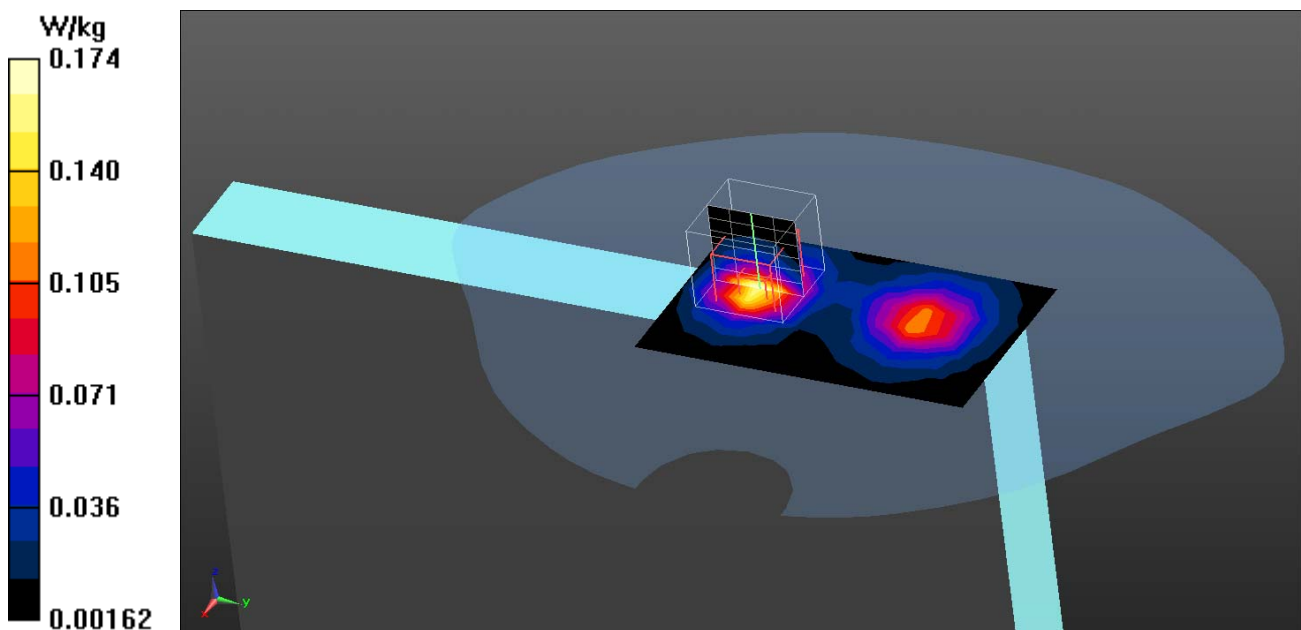

Test Laboratory: QuieTek

Date/Time: 2015/6/10

802.11b_6-Top

DUT: TABLET PC; Type: PA-501

Communication System: UID 0, WLAN 2.4G; Frequency: 2437 MHz;

Communication System PAR: 0 dB

Medium parameters used: $f = 2437$ MHz; $\sigma = 1.93$ S/m; $\epsilon_r = 52.94$; $\rho = 1000$ kg/m³

Phantom section: Flat Section

Ambient Temperature (°C) : 22.1, Liquid Temperature (°C) : 20.8

Measurement Standard: DASY5 (IEEE/IEC/ANSI C63.19-2007)

DASY5 Configuration:

- Probe: EX3DV4 - SN3979; ConvF(7.08, 7.08, 7.08); Calibrated: 2014/11/21;
- Sensor-Surface: 3mm (Mechanical Surface Detection)
- Electronics: DAE4 Sn1425; Calibrated: 2014/11/13
- Phantom: SAM with left table; Type: SAM;
- Measurement SW: DASY52, Version 52.8 (8); SEMCAD X Version 14.6.10 (7331)

Configuration/Body/Area Scan (8x11x1): Measurement grid: dx=12mm, dy=12mm

Maximum value of SAR (measured) = 0.000738 W/kg

Configuration/Body/Zoom Scan (5x5x7) (5x5x7)/Cube 0: Measurement grid:

dx=8mm, dy=8mm, dz=5mm

Reference Value = 0.4210 V/m; Power Drift = -0.09 dB

Peak SAR (extrapolated) = 0.00114 W/kg

SAR(1 g) = 1.81e-005 W/kg; SAR(10 g) = 3.75e-006 W/kg

Maximum value of SAR (measured) = 0.00127 W/kg

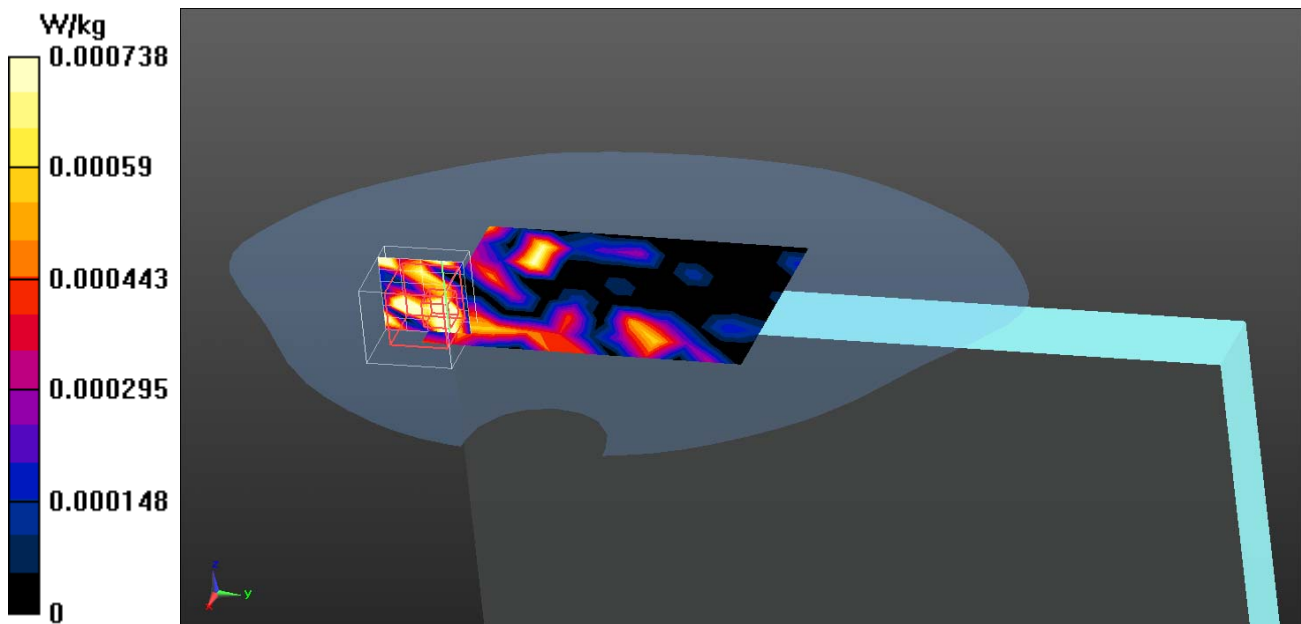

Test Laboratory: QuieTek

Date/Time: 2015/6/10

802.11b_6-Back

DUT: TABLET PC; Type: PA-501

Communication System: UID 0, WLAN 2.4G; Frequency: 2437 MHz;

Communication System PAR: 0 dB

Medium parameters used: $f = 2437$ MHz; $\sigma = 1.93$ S/m; $\epsilon_r = 52.94$; $\rho = 1000$ kg/m³

Phantom section: Flat Section

Ambient Temperature (°C) : 22.1, Liquid Temperature (°C) : 20.8

Measurement Standard: DASY5 (IEEE/IEC/ANSI C63.19-2007)

DASY5 Configuration:

- Probe: EX3DV4 - SN3979; ConvF(7.08, 7.08, 7.08); Calibrated: 2014/11/21;
- Sensor-Surface: 3mm (Mechanical Surface Detection)
- Electronics: DAE4 Sn1425; Calibrated: 2014/11/13
- Phantom: SAM with left table; Type: SAM;
- Measurement SW: DASY52, Version 52.8 (8); SEMCAD X Version 14.6.10 (7331)

Configuration/Body/Area Scan (9x13x1): Measurement grid: dx=12mm, dy=12mm

Maximum value of SAR (measured) = 0.0580 W/kg

Configuration/Body/Zoom Scan (5x5x7) (5x5x7)/Cube 0: Measurement grid:

dx=8mm, dy=8mm, dz=5mm

Reference Value = 5.483 V/m; Power Drift = -0.10 dB

Peak SAR (extrapolated) = 0.0850 W/kg

SAR(1 g) = 0.047 W/kg; SAR(10 g) = 0.026 W/kg

Maximum value of SAR (measured) = 0.0589 W/kg

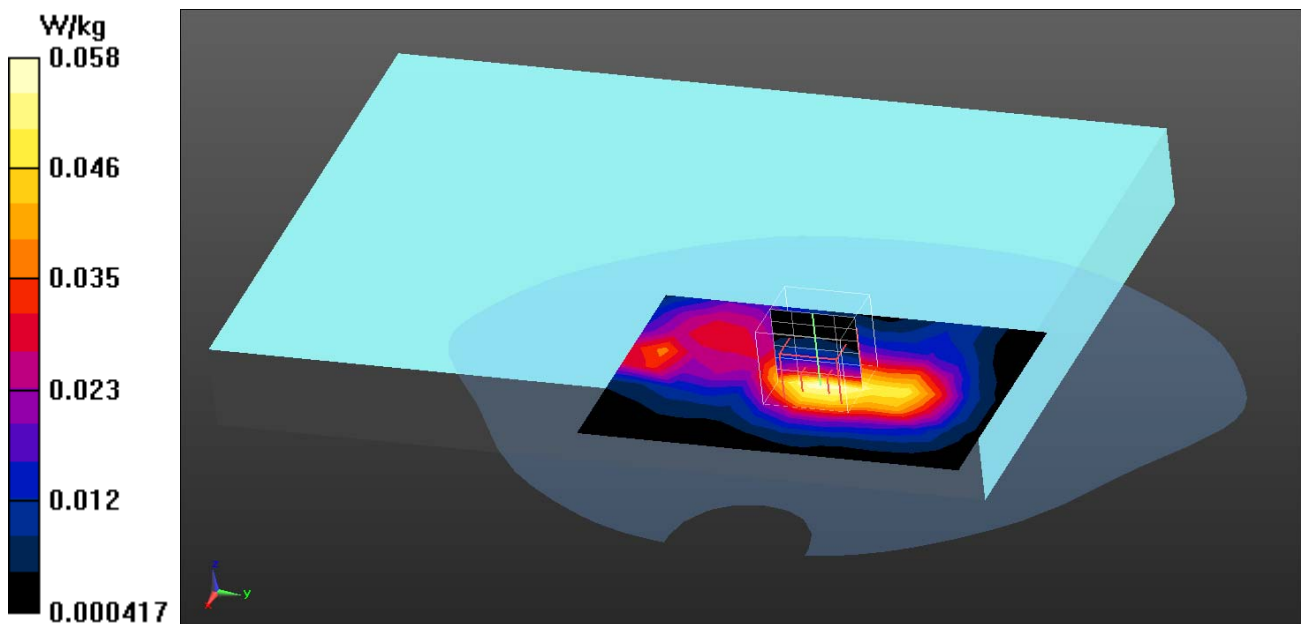

Test Laboratory: QuieTek

Date/Time: 2015/6/10

802.11b_6-Left-Side

DUT: TABLET PC; Type: PA-501

Communication System: UID 0, WLAN 2.4G; Frequency: 2437 MHz;

Communication System PAR: 0 dB

Medium parameters used: $f = 2437$ MHz; $\sigma = 1.93$ S/m; $\epsilon_r = 52.94$; $\rho = 1000$ kg/m³

Phantom section: Flat Section

Ambient Temperature (°C) : 22.1, Liquid Temperature (°C) : 20.8

Measurement Standard: DASY5 (IEEE/IEC/ANSI C63.19-2007)

DASY5 Configuration:

- Probe: EX3DV4 - SN3979; ConvF(7.08, 7.08, 7.08); Calibrated: 2014/11/21;
- Sensor-Surface: 3mm (Mechanical Surface Detection)
- Electronics: DAE4 Sn1425; Calibrated: 2014/11/13
- Phantom: SAM with left table; Type: SAM;
- Measurement SW: DASY52, Version 52.8 (8); SEMCAD X Version 14.6.10 (7331)

Configuration/Body/Area Scan (8x10x1): Measurement grid: dx=12mm, dy=12mm

Maximum value of SAR (measured) = 0.0540 W/kg

Configuration/Body/Zoom Scan (5x5x7) (5x5x7)/Cube 0: Measurement grid:

dx=8mm, dy=8mm, dz=5mm

Reference Value = 3.739 V/m; Power Drift = 0.14 dB

Peak SAR (extrapolated) = 0.0870 W/kg

SAR(1 g) = 0.046 W/kg; SAR(10 g) = 0.026 W/kg

Maximum value of SAR (measured) = 0.0573 W/kg

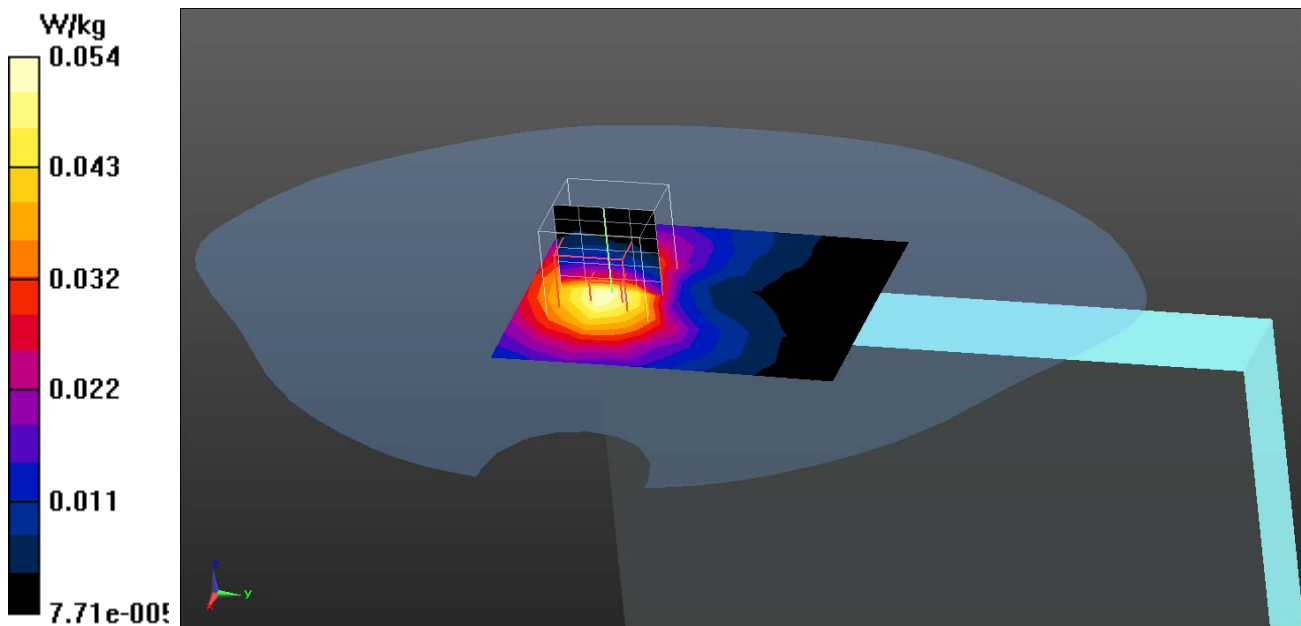

802.11b EUT Bottom, Z-Axis plot
Channel: 6

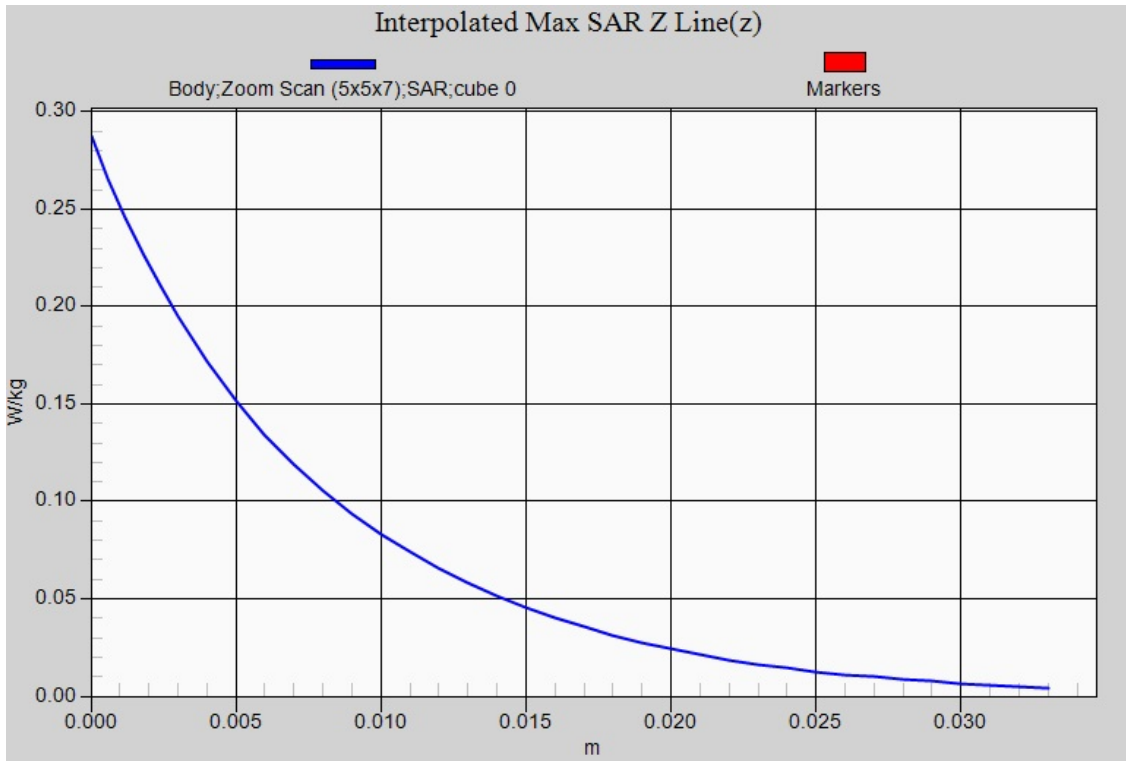

Test Laboratory: QuieTek

Date/Time: 2015/6/11

802.11a_36-Top

DUT: TABLET PC; Type: PA-501

Communication System: UID 0, WLAN 5G; Frequency: 5180 MHz;

Communication System PAR: 0 dB

Medium parameters used: $f = 5180$ MHz; $\sigma = 5.27$ S/m; $\epsilon_r = 49.23$; $\rho = 1000$ kg/m³

Phantom section: Flat Section

Ambient Temperature (°C) : 21.9, Liquid Temperature (°C) : 19.8

Measurement Standard: DASYS (IEEE/IEC/ANSI C63.19-2007)

DASY5 Configuration:

- Probe: EX3DV4 - SN3979; ConvF(4.6, 4.6, 4.6); Calibrated: 2014/11/21;
- Sensor-Surface: 1.4mm (Mechanical Surface Detection)
- Electronics: DAE4 Sn1425; Calibrated: 2014/11/13
- Phantom: SAM with left table; Type: SAM;
- Measurement SW: DASYS2, Version 52.8 (8); SEMCAD X Version 14.6.10 (7331)

Configuration/Body/Area Scan (7x12x1): Measurement grid: dx=10mm, dy=10mm
Maximum value of SAR (measured) = 0.358 W/kg

Configuration/Body/Zoom Scan (6x6x12) (6x6x12)/Cube 0: Measurement grid:
dx=5mm, dy=5mm, dz=2mm
Reference Value = 9.766 V/m; Power Drift = -0.04 dB
Peak SAR (extrapolated) = 0.620 W/kg
SAR(1 g) = 0.169 W/kg; SAR(10 g) = 0.063 W/kg
Maximum value of SAR (measured) = 0.357 W/kg

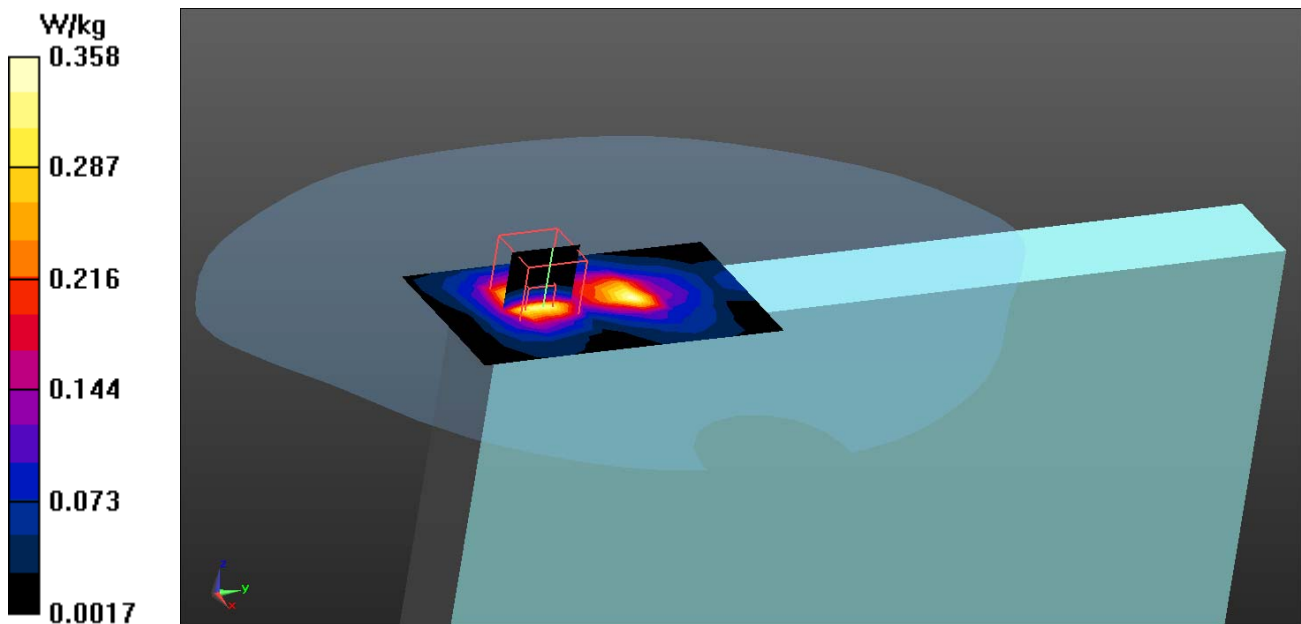

Test Laboratory: QuieTek

Date/Time: 2015/6/11

802.11a_44-Top

DUT: TABLET PC; Type: PA-501

Communication System: UID 0, WLAN 5G; Frequency: 5220 MHz;

Communication System PAR: 0 dB

Medium parameters used: $f = 5220$ MHz; $\sigma = 5.33$ S/m; $\epsilon_r = 49.12$; $\rho = 1000$ kg/m³

Phantom section: Flat Section

Ambient Temperature (°C) : 21.9, Liquid Temperature (°C) : 19.8

Measurement Standard: DASY5 (IEEE/IEC/ANSI C63.19-2007)

DASY5 Configuration:

- Probe: EX3DV4 - SN3979; ConvF(4.6, 4.6, 4.6); Calibrated: 2014/11/21;
- Sensor-Surface: 1.4mm (Mechanical Surface Detection)
- Electronics: DAE4 Sn1425; Calibrated: 2014/11/13
- Phantom: SAM with left table; Type: SAM;
- Measurement SW: DASY52, Version 52.8 (8); SEMCAD X Version 14.6.10 (7331)

Configuration/Body/Area Scan (7x11x1): Measurement grid: dx=10mm, dy=10mm
Maximum value of SAR (measured) = 0.352 W/kg

Configuration/Body/Zoom Scan (6x6x12) (6x6x12)/Cube 0: Measurement grid:
dx=5mm, dy=5mm, dz=2mm
Reference Value = 9.117 V/m; Power Drift = 0.01 dB
Peak SAR (extrapolated) = 0.603 W/kg
SAR(1 g) = 0.165 W/kg; SAR(10 g) = 0.061 W/kg
Maximum value of SAR (measured) = 0.351 W/kg

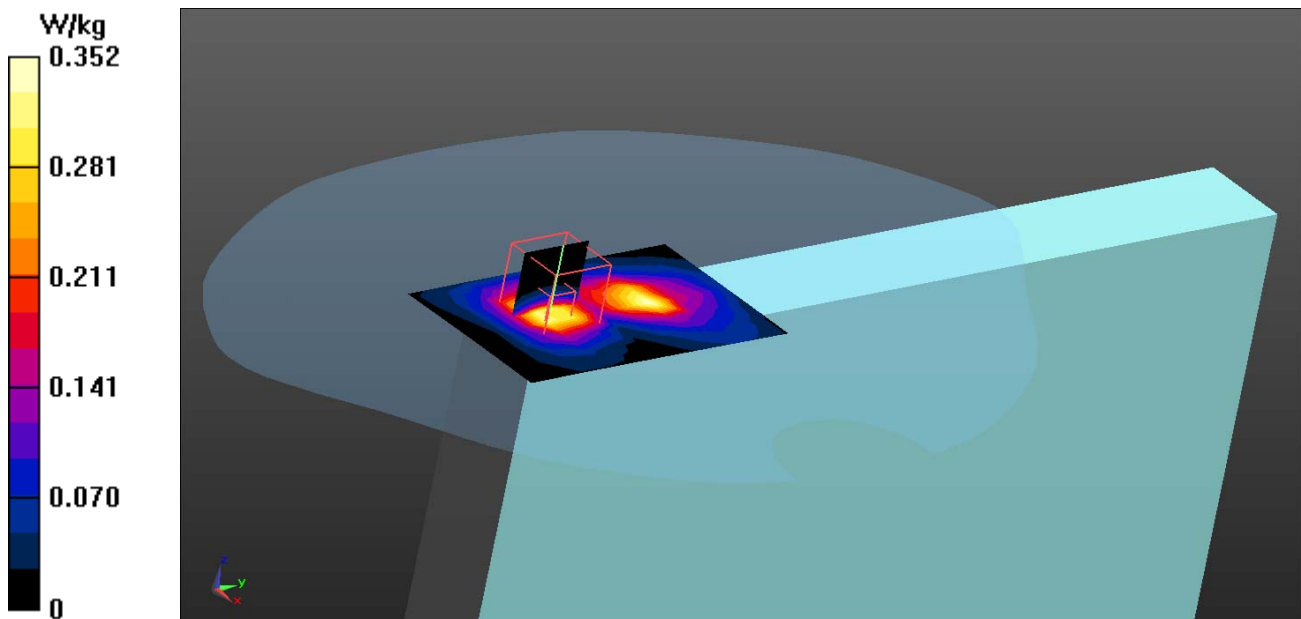

Test Laboratory: QuieTek

Date/Time: 2015/6/11

802.11a_48-Top

DUT: TABLET PC; Type: PA-501

Communication System: UID 0, WLAN 5G; Frequency: 5240 MHz;

Communication System PAR: 0 dB

Medium parameters used: $f = 5240$ MHz; $\sigma = 5.35$ S/m; $\epsilon_r = 49.07$; $\rho = 1000$ kg/m³

Phantom section: Flat Section

Ambient Temperature (°C) : 21.9, Liquid Temperature (°C) : 19.8

Measurement Standard: DASYS (IEEE/IEC/ANSI C63.19-2007)

DASY5 Configuration:

- Probe: EX3DV4 - SN3979; ConvF(4.6, 4.6, 4.6); Calibrated: 2014/11/21;
- Sensor-Surface: 1.4mm (Mechanical Surface Detection)
- Electronics: DAE4 Sn1425; Calibrated: 2014/11/13
- Phantom: SAM with left table; Type: SAM;
- Measurement SW: DASYS2, Version 52.8 (8); SEMCAD X Version 14.6.10 (7331)

Configuration/Body/Area Scan (7x11x1): Measurement grid: dx=10mm, dy=10mm
Maximum value of SAR (measured) = 0.327 W/kg

Configuration/Body/Zoom Scan (6x6x12) (6x6x12)/Cube 0: Measurement grid:
dx=5mm, dy=5mm, dz=2mm
Reference Value = 8.765 V/m; Power Drift = -0.04 dB
Peak SAR (extrapolated) = 0.629 W/kg
SAR(1 g) = 0.151 W/kg; SAR(10 g) = 0.053 W/kg
Maximum value of SAR (measured) = 0.362 W/kg

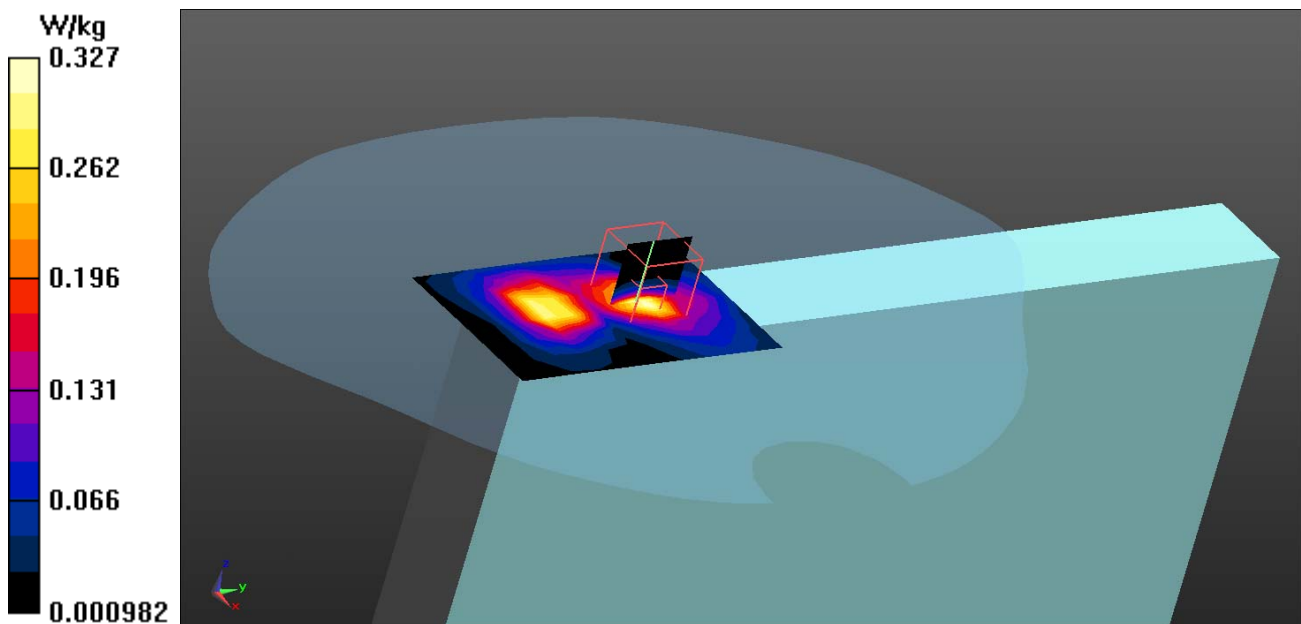

Test Laboratory: QuieTek

Date/Time: 2015/6/11

802.11a_52-Top

DUT: TABLET PC; Type: PA-501

Communication System: UID 0, WLAN 5G; Frequency: 5260 MHz;

Communication System PAR: 0 dB

Medium parameters used: $f = 5260$ MHz; $\sigma = 5.39$ S/m; $\epsilon_r = 49.01$; $\rho = 1000$ kg/m³

Phantom section: Flat Section

Ambient Temperature (°C) : 21.9, Liquid Temperature (°C) : 19.8

Measurement Standard: DASYS (IEEE/IEC/ANSI C63.19-2007)

DASY5 Configuration:

- Probe: EX3DV4 - SN3979; ConvF(4.42, 4.42, 4.42); Calibrated: 2014/11/21;
- Sensor-Surface: 1.4mm (Mechanical Surface Detection)
- Electronics: DAE4 Sn1425; Calibrated: 2014/11/13
- Phantom: SAM with left table; Type: SAM;
- Measurement SW: DASYS2, Version 52.8 (8); SEMCAD X Version 14.6.10 (7331)

Configuration/Body/Area Scan (7x11x1): Measurement grid: dx=10mm, dy=10mm

Maximum value of SAR (measured) = 0.269 W/kg

Configuration/Body/Zoom Scan (6x6x12) (6x6x12)/Cube 0: Measurement grid:

dx=5mm, dy=5mm, dz=2mm

Reference Value = 7.989 V/m; Power Drift = 0.16 dB

Peak SAR (extrapolated) = 0.598 W/kg

SAR(1 g) = 0.146 W/kg; SAR(10 g) = 0.054 W/kg

Maximum value of SAR (measured) = 0.313 W/kg

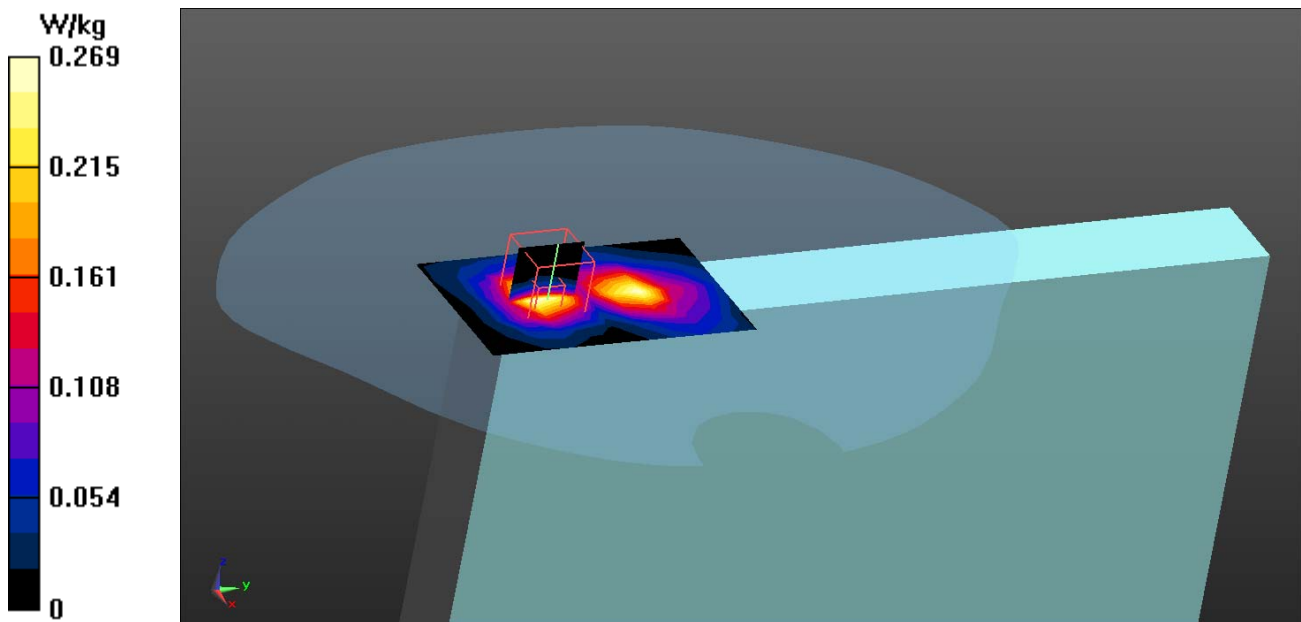

Test Laboratory: QuieTek

Date/Time: 2015/6/11

802.11a_60-Top

DUT: TABLET PC; Type: PA-501

Communication System: UID 0, WLAN 5G; Frequency: 5300 MHz;

Communication System PAR: 0 dB

Medium parameters used: $f = 5300 \text{ MHz}$; $\sigma = 5.45 \text{ S/m}$; $\epsilon_r = 48.92$; $\rho = 1000 \text{ kg/m}^3$

Phantom section: Flat Section

Ambient Temperature ($^{\circ}\text{C}$) : 21.9, Liquid Temperature ($^{\circ}\text{C}$) : 19.8

Measurement Standard: DASY5 (IEEE/IEC/ANSI C63.19-2007)

DASY5 Configuration:

- Probe: EX3DV4 - SN3979; ConvF(4.42, 4.42, 4.42); Calibrated: 2014/11/21;
- Sensor-Surface: 1.4mm (Mechanical Surface Detection)
- Electronics: DAE4 Sn1425; Calibrated: 2014/11/13
- Phantom: SAM with left table; Type: SAM;
- Measurement SW: DASY52, Version 52.8 (8); SEMCAD X Version 14.6.10 (7331)

Configuration/Body/Area Scan (7x11x1): Measurement grid: dx=10mm, dy=10mm

Maximum value of SAR (measured) = 0.339 W/kg

Configuration/Body/Zoom Scan (6x6x12) (6x6x12)/Cube 0: Measurement grid:

dx=5mm, dy=5mm, dz=2mm

Reference Value = 8.318 V/m; Power Drift = -0.06 dB

Peak SAR (extrapolated) = 0.606 W/kg

SAR(1 g) = 0.150 W/kg; SAR(10 g) = 0.053 W/kg

Maximum value of SAR (measured) = 0.310 W/kg

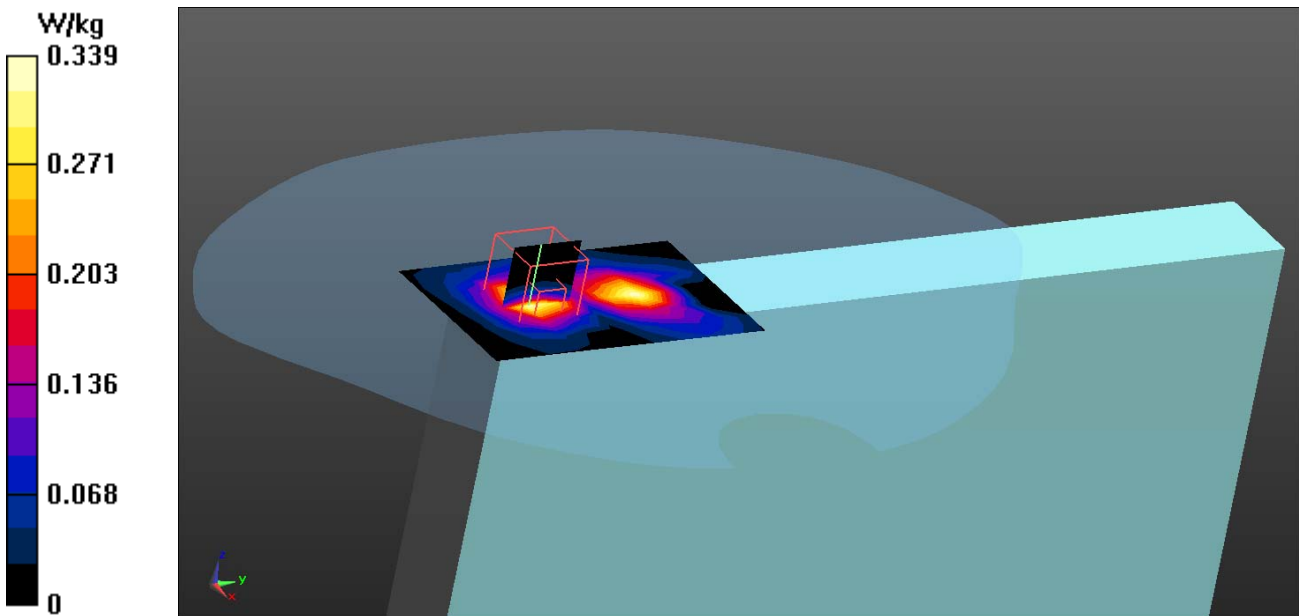

Test Laboratory: QuieTek

Date/Time: 2015/6/11

802.11a_64-Top

DUT: TABLET PC; Type: PA-501

Communication System: UID 0, WLAN 5G; Frequency: 5320 MHz;

Communication System PAR: 0 dB

Medium parameters used: $f = 5320$ MHz; $\sigma = 5.48$ S/m; $\epsilon_r = 48.85$; $\rho = 1000$ kg/m³

Phantom section: Flat Section

Ambient Temperature (°C) : 21.9, Liquid Temperature (°C) : 19.8

Measurement Standard: DASY5 (IEEE/IEC/ANSI C63.19-2007)

DASY5 Configuration:

- Probe: EX3DV4 - SN3979; ConvF(4.42, 4.42, 4.42); Calibrated: 2014/11/21;
- Sensor-Surface: 1.4mm (Mechanical Surface Detection)
- Electronics: DAE4 Sn1425; Calibrated: 2014/11/13
- Phantom: SAM with left table; Type: SAM;
- Measurement SW: DASY52, Version 52.8 (8); SEMCAD X Version 14.6.10 (7331)

Configuration/Body/Area Scan (7x16x1): Measurement grid: dx=10mm, dy=10mm
Maximum value of SAR (measured) = 0.290 W/kg

Configuration/Body/Zoom Scan (6x6x12) (6x6x12)/Cube 0: Measurement grid:
dx=5mm, dy=5mm, dz=2mm
Reference Value = 8.151 V/m; Power Drift = -0.03 dB
Peak SAR (extrapolated) = 0.511 W/kg
SAR(1 g) = 0.160 W/kg; SAR(10 g) = 0.049 W/kg
Maximum value of SAR (measured) = 0.301 W/kg

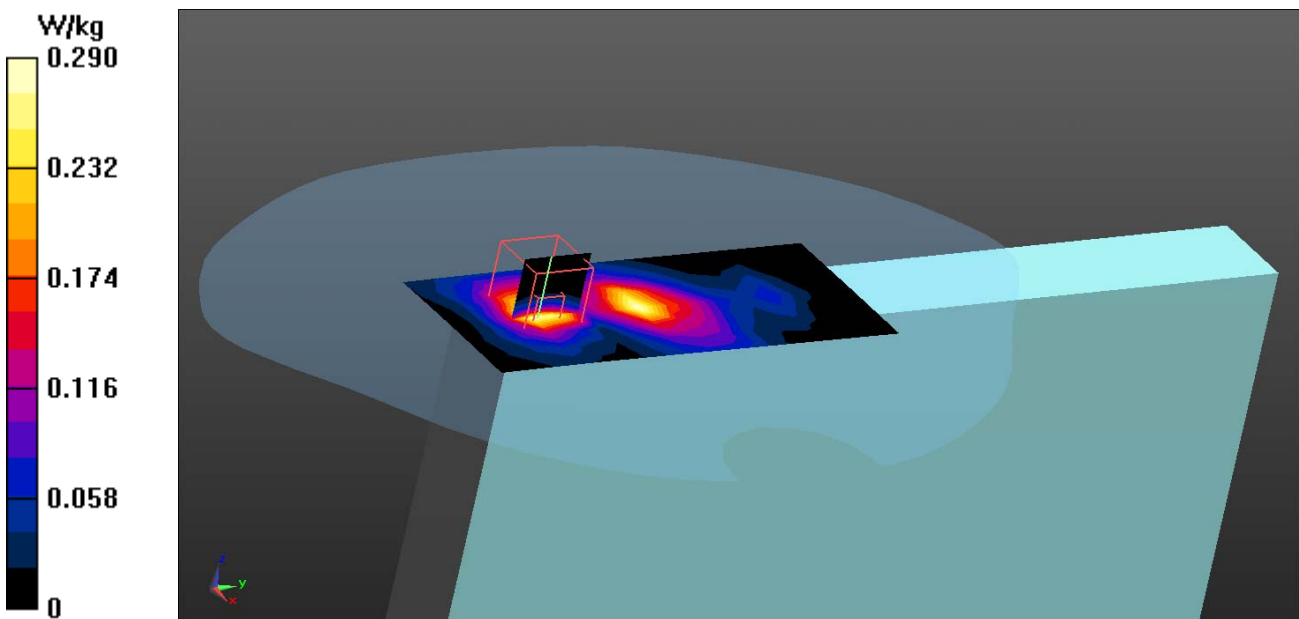

Test Laboratory: QuieTek

Date/Time: 2015/6/11

802.11a_100-Top

DUT: TABLET PC; Type: PA-501

Communication System: UID 0, WLAN 5G; Frequency: 5500 MHz;

Communication System PAR: 0 dB

Medium parameters used: $f = 5500$ MHz; $\sigma = 5.75$ S/m; $\epsilon_r = 48.36$; $\rho = 1000$ kg/m³

Phantom section: Flat Section

Ambient Temperature (°C) : 21.9, Liquid Temperature (°C) : 19.8

Measurement Standard: DASY5 (IEEE/IEC/ANSI C63.19-2007)

DASY5 Configuration:

- Probe: EX3DV4 - SN3979; ConvF(4.04, 4.04, 4.04); Calibrated: 2014/11/21;
- Sensor-Surface: 1.4mm (Mechanical Surface Detection)
- Electronics: DAE4 Sn1425; Calibrated: 2014/11/13
- Phantom: SAM with left table; Type: SAM;
- Measurement SW: DASY52, Version 52.8 (8); SEMCAD X Version 14.6.10 (7331)

Configuration/Body/Area Scan (7x11x1): Measurement grid: dx=10mm, dy=10mm
Maximum value of SAR (measured) = 0.453 W/kg

Configuration/Body/Zoom Scan (6x6x12) (6x6x12)/Cube 0: Measurement grid:
dx=5mm, dy=5mm, dz=2mm
Reference Value = 9.775 V/m; Power Drift = -0.02 dB
Peak SAR (extrapolated) = 0.791 W/kg
SAR(1 g) = 0.215 W/kg; SAR(10 g) = 0.092 W/kg
Maximum value of SAR (measured) = 0.477 W/kg

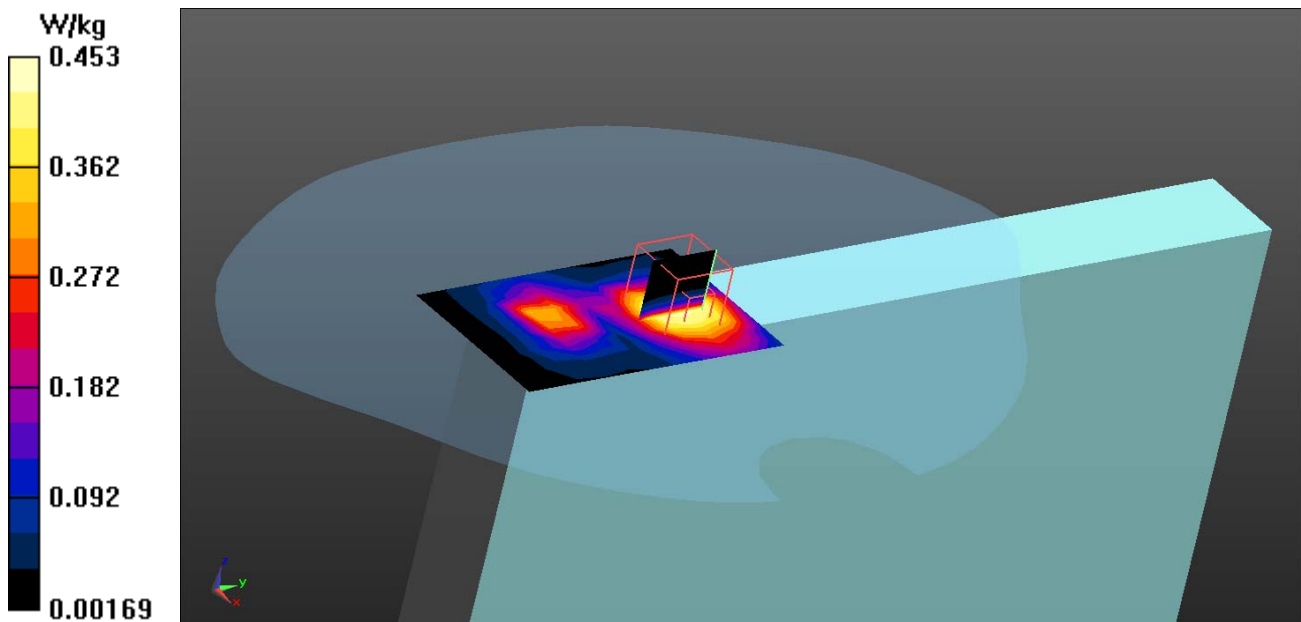

Test Laboratory: QuieTek

Date/Time: 2015/6/11

802.11a_116-Top

DUT: TABLET PC; Type: PA-501

Communication System: UID 0, WLAN 5G; Frequency: 5580 MHz;

Communication System PAR: 0 dB

Medium parameters used: $f = 5580$ MHz; $\sigma = 5.88$ S/m; $\epsilon_r = 48.14$; $\rho = 1000$ kg/m³

Phantom section: Flat Section

Ambient Temperature (°C) : 21.9, Liquid Temperature (°C) : 19.8

Measurement Standard: DASY5 (IEEE/IEC/ANSI C63.19-2007)

DASY5 Configuration:

- Probe: EX3DV4 - SN3979; ConvF(4.01, 4.01, 4.01); Calibrated: 2014/11/21;
- Sensor-Surface: 1.4mm (Mechanical Surface Detection)
- Electronics: DAE4 Sn1425; Calibrated: 2014/11/13
- Phantom: SAM with left table; Type: SAM;
- Measurement SW: DASY52, Version 52.8 (8); SEMCAD X Version 14.6.10 (7331)

Configuration/Body/Area Scan (7x11x1): Measurement grid: dx=10mm, dy=10mm
Maximum value of SAR (measured) = 0.432 W/kg

Configuration/Body/Zoom Scan (6x6x12) (6x6x12)/Cube 0: Measurement grid:
dx=5mm, dy=5mm, dz=2mm
Reference Value = 8.946 V/m; Power Drift = -0.09 dB
Peak SAR (extrapolated) = 0.824 W/kg
SAR(1 g) = 0.221 W/kg; SAR(10 g) = 0.090 W/kg
Maximum value of SAR (measured) = 0.494 W/kg

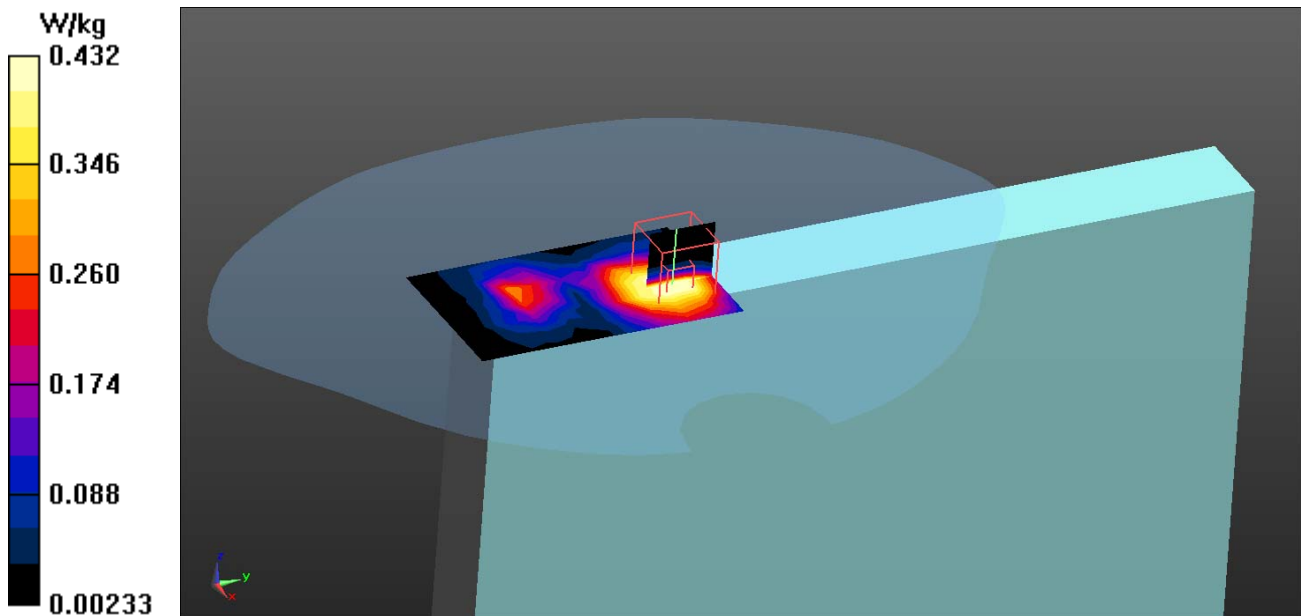

Test Laboratory: QuieTek

Date/Time: 2015/6/11

802.11a_149-Top

DUT: TABLET PC; Type: PA-501

Communication System: UID 0, WLAN 5G; Frequency: 5745 MHz;

Communication System PAR: 0 dB

Medium parameters used: $f = 5745$ MHz; $\sigma = 6.13$ S/m; $\epsilon_r = 47.73$; $\rho = 1000$ kg/m³

Phantom section: Flat Section

Ambient Temperature (°C) : 21.9, Liquid Temperature (°C) : 19.8

Measurement Standard: DASYS (IEEE/IEC/ANSI C63.19-2007)

DASY5 Configuration:

- Probe: EX3DV4 - SN3979; ConvF(4.18, 4.18, 4.18); Calibrated: 2014/11/21;
- Sensor-Surface: 1.4mm (Mechanical Surface Detection)
- Electronics: DAE4 Sn1425; Calibrated: 2014/11/13
- Phantom: SAM with left table; Type: SAM;
- Measurement SW: DASYS2, Version 52.8 (8); SEMCAD X Version 14.6.10 (7331)

Configuration/Body/Area Scan (7x11x1): Measurement grid: dx=10mm, dy=10mm

Maximum value of SAR (measured) = 0.264 W/kg

Configuration/Body/Zoom Scan (6x6x12) (6x6x12)/Cube 0: Measurement grid:

dx=5mm, dy=5mm, dz=2mm

Reference Value = 6.550 V/m; Power Drift = -0.04 dB

Peak SAR (extrapolated) = 0.532 W/kg

SAR(1 g) = 0.133 W/kg; SAR(10 g) = 0.054 W/kg

Maximum value of SAR (measured) = 0.300 W/kg

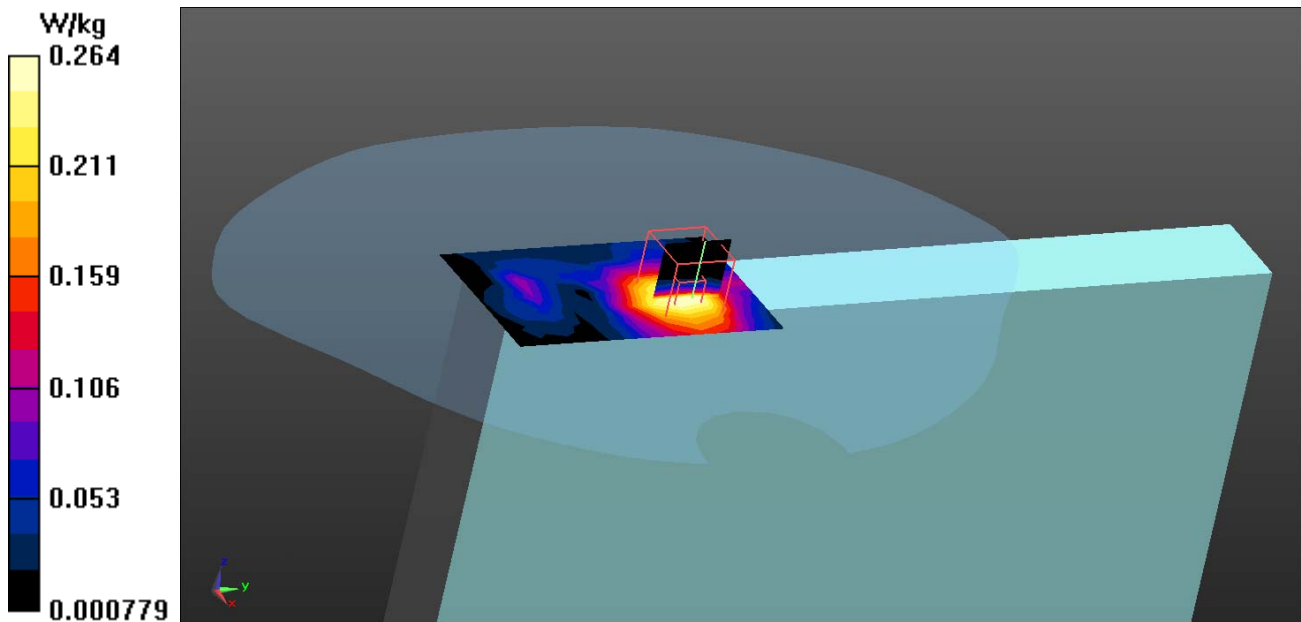

Test Laboratory: QuieTek

Date/Time: 2015/6/11

802.11a_165-Top

DUT: TABLET PC; Type: PA-501

Communication System: UID 0, WLAN 5G; Frequency: 5825 MHz;

Communication System PAR: 0 dB

Medium parameters used: $f = 5825$ MHz; $\sigma = 6.25$ S/m; $\epsilon_r = 47.46$; $\rho = 1000$ kg/m³

Phantom section: Flat Section

Ambient Temperature (°C) : 21.9, Liquid Temperature (°C) : 19.8

Measurement Standard: DASYS (IEEE/IEC/ANSI C63.19-2007)

DASY5 Configuration:

- Probe: EX3DV4 - SN3979; ConvF(4.18, 4.18, 4.18); Calibrated: 2014/11/21;
- Sensor-Surface: 1.4mm (Mechanical Surface Detection)
- Electronics: DAE4 Sn1425; Calibrated: 2014/11/13
- Phantom: SAM with left table; Type: SAM;
- Measurement SW: DASYS2, Version 52.8 (8); SEMCAD X Version 14.6.10 (7331)

Configuration/Body/Area Scan (7x11x1): Measurement grid: dx=10mm, dy=10mm

Maximum value of SAR (measured) = 0.253 W/kg

Configuration/Body/Zoom Scan (6x6x12) (6x6x12)/Cube 0: Measurement grid:

dx=5mm, dy=5mm, dz=2mm

Reference Value = 5.962 V/m; Power Drift = -0.14 dB

Peak SAR (extrapolated) = 0.464 W/kg

SAR(1 g) = 0.117 W/kg; SAR(10 g) = 0.047 W/kg

Maximum value of SAR (measured) = 0.279 W/kg

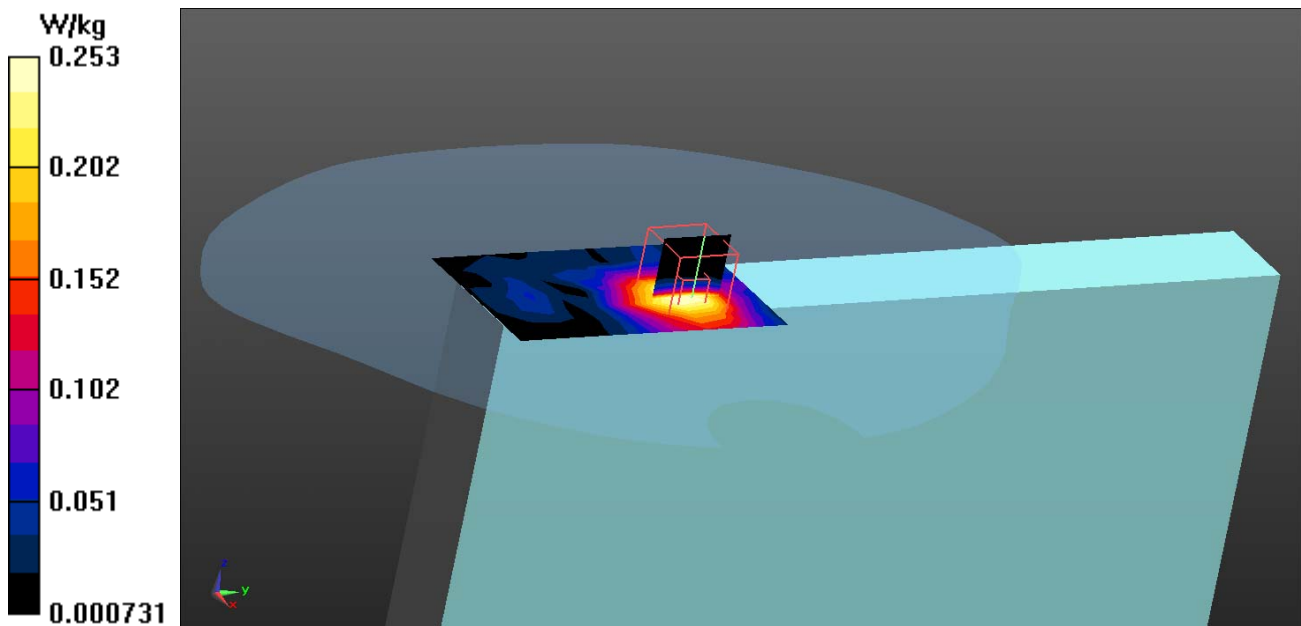

Test Laboratory: QuieTek

Date/Time: 2015/6/11

802.11a_64-Bottom

DUT: TABLET PC; Type: PA-501

Communication System: UID 0, WLAN 5G; Frequency: 5320 MHz;

Communication System PAR: 0 dB

Medium parameters used: $f = 5320$ MHz; $\sigma = 5.48$ S/m; $\epsilon_r = 48.85$; $\rho = 1000$ kg/m³

Phantom section: Flat Section

Ambient Temperature (°C) : 21.9, Liquid Temperature (°C) : 19.8

Measurement Standard: DASYS (IEEE/IEC/ANSI C63.19-2007)

DASY5 Configuration:

- Probe: EX3DV4 - SN3979; ConvF(4.42, 4.42, 4.42); Calibrated: 2014/11/21;
- Sensor-Surface: 1.4mm (Mechanical Surface Detection)
- Electronics: DAE4 Sn1425; Calibrated: 2014/11/13
- Phantom: SAM with left table; Type: SAM;
- Measurement SW: DASYS2, Version 52.8 (8); SEMCAD X Version 14.6.10 (7331)

Configuration/Body/Area Scan (7x16x1): Measurement grid: dx=10mm, dy=10mm
Maximum value of SAR (measured) = 0.0217 W/kg

Configuration/Body/Zoom Scan (6x6x12) (6x6x12)/Cube 0: Measurement grid:
dx=5mm, dy=5mm, dz=2mm
Reference Value = 0.4130 V/m; Power Drift = 0.11 dB
Peak SAR (extrapolated) = 0.0600 W/kg
SAR(1 g) = 0.00701 W/kg; SAR(10 g) = 0.00196 W/kg
Maximum value of SAR (measured) = 0.0194 W/kg

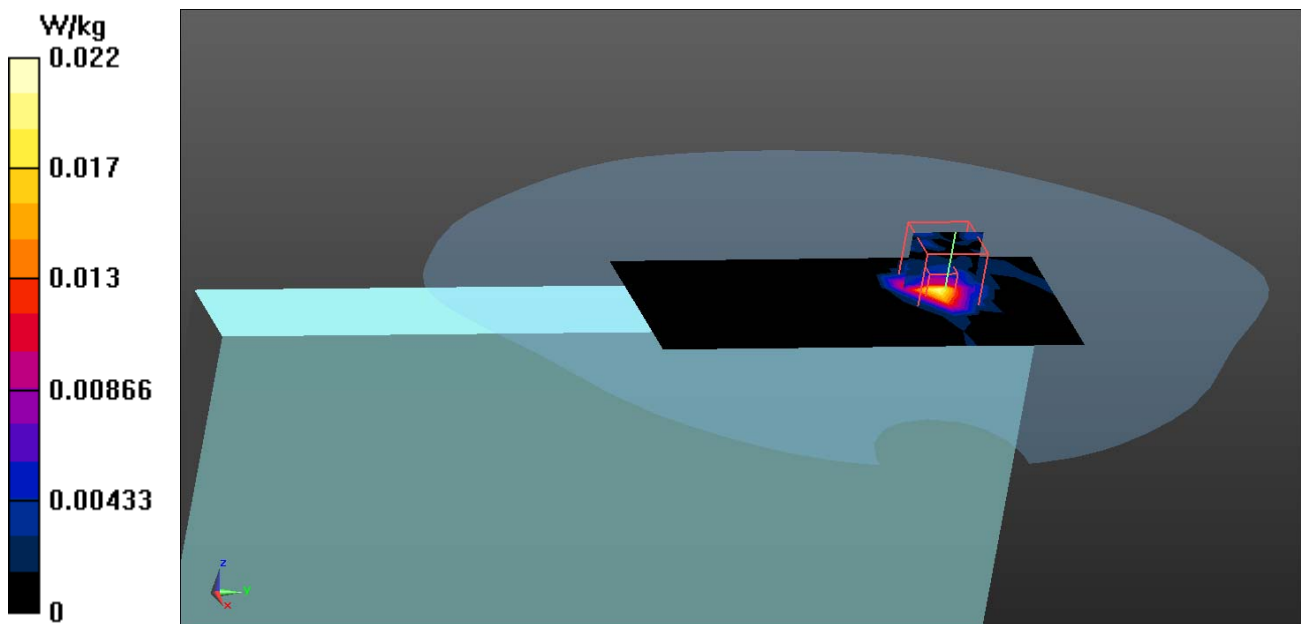

Test Laboratory: QuieTek

Date/Time: 2015/6/11

802.11a_64-Back

DUT: TABLET PC; Type: PA-501

Communication System: UID 0, WLAN 5G; Frequency: 5320 MHz;

Communication System PAR: 0 dB

Medium parameters used: $f = 5320$ MHz; $\sigma = 5.48$ S/m; $\epsilon_r = 48.85$; $\rho = 1000$ kg/m³

Phantom section: Flat Section

Ambient Temperature (°C) : 21.9, Liquid Temperature (°C) : 19.8

Measurement Standard: DASY5 (IEEE/IEC/ANSI C63.19-2007)

DASY5 Configuration:

- Probe: EX3DV4 - SN3979; ConvF(4.42, 4.42, 4.42); Calibrated: 2014/11/21;
- Sensor-Surface: 1.4mm (Mechanical Surface Detection)
- Electronics: DAE4 Sn1425; Calibrated: 2014/11/13
- Phantom: SAM with left table; Type: SAM;
- Measurement SW: DASY52, Version 52.8 (8); SEMCAD X Version 14.6.10 (7331)

Configuration/Body/Area Scan (8x14x1): Measurement grid: dx=10mm, dy=10mm
Maximum value of SAR (measured) = 0.190 W/kg

Configuration/Body/Zoom Scan (6x6x12) (6x6x12)/Cube 0: Measurement grid:
dx=5mm, dy=5mm, dz=2mm
Reference Value = 5.059 V/m; Power Drift = -0.15 dB
Peak SAR (extrapolated) = 0.639 W/kg
SAR(1 g) = 0.069 W/kg; SAR(10 g) = 0.026 W/kg
Maximum value of SAR (measured) = 0.175 W/kg

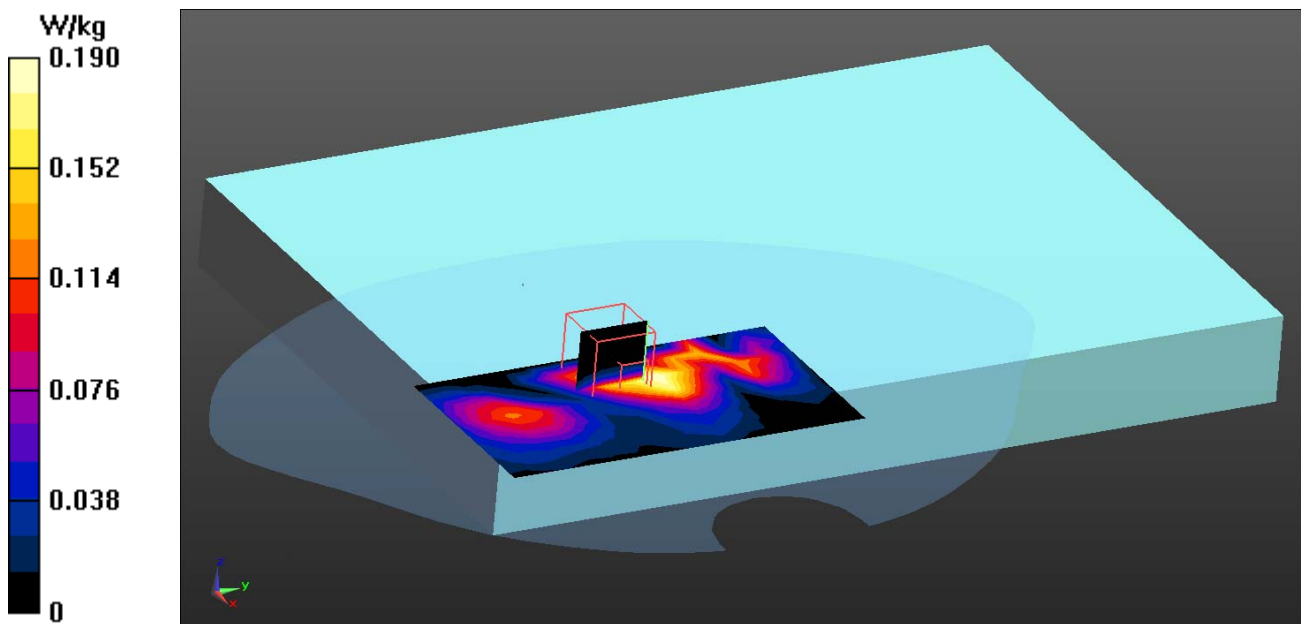

Test Laboratory: QuieTek

Date/Time: 2015/6/11

802.11a_64-Left-Side

DUT: TABLET PC; Type: PA-501

Communication System: UID 0, WLAN 5G; Frequency: 5320 MHz;

Communication System PAR: 0 dB

Medium parameters used: $f = 5320$ MHz; $\sigma = 5.48$ S/m; $\epsilon_r = 48.85$; $\rho = 1000$ kg/m³

Phantom section: Flat Section

Ambient Temperature (°C) : 21.9, Liquid Temperature (°C) : 19.8

Measurement Standard: DASYS (IEEE/IEC/ANSI C63.19-2007)

DASY5 Configuration:

- Probe: EX3DV4 - SN3979; ConvF(4.42, 4.42, 4.42); Calibrated: 2014/11/21;
- Sensor-Surface: 1.4mm (Mechanical Surface Detection)
- Electronics: DAE4 Sn1425; Calibrated: 2014/11/13
- Phantom: SAM with left table; Type: SAM;
- Measurement SW: DASYS2, Version 52.8 (8); SEMCAD X Version 14.6.10 (7331)

Configuration/Body/Area Scan (9x14x1): Measurement grid: dx=10mm, dy=10mm

Maximum value of SAR (measured) = 0.0788 W/kg

Configuration/Body/Zoom Scan (6x6x12) (6x6x12)/Cube 0: Measurement grid:

dx=5mm, dy=5mm, dz=2mm

Reference Value = 2.773 V/m; Power Drift = 0.04 dB

Peak SAR (extrapolated) = 0.161 W/kg

SAR(1 g) = 0.033 W/kg; SAR(10 g) = 0.012 W/kg

Maximum value of SAR (measured) = 0.0838 W/kg

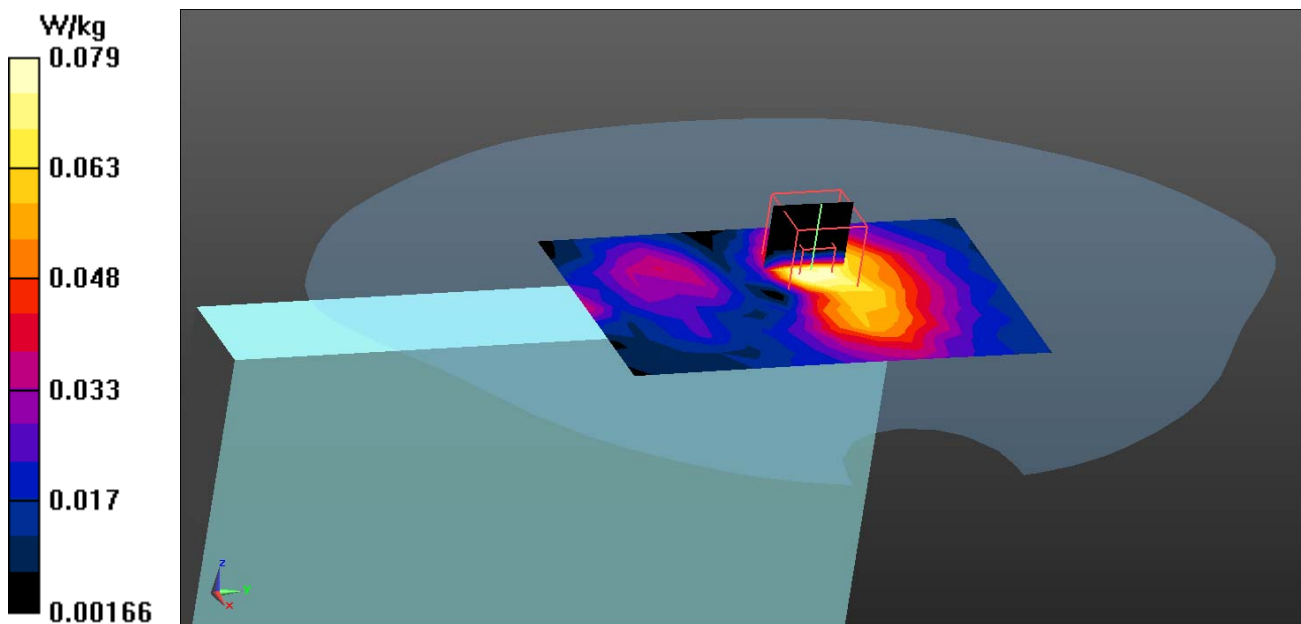

802.11a EUT Top, Z-Axis plot
Channel: 116

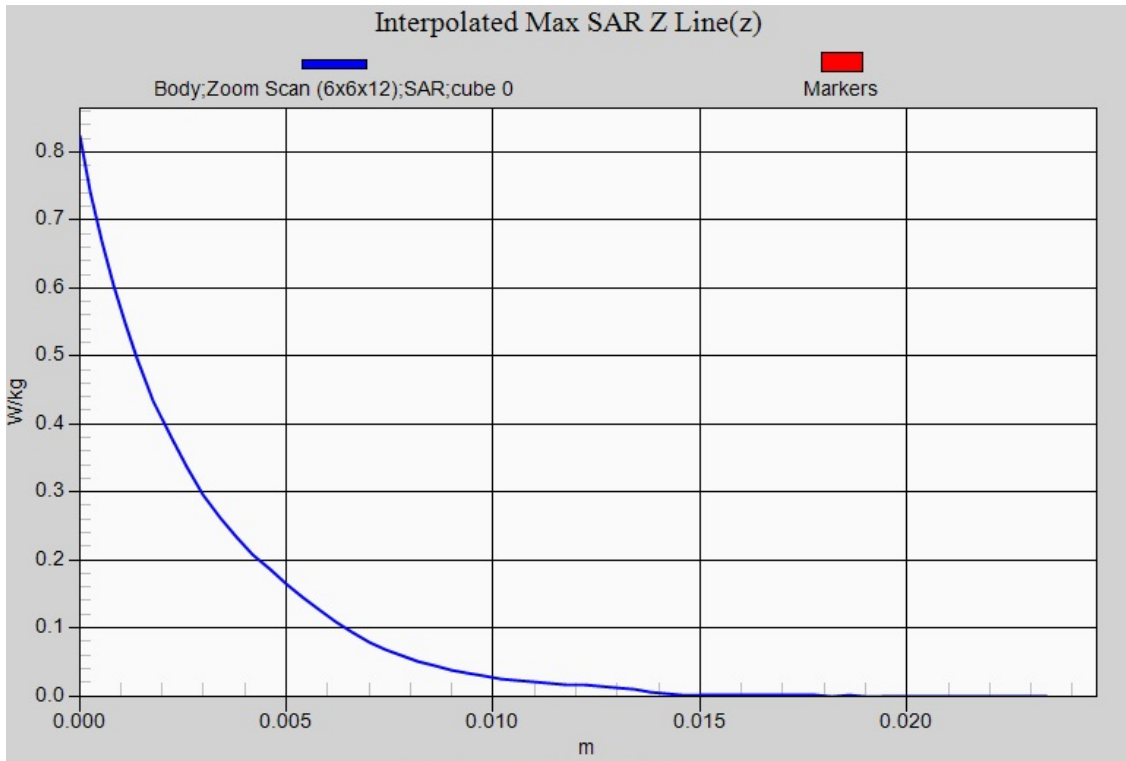

Appendix D. Probe Calibration Data

Object: EX3DV4- SN: 3979



Accredited by the Swiss Accreditation Service (SAS)
The Swiss Accreditation Service is one of the signatories to the EA
Multilateral Agreement for the recognition of calibration certificates

Accreditation No.: **SCS 108**

Client **Quietek-TW (Auden)**

Certificate No: **EX3-3979_Nov14**

CALIBRATION CERTIFICATE

Object **EX3DV4 - SN:3979**

Calibration procedure(s) **QA CAL-01.v9, QA CAL-14.v4, QA CAL-23.v5, QA CAL-25.v6
Calibration procedure for dosimetric E-field probes**

Calibration date: **November 21, 2014**

This calibration certificate documents the traceability to national standards, which realize the physical units of measurements (SI).
The measurements and the uncertainties with confidence probability are given on the following pages and are part of the certificate.

All calibrations have been conducted in the closed laboratory facility: environment temperature (22 ± 3)°C and humidity < 70%.

Calibration Equipment used (M&TE critical for calibration)

Primary Standards	ID	Cal Date (Certificate No.)	Scheduled Calibration
Power meter E4419B	GB41293874	03-Apr-14 (No. 217-01911)	Apr-15
Power sensor E4412A	MY41498087	03-Apr-14 (No. 217-01911)	Apr-15
Reference 3 dB Attenuator	SN: S5054 (3c)	03-Apr-14 (No. 217-01915)	Apr-15
Reference 20 dB Attenuator	SN: S5277 (20x)	03-Apr-14 (No. 217-01919)	Apr-15
Reference 30 dB Attenuator	SN: S5129 (30b)	03-Apr-14 (No. 217-01920)	Apr-15
Reference Probe ES3DV2	SN: 3013	30-Dec-13 (No. ES3-3013_Dec13)	Dec-14
DAE4	SN: 660	13-Dec-13 (No. DAE4-660_Dec13)	Dec-14
Secondary Standards	ID	Check Date (in house)	Scheduled Check
RF generator HP 8648C	US3642U01700	4-Aug-99 (in house check Apr-13)	In house check: Apr-16
Network Analyzer HP 8753E	US37390585	18-Oct-01 (in house check Oct-14)	In house check: Oct-15

	Name	Function	Signature
Calibrated by:	Jeton Kastrati	Laboratory Technician	
Approved by:	Katja Pokovic	Technical Manager	

Issued: November 24, 2014

This calibration certificate shall not be reproduced except in full without written approval of the laboratory.



Accredited by the Swiss Accreditation Service (SAS)
The Swiss Accreditation Service is one of the signatories to the EA
Multilateral Agreement for the recognition of calibration certificates

Accreditation No.: **SCS 108**

Glossary:

TSL	tissue simulating liquid
NORM _{x,y,z}	sensitivity in free space
ConvF	sensitivity in TSL / NORM _{x,y,z}
DCP	diode compression point
CF	crest factor (1/duty_cycle) of the RF signal
A, B, C, D	modulation dependent linearization parameters
Polarization φ	φ rotation around probe axis
Polarization ϑ	ϑ rotation around an axis that is in the plane normal to probe axis (at measurement center), i.e., $\vartheta = 0$ is normal to probe axis
Connector Angle	information used in DASY system to align probe sensor X to the robot coordinate system

Calibration is Performed According to the Following Standards:

- IEEE Std 1528-2013, "IEEE Recommended Practice for Determining the Peak Spatial-Averaged Specific Absorption Rate (SAR) in the Human Head from Wireless Communications Devices: Measurement Techniques", June 2013
- IEC 62209-1, "Procedure to measure the Specific Absorption Rate (SAR) for hand-held devices used in close proximity to the ear (frequency range of 300 MHz to 3 GHz)", February 2005

Methods Applied and Interpretation of Parameters:

- NORM_{x,y,z}**: Assessed for E-field polarization $\vartheta = 0$ ($f \leq 900$ MHz in TEM-cell; $f > 1800$ MHz: R22 waveguide). NORM_{x,y,z} are only intermediate values, i.e., the uncertainties of NORM_{x,y,z} does not affect the E²-field uncertainty inside TSL (see below ConvF).
- NORM(f)_{x,y,z}** = NORM_{x,y,z} * frequency_response (see Frequency Response Chart). This linearization is implemented in DASY4 software versions later than 4.2. The uncertainty of the frequency response is included in the stated uncertainty of ConvF.
- DCP_{x,y,z}**: DCP are numerical linearization parameters assessed based on the data of power sweep with CW signal (no uncertainty required). DCP does not depend on frequency nor media.
- PAR**: PAR is the Peak to Average Ratio that is not calibrated but determined based on the signal characteristics
- A_{x,y,z}; B_{x,y,z}; C_{x,y,z}; D_{x,y,z}; VR_{x,y,z}**: A, B, C, D are numerical linearization parameters assessed based on the data of power sweep for specific modulation signal. The parameters do not depend on frequency nor media. VR is the maximum calibration range expressed in RMS voltage across the diode.
- ConvF and Boundary Effect Parameters**: Assessed in flat phantom using E-field (or Temperature Transfer Standard for $f \leq 800$ MHz) and inside waveguide using analytical field distributions based on power measurements for $f > 800$ MHz. The same setups are used for assessment of the parameters applied for boundary compensation (alpha, depth) of which typical uncertainty values are given. These parameters are used in DASY4 software to improve probe accuracy close to the boundary. The sensitivity in TSL corresponds to NORM_{x,y,z} * ConvF whereby the uncertainty corresponds to that given for ConvF. A frequency dependent ConvF is used in DASY version 4.4 and higher which allows extending the validity from ± 50 MHz to ± 100 MHz.
- Spherical isotropy (3D deviation from isotropy)**: in a field of low gradients realized using a flat phantom exposed by a patch antenna.
- Sensor Offset**: The sensor offset corresponds to the offset of virtual measurement center from the probe tip (on probe axis). No tolerance required.
- Connector Angle**: The angle is assessed using the information gained by determining the NORM_x (no uncertainty required).

Probe EX3DV4

SN:3979

Manufactured: November 5, 2013
Calibrated: November 21, 2014

Calibrated for DASY/EASY Systems
(Note: non-compatible with DASY2 system!)

DASY/EASY - Parameters of Probe: EX3DV4 - SN:3979

Basic Calibration Parameters

	Sensor X	Sensor Y	Sensor Z	Unc (k=2)
Norm ($\mu\text{V}/(\text{V}/\text{m})^2$) ^A	0.48	0.50	0.48	$\pm 10.1 \%$
DCP (mV) ^B	99.8	99.9	100.5	

Modulation Calibration Parameters

UID	Communication System Name		A dB	B dB $\sqrt{\mu\text{V}}$	C	D dB	VR mV	Unc ^E (k=2)
0	CW	X	0.0	0.0	1.0	0.00	193.1	$\pm 3.8 \%$
		Y	0.0	0.0	1.0		190.4	
		Z	0.0	0.0	1.0		184.4	

The reported uncertainty of measurement is stated as the standard uncertainty of measurement multiplied by the coverage factor $k=2$, which for a normal distribution corresponds to a coverage probability of approximately 95%.

^A The uncertainties of NormX,Y,Z do not affect the E^2 -field uncertainty inside TSL (see Pages 5 and 6).

^B Numerical linearization parameter: uncertainty not required.

^E Uncertainty is determined using the max. deviation from linear response applying rectangular distribution and is expressed for the square of the field value.

DASY/EASY - Parameters of Probe: EX3DV4 - SN:3979

Calibration Parameter Determined in Head Tissue Simulating Media

f (MHz) ^C	Relative Permittivity ^F	Conductivity (S/m) ^F	ConvF X	ConvF Y	ConvF Z	Alpha ^G	Depth (mm) ^G	Unct. (k=2)
750	41.9	0.89	9.94	9.94	9.94	0.64	0.70	± 12.0 %
835	41.5	0.90	9.50	9.50	9.50	0.27	1.16	± 12.0 %
900	41.5	0.97	9.29	9.29	9.29	0.26	1.19	± 12.0 %
1450	40.5	1.20	8.36	8.36	8.36	0.80	0.58	± 12.0 %
1640	40.3	1.29	8.08	8.08	8.08	0.68	0.78	± 12.0 %
1750	40.1	1.37	8.02	8.02	8.02	0.71	0.73	± 12.0 %
1810	40.0	1.40	7.81	7.81	7.81	0.67	0.74	± 12.0 %
1900	40.0	1.40	7.76	7.76	7.76	0.56	0.83	± 12.0 %
2000	40.0	1.40	7.78	7.78	7.78	0.62	0.76	± 12.0 %
2300	39.5	1.67	7.38	7.38	7.38	0.44	0.87	± 12.0 %
2450	39.2	1.80	7.09	7.09	7.09	0.43	0.88	± 12.0 %
2600	39.0	1.96	6.90	6.90	6.90	0.42	0.97	± 12.0 %
3500	37.9	2.91	7.19	7.19	7.19	0.77	0.66	± 13.1 %
5200	36.0	4.66	4.88	4.88	4.88	0.35	1.80	± 13.1 %
5300	35.9	4.76	4.69	4.69	4.69	0.35	1.80	± 13.1 %
5500	35.6	4.96	4.57	4.57	4.57	0.40	1.80	± 13.1 %
5600	35.5	5.07	4.45	4.45	4.45	0.40	1.80	± 13.1 %
5800	35.3	5.27	4.40	4.40	4.40	0.40	1.80	± 13.1 %

^C Frequency validity above 300 MHz of ± 100 MHz only applies for DASY v4.4 and higher (see Page 2), else it is restricted to ± 50 MHz. The uncertainty is the RSS of the ConvF uncertainty at calibration frequency and the uncertainty for the indicated frequency band. Frequency validity below 300 MHz is ± 10, 25, 40, 50 and 70 MHz for ConvF assessments at 30, 64, 128, 150 and 220 MHz respectively. Above 5 GHz frequency validity can be extended to ± 110 MHz.

^F At frequencies below 3 GHz, the validity of tissue parameters (ϵ and σ) can be relaxed to ± 10% if liquid compensation formula is applied to measured SAR values. At frequencies above 3 GHz, the validity of tissue parameters (ϵ and σ) is restricted to ± 5%. The uncertainty is the RSS of the ConvF uncertainty for indicated target tissue parameters.

^G Alpha/Depth are determined during calibration. SPEAG warrants that the remaining deviation due to the boundary effect after compensation is always less than ± 1% for frequencies below 3 GHz and below ± 2% for frequencies between 3-6 GHz at any distance larger than half the probe tip diameter from the boundary.

DASY/EASY - Parameters of Probe: EX3DV4 - SN:3979

Calibration Parameter Determined in Body Tissue Simulating Media

f (MHz) ^C	Relative Permittivity ^F	Conductivity (S/m) ^F	ConvF X	ConvF Y	ConvF Z	Alpha ^G	Depth ^G (mm)	Unct. (k=2)
750	55.5	0.96	9.79	9.79	9.79	0.44	0.85	± 12.0 %
835	55.2	0.97	9.68	9.68	9.68	0.66	0.69	± 12.0 %
900	55.0	1.05	9.43	9.43	9.43	0.35	0.99	± 12.0 %
1450	54.0	1.30	8.11	8.11	8.11	0.74	0.62	± 12.0 %
1640	53.8	1.40	8.25	8.25	8.25	0.60	0.71	± 12.0 %
1750	53.4	1.49	7.77	7.77	7.77	0.65	0.69	± 12.0 %
1810	53.3	1.52	7.64	7.64	7.64	0.52	0.77	± 12.0 %
1900	53.3	1.52	7.51	7.51	7.51	0.63	0.70	± 12.0 %
2000	53.3	1.52	7.61	7.61	7.61	0.45	0.79	± 12.0 %
2300	52.9	1.81	7.30	7.30	7.30	0.67	0.64	± 12.0 %
2450	52.7	1.95	7.08	7.08	7.08	0.80	0.61	± 12.0 %
2600	52.5	2.16	6.81	6.81	6.81	0.80	0.50	± 12.0 %
3500	51.3	3.31	6.40	6.40	6.40	0.57	0.85	± 13.1 %
5200	49.0	5.30	4.60	4.60	4.60	0.40	1.90	± 13.1 %
5300	48.9	5.42	4.42	4.42	4.42	0.40	1.90	± 13.1 %
5500	48.6	5.65	4.04	4.04	4.04	0.45	1.90	± 13.1 %
5600	48.5	5.77	4.01	4.01	4.01	0.45	1.90	± 13.1 %
5800	48.2	6.00	4.18	4.18	4.18	0.50	1.90	± 13.1 %

^C Frequency validity above 300 MHz of ± 100 MHz only applies for DASY v4.4 and higher (see Page 2), else it is restricted to ± 50 MHz. The uncertainty is the RSS of the ConvF uncertainty at calibration frequency and the uncertainty for the indicated frequency band. Frequency validity below 300 MHz is ± 10, 25, 40, 50 and 70 MHz for ConvF assessments at 30, 64, 128, 150 and 220 MHz respectively. Above 5 GHz frequency validity can be extended to ± 110 MHz.

^F At frequencies below 3 GHz, the validity of tissue parameters (ϵ and σ) can be relaxed to ± 10% if liquid compensation formula is applied to measured SAR values. At frequencies above 3 GHz, the validity of tissue parameters (ϵ and σ) is restricted to ± 5%. The uncertainty is the RSS of the ConvF uncertainty for indicated target tissue parameters.

^G Alpha/Depth are determined during calibration. SPEAG warrants that the remaining deviation due to the boundary effect after compensation is always less than ± 1% for frequencies below 3 GHz and below ± 2% for frequencies between 3-6 GHz at any distance larger than half the probe tip diameter from the boundary.

Frequency Response of E-Field

(TEM-Cell:ifi110 EXX, Waveguide: R22)

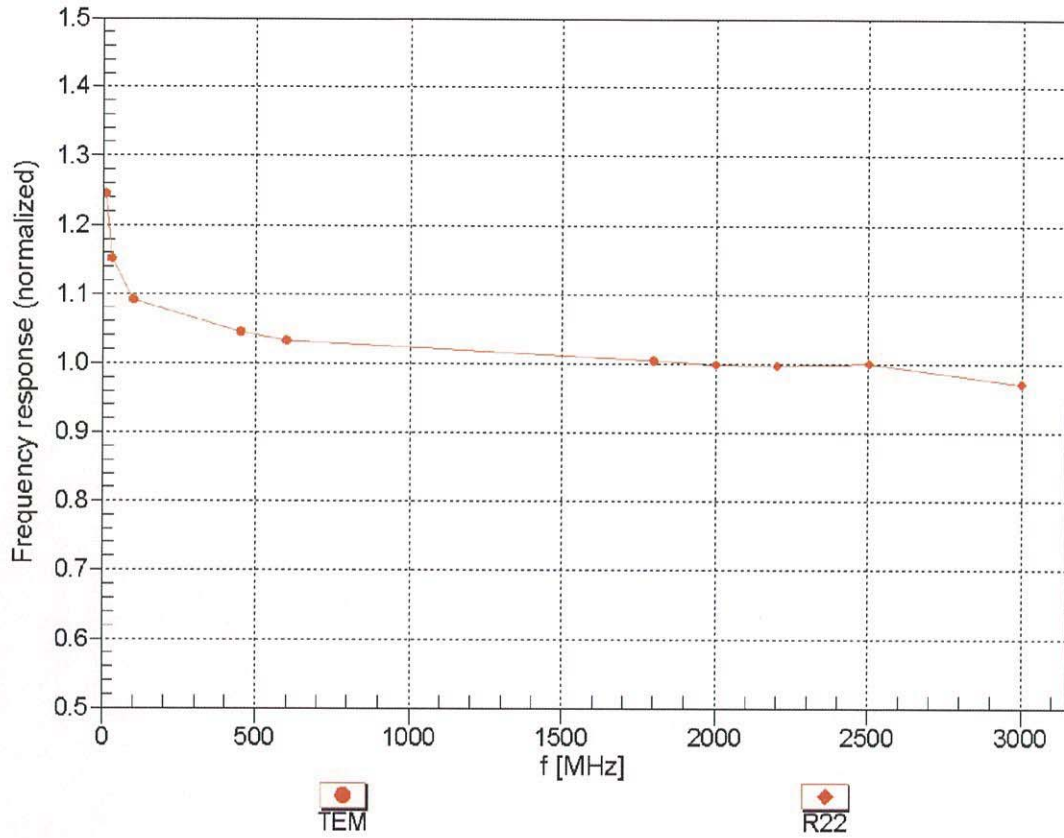

Uncertainty of Frequency Response of E-field: $\pm 6.3\%$ (k=2)

Receiving Pattern (ϕ), $\vartheta = 0^\circ$

f=600 MHz, TEM

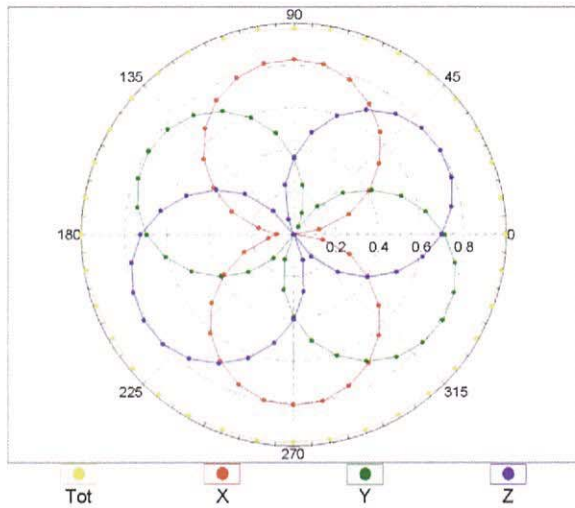

f=1800 MHz, R22

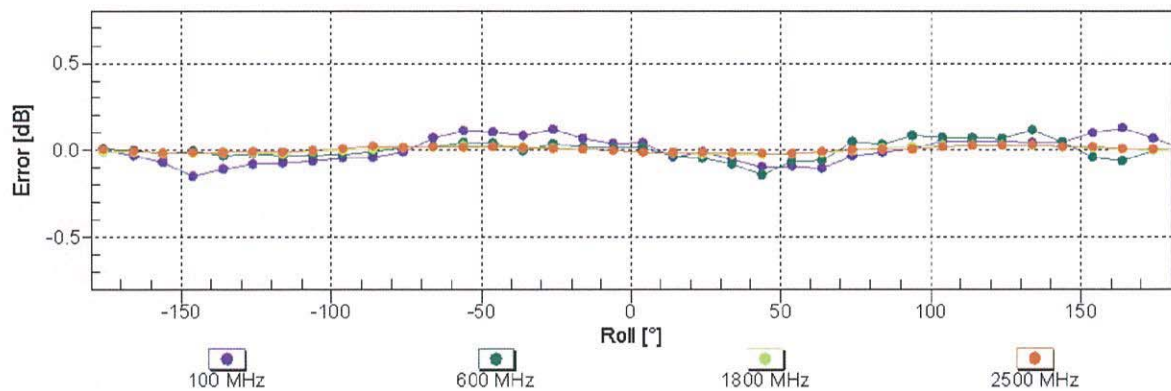
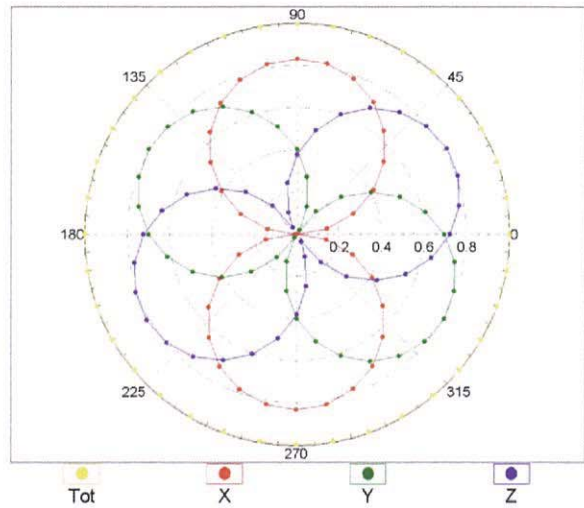

Uncertainty of Axial Isotropy Assessment: $\pm 0.5\%$ ($k=2$)

Dynamic Range $f(SAR_{head})$ (TEM cell , $f_{eval}= 1900$ MHz)

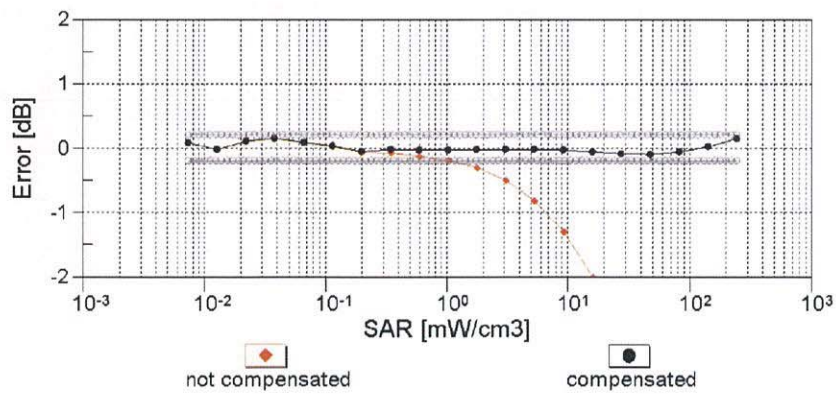
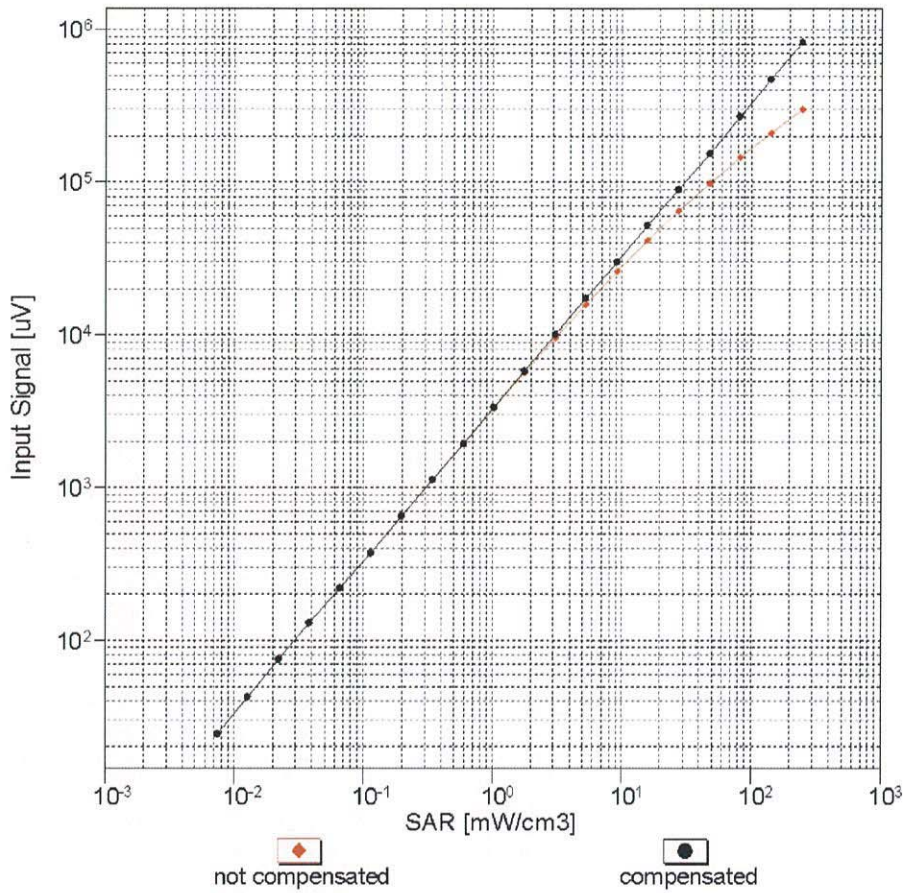

Uncertainty of Linearity Assessment: $\pm 0.6\%$ (k=2)

Conversion Factor Assessment

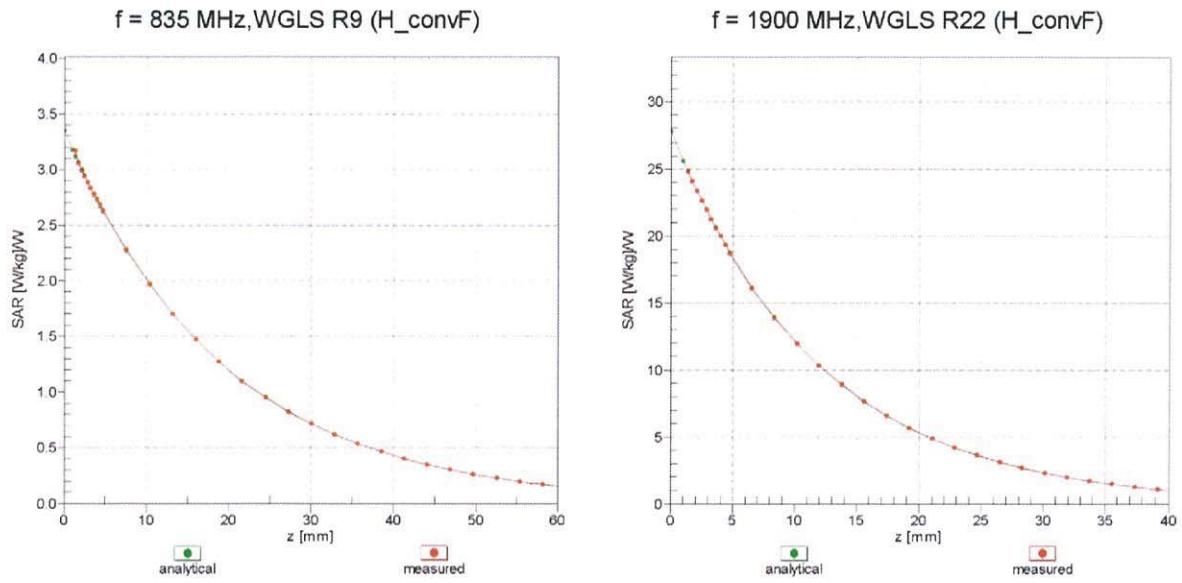

Deviation from Isotropy in Liquid Error (ϕ, ϑ), f = 900 MHz

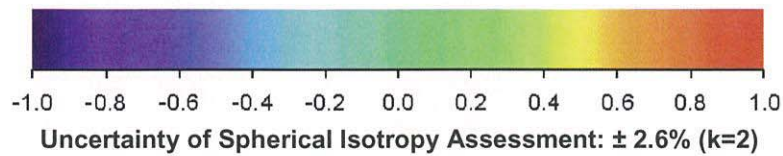
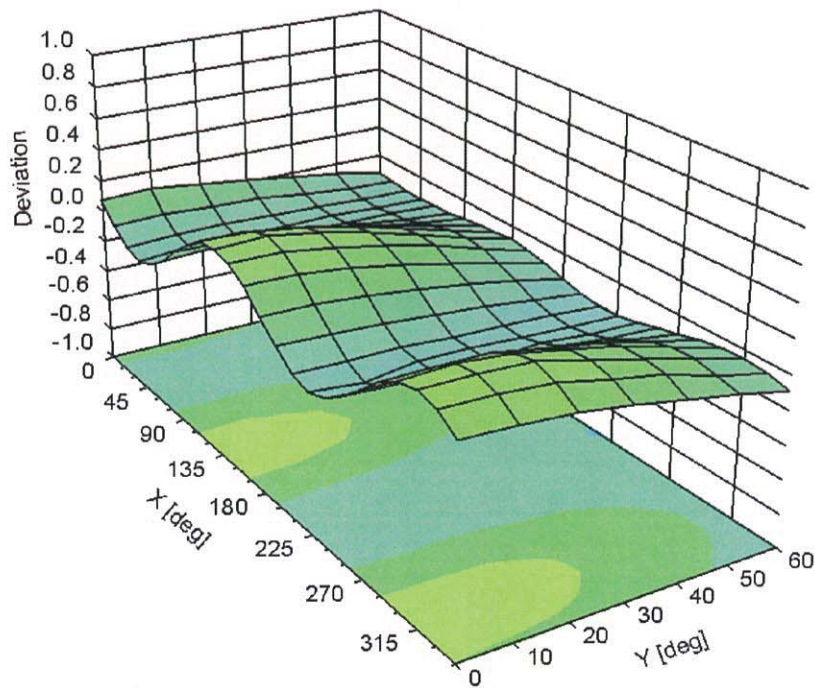

DASY/EASY - Parameters of Probe: EX3DV4 - SN:3979**Other Probe Parameters**

Sensor Arrangement	Triangular
Connector Angle (°)	-46.1
Mechanical Surface Detection Mode	enabled
Optical Surface Detection Mode	disabled
Probe Overall Length	337 mm
Probe Body Diameter	10 mm
Tip Length	9 mm
Tip Diameter	2.5 mm
Probe Tip to Sensor X Calibration Point	1 mm
Probe Tip to Sensor Y Calibration Point	1 mm
Probe Tip to Sensor Z Calibration Point	1 mm
Recommended Measurement Distance from Surface	1.4 mm