

# FCC Test Report

Product Name	TABLET PC
Model No	PA-501
FCC ID	2ABTU-PA-501

Applicant	RuggON Corporation
Address	3F., No.10, Ln. 181, Sec. 2, Jiuzong Rd., Neihu Dist., Taipei City , Taiwan

Date of Receipt	Apr. 10, 2014
Issued Date	Jul. 09, 2015
Report No.	1540249R-RFUSP72V00
Report Version	V1.0



The test results relate only to the samples tested.

The test results shown in the test report are traceable to the national/international standard through the calibration report of the equipment and evaluated measurement uncertainty herein.

This report must not be used to claim product endorsement by TAF or any agency of the government.

The test report shall not be reproduced without the written approval of QuieTek Corporation.

# Test Report

Issued Date: Jul. 09, 2015

Report No.: 1540249R-RFUSP72V00



Product Name	TABLET PC
Applicant	RuggON Corporation
Address	3F., No.10, Ln. 181, Sec. 2, Jiuzong Rd., Neihu Dist., Taipei City , Taiwan
Manufacturer	Ubiqonn Technology, Inc.
Model No.	PA-501
FCC ID.	2ABTU-PA-501
EUT Rated Voltage	AC 100-240V, 50/0Hz
EUT Test Voltage	AC 120V/60Hz
Trade Name	RuggON
Applicable Standard	FCC CFR Title 47 Part 15 Subpart E: 2014 ANSI C63.4: 2014, ANSI C63.10: 2013 789033 D02 General UNII Test Procedures New Rules v01
Test Result	Complied

Documented By : Jinn Chen  
( Senior Adm. Specialist / Jinn Chen )

Tested By : Eason chen  
( Engineer / Eason Chen )

Approved By : [Signature]  
( Director / Vincent Lin )

## TABLE OF CONTENTS

Description	Page
<b>1. GENERAL INFORMATION .....</b>	<b>5</b>
1.1. EUT Description.....	5
1.2. Operational Description .....	7
1.3. Tested System Details.....	8
1.4. Configuration of tested System .....	8
1.5. EUT Exercise Software .....	8
1.6. Test Facility .....	9
<b>2. Conducted Emission.....</b>	<b>10</b>
2.1. Test Equipment.....	10
2.2. Test Setup .....	10
2.3. Limits .....	11
2.4. Test Procedure .....	11
2.5. Uncertainty .....	11
2.6. Test Result of Conducted Emission.....	12
<b>3. Maximun conducted output power .....</b>	<b>20</b>
3.1. Test Equipment.....	20
3.2. Test Setup .....	20
3.3. Limits .....	21
3.4. Test Procedure .....	22
3.5. Uncertainty .....	22
3.6. Test Result of Maximum conducted output power.....	23
<b>4. Peak Power Spectral Density.....</b>	<b>33</b>
4.1. Test Equipment.....	33
4.2. Test Setup .....	33
4.3. Limits .....	33
4.4. Test Procedure .....	34
4.5. Uncertainty .....	34
4.6. Test Result of Peak Power Spectral Density .....	35
<b>5. Radiated Emission.....</b>	<b>49</b>
5.1. Test Equipment.....	49
5.2. Test Setup .....	49
5.3. Limits .....	50
5.4. Test Procedure .....	51
5.5. Uncertainty .....	51
5.6. Test Result of Radiated Emission.....	52
<b>6. Band Edge .....</b>	<b>84</b>
6.1. Test Equipment.....	84
6.2. Test Setup .....	84
6.3. Limits .....	85
6.4. Test Procedure .....	85
6.5. Uncertainty .....	85
6.6. Test Result of Band Edge .....	86
<b>7. Occupied Bandwidth.....</b>	<b>102</b>

---

7.1.	Test Equipment.....	102
7.2.	Test Setup .....	102
7.3.	Limits .....	102
7.4.	.Test Procedure .....	102
7.5.	Uncertainty .....	102
7.6.	Test Result of Occupied Bandwidth .....	103
<b>8.</b>	<b>Frequency Stability.....</b>	<b>109</b>
8.1.	Test Equipment.....	109
8.2.	Test Setup .....	109
8.3.	Limits .....	109
8.4.	Test Procedure .....	109
8.5.	Uncertainty .....	109
8.6.	Test Result of Frequency Stability.....	110
<b>9.</b>	<b>EMI Reduction Method During Compliance Testing .....</b>	<b>113</b>

Attachment 1: EUT Test Photographs  
Attachment 2: EUT Detailed Photographs

**1. GENERAL INFORMATION**

**1.1. EUT Description**

Product Name	TABLET PC
Trade Name	RuggON
FCC ID.	2ABTU-PA-501
Model No.	PA-501
Frequency Range	802.11a/n-20MHz: 5180-5320MHz, 5500-5700MHz, 5745-5825MHz
Number of Channels	802.11a/n-20MHz: 24
Data Rate	802.11a: 6 - 54Mbps, 802.11n: up to 72.2Mbps
Channel Control	Auto
Type of Modulation	802.11a/n:OFDM, BPSK, QPSK, 16QAM, 64QAM
Antenna type	PIFA Antenna
Antenna Gain	Refer to the table “Antenna List”
Power Adapter	MFR: FSP, M/N: FSP065-REB Input: 100-240V~1.5A, 50-60Hz Output: 19V $\overline{=}$ 3.42A Cable Out: Non-shielded, 1.8m

**Antenna List**

No.	Manufacturer	Part No.	Antenna Type	Peak Gain
1	Ethertronics Inc.	5001791 (Main) 5001799 (Aux)	PIFA Antenna	5.1dBi For 5.15~5.25GHz 5.1dBi For 5.25~5.35GHz 4.2dBi For 5.47~5.725GHz 2.6dBi For 5.725~5.850GHz

Note: The antenna of EUT is conform to FCC 15.203

802.11a/n-20MHz Center Working Frequency of Each Channel:

Channel	Frequency	Channel	Frequency	Channel	Frequency	Channel	Frequency
Channel 36:	5180 MHz	Channel 40:	5200 MHz	Channel 44:	5220 MHz	Channel 48:	5240 MHz
Channel 52:	5260 MHz	Channel 56:	5280 MHz	Channel 60:	5300 MHz	Channel 64:	5320 MHz
Channel 100:	5500 MHz	Channel 104:	5520 MHz	Channel 108:	5540 MHz	Channel 112:	5560 MHz
Channel 116:	5580 MHz	Channel 120:	5600 MHz	Channel 124:	5620 MHz	Channel 128:	5640 MHz
Channel 132:	5660 MHz	Channel 136:	5680 MHz	Channel 140:	5700 MHz	Channel 149:	5745 MHz
Channel 153:	5765 MHz	Channel 157:	5785 MHz	Channel 161:	5805 MHz	Channel 165:	5825 MHz

Note:

1. This device is a TABLET PC with a built-in 802.11a/b/g/n WLAN transceiver.
2. Regarding to the operation frequency, the lowest, middle and highest frequency are selected to perform the test.
3. At result of pretests, module supports dual-channel transmission, only the worst case is shown in the report.
4. Lowest and highest data rates are tested in each mode. Only worst case is shown in the report. (802.11a is 6Mbps 、 802.11n-20BW is 7.2Mbps)
5. These tests were conducted on a sample of the equipment for the purpose of demonstrating compliance with Part 15 Subpart E for Unlicensed National Information Infrastructure devices.
6. The radiation measurements are performed in X, Y, Z axis positioning. Only the worst case is shown in the report.

Test Mode	Mode 1: Transmit (802.11a-6Mbps) Mode 2: Transmit (802.11n-20BW 7.2Mbps)
-----------	---

### 1.3. Tested System Details

The types for all equipment, plus descriptions of all cables used in the tested system (including inserted cards) are:

	Product	Manufacturer	Model No.	Serial No.	Power Cord
(1)	Notebook PC	DELL	PPT	N/A	Non-Shielded, 0.8m
(2)	Monitor	DELL	ST2320L	N/A	N/A
(3)	FLASH	Transcend	JetFlash110	155422-2931	Non-Shielded, 1.8m
(4)	Earphone	AIWA	N/A	N/A	N/A

Signal Cable Type	Signal cable Description
A	RS-232 Cable
B	HDMI Cable
C	Earphone Cable
D	Micro USB Cable
E	RJ45 Cable

### 1.4. Configuration of tested System

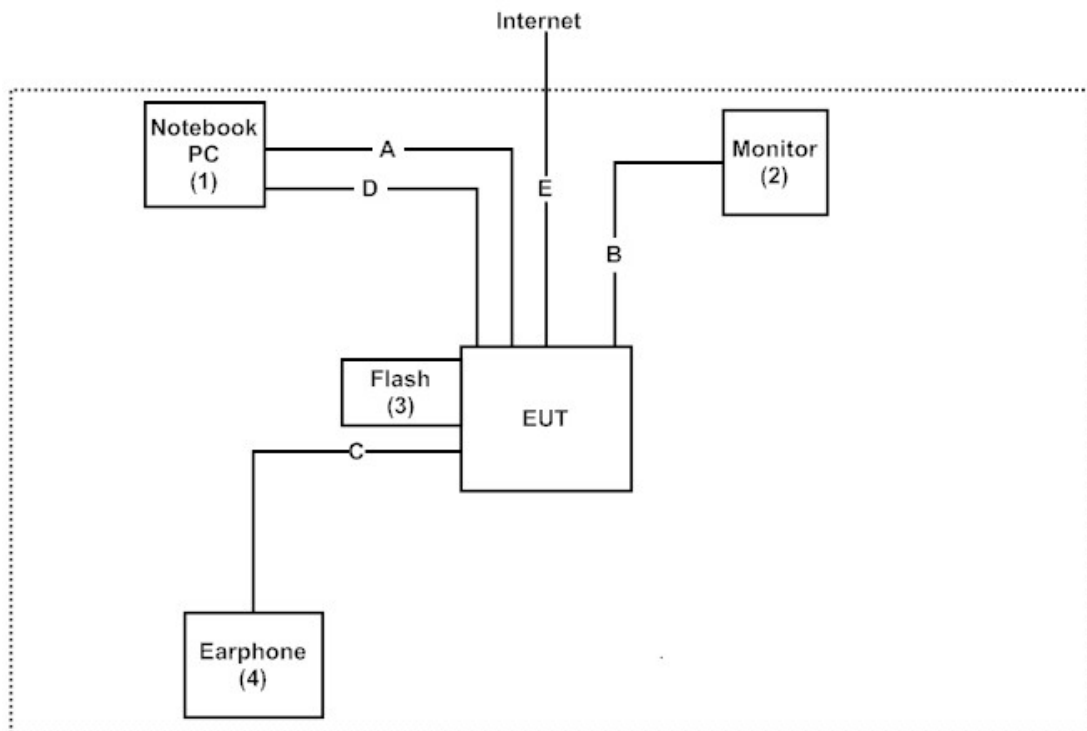

### 1.5. EUT Exercise Software

- (1) Setup the EUT as shown in Section 1.3.
- (2) Execute software on the EUT.
- (3) Configure the test mode, the test channel, and the data rate.
- (4) Press “OK” to start the continuous Transmit.
- (5) Verify that the EUT works properly.

**1.6. Test Facility**

Ambient conditions in the laboratory:

Items	Required (IEC 68-1)	Actual
Temperature (°C)	15-35	20-35
Humidity (%RH)	25-75	50-65
Barometric pressure (mbar)	860-1060	950-1000

The related certificate for our laboratories about the test site and management system can be downloaded from Quietek Corporation's Web Site : <http://www.quietek.com/chinese/about/certificates.aspx?bval=5>

The address and introduction of Quietek Corporation's laboratories can be founded in our Web site : <http://www.quietek.com/>

Site Description: File on  
 Federal Communications Commission  
 FCC Engineering Laboratory  
 7435 Oakland Mills Road  
 Columbia, MD 21046  
 Registration Number: 92195

Site Name: Quietek Corporation  
 Site Address: No. 5-22, Ruei-Shu Valley, Ruei-Ping Tsuen,  
 Lin-Kou Shiang, Taipei,  
 Taiwan, R.O.C.  
 TEL: 886-2-8601-3788 / FAX : 886-2-8601-3789  
 E-Mail : [service@quietek.com](mailto:service@quietek.com)

FCC Accreditation Number: TW1014



## 2. Conducted Emission

### 2.1. Test Equipment

	Equipment	Manufacturer	Model No. / Serial No.	Last Cal.	Remark
X	Test Receiver	R & S	ESCS 30 / 825442/018	Sep., 2014	
X	Artificial Mains Network	R & S	ENV4200 / 848411/10	Feb., 2015	Peripherals
X	LISN	R & S	ESH3-Z5 / 825562/002	Feb., 2015	EUT
	DC LISN	Schwarzbeck	8226 / 176	Mar, 2015	EUT
X	Pulse Limiter	R & S	ESH3-Z2 / 357.8810.52	Feb., 2015	
	No.1 Shielded Room				

Note:

1. All equipments are calibrated every one year.
2. The test instruments marked by “X” are used to measure the final test results.

### 2.2. Test Setup

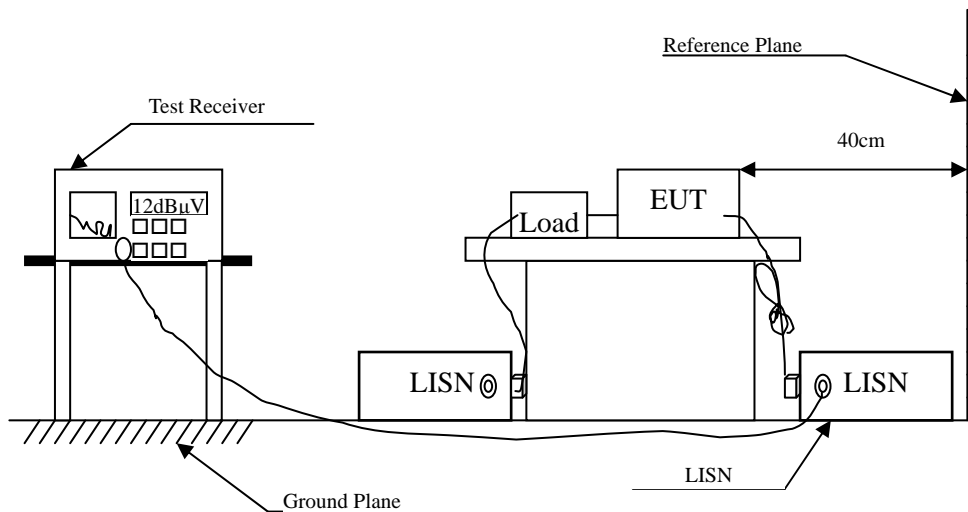

### 2.3. Limits

<b>FCC Part 15 Subpart C Paragraph 15.207 (dBμV) Limit</b>		
Frequency MHz	Limits	
	QP	AV
0.15 - 0.50	66-56	56-46
0.50-5.0	56	46
5.0 - 30	60	50

Remarks : In the above table, the tighter limit applies at the band edges.

### 2.4. Test Procedure

The EUT and simulators are connected to the main power through a line impedance stabilization network (L.I.S.N.). This provides a 50 ohm /50uH coupling impedance for the measuring equipment. The peripheral devices are also connected to the main power through a LISN that provides a 50ohm /50uH coupling impedance with 50ohm termination. (Please refers to the block diagram of the test setup and photographs.)

Both sides of A.C. line are checked for maximum conducted interference. In order to find the maximum emission, the relative positions of equipment and all of the interface cables must be changed according to ANSI C63.10:2013 on conducted measurement.

Conducted emissions were investigated over the frequency range from 0.15MHz to 30MHz using a receiver bandwidth of 9kHz.

The EUT was setup to ANSI C63.10, 2014; tested to UNII test procedure of FCC KDB-789033 for compliance to FCC 47CFR Subpart E requirements.

### 2.5. Uncertainty

± 2.26 dB

## 2.6. Test Result of Conducted Emission

Product : TABLET PC  
 Test Item : Conducted Emission Test  
 Power Line : Line 1  
 Test Mode : Mode 2: Transmit (802.11n-20BW 7.2Mbps) (5220MHz)

Frequency MHz	Correct Factor dB	Reading Level dB $\mu$ V	Measurement Level dB $\mu$ V	Margin dB	Limit dB $\mu$ V
<b>LINE 1</b>					
<b>Quasi-Peak</b>					
0.170	9.665	37.090	46.755	-18.674	65.429
0.212	9.661	29.450	39.111	-25.118	64.229
0.709	9.688	15.770	25.458	-30.542	56.000
3.005	9.807	24.000	33.807	-22.193	56.000
12.193	9.981	13.060	23.041	-36.959	60.000
24.002	10.058	26.430	36.488	-23.512	60.000
<b>Average</b>					
0.170	9.665	23.140	32.805	-22.624	55.429
0.212	9.661	15.580	25.241	-28.988	54.229
0.709	9.688	4.060	13.748	-32.252	46.000
3.005	9.807	12.350	22.157	-23.843	46.000
12.193	9.981	7.130	17.111	-32.889	50.000
24.002	10.058	24.090	34.148	-15.852	50.000

Note:

1. All Reading Levels are Quasi-Peak and average value.
2. "■" means the worst emission level.
3. Measurement Level = Reading Level + Correct Factor

Product : TABLET PC  
 Test Item : Conducted Emission Test  
 Power Line : Line 2  
 Test Mode : Mode 2: Transmit (802.11n-20BW 7.2Mbps) (5220MHz)

Frequency MHz	Correct Factor dB	Reading Level dBμV	Measurement Level dBμV	Margin dB	Limit dBμV
<b>LINE 2</b>					
<b>Quasi-Peak</b>					
0.177	9.663	33.930	43.593	-21.636	65.229
0.216	9.661	29.050	38.711	-25.403	64.114
0.849	9.696	15.250	24.946	-31.054	56.000
2.935	9.797	23.680	33.477	-22.523	56.000
19.459	10.187	17.360	27.547	-32.453	60.000
24.002	10.238	25.940	36.178	-23.822	60.000
<b>Average</b>					
0.177	9.663	23.800	33.463	-21.766	55.229
0.216	9.661	14.300	23.961	-30.153	54.114
0.849	9.696	5.840	15.536	-30.464	46.000
2.935	9.797	9.930	19.727	-26.273	46.000
19.459	10.187	12.260	22.447	-27.553	50.000
24.002	10.238	23.570	33.808	-16.192	50.000

Note:

1. All Reading Levels are Quasi-Peak and average value.
2. "■" means the worst emission level.
3. Measurement Level = Reading Level + Correct Factor

Product : TABLET PC  
 Test Item : Conducted Emission Test  
 Power Line : Line 1  
 Test Mode : Mode 2: Transmit (802.11n-20BW 7.2Mbps) (5300MHz)

Frequency MHz	Correct Factor dB	Reading Level dBμV	Measurement Level dBμV	Margin dB	Limit dBμV
<b>LINE 1</b>					
<b>Quasi-Peak</b>					
0.162	9.667	37.940	47.607	-18.050	65.657
0.713	9.688	17.970	27.658	-28.342	56.000
0.806	9.693	16.700	26.393	-29.607	56.000
2.720	9.792	20.940	30.732	-25.268	56.000
3.048	9.809	23.690	33.499	-22.501	56.000
24.002	10.058	25.860	35.918	-24.082	60.000
<b>Average</b>					
0.162	9.667	23.470	33.137	-22.520	55.657
0.713	9.688	2.800	12.488	-33.512	46.000
0.806	9.693	2.020	11.713	-34.287	46.000
2.720	9.792	10.540	20.332	-25.668	46.000
3.048	9.809	12.170	21.979	-24.021	46.000
24.002	10.058	23.400	33.458	-16.542	50.000

Note:

1. All Reading Levels are Quasi-Peak and average value.
2. "■" means the worst emission level.
3. Measurement Level = Reading Level + Correct Factor

Product : TABLET PC  
 Test Item : Conducted Emission Test  
 Power Line : Line 2  
 Test Mode : Mode 2: Transmit (802.11n-20BW 7.2Mbps) (5300MHz)

Frequency MHz	Correct Factor dB	Reading Level dBμV	Measurement Level dBμV	Margin dB	Limit dBμV
<b>LINE 2</b>					
<b>Quasi-Peak</b>					
0.166	9.667	37.820	47.486	-18.057	65.543
0.357	9.669	18.570	28.239	-31.847	60.086
0.806	9.693	17.240	26.933	-29.067	56.000
2.630	9.790	19.320	29.110	-26.890	56.000
11.611	10.025	8.660	18.685	-41.315	60.000
24.002	10.238	25.270	35.508	-24.492	60.000
<b>Average</b>					
0.166	9.667	11.540	21.206	-34.337	55.543
0.357	9.669	9.750	19.419	-30.667	50.086
0.806	9.693	5.020	14.713	-31.287	46.000
2.630	9.790	9.240	19.030	-26.970	46.000
11.611	10.025	4.230	14.255	-35.745	50.000
24.002	10.238	22.860	33.098	-16.902	50.000

Note:

1. All Reading Levels are Quasi-Peak and average value.
2. "■" means the worst emission level.
3. Measurement Level = Reading Level + Correct Factor

Product : TABLET PC  
 Test Item : Conducted Emission Test  
 Power Line : Line 1  
 Test Mode : Mode 2: Transmit (802.11n-20BW 7.2Mbps) (5580MHz)

Frequency MHz	Correct Factor dB	Reading Level dBμV	Measurement Level dBμV	Margin dB	Limit dBμV
<b>LINE 1</b>					
<b>Quasi-Peak</b>					
0.170	9.665	37.050	46.715	-18.714	65.429
0.216	9.661	29.070	38.731	-25.383	64.114
0.775	9.692	17.410	27.102	-28.898	56.000
2.959	9.797	24.080	33.877	-22.123	56.000
20.177	10.062	17.470	27.532	-32.468	60.000
24.002	10.058	25.840	35.898	-24.102	60.000
<b>Average</b>					
0.170	9.665	8.570	18.235	-37.194	55.429
0.216	9.661	13.150	22.811	-31.303	54.114
0.775	9.692	0.640	10.332	-35.668	46.000
2.959	9.797	13.770	23.567	-22.433	46.000
20.177	10.062	10.610	20.672	-29.328	50.000
24.002	10.058	23.400	33.458	-16.542	50.000

Note:

1. All Reading Levels are Quasi-Peak and average value.
2. "■" means the worst emission level.
3. Measurement Level = Reading Level + Correct Factor

Product : TABLET PC  
 Test Item : Conducted Emission Test  
 Power Line : Line 2  
 Test Mode : Mode 2: Transmit (802.11n-20BW 7.2Mbps) (5580MHz)

Frequency MHz	Correct Factor dB	Reading Level dBμV	Measurement Level dBμV	Margin dB	Limit dBμV
<b>LINE 2</b>					
<b>Quasi-Peak</b>					
0.166	9.667	37.860	47.526	-18.017	65.543
0.220	9.662	28.160	37.822	-26.178	64.000
0.791	9.693	17.560	27.253	-28.747	56.000
2.939	9.797	24.080	33.877	-22.123	56.000
19.701	10.199	17.420	27.619	-32.381	60.000
24.002	10.238	25.480	35.718	-24.282	60.000
<b>Average</b>					
0.166	9.667	23.560	33.226	-22.317	55.543
0.220	9.662	15.520	25.182	-28.818	54.000
0.791	9.693	4.880	14.573	-31.427	46.000
2.939	9.797	12.660	22.457	-23.543	46.000
19.701	10.199	10.360	20.559	-29.441	50.000
24.002	10.238	23.120	33.358	-16.642	50.000

Note:

1. All Reading Levels are Quasi-Peak and average value.
2. "■" means the worst emission level.
3. Measurement Level = Reading Level + Correct Factor



Product : TABLET PC  
 Test Item : Conducted Emission Test  
 Power Line : Line 1  
 Test Mode : Mode 2: Transmit (802.11n-20BW 7.2Mbps) (5785MHz)

Frequency MHz	Correct Factor dB	Reading Level dBμV	Measurement Level dBμV	Margin dB	Limit dBμV
<b>LINE 1</b>					
<b>Quasi-Peak</b>					
0.173	9.664	35.860	45.524	-19.819	65.343
0.220	9.662	28.340	38.002	-25.998	64.000
0.728	9.689	19.090	28.779	-27.221	56.000
3.013	9.808	23.660	33.468	-22.532	56.000
12.084	9.980	13.000	22.980	-37.020	60.000
24.002	10.058	25.820	35.878	-24.122	60.000
<b>Average</b>					
0.173	9.664	26.530	36.194	-19.149	55.343
0.220	9.662	20.410	30.072	-23.928	54.000
0.728	9.689	3.720	13.409	-32.591	46.000
3.013	9.808	8.400	18.208	-27.792	46.000
12.084	9.980	8.070	18.050	-31.950	50.000
24.002	10.058	23.250	33.308	-16.692	50.000

Note:

1. All Reading Levels are Quasi-Peak and average value.
2. "■" means the worst emission level.
3. Measurement Level = Reading Level + Correct Factor

Product : TABLET PC  
 Test Item : Conducted Emission Test  
 Power Line : Line 2  
 Test Mode : Mode 2: Transmit (802.11n-20BW 7.2Mbps) (5785MHz)

Frequency MHz	Correct Factor dB	Reading Level dBμV	Measurement Level dBμV	Margin dB	Limit dBμV
<b>LINE 2</b>					
<b>Quasi-Peak</b>					
0.166	9.667	37.860	47.526	-18.017	65.543
0.216	9.661	28.970	38.631	-25.483	64.114
0.709	9.688	17.580	27.268	-28.732	56.000
3.017	9.808	24.140	33.948	-22.052	56.000
19.740	10.199	17.480	27.679	-32.321	60.000
24.002	10.238	25.580	35.818	-24.182	60.000
<b>Average</b>					
0.166	9.667	23.560	33.226	-22.317	55.543
0.216	9.661	15.640	25.301	-28.813	54.114
0.709	9.688	5.690	15.378	-30.622	46.000
3.017	9.808	12.520	22.328	-23.672	46.000
19.740	10.199	10.250	20.449	-29.551	50.000
24.002	10.238	23.200	33.438	-16.562	50.000

Note:

1. All Reading Levels are Quasi-Peak and average value.
2. “█” means the worst emission level.
3. Measurement Level = Reading Level + Correct Factor

### 3. Maximun conducted output power

#### 3.1. Test Equipment

	Equipment	Manufacturer	Model No./Serial No.	Last Cal.
X	Power Meter	Anritsu	ML2495A/6K00003357	May, 2015
X	Power Sensor	Anritsu	MA2411B/0738448	Jun., 2015
X	Spectrum Analyzer	Agilent	N9010A / MY48030495	Apr., 2015

Note:

1. All equipments are calibrated with traceable calibrations. Each calibration is traceable to the national or international standards.
2. The test instruments marked with “X” are used to measure the final test results.

#### 3.2. Test Setup

##### 99% Occupied Bandwidth

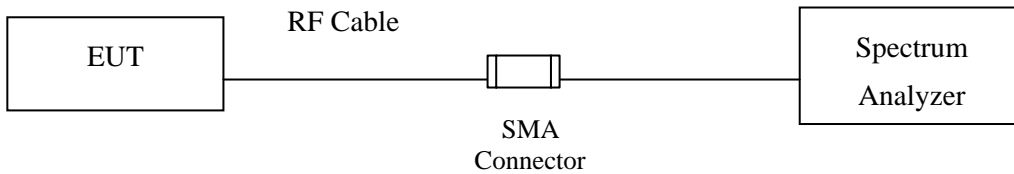

##### Conduction Power Measurement (for 802.11a)

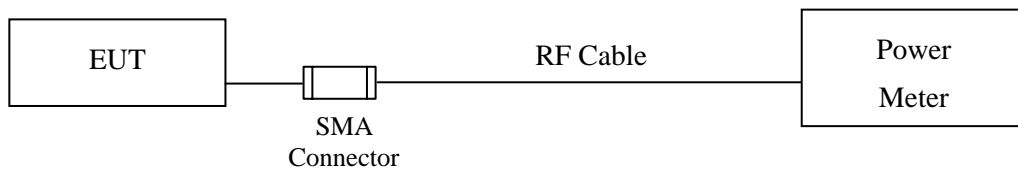

##### Conduction Power Measurement (for 802.11ac)

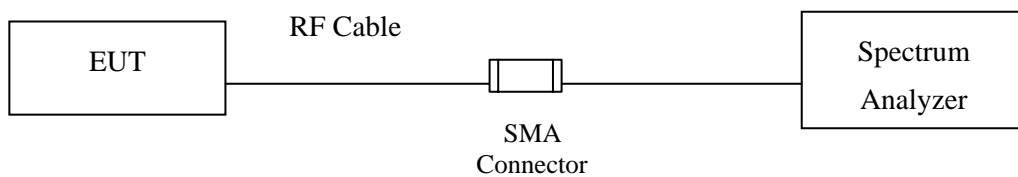

### 3.3. Limits

#### 3.3.1. For the band 5.15-5.25 GHz,

(i) For an outdoor access point operating in the band 5.15-5.25 GHz, the maximum conducted output power over the frequency band of operation shall not exceed 1 W, provided the maximum antenna gain does not exceed 6 dBi. If transmitting antennas of directional gain greater than 6 dBi are used, the maximum conducted output power shall be reduced by the amount in dB that the directional gain of the antenna exceeds 6 dBi. The maximum e.i.r.p. at any elevation angle above 30 degrees as measured from the horizon must not exceed 125 mW (21 dBm).

(ii) For an indoor access point operating in the band 5.15-5.25 GHz, the maximum conducted output power over the frequency band of operation shall not exceed 1 W provided the maximum antenna gain does not exceed 6 dBi. In addition. If transmitting antennas of directional gain greater than 6 dBi are used, the maximum conducted output power shall be reduced by the amount in dB that the directional gain of the antenna exceeds 6 dBi.

(iii) For fixed point-to-point access points operating in the band 5.15-5.25 GHz, the maximum conducted output power over the frequency band of operation shall not exceed 1 W. Fixed point-to-point U-NII devices may employ antennas with directional gain up to 23 dBi without any corresponding reduction in the maximum conducted output power. For fixed point-to-point transmitters that employ a directional antenna gain greater than 23 dBi, a 1 dB reduction in maximum conducted output power is required for each 1 dB of antenna gain in excess of 23 dBi. Fixed, point-to-point operations exclude the use of point-to-multipoint systems, omnidirectional applications, and multiple collocated transmitters transmitting the same information. The operator of the U-NII device, or if the equipment is professionally installed, the installer, is responsible for ensuring that systems employing high gain directional antennas are used exclusively for fixed, point-to-point operations.

(iv) For mobile and portable client devices in the 5.15-5.25 GHz band, the maximum conducted output power over the frequency band of operation shall not exceed 250 mW provided the maximum antenna gain does not exceed 6 dBi. In addition. If transmitting antennas of directional gain greater than 6 dBi are used, the maximum conducted output power shall be reduced by the amount in dB that the directional gain of the antenna exceeds 6 dBi.

3.3.2. For the 5.25-5.35 GHz and 5.47-5.725 GHz bands, the maximum conducted output power over the frequency bands of operation shall not exceed the lesser of 250 mW or  $11 \text{ dBm} + 10 \log B$ , where B is the 26 dB emission bandwidth in megahertz. If transmitting antennas of directional gain greater than 6 dBi are used, the maximum conducted output power shall be reduced by the amount in dB that the directional gain of the antenna exceeds 6 dBi.

3.3.3. For the band 5.725-5.85 GHz, the maximum conducted output power over the frequency band of operation shall not exceed 1 W. In addition. If transmitting antennas of directional gain greater than 6 dBi are used, the maximum conducted output power shall be reduced by the amount in dB that the directional gain of the antenna exceeds 6 dBi. However, fixed point-to-point UNII devices operating in this band may employ transmitting antennas with directional gain greater than 6 dBi without any

corresponding reduction in transmitter conducted power. Fixed, point-to-point operations exclude the use of point-to-multipoint systems, omnidirectional applications, and multiple collocated transmitters transmitting the same information. The operator of the U-NII device, or if the equipment is professionally installed, the installer, is responsible for ensuring that systems employing high gain directional antennas are used exclusively for fixed, point-to-point operations.

### 3.4. Test Procedure

As an alternative to FCC KDB-789033, the EUT maximum conducted output power was measured with an average power meter employing a video bandwidth greater the 6dB BW of the emission under test. Maximum conducted output power was read directly from the meter across all data rates, and across three channels within each sub-band. Special care was used to make sure that the EUT was transmitting in continuous mode. This method exceeds the limitations of FCC KDB-789033, and provides more accurate measurements.

802.11an (BW  $\leq$  40MHz) Maximum conducted output power using KDB 789033 section E)3)b) Method PM-G (Measurement using a gated RF average power meter)

Note: the power meter have a video bandwidth that is greater than or equal to the measurement bandwidth, (Anritsu/ MA2411B video bandwidth: 65MHz)

802.11ac (BW=80MHz) Maximum conducted output power using KDB 789033 section E)2)b) Method SA-1 (trace averaging with the EUT transmitting at full power throughout each sweep).

When transmitted signals consist of two or more non-contiguous spectrum segments (e.g., 80+80 MHz mode) or when a single spectrum segment of a transmission crosses the boundary between two adjacent U-NII bands, KDB 644545 D01 section F) procedure is used for measurements.

### 3.5. Uncertainty

$\pm 1.27$  dB

### 3.6. Test Result of Maximum conducted output power

Product : TABLET PC  
 Test Item : Maximum conducted output power  
 Test Site : No.3 OATS  
 Test Mode : Mode 1: Transmit (802.11a-6Mbps)

Cable loss=1dB		Maximum conducted output power								
Channel No.	Frequency (MHz)	Data Rate (Mbps)								Required Limit
		6	9	12	18	24	36	48	54	
		Measurement Level (dBm)								
36	5180	14.29	--	--	--	--	--	--	--	<24dBm
44	5220	14.57	14.21	14.18	14.11	14.08	13.98	13.85	13.81	<24dBm
48	5240	14.36	--	--	--	--	--	--	--	<24dBm
52	5260	14.22	--	--	--	--	--	--	--	<24dBm
60	5300	14.47	14.28	14.16	14.07	14.01	13.94	13.86	13.79	<24dBm
64	5320	14.58	--	--	--	--	--	--	--	<24dBm
100	5500	14.48	--	--	--	--	--	--	--	<24dBm
116	5580	14.29	14.27	14.22	14.17	14.16	14.04	13.98	13.91	<24dBm
140	5700	14.45	--	--	--	--	--	--	--	<24dBm
149	5745	13.77	--	--	--	--	--	--	--	<30dBm
157	5785	14.07	13.99	13.83	13.74	13.66	13.53	13.47	13.35	<30dBm
165	5825	14.02	--	--	--	--	--	--	--	<30dBm

Note: Maximum conducted output power Value =Reading value on average power meter + cable loss

**Maximum conducted output power Measurement:**

Channel No	Frequency Range (MHz)	99% Bandwidth (MHz)	Output Power (dBm)	Output Power Limit	
				(dBm)	dBm+10log(BW)
36	5180	--	14.29	24	--
44	5220	--	14.57	24	--
48	5240	--	14.36	24	--
52	5260	17.900	14.22	24	23.53
60	5300	18.014	14.47	24	23.56
64	5320	18.144	14.58	24	23.59
100	5500	18.511	14.48	24	23.67
116	5580	18.931	14.29	24	23.77
140	5700	19.099	14.45	24	23.81
149	5745	--	13.77	30	--
157	5785	--	14.07	30	--
165	5825	--	14.02	30	--

Note:

1. Power Output Value =Reading value on average power meter + cable loss
2. 99% Bandwidth is the bandwidth of chain A or chain B whichever is less bandwidth; output power limitation is more stringent.

### 99% Occupied Bandwidth: Channel 52:

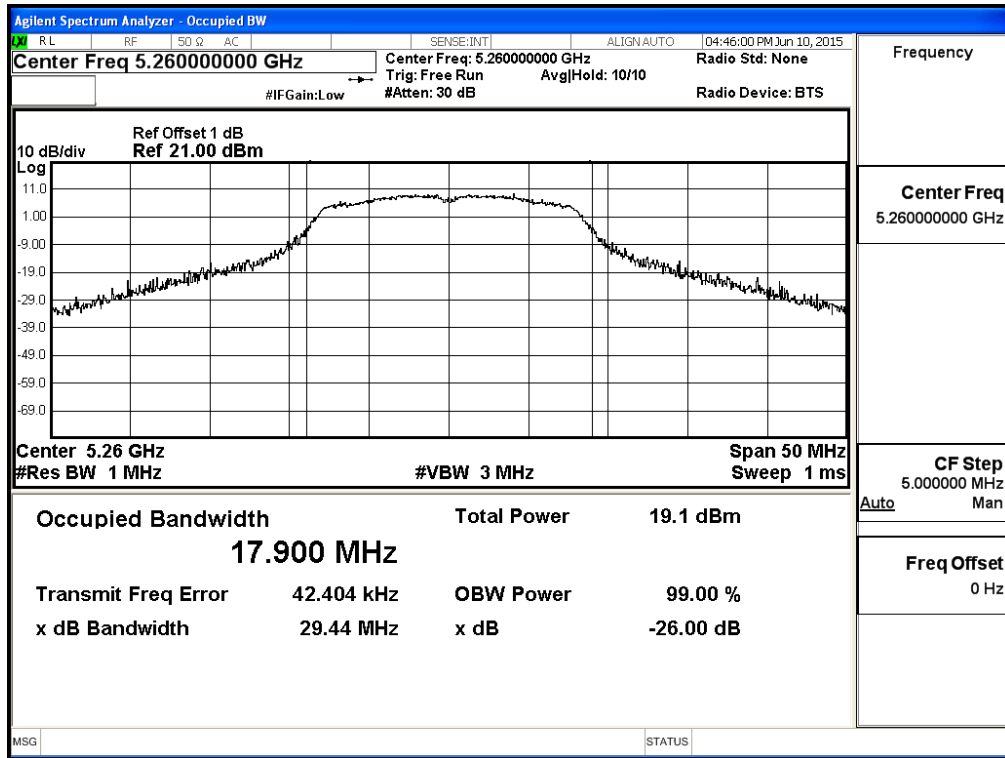

### Channel 60:

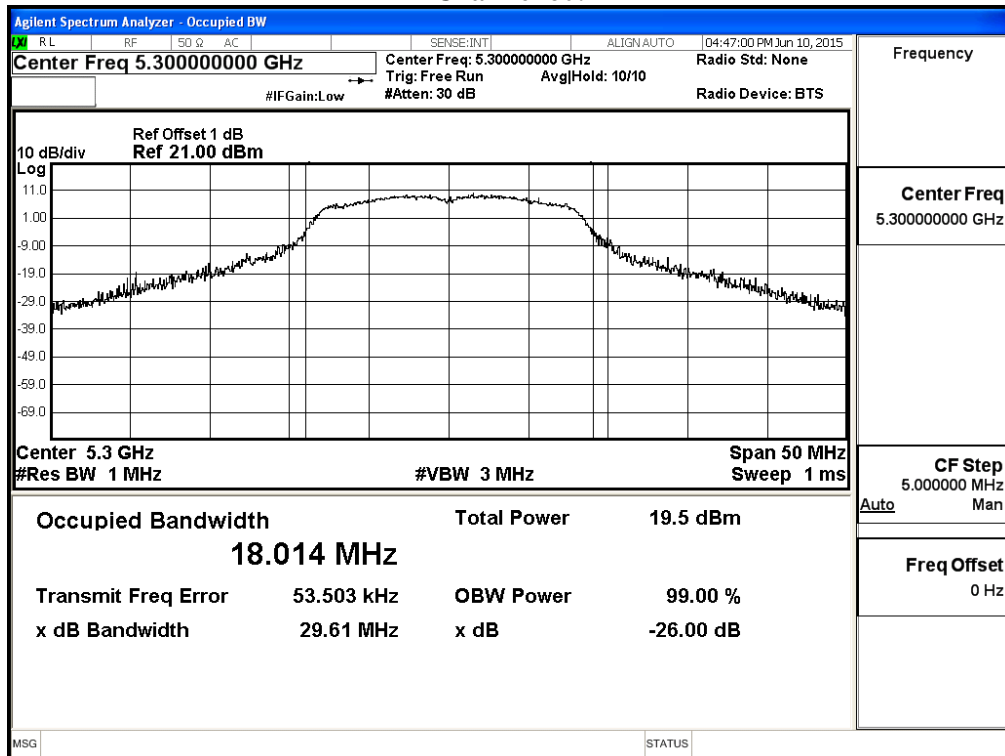



**Channel 64:**

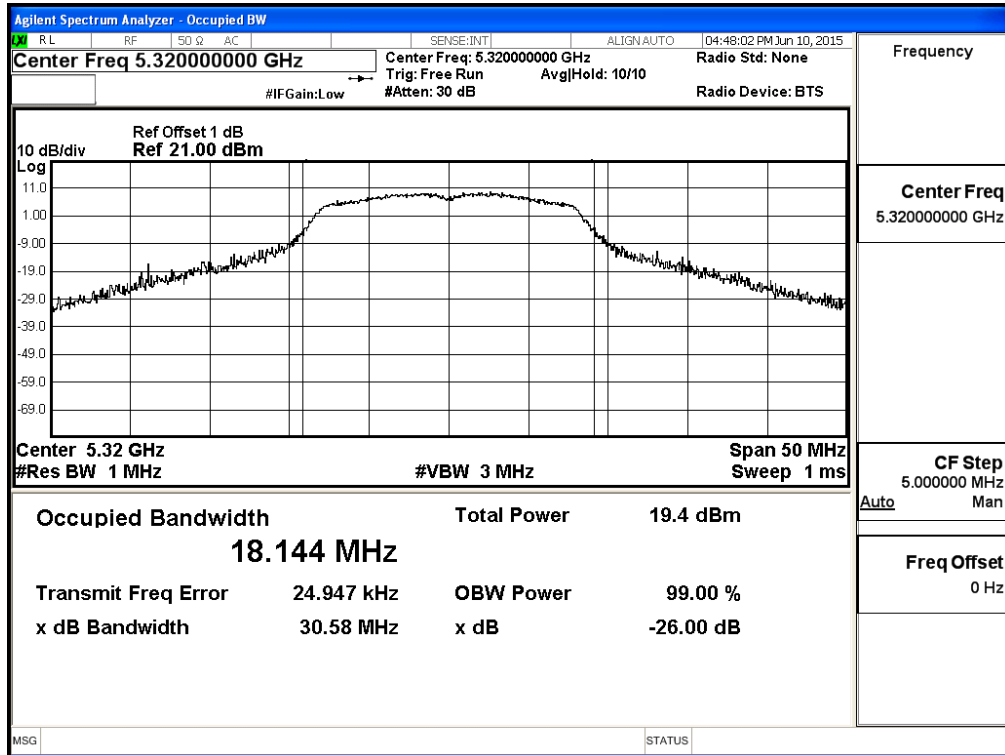

**Channel 100:**

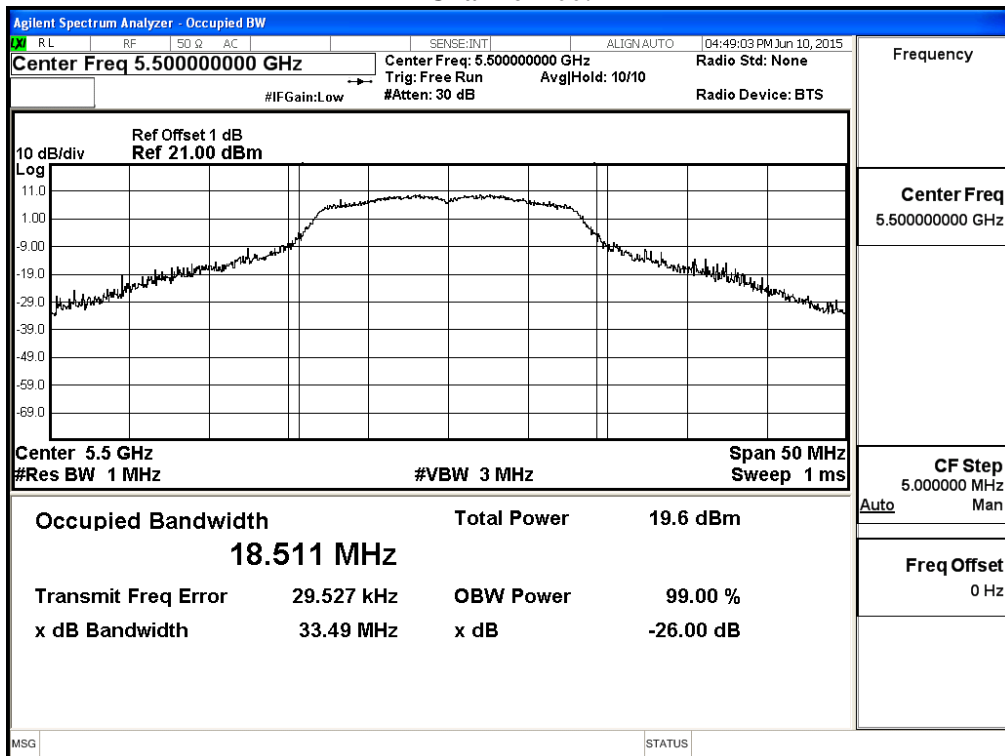

**Channel 116:**

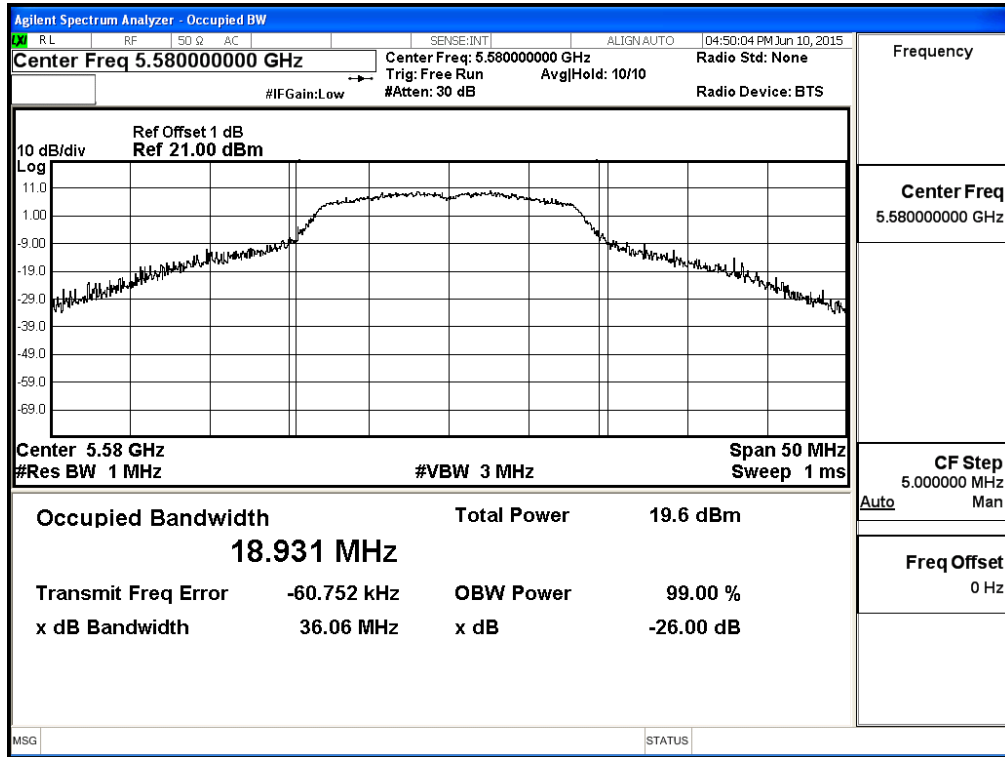

**Channel 140:**

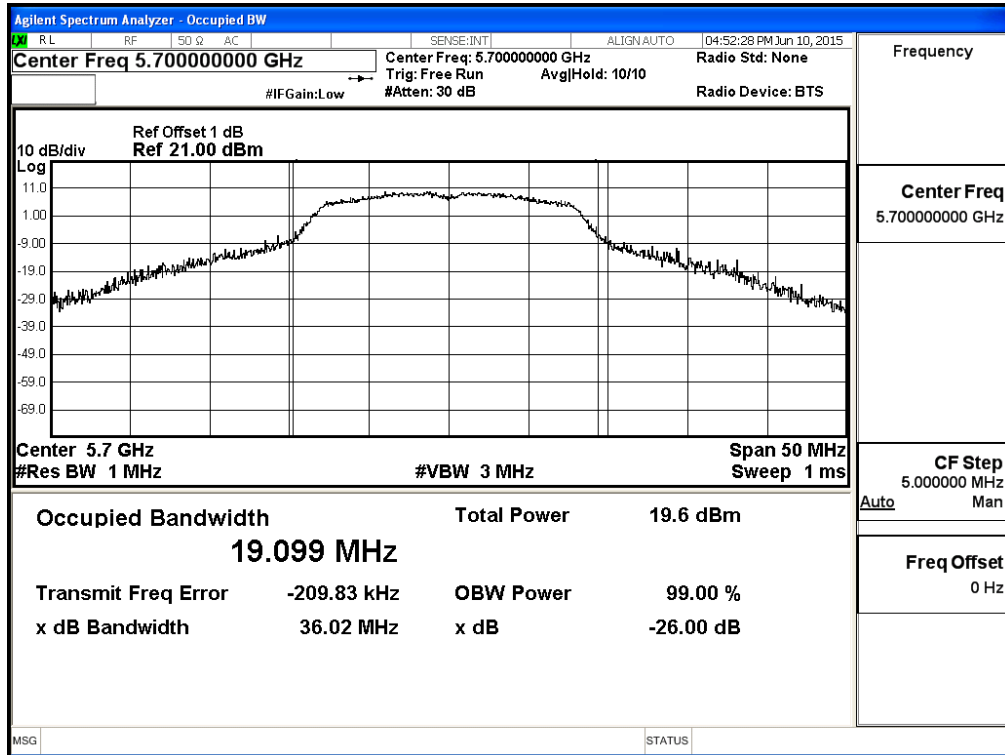

Product : TABLET PC  
 Test Item : Maximum conducted output power  
 Test Site : No.3 OATS  
 Test Mode : Mode 2: Transmit (802.11n-20BW 7.2Mbps)

Cable loss=1dB		Maximum conducted output power								
Channel No.	Frequency (MHz)	Data Rate (Mbps)								Required Limit
		7.2	14.4	21.7	28.9	43.3	57.8	65	72.2	
		Measurement Level (dBm)								
36	5180	14.30	--	--	--	--	--	--	--	<24dBm
44	5220	14.53	14.37	14.28	14.19	14.12	14.06	13.95	13.86	<24dBm
48	5240	14.35	--	--	--	--	--	--	--	<24dBm
52	5260	14.23	--	--	--	--	--	--	--	<24dBm
60	5300	14.24	14.17	14.1	14.04	13.99	13.93	13.85	13.77	<24dBm
64	5320	14.55	--	--	--	--	--	--	--	<24dBm
100	5500	14.54	--	--	--	--	--	--	--	<24dBm
116	5580	14.53	14.33	14.26	14.15	14.07	13.97	13.88	13.82	<24dBm
140	5700	14.35	--	--	--	--	--	--	--	<24dBm
149	5745	14.06	--	--	--	--	--	--	--	<30dBm
157	5785	13.99	13.69	13.58	13.46	13.4	13.34	13.28	13.15	<30dBm
165	5825	13.97	--	--	--	--	--	--	--	<30dBm

Note: Maximum conducted output power Value =Reading value on average power meter + cable loss

**Maximum conducted output power Measurement:**

Channel No	Frequency Range (MHz)	99% Bandwidth (MHz)	Output Power (dBm)	Output Power Limit	
				(dBm)	dBm+10log(BW)
36	5180	--	14.30	24	--
44	5220	--	14.53	24	--
48	5240	--	14.35	24	--
52	5260	19.108	14.23	24	23.81
60	5300	19.110	14.24	24	23.81
64	5320	19.141	14.55	24	23.82
100	5500	19.431	14.54	24	23.88
116	5580	19.948	14.53	24	24.00
140	5700	20.042	14.35	24	24.02
149	5745	--	14.06	30	--
157	5785	--	13.99	30	--
165	5825	--	13.97	30	--

Note:

1. Power Output Value =Reading value on average power meter + cable loss
2. 99% Bandwidth is the bandwidth of chain A or chain B whichever is less bandwidth; output power limitation is more stringent.

**99% Occupied Bandwidth:  
Channel 52:**

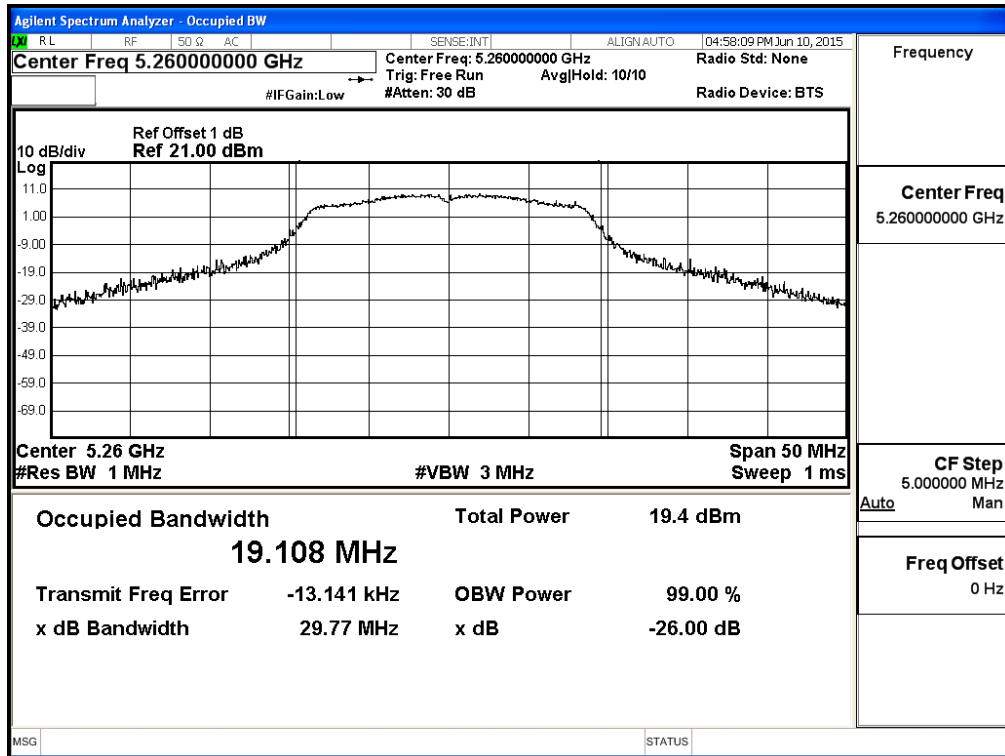

**Channel 60:**

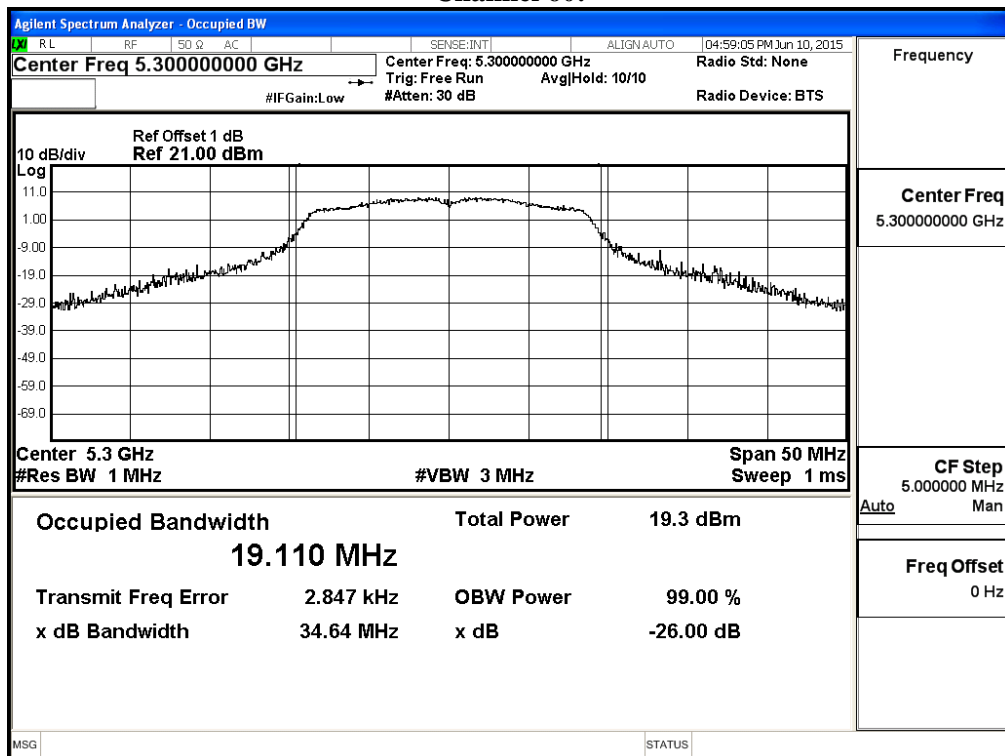

### Channel 64:

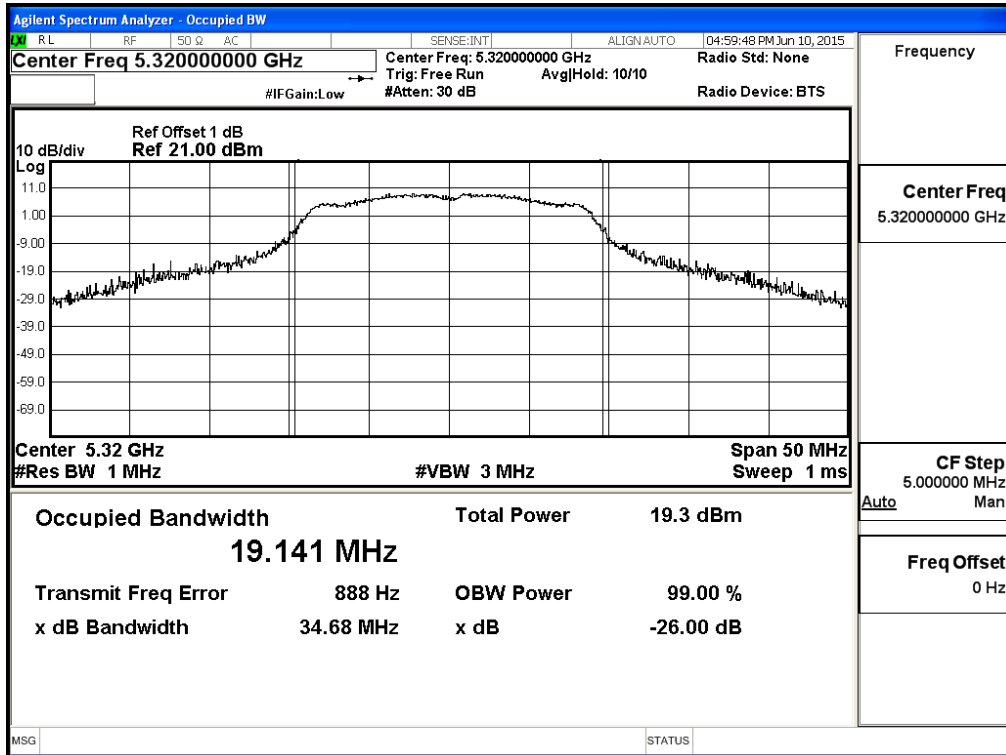

### Channel 100:

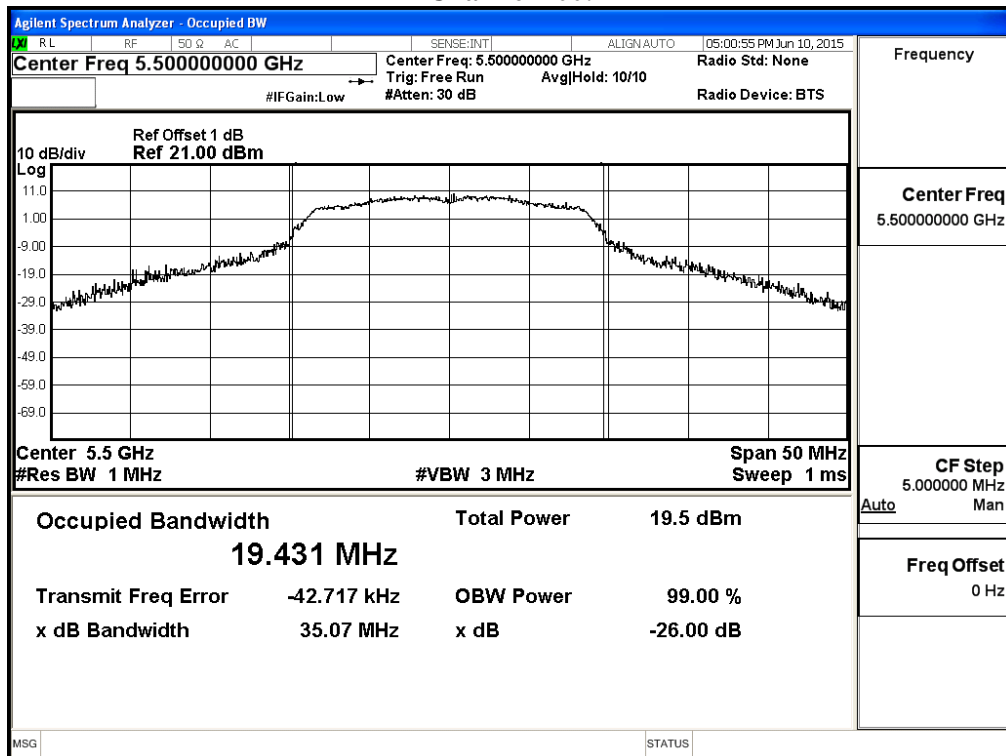

**Channel 116:**

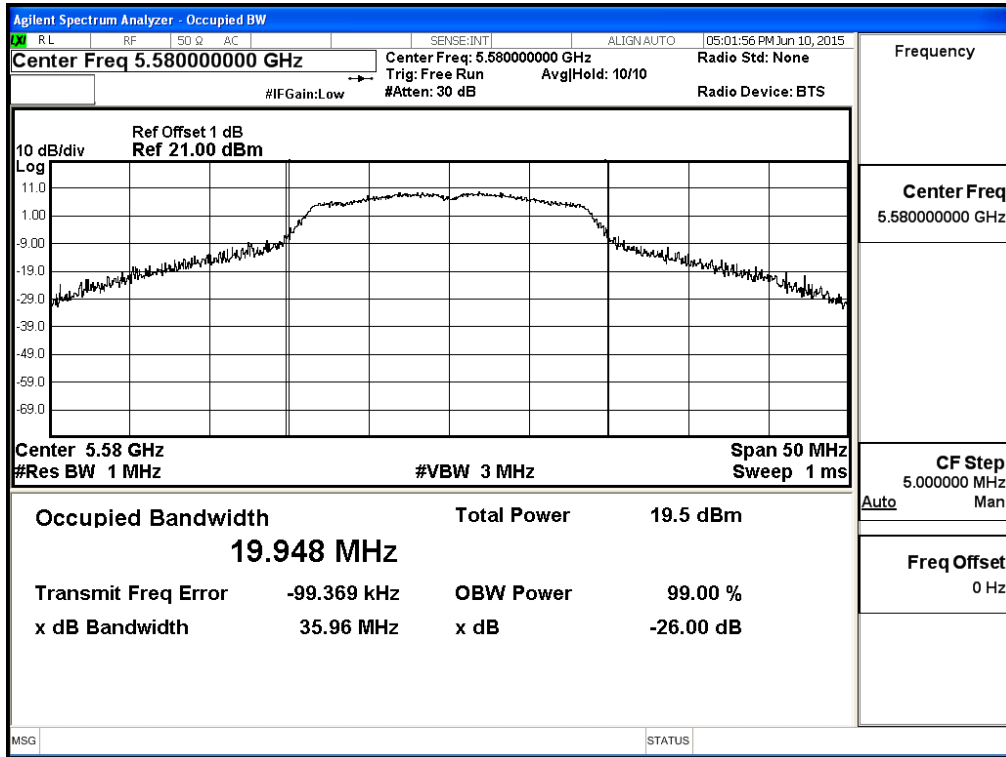

**Channel 140:**

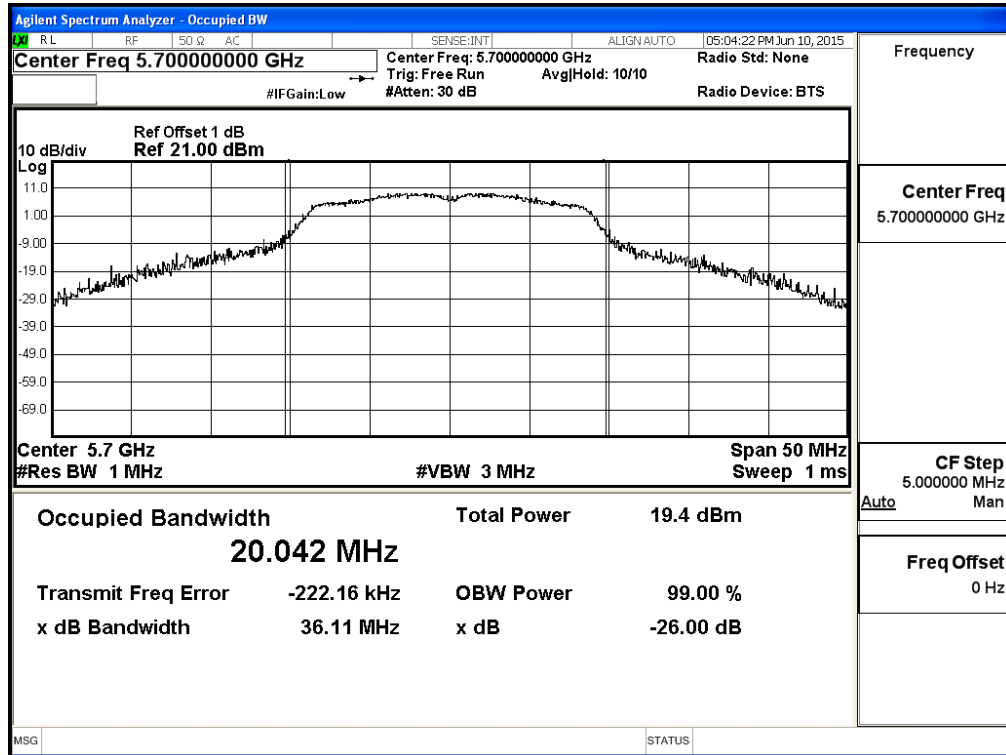

## 4. Peak Power Spectral Density

### 4.1. Test Equipment

	Equipment	Manufacturer	Model No./Serial No.	Last Cal.
	Spectrum Analyzer	R&S	FSP40 / 100170	Jun., 2015
	Spectrum Analyzer	Agilent	E4407B / US39440758	Jun., 2015
X	Spectrum Analyzer	Agilent	N9010A / MY48030495	Apr, 2015

Note:

1. All equipments are calibrated with traceable calibrations. Each calibration is traceable to the national or international standards.
2. The test instruments marked with “X” are used to measure the final test results.

### 4.2. Test Setup

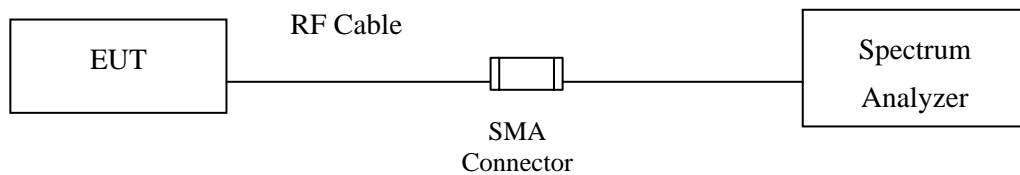

### 4.3. Limits

- (1) For the band 5.15-5.25 GHz,
  - (i) For an outdoor access point operating in the band 5.15-5.25 GHz, the maximum power spectral density shall not exceed 17 dBm in any 1 megahertz band. If transmitting antennas of directional gain greater than 6 dBi are used, the maximum power spectral density shall be reduced by the amount in dB that the directional gain of the antenna exceeds 6 dBi.
  - (ii) For an indoor access point operating in the band 5.15-5.25 GHz, the maximum power spectral density shall not exceed 17 dBm in any 1 megahertz band. If transmitting antennas of directional gain greater than 6 dBi are used, the maximum power spectral density shall be reduced by the amount in dB that the directional gain of the antenna exceeds 6 dBi.
  - (iii) For fixed point-to-point access points operating in the band 5.15-5.25 GHz, the maximum conducted output power over the frequency band of operation shall not exceed 1 W. Fixed point-to-point U-NII devices may employ antennas with directional gain up to 23 dBi without any corresponding reduction in the maximum conducted output power or maximum power spectral density. For fixed point-to-point transmitters that employ a directional antenna gain greater than 23 dBi, a 1 dB reduction in maximum conducted output power and maximum power spectral density is required for each 1 dB of antenna gain in excess of 23 dBi. Fixed, point-to-point operations exclude the use of point-to-multipoint systems, omnidirectional applications, and multiple collocated transmitters transmitting the same information. The operator of the U-NII device, or if the



equipment is professionally installed, the installer, is responsible for ensuring that systems employing high gain directional antennas are used exclusively for fixed, point-to-point operations. (iv) For mobile and portable client devices in the 5.15-5.25 GHz band, the maximum power spectral density shall not exceed 11 dBm in any 1 megahertz band. If transmitting antennas of directional gain greater than 6 dBi are used, the maximum power spectral density shall be reduced by the amount in dB that the directional gain of the antenna exceeds 6 dBi.+

- (2) For the 5.25-5.35 GHz and 5.47-5.725 GHz bands, the maximum power spectral density shall not exceed 11 dBm in any 1 megahertz band. If transmitting antennas of directional gain greater than 6 dBi are used, the maximum power spectral density shall be reduced by the amount in dB that the directional gain of the antenna exceeds 6 dBi.
- (3) For the band 5.725-5.85 GHz, the maximum power spectral density shall not exceed 30 dBm in any 500-kHz band. If transmitting antennas of directional gain greater than 6 dBi are used, the maximum power spectral density shall be reduced by the amount in dB that the directional gain of the antenna exceeds 6 dBi. However, fixed point-to-point UNII devices operating in this band may employ transmitting antennas with directional gain greater than 6 dBi without any corresponding reduction in transmitter conducted power. Fixed, point-to-point operations exclude the use of point-to-multipoint systems, omnidirectional applications, and multiple collocated transmitters transmitting the same information. The operator of the U-NII device, or if the equipment is professionally installed, the installer, is responsible for ensuring that systems employing high gain directional antennas are used exclusively for fixed, point-to-point operations.

#### **4.4. Test Procedure**

The EUT was setup to ANSI C63.10, 2013; tested to UNII test procedure of FCC KDB-789033 for compliance to FCC 47CFR Subpart E requirements.

The Peak Power Spectral Density using KDB 789033 section F) procedure, Create an average power spectrum for the EUT operating mode being tested by following the instructions in section E)2) for measuring maximum conducted output power using a spectrum analyzer.

SA-1 method is selected to run the test.

For the band 5.725-5.85 GHz, Scale the observed power level to an equivalent value in 500 kHz by adjusting (increase) the measured power by a bandwidth correction factor (BWCF) where  $BWCF = 10\log(500\text{ kHz}/100\text{ kHz}) = 6.98\text{ dB}$ .

#### **4.5. Uncertainty**

± 1.27 dB

**4.6. Test Result of Peak Power Spectral Density**

Product : TABLET PC  
 Test Item : Peak Power Spectral Density  
 Test Site : No.3 OATS  
 Test Mode : Mode 1: Transmit (802.11a-6Mbps)

Channel Number	Frequency (MHz)	Data Rata (Mbps)	Measurement Level (dBm)	Required Limit (dBm)	Result
36	5180	6	3.99	<11	Pass
44	5220	6	3.69	<11	Pass
48	5240	6	3.56	<11	Pass
52	5260	6	3.74	<11	Pass
60	5300	6	4.02	<11	Pass
64	5320	6	4.09	<11	Pass
100	5500	6	4.10	<11	Pass
116	5580	6	4.20	<11	Pass
140	5700	6	4.21	<11	Pass

Channel Number	Frequency (MHz)	Data Rata (Mbps)	PPSD (dBm)	BWCF (dB)	Total PPSD (dBm)	Required Limit (dBm)	Result
149	5745	6	1.58	6.98	8.56	<30	Pass
157	5785	6	1.39	6.98	8.37	<30	Pass
165	5825	6	0.78	6.98	7.76	<30	Pass

### Channel 36:

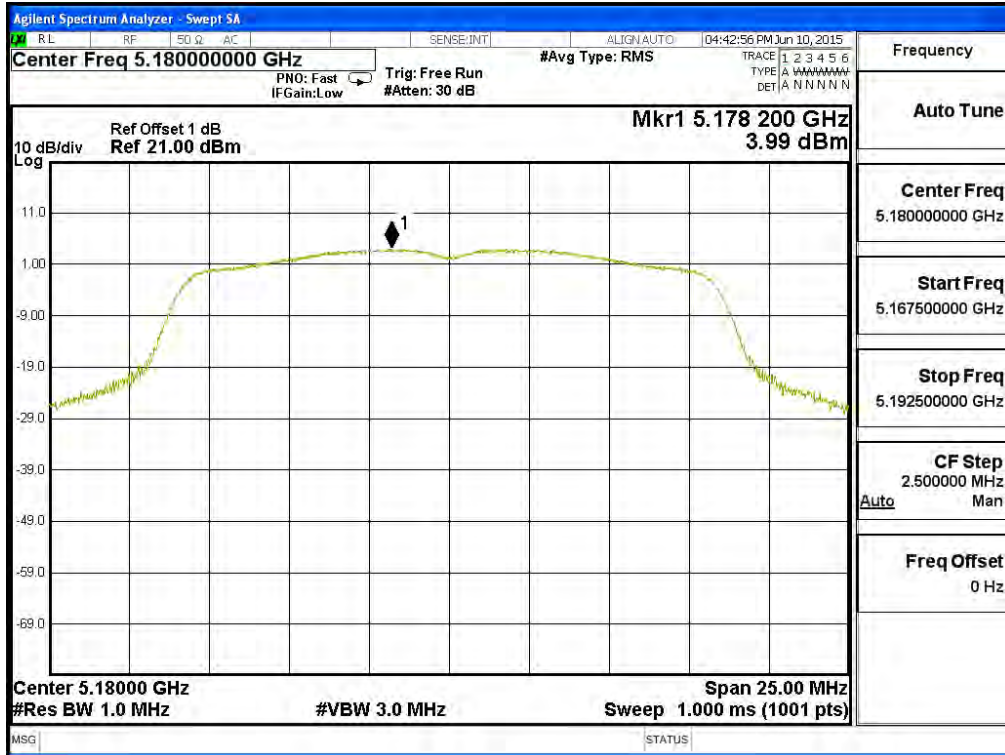

### Channel 44:

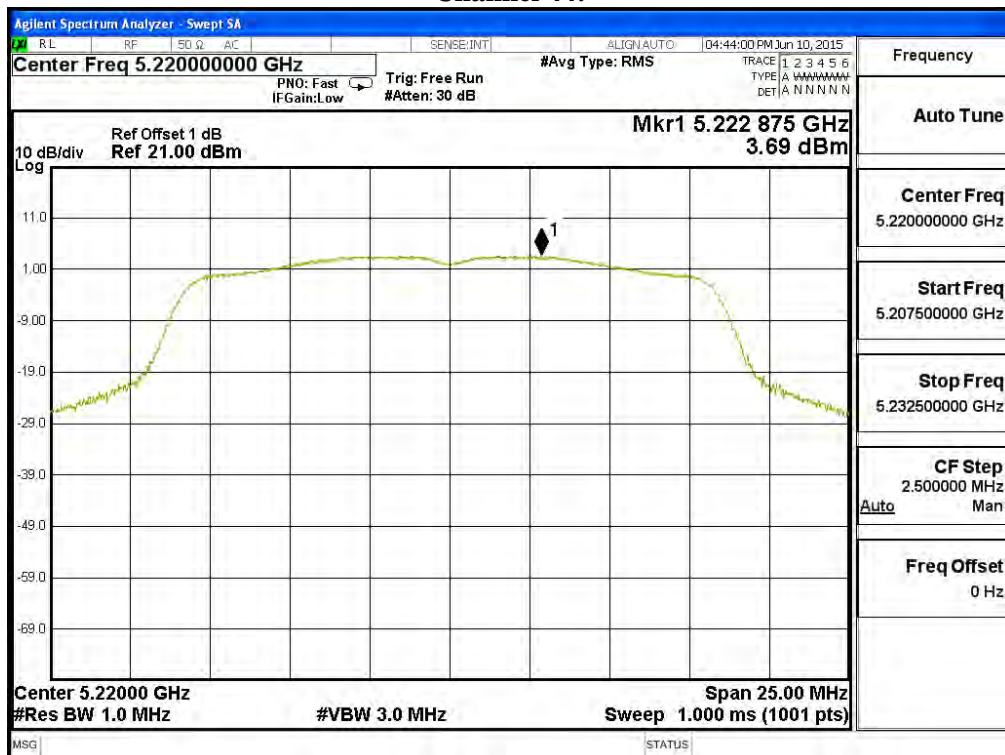

**Channel 48:**

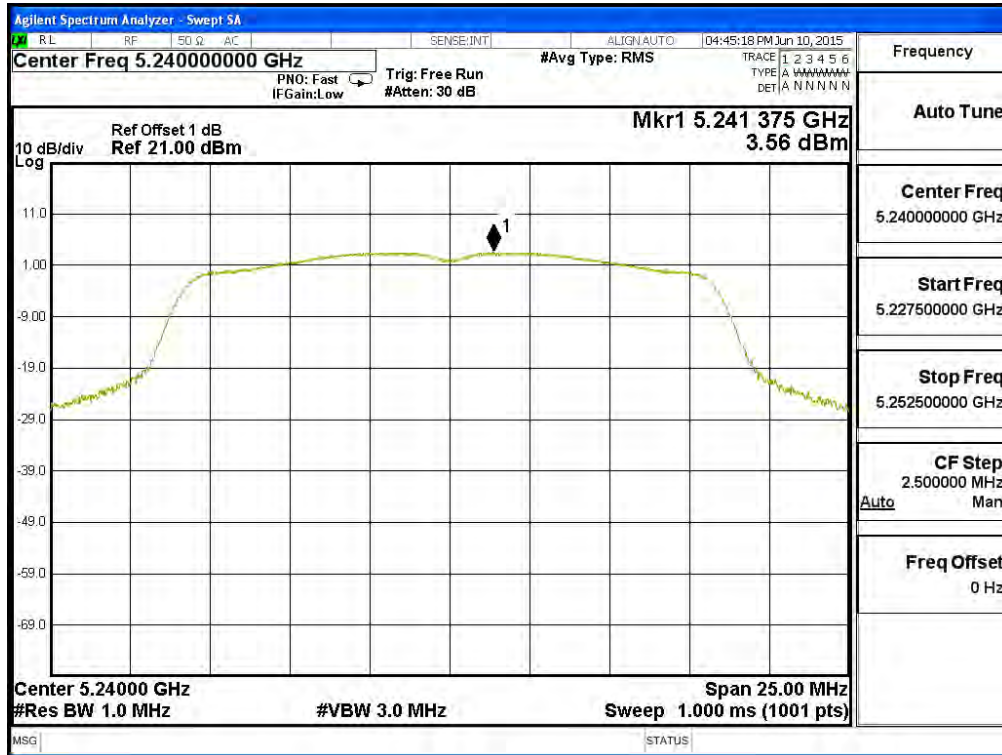

**Channel 52:**

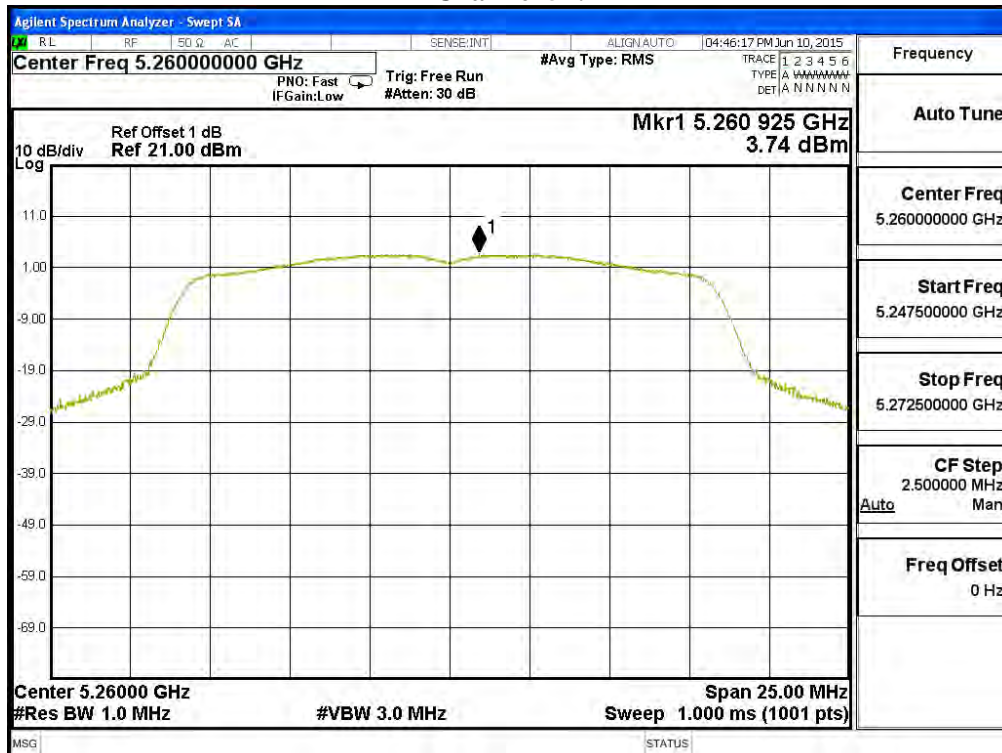

**Channel 60:**

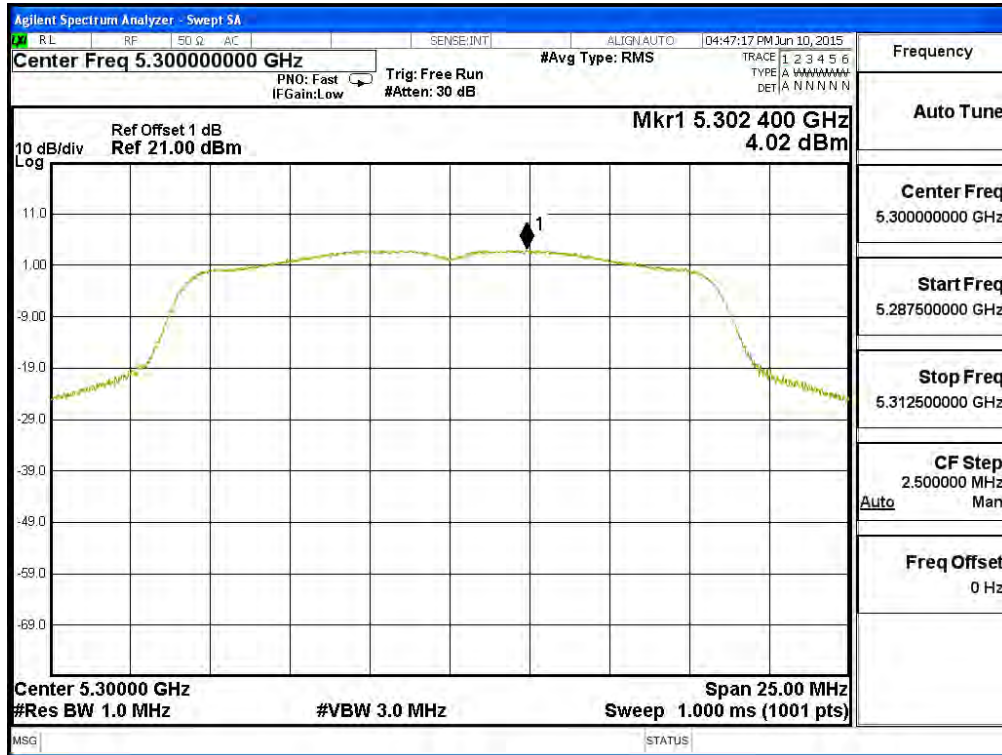

**Channel 64:**

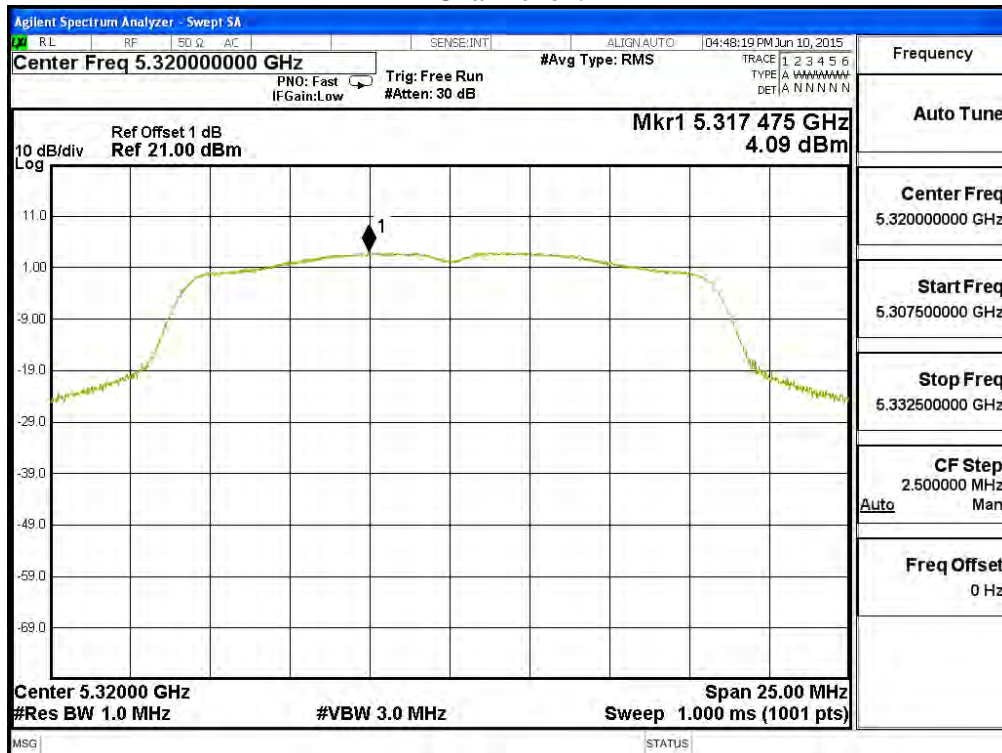

**Channel 100:**

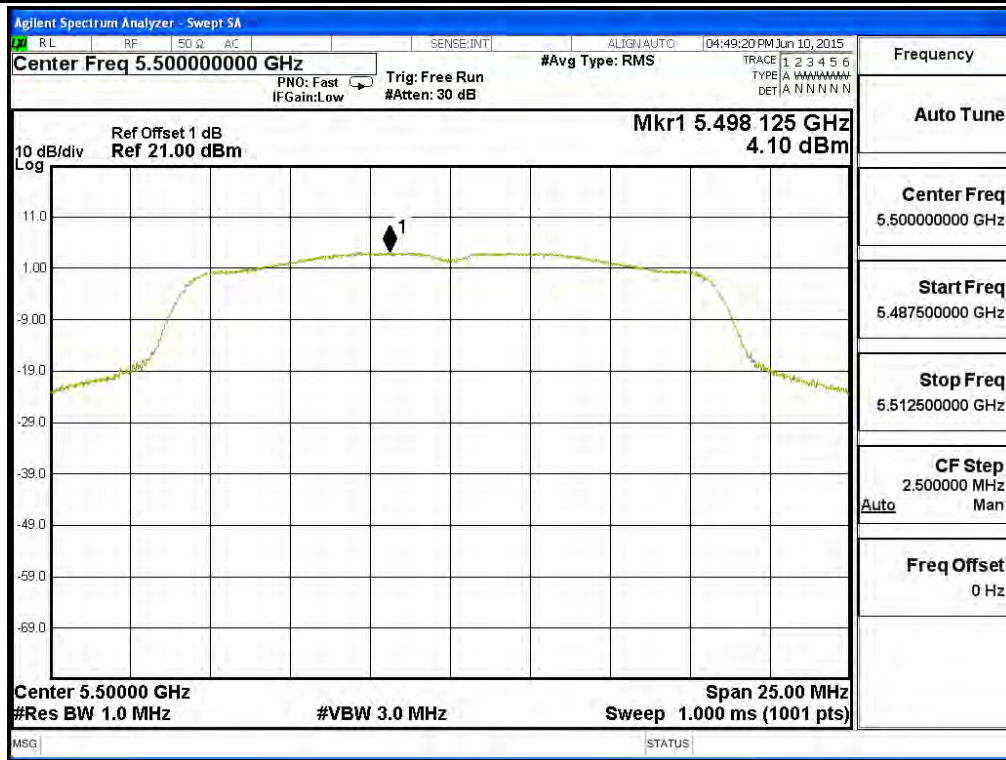

**Channel 116:**

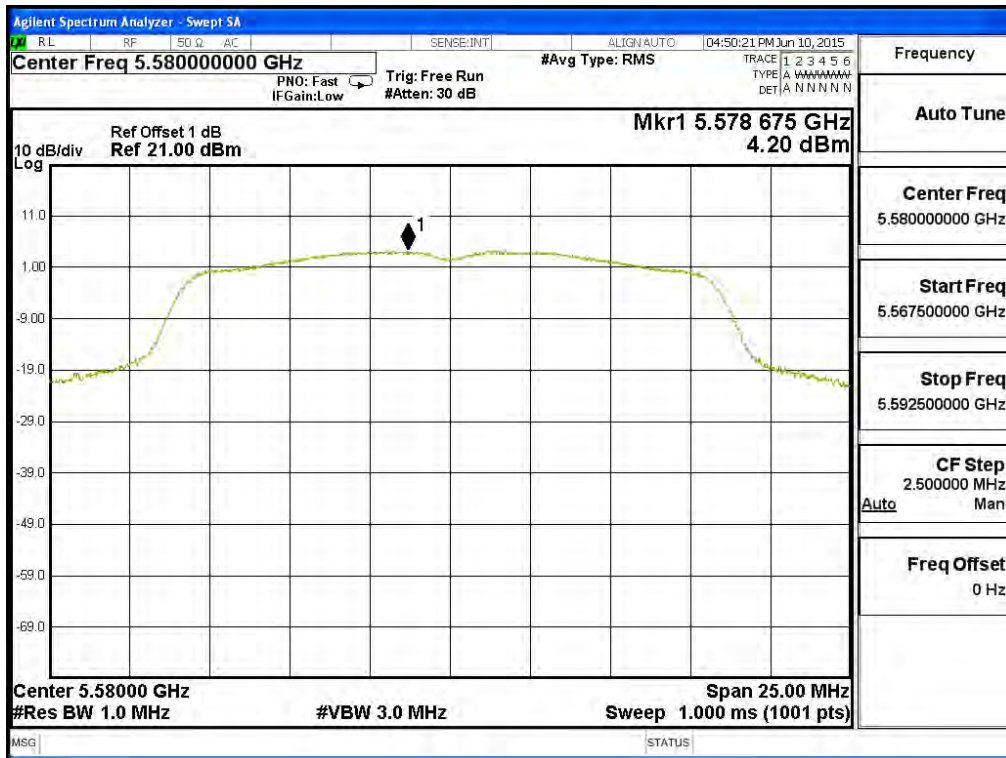

**Channel 140:**

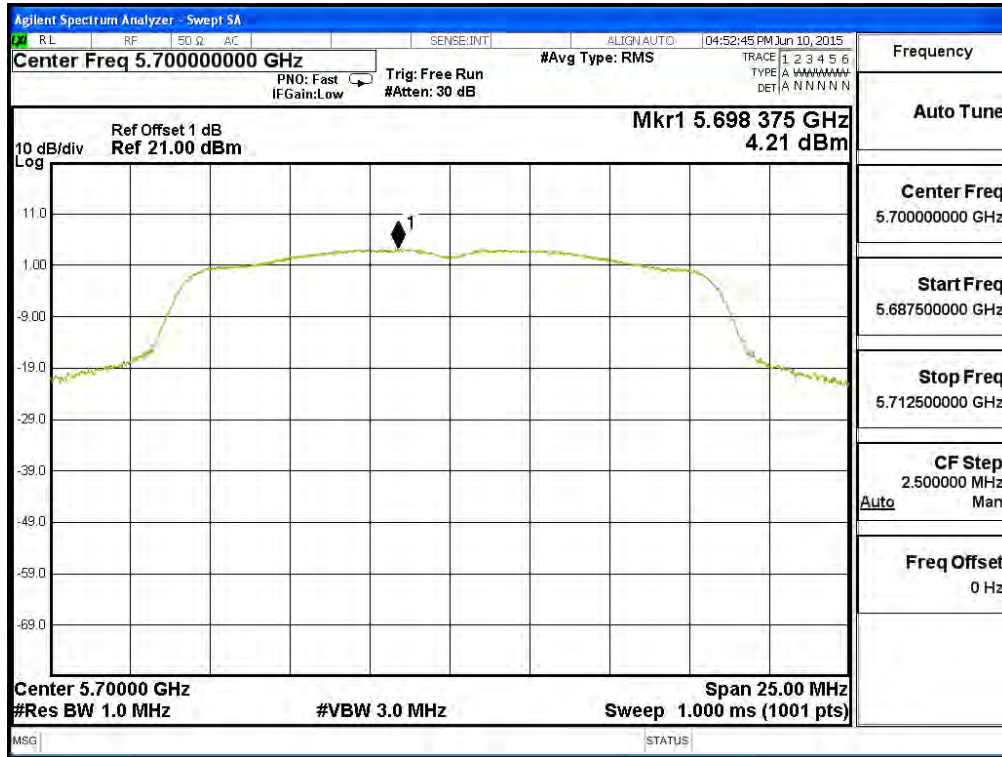

**Channel 149:**



**Channel 157:**

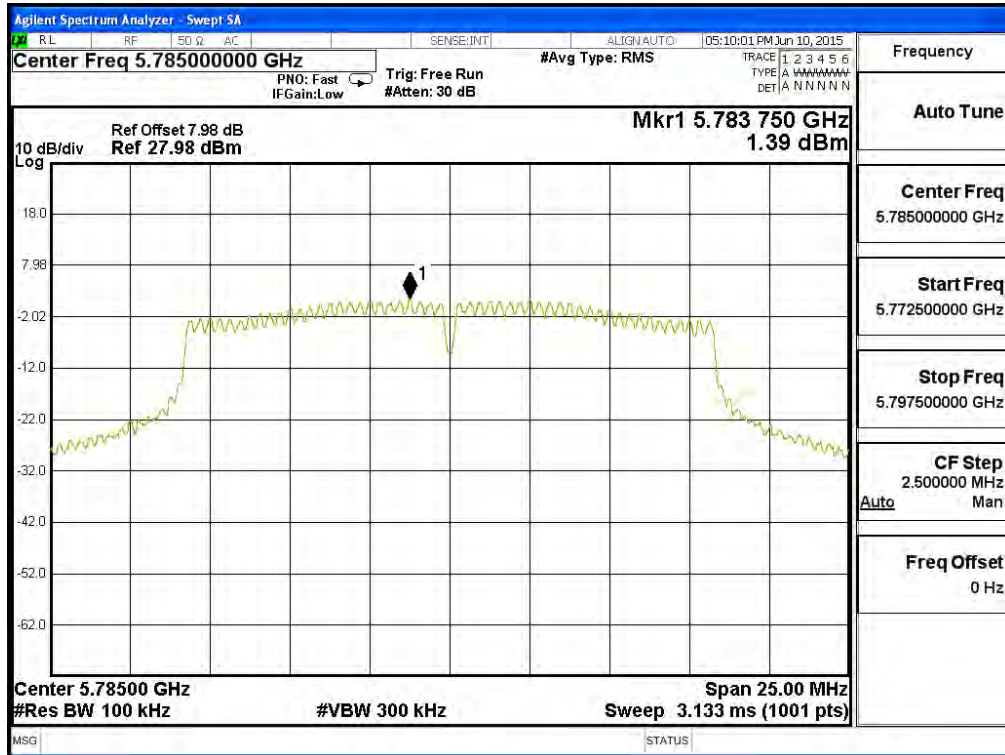

**Channel 165:**

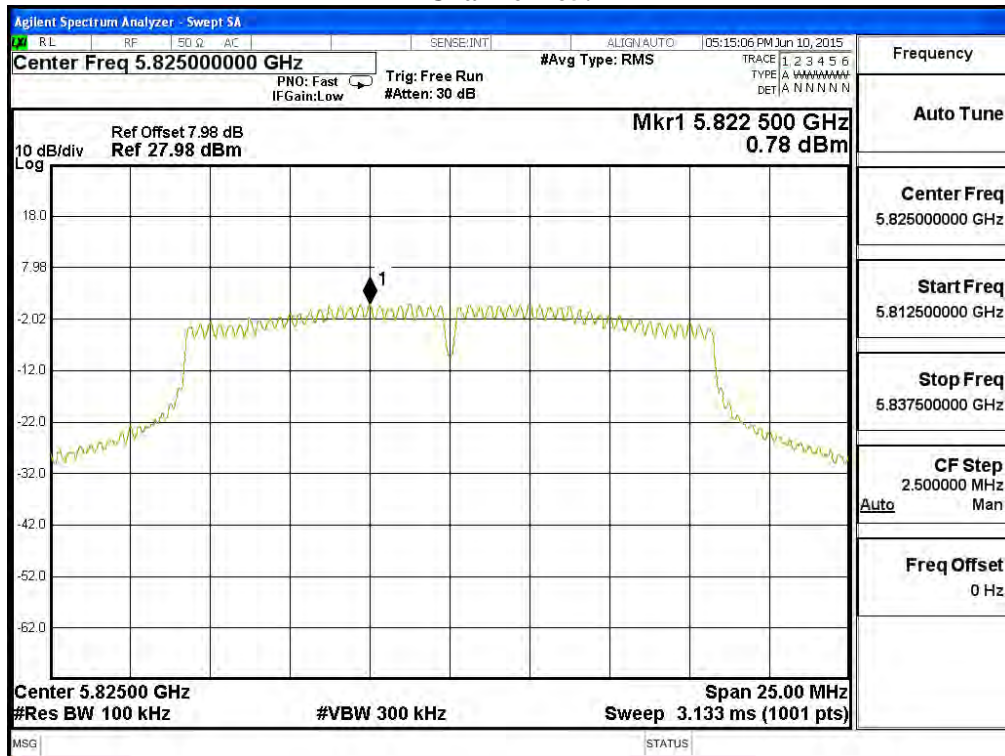



Product : TABLET PC  
Test Item : Peak Power Spectral Density  
Test Site : No.3 OATS  
Test Mode : Mode 2: Transmit (802.11n-20BW 7.2Mbps)

Channel Number	Frequency (MHz)	Data Rate (Mbps)	Measurement Level (dBm)	Required Limit (dBm)	Result
36	5180	7.2	3.89	<11	Pass
44	5220	7.2	3.60	<11	Pass
48	5240	7.2	3.76	<11	Pass
52	5260	7.2	3.94	<11	Pass
60	5300	7.2	3.72	<11	Pass
64	5320	7.2	3.62	<11	Pass
100	5500	7.2	4.05	<11	Pass
116	5580	7.2	4.01	<11	Pass
140	5700	7.2	3.87	<11	Pass

Channel Number	Frequency (MHz)	Data Rate (Mbps)	PPSD (dBm)	BWCF (dB)	Total PPSD (dBm)	Required Limit (dBm)	Result
149	5745	7.2	1.10	6.98	8.08	<30	Pass
157	5785	7.2	1.00	6.98	7.98	<30	Pass
165	5825	7.2	0.70	6.98	7.68	<30	Pass

### Channel 36:

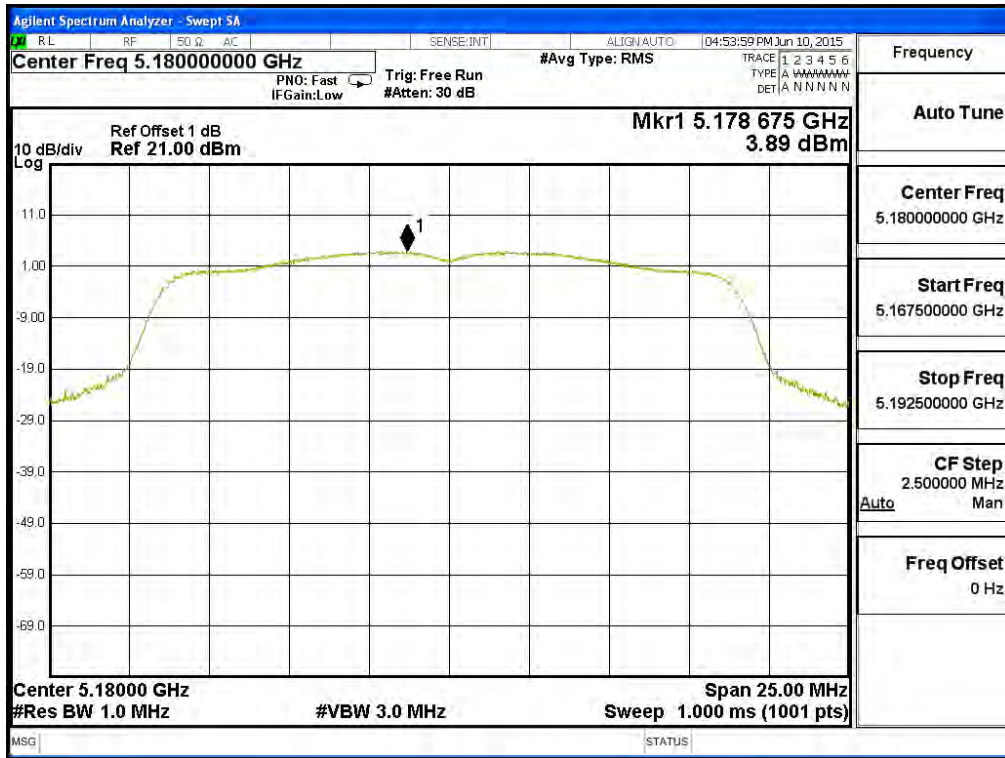

### Channel 44:

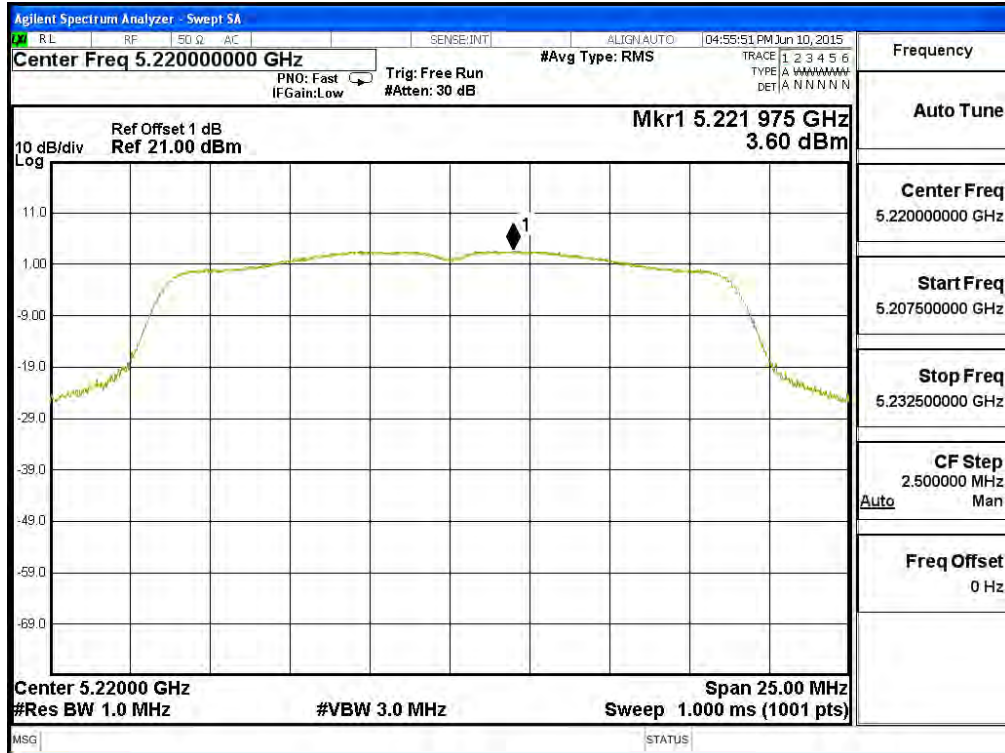

**Channel 48:**

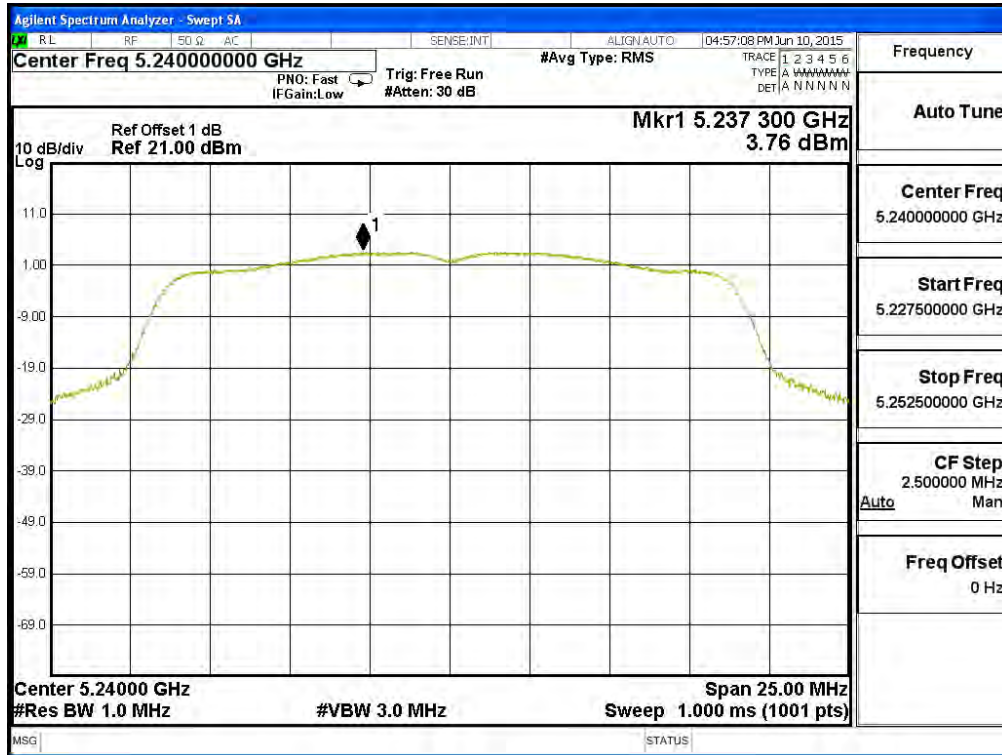

**Channel 52:**

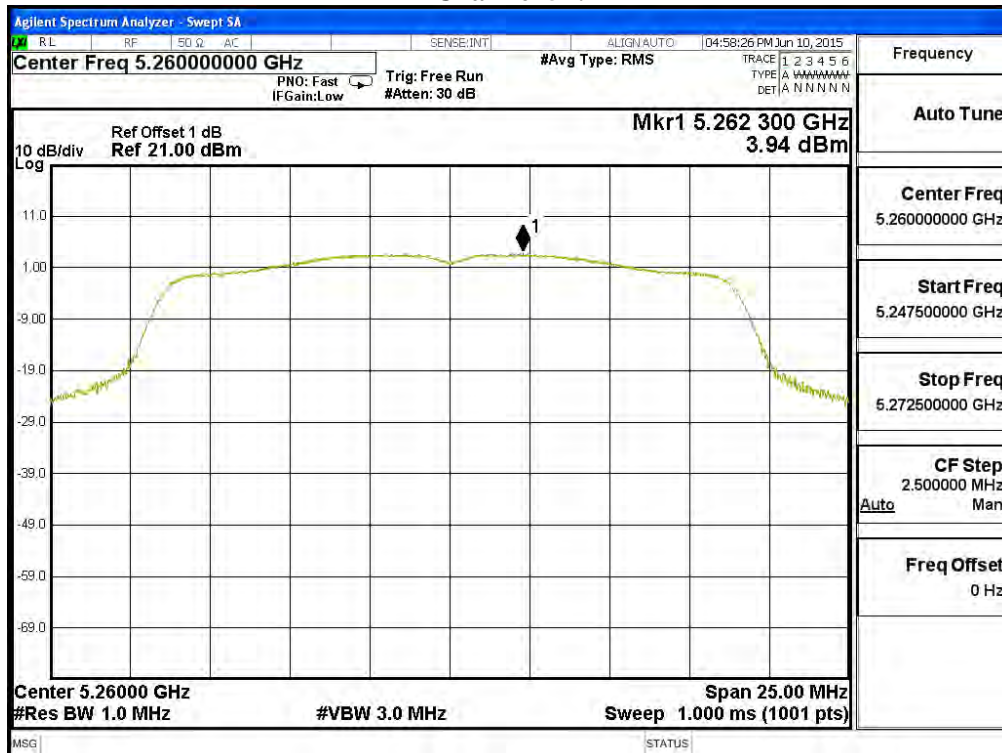

**Channel 60:**

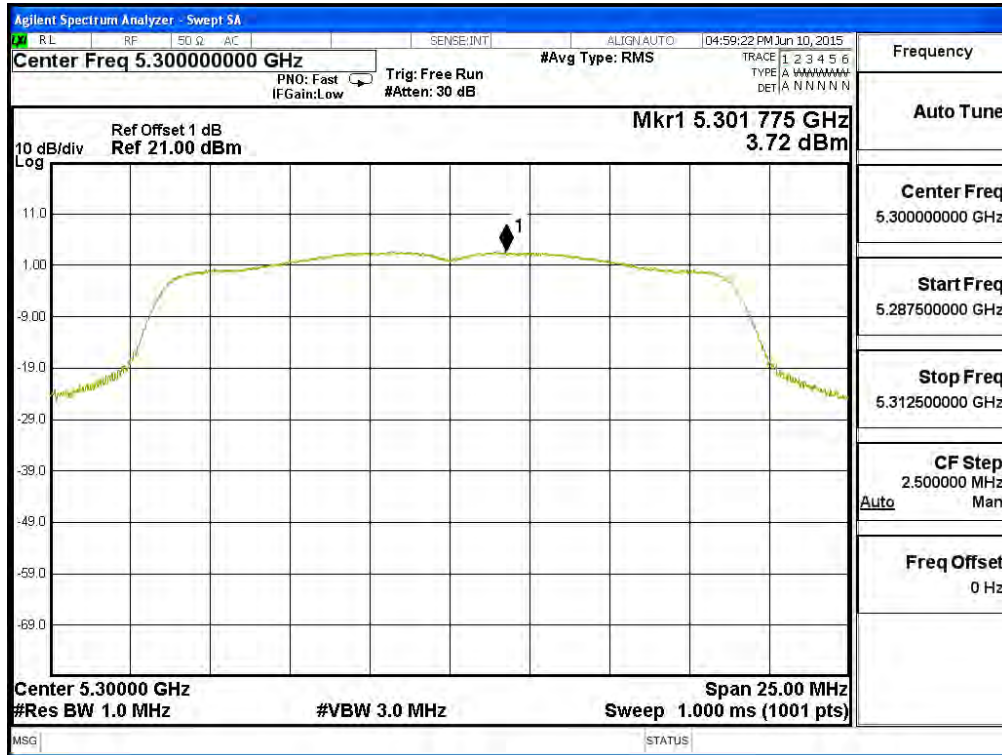

**Channel 64:**

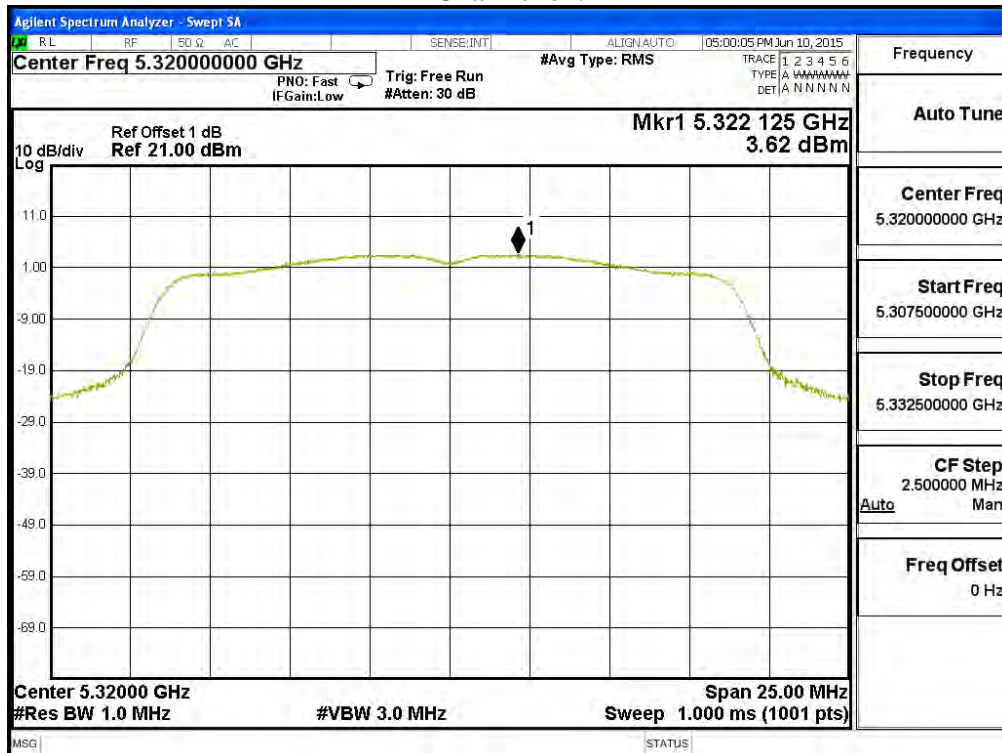

**Channel 100:**

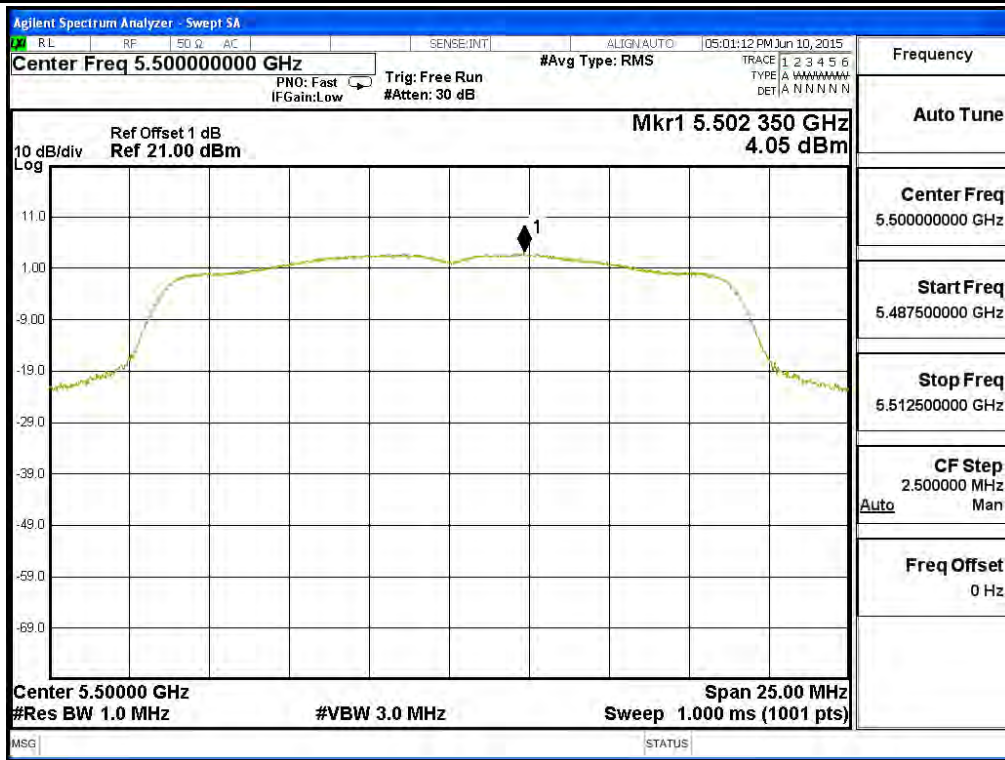

**Channel 116:**

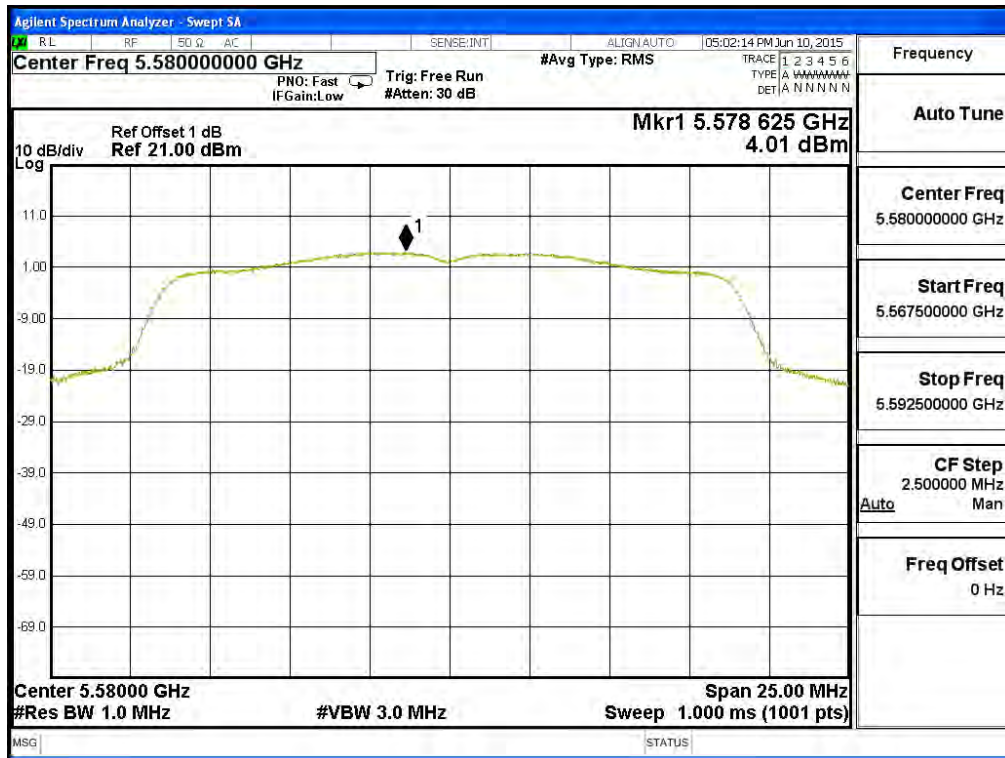

**Channel 140:**

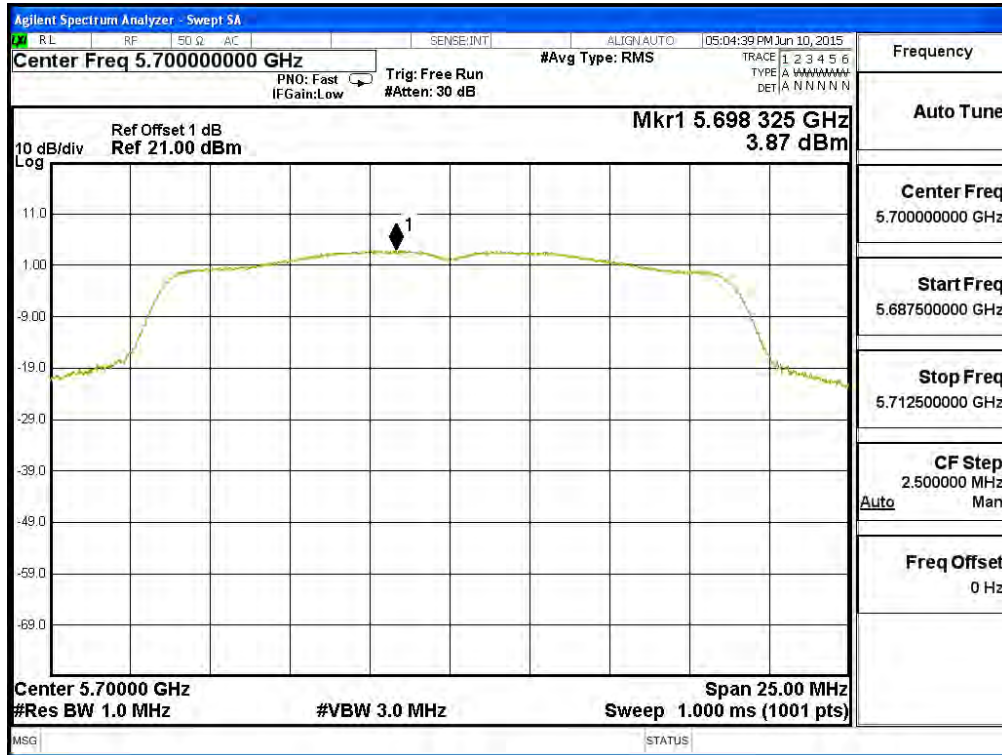

**Channel 149:**

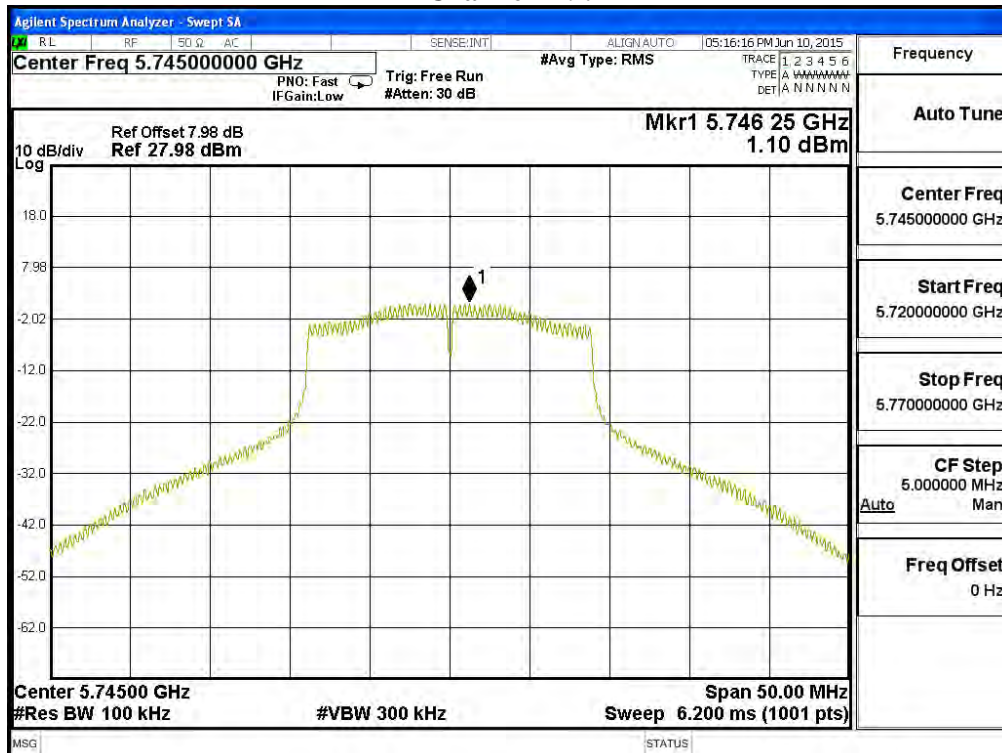

**Channel 157:**

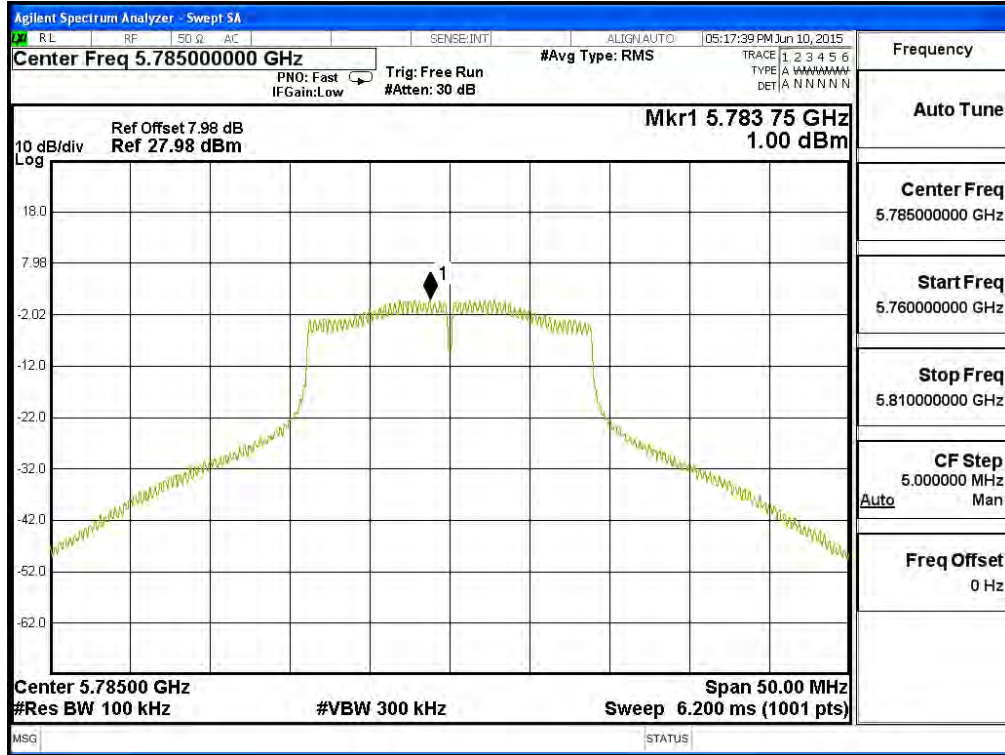

**Channel 165:**

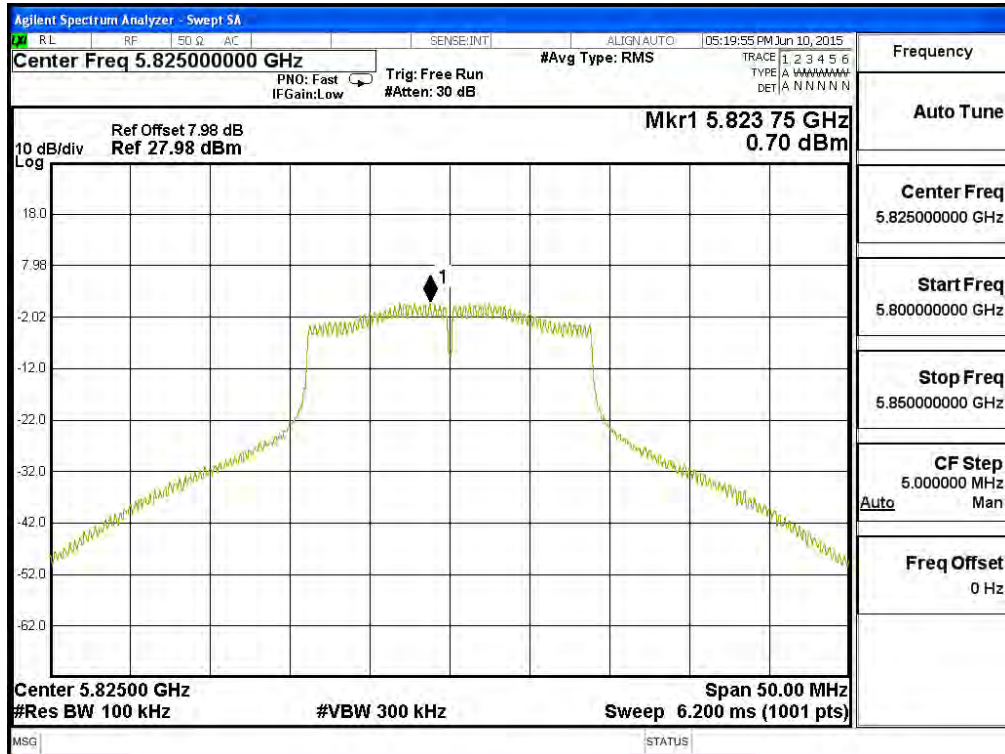

## 5. Radiated Emission

### 5.1. Test Equipment

The following test equipments are used during the radiated emission test:

Test Site	Equipment	Manufacturer	Model No./Serial No.	Last Cal.
☒ Site # 3	X Magnetic Loop Antenna	Teseq	HLA6121/ 37133	Sep, 2014
	X Bilog Antenna	Schaffner Chase	CBL6112B/ 2707	Jun, 2015
	X EMI Test Receiver	R&S	ESCS 30/838251/ 001	Jun, 2015
	X Coaxial Cable	QTK(Arnist)	RG 214/ LC003-RG	Jun, 2015
	X Coaxial signal switch	Arnist	MP59B/ 6200798682	Jun, 2015

Test Site	Equipment	Manufacturer	Model No./Serial No.	Last Cal.
☒ CB # 8	X Spectrum Analyzer	R&S	FSP40/ 100339	Oct, 2014
	X Horn Antenna	ETS-Lindgren	3117/ 35205	Mar, 2015
	X Horn Antenna	Schwarzbeck	BBHA9170/209	Jan, 2015
	X Horn Antenna	TRC	AH-0801/95051	Aug, 2014
	X Pre-Amplifier	EMCI	EMC012630SE/980210	Jan, 2015
	X Pre-Amplifier	MITEQ	JS41-001040000-58-5P/153945	Jul, 2015
	X Pre-Amplifier	NARDA	DBL-1840N506/013	Jul, 2015

- Note:
1. All equipments are calibrated with traceable calibrations. Each calibration is traceable to the national or international standards.
  2. The test instruments marked with "X" are used to measure the final test results.

### 5.2. Test Setup

Radiated Emission Below 1GHz

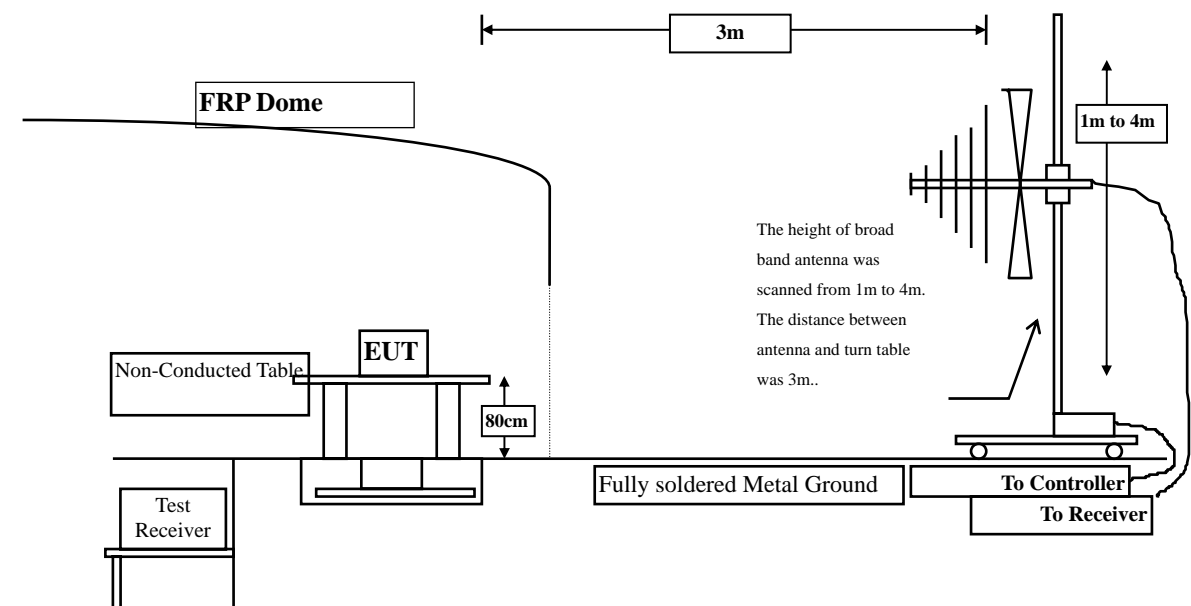



Radiated Emission Above 1GHz

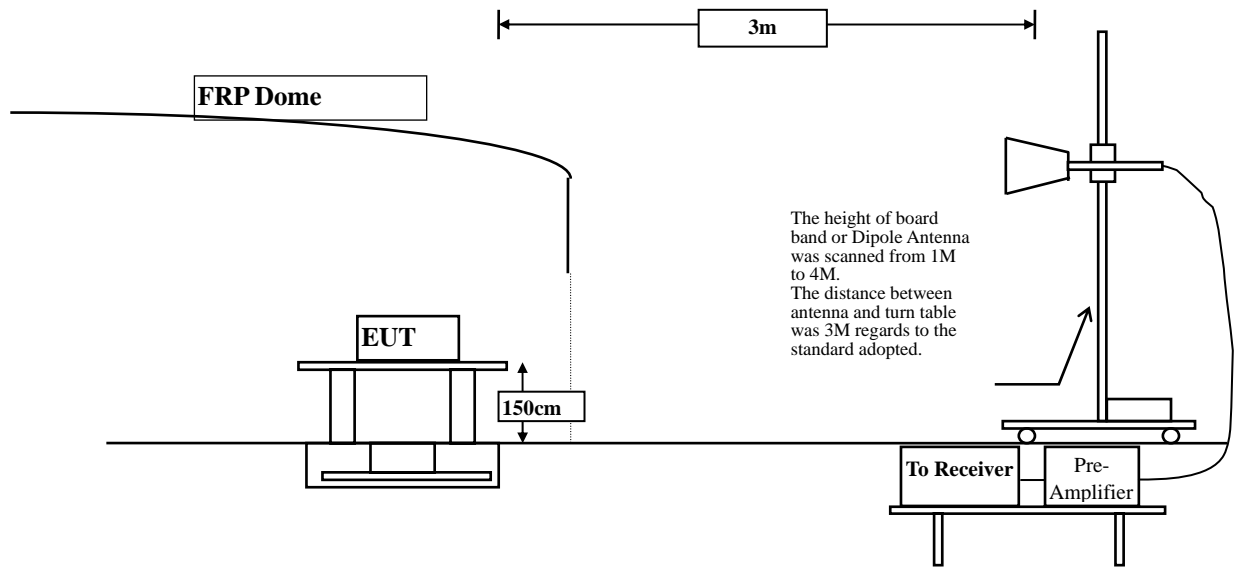

**5.3. Limits**

Emissions radiated outside of the specified frequency bands, except for harmonics, shall be attenuated by at least 20dB below the level of the fundamental or to the general radiated emission limits in paragraph 15.209, whichever is the lesser attenuation.

FCC Part 15 Subpart C Paragraph 15.209(a) Limits		
Frequency MHz	Field strength (microvolts/meter)	Measurement distance (meter)
0.009-0.490	2400/F(kHz)	300
0.490-1.705	24000/F(kHz)	30
1.705-30	30	30
30-88	100	3
88-216	150	3
216-960	200	3
Above 960	500	3

Remarks: E field strength (dBμV/m) = 20 log E field strength (uV/m)

#### **5.4. Test Procedure**

The EUT was setup according to ANSI C63.10, 2013 and tested according to FCC KDB-789033 test procedure for compliance to FCC 47CFR 15. 407 requirements.

Measuring the frequency range below 1GHz, the EUT is placed on a turn table which is 0.8 meter above ground, when measuring the frequency range above 1GHz, the EUT is placed on a turn table which is 1.5 meter above ground.

The turn table is rotated 360 degrees to determine the position of the maximum emission level.

The EUT was positioned such that the distance from antenna to the EUT was 3 meters.

The antenna is scanned between 1 meter and 4 meters to find out the maximum emission level. This is repeated for both horizontal and vertical polarization of the antenna. In order to find the maximum emission, all of the interface cables were manipulated according to ANSI C63.10: 2013 on radiated measurement.

The resolution bandwidth below 30MHz setting on the field strength meter is 9kHz and 30MHz~1GHz is 120kHz and above 1GHz is 1MHz.

Radiated emission measurements below 30MHz are made using Loop Antenna and 30MHz~1GHz are made using broadband Bilog antenna and above 1GHz are made using Horn Antennas.

The measurement is divided into the Preliminary Measurement and the Final Measurement.

The suspected frequencies are searched for in Preliminary Measurement with the measurement antenna kept pointed at the source of the emission both in azimuth and elevation, with the polarization of the antenna oriented for maximum response. The antenna is pointed at an angle towards the source of the emission, and the EUT is rotated in both height and polarization to maximize the measured emission. The emission is kept within the illumination area of the 3 dB bandwidth of the antenna.

The worst radiated emission is measured in the Open Area Test Site on the Final Measurement.

The measurement frequency range from 9kHz - 10th Harmonic of fundamental was investigated.

#### **5.5. Uncertainty**

± 3.8 dB below 1GHz

± 3.9 dB above 1GHz

**5.6. Test Result of Radiated Emission**

Product : TABLET PC  
 Test Item : Harmonic Radiated Emission Data  
 Test Site : No.3 OATS  
 Test Mode : Mode 1: Transmit (802.11a-6Mbps) (5180MHz)

Frequency MHz	Correct Factor dB	Reading Level dB $\mu$ V	Measurement Level dB $\mu$ V/m	Margin dB	Limit dB $\mu$ V/m
<b>Horizontal</b>					
<b>Peak Detector:</b>					
10360.000	12.930	37.450	50.380	-23.620	74.000
15540.000	*	*	*	*	74.000
20720.000	*	*	*	*	74.000
25900.000	*	*	*	*	74.000
31080.000	*	*	*	*	74.000
36260.000	*	*	*	*	74.000
<b>Average Detector:</b>					
*	*	*	*	*	*
<b>Vertical</b>					
<b>Peak Detector:</b>					
10360.000	13.724	36.470	50.194	-23.806	74.000
15540.000	*	*	*	*	74.000
20720.000	*	*	*	*	74.000
25900.000	*	*	*	*	74.000
31080.000	*	*	*	*	74.000
36260.000	*	*	*	*	74.000
<b>Average Detector:</b>					
*	*	*	*	*	*

Note:

1. All Readings below 1GHz are Quasi-Peak, above 1GHz are performed with peak and/or average measurements as necessary.
2. Peak measurements: RBW = 1MHz, VBW = 3 MHz, Sweep: Auto.
3. Average measurements: RBW = 1MHz, VBW = 10 Hz, Sweep: Auto.
4. Measurement Level = Reading Level + Correct Factor.
5. Correct Factor = Antenna factor + Cable loss – Amplifier gain.
6. The average measurement was not performed when the peak measured data under the limit of average detection.
7. The emission levels of other frequencies are very lower than the limit and not show in test report.

Product : TABLET PC  
 Test Item : Harmonic Radiated Emission Data  
 Test Site : No.3 OATS  
 Test Mode : Mode 1: Transmit (802.11a-6Mbps) (5220MHz)

Frequency MHz	Correct Factor dB	Reading Level dB $\mu$ V	Measurement Level dB $\mu$ V/m	Margin dB	Limit dB $\mu$ V/m
<b>Horizontal</b>					
<b>Peak Detector:</b>					
10440.000	13.322	36.610	49.932	-24.068	74.000
15660.000	*	*	*	*	74.000
20880.000	*	*	*	*	74.000
26100.000	*	*	*	*	74.000
<b>Average Detector:</b>					
*	*	*	*	*	*
<b>Vertical</b>					
<b>Peak Detector:</b>					
10440.000	14.245	37.120	51.365	-22.635	74.000
15660.000	*	*	*	*	74.000
20880.000	*	*	*	*	74.000
26100.000	*	*	*	*	74.000
<b>Average Detector:</b>					
*	*	*	*	*	*

Note:

1. All Readings below 1GHz are Quasi-Peak, above 1GHz are performed with peak and/or average measurements as necessary.
2. Peak measurements: RBW = 1MHz, VBW = 3 MHz, Sweep: Auto.
3. Average measurements: RBW = 1MHz, VBW = 10 Hz, Sweep: Auto.
4. Measurement Level = Reading Level + Correct Factor.
5. Correct Factor = Antenna factor + Cable loss – Amplifier gain.
6. The average measurement was not performed when the peak measured data under the limit of average detection.
7. The emission levels of other frequencies are very lower than the limit and not show in test report.

Product : TABLET PC  
 Test Item : Harmonic Radiated Emission Data  
 Test Site : No.3 OATS  
 Test Mode : Mode 1: Transmit (802.11a-6Mbps) (5240MHz)

Frequency MHz	Correct Factor dB	Reading Level dB $\mu$ V	Measurement Level dB $\mu$ V/m	Margin dB	Limit dB $\mu$ V/m
<b>Horizontal</b>					
<b>Peak Detector:</b>					
10480.000	13.693	37.320	51.014	-22.986	74.000
15720.000	*	*	*	*	74.000
20960.000	*	*	*	*	74.000
26200.000	*	*	*	*	74.000
<b>Average</b>					
<b>Detector:</b>					
*	*	*	*	*	*
<b>Vertical</b>					
<b>Peak Detector:</b>					
10480.000	14.620	37.440	52.061	-21.939	74.000
15720.000	*	*	*	*	74.000
20960.000	*	*	*	*	74.000
26200.000	*	*	*	*	74.000
<b>Average</b>					
<b>Detector:</b>					
*	*	*	*	*	*

Note:

1. All Readings below 1GHz are Quasi-Peak, above 1GHz are performed with peak and/or average measurements as necessary.
2. Peak measurements: RBW = 1MHz, VBW = 3 MHz, Sweep: Auto.
3. Average measurements: RBW = 1MHz, VBW = 10 Hz, Sweep: Auto.
4. Measurement Level = Reading Level + Correct Factor.
5. Correct Factor = Antenna factor + Cable loss – Amplifier gain.
6. The average measurement was not performed when the peak measured data under the limit of average detection.
7. The emission levels of other frequencies are very lower than the limit and not show in test report.

Product : TABLET PC  
 Test Item : Harmonic Radiated Emission Data  
 Test Site : No.3 OATS  
 Test Mode : Mode 1: Transmit (802.11a-6Mbps) (5260MHz)

Frequency MHz	Correct Factor dB	Reading Level dB $\mu$ V	Measurement Level dB $\mu$ V/m	Margin dB	Limit dB $\mu$ V/m
<b>Horizontal</b>					
<b>Peak Detector:</b>					
10520.000	14.015	36.410	50.425	-23.575	74.000
15780.000	*	*	*	*	74.000
21040.000	*	*	*	*	74.000
26300.000	*	*	*	*	74.000
<b>Average</b>					
<b>Detector:</b>					
*	*	*	*	*	*
<b>Vertical</b>					
<b>Peak Detector:</b>					
10520.000	14.818	36.620	51.438	-22.562	74.000
15780.000	*	*	*	*	74.000
21040.000	*	*	*	*	74.000
26300.000	*	*	*	*	74.000
<b>Average</b>					
<b>Detector:</b>					
*	*	*	*	*	*

Note:

1. All Readings below 1GHz are Quasi-Peak, above 1GHz are performed with peak and/or average measurements as necessary.
2. Peak measurements: RBW = 1MHz, VBW = 3 MHz, Sweep: Auto.
3. Average measurements: RBW = 1MHz, VBW = 10 Hz, Sweep: Auto.
4. Measurement Level = Reading Level + Correct Factor.
5. Correct Factor = Antenna factor + Cable loss – Amplifier gain.
6. The average measurement was not performed when the peak measured data under the limit of average detection.
7. The emission levels of other frequencies are very lower than the limit and not show in test report.

Product : TABLET PC  
 Test Item : Harmonic Radiated Emission Data  
 Test Site : No.3 OATS  
 Test Mode : Mode 1: Transmit (802.11a-6Mbps) (5300MHz)

Frequency MHz	Correct Factor dB	Reading Level dB $\mu$ V	Measurement Level dB $\mu$ V/m	Margin dB	Limit dB $\mu$ V/m
<b>Horizontal</b>					
<b>Peak Detector:</b>					
10600.000	14.550	36.570	51.119	-22.881	74.000
15900.000	*	*	*	*	74.000
21200.000	*	*	*	*	74.000
26500.000	*	*	*	*	74.000
<b>Average Detector:</b>					
*	*	*	*	*	*
<b>Vertical</b>					
<b>Peak Detector:</b>					
10600.000	14.881	36.840	51.721	-22.279	74.000
15900.000	*	*	*	*	74.000
21200.000	*	*	*	*	74.000
26500.000	*	*	*	*	74.000
<b>Average Detector:</b>					
*	*	*	*	*	*

Note:

1. All Readings below 1GHz are Quasi-Peak, above 1GHz are performed with peak and/or average measurements as necessary.
2. Peak measurements: RBW = 1MHz, VBW = 3 MHz, Sweep: Auto.
3. Average measurements: RBW = 1MHz, VBW = 10 Hz, Sweep: Auto.
4. Measurement Level = Reading Level + Correct Factor.
5. Correct Factor = Antenna factor + Cable loss – Amplifier gain.
6. The average measurement was not performed when the peak measured data under the limit of average detection.
7. The emission levels of other frequencies are very lower than the limit and not show in test report.

Product : TABLET PC  
 Test Item : Harmonic Radiated Emission Data  
 Test Site : No.3 OATS  
 Test Mode : Mode 1: Transmit (802.11a-6Mbps) (5320MHz)

Frequency MHz	Correct Factor dB	Reading Level dB $\mu$ V	Measurement Level dB $\mu$ V/m	Margin dB	Limit dB $\mu$ V/m
<b>Horizontal</b>					
<b>Peak Detector:</b>					
10640.000	14.690	36.330	51.020	-22.980	74.000
15960.000	*	*	*	*	74.000
21280.000	*	*	*	*	74.000
26600.000	*	*	*	*	74.000
<b>Average Detector:</b>					
*	*	*	*	*	*
<b>Vertical</b>					
<b>Peak Detector:</b>					
10640.000	15.083	36.490	51.573	-22.427	74.000
15960.000	*	*	*	*	74.000
21280.000	*	*	*	*	74.000
26600.000	*	*	*	*	74.000
<b>Average Detector:</b>					
*	*	*	*	*	*

Note:

1. All Readings below 1GHz are Quasi-Peak, above 1GHz are performed with peak and/or average measurements as necessary.
2. Peak measurements: RBW = 1MHz, VBW = 3 MHz, Sweep: Auto.
3. Average measurements: RBW = 1MHz, VBW = 10 Hz, Sweep: Auto.
4. Measurement Level = Reading Level + Correct Factor.
5. Correct Factor = Antenna factor + Cable loss – Amplifier gain.
6. The average measurement was not performed when the peak measured data under the limit of average detection.
7. The emission levels of other frequencies are very lower than the limit and not show in test report.



Product : TABLET PC  
 Test Item : Harmonic Radiated Emission Data  
 Test Site : No.3 OATS  
 Test Mode : Mode 1: Transmit (802.11a-6Mbps) (5500MHz)

Frequency MHz	Correct Factor dB	Reading Level dB $\mu$ V	Measurement Level dB $\mu$ V/m	Margin dB	Limit dB $\mu$ V/m
<b>Horizontal</b>					
<b>Peak Detector:</b>					
11160.000	16.664	35.970	52.635	-21.365	74.000
16500.000	*	*	*	*	74.000
22000.000	*	*	*	*	74.000
27500.000	*	*	*	*	74.000
<b>Average Detector:</b>					
*	*	*	*	*	*
<b>Vertical</b>					
<b>Peak Detector:</b>					
11160.000	17.643	36.120	53.763	-20.237	74.000
16500.000	*	*	*	*	74.000
22000.000	*	*	*	*	74.000
27500.000	*	*	*	*	74.000
<b>Average Detector:</b>					
*	*	*	*	*	*

Note:

1. All Readings below 1GHz are Quasi-Peak, above 1GHz are performed with peak and/or average measurements as necessary.
2. Peak measurements: RBW = 1MHz, VBW = 3 MHz, Sweep: Auto.
3. Average measurements: RBW = 1MHz, VBW = 10 Hz, Sweep: Auto.
4. Measurement Level = Reading Level + Correct Factor.
5. Correct Factor = Antenna factor + Cable loss – Amplifier gain.
6. The average measurement was not performed when the peak measured data under the limit of average detection.
7. The emission levels of other frequencies are very lower than the limit and not show in test report.

Product : TABLET PC  
 Test Item : Harmonic Radiated Emission Data  
 Test Site : No.3 OATS  
 Test Mode : Mode 1: Transmit (802.11a-6Mbps) (5580MHz)

Frequency MHz	Correct Factor dB	Reading Level dB $\mu$ V	Measurement Level dB $\mu$ V/m	Margin dB	Limit dB $\mu$ V/m
<b>Horizontal</b>					
<b>Peak Detector:</b>					
11160.000	16.664	35.910	52.575	-21.425	74.000
16800.000	*	*	*	*	74.000
22400.000	*	*	*	*	74.000
28000.000	*	*	*	*	74.000
<b>Average Detector:</b>					
*	*	*	*	*	*
<b>Vertical</b>					
<b>Peak Detector:</b>					
11160.000	17.643	36.230	53.873	-20.127	74.000
16800.000	*	*	*	*	74.000
22400.000	*	*	*	*	74.000
28000.000	*	*	*	*	74.000
<b>Average Detector:</b>					
*	*	*	*	*	*

Note:

1. All Readings below 1GHz are Quasi-Peak, above 1GHz are performed with peak and/or average measurements as necessary.
2. Peak measurements: RBW = 1MHz, VBW = 3 MHz, Sweep: Auto.
3. Average measurements: RBW = 1MHz, VBW = 10 Hz, Sweep: Auto.
4. Measurement Level = Reading Level + Correct Factor.
5. Correct Factor = Antenna factor + Cable loss – Amplifier gain.
6. The average measurement was not performed when the peak measured data under the limit of average detection.
7. The emission levels of other frequencies are very lower than the limit and not show in test report.

Product : TABLET PC  
 Test Item : Harmonic Radiated Emission Data  
 Test Site : No.3 OATS  
 Test Mode : Mode 1: Transmit (802.11a-6Mbps) (5700MHz)

Frequency MHz	Correct Factor dB	Reading Level dB $\mu$ V	Measurement Level dB $\mu$ V/m	Margin dB	Limit dB $\mu$ V/m
<b>Horizontal</b>					
<b>Peak Detector:</b>					
11400.000	16.530	36.070	52.601	-21.399	74.000
17100.000	*	*	*	*	74.000
22800.000	*	*	*	*	74.000
28500.000	*	*	*	*	74.000
<b>Average Detector:</b>					
*	*	*	*	*	*
<b>Vertical</b>					
<b>Peak Detector:</b>					
11400.000	17.138	36.280	53.418	-20.582	74.000
17100.000	*	*	*	*	74.000
22800.000	*	*	*	*	74.000
28500.000	*	*	*	*	74.000
<b>Average Detector:</b>					
*	*	*	*	*	*

Note:

1. All Readings below 1GHz are Quasi-Peak, above 1GHz are performed with peak and/or average measurements as necessary.
2. Peak measurements: RBW = 1MHz, VBW = 3 MHz, Sweep: Auto.
3. Average measurements: RBW = 1MHz, VBW = 10 Hz, Sweep: Auto.
4. Measurement Level = Reading Level + Correct Factor.
5. Correct Factor = Antenna factor + Cable loss – Amplifier gain.
6. The average measurement was not performed when the peak measured data under the limit of average detection.
7. The emission levels of other frequencies are very lower than the limit and not show in test report.

Product : TABLET PC  
 Test Item : Harmonic Radiated Emission Data  
 Test Site : No.3 OATS  
 Test Mode : Mode 1: Transmit (802.11a-6Mbps) (5745MHz)

Frequency MHz	Correct Factor dB	Reading Level dBuV	Measurement Level dBuV/m	Margin dB	Limit dBuV/m
<b>Horizontal</b>					
<b>Peak Detector:</b>					
11490.000	17.106	35.860	52.967	-21.033	74.000
17235.000	*	*	*	*	74.000
20720.000	*	*	*	*	74.000
25900.000	*	*	*	*	74.000
31080.000	*	*	*	*	74.000
36260.000	*	*	*	*	74.000
<b>Average Detector:</b>					
*	*	*	*	*	*
<b>Vertical</b>					
<b>Peak Detector:</b>					
11490.000	18.034	35.320	53.355	-20.645	74.000
17235.000	*	*	*	*	74.000
20720.000	*	*	*	*	74.000
25900.000	*	*	*	*	74.000
31080.000	*	*	*	*	74.000
36260.000	*	*	*	*	74.000
<b>Average Detector:</b>					
*	*	*	*	*	*

Note:

1. All Readings below 1GHz are Quasi-Peak, above 1GHz are performed with peak and/or average measurements as necessary.
2. Peak measurements: RBW = 1MHz, VBW = 3 MHz, Sweep: Auto.
3. Average measurements: RBW = 1MHz, VBW = 10 Hz, Sweep: Auto.
4. Measurement Level = Reading Level + Correct Factor.
5. Correct Factor = Antenna factor + Cable loss – Amplifier gain.
6. The average measurement was not performed when the peak measured data under the limit of average detection.
7. The emission levels of other frequencies are very lower than the limit and not show in test report.

Product : TABLET PC  
 Test Item : Harmonic Radiated Emission Data  
 Test Site : No.3 OATS  
 Test Mode : Mode 1: Transmit (802.11a-6Mbps) (5785MHz)

Frequency MHz	Correct Factor dB	Reading Level dBuV	Measurement Level dBuV/m	Margin dB	Limit dBuV/m
<b>Horizontal</b>					
<b>Peak Detector:</b>					
11570.000	16.809	35.830	52.639	-21.361	74.000
17355.000	*	*	*	*	74.000
20800.000	*	*	*	*	74.000
26000.000	*	*	*	*	74.000
31200.000	*	*	*	*	74.000
36400.000	*	*	*	*	74.000
<b>Average</b>					
<b>Detector:</b>					
*	*	*	*	*	*
<b>Vertical</b>					
<b>Peak Detector:</b>					
11570.000	17.698	35.070	52.768	-21.232	74.000
17355.000	*	*	*	*	74.000
20800.000	*	*	*	*	74.000
26000.000	*	*	*	*	74.000
31200.000	*	*	*	*	74.000
36400.000	*	*	*	*	74.000
<b>Average</b>					
<b>Detector:</b>					
*	*	*	*	*	*

Note:

1. All Readings below 1GHz are Quasi-Peak, above 1GHz are performed with peak and/or average measurements as necessary.
2. Peak measurements: RBW = 1MHz, VBW = 3 MHz, Sweep: Auto.
3. Average measurements: RBW = 1MHz, VBW = 10 Hz, Sweep: Auto.
4. Measurement Level = Reading Level + Correct Factor.
5. Correct Factor = Antenna factor + Cable loss – Amplifier gain.
6. The average measurement was not performed when the peak measured data under the limit of average detection.
7. The emission levels of other frequencies are very lower than the limit and not show in test report.

Product : TABLET PC  
 Test Item : Harmonic Radiated Emission Data  
 Test Site : No.3 OATS  
 Test Mode : Mode 1: Transmit (802.11a-6Mbps) (5825MHz)

Frequency MHz	Correct Factor dB	Reading Level dBuV	Measurement Level dBuV/m	Margin dB	Limit dBuV/m
<b>Horizontal</b>					
<b>Peak Detector:</b>					
11650.000	16.158	35.850	52.008	-21.992	74.000
17475.000	*	*	*	*	74.000
20960.000	*	*	*	*	74.000
26200.000	*	*	*	*	74.000
31440000	*	*	*	*	74.000
36680.000	*	*	*	*	74.000
<b>Average Detector:</b>					
*	*	*	*	*	*
<b>Vertical</b>					
<b>Peak Detector:</b>					
11650.000	17.274	35.140	52.415	-21.585	74.000
17475.000	*	*	*	*	74.000
20960.000	*	*	*	*	74.000
26200.000	*	*	*	*	74.000
31440000	*	*	*	*	74.000
36680.000	*	*	*	*	74.000
<b>Average Detector:</b>					
*	*	*	*	*	*

Note:

1. All Readings below 1GHz are Quasi-Peak, above 1GHz are performed with peak and/or average measurements as necessary.
2. Peak measurements: RBW = 1MHz, VBW = 3 MHz, Sweep: Auto.
3. Average measurements: RBW = 1MHz, VBW = 10 Hz, Sweep: Auto.
4. Measurement Level = Reading Level + Correct Factor.
5. Correct Factor = Antenna factor + Cable loss – Amplifier gain.
6. The average measurement was not performed when the peak measured data under the limit of average detection.
7. The emission levels of other frequencies are very lower than the limit and not show in test report.

Product : TABLET PC  
 Test Item : Harmonic Radiated Emission Data  
 Test Site : No.3 OATS  
 Test Mode : Mode 2: Transmit (802.11n-20BW 7.2Mbps) (5180MHz)

Frequency MHz	Correct Factor dB	Reading Level dB $\mu$ V	Measurement Level dB $\mu$ V/m	Margin dB	Limit dB $\mu$ V/m
<b>Horizontal</b>					
<b>Peak Detector:</b>					
10360.000	12.930	36.270	49.200	-24.800	74.000
15540.000	*	*	*	*	74.000
20720.000	*	*	*	*	74.000
25900.000	*	*	*	*	74.000
<b>Average Detector:</b>					
*	*	*	*	*	*
<b>Vertical</b>					
<b>Peak Detector:</b>					
10360.000	13.724	36.460	50.184	-23.816	74.000
15540.000	*	*	*	*	74.000
20720.000	*	*	*	*	74.000
25900.000	*	*	*	*	74.000
<b>Average Detector:</b>					
*	*	*	*	*	*

Note:

1. All Readings below 1GHz are Quasi-Peak, above 1GHz are performed with peak and/or average measurements as necessary.
2. Peak measurements: RBW = 1MHz, VBW = 3 MHz, Sweep: Auto.
3. Average measurements: RBW = 1MHz, VBW = 10 Hz, Sweep: Auto.
4. Measurement Level = Reading Level + Correct Factor.
5. Correct Factor = Antenna factor + Cable loss – Amplifier gain.
6. The average measurement was not performed when the peak measured data under the limit of average detection.
7. The emission levels of other frequencies are very lower than the limit and not show in test report.

Product : TABLET PC  
 Test Item : Harmonic Radiated Emission Data  
 Test Site : No.3 OATS  
 Test Mode : Mode 2: Transmit (802.11n-20BW 7.2Mbps) (5220MHz)

Frequency MHz	Correct Factor dB	Reading Level dB $\mu$ V	Measurement Level dB $\mu$ V/m	Margin dB	Limit dB $\mu$ V/m
<b>Horizontal</b>					
<b>Peak Detector:</b>					
10440.000	13.322	36.290	49.612	-24.388	74.000
15660.000	*	*	*	*	74.000
20880.000	*	*	*	*	74.000
26100.000	*	*	*	*	74.000
<b>Average Detector:</b>					
*	*	*	*	*	*
<b>Vertical</b>					
<b>Peak Detector:</b>					
10440.000	14.245	36.510	50.755	-23.245	74.000
15660.000	*	*	*	*	74.000
20880.000	*	*	*	*	74.000
26100.000	*	*	*	*	74.000
<b>Average Detector:</b>					
*	*	*	*	*	*

Note:

1. All Readings below 1GHz are Quasi-Peak, above 1GHz are performed with peak and/or average measurements as necessary.
2. Peak measurements: RBW = 1MHz, VBW = 3 MHz, Sweep: Auto.
3. Average measurements: RBW = 1MHz, VBW = 10 Hz, Sweep: Auto.
4. Measurement Level = Reading Level + Correct Factor.
5. Correct Factor = Antenna factor + Cable loss – Amplifier gain.
6. The average measurement was not performed when the peak measured data under the limit of average detection.
7. The emission levels of other frequencies are very lower than the limit and not show in test report.



Product : TABLET PC  
 Test Item : Harmonic Radiated Emission Data  
 Test Site : No.3 OATS  
 Test Mode : Mode 2: Transmit (802.11n-20BW 7.2Mbps) (5240MHz)

Frequency MHz	Correct Factor dB	Reading Level dB $\mu$ V	Measurement Level dB $\mu$ V/m	Margin dB	Limit dB $\mu$ V/m
<b>Horizontal</b>					
<b>Peak Detector:</b>					
10480.000	13.693	36.240	49.934	-24.066	74.000
15720.000	*	*	*	*	74.000
20960.000	*	*	*	*	74.000
26200.000	*	*	*	*	74.000
<b>Average Detector:</b>					
*	*	*	*	*	*
<b>Vertical</b>					
<b>Peak Detector:</b>					
10480.000	14.620	36.420	51.041	-22.959	74.000
15720.000	*	*	*	*	74.000
20960.000	*	*	*	*	74.000
26200.000	*	*	*	*	74.000
<b>Average Detector:</b>					
*	*	*	*	*	*

Note:

1. All Readings below 1GHz are Quasi-Peak, above 1GHz are performed with peak and/or average measurements as necessary.
2. Peak measurements: RBW = 1MHz, VBW = 3 MHz, Sweep: Auto.
3. Average measurements: RBW = 1MHz, VBW = 10 Hz, Sweep: Auto.
4. Measurement Level = Reading Level + Correct Factor.
5. Correct Factor = Antenna factor + Cable loss – Amplifier gain.
6. The average measurement was not performed when the peak measured data under the limit of average detection.
7. The emission levels of other frequencies are very lower than the limit and not show in test report.

Product : TABLET PC  
 Test Item : Harmonic Radiated Emission Data  
 Test Site : No.3 OATS  
 Test Mode : Mode 2: Transmit (802.11n-20BW 7.2Mbps) (5260MHz)

Frequency MHz	Correct Factor dB	Reading Level dB $\mu$ V	Measurement Level dB $\mu$ V/m	Margin dB	Limit dB $\mu$ V/m
<b>Horizontal</b>					
<b>Peak Detector:</b>					
10520.000	14.015	36.080	50.095	-23.905	74.000
15780.000	*	*	*	*	74.000
21040.000	*	*	*	*	74.000
26300.000	*	*	*	*	74.000
<b>Average Detector:</b>					
*	*	*	*	*	*
<b>Vertical</b>					
<b>Peak Detector:</b>					
10520.000	14.818	36.330	51.148	-22.852	74.000
15780.000	*	*	*	*	74.000
21040.000	*	*	*	*	74.000
26300.000	*	*	*	*	74.000
<b>Average Detector:</b>					
*	*	*	*	*	*

Note:

1. All Readings below 1GHz are Quasi-Peak, above 1GHz are performed with peak and/or average measurements as necessary.
2. Peak measurements: RBW = 1MHz, VBW = 3 MHz, Sweep: Auto.
3. Average measurements: RBW = 1MHz, VBW = 10 Hz, Sweep: Auto.
4. Measurement Level = Reading Level + Correct Factor.
5. Correct Factor = Antenna factor + Cable loss – Amplifier gain.
6. The average measurement was not performed when the peak measured data under the limit of average detection.
7. The emission levels of other frequencies are very lower than the limit and not show in test report.

Product : TABLET PC  
 Test Item : Harmonic Radiated Emission Data  
 Test Site : No.3 OATS  
 Test Mode : Mode 2: Transmit (802.11n-20BW 7.2Mbps) (5300MHz)

Frequency MHz	Correct Factor dB	Reading Level dB $\mu$ V	Measurement Level dB $\mu$ V/m	Margin dB	Limit dB $\mu$ V/m
<b>Horizontal</b>					
<b>Peak Detector:</b>					
10600.000	14.550	35.950	50.499	-23.501	74.000
15900.000	*	*	*	*	74.000
21200.000	*	*	*	*	74.000
26500.000	*	*	*	*	74.000
<b>Average Detector:</b>					
*	*	*	*	*	*
<b>Vertical</b>					
<b>Peak Detector:</b>					
10600.000	14.881	36.190	51.071	-22.929	74.000
15900.000	*	*	*	*	74.000
21200.000	*	*	*	*	74.000
26500.000	*	*	*	*	74.000
<b>Average Detector:</b>					
*	*	*	*	*	*

Note:

1. All Readings below 1GHz are Quasi-Peak, above 1GHz are performed with peak and/or average measurements as necessary.
2. Peak measurements: RBW = 1MHz, VBW = 3 MHz, Sweep: Auto.
3. Average measurements: RBW = 1MHz, VBW = 10 Hz, Sweep: Auto.
4. Measurement Level = Reading Level + Correct Factor.
5. Correct Factor = Antenna factor + Cable loss – Amplifier gain.
6. The average measurement was not performed when the peak measured data under the limit of average detection.
7. The emission levels of other frequencies are very lower than the limit and not show in test report.

Product : TABLET PC  
 Test Item : Harmonic Radiated Emission Data  
 Test Site : No.3 OATS  
 Test Mode : Mode 2: Transmit (802.11n-20BW 7.2Mbps) (5320MHz)

Frequency MHz	Correct Factor dB	Reading Level dB $\mu$ V	Measurement Level dB $\mu$ V/m	Margin dB	Limit dB $\mu$ V/m
<b>Horizontal</b>					
<b>Peak Detector:</b>					
10640.000	14.690	36.430	51.120	-22.880	74.000
15960.000	*	*	*	*	74.000
21280.000	*	*	*	*	74.000
26600.000	*	*	*	*	74.000
<b>Average Detector:</b>					
*	*	*	*	*	*
<b>Vertical</b>					
<b>Peak Detector:</b>					
10640.000	15.083	36.760	51.843	-22.157	74.000
15960.000	*	*	*	*	74.000
21280.000	*	*	*	*	74.000
26600.000	*	*	*	*	74.000
<b>Average Detector:</b>					
*	*	*	*	*	*

Note:

1. All Readings below 1GHz are Quasi-Peak, above 1GHz are performed with peak and/or average measurements as necessary.
2. Peak measurements: RBW = 1MHz, VBW = 3 MHz, Sweep: Auto.
3. Average measurements: RBW = 1MHz, VBW = 10 Hz, Sweep: Auto.
4. Measurement Level = Reading Level + Correct Factor.
5. Correct Factor = Antenna factor + Cable loss – Amplifier gain.
6. The average measurement was not performed when the peak measured data under the limit of average detection.
7. The emission levels of other frequencies are very lower than the limit and not show in test report.

Product : TABLET PC  
 Test Item : Harmonic Radiated Emission Data  
 Test Site : No.3 OATS  
 Test Mode : Mode 2: Transmit (802.11n-20BW 7.2Mbps) (5500MHz)

Frequency MHz	Correct Factor dB	Reading Level dB $\mu$ V	Measurement Level dB $\mu$ V/m	Margin dB	Limit dB $\mu$ V/m
<b>Horizontal</b>					
<b>Peak Detector:</b>					
11000.000	16.399	35.960	52.359	-21.641	74.000
16500.000	*	*	*	*	74.000
22000.000	*	*	*	*	74.000
27500.000	*	*	*	*	74.000
<b>Average Detector:</b>					
*	*	*	*	*	*
<b>Vertical</b>					
<b>Peak Detector:</b>					
11000.000	17.132	36.120	53.252	-20.748	74.000
16500.000	*	*	*	*	74.000
22000.000	*	*	*	*	74.000
27500.000	*	*	*	*	74.000
<b>Average Detector:</b>					
*	*	*	*	*	*

Note:

1. All Readings below 1GHz are Quasi-Peak, above 1GHz are performed with peak and/or average measurements as necessary.
2. Peak measurements: RBW = 1MHz, VBW = 3 MHz, Sweep: Auto.
3. Average measurements: RBW = 1MHz, VBW = 10 Hz, Sweep: Auto.
4. Measurement Level = Reading Level + Correct Factor.
5. Correct Factor = Antenna factor + Cable loss – Amplifier gain.
6. The average measurement was not performed when the peak measured data under the limit of average detection.
7. The emission levels of other frequencies are very lower than the limit and not show in test report.

Product : TABLET PC  
 Test Item : Harmonic Radiated Emission Data  
 Test Site : No.3 OATS  
 Test Mode : Mode 2: Transmit (802.11n-20BW 7.2Mbps) (5580MHz)

Frequency MHz	Correct Factor dB	Reading Level dB $\mu$ V	Measurement Level dB $\mu$ V/m	Margin dB	Limit dB $\mu$ V/m
<b>Horizontal</b>					
<b>Peak Detector:</b>					
11160.000	16.664	35.910	52.575	-21.425	74.000
16800.000	*	*	*	*	74.000
22400.000	*	*	*	*	74.000
28000.000	*	*	*	*	74.000
<b>Average Detector:</b>					
*	*	*	*	*	*
<b>Vertical</b>					
<b>Peak Detector:</b>					
11160.000	17.643	36.030	53.673	-20.327	74.000
16800.000	*	*	*	*	74.000
22400.000	*	*	*	*	74.000
28000.000	*	*	*	*	74.000
<b>Average Detector:</b>					
*	*	*	*	*	*

Note:

1. All Readings below 1GHz are Quasi-Peak, above 1GHz are performed with peak and/or average measurements as necessary.
2. Peak measurements: RBW = 1MHz, VBW = 3 MHz, Sweep: Auto.
3. Average measurements: RBW = 1MHz, VBW = 10 Hz, Sweep: Auto.
4. Measurement Level = Reading Level + Correct Factor.
5. Correct Factor = Antenna factor + Cable loss – Amplifier gain.
6. The average measurement was not performed when the peak measured data under the limit of average detection.
7. The emission levels of other frequencies are very lower than the limit and not show in test report.

Product : TABLET PC  
 Test Item : Harmonic Radiated Emission Data  
 Test Site : No.3 OATS  
 Test Mode : Mode 2: Transmit (802.11n-20BW 7.2Mbps) (5700MHz)

Frequency MHz	Correct Factor dB	Reading Level dB $\mu$ V	Measurement Level dB $\mu$ V/m	Margin dB	Limit dB $\mu$ V/m
<b>Horizontal</b>					
<b>Peak Detector:</b>					
11400.000	16.530	34.910	51.441	-22.559	74.000
17100.000	*	*	*	*	74.000
22800.000	*	*	*	*	74.000
28500.000	*	*	*	*	74.000
<b>Average Detector:</b>					
*	*	*	*	*	*
<b>Vertical</b>					
<b>Peak Detector:</b>					
11400.000	17.138	36.110	53.248	-20.752	74.000
17100.000	*	*	*	*	74.000
22800.000	*	*	*	*	74.000
28500.000	*	*	*	*	74.000
<b>Average Detector:</b>					
*	*	*	*	*	*

Note:

1. All Readings below 1GHz are Quasi-Peak, above 1GHz are performed with peak and/or average measurements as necessary.
2. Peak measurements: RBW = 1MHz, VBW = 3 MHz, Sweep: Auto.
3. Average measurements: RBW = 1MHz, VBW = 10 Hz, Sweep: Auto.
4. Measurement Level = Reading Level + Correct Factor.
5. Correct Factor = Antenna factor + Cable loss – Amplifier gain.
6. The average measurement was not performed when the peak measured data under the limit of average detection.
7. The emission levels of other frequencies are very lower than the limit and not show in test report.

Product : TABLET PC  
 Test Item : Harmonic Radiated Emission Data  
 Test Site : No.3 OATS  
 Test Mode : Mode 2: Transmit (802.11n-20BW 7.2Mbps) (5745MHz)

Frequency MHz	Correct Factor dB	Reading Level dBuV	Measurement Level dBuV/m	Margin dB	Limit dBuV/m
<b>Horizontal</b>					
<b>Peak Detector:</b>					
11490.000	17.106	35.760	52.867	-21.133	74.000
17235.000	*	*	*	*	74.000
20720.000	*	*	*	*	74.000
25900.000	*	*	*	*	74.000
31080.000	*	*	*	*	74.000
36260.000	*	*	*	*	74.000
<b>Average Detector:</b>					
*	*	*	*	*	*
<b>Vertical</b>					
<b>Peak Detector:</b>					
11490.000	18.034	35.830	53.865	-20.135	74.000
17235.000	*	*	*	*	74.000
20720.000	*	*	*	*	74.000
25900.000	*	*	*	*	74.000
31080.000	*	*	*	*	74.000
36260.000	*	*	*	*	74.000
<b>Average Detector:</b>					
*	*	*	*	*	*

Note:

1. All Readings below 1GHz are Quasi-Peak, above 1GHz are performed with peak and/or average measurements as necessary.
2. Peak measurements: RBW = 1MHz, VBW = 3 MHz, Sweep: Auto.
3. Average measurements: RBW = 1MHz, VBW = 10 Hz, Sweep: Auto.
4. Measurement Level = Reading Level + Correct Factor.
5. Correct Factor = Antenna factor + Cable loss – Amplifier gain.
6. The average measurement was not performed when the peak measured data under the limit of average detection.
7. The emission levels of other frequencies are very lower than the limit and not show in test report.



Product : TABLET PC  
 Test Item : Harmonic Radiated Emission Data  
 Test Site : No.3 OATS  
 Test Mode : Mode 2: Transmit (802.11n-20BW 7.2Mbps) (5785MHz)

Frequency MHz	Correct Factor dB	Reading Level dBuV	Measurement Level dBuV/m	Margin dB	Limit dBuV/m
<b>Horizontal</b>					
<b>Peak Detector:</b>					
11570.000	16.809	35.790	52.599	-21.401	74.000
17355.000	*	*	*	*	74.000
20880.000	*	*	*	*	74.000
26100.000	*	*	*	*	74.000
31320.000	*	*	*	*	74.000
36540.000	*	*	*	*	74.000
<b>Average Detector:</b>					
*	*	*	*	*	*
<b>Vertical</b>					
<b>Peak Detector:</b>					
11570.000	17.698	36.080	53.778	-20.222	74.000
17355.000	*	*	*	*	74.000
20880.000	*	*	*	*	74.000
26100.000	*	*	*	*	74.000
31320.000	*	*	*	*	74.000
36540.000	*	*	*	*	74.000
<b>Average Detector:</b>					
*	*	*	*	*	*

Note:

1. All Readings below 1GHz are Quasi-Peak, above 1GHz are performed with peak and/or average measurements as necessary.
2. Peak measurements: RBW = 1MHz, VBW = 3 MHz, Sweep: Auto.
3. Average measurements: RBW = 1MHz, VBW = 10 Hz, Sweep: Auto.
4. Measurement Level = Reading Level + Correct Factor.
5. Correct Factor = Antenna factor + Cable loss – Amplifier gain.
6. The average measurement was not performed when the peak measured data under the limit of average detection.
7. The emission levels of other frequencies are very lower than the limit and not show in test report.

Product : TABLET PC  
 Test Item : Harmonic Radiated Emission Data  
 Test Site : No.3 OATS  
 Test Mode : Mode 2: Transmit (802.11n-20BW 7.2Mbps) (5825MHz)

Frequency MHz	Correct Factor dB	Reading Level dBuV	Measurement Level dBuV/m	Margin dB	Limit dBuV/m
<b>Horizontal</b>					
<b>Peak Detector:</b>					
11650.000	16.158	35.740	51.898	-22.102	74.000
17475.000	*	*	*	*	74.000
20960.000	*	*	*	*	74.000
26200.000	*	*	*	*	74.000
31440.000	*	*	*	*	74.000
36680.000	*	*	*	*	74.000
<b>Average Detector:</b>					
*	*	*	*	*	*
<b>Vertical</b>					
<b>Peak Detector:</b>					
11650.000	17.274	35.990	53.265	-20.735	74.000
17475.000	*	*	*	*	74.000
20960.000	*	*	*	*	74.000
26200.000	*	*	*	*	74.000
31440.000	*	*	*	*	74.000
36680.000	*	*	*	*	74.000
<b>Average Detector:</b>					
*	*	*	*	*	*

Note:

1. All Readings below 1GHz are Quasi-Peak, above 1GHz are performed with peak and/or average measurements as necessary.
2. Peak measurements: RBW = 1MHz, VBW = 3 MHz, Sweep: Auto.
3. Average measurements: RBW = 1MHz, VBW = 10 Hz, Sweep: Auto.
4. Measurement Level = Reading Level + Correct Factor.
5. Correct Factor = Antenna factor + Cable loss – Amplifier gain.
6. The average measurement was not performed when the peak measured data under the limit of average detection.
7. The emission levels of other frequencies are very lower than the limit and not show in test report.

Product : TABLET PC  
 Test Item : General Radiated Emission  
 Test Site : No.3 OATS  
 Test Mode : Mode 1: Transmit (802.11a-6Mbps) (5220MHz)

Frequency MHz	Correct Factor dB	Reading Level dB $\mu$ V	Measurement Level dB $\mu$ V/m	Margin dB	Limit dB $\mu$ V/m
<b>Horizontal</b>					
<b>Peak Detector</b>					
263.362	-5.004	31.550	26.545	-19.455	46.000
360.362	-1.631	35.475	33.845	-12.155	46.000
503.754	0.154	34.262	34.416	-11.584	46.000
575.449	2.962	37.551	40.513	-5.487	46.000
791.942	5.212	28.488	33.700	-12.300	46.000
933.928	6.630	26.753	33.384	-12.616	46.000
<b>Vertical</b>					
<b>Peak Detector</b>					
263.362	-7.569	28.540	20.970	-25.030	46.000
378.638	-1.584	28.341	26.757	-19.243	46.000
503.754	-0.852	34.758	33.906	-12.094	46.000
575.449	-5.622	39.260	33.638	-12.362	46.000
753.986	3.234	26.701	29.935	-16.065	46.000
933.928	5.813	27.821	33.634	-12.366	46.000

Note:

1. All Readings below 1GHz are Quasi-Peak, above 1GHz are performed with peak and/or average measurements as necessary.
2. Peak measurements: RBW = 1MHz, VBW = 3 MHz, Sweep: Auto.
3. Average measurements: RBW = 1MHz, VBW = 10 Hz, Sweep: Auto.
4. Measurement Level = Reading Level + Correct Factor.
5. Correct Factor = Antenna factor + Cable loss – Amplifier gain.
6. The average measurement was not performed when the peak measured data under the limit of average detection.
7. The emission levels of other frequencies are very lower than the limit and not show in test report.
8. No emission found between lowest internal used/generated frequency to 30MHz.

Product : TABLET PC  
 Test Item : General Radiated Emission  
 Test Site : No.3 OATS  
 Test Mode : Mode 1: Transmit (802.11a-6Mbps) (5300MHz)

Frequency MHz	Correct Factor dB	Reading Level dB $\mu$ V	Measurement Level dB $\mu$ V/m	Margin dB	Limit dB $\mu$ V/m
<b>Horizontal</b>					
<b>Peak Detector</b>					
263.362	-5.004	30.426	25.421	-20.579	46.000
360.362	-1.631	37.538	35.908	-10.092	46.000
455.957	-0.437	35.735	35.298	-10.702	46.000
575.449	2.962	38.165	41.127	-4.873	46.000
791.942	5.212	28.958	34.170	-11.830	46.000
960.638	6.391	26.482	32.873	-21.127	54.000
<b>Vertical</b>					
<b>Peak Detector</b>					
263.362	-7.569	29.389	21.819	-24.181	46.000
360.362	-3.627	34.839	31.212	-14.788	46.000
503.754	-0.852	34.654	33.802	-12.198	46.000
575.449	-5.622	38.938	33.316	-12.684	46.000
755.391	3.286	27.201	30.487	-15.513	46.000
933.928	5.813	28.694	34.507	-11.493	46.000

Note:

1. All Readings below 1GHz are Quasi-Peak, above 1GHz are performed with peak and/or average measurements as necessary.
2. Peak measurements: RBW = 1MHz, VBW = 3 MHz, Sweep: Auto.
3. Average measurements: RBW = 1MHz, VBW = 10 Hz, Sweep: Auto.
4. Measurement Level = Reading Level + Correct Factor.
5. Correct Factor = Antenna factor + Cable loss – Amplifier gain.
6. The average measurement was not performed when the peak measured data under the limit of average detection.
7. The emission levels of other frequencies are very lower than the limit and not show in test report.
8. No emission found between lowest internal used/generated frequency to 30MHz.

Product : TABLET PC  
 Test Item : General Radiated Emission  
 Test Site : No.3 OATS  
 Test Mode : Mode 1: Transmit (802.11a-6Mbps) (5580MHz)

Frequency MHz	Correct Factor dB	Reading Level dBμV	Measurement Level dBμV/m	Margin dB	Limit dBμV/m
<b>Horizontal</b>					
<b>Peak Detector</b>					
263.362	-5.004	30.598	25.593	-20.407	46.000
360.362	-1.631	39.062	37.432	-8.568	46.000
503.754	0.154	35.762	35.916	-10.084	46.000
575.449	2.962	38.254	41.216	-4.784	46.000
791.942	5.212	27.169	32.381	-13.619	46.000
960.638	6.391	26.623	33.014	-20.986	54.000
<b>Vertical</b>					
<b>Peak Detector</b>					
263.362	-7.569	28.022	20.452	-25.548	46.000
360.362	-3.627	34.859	31.232	-14.768	46.000
503.754	-0.852	34.762	33.910	-12.090	46.000
575.449	-5.622	38.541	32.919	-13.081	46.000
758.203	2.777	28.324	31.101	-14.899	46.000
933.928	5.813	27.442	33.255	-12.745	46.000

Note:

1. All Readings below 1GHz are Quasi-Peak, above 1GHz are performed with peak and/or average measurements as necessary.
2. Peak measurements: RBW = 1MHz, VBW = 3 MHz, Sweep: Auto.
3. Average measurements: RBW = 1MHz, VBW = 10 Hz, Sweep: Auto.
4. Measurement Level = Reading Level + Correct Factor.
5. Correct Factor = Antenna factor + Cable loss – Amplifier gain.
6. The average measurement was not performed when the peak measured data under the limit of average detection.
7. The emission levels of other frequencies are very lower than the limit and not show in test report.
8. No emission found between lowest internal used/generated frequency to 30MHz.

Product : TABLET PC  
 Test Item : General Radiated Emission  
 Test Site : No.3 OATS  
 Test Mode : Mode 2: Transmit (802.11n-20BW 7.2Mbps) (5785MHz)

Frequency MHz	Correct Factor dB	Reading Level dB $\mu$ V	Measurement Level dB $\mu$ V/m	Margin dB	Limit dB $\mu$ V/m
<b>Horizontal</b>					
<b>Peak Detector</b>					
263.362	-5.004	30.699	25.694	-20.306	46.000
360.362	-1.631	39.078	37.448	-8.552	46.000
455.957	-0.437	36.285	35.848	-10.152	46.000
575.449	2.962	38.101	41.063	-4.937	46.000
791.942	5.212	28.730	33.942	-12.058	46.000
960.638	6.391	25.994	32.385	-21.615	54.000
<b>Vertical</b>					
<b>Peak Detector</b>					
263.362	-7.569	28.476	20.906	-25.094	46.000
360.362	-3.627	34.802	31.175	-14.825	46.000
503.754	-0.852	35.614	34.762	-11.238	46.000
575.449	-5.622	38.704	33.082	-12.918	46.000
756.797	3.066	27.109	30.175	-15.825	46.000
969.072	8.191	23.017	31.208	-22.792	54.000

Note:

1. All Readings below 1GHz are Quasi-Peak, above 1GHz are performed with peak and/or average measurements as necessary.
2. Peak measurements: RBW = 1MHz, VBW = 3 MHz, Sweep: Auto.
3. Average measurements: RBW = 1MHz, VBW = 10 Hz, Sweep: Auto.
4. Measurement Level = Reading Level + Correct Factor.
5. Correct Factor = Antenna factor + Cable loss – Amplifier gain.
6. The average measurement was not performed when the peak measured data under the limit of average detection.
7. The emission levels of other frequencies are very lower than the limit and not show in test report.
8. No emission found between lowest internal used/generated frequency to 30MHz.

Product : TABLET PC  
 Test Item : General Radiated Emission  
 Test Site : No.3 OATS  
 Test Mode : Mode 2: Transmit (802.11n-20BW 7.2Mbps) (5220MHz)

Frequency MHz	Correct Factor dB	Reading Level dBμV	Measurement Level dBμV/m	Margin dB	Limit dBμV/m
<b>Horizontal</b>					
<b>Peak Detector</b>					
263.362	-5.004	30.926	25.921	-20.079	46.000
360.362	-1.631	38.308	36.678	-9.322	46.000
455.957	-0.437	36.129	35.692	-10.308	46.000
575.449	2.962	37.730	40.692	-5.308	46.000
791.942	5.212	28.566	33.778	-12.222	46.000
933.928	6.630	25.634	32.265	-13.735	46.000
<b>Vertical</b>					
<b>Peak Detector</b>					
263.362	-7.569	28.601	21.031	-24.969	46.000
360.362	-3.627	34.317	30.690	-15.310	46.000
503.754	-0.852	34.888	34.036	-11.964	46.000
575.449	-5.622	39.440	33.818	-12.182	46.000
752.580	3.012	27.753	30.764	-15.236	46.000
960.638	7.166	25.295	32.461	-21.539	54.000

Note:

1. All Readings below 1GHz are Quasi-Peak, above 1GHz are performed with peak and/or average measurements as necessary.
2. Peak measurements: RBW = 1MHz, VBW = 3 MHz, Sweep: Auto.
3. Average measurements: RBW = 1MHz, VBW = 10 Hz, Sweep: Auto.
4. Measurement Level = Reading Level + Correct Factor.
5. Correct Factor = Antenna factor + Cable loss – Amplifier gain.
6. The average measurement was not performed when the peak measured data under the limit of average detection.
7. The emission levels of other frequencies are very lower than the limit and not show in test report.
8. No emission found between lowest internal used/generated frequency to 30MHz.

Product : TABLET PC  
 Test Item : General Radiated Emission  
 Test Site : No.3 OATS  
 Test Mode : Mode 2: Transmit (802.11n-20BW 7.2Mbps) (5300MHz)

Frequency MHz	Correct Factor dB	Reading Level dBμV	Measurement Level dBμV/m	Margin dB	Limit dBμV/m
<b>Horizontal</b>					
<b>Peak Detector</b>					
263.362	-5.004	30.407	25.402	-20.598	46.000
360.362	-1.631	38.664	37.034	-8.966	46.000
455.957	-0.437	36.126	35.689	-10.311	46.000
575.449	2.962	37.992	40.954	-5.046	46.000
791.942	5.212	29.058	34.270	-11.730	46.000
960.638	6.391	26.553	32.944	-21.056	54.000
<b>Vertical</b>					
<b>Peak Detector</b>					
100.290	0.009	24.736	24.745	-18.755	43.500
360.362	-3.627	34.371	30.744	-15.256	46.000
503.754	-0.852	34.747	33.895	-12.105	46.000
575.449	-5.622	38.680	33.058	-12.942	46.000
759.609	2.506	28.080	30.586	-15.414	46.000
933.928	5.813	26.760	32.573	-13.427	46.000

Note:

1. All Readings below 1GHz are Quasi-Peak, above 1GHz are performed with peak and/or average measurements as necessary.
2. Peak measurements: RBW = 1MHz, VBW = 3 MHz, Sweep: Auto.
3. Average measurements: RBW = 1MHz, VBW = 10 Hz, Sweep: Auto.
4. Measurement Level = Reading Level + Correct Factor.
5. Correct Factor = Antenna factor + Cable loss – Amplifier gain.
6. The average measurement was not performed when the peak measured data under the limit of average detection.
7. The emission levels of other frequencies are very lower than the limit and not show in test report.
8. No emission found between lowest internal used/generated frequency to 30MHz.



Product : TABLET PC  
 Test Item : General Radiated Emission  
 Test Site : No.3 OATS  
 Test Mode : Mode 2: Transmit (802.11n-20BW 7.2Mbps) (5580MHz)

Frequency MHz	Correct Factor dB	Reading Level dB $\mu$ V	Measurement Level dB $\mu$ V/m	Margin dB	Limit dB $\mu$ V/m
<b>Horizontal</b>					
<b>Peak Detector</b>					
263.362	-5.004	30.087	25.082	-20.918	46.000
360.362	-1.631	38.646	37.016	-8.984	46.000
455.957	-0.437	36.216	35.779	-10.221	46.000
575.449	2.962	37.580	40.542	-5.458	46.000
791.942	5.212	28.383	33.595	-12.405	46.000
933.928	6.630	26.823	33.454	-12.546	46.000
<b>Vertical</b>					
<b>Peak Detector</b>					
110.130	-0.531	25.166	24.635	-18.865	43.500
360.362	-3.627	35.325	31.698	-14.302	46.000
503.754	-0.852	34.801	33.949	-12.051	46.000
575.449	-5.622	38.903	33.281	-12.719	46.000
759.609	2.506	27.952	30.458	-15.542	46.000
933.928	5.813	26.981	32.794	-13.206	46.000

Note:

1. All Readings below 1GHz are Quasi-Peak, above 1GHz are performed with peak and/or average measurements as necessary.
2. Peak measurements: RBW = 1MHz, VBW = 3 MHz, Sweep: Auto.
3. Average measurements: RBW = 1MHz, VBW = 10 Hz, Sweep: Auto.
4. Measurement Level = Reading Level + Correct Factor.
5. Correct Factor = Antenna factor + Cable loss – Amplifier gain.
6. The average measurement was not performed when the peak measured data under the limit of average detection.
7. The emission levels of other frequencies are very lower than the limit and not show in test report.
8. No emission found between lowest internal used/generated frequency to 30MHz.

Product : TABLET PC  
 Test Item : General Radiated Emission  
 Test Site : No.3 OATS  
 Test Mode : Mode 2: Transmit (802.11n-20BW 7.2Mbps) (5785MHz)

Frequency MHz	Correct Factor dB	Reading Level dB $\mu$ V	Measurement Level dB $\mu$ V/m	Margin dB	Limit dB $\mu$ V/m
<b>Horizontal</b>					
<b>Peak Detector</b>					
263.362	-5.004	30.851	25.846	-20.154	46.000
360.362	-1.631	38.970	37.340	-8.660	46.000
455.957	-0.437	36.075	35.638	-10.362	46.000
575.449	2.962	37.748	40.710	-5.290	46.000
791.942	5.212	28.437	33.649	-12.351	46.000
933.928	6.630	26.131	32.762	-13.238	46.000
<b>Vertical</b>					
<b>Peak Detector</b>					
263.362	-7.569	28.381	20.811	-25.189	46.000
360.362	-3.627	35.140	31.513	-14.487	46.000
503.754	-0.852	35.346	34.494	-11.506	46.000
575.449	-5.622	38.879	33.257	-12.743	46.000
755.391	3.286	26.222	29.508	-16.492	46.000
933.928	5.813	27.295	33.108	-12.892	46.000

Note:

1. All Readings below 1GHz are Quasi-Peak, above 1GHz are performed with peak and/or average measurements as necessary.
2. Peak measurements: RBW = 1MHz, VBW = 3 MHz, Sweep: Auto.
3. Average measurements: RBW = 1MHz, VBW = 10 Hz, Sweep: Auto.
4. Measurement Level = Reading Level + Correct Factor.
5. Correct Factor = Antenna factor + Cable loss – Amplifier gain.
6. The average measurement was not performed when the peak measured data under the limit of average detection.
7. The emission levels of other frequencies are very lower than the limit and not show in test report.
8. No emission found between lowest internal used/generated frequency to 30MHz.

## 6. Band Edge

### 6.1. Test Equipment

#### RF Radiated Measurement:

The following test equipments are used during the band edge tests:

Test Site	Equipment		Manufacturer	Model No./Serial No.	Last Cal.
☒ CB # 8	X	Spectrum Analyzer	R&S	FSP40/ 100339	Oct, 2014
	X	Horn Antenna	ETS-Lindgren	3117/ 35205	Mar, 2015
	X	Horn Antenna	Schwarzbeck	BBHA9170/209	Jan, 2015
	X	Horn Antenna	TRC	AH-0801/95051	Aug, 2014
	X	Pre-Amplifier	EMCI	EMC012630SE/980210	Jan, 2015
	X	Pre-Amplifier	MITEQ	JS41-001040000-58-5P/153945	Jul, 2015
	X	Pre-Amplifier	NARDA	DBL-1840N506/013	Jul, 2015

- Note:
1. All instruments are calibrated every one year.
  2. The test instruments marked by “X” are used to measure the final test results.

### 6.2. Test Setup

#### RF Radiated Measurement:

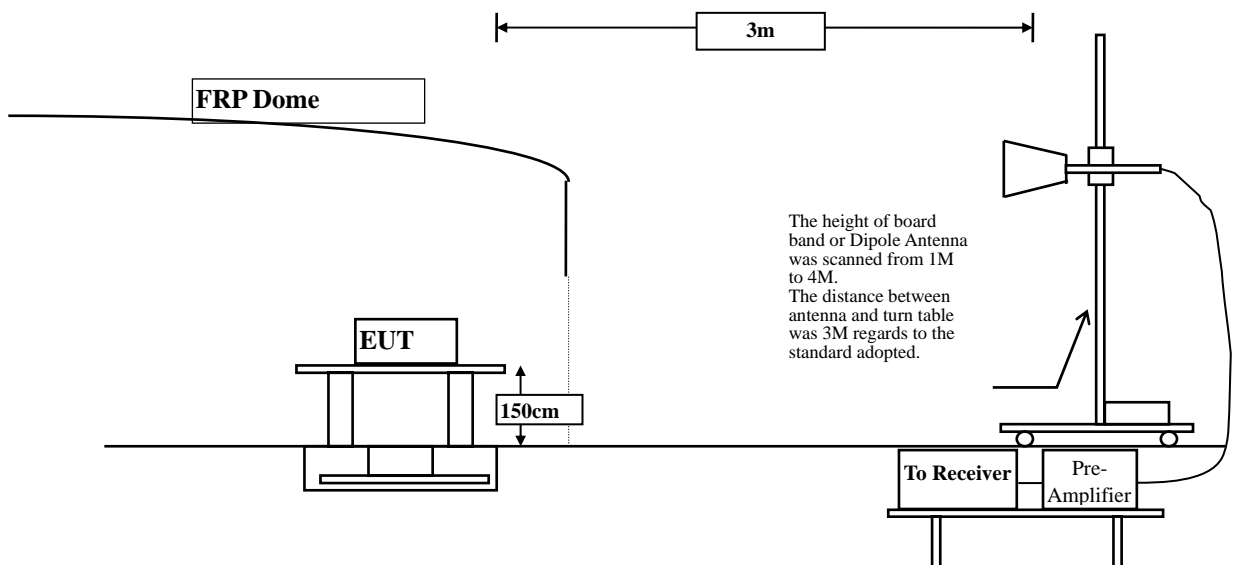

### 6.3. Limits

The provisions of Section 15.205 of this part apply to intentional radiators operating under this section.

Radiated emissions which fall in the restricted bands, as defined in Section 15.205, must also comply with the radiated emission limits specified in Section 15.209:

<b>FCC Part 15 Subpart C Paragraph 15.209 Limits</b>		
Frequency MHz	uV/m @3m	dBµV/m@3m
30-88	100	40
88-216	150	43.5
216-960	200	46
Above 960	500	54

- Remarks :
1. RF Voltage (dBµV) = 20 log RF Voltage (uV)
  2. In the Above Table, the tighter limit applies at the band edges.
  3. Distance refers to the distance in meters between the measuring instrument antenna and the closed point of any part of the device or system.

### 6.4. Test Procedure

The EUT is placed on a turn table which is 1.5 meter above ground. The turn table can rotate 360 degrees to determine the position of the maximum emission level. The EUT was positioned such that the distance from antenna to the EUT was 3 meters.

The antenna can move up and down between 1 meter and 4 meters to find out the maximum emission level.

Both horizontal and vertical polarization of the antenna are set on measurement. In order to find the maximum emission, all of the interface cables must be manipulated according to ANSI C63.10:2013 on radiated measurement.

The bandwidth below 1GHz setting on the field strength meter is 120 kHz, above 1GHz are 1 MHz. The EUT was setup to ANSI C63.10, 2013; tested to UNII test procedure of FCC KDB-789033 for compliance to FCC 47CFR Subpart E requirements.

### 6.5. Uncertainty

± 3.8 dB below 1GHz

± 3.9 dB above 1GHz

### 6.6. Test Result of Band Edge

Product : TABLET PC  
 Test Item : Band Edge Data  
 Test Site : No.3 OATS  
 Test Mode : Mode 1: Transmit (802.11a-6Mbps)-Channel 36

#### RF Radiated Measurement (Horizontal):

Channel No.	Frequency (MHz)	Correct Factor (dB)	Reading Level (dBμV)	Emission Level (dBμV/m)	Peak Limit (dBμV/m)	Average Limit (dBμV/m)	Result
36 (Peak)	5147.200	0.087	56.959	57.046	74.00	54.00	Pass
36 (Peak)	5150.000	0.085	56.780	56.865	74.00	54.00	Pass
36 (Peak)	5183.200	0.452	102.687	103.139	--	--	--
36 (Average)	5150.000	0.085	40.323	40.408	74.00	54.00	Pass
36 (Average)	5181.700	0.432	92.048	92.480	--	--	--

Figure Channel 36: Horizontal (Peak)

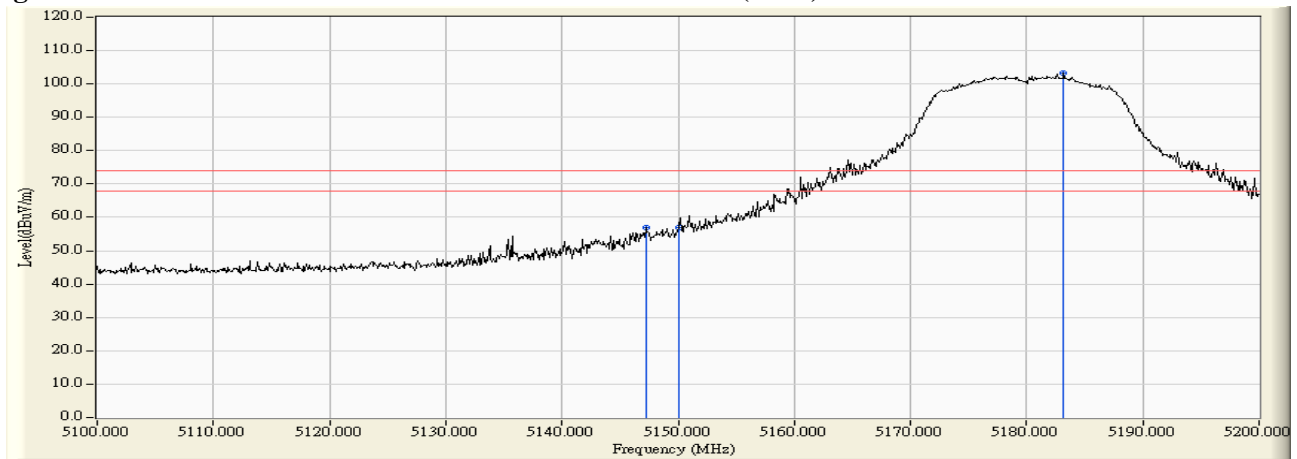
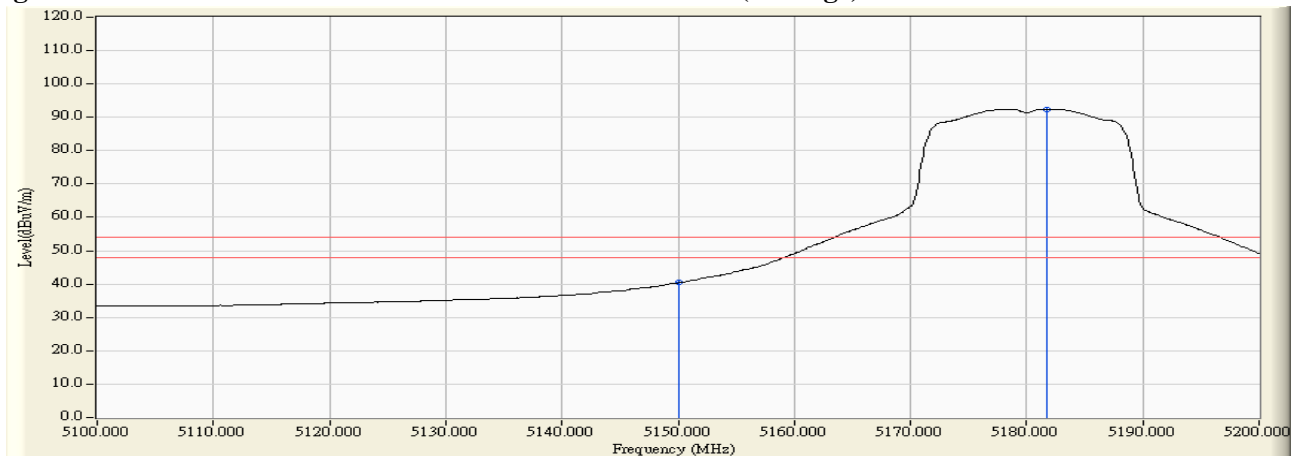

Figure Channel 36: Horizontal (Average)



- Note: 1. All readings above 1GHz are performed with peak and/or average measurements as necessary.  
 2. Peak measurements: RBW = 1MHz, VBW = 3 MHz, Sweep: Auto.  
 3. Average measurements: RBW = 1MHz, VBW = 10 Hz, Sweep: Auto.  
 4. “ \* ”, means this data is the worst emission level.  
 5. Measurement Level = Reading Level + Correct Factor.  
 6. The average measurement was not performed when the peak measured data under the limit of average detection.

Product : TABLET PC  
 Test Item : Band Edge Data  
 Test Site : No.3 OATS  
 Test Mode : Mode 1: Transmit (802.11a-6Mbps)-Channel 36

**RF Radiated Measurement (Vertical):**

Channel No.	Frequency (MHz)	Correct Factor (dB)	Reading Level (dBμV)	Emission Level (dBμV/m)	Peak Limit (dBμV/m)	Average Limit (dBμV/m)	Result
36 (Peak)	5149.900	10.325	59.565	69.890	74.00	54.00	Pass
36 (Peak)	5150.000	10.324	57.779	68.104	74.00	54.00	Pass
36 (Peak)	5183.200	10.616	101.226	111.842	--	--	--
36 (Average)	5150.000	10.324	39.700	50.025	74.00	54.00	Pass
36 (Average)	5181.400	10.596	90.225	100.821	--	--	--

**Figure Channel 36: Vertical (Peak)**

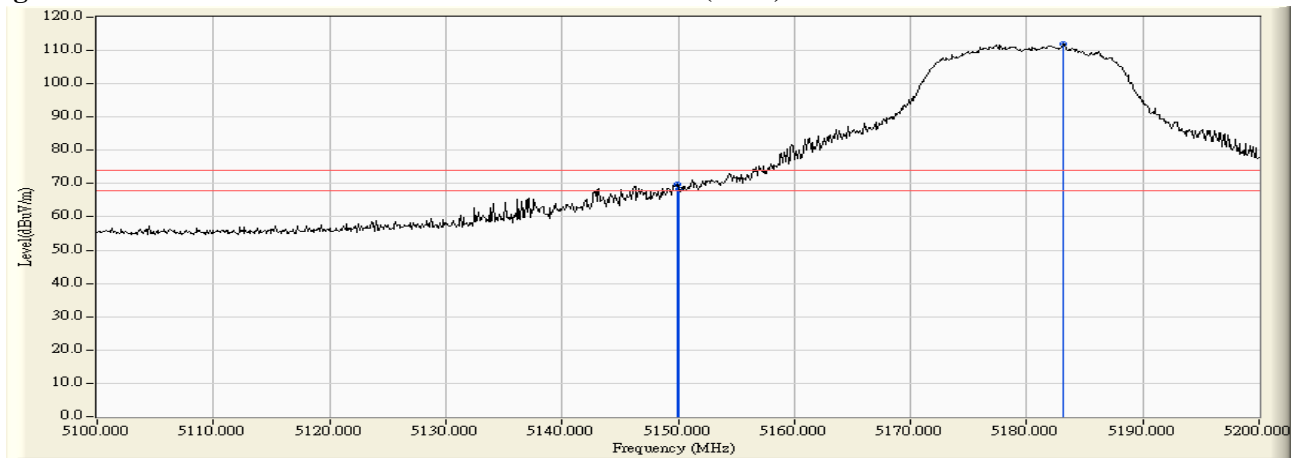

**Figure Channel 36: Vertical (Average)**

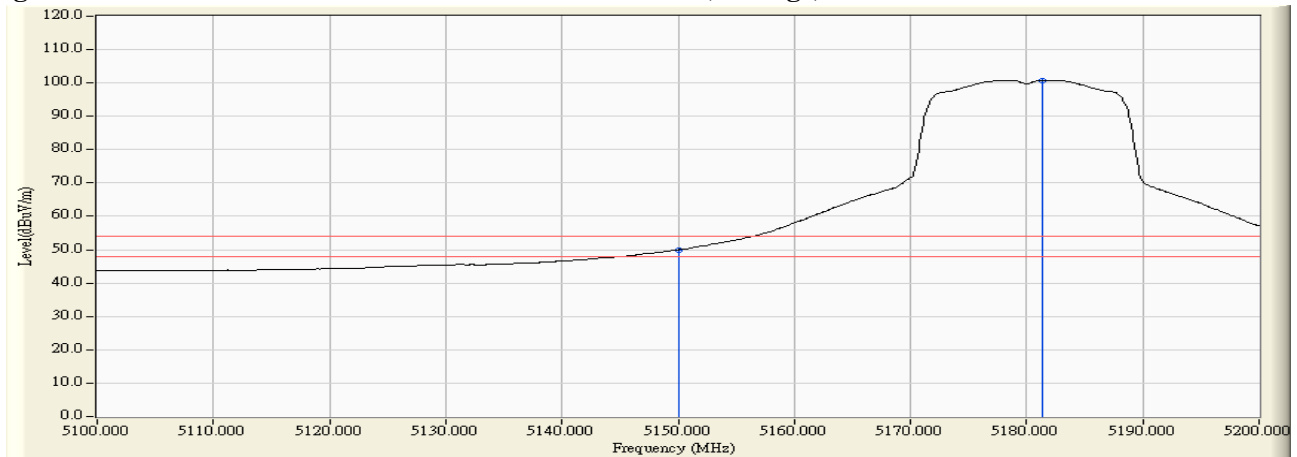

**Note:**

1. All readings above 1GHz are performed with peak and/or average measurements as necessary.
2. Peak measurements: RBW = 1MHz, VBW = 3 MHz, Sweep: Auto.
3. Average measurements: RBW = 1MHz, VBW = 10 Hz, Sweep: Auto.
4. “ \* ”, means this data is the worst emission level.
5. Measurement Level = Reading Level + Correct Factor.
6. The average measurement was not performed when the peak measured data under the limit of average detection.

Product : TABLET PC  
 Test Item : Band Edge Data  
 Test Site : No.3 OATS  
 Test Mode : Mode 1: Transmit (802.11a-6Mbps) -Channel 64

**RF Radiated Measurement (Horizontal):**

Channel No.	Frequency (MHz)	Correct Factor (dB)	Reading Level (dBμV)	Emission Level (dBμV/m)	Peak Limit (dBμV/m)	Average Limit (dBμV/m)	Result
64 (Peak)	5323.200	0.146	100.468	100.614	--	--	--
64 (Peak)	5350.000	0.262	58.828	59.090	74.00	54.00	Pass
64 (Average)	5321.700	0.129	89.284	89.413	--	--	--
64 (Average)	5350.000	0.262	38.724	38.986	74.00	54.00	Pass

**Figure Channel 64: Horizontal (Peak)**

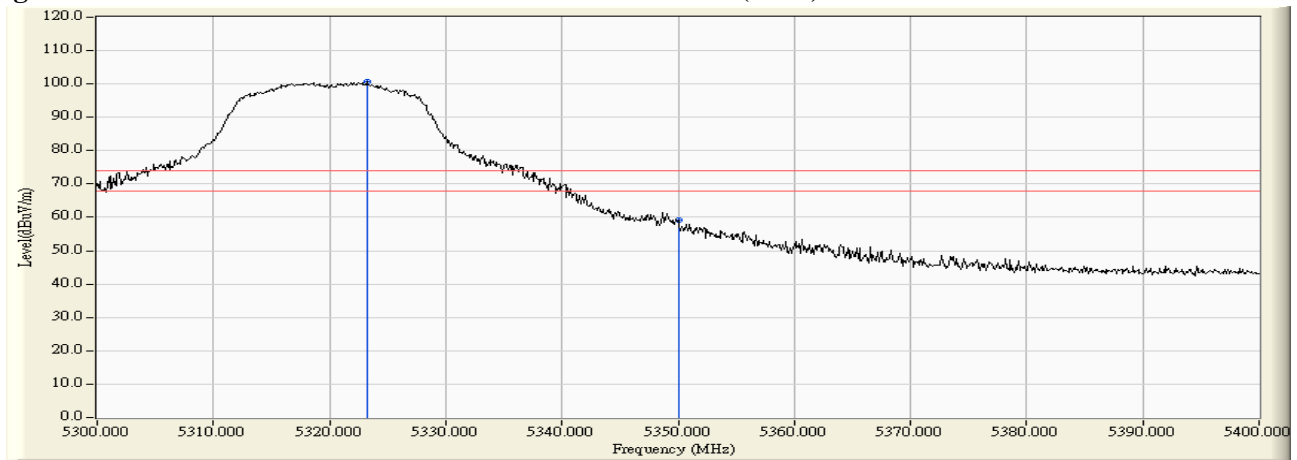

**Figure Channel 64: Horizontal (Average)**

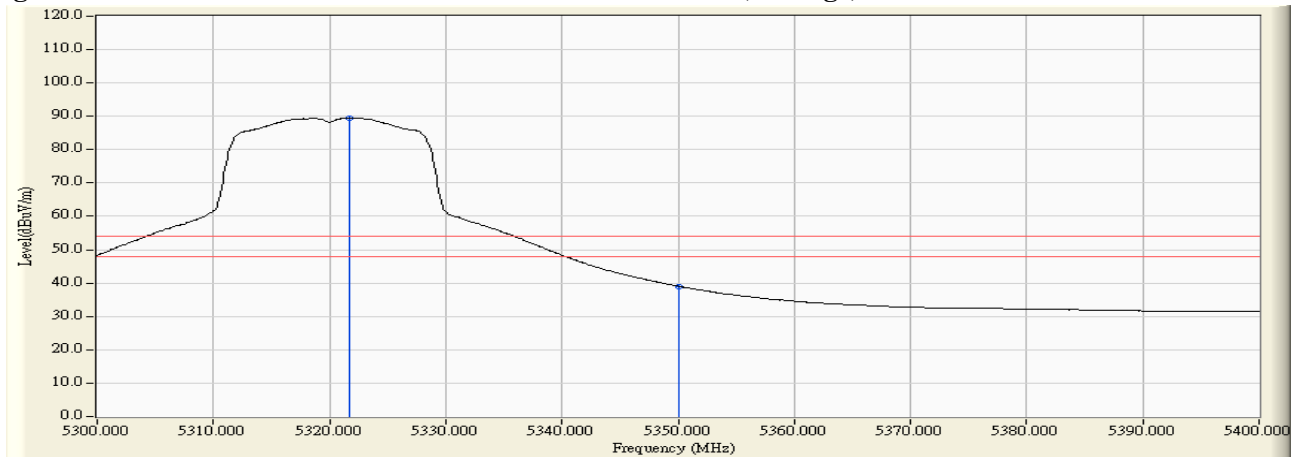

**Note:**

1. All readings above 1GHz are performed with peak and/or average measurements as necessary.
2. Peak measurements: RBW = 1MHz, VBW = 3 MHz, Sweep: Auto.
3. Average measurements: RBW = 1MHz, VBW = 10 Hz, Sweep: Auto.
4. “ \* ”, means this data is the worst emission level.
5. Measurement Level = Reading Level + Correct Factor.
6. The average measurement was not performed when the peak measured data under the limit of average detection.

Product : TABLET PC  
 Test Item : Band Edge Data  
 Test Site : No.3 OATS  
 Test Mode : Mode 1: Transmit (802.11a-6Mbps) -Channel 64

**RF Radiated Measurement (Vertical):**

Channel No.	Frequency (MHz)	Correct Factor (dB)	Reading Level (dBμV)	Emission Level (dBμV/m)	Peak Limit (dBμV/m)	Average Limit (dBμV/m)	Result
64 (Peak)	5323.200	9.891	101.132	111.022	--	--	--
64 (Peak)	5350.000	9.923	61.006	70.930	74.00	54.00	Pass
64 (Average)	5321.500	9.877	89.968	99.844	--	--	--
64 (Average)	5350.000	9.923	41.000	50.924	74.00	54.00	Pass

**Figure Channel 64: Vertical (Peak)**

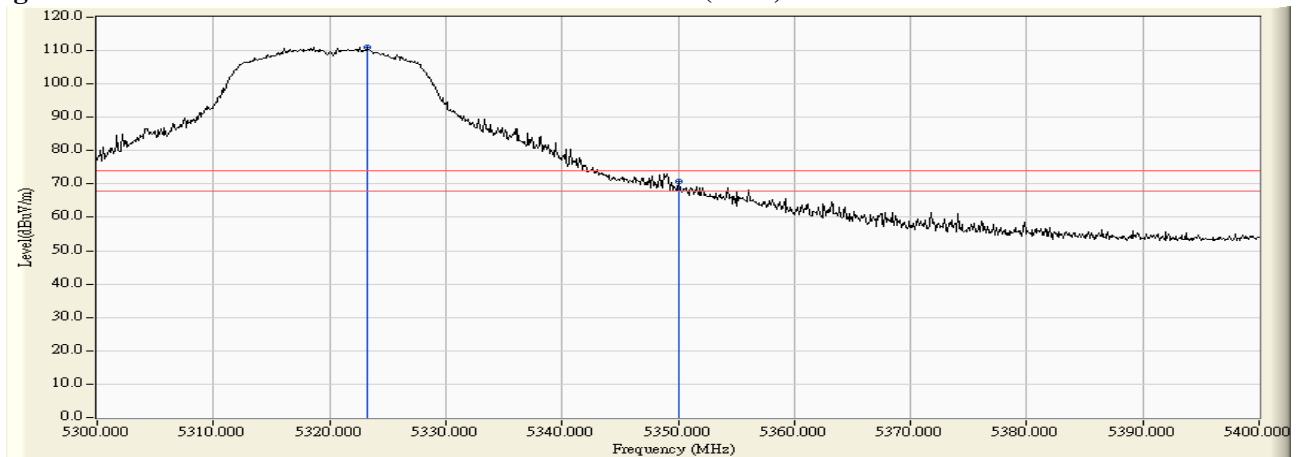

**Figure Channel 64: Vertical (Average)**

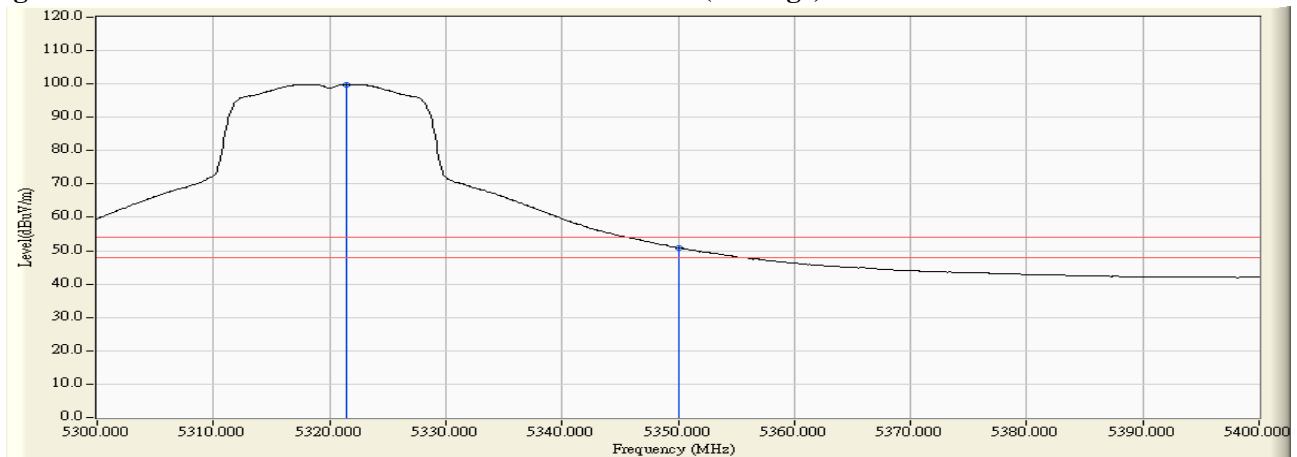

**Note:**

1. All readings above 1GHz are performed with peak and/or average measurements as necessary.
2. Peak measurements: RBW = 1MHz, VBW = 3 MHz, Sweep: Auto.
3. Average measurements: RBW = 1MHz, VBW = 10 Hz, Sweep: Auto.
4. “ \* ”, means this data is the worst emission level.
5. Measurement Level = Reading Level + Correct Factor.
6. The average measurement was not performed when the peak measured data under the limit of average detection.



Product : TABLET PC  
 Test Item : Band Edge Data  
 Test Site : No.3 OATS  
 Test Mode : Mode 1: Transmit (802.11a-6Mbps) -Channel 100

**RF Radiated Measurement (Horizontal):**

Channel No.	Frequency (MHz)	Correct Factor (dB)	Reading Level (dBμV)	Emission Level (dBμV/m)	Peak Limit (dBμV/m)	Average Limit (dBμV/m)	Result
100 (Peak)	5459.800	0.175	55.771	55.946	74.00	54.00	Pass
100 (Peak)	5460.000	0.178	54.483	54.661	74.00	54.00	Pass
100 (Peak)	5499.600	0.573	102.973	103.547	--	--	--
100 (Average)	5460.000	0.178	37.829	38.007	74.00	54.00	Pass
100 (Average)	5501.500	0.594	91.801	92.395	--	--	--

**Figure Channel 100: Horizontal (Peak)**

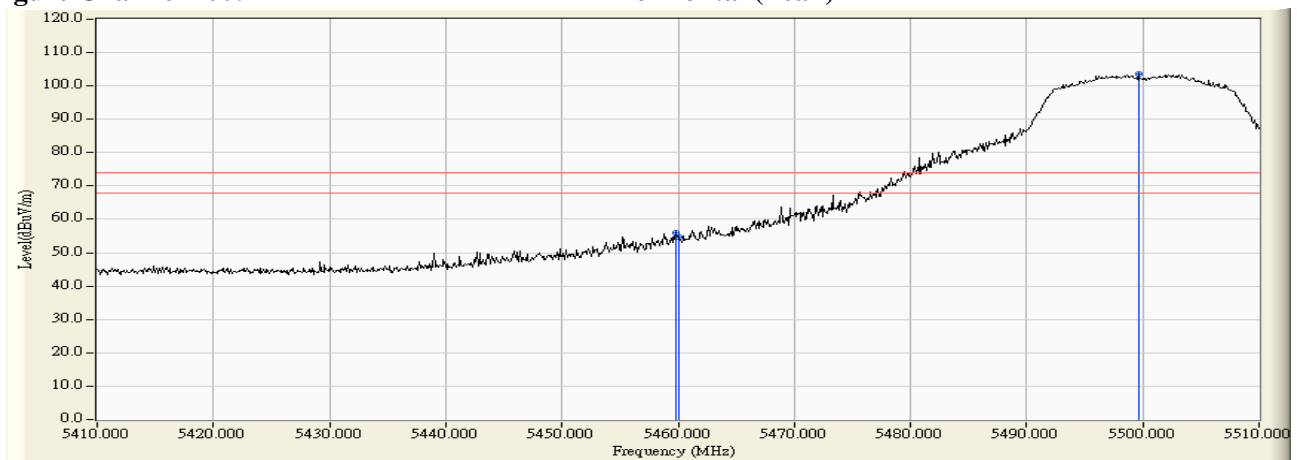

**Figure Channel 100: Horizontal (Average)**

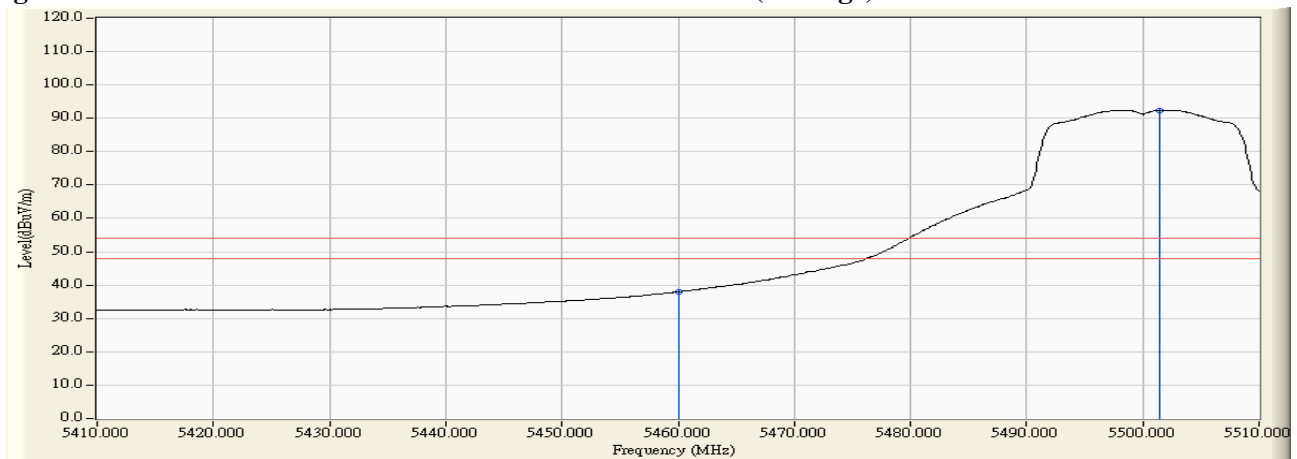

**Note:**

1. All readings above 1GHz are performed with peak and/or average measurements as necessary.
2. Peak measurements: RBW = 1MHz, VBW = 3 MHz, Sweep: Auto.
3. Average measurements: RBW = 1MHz, VBW = 10 Hz, Sweep: Auto.
4. “ \* ”, means this data is the worst emission level.
5. Measurement Level = Reading Level + Correct Factor.
6. The average measurement was not performed when the peak measured data under the limit of average detection.

Product : TABLET PC  
 Test Item : Band Edge Data  
 Test Site : No.3 OATS  
 Test Mode : Mode 1: Transmit (802.11a-6Mbps) -Channel 100

**RF Radiated Measurement (Vertical):**

Channel No.	Frequency (MHz)	Correct Factor (dB)	Reading Level (dB $\mu$ V)	Emission Level (dB $\mu$ V/m)	Peak Limit (dB $\mu$ V/m)	Average Limit (dB $\mu$ V/m)	Result
100 (Peak)	5458.900	9.486	55.043	64.529	74.00	54.00	Pass
100 (Peak)	5460.000	9.497	52.633	62.129	74.00	54.00	Pass
100 (Peak)	5503.200	9.795	102.269	112.064	--	--	--
100 (Average)	5460.000	9.497	36.437	45.933	74.00	54.00	Pass
100 (Average)	5502.600	9.791	91.160	100.951	--	--	--

**Figure Channel 100: Vertical (Peak)**

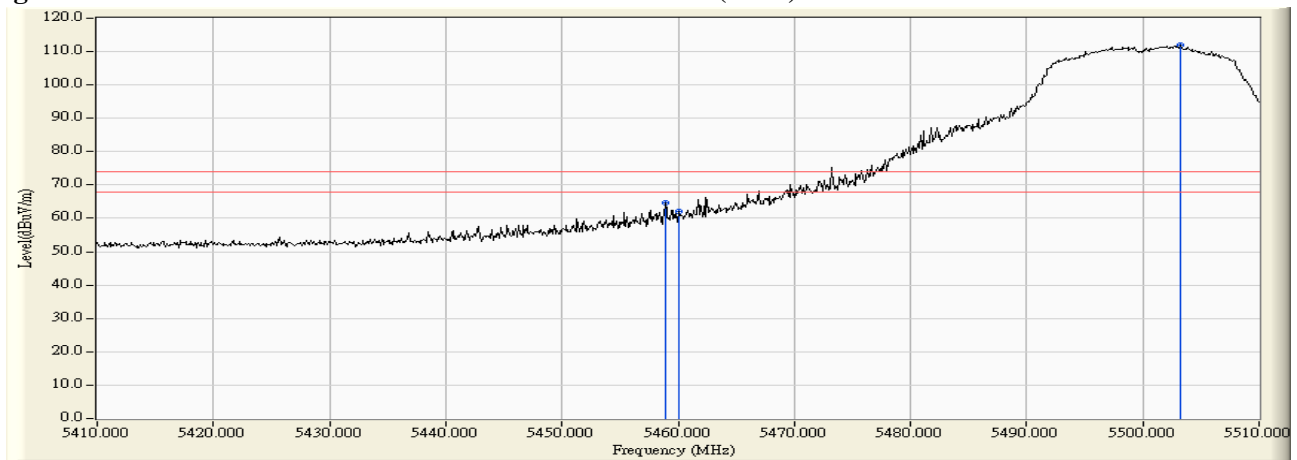

**Figure Channel 100: Vertical (Average)**

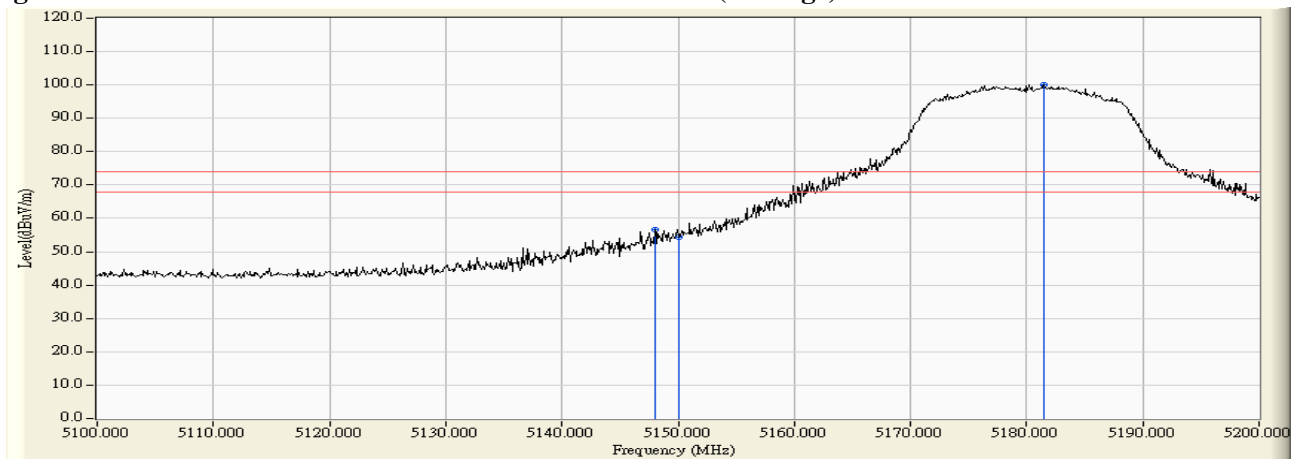

**Note:**

1. All readings above 1GHz are performed with peak and/or average measurements as necessary.
2. Peak measurements: RBW = 1MHz, VBW = 3 MHz, Sweep: Auto.
3. Average measurements: RBW = 1MHz, VBW = 10 Hz, Sweep: Auto.
4. “ \* ”, means this data is the worst emission level.
5. Measurement Level = Reading Level + Correct Factor.
6. The average measurement was not performed when the peak measured data under the limit of average detection.

Product : TABLET PC  
 Test Item : Band Edge Data  
 Test Site : No.3 OATS  
 Test Mode : Mode 1: Transmit (802.11a-6Mbps) -Channel 100

**RF Radiated Measurement:**

	Frequency (MHz)	Correct Factor (dB)	Reading Level (dBm)	Measure Level (dBm/m)	Margin (dB)	Limit (dBm/m)	Result
Horizontal	5470.000	4.488	54.034	58.522	-9.698	68.220	Pass
Horizontal	5499.130	4.809	96.586	101.394	--	--	--

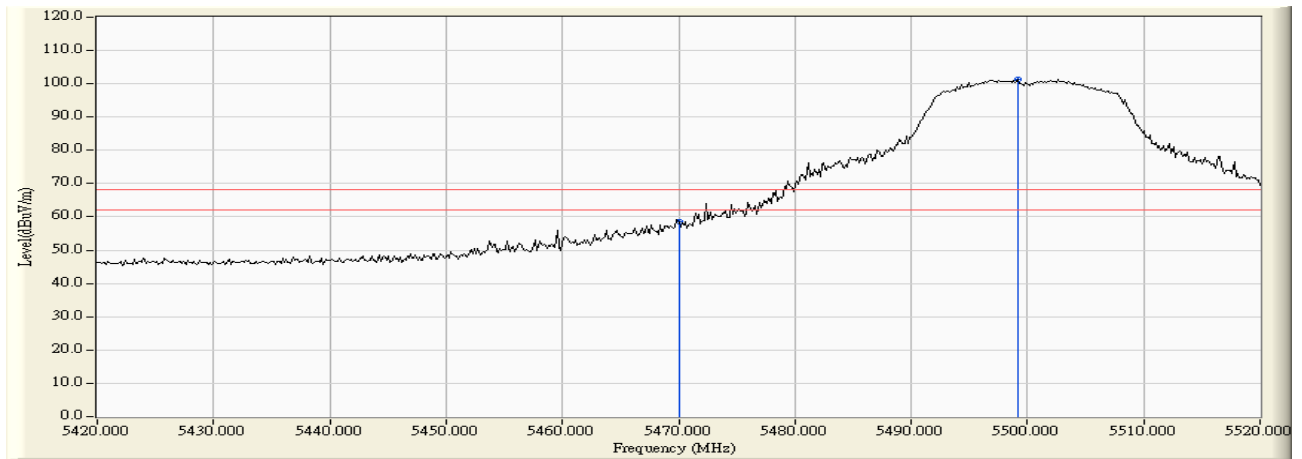

	Frequency (MHz)	Correct Factor (dB)	Reading Level (dBm)	Measure Level (dBm/m)	Margin (dB)	Limit (dBm/m)	Result
Vertical	5468.116	6.098	56.079	62.177	-6.043	68.220	Pass
Vertical	5470.000	6.112	53.324	59.435	-8.785	68.220	Pass
Vertical	5498.696	6.270	98.429	104.700	--	--	--

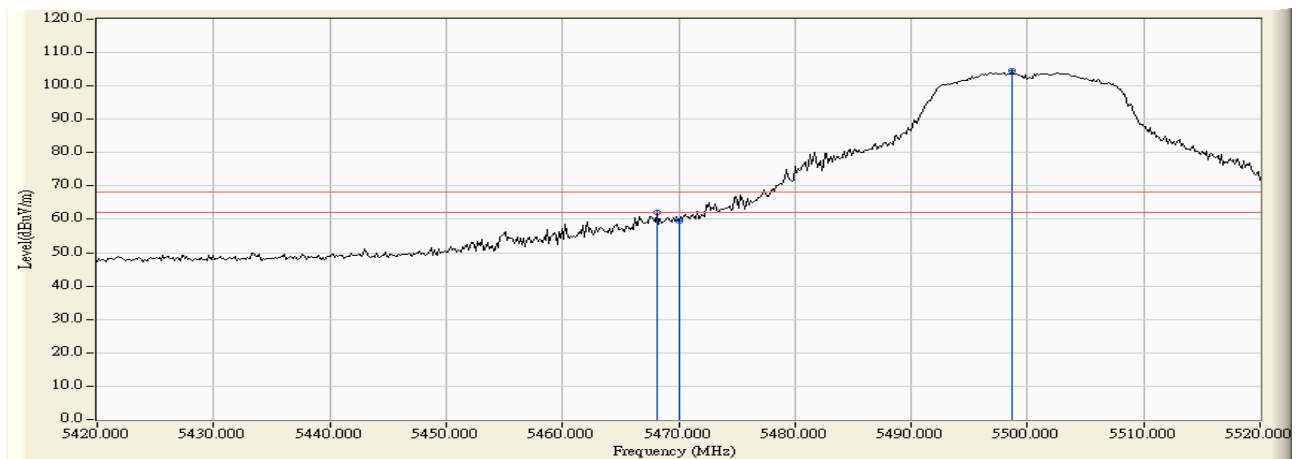

Product : TABLET PC  
 Test Item : Band Edge Data  
 Test Site : No.3 OATS  
 Test Mode : Mode 1: Transmit (802.11a-6Mbps) -Channel 140

**RF Radiated Measurement:**

	Frequency (MHz)	Correct Factor (dB)	Reading Level (dBm)	Measure Level (dBm/m)	Margin (dB)	Limit (dBm/m)	Result
Horizontal	5703.251	4.636	95.693	100.328	--	--	--
Horizontal	5725.000	4.654	58.992	63.646	-4.574	68.220	Pass
Horizontal	5726.232	4.654	60.629	65.283	-2.937	68.220	Pass

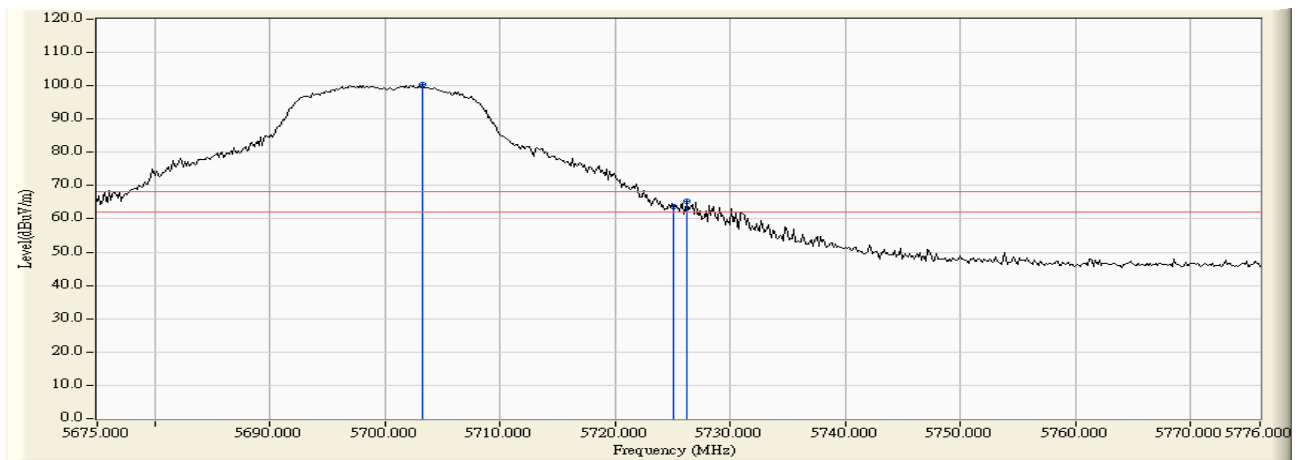

	Frequency (MHz)	Correct Factor (dB)	Reading Level (dBm)	Measure Level (dBm/m)	Margin (dB)	Limit (dBm/m)	Result
Vertical	5703.397	5.987	95.380	101.367	--	--	--
Vertical	5725.000	5.992	57.719	63.712	-4.508	68.220	Pass
Vertical	5727.110	5.992	60.293	66.285	-1.935	68.220	Pass

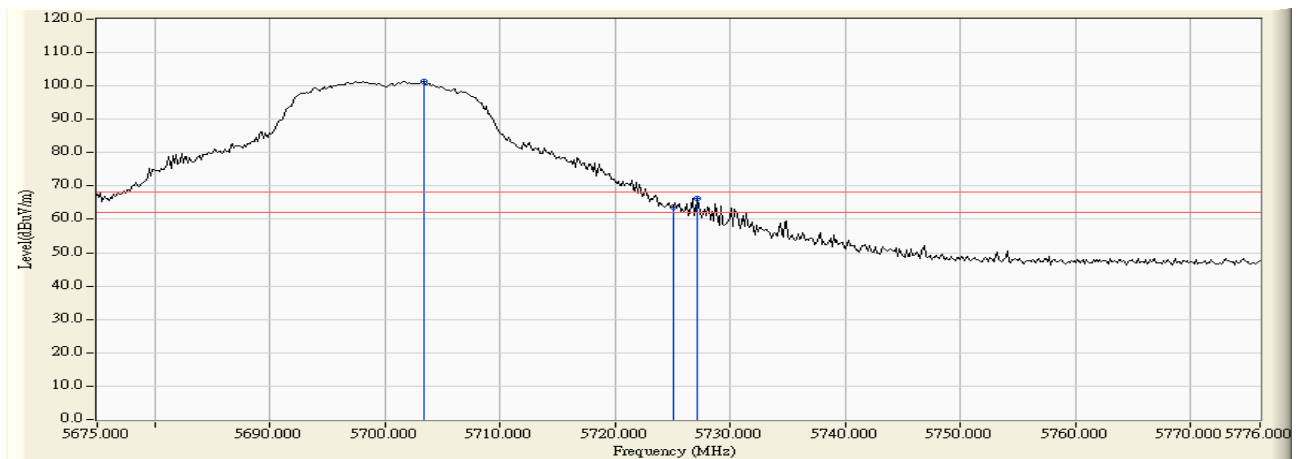

Product : TABLET PC  
 Test Item : Band Edge Data  
 Test Site : No.3 OATS  
 Test Mode : Mode 2: Transmit (802.11n-20BW 7.2Mbps) -Channel 36

**RF Radiated Measurement (Horizontal):**

Channel No.	Frequency (MHz)	Correct Factor (dB)	Reading Level (dBμV)	Emission Level (dBμV/m)	Peak Limit (dBμV/m)	Average Limit (dBμV/m)	Result
36 (Peak)	5148.000	0.079	56.684	56.763	74.00	54.00	Pass
36 (Peak)	5150.000	0.085	54.315	54.400	74.00	54.00	Pass
36 (Peak)	5181.500	0.430	99.697	100.127	--	--	--
36 (Average)	5150.000	0.085	37.706	37.791	74.00	54.00	Pass
36 (Average)	5178.800	0.398	88.591	88.990	--	--	--

**Figure Channel 36: Horizontal (Peak)**

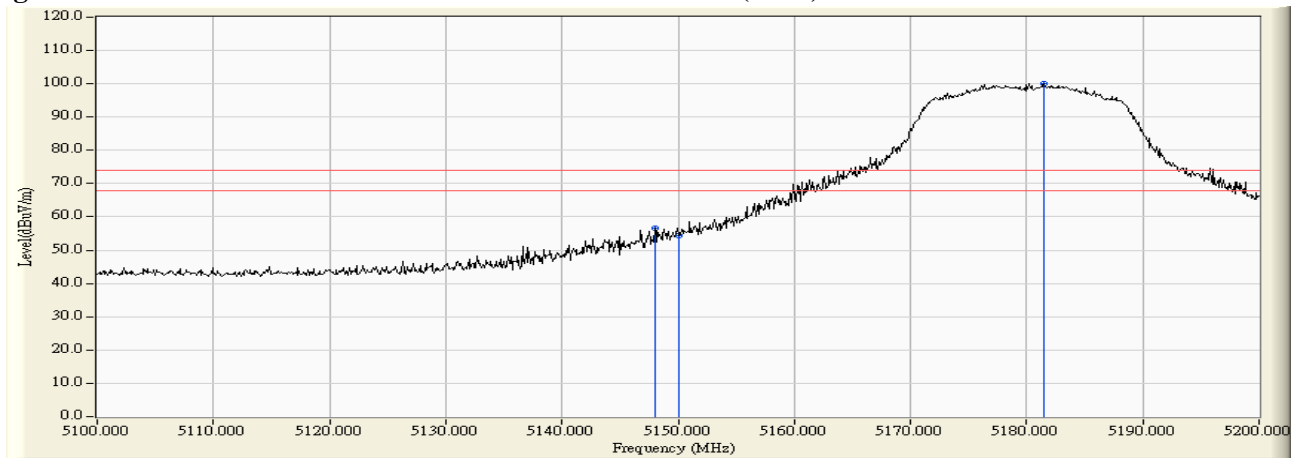

**Figure Channel 36: Horizontal (Average)**

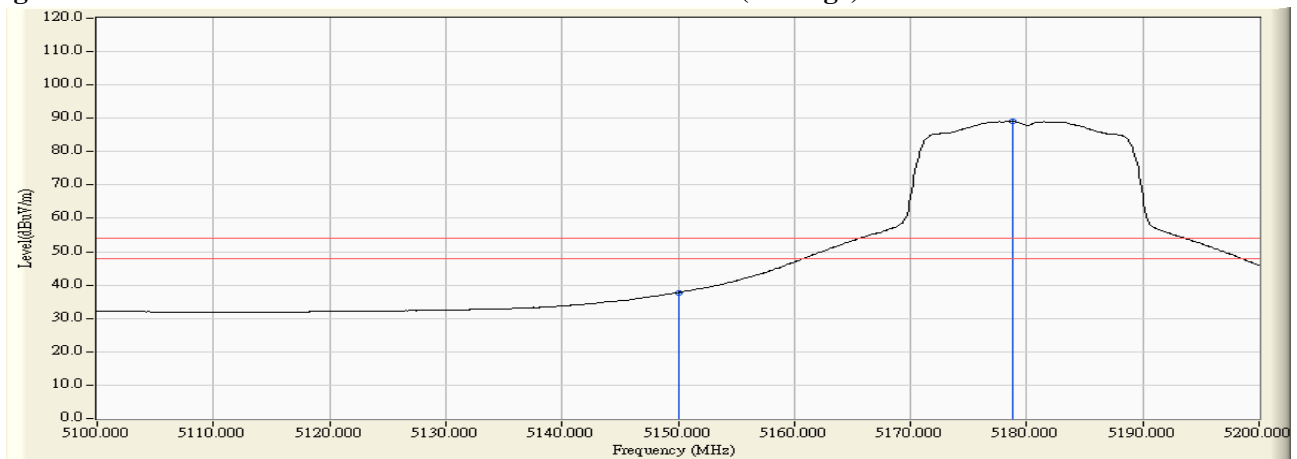

**Note:**

1. All readings above 1GHz are performed with peak and/or average measurements as necessary.
2. Peak measurements: RBW = 1MHz, VBW = 3 MHz, Sweep: Auto.
3. Average measurements: RBW = 1MHz, VBW = 10 Hz, Sweep: Auto.
4. “ \* ”, means this data is the worst emission level.
5. Measurement Level = Reading Level + Correct Factor.
6. The average measurement was not performed when the peak measured data under the limit of average detection.

Product : TABLET PC  
 Test Item : Band Edge Data  
 Test Site : No.3 OATS  
 Test Mode : Mode 2: Transmit (802.11n-20BW 7.2Mbps) -Channel 36

**RF Radiated Measurement (Vertical):**

Channel No.	Frequency (MHz)	Correct Factor (dB)	Reading Level (dB $\mu$ V)	Emission Level (dB $\mu$ V/m)	Peak Limit (dB $\mu$ V/m)	Average Limit (dB $\mu$ V/m)	Result
36 (Peak)	5148.000	10.323	60.461	70.784	74.00	54.00	Pass
36 (Peak)	5150.000	10.324	59.206	69.531	74.00	54.00	Pass
36 (Peak)	5180.000	10.583	100.800	111.383	--	--	--
36 (Average)	5150.000	10.324	40.016	50.341	74.00	54.00	Pass
36 (Average)	5181.400	10.596	90.374	100.970	--	--	--

**Figure Channel 36: Vertical (Peak)**

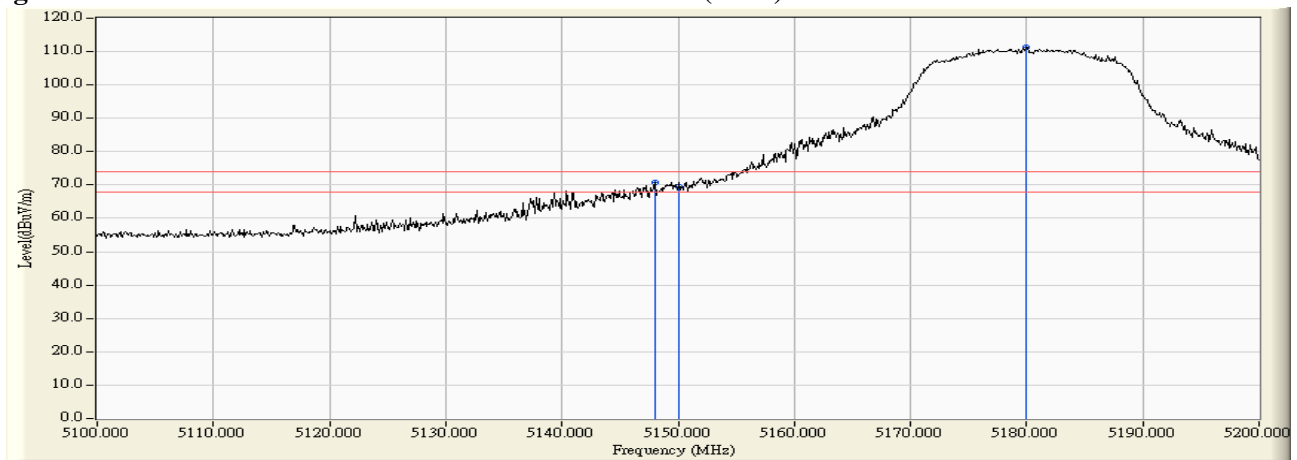

**Figure Channel 36: Vertical (Average)**

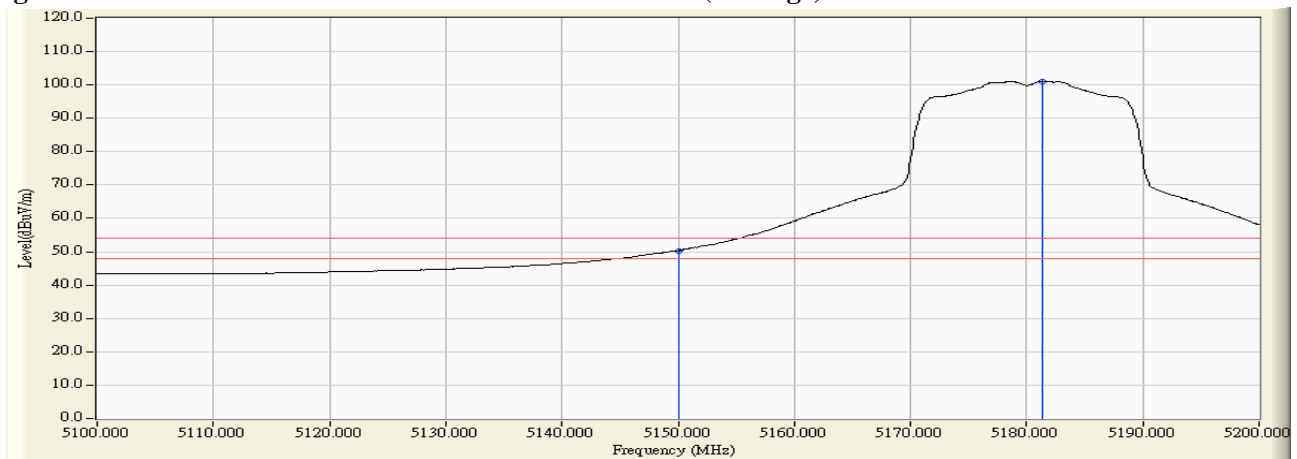

**Note:**

1. All readings above 1GHz are performed with peak and/or average measurements as necessary.
2. Peak measurements: RBW = 1MHz, VBW = 3 MHz, Sweep: Auto.
3. Average measurements: RBW = 1MHz, VBW = 10 Hz, Sweep: Auto.
4. “ \* ”, means this data is the worst emission level.
5. Measurement Level = Reading Level + Correct Factor.
6. The average measurement was not performed when the peak measured data under the limit of average detection.

Product : TABLET PC  
 Test Item : Band Edge Data  
 Test Site : No.3 OATS  
 Test Mode : Mode 2: Transmit (802.11n-20BW 7.2Mbps) -Channel 64

**RF Radiated Measurement (Horizontal):**

Channel No.	Frequency (MHz)	Correct Factor (dB)	Reading Level (dBμV)	Emission Level (dBμV/m)	Peak Limit (dBμV/m)	Average Limit (dBμV/m)	Result
64 (Peak)	5320.300	0.112	99.890	100.002	--	--	--
64 (Peak)	5350.000	0.262	58.796	59.058	74.00	54.00	Pass
64 (Peak)	5351.800	0.273	59.484	59.756	74.00	54.00	Pass
64 (Average)	5321.500	0.127	89.146	89.272	--	--	--
64 (Average)	5350.000	0.262	39.737	39.999	74.00	54.00	Pass

**Figure Channel 64: Horizontal (Peak)**

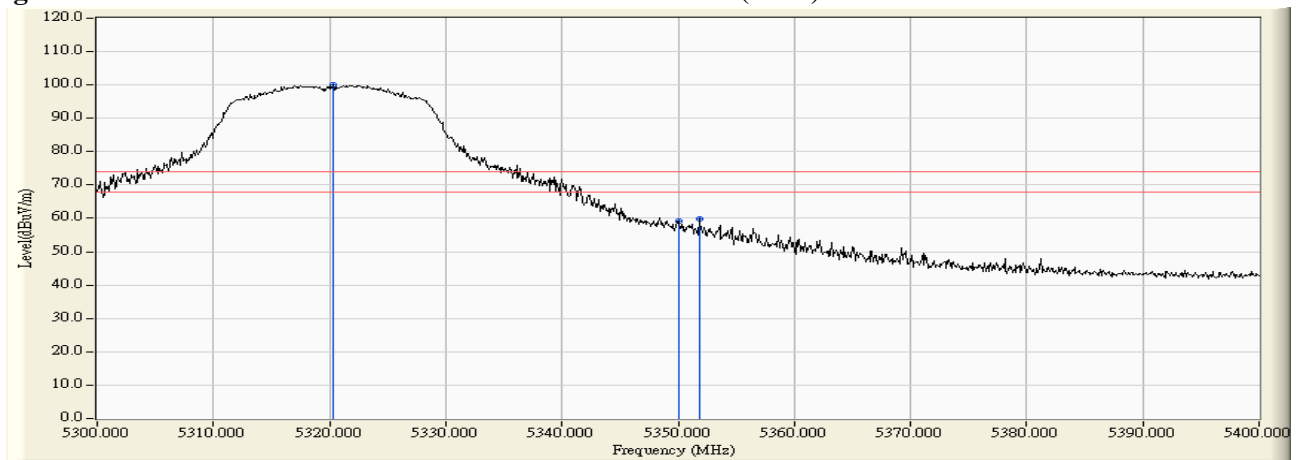

**Figure Channel 64: Horizontal (Average)**

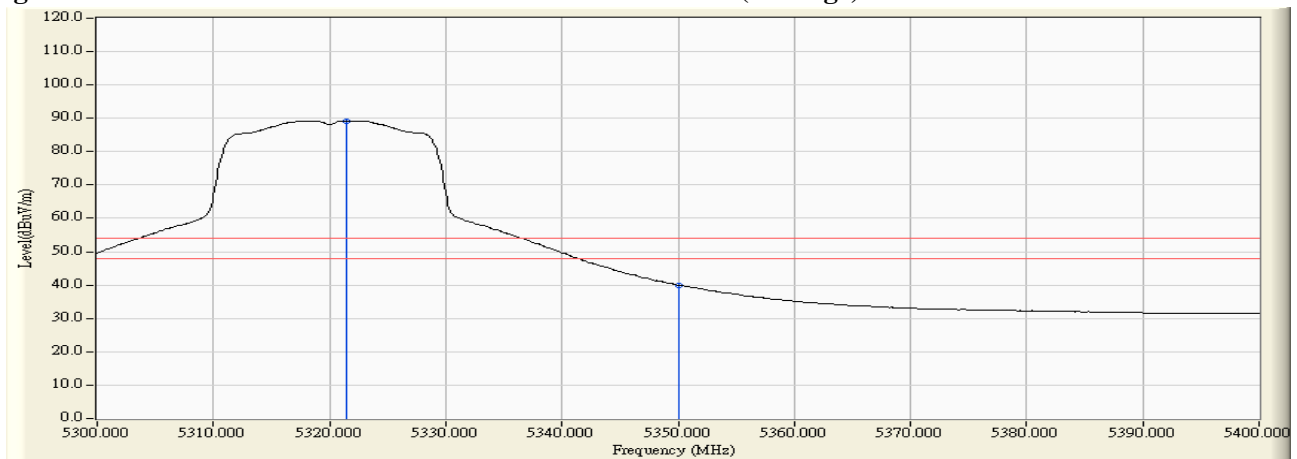

**Note:**

1. All readings above 1GHz are performed with peak and/or average measurements as necessary.
2. Peak measurements: RBW = 1MHz, VBW = 3 MHz, Sweep: Auto.
3. Average measurements: RBW = 1MHz, VBW = 10 Hz, Sweep: Auto.
4. “ \* ”, means this data is the worst emission level.
5. Measurement Level = Reading Level + Correct Factor.
6. The average measurement was not performed when the peak measured data under the limit of average detection.

Product : TABLET PC  
 Test Item : Band Edge Data  
 Test Site : No.3 OATS  
 Test Mode : Mode 2: Transmit (802.11n-20BW 7.2Mbps) -Channel 64

**RF Radiated Measurement (Vertical):**

Channel No.	Frequency (MHz)	Correct Factor (dB)	Reading Level (dBμV)	Emission Level (dBμV/m)	Peak Limit (dBμV/m)	Average Limit (dBμV/m)	Result
64 (Peak)	5319.900	9.863	101.007	110.870	--	--	--
64 (Peak)	5350.000	9.923	60.467	70.391	74.00	54.00	Pass
64 (Peak)	5350.300	9.925	61.938	71.862	74.00	54.00	Pass
64 (Average)	5321.900	9.879	89.553	99.433	--	--	--
64 (Average)	5350.000	9.923	41.397	51.321	74.00	54.00	Pass

**Figure Channel 64: Vertical (Peak)**

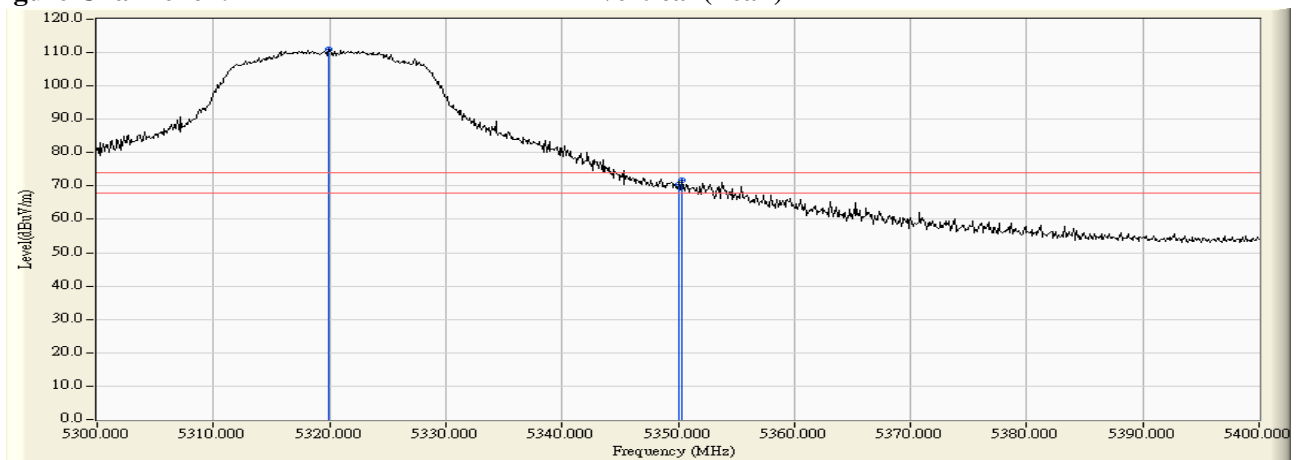

**Figure Channel 64: Vertical (Average)**

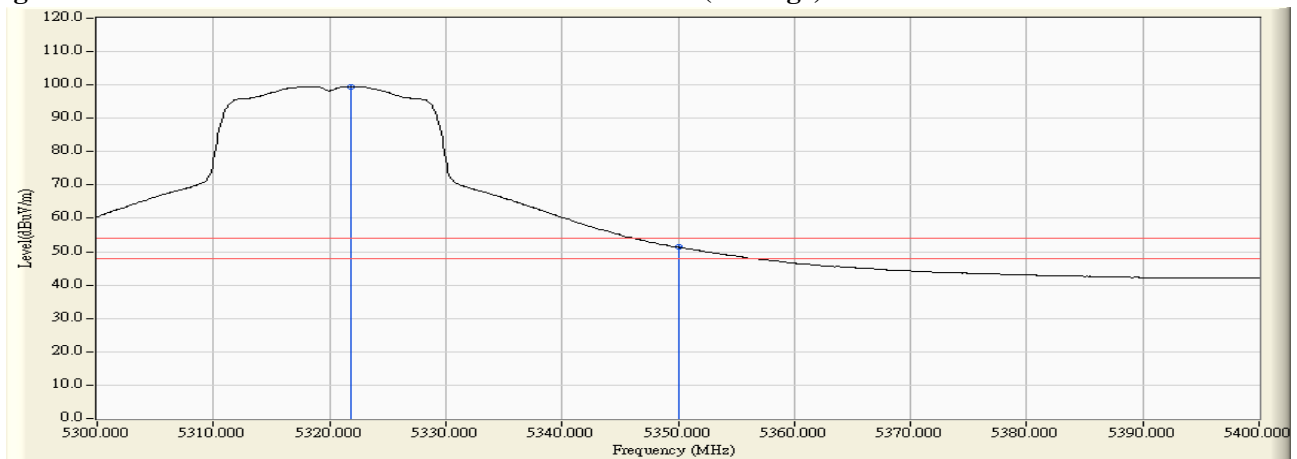

**Note:**

1. All readings above 1GHz are performed with peak and/or average measurements as necessary.
2. Peak measurements: RBW = 1MHz, VBW = 3 MHz, Sweep: Auto.
3. Average measurements: RBW = 1MHz, VBW = 10 Hz, Sweep: Auto.
4. “ \* ”, means this data is the worst emission level.
5. Measurement Level = Reading Level + Correct Factor.
6. The average measurement was not performed when the peak measured data under the limit of average detection.



Product : TABLET PC  
 Test Item : Band Edge Data  
 Test Site : No.3 OATS  
 Test Mode : Mode 2: Transmit (802.11n-20BW 7.2Mbps) -Channel 100

**RF Radiated Measurement (Horizontal):**

Channel No.	Frequency (MHz)	Correct Factor (dB)	Reading Level (dBμV)	Emission Level (dBμV/m)	Peak Limit (dBμV/m)	Average Limit (dBμV/m)	Result
100 (Peak)	5458.900	0.164	55.120	55.284	74.00	54.00	Pass
100 (Peak)	5460.000	0.178	54.771	54.949	74.00	54.00	Pass
100 (Peak)	5500.300	0.582	102.483	103.064	--	--	--
100 (Average)	5460.000	0.178	38.162	38.340	74.00	54.00	Pass
100 (Average)	5502.300	0.602	91.325	91.927	--	--	--

**Figure Channel 100: Horizontal (Peak)**

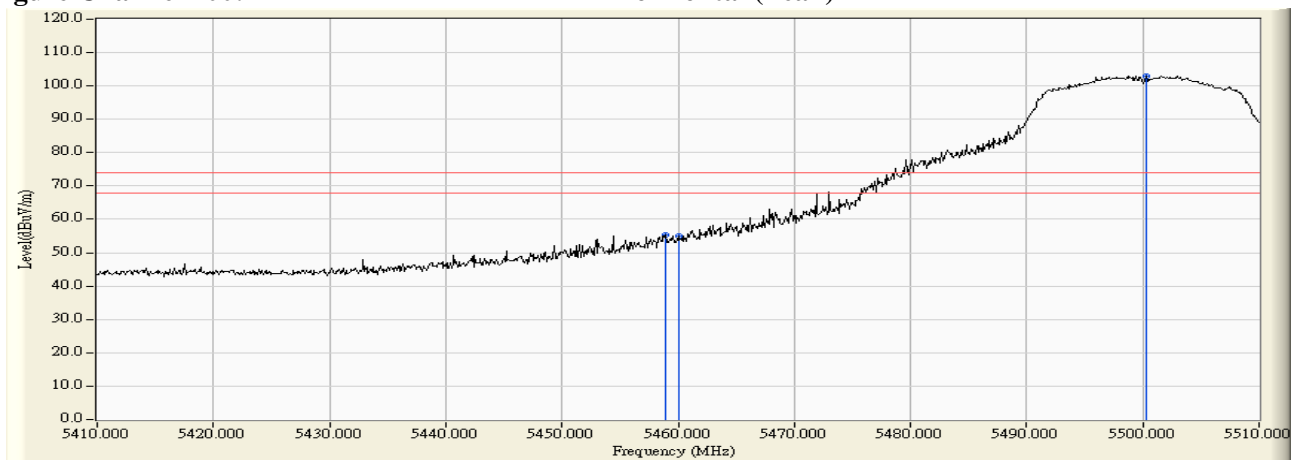

**Figure Channel 100: Horizontal (Average)**

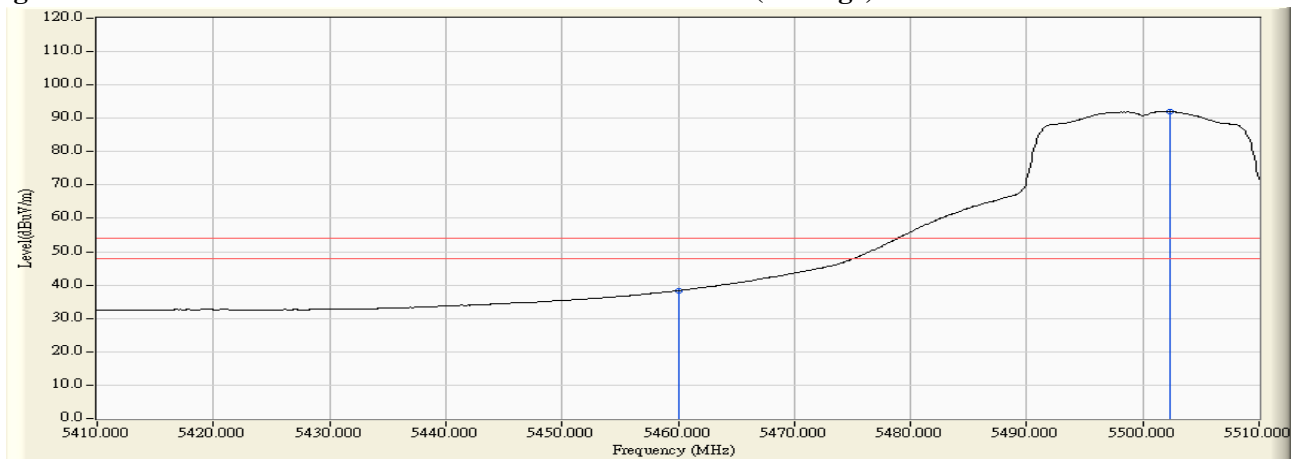

**Note:**

1. All readings above 1GHz are performed with peak and/or average measurements as necessary.
2. Peak measurements: RBW = 1MHz, VBW = 3 MHz, Sweep: Auto.
3. Average measurements: RBW = 1MHz, VBW = 10 Hz, Sweep: Auto.
4. “ \* ”, means this data is the worst emission level.
5. Measurement Level = Reading Level + Correct Factor.
6. The average measurement was not performed when the peak measured data under the limit of average detection.

Product : TABLET PC  
 Test Item : Band Edge Data  
 Test Site : No.3 OATS  
 Test Mode : Mode 2: Transmit (802.11n-20BW 7.2Mbps) -Channel 100

**RF Radiated Measurement (Vertical):**

Channel No.	Frequency (MHz)	Correct Factor (dB)	Reading Level (dBμV)	Emission Level (dBμV/m)	Peak Limit (dBμV/m)	Average Limit (dBμV/m)	Result
100 (Peak)	5459.600	9.492	54.393	63.885	74.00	54.00	Pass
100 (Peak)	5460.000	9.497	52.073	61.569	74.00	54.00	Pass
100 (Peak)	5502.900	9.792	102.008	111.801	--	--	--
100 (Average)	5460.000	9.497	36.935	46.431	74.00	54.00	Pass
100 (Average)	5502.100	9.787	91.077	100.864	--	--	--

**Figure Channel 100: Vertical (Peak)**

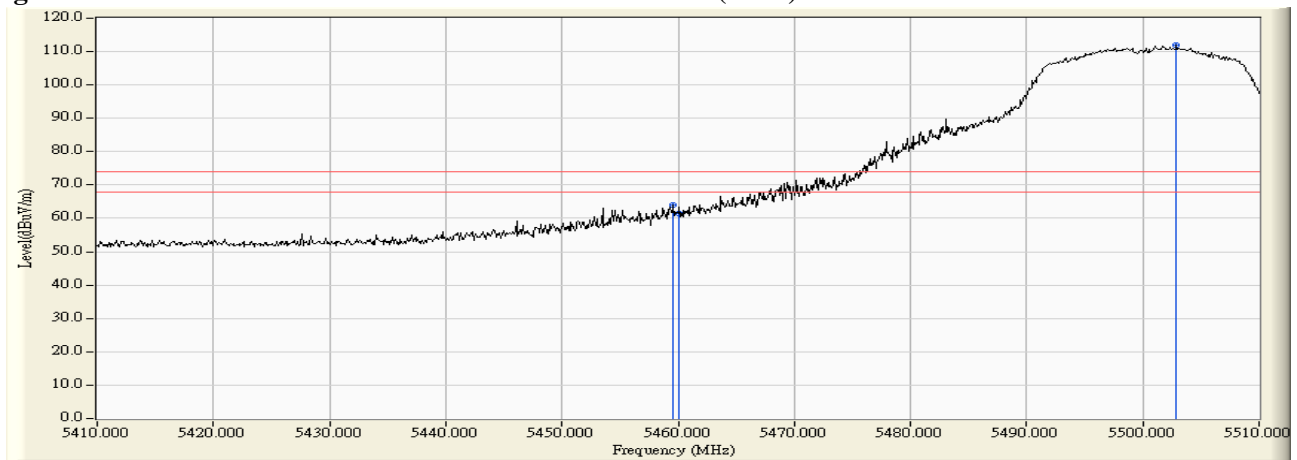

**Figure Channel 100: Vertical (Average)**

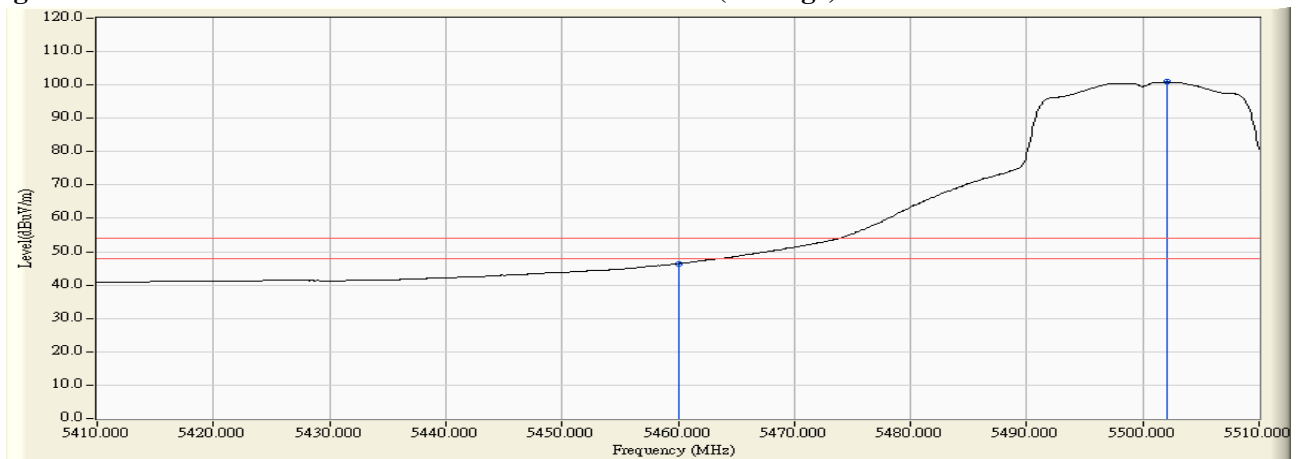

**Note:**

1. All readings above 1GHz are performed with peak and/or average measurements as necessary.
2. Peak measurements: RBW = 1MHz, VBW = 3 MHz, Sweep: Auto.
3. Average measurements: RBW = 1MHz, VBW = 10 Hz, Sweep: Auto.
4. “ \* ”, means this data is the worst emission level.
5. Measurement Level = Reading Level + Correct Factor.
6. The average measurement was not performed when the peak measured data under the limit of average detection.

Product : TABLET PC  
 Test Item : Band Edge Data  
 Test Site : No.3 OATS  
 Test Mode : Mode 2: Transmit (802.11n-20BW 7.2Mbps) -Channel 100

**RF Radiated Measurement:**

	Frequency (MHz)	Correct Factor (dB)	Reading Level (dBm)	Measure Level (dBm/m)	Margin (dB)	Limit (dBm/m)	Result
Horizontal	5466.522	4.442	54.115	58.556	-9.664	68.220	Pass
Horizontal	5470.000	4.488	50.279	54.767	-13.453	68.220	Pass
Horizontal	5498.261	4.802	95.953	100.755	--	--	--

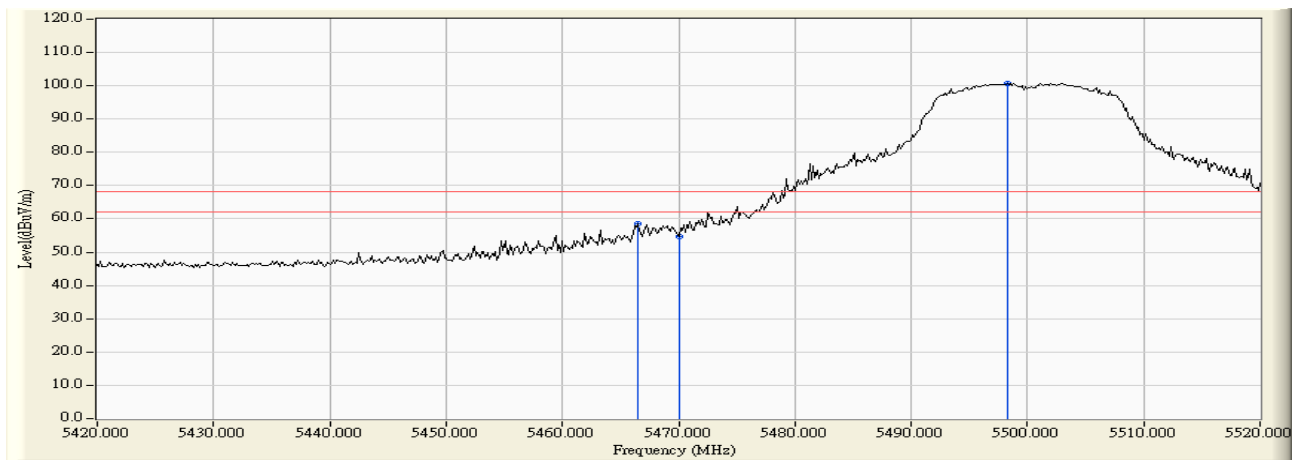

	Frequency (MHz)	Correct Factor (dB)	Reading Level (dBm)	Measure Level (dBm/m)	Margin (dB)	Limit (dBm/m)	Result
Vertical	5468.261	6.099	54.775	60.874	-7.346	68.220	Pass
Vertical	5470.000	6.112	53.930	60.041	-8.179	68.220	Pass
Vertical	5503.043	6.284	96.880	103.164	--	--	--

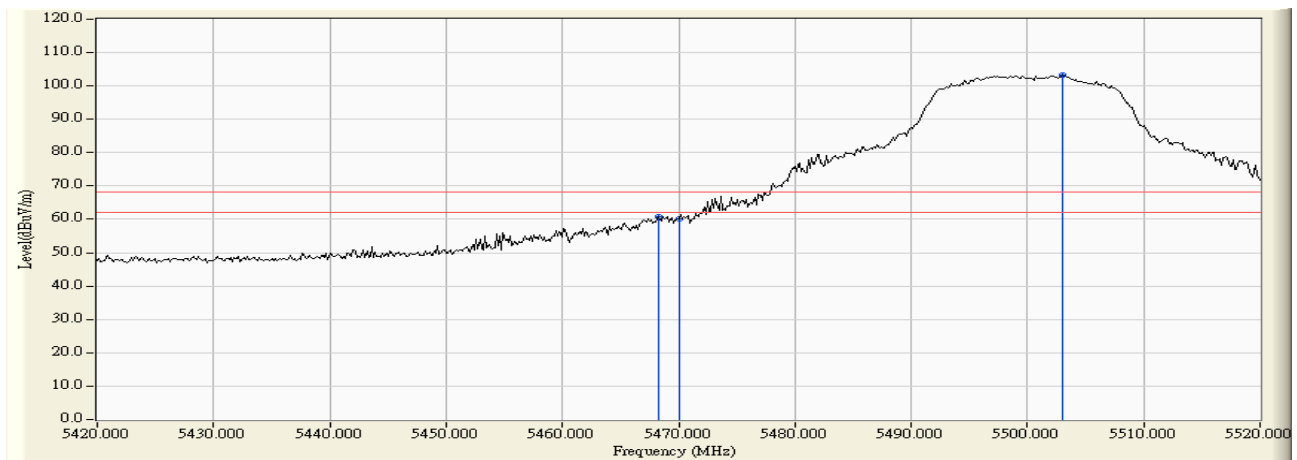

Product : TABLET PC  
 Test Item : Band Edge Data  
 Test Site : No.3 OATS  
 Test Mode : Mode 2: Transmit (802.11n-20BW 7.2Mbps) -Channel 140

**RF Radiated Measurement:**

	Frequency (MHz)	Correct Factor (dB)	Reading Level (dBm)	Measure Level (dBm/m)	Margin (dB)	Limit (dBm/m)	Result
Horizontal	5696.225	4.618	95.410	100.027	31.807	68.220	Pass
Horizontal	5725.000	4.654	58.235	62.889	-5.331	68.220	Pass
Horizontal	5726.378	4.654	60.124	64.779	-3.441	68.220	Pass

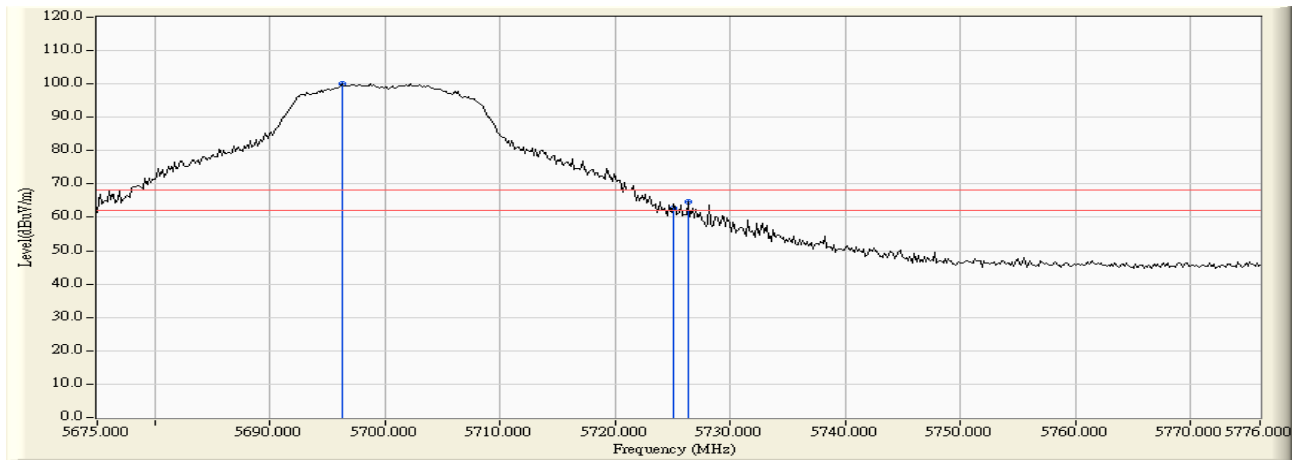

	Frequency (MHz)	Correct Factor (dB)	Reading Level (dBm)	Measure Level (dBm/m)	Margin (dB)	Limit (dBm/m)	Result
Vertical	5697.542	5.979	95.601	101.580	33.360	68.220	Pass
Vertical	5725.000	5.992	58.508	64.501	-3.719	68.220	Pass
Vertical	5726.817	5.993	60.457	66.449	-1.771	68.220	Pass

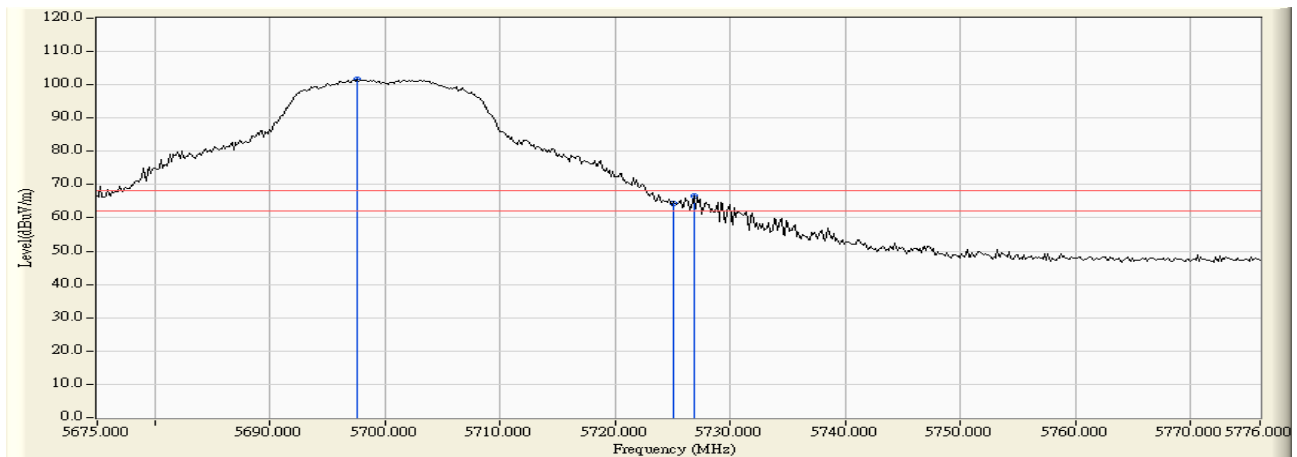

## 7. Occupied Bandwidth

### 7.1. Test Equipment

	Equipment	Manufacturer	Model No./Serial No.	Last Cal.
	Spectrum Analyzer	R&S	FSP40 / 100170	Jun, 2015
	Spectrum Analyzer	Agilent	E4407B / US39440758	Jun, 2015
X	Spectrum Analyzer	Agilent	N9010A / MY48030495	Apr., 2015

Note:

1. All equipments are calibrated with traceable calibrations. Each calibration is traceable to the national or international standards.
2. The test instruments marked with “X” are used to measure the final test results.

### 7.2. Test Setup

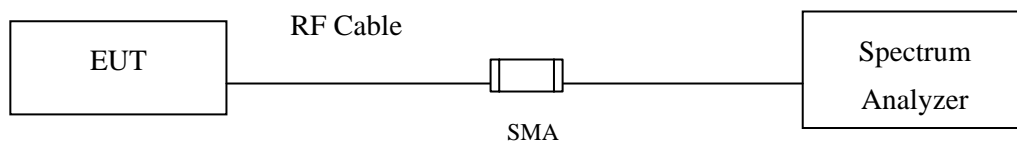

### 7.3. Limits

For the 5.725-5.85 GHz band, the minimum 6 dB bandwidth of U-NII devices shall be at least 500 kHz

### 7.4. Test Procedure

The EUT was setup to ANSI C63.10, 2013; tested to UNII test procedure of FCC KDB-789033 for compliance to FCC 47CFR Subpart E requirements.

### 7.5. Uncertainty

± 150Hz

### 7.6. Test Result of Occupied Bandwidth

Product : TABLET PC  
 Test Item : Occupied Bandwidth Data  
 Test Site : No.3 OATS  
 Test Mode : Mode 1: Transmit (802.11a-6Mbps) (5745MHz)

Channel No.	Frequency (MHz)	Measurement Level (kHz)	Required Limit (kHz)	Result
149	5745.00	12900	>500	Pass

**Figure Channel 149:**

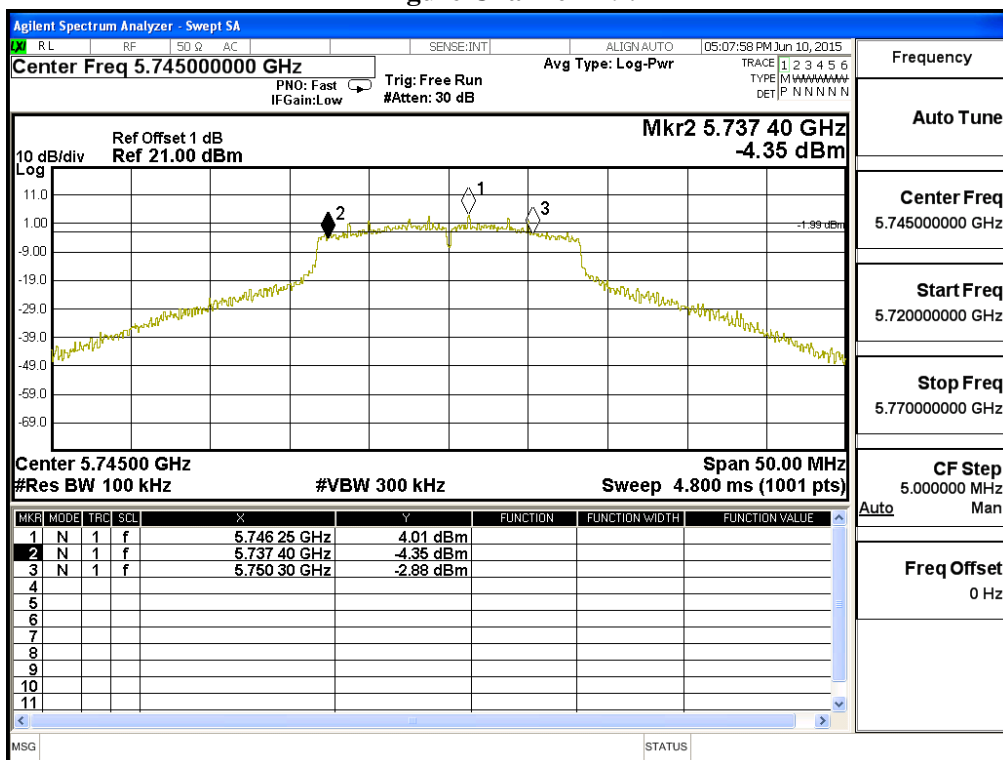

Product : TABLET PC  
 Test Item : Occupied Bandwidth Data  
 Test Site : No.3 OATS  
 Test Mode : Mode 1: Transmit (802.11a-6Mbps) (5785MHz)

Channel No.	Frequency (MHz)	Measurement Level (kHz)	Required Limit (kHz)	Result
157	5785.00	15200	>500	Pass

**Figure Channel 157:**

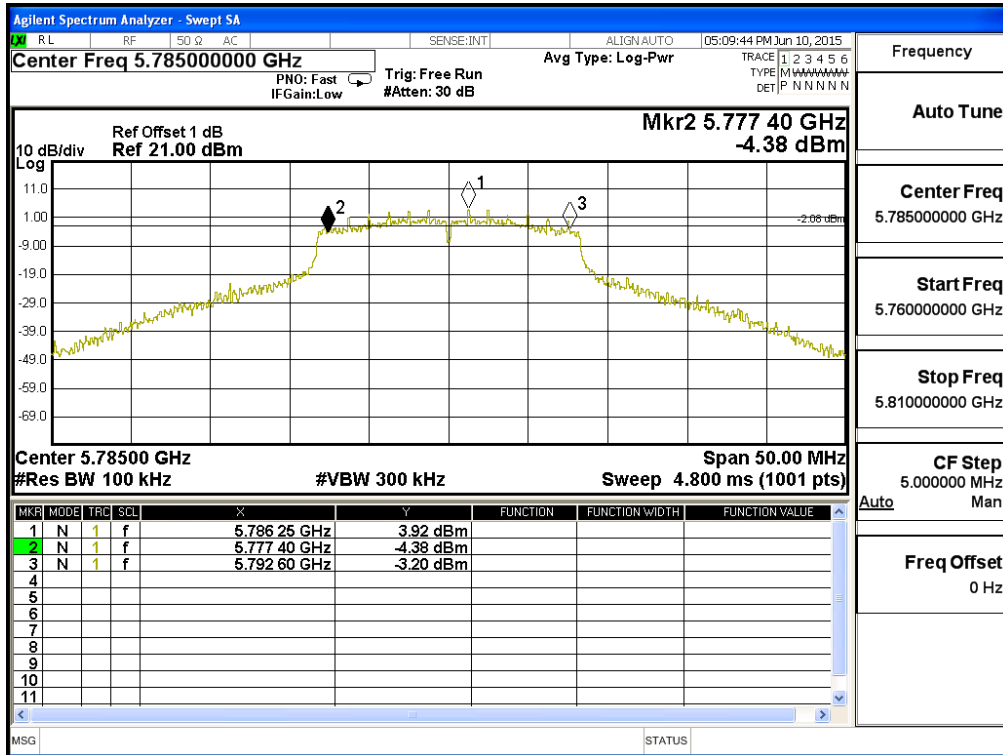

Product : TABLET PC  
 Test Item : Occupied Bandwidth Data  
 Test Site : No.3 OATS  
 Test Mode : Mode 1: Transmit (802.11a-6Mbps) (5825MHz)

Channel No.	Frequency (MHz)	Measurement Level (kHz)	Required Limit (kHz)	Result
165	5825.00	15200	>500	Pass

**Figure Channel 165:**

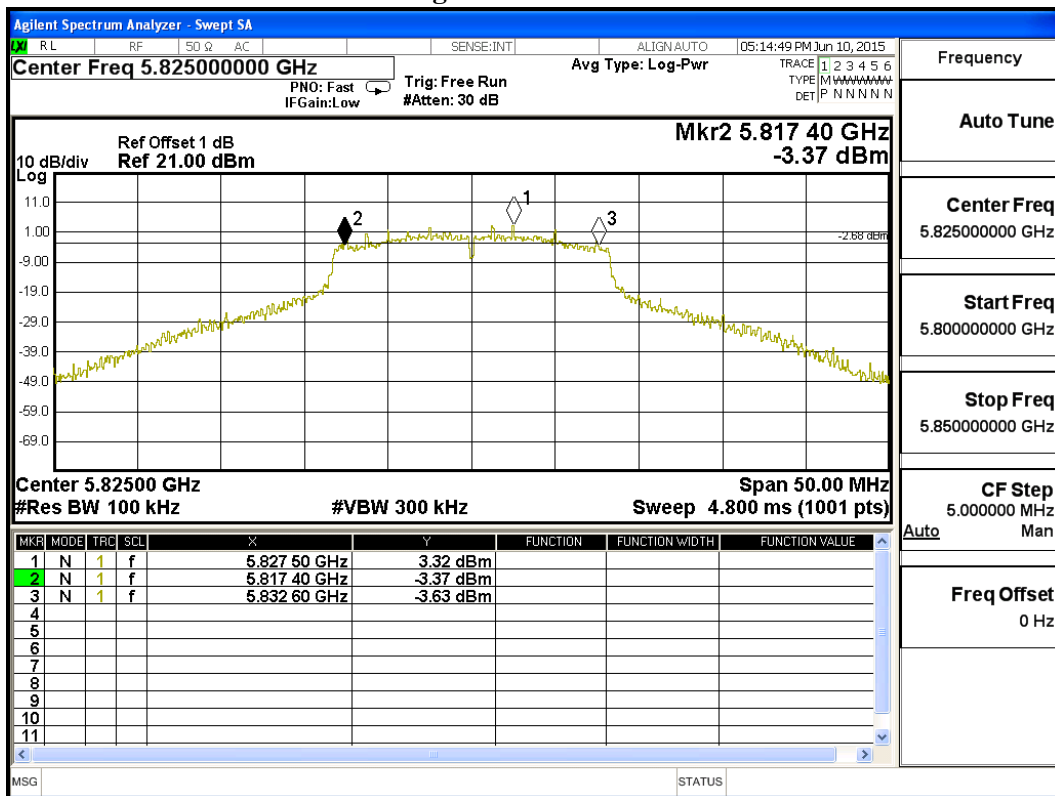



Product : TABLET PC  
 Test Item : Occupied Bandwidth Data  
 Test Site : No.3 OATS  
 Test Mode : Mode 2: Transmit (802.11n-20BW 7.2Mbps) (5745MHz)

Channel No.	Frequency (MHz)	Measurement Level (kHz)	Required Limit (kHz)	Result
149	5745.00	15200	>500	Pass

**Figure Channel 149:**

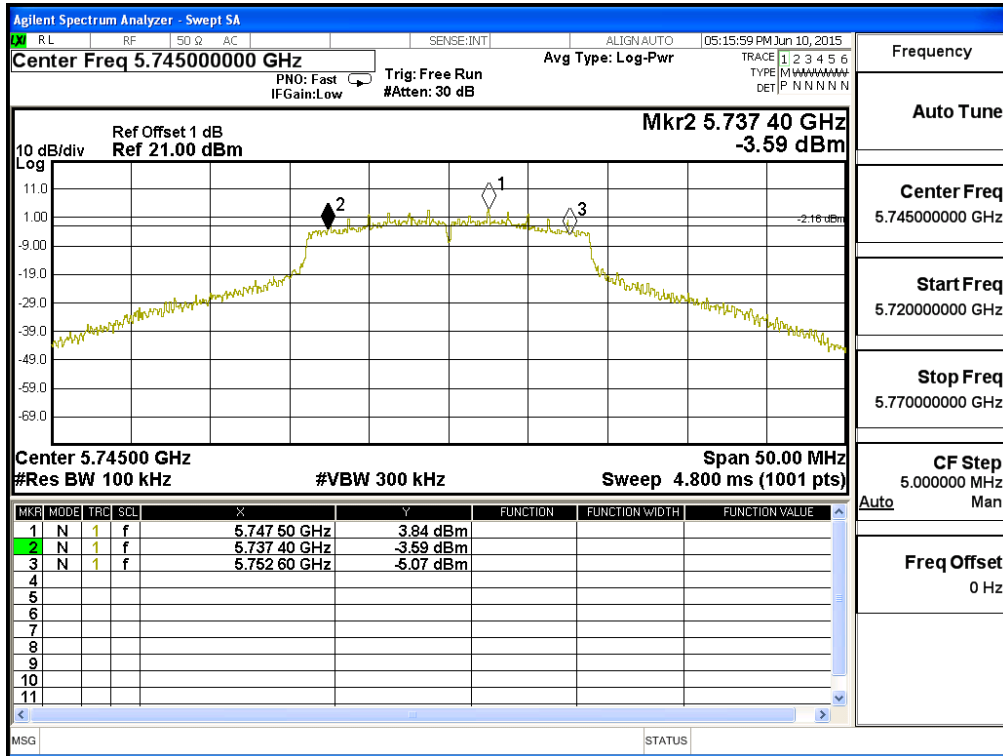

Product : TABLET PC  
 Test Item : Occupied Bandwidth Data  
 Test Site : No.3 OATS  
 Test Mode : Mode 2: Transmit (802.11n-20BW 7.2Mbps) (5785MHz)

Channel No.	Frequency (MHz)	Measurement Level (kHz)	Required Limit (kHz)	Result
157	5785.00	13850	>500	Pass

**Figure Channel 157:**

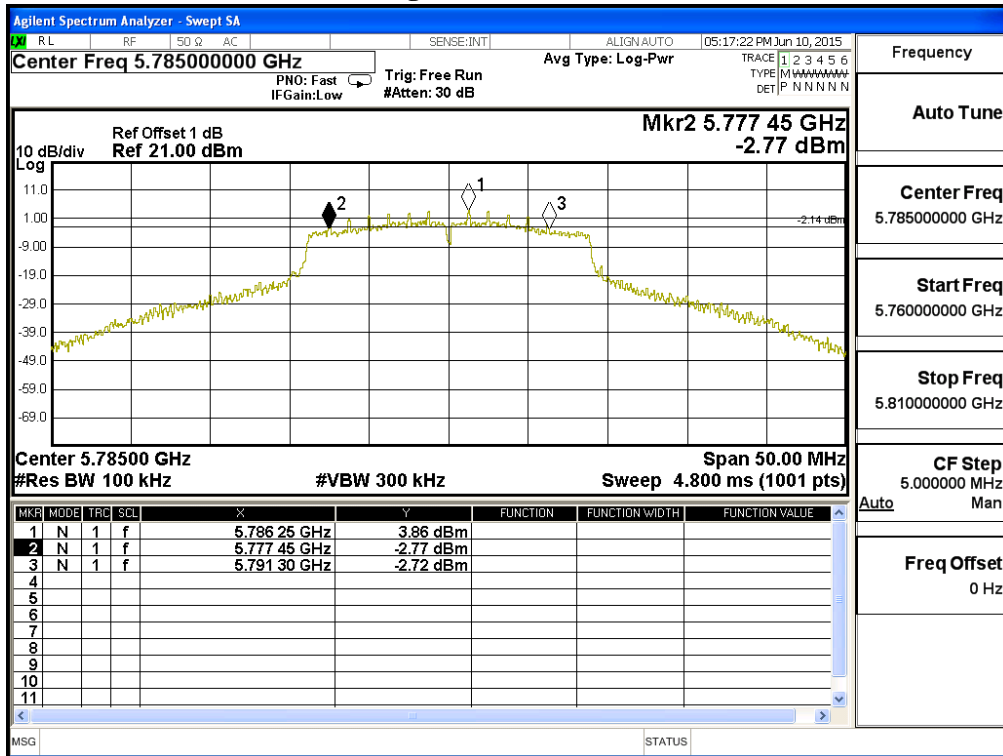

Product : TABLET PC  
 Test Item : Occupied Bandwidth Data  
 Test Site : No.3 OATS  
 Test Mode : Mode 2: Transmit (802.11n-20BW 7.2Mbps) (5825MHz)

Channel No.	Frequency (MHz)	Measurement Level (kHz)	Required Limit (kHz)	Result
165	5825.00	15150	>500	Pass

**Figure Channel 165:**

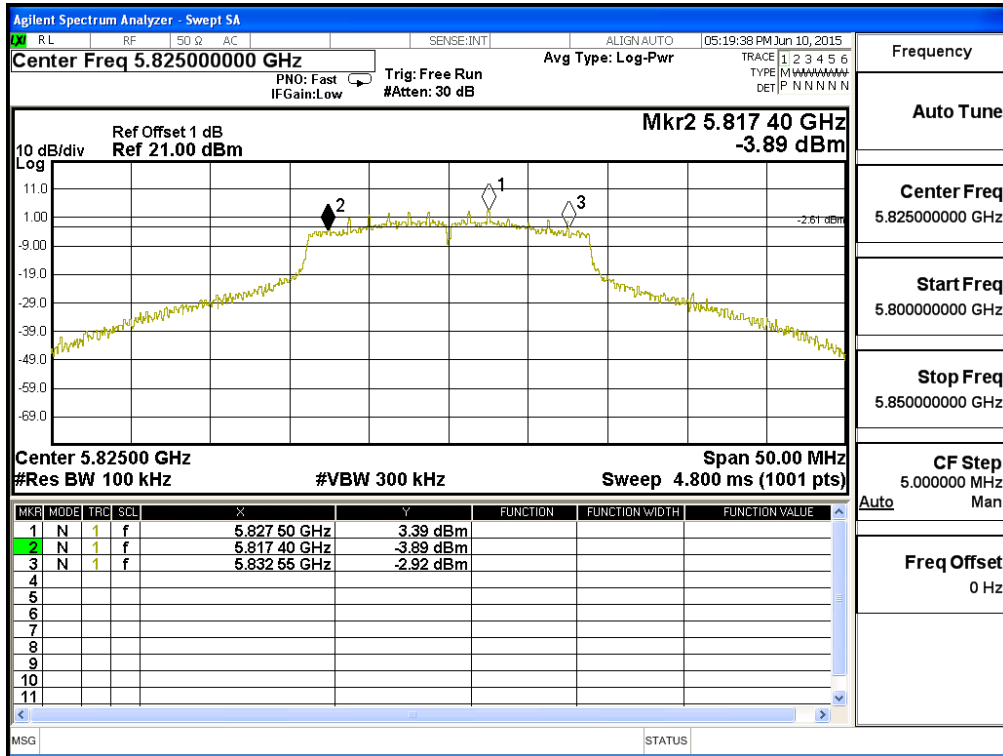

## 8. Frequency Stability

### 8.1. Test Equipment

	Equipment	Manufacturer	Model No./Serial No.	Last Cal.
	Spectrum Analyzer	R&S	FSP40 / 100170	Jun., 2015
	Spectrum Analyzer	Agilent	E4407B / US39440758	Jun., 2015
X	Spectrum Analyzer	Agilent	N9010A / MY48030495	Apr., 2015

Note:

1. All equipments are calibrated with traceable calibrations. Each calibration is traceable to the national or international standards.
2. The test instruments marked with “X” are used to measure the final test results.

### 8.2. Test Setup

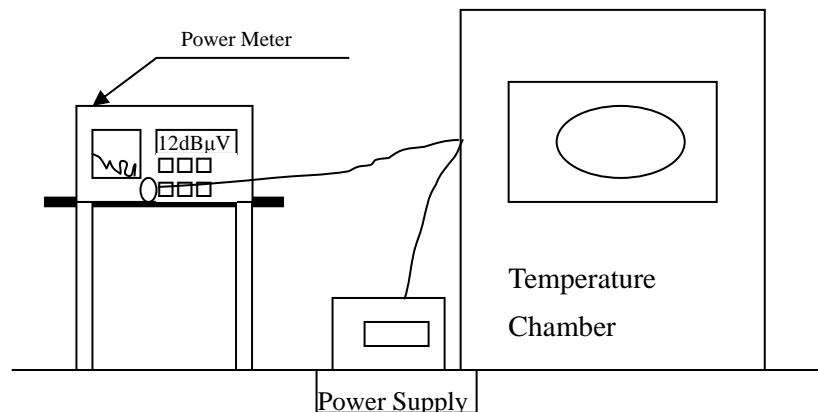

### 8.3. Limits

Manufacturers of U-NII devices are responsible for ensuring frequency stability such that an emission is maintained within the band of operation under all conditions of normal operation as specified

### 8.4. Test Procedure

The EUT was setup to ANSI C63.10, 2013; tested to UNII test procedure of FCC KDB-789033 for compliance to FCC 47CFR Subpart E requirements.

### 8.5. Uncertainty

± 150 Hz

**8.6. Test Result of Frequency Stability**

Product : TABLET PC  
 Test Item : Frequency Stability  
 Test Site : Temperature Chamber  
 Test Mode : Carrier Wave

Test Conditions		Channel	Frequency (MHz)	Frequency (MHz)	$\Delta F$ (MHz)
Tnom (20) oC	Vnom (120)V	36	5180.0000	5180.0047	-0.0047
		44	5220.0000	5220.0061	-0.0061
		48	5240.0000	5240.0077	-0.0077
		52	5260.0000	5260.0075	-0.0075
		60	5300.0000	5300.0048	-0.0048
		64	5320.0000	5320.0064	-0.0064
		100	5500.0000	5500.0067	-0.0067
		116	5580.0000	5580.0039	-0.0039
		140	5700.0000	5700.0041	-0.0041
		149	5745.0000	5745.0065	-0.0065
		157	5785.0000	5785.0059	-0.0059
		165	5825.0000	5825.0057	-0.0057
Test Conditions		Channel	Frequency (MHz)	Frequency (MHz)	$\Delta F$ (MHz)
Tmax (50) oC	Vmax (138)V	36	5180.0000	5180.0094	-0.0094
		44	5220.0000	5220.0104	-0.0104
		48	5240.0000	5240.0081	-0.0081
		52	5260.0000	5260.0087	-0.0087
		60	5300.0000	5300.0081	-0.0081
		64	5320.0000	5320.0086	-0.0086
		100	5500.0000	5500.0089	-0.0089
		116	5580.0000	5580.0115	-0.0115
		140	5700.0000	5700.0098	-0.0098
		149	5745.0000	5745.0117	-0.0117
		157	5785.0000	5785.0096	-0.0096
		165	5825.0000	5825.0087	-0.0087

Test Conditions		Channel	Frequency (MHz)	Frequency (MHz)	$\Delta F$ (MHz)
Tmax (50) °C	Vmin (102)V	36	5180.0000	5180.0094	-0.0094
		44	5220.0000	5220.0104	-0.0104
		48	5240.0000	5240.0081	-0.0081
		52	5260.0000	5260.0087	-0.0087
		60	5300.0000	5300.0081	-0.0081
		64	5320.0000	5320.0086	-0.0086
		100	5500.0000	5500.0089	-0.0089
		116	5580.0000	5580.0115	-0.0115
		140	5700.0000	5700.0098	-0.0098
		149	5745.0000	5745.0117	-0.0117
		157	5785.0000	5785.0096	-0.0096
		165	5825.0000	5825.0087	-0.0087
Test Conditions		Channel	Frequency (MHz)	Frequency (MHz)	$\Delta F$ (MHz)
Tnom (-20) oC	Vnom (138)V	36	5180.0000	5180.0029	-0.0029
		44	5220.0000	5220.0023	-0.0023
		48	5240.0000	5240.0016	-0.0016
		52	5260.0000	5260.0027	-0.0027
		60	5300.0000	5300.0016	-0.0016
		64	5320.0000	5320.0027	-0.0027
		100	5500.0000	5500.0029	-0.0029
		116	5580.0000	5580.0037	-0.0037
		140	5700.0000	5700.0025	-0.0025
		149	5745.0000	5745.0041	-0.0041
		157	5785.0000	5785.0029	-0.0029
		165	5825.0000	5825.0034	-0.0034

Test Conditions		Channel	Frequency (MHz)	Frequency (MHz)	$\Delta F$ (MHz)
Tmax (-20) oC	Vmax (102)V	36	5180.0000	5180.0029	-0.0029
		44	5220.0000	5220.0023	-0.0023
		48	5240.0000	5240.0016	-0.0016
		52	5260.0000	5260.0027	-0.0027
		60	5300.0000	5300.0016	-0.0016
		64	5320.0000	5320.0027	-0.0027
		100	5500.0000	5500.0029	-0.0029
		116	5580.0000	5580.0037	-0.0037
		140	5700.0000	5700.0025	-0.0025
		149	5745.0000	5745.0041	-0.0041
		157	5785.0000	5785.0029	-0.0029
		165	5825.0000	5825.0034	-0.0034

**9. EMI Reduction Method During Compliance Testing**

No modification was made during testing.