

FCC Test Report

Product Name	TABLET PC
Model No.	PA-501
FCC ID.	2ABTU-PA-501

Applicant	RuggON Corporation
Address	3F., No.10, Ln. 181, Sec. 2, Jiuzong Rd., Neihu Dist., Taipei City , Taiwan

Date of Receipt	Apr. 10, 2015
Issued Date	Jul. 08, 2015
Report No.	1540249R-RFUSP26V00-A
Report Version	V1.0



The test results relate only to the samples tested.

The test results shown in the test report are traceable to the national/international standard through the calibration report of the equipment and evaluated measurement uncertainty herein.

This report must not be used to claim product endorsement by TAF or any agency of the government.

The test report shall not be reproduced without the written approval of QuieTek Corporation.

Test Report

Issued Date: Jul. 08, 2015

Report No.: 1540249R-RFUSP26V00-A



Product Name	TABLET PC
Applicant	RuggON Corporation
Address	3F., No.10, Ln. 181, Sec. 2, Jiuzong Rd., Neihu Dist., Taipei City , Taiwan
Manufacturer	Ubiqconn Technology,Inc.
Model No.	PA-501
FCC ID.	2ABTU-PA-501
EUT Rated Voltage	AC 100-240V, 50-60Hz
EUT Test Voltage	AC 120V/60Hz
Trade Name	RuggON
Applicable Standard	FCC CFR Title 47 Part 15 Subpart C: 2014 ANSI C63.4: 2014, ANSI C63.10: 2013 KDB 558074 D01 DTS Meas Guidance v03r02
Test Result	Complied

Documented By : Jinn Chen
(Senior Adm. Specialist / Jinn Chen)

Tested By : Eason chen
(Engineer / Eason Chen)

Approved By : [Signature]
(Director / Vincent Lin)

TABLE OF CONTENTS

Description	Page
1. GENERAL INFORMATION	4
1.1. EUT Description.....	4
1.2. Operational Description.....	6
1.3. Tested System Details.....	7
1.4. Configuration of Tested System	7
1.5. EUT Exercise Software	7
1.6. Test Facility	8
2. CONDUCTED EMISSION	9
2.1. Test Equipment	9
2.2. Test Setup	9
2.3. Limits.....	10
2.4. Test Procedure	10
2.5. Uncertainty	10
2.6. Test Result of Conducted Emission.....	11
3. PEAK POWER OUTPUT	13
3.1. Test Equipment	13
3.2. Test Setup	13
3.3. Limit	13
3.4. Test Procedure	13
3.5. Uncertainty	13
3.6. Test Result of Peak Power Output	14
4. RADIATED EMISSION	15
4.1. Test Equipment	15
4.2. Test Setup	15
4.3. Limits.....	16
4.4. Test Procedure	17
4.5. Uncertainty	17
4.6. Test Result of Radiated Emission.....	18
5. RF ANTENNA CONDUCTED TEST	22
5.1. Test Equipment	22
5.2. Test Setup	22
5.3. Limits.....	22
5.4. Test Procedure	22
5.5. Uncertainty	22
5.6. Test Result of RF Antenna Conducted Test	23
6. BAND EDGE	24
6.1. Test Equipment	24
6.2. Test Setup	24
6.3. Limit	25
6.4. Test Procedure	25
6.5. Uncertainty	25
6.6. Test Result of Band Edge	26
7. OCCUPIED BANDWIDTH (6DB BW).....	30
7.1. Test Equipment	30
7.2. Test Setup	30
7.3. Limits.....	30
7.4. Test Procedure	30
7.5. Uncertainty	30
7.6. Test Result of Occupied Bandwidth	31
8. POWER DENSITY	34
8.1. Test Equipment	34
8.2. Test Setup	34
8.3. Limits.....	34
8.4. Test Procedure	34
8.5. Uncertainty	34
8.6. Test Result of Power Density	35
9. EMI REDUCTION METHOD DURING COMPLIANCE TESTING	38
Attachment 1: EUT Test Photographs	
Attachment 2: EUT Detailed Photographs	

1. GENERAL INFORMATION

1.1. EUT Description

Product Name	TABLET PC
Trade Name	RuggON
Model No.	PA-501
FCC ID.	2ABTU-PA-501
Frequency Range	2402 – 2480MHz
Channel Number	V4.0: 40CH
Type of Modulation	V4.0: GFSK(1Mbps)
Antenna Type	PIFA Antenna
Channel Control	Auto
Antenna Gain	Refer to the table “Antenna List”
Power Adapter	MFR: FSP, M/N: FSP065-REB Input: 100-240V~1.5A, 50-60Hz Output: 19V $\overline{=}$ 3.42A Cable Out: Non-shielded, 1.8m

Antenna List

No.	Manufacturer	Part No.	Antenna Type	Peak Gain
1	Ethertronics Inc.	5001791 (Main) 5001799 (Aux)	PIFA	3.8dBi for 2.4 GHz

Note: The antenna of EUT is conforming to FCC 15.203.

Center Frequency of Each Channel: (For V4.0)

Channel	Frequency	Channel	Frequency	Channel	Frequency	Channel	Frequency
Channel 00:	2402 MHz	Channel 01:	2404 MHz	Channel 02:	2406 MHz	Channel 03:	2408 MHz
Channel 04:	2410 MHz	Channel 05:	2412 MHz	Channel 06:	2414 MHz	Channel 07:	2416 MHz
Channel 08:	2418 MHz	Channel 09:	2420 MHz	Channel 10:	2422 MHz	Channel 11:	2424 MHz
Channel 12:	2426 MHz	Channel 13:	2428 MHz	Channel 14:	2430 MHz	Channel 15:	2432 MHz
Channel 16:	2434 MHz	Channel 17:	2436 MHz	Channel 18:	2438 MHz	Channel 19:	2440 MHz
Channel 20:	2442 MHz	Channel 21:	2444 MHz	Channel 22:	2446 MHz	Channel 23:	2448 MHz
Channel 24:	2450 MHz	Channel 25:	2452 MHz	Channel 26:	2454 MHz	Channel 27:	2456 MHz
Channel 28:	2458 MHz	Channel 29:	2460 MHz	Channel 30:	2462 MHz	Channel 31:	2464 MHz
Channel 32:	2466 MHz	Channel 33:	2468 MHz	Channel 34:	2470 MHz	Channel 35:	2472 MHz
Channel 36:	2474 MHz	Channel 37:	2476 MHz	Channel 38:	2478 MHz	Channel 39:	2480 MHz

Note:

1. The EUT is a TABLET PC with a built-in Bluetooth V4.0 transceiver.
2. These tests were conducted on a sample for the purpose of demonstrating compliance of Bluetooth transmitter with Part 15 Subpart C Paragraph 15.247 for spread spectrum devices.
3. Regarding to the operation frequency, the lowest, middle and highest frequency are selected to perform the test.
4. The radiation measurements are performed in X, Y, Z axis positioning. Only the worst case is shown in the report.

Test Mode	Mode 1: Transmit - BLE (GFSK)
-----------	-------------------------------

1.3. Tested System Details

The types for all equipment, plus descriptions of all cables used in the tested system (including inserted cards) are:

	Product	Manufacturer	Model No.	Serial No.	Power Cord
(1)	Notebook PC	DELL	PPT	N/A	Non-Shielded, 0.8m
(2)	Monitor	DELL	ST2320L	N/A	N/A
(3)	FLASH	Transcend	JetFlash110	155422-2931	Non-Shielded, 1.8m
(4)	Earphone	AIWA	N/A	N/A	N/A

Signal Cable Type	Signal cable Description
A RS-232 Cable	Shielded, 1.8m
B HDMI Cable	Shielded, 1.8m
C Earphone Cable	Non-Shielded, 1.8m
D Micro USB Cable	Shielded, 0.6m
E RJ45 Cable	Non-Shielded, 2.0m

1.4. Configuration of Tested System

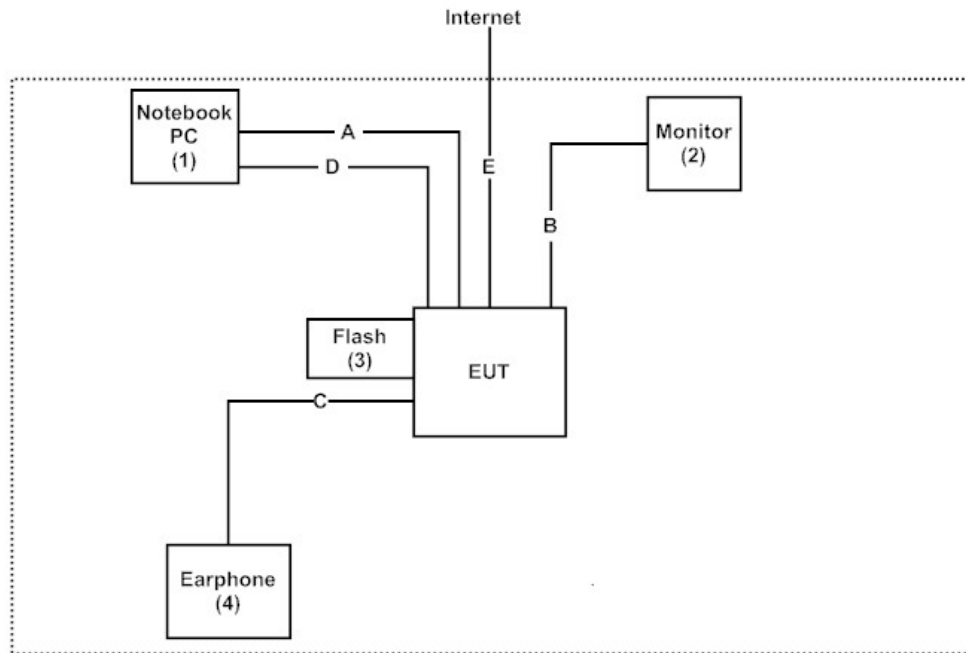

1.5. EUT Exercise Software

- 1 Setup the EUT as shown in Section 1.4.
- 2 Execute software “Terminal Euulator V1.0.45” on the Notebook PC.
- 3 Configure the test mode, the test channel, and the data rate.
- 4 Press “OK” to start the continuous Transmit.
- 5 Verify that the EUT works properly.

1.6. Test Facility

Ambient conditions in the laboratory:

Items	Required (IEC 68-1)	Actual
Temperature (°C)	15-35	20-35
Humidity (%RH)	25-75	30-65
Barometric pressure (mbar)	860-1060	950-1000

The related certificate for our laboratories about the test site and management system can be downloaded from

QuieTek Corporation's Web Site: <http://www.quietek.com/chinese/about/certificates.aspx?bval=5>

The address and introduction of Quietek Corporation's laboratories can be founded in our Web site:
<http://www.quietek.com/>

Site Description: File on
 Federal Communications Commission
 FCC Engineering Laboratory
 7435 Oakland Mills Road
 Columbia, MD 21046
 Registration Number: 92195

Site Name: Quietek Corporation
 Site Address: No.5-22, Ruishukeng,
 Linkou Dist. New Taipei City 24451,
 Taiwan, R.O.C.
 TEL: 886-2-8601-3788 / FAX : 886-2-8601-3789
 E-Mail : service@quietek.com

FCC Accreditation Number: TW1014

2. Conducted Emission

2.1. Test Equipment

	Equipment	Manufacturer	Model No. / Serial No.	Last Cal.	Remark
X	Test Receiver	R & S	ESCS 30 / 825442/018	Sep., 2014	
X	Artificial Mains Network	R & S	ENV4200 / 848411/10	Feb., 2015	Peripherals
X	LISN	R & S	ESH3-Z5 / 825562/002	Feb., 2015	EUT
	DC LISN	Schwarzbeck	8226 / 176	Mar., 2015	EUT
X	Pulse Limiter	R & S	ESH3-Z2 / 357.8810.52	Feb., 2015	
	No.1 Shielded Room				

Note:

1. All equipments are calibrated every one year.
2. The test instruments marked by "X" are used to measure the final test results.

2.2. Test Setup

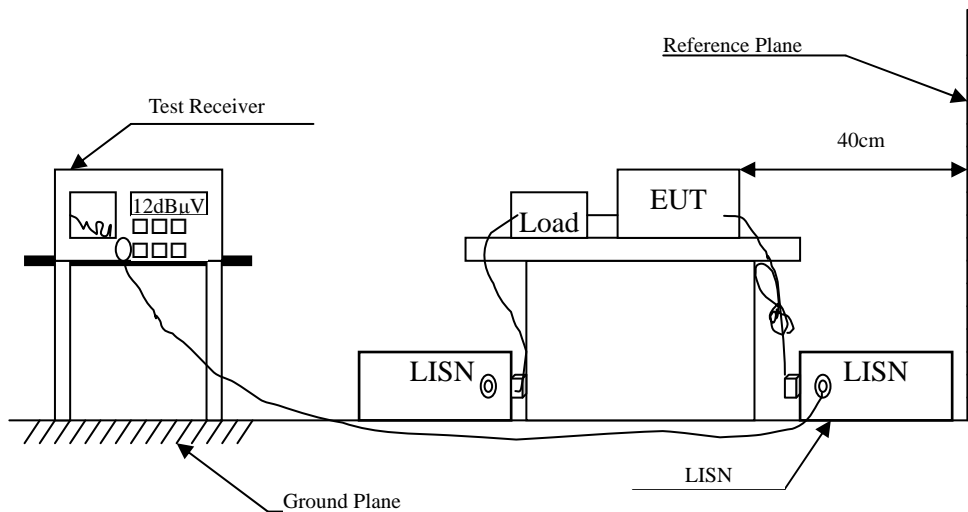

2.3. Limits

FCC Part 15 Subpart C Paragraph 15.207 (dBμV) Limit		
Frequency MHz	Limits	
	QP	AV
0.15 - 0.50	66-56	56-46
0.50-5.0	56	46
5.0 - 30	60	50

Remarks: In the above table, the tighter limit applies at the band edges.

2.4. Test Procedure

The EUT and Peripherals are connected to the main power through a line impedance stabilization network (L.I.S.N.). This provides a 50 ohm /50uH coupling impedance for the measuring equipment. The peripheral devices are also connected to the main power through a LISN that provides a 50ohm /50uH coupling impedance with 50ohm termination. (Please refer to the block diagram of the test setup and photographs.)

Both sides of A.C. line are checked for maximum conducted interference. In order to find the maximum emission, the relative positions of equipment and all the interface cables must be changed according to ANSI C63.4: 2014 on conducted measurement.

Conducted emissions were investigated over the frequency range from 0.15MHz to 30MHz using a receiver bandwidth of 9kHz.

The EUT was setup to ANSI C63.4: 2014; tested to FHSS test procedure of FCC Public Notice DA 00-705 for compliance to FCC 47CFR 15.247 requirements.

2.5. Uncertainty

± 2.26 dB

2.6. Test Result of Conducted Emission

Product : TABLET PC
 Test Item : Conducted Emission Test
 Power Line : Line 1
 Test Mode : Mode 1: Transmit - BLE (GFSK) (2442MHz)

Frequency MHz	Correct Factor dB	Reading Level dBuV	Measurement Level dBuV	Margin dB	Limit dBuV
LINE 1					
Quasi-Peak					
0.170	9.665	37.360	47.025	-18.404	65.429
0.263	9.664	23.540	33.204	-29.567	62.771
0.755	9.691	16.290	25.981	-30.019	56.000
2.947	9.797	23.960	33.757	-22.243	56.000
12.236	9.981	12.640	22.621	-37.379	60.000
19.990	10.061	17.210	27.271	-32.729	60.000
Average					
0.170	9.665	23.830	33.495	-21.934	55.429
0.263	9.664	13.780	23.444	-29.327	52.771
0.755	9.691	5.470	15.161	-30.839	46.000
2.947	9.797	14.990	24.787	-21.213	46.000
12.236	9.981	8.070	18.051	-31.949	50.000
19.990	10.061	8.700	18.761	-31.239	50.000

Note:

1. All Reading Levels are Quasi-Peak and average value.
2. "■" means the worst emission level.
3. Measurement Level = Reading Level + Correct Factor

Product : TABLET PC
 Test Item : Conducted Emission Test
 Power Line : Line 2
 Test Mode : Mode 1: Transmit - BLE (GFSK) (2442MHz)

Frequency MHz	Correct Factor dB	Reading Level dBuV	Measurement Level dBuV	Margin dB	Limit dBuV
LINE 2					
Quasi-Peak					
0.173	9.664	36.010	45.674	-19.669	65.343
0.209	9.661	29.150	38.811	-25.503	64.314
0.724	9.689	17.080	26.769	-29.231	56.000
3.091	9.810	23.060	32.870	-23.130	56.000
19.369	10.186	17.190	27.376	-32.624	60.000
24.002	10.238	25.660	35.898	-24.102	60.000
Average					
0.173	9.664	26.420	36.084	-19.259	55.343
0.209	9.661	21.340	31.001	-23.313	54.314
0.724	9.689	4.370	14.059	-31.941	46.000
3.091	9.810	14.520	24.330	-21.670	46.000
19.369	10.186	11.770	21.956	-28.044	50.000
24.002	10.238	23.250	33.488	-16.512	50.000

Note:

1. All Reading Levels are Quasi-Peak and average value.
2. "█" means the worst emission level.
3. Measurement Level = Reading Level + Correct Factor

3. Peak Power Output

3.1. Test Equipment

	Equipment	Manufacturer	Model No./Serial No.	Last Cal.
X	Power Meter	Anritsu	ML2495A/6K00003357	May, 2015
X	Power Sensor	Anritsu	MA2411B/0738448	Jun., 2015

Note: 1. All equipments are calibrated every one year.
2. The test instruments marked by “X” are used to measure the final test results.

3.2. Test Setup

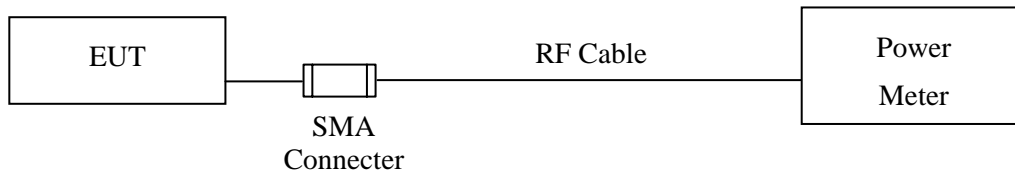

3.3. Limit

The maximum peak power shall be less 1Watt.

3.4. Test Procedure

Tested according to DTS test procedure of KDB 558074 for compliance to FCC 47CFR 15.247 requirements. The maximum peak conducted output power using KDB 558074 section 9.1.2 PKPM1 Peak power meter method.

3.5. Uncertainty

± 1.27 dB

3.6. Test Result of Peak Power Output

Product : TABLET PC
 Test Item : Peak Power Output
 Test Site : No.3 OATS
 Test Mode : Mode 1: Transmit - BLE (GFSK)

Channel No.	Frequency (MHz)	Measurement (dBm)	Required Limit	Result
Channel 00	2402.00	0.98	1 Watt= 30 dBm	Pass
Channel 19	2440.00	1.19	1 Watt= 30 dBm	Pass
Channel 39	2480.00	1.53	1 Watt= 30 dBm	Pass

4. Radiated Emission

4.1. Test Equipment

The following test equipments are used during the radiated emission test:

Test Site	Equipment	Manufacturer	Model No./Serial No.	Last Cal.	
☒ Site # 3	X	Magnetic Loop Antenna	Teseq	HLA6121/ 37133	Sep, 2014
	X	Bilog Antenna	Schaffner Chase	CBL6112B/ 2707	Jun, 2015
	X	EMI Test Receiver	R&S	ESCS 30/838251/ 001	Jun, 2015
	X	Coaxial Cable	QTK(Arnist)	RG 214/ LC003-RG	Jun, 2015
	X	Coaxial signal switch	Arnist	MP59B/ 6200798682	Jun, 2015

Test Site	Equipment	Manufacturer	Model No./Serial No.	Last Cal.	
☒ CB # 8	X	Spectrum Analyzer	R&S	FSP40/ 100339	Oct, 2014
	X	Horn Antenna	ETS-Lindgren	3117/ 35205	Mar, 2015
	X	Horn Antenna	Schwarzbeck	BBHA9170/209	Jan, 2015
	X	Horn Antenna	TRC	AH-0801/95051	Aug, 2014
	X	Pre-Amplifier	EMCI	EMC012630SE/980210	Jan, 2015
	X	Pre-Amplifier	MITEQ	JS41-001040000-58-5P/153945	Jul, 2014
	X	Pre-Amplifier	NARDA	DBL-1840N506/013	Jul, 2014

- Note: 1. All equipments are calibrated with traceable calibrations. Each calibration is traceable to the national or international standards.
2. The test instruments marked with “X” are used to measure the final test results.

4.2. Test Setup

Below 1GHz

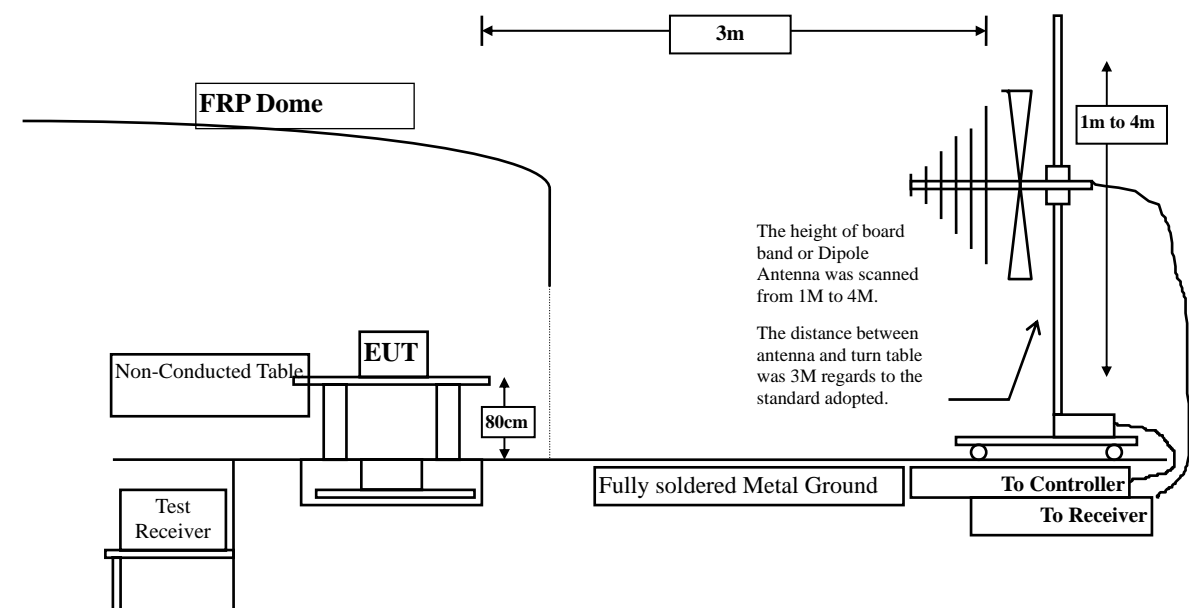

Above 1GHz

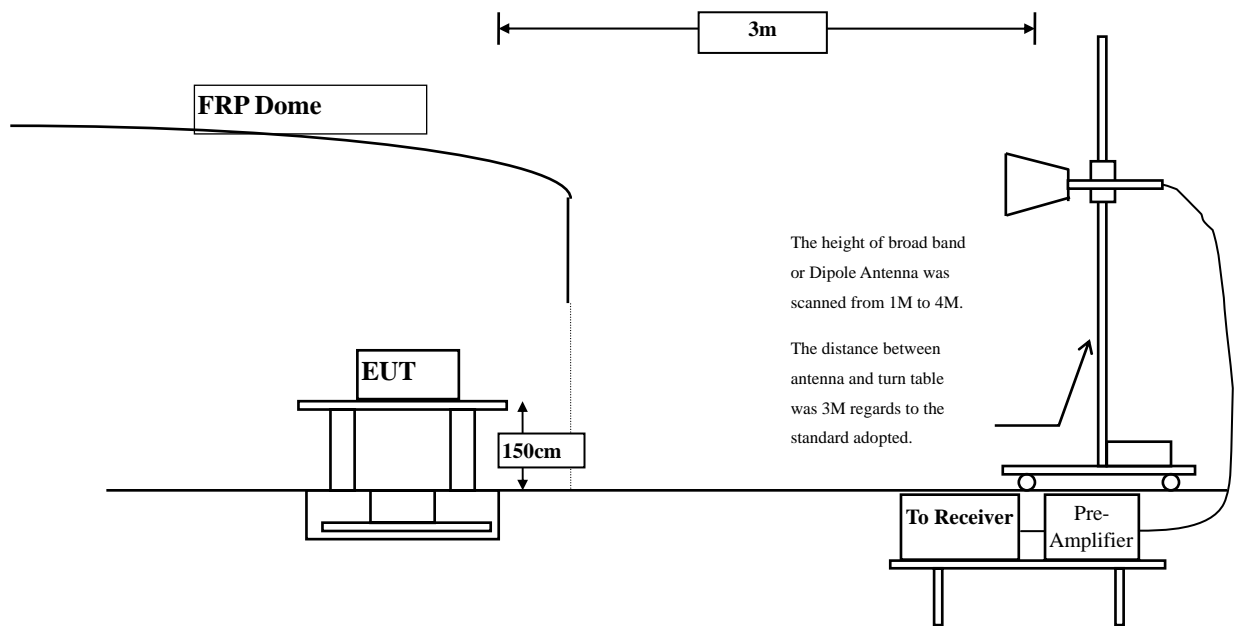

4.3. Limits

➤ General Radiated Emission Limits

Emissions radiated outside of the specified frequency bands, except for harmonics, shall be attenuated by at least 20dB below the level of the fundamental or to the general radiated emission limits in paragraph 15.209, whichever is the lesser attenuation.

FCC Part 15 Subpart C Paragraph 15.209 Limits		
Frequency MHz	Field strength (microvolts/meter)	Measurement distance (meter)
0.009-0.490	2400/F(kHz)	300
0.490-1.705	24000/F(kHz)	30
1.705-30	30	30
30-88	100	3
88-216	150	3
216-960	200	3
Above 960	500	3

- Remarks:
1. RF Voltage (dB μ V) = 20 log RF Voltage (uV)
 2. In the Above Table, the tighter limit applies at the band edges.
 3. Distance refers to the distance in meters between the measuring instrument antenna and the closed point of any part of the device or system.

4.4. Test Procedure

The EUT was setup according to ANSI C63.10: 2013 and tested according to DTS test procedure of KDB558074 for compliance to FCC 47CFR 15.247 requirements.

Measuring the frequency range below 1GHz, the EUT is placed on a turn table which is 0.8 meter above ground, when measuring the frequency range above 1GHz, the EUT is placed on a turn table which is 1.5 meter above ground.

The turn table is rotated 360 degrees to determine the position of the maximum emission level.

The EUT was positioned such that the distance from antenna to the EUT was 3 meters.

The antenna is scanned between 1 meter and 4 meters to find out the maximum emission level. This is repeated for both horizontal and vertical polarization of the antenna. In order to find the maximum emission, all of the interface cables were manipulated according to ANSI C63.10: 2013 on radiated measurement.

The resolution bandwidth below 30MHz setting on the field strength meter is 9kHz and 30MHz~1GHz is 120kHz and above 1GHz is 1MHz.

Radiated emission measurements below 30MHz are made using Loop Antenna and 30MHz~1GHz are made using broadband Bilog antenna and above 1GHz are made using Horn Antennas.

The measurement is divided into the Preliminary Measurement and the Final Measurement.

The suspected frequencies are searched for in Preliminary Measurement with the measurement antenna kept pointed at the source of the emission both in azimuth and elevation, with the polarization of the antenna oriented for maximum response. The antenna is pointed at an angle towards the source of the emission, and the EUT is rotated in both height and polarization to maximize the measured emission. The emission is kept within the illumination area of the 3 dB bandwidth of the antenna.

The worst radiated emission is measured in the Open Area Test Site on the Final Measurement.

The measurement frequency range from 9kHz - 10th Harmonic of fundamental was investigated.

4.5. Uncertainty

± 3.9 dB above 1GHz

± 3.8 dB below 1GHz

4.6. Test Result of Radiated Emission

Product : TABLET PC
 Test Item : Harmonic Radiated Emission
 Test Site : No.3 OATS
 Test Mode : Mode 1: Transmit - BLE (GFSK)(2402MHz)

Frequency MHz	Correct Factor dB	Reading Level dB μ V	Measurement Level dB μ V/m	Margin dB	Limit dB μ V/m
Horizontal					
Peak Detector:					
4804.000	3.327	34.360	37.687	-36.313	74.000
7206.000	10.136	32.900	43.036	-30.964	74.000
9608.000	13.706	34.550	48.256	-25.744	74.000
Average Detector:					
--					
Vertical					
Peak Detector:					
4804.000	6.638	34.760	41.397	-32.603	74.000
7206.000	11.005	33.310	44.315	-29.685	74.000
9608.000	14.103	34.250	48.353	-25.647	74.000
Average Detector:					
--					

Note:

1. All Readings below 1GHz are Quasi-Peak, above 1GHz are performed with peak and/or average measurements as necessary.
2. Peak measurements: RBW = 1MHz, VBW = 3 MHz, Sweep: Auto.
3. Average measurements: RBW = 1MHz, VBW = 10 Hz, Sweep: Auto.
4. Measurement Level = Reading Level + Correct Factor.
5. Correct Factor = Antenna factor + Cable loss – Amplifier gain.
6. The average measurement was not performed when the peak measured data under the limit of average detection.
7. The emission levels of other frequencies are very lower than the limit and not show in test report.

Product : TABLET PC
 Test Item : Harmonic Radiated Emission
 Test Site : No.3 OATS
 Test Mode : Mode 1: Transmit - BLE (GFSK) (2440MHz)

Frequency MHz	Correct Factor dB	Reading Level dBμV	Measurement Level dBμV/m	Margin dB	Limit dBμV/m
Horizontal					
Peak Detector:					
4880.000	3.010	34.440	37.450	-36.550	74.000
7320.000	11.833	32.980	44.814	-29.186	74.000
9760.000	12.580	33.520	46.101	-27.899	74.000
Average Detector:					
--					
Vertical					
Peak Detector:					
4880.000	5.738	34.520	40.258	-33.742	74.000
7320.000	12.703	32.560	45.263	-28.737	74.000
9760.000	13.052	32.610	45.662	-28.338	74.000
Average Detector:					
--					

Note:

1. All Readings below 1GHz are Quasi-Peak, above 1GHz are performed with peak and/or average measurements as necessary.
2. Peak measurements: RBW = 1MHz, VBW = 3 MHz, Sweep: Auto.
3. Average measurements: RBW = 1MHz, VBW = 10 Hz, Sweep: Auto.
4. Measurement Level = Reading Level + Correct Factor.
5. Correct Factor = Antenna factor + Cable loss – Amplifier gain.
6. The average measurement was not performed when the peak measured data under the limit of average detection.
7. The emission levels of other frequencies are very lower than the limit and not show in test report.

Product : TABLET PC
 Test Item : Harmonic Radiated Emission
 Test Site : No.3 OATS
 Test Mode : Mode 1: Transmit - BLE (GFSK) (2480MHz)

Frequency MHz	Correct Factor dB	Reading Level dB μ V	Measurement Level dB μ V/m	Margin dB	Limit dB μ V/m
Horizontal					
Peak Detector:					
4960.000	2.760	34.090	36.850	-37.150	74.000
7440.000	12.567	33.950	46.516	-27.484	74.000
9920.000	13.456	33.510	46.966	-27.034	74.000
Average Detector:					
--					
Vertical					
Peak Detector:					
4960.000	5.557	33.310	38.867	-35.133	74.000
7440.000	13.426	33.290	46.715	-27.285	74.000
9920.000	13.958	33.140	47.098	-26.902	74.000
Average Detector:					
--					

Note:

1. All Readings below 1GHz are Quasi-Peak, above 1GHz are performed with peak and/or average measurements as necessary.
2. Peak measurements: RBW = 1MHz, VBW = 3 MHz, Sweep: Auto.
3. Average measurements: RBW = 1MHz, VBW = 10 Hz, Sweep: Auto.
4. Measurement Level = Reading Level + Correct Factor.
5. Correct Factor = Antenna factor + Cable loss – Amplifier gain.
6. The average measurement was not performed when the peak measured data under the limit of average detection.
7. The emission levels of other frequencies are very lower than the limit and not show in test report.

Product : TABLET PC
 Test Item : General Radiated Emission
 Test Site : No.3 OATS
 Test Mode : Mode 1: Transmit - BLE (GFSK) (2440MHz)

Frequency MHz	Correct Factor dB	Reading Level dB μ V	Measurement Level dB μ V/m	Margin dB	Limit dB μ V/m
Horizontal					
263.362	-5.004	34.167	29.162	-16.838	46.000
371.609	-1.104	30.480	29.376	-16.624	46.000
455.957	-0.437	33.558	33.121	-12.879	46.000
575.449	2.962	38.687	41.649	-4.351	46.000
791.942	5.212	31.522	36.734	-9.266	46.000
963.449	6.696	23.810	30.506	-23.494	54.000
Vertical					
153.710	-6.217	43.087	36.870	-6.630	43.500
371.609	-2.706	28.212	25.507	-20.493	46.000
503.754	-0.852	36.475	35.623	-10.377	46.000
576.855	-5.655	34.412	28.757	-17.243	46.000
791.942	2.897	28.272	31.169	-14.831	46.000
960.638	7.166	24.872	32.038	-21.962	54.000

Note:

1. All Readings below 1GHz are Quasi-Peak, above 1GHz are performed with peak and/or average measurements as necessary.
2. Peak measurements: RBW = 1MHz, VBW = 3 MHz, Sweep: Auto.
3. Average measurements: RBW = 1MHz, VBW = 10 Hz, Sweep: Auto.
4. Measurement Level = Reading Level + Correct Factor.
5. Correct Factor = Antenna factor + Cable loss – Amplifier gain.
6. The average measurement was not performed when the peak measured data under the limit of average detection.
7. The emission levels of other frequencies are very lower than the limit and not show in test report.
8. No emission found between lowest internal used/generated frequency to 30MHz.

5. RF Antenna Conducted Test

5.1. Test Equipment

	Equipment	Manufacturer	Model No./Serial No.	Last Cal.
	Spectrum Analyzer	R&S	FSP40 / 100170	Jun., 2015
	Spectrum Analyzer	Agilent	E4407B / US39440758	Jun., 2015
X	Spectrum Analyzer	Agilent	N9010A / MY48030495	Apr., 2015

Note: 1. All equipments are calibrated every one year.
2. The test instruments Marked “X” are used to measure the final test results.

5.2. Test Setup

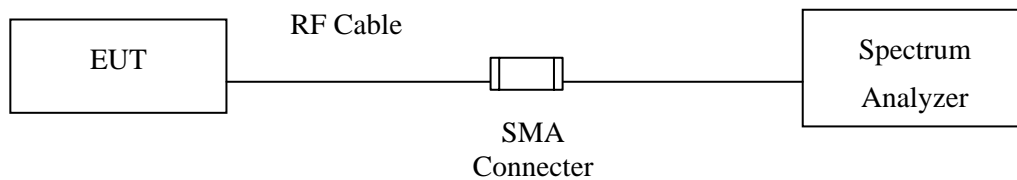

5.3. Limits

According to FCC Section 15.247(d). In any 100 kHz bandwidth outside the frequency band in which the spread spectrum or digitally modulated intentional radiator is operating, the radio frequency power that is produced by the intentional radiator shall be at least 20 dB below that in the 100 kHz bandwidth within the band that contains the highest level of the desired power, based on either an RF conducted or measurement, provided the transmitter demonstrates compliance with the peak conducted power limits. If the transmitter complies with the conducted power limits based on the use of RMS averaging over a time interval, the attenuation required under this paragraph shall be 30 dB instead of 20 dB.

5.4. Test Procedure

The EUT was tested according to DTS test procedure of KDB558074 for compliance to FCC 47CFR 15.247 requirements.

5.5. Uncertainty

± 150Hz

5.6. Test Result of RF Antenna Conducted Test

Product : TABLET PC
 Test Item : RF Antenna Conducted Test
 Test Site : No.3 OATS
 Test Mode : Mode 1: Transmit - BLE (GFSK)

Figure Channel 00:

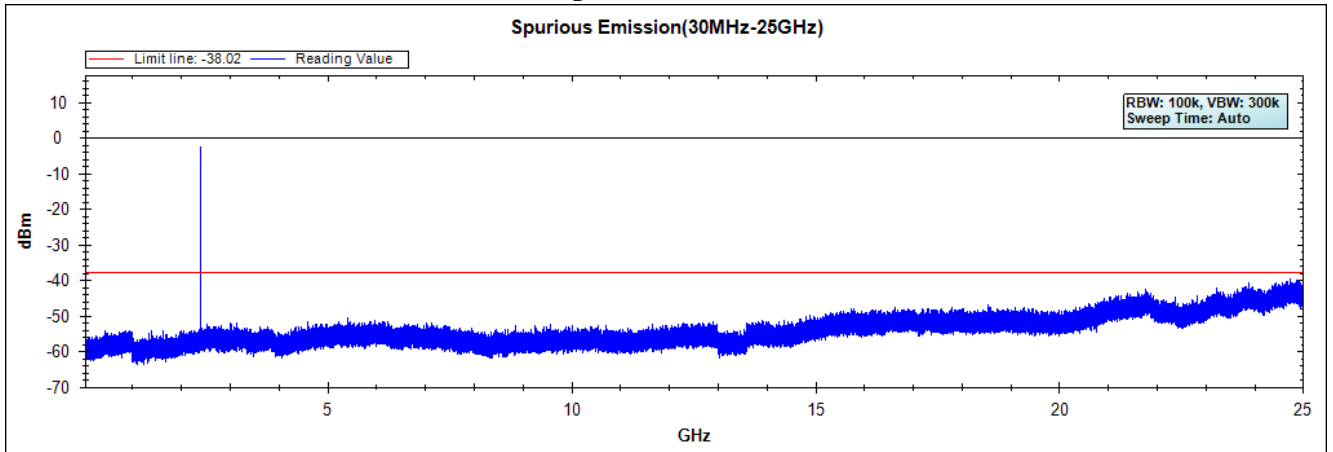

Figure Channel 19:

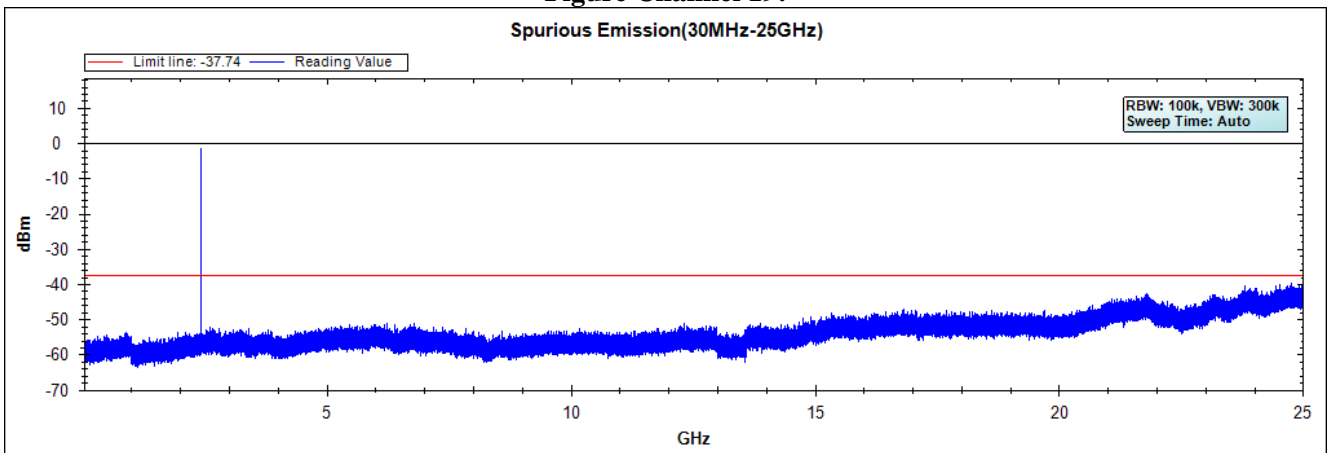
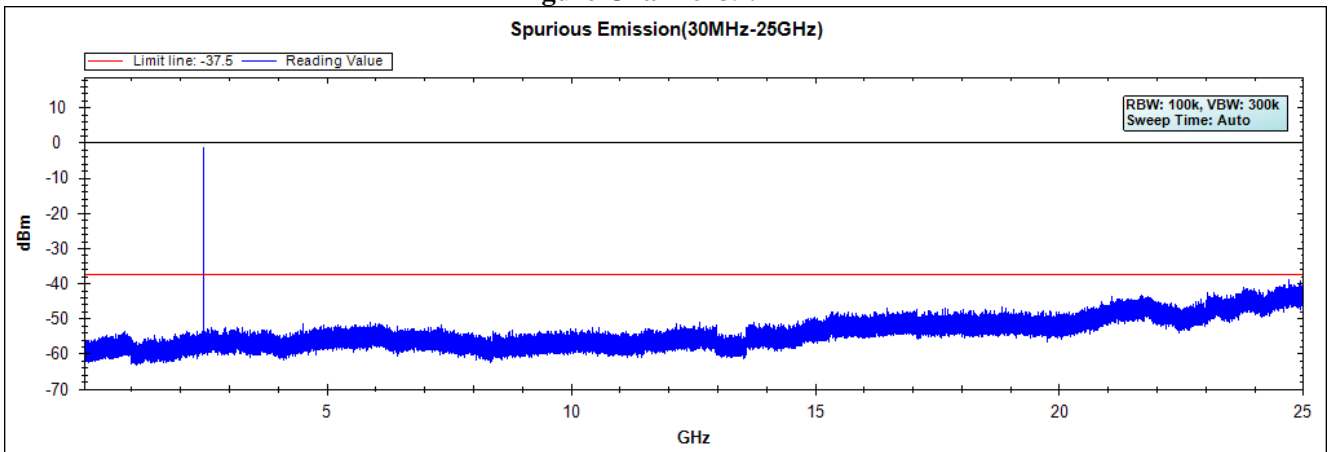

Figure Channel 39:



Note: The above test pattern is synthesized by multiple of the frequency range.

6. Band Edge

6.1. Test Equipment

RF Radiated Measurement:

The following test equipments are used during the band edge tests:

Test Site		Equipment	Manufacturer	Model No./Serial No.	Last Cal.
☒ CB # 8	X	Spectrum Analyzer	R&S	FSP40/ 100339	Oct, 2014
	X	Horn Antenna	ETS-Lindgren	3117/ 35205	Mar, 2014
	X	Horn Antenna	Schwarzbeck	BBHA9170/209	Jan, 2015
	X	Horn Antenna	TRC	AH-0801/95051	Aug, 2014
	X	Pre-Amplifier	EMCI	EMC012630SE/980210	Jan, 2015
	X	Pre-Amplifier	MITEQ	JS41-001040000-58-5P/153945	Jul, 2014
	X	Pre-Amplifier	NARDA	DBL-1840N506/013	Jul, 2014

- Note: 1. All equipments are calibrated with traceable calibrations. Each calibration is traceable to the national or international standards.
2. The test instruments marked with "X" are used to measure the final test results.

6.2. Test Setup

RF Radiated Measurement:

Above 1GHz

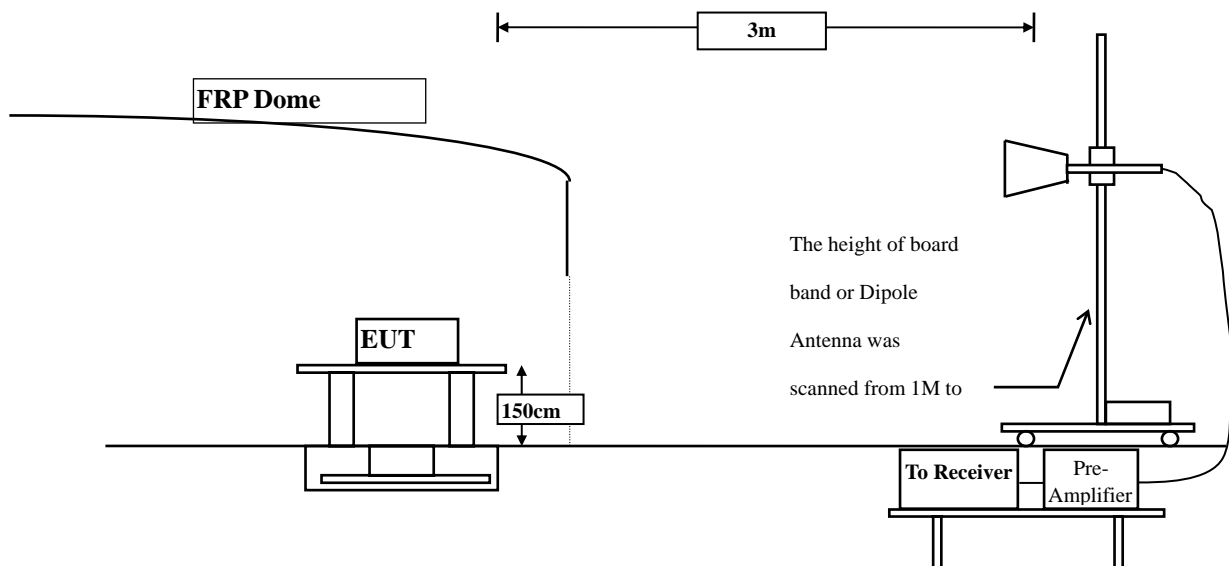

6.3. Limit

In any 100 kHz bandwidth outside the frequency band in which the spread spectrum intentional radiator is operating, the radio frequency power that is produced by the intentional radiator shall be at least 20 dB below that in the 100 kHz bandwidth within the band that contains the highest level of the desired power, based on either an RF conducted or a radiated measurement. Attenuation below the general limits specified in Section 15.209(a) is not required. In addition, radiated emissions which fall in the restricted bands, as defined in Section 15.205(a), must also comply with the radiated emission limits specified in Section 15.209(a) (see Section 15.205(c)).

6.4. Test Procedure

The EUT was setup according to ANSI C63.10, 2013 and tested according to DTS test procedure of KDB558074 for compliance to FCC 47CFR 15.247 requirements.

The EUT is placed on a turn table which is 1.5 meter above ground. The turn table is rotated 360 degrees to determine the position of the maximum emission level. The EUT was positioned such that the distance from antenna to the EUT was 3 meters.

The antenna is scanned from 1 meter to 4 meters to find out the maximum emission level. This is repeated for both horizontal and vertical polarization of the antenna. In order to find the maximum emission, all of the interface cables were manipulated according to ANSI C63.10:2013 on radiated measurement.

6.5. Uncertainty

- ± 3.9 dB above 1GHz
- ± 3.8 dB below 1GHz

6.6. Test Result of Band Edge

Product : TABLET PC
 Test Item : Band Edge
 Test Site : No.3 OATS
 Test Mode : Mode 1: Transmit - BLE (GFSK) (2402MHz)

RF Radiated Measurement (Horizontal):

Channel No.	Frequency (MHz)	Correct Factor (dB)	Reading Level (dBμV)	Emission Level (dBμV/m)	Peak Limit (dBμV/m)	Average Limit (dBμV/m)	Result
00 (Peak)	2385.942	-1.147	38.215	37.068	74.00	54.00	Pass
00 (Peak)	2390.000	-1.131	36.635	35.504	74.00	54.00	Pass
00 (Peak)	2400.000	-1.084	61.270	60.187	--	--	--
00 (Peak)	2401.739	-1.074	93.320	92.246	--	--	--
00 (Average)	2390.000	-1.131	25.159	24.028	74.00	54.00	Pass
00 (Average)	2400.000	-1.084	44.978	43.895	--	--	--
00 (Average)	2402.029	-1.073	92.670	91.598	--	--	--

Figure Channel 00: Horizontal (Peak)

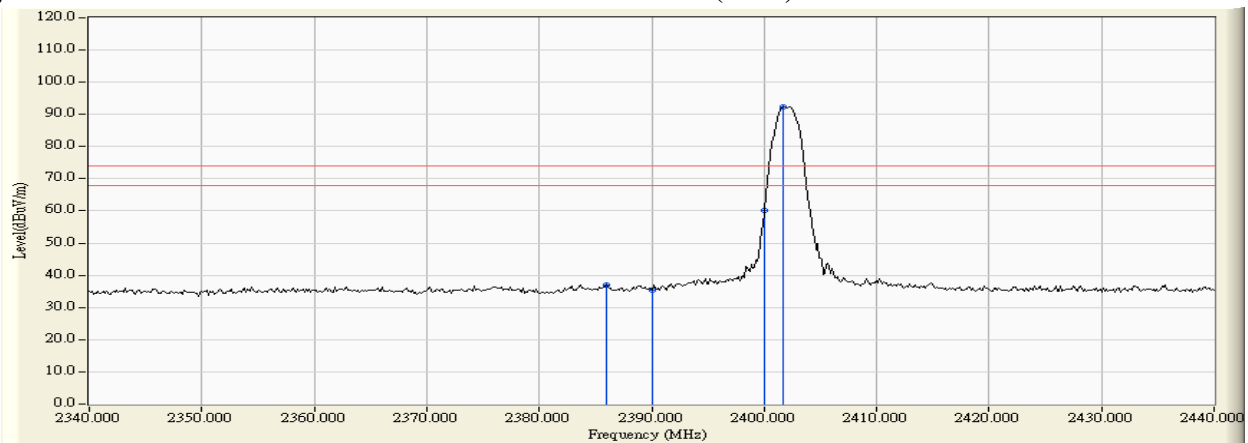
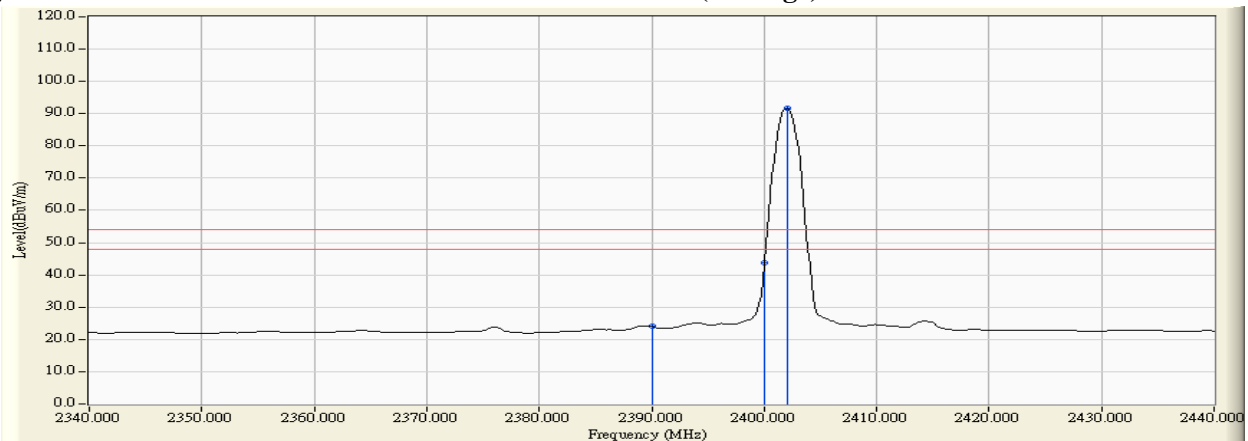

Figure Channel 00: Horizontal (Average)



Note:

1. All readings above 1GHz are performed with peak and/or average measurements as necessary.
2. Peak measurements: RBW = 1MHz, VBW = 3 MHz, Sweep: Auto.
3. Average measurements: RBW = 1MHz, VBW = 10 Hz, Sweep: Auto.
4. “ * ”, means this data is the worst emission level.
5. Measurement Level = Reading Level + Correct Factor.
6. The average measurement was not performed when the peak measured data under the limit of average detection.

Product : TABLET PC
 Test Item : Band Edge
 Test Site : No.3 OATS
 Test Mode : Mode 1: Transmit - BLE (GFSK) (2402MHz)

RF Radiated Measurement (Vertical):

Channel No.	Frequency (MHz)	Correct Factor (dB)	Reading Level (dBμV)	Emission Level (dBμV/m)	Peak Limit (dBμV/m)	Average Limit (dBμV/m)	Result
00 (Peak)	2389.420	-1.722	42.334	40.612	74.00	54.00	Pass
00 (Peak)	2390.000	-1.725	37.993	36.268	74.00	54.00	Pass
00 (Peak)	2400.000	-1.733	61.399	59.667	--	--	--
00 (Peak)	2402.319	-1.728	93.624	91.896	--	--	--
00 (Average)	2386.522	-1.709	25.486	23.777	74.00	54.00	Pass
00 (Average)	2390.000	-1.725	24.800	23.075	74.00	54.00	Pass
00 (Average)	2400.000	-1.733	45.383	43.651	--	--	--
00 (Average)	2402.029	-1.729	93.134	91.405	--	--	--

Figure Channel 00: Vertical (Peak)

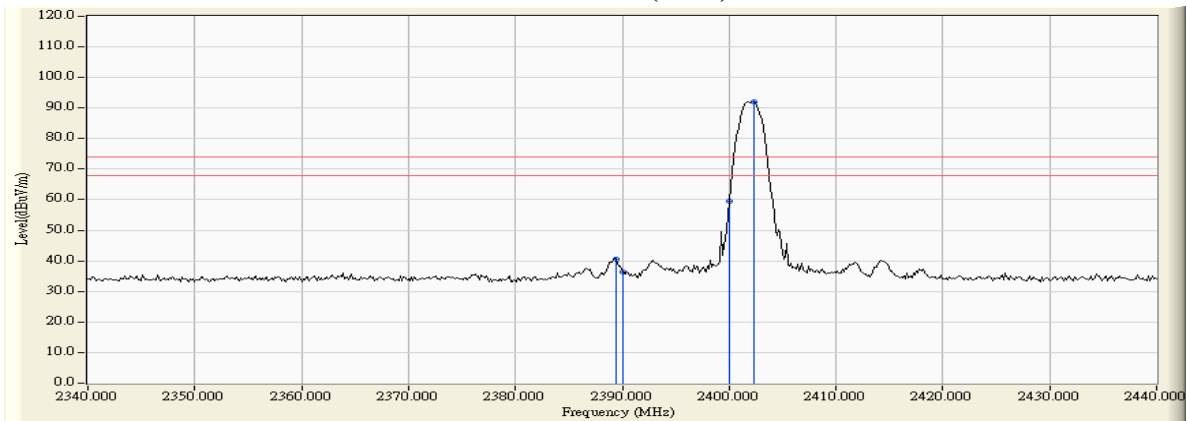
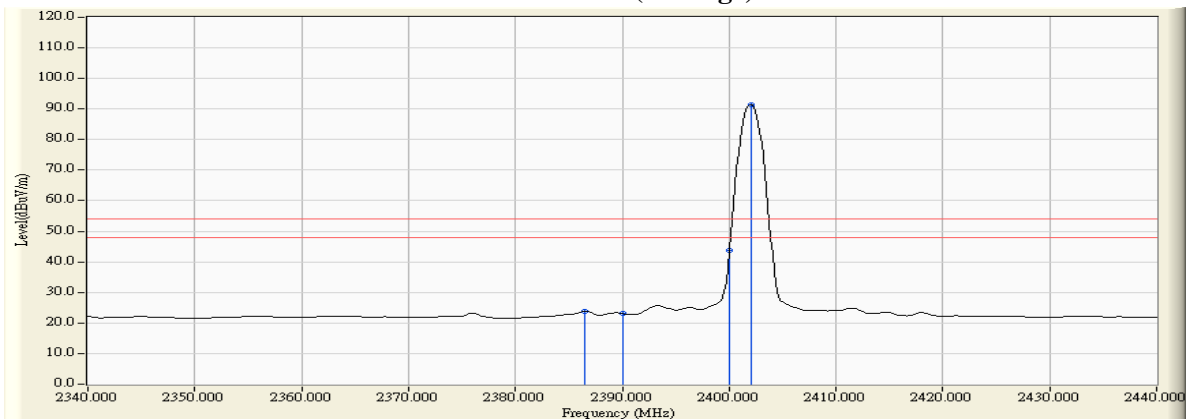

Figure Channel 00: Vertical (Average)



Note:

1. All readings above 1GHz are performed with peak and/or average measurements as necessary.
2. Peak measurements: RBW = 1MHz, VBW = 3 MHz, Sweep: Auto.
3. Average measurements: RBW = 1MHz, VBW = 10 Hz, Sweep: Auto.
4. “ * ”, means this data is the worst emission level.
5. Measurement Level = Reading Level + Correct Factor.
6. The average measurement was not performed when the peak measured data under the limit of average detection.

Product : TABLET PC
 Test Item : Band Edge
 Test Site : No.3 OATS
 Test Mode : Mode 1: Transmit - BLE (GFSK) (2480MHz)

RF Radiated Measurement (Horizontal):

Channel No.	Frequency (MHz)	Correct Factor (dB)	Reading Level (dBμV)	Emission Level (dBμV/m)	Peak Limit (dBμV/m)	Average Limit (dBμV/m)	Result
39 (Peak)	2479.732	-0.582	92.495	91.913	--	--	--
39 (Peak)	2483.500	-0.558	44.512	43.954	74.00	54.00	Pass
39 (Peak)	2484.225	-0.554	44.982	44.428	74.00	54.00	Pass
39 (Average)	2480.022	-0.580	91.779	91.199	--	--	--
39 (Average)	2483.500	-0.558	26.845	26.287	74.00	54.00	Pass

Figure Channel 39: Horizontal (Peak)

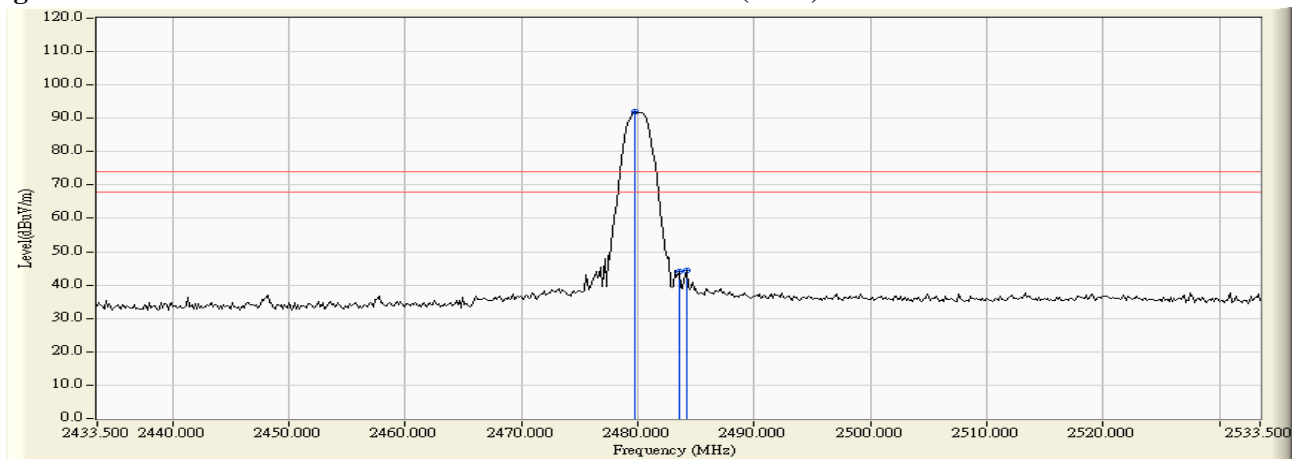
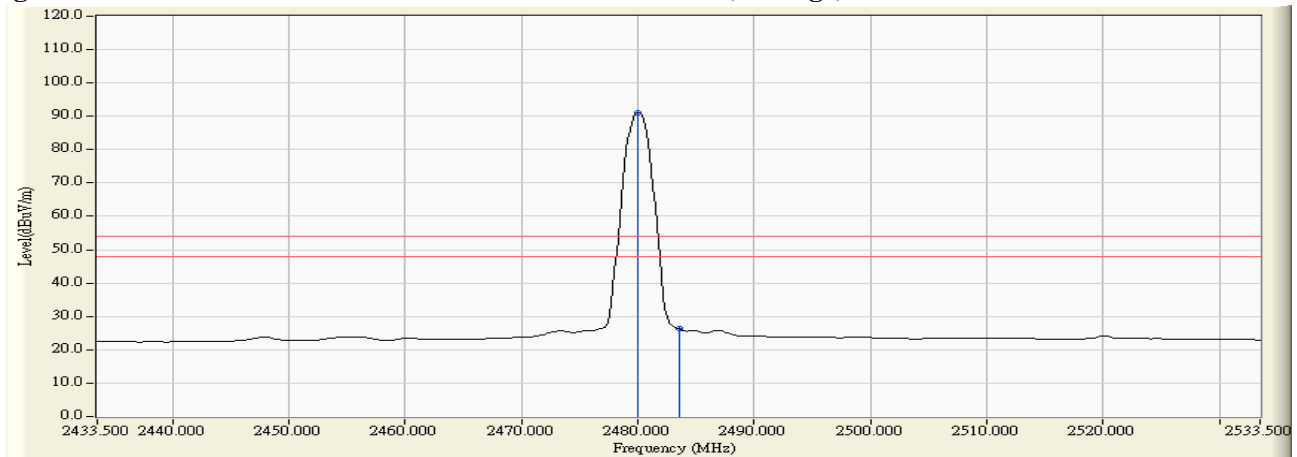

Figure Channel 39: Horizontal (Average)



Note:

1. All readings above 1GHz are performed with peak and/or average measurements as necessary.
2. Peak measurements: RBW = 1MHz, VBW = 3 MHz, Sweep: Auto.
3. Average measurements: RBW = 1MHz, VBW = 10 Hz, Sweep: Auto.
4. “ * ”, means this data is the worst emission level.
5. Measurement Level = Reading Level + Correct Factor.
6. The average measurement was not performed when the peak measured data under the limit of average detection.

Product : TABLET PC
 Test Item : Band Edge
 Test Site : No.3 OATS
 Test Mode : Mode 1: Transmit - BLE (GFSK) (2480MHz)

RF Radiated Measurement (Vertical):

Channel No.	Frequency (MHz)	Correct Factor (dB)	Reading Level (dBμV)	Emission Level (dBμV/m)	Peak Limit (dBμV/m)	Average Limit (dBμV/m)	Result
39 (Peak)	2480.312	-1.323	94.231	92.908	--	--	--
39 (Peak)	2483.500	-1.305	40.521	39.216	74.00	54.00	Pass
39 (Peak)	2484.225	-1.301	47.576	46.275	74.00	54.00	Pass
39 (Average)	2480.022	-1.324	93.716	92.392	--	--	--
39 (Average)	2483.500	-1.305	28.168	26.863	74.00	54.00	Pass

Figure Channel 39: Vertical (Peak)

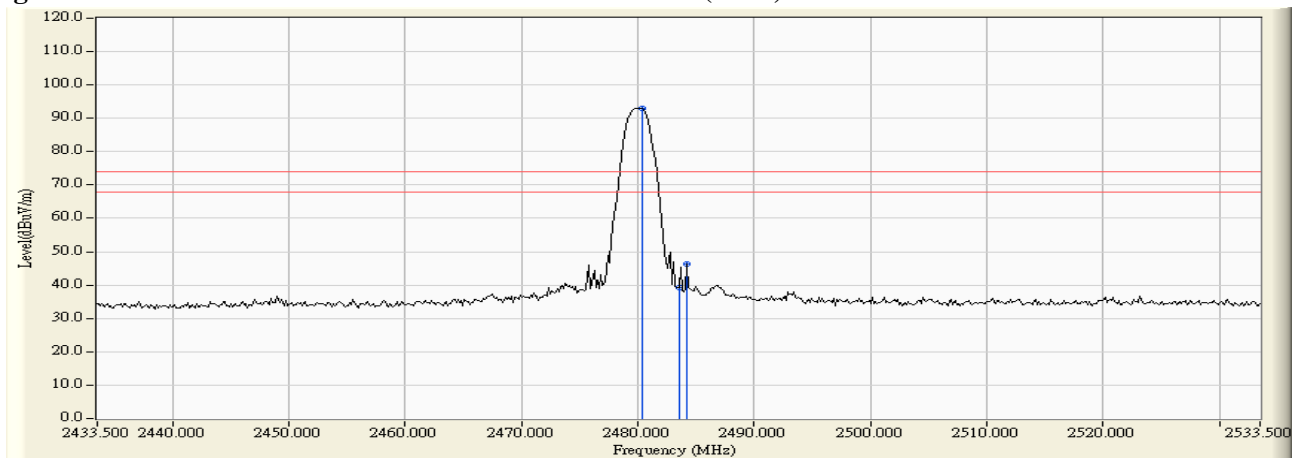
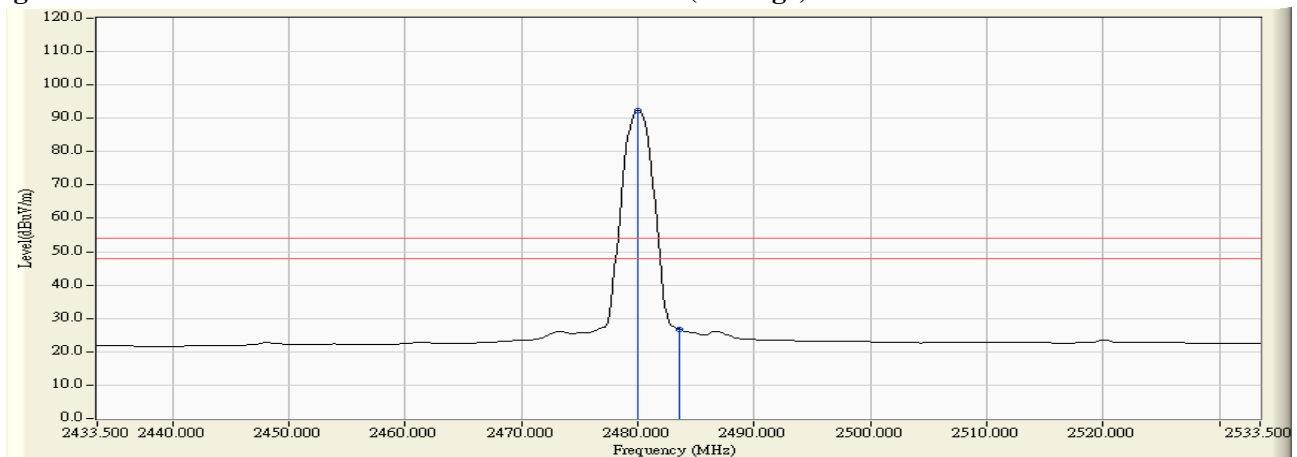

Figure Channel 39: Vertical (Average)



Note:

1. All readings above 1GHz are performed with peak and/or average measurements as necessary.
2. Peak measurements: RBW = 1MHz, VBW = 3 MHz, Sweep: Auto.
3. Average measurements: RBW = 1MHz, VBW = 10 Hz, Sweep: Auto.
4. “ * ”, means this data is the worst emission level.
5. Measurement Level = Reading Level + Correct Factor.
6. The average measurement was not performed when the peak measured data under the limit of average detection.

7. Occupied Bandwidth (6dB BW)

7.1. Test Equipment

	Equipment	Manufacturer	Model No./Serial No.	Last Cal.
	Spectrum Analyzer	R&S	FSP40 / 100170	Jun., 2015
	Spectrum Analyzer	Agilent	E4407B / US39440758	Jun., 2015
X	Spectrum Analyzer	Agilent	N9010A / MY48030495	Apr., 2015

Note:

1. All equipments are calibrated with traceable calibrations. Each calibration is traceable to the national or international standards.
2. The test instruments marked with “X” are used to measure the final test results.

7.2. Test Setup

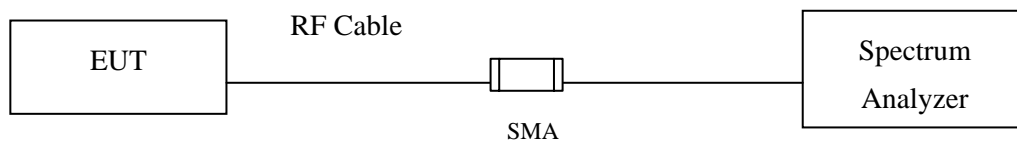

7.3. Limits

The minimum bandwidth shall be at least 500 kHz.

7.4. Test Procedure

The EUT was setup according to ANSI C63.10 2013; tested according to DTS test procedure of KDB558074 for compliance to FCC 47CFR 15.247 requirements.

Set RBW = 1-5% of the emission bandwidth, VBW ≥ 3*RBW

7.5. Uncertainty

± 150Hz

7.6. Test Result of Occupied Bandwidth

Product : TABLET PC
 Test Item : Occupied Bandwidth Data
 Test Site : No.3 OATS
 Test Mode : Mode 1: Transmit - BLE (GFSK) (2402MHz)

Channel No.	Frequency (MHz)	Measurement Level (kHz)	Required Limit (kHz)	Result
00	2402	760	>500	Pass

Figure Channel 00:

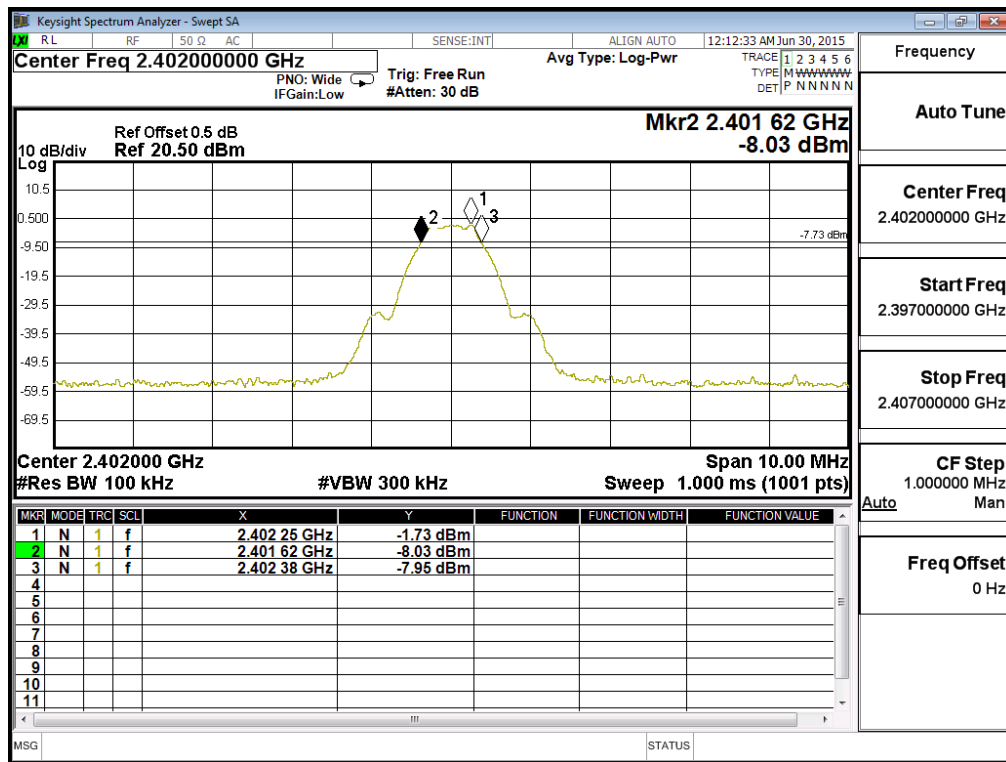

Product : TABLET PC
 Test Item : Occupied Bandwidth Data
 Test Site : No.3 OATS
 Test Mode : Mode 1: Transmit - BLE (GFSK) (2440MHz)

Channel No.	Frequency (MHz)	Measurement Level (kHz)	Required Limit (kHz)	Result
19	2440	750	>500	Pass

Figure Channel 19:

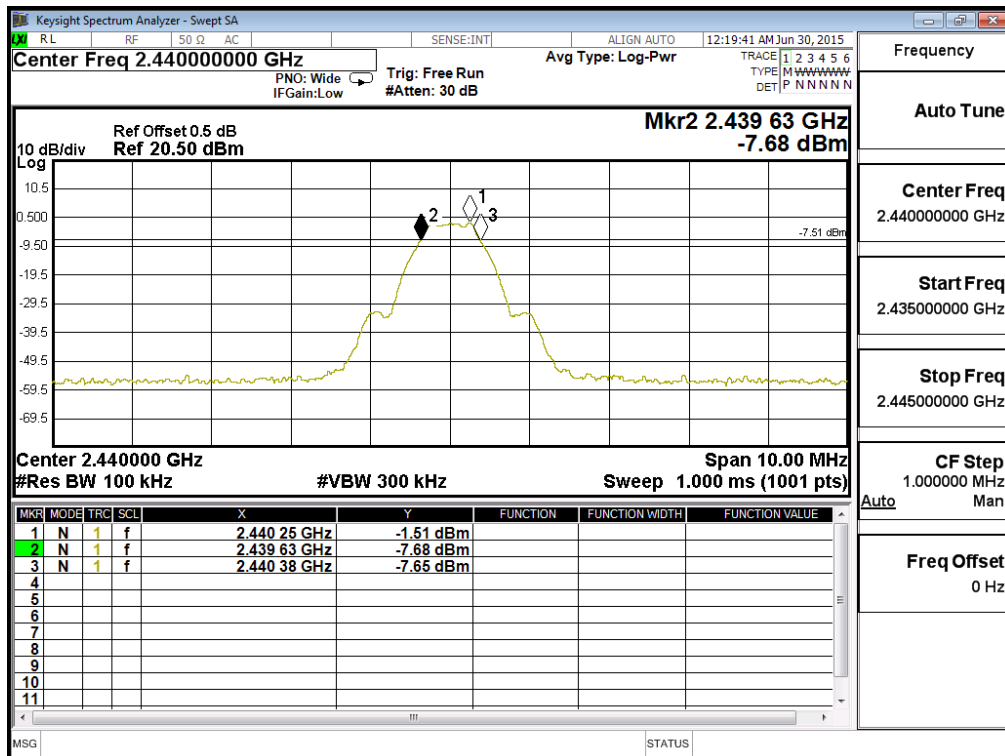

Product : TABLET PC
 Test Item : Occupied Bandwidth Data
 Test Site : No.3 OATS
 Test Mode : Mode 1: Transmit - BLE (GFSK) (2480MHz)

Channel No.	Frequency (MHz)	Measurement Level (kHz)	Required Limit (kHz)	Result
39	2480	760	>500	Pass

Figure Channel 39:

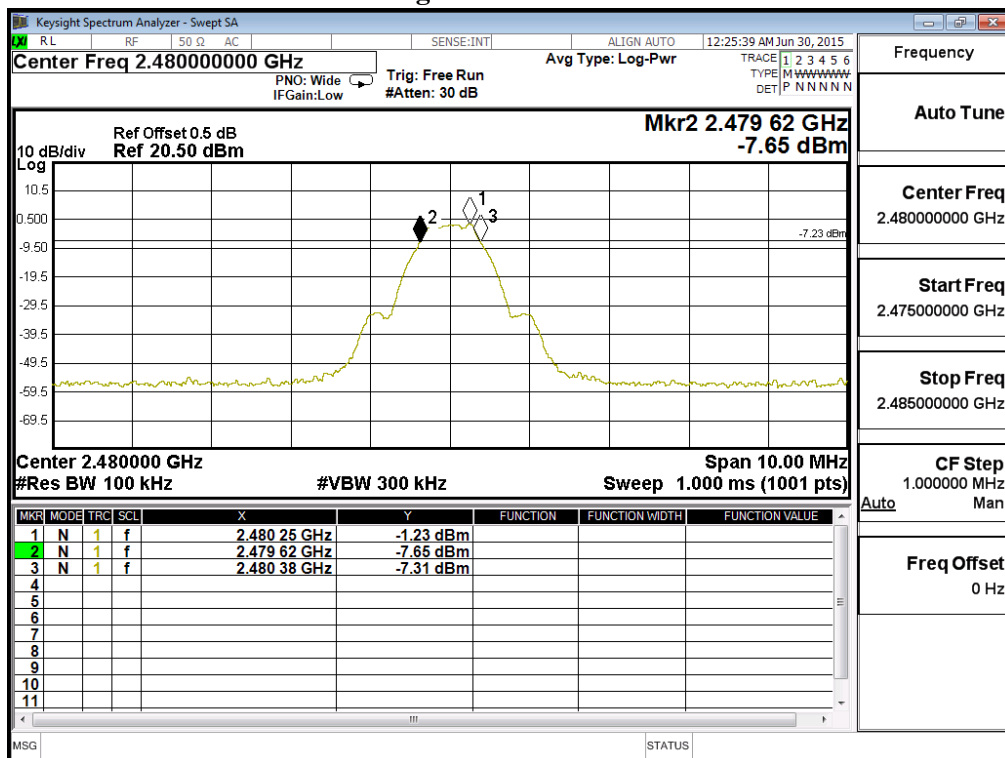

8. Power Density

8.1. Test Equipment

	Equipment	Manufacturer	Model No./Serial No.	Last Cal.
	Spectrum Analyzer	R&S	FSP40 / 100170	Jun., 2015
	Spectrum Analyzer	Agilent	E4407B / US39440758	Jun., 2015
X	Spectrum Analyzer	Agilent	N9010A / MY48030495	Apr., 2015

Note:

1. All equipments are calibrated with traceable calibrations. Each calibration is traceable to the national or international standards.
2. The test instruments marked with “X” are used to measure the final test results.

8.2. Test Setup

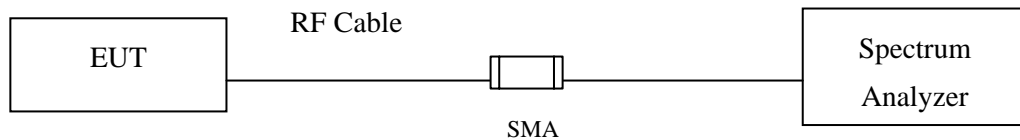

8.3. Limits

The transmitted power density averaged over any 1 second interval shall not be greater +8dBm in any 3kHz bandwidth.

8.4. Test Procedure

The EUT was setup according to ANSI C63.10: 2013, the maximum power spectral density using KDB 558074 section 10.2 PKPSD (peak PSD) method.

8.5. Uncertainty

± 1.27 dB

8.6. Test Result of Power Density

Product : TABLET PC
 Test Item : Power Density Data
 Test Site : No.3 OATS
 Test Mode : Mode 1: Transmit - BLE (GFSK) (2402MHz)

Channel No.	Frequency (MHz)	Measure Level (dBm)	Limit (dBm)	Result
00	2402	-8.020	< 8dBm	Pass

Figure Channel 00:

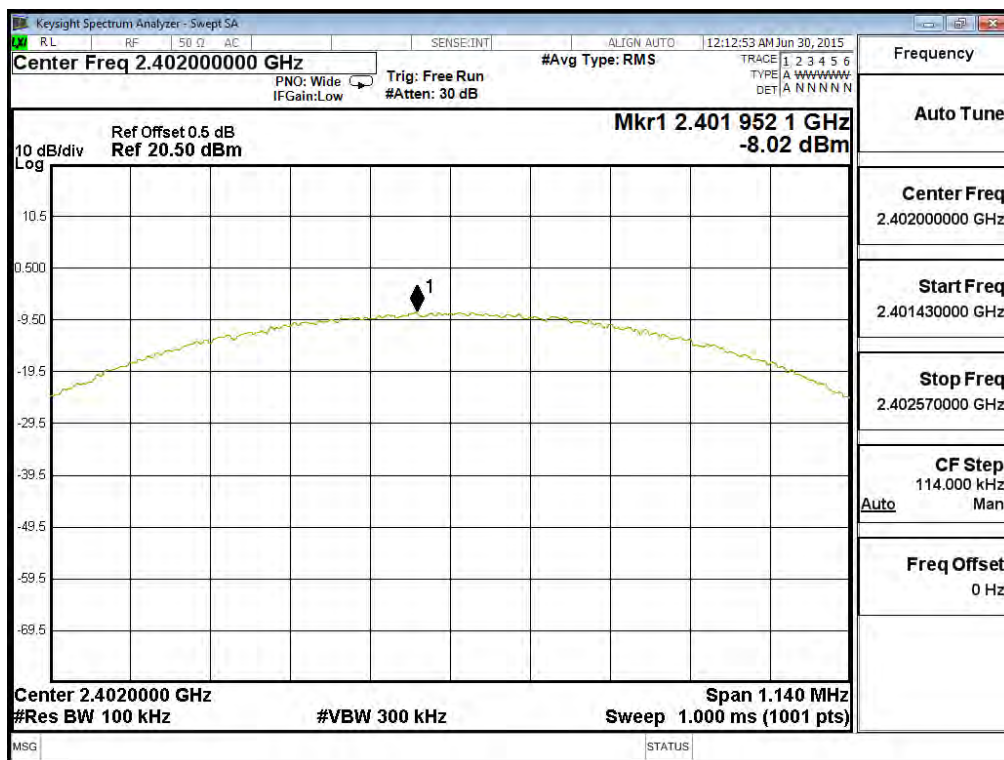

Product : TABLET PC
 Test Item : Power Density Data
 Test Site : No.3OATS
 Test Mode : Mode 1: Transmit - BLE (GFSK) (2440MHz)

Channel No.	Frequency (MHz)	Measurement Level (dBm)	Required Limit (dBm)	Result
19	2440	-7.740	< 8dBm	Pass

Figure Channel 19:

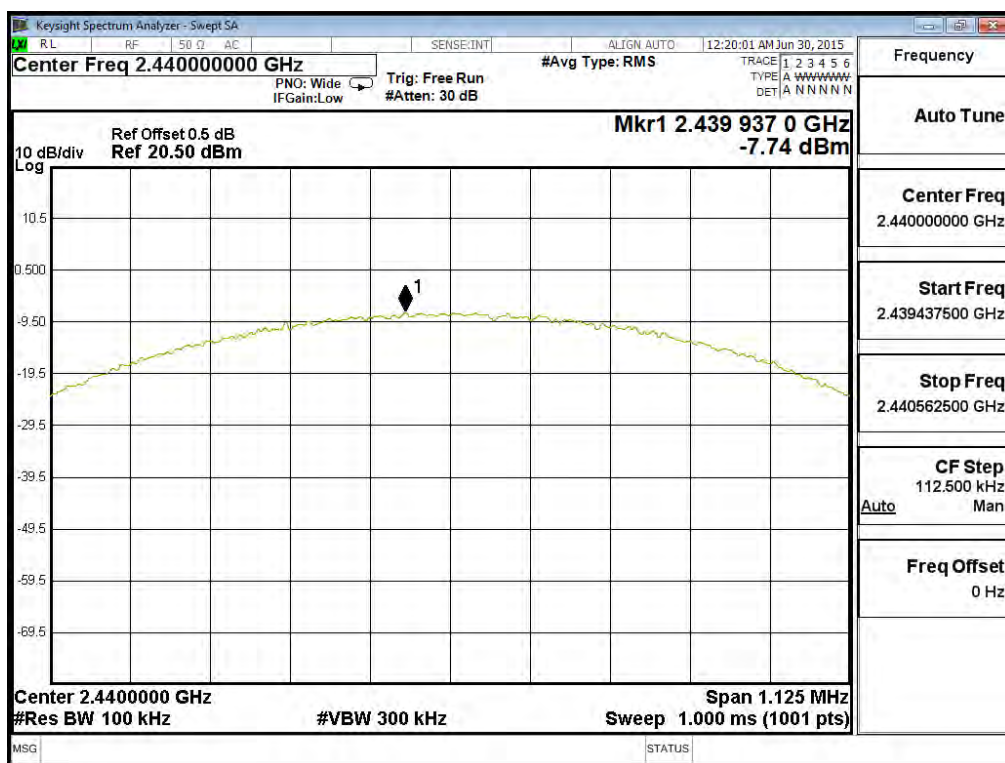

Product : TABLET PC
 Test Item : Power Density Data
 Test Site : No.3 OATS
 Test Mode : Mode 1: Transmit - BLE (GFSK) (2480MHz)

Channel No.	Frequency (MHz)	Measurement Level (dBm)	Required Limit (dBm)	Result
39	2480	-7.500	< 8dBm	Pass

Figure Channel 39:

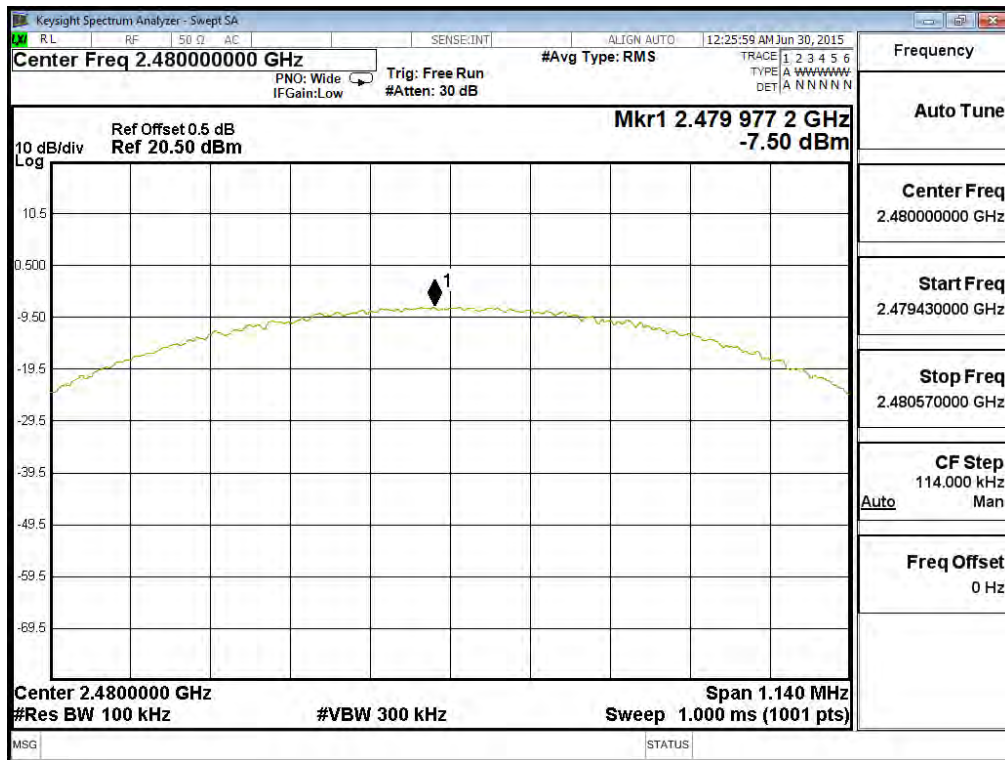

9. EMI Reduction Method During Compliance Testing

No modification was made during testing.