

FCC Test Report

(Class II Permissive Change)

Product Name	WiFi SOM Module
Model No	MS-01
FCC ID.	2ABTU-MS01

Applicant	RuggON Corporation
Address	4F, No. 298, Yang Guang St., Neihu Dist., Taipei City, Taiwan

Date of Receipt	Dec. 06, 2019
Issue Date	Jan. 17, 2020
Report No.	19C0098R-RFUSP27V00
Report Version	V1.0



The test results relate only to the samples tested.

The test results shown in the test report are traceable to the national/international standard through the calibration report of the equipment and evaluated measurement uncertainty herein.

This report must not be used to claim product endorsement by TAF or any agency of the government.

The test report shall not be reproduced without the written approval of DEKRA Testing and Certification Co., Ltd

Test Report

Issue Date: Jan. 17, 2020

Report No.: 19C0098R-RFUSP27V00



Product Name	WiFi SOM Module
Applicant	RuggON Corporation
Address	4F, No. 298, Yang Guang St., Neihu Dist., Taipei City, Taiwan
Manufacturer	RuggON Corporation
Model No.	MS-01
FCC ID.	2ABTU-MS01
EUT Rated Voltage	DC 3.3V
EUT Test Voltage	DC 3.3V
Trade Name	RuggON
Applicable Standard	FCC CFR Title 47 Part 15 Subpart C ANSI C63.4: 2014, ANSI C63.10: 2013
Test Result	Complied

Documented By :

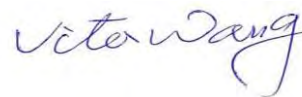

(Adm. Specialist / Vita Wang)

Tested By :



(Engineer / Sam Hsu)

Approved By :



(Director / Vincent Lin)

TABLE OF CONTENTS

Description	Page
1. GENERAL INFORMATION	4
1.1. EUT Description.....	4
1.2. Operational Description	6
1.3. Tested System Details	7
1.4. Configuration of Tested System	7
1.5. EUT Exercise Software.....	7
1.6. Test Facility	8
1.7. List of Test Equipment.....	9
2. Peak Power Output.....	11
2.1. Test Setup.....	11
2.2. Limits	11
2.3. Test Procedure	11
2.4. Uncertainty	11
2.5. Test Result of Peak Power Output	12
3. Radiated Emission	18
3.1. Test Setup.....	18
3.2. Limits	19
3.3. Test Procedure	20
3.4. Uncertainty	21
3.5. Test Result of Radiated Emission	22
4. Band Edge	96
4.1. Test Setup.....	96
4.2. Limits	96
4.3. Test Procedure	97
4.4. Uncertainty	98
4.5. Test Result of Band Edge.....	99
5. Duty Cycle.....	203
5.1. Test Setup.....	203
5.2. Test Procedure	203
5.3. Uncertainty	203
5.4. Test Result of Duty Cycle	204
6. EMI Reduction Method During Compliance Testing	207
Attachment 1: EUT Test Photographs	
Attachment 2: EUT Detailed Photographs	

1. GENERAL INFORMATION

1.1. EUT Description

Product Name	WiFi SOM Module
Trade Name	RuggON
Model No.	MS-01
FCC ID.	2ABTU-MS01
Frequency Range	2412-2462MHz for 802.11b/g/n-20BW, 2422-2452MHz for 802.11n-40BW
Number of Channels	802.11b/g/n-20MHz: 11, 802.11n-40MHz: 9
Data Speed	802.11b: 1-11Mbps, 802.11g: 6-54Mbps, 802.11n: up to 300Mbps
Channel separation	802.11b/g/n: 5 MHz
Type of Modulation	802.11b: DSSS (DBPSK, DQPSK, CCK) 802.11g/n: OFDM (BPSK, QPSK, 16QAM, 64QAM)
Antenna Type	PIFA Antenna
Channel Control	Auto
Antenna Gain	Refer to the table "Antenna List"

Antenna List:

No.	Manufacturer	Part No.	Antenna Type	Peak Gain
1	AnJie	AJDP1J-B0006	PIFA	3.62dBi for 2.4 GHz

Note: The antenna of EUT is conforming to FCC 15.203

802.11b/g/n-20MHz Center Frequency of Each Channel:

Channel	Frequency	Channel	Frequency	Channel	Frequency	Channel	Frequency
Channel 01:	2412 MHz	Channel 02:	2417 MHz	Channel 03:	2422 MHz	Channel 04:	2427 MHz
Channel 05:	2432 MHz	Channel 06:	2437 MHz	Channel 07:	2442 MHz	Channel 08:	2447 MHz
Channel 09:	2452 MHz	Channel 10:	2457 MHz	Channel 11:	2462 MHz		

802.11n-40MHz Center Frequency of Each Channel:

Channel	Frequency	Channel	Frequency	Channel	Frequency	Channel	Frequency
Channel 03:	2422 MHz	Channel 04:	2427 MHz	Channel 05:	2432 MHz	Channel 06:	2437 MHz
Channel 07:	2442 MHz	Channel 08:	2447 MHz	Channel 09:	2452 MHz		

Note:

1. The EUT is an WiFi SOM Module, Contains functions on NFC, 2.4G and 5G band WIFI and WWAN with Bluetooth (V5.0 and V3.0+HS, V2.1+EDR) combo card module transceiver, this report for 2.4GHz WLAN.
2. These tests are conducted on a sample for the purpose of demonstrating compliance of transmitter with Part 15 Subpart C Paragraph 15.247 of spread spectrum devices
3. Regarding to the operation frequency, the lowest, middle and highest frequency are selected to perform the test.
4. Lowest and highest data rates are tested in each mode. Only worst case is shown in the report.
5. This is to request a Class II permissive change for FCC ID: 2ABTU-MS01, originally granted on 12/24/2019.

The major change filed under this application is:

Change #1: Addition an new antenna, antenna type is different with the original application.

(Antenna type: PIFA antenna)

#2: Reduce the Output Power through firmware.

Test Mode	Mode 1:802.11b
	Mode 2:802.11g
	Mode 3:802.11n-20
	Mode 4:802.11n-40

1.3. Tested System Details

The types for all equipment, plus descriptions of all cables used in the tested system (including inserted cards) are:

Product	Manufacturer	Model No.	Serial No.	Power Cord	
1	Notebook PC	DELL	Latitude 5580	2HRD7H2	Non-Shielded, 0.8m
2	Test Fixture	RuggON	N/A	N/A	N/A

Signal Cable Type	Signal cable Description	
A	USB Cable	Shielded, 1m
B	Power Cable	Shielded, 1.8m

1.4. Configuration of Tested System

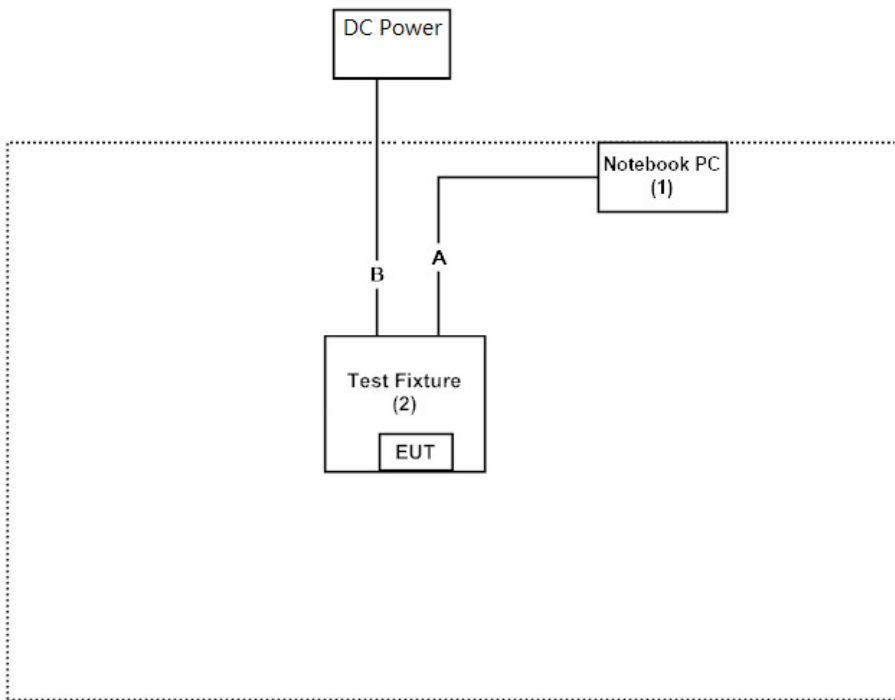

1.5. EUT Exercise Software

- (1) Setup the EUT as shown on 1.4
- (2) Execute software “QRCT V3.0.268.0” on the EUT.
- (3) Configure the test mode, the test channel, and the data rate.
- (4) Start the continuous transmission.
- (5) Verify that the EUT works properly.

Test Facility

Ambient conditions in the laboratory:

Items	Required (IEC 68-1)	Actual
Temperature (°C)	15-35	20-35
Humidity (%RH)	25-75	50-65
Barometric pressure (mbar)	860-1060	950-1000

USA : FCC Registration Number: TW3023

Canada : IC Registration Number: 4075A

Site Description: Accredited by TAF
Accredited Number: 3023

Test Laboratory: DEKRA Testing and Certification Co., Ltd
Address: No.5-22, Ruishukeng, Linkou Dist., New Taipei City 24451,
Taiwan, R.O.C.

Phone number: 886-2-8601-3788

Fax number: 886-2-8601-3789

Email address: info.tw@dekra.com

Website: <http://www.dekra.com.tw>

1.6. List of Test Equipment

For Conducted measurements /CB3/SR8

	Equipment	Manufacturer	Model No.	Serial No.	Cali. Date	Due. Date
	Temperature Chamber	WIT GROUP	TH-1S-B	EQ-201-00146	<u>2019/02/26</u>	2020/02/25
X	Spectrum Analyzer	Agilent	N9010A	MY53470892	2019/09/25	2020/09/24
X	Peak Power Analyzer	Keysight	8990B	MY51000410	2019/07/30	2020/07/29
X	Wideband Power Sensor	Keysight	N1923A	MY56080003	2019/07/30	2020/07/29
X	Wideband Power Sensor	Keysight	N1923A	MY56080004	2019/07/30	2020/07/29
X	EMI Test Receiver	R&S	ESCS 30	100369	<u>2019/11/19</u>	2020/11/18
X	LISN	R&S	ENV216	101105	2019/04/10	2020/04/09
X	LISN	R&S	ESH3-Z5	836679/014	2019/04/10	2020/04/09
X	Coaxial Cable	DEKRA	RG 400	LC018-RG	2019/06/20	2020/06/19

Note:

1. All equipments are calibrated every one year.
2. The test instruments marked with "X" are used to measure the final test results.
3. Test Software version : DEKRA Conduction Test SystemV9.0.5.

For Radiated measurements /Site3/CB8

	Equipment	Manufacturer	Model No.	Serial No.	Cali. Date	Due. Date
X	Spectrum Analyzer	R&S	FSP40	100170	<u>2019/03/11</u>	2020/03/10
X	Loop Antenna	Teseq	HLA6121	37133	2019/10/15	2021/10/14
X	Bilog Antenna	Schaffner Chase	CBL6112B	2794	2019/06/23	2020/06/22
X	Coaxial Cable	DEKRA	L1907-001C	280280.F141.1000D	2019/07/10	2020/07/09
X	Amplifier	EMCI	EMC001330	980254	2019/08/22	2020/08/21
X	Horn Antenna	ETS-LINDGREN	3117	00228113	<u>2019/05/02</u>	2020/05/01
	Coaxial Cable	DEKRA	L1907-002C	280280.F141.1000D	2019/07/10	2020/07/09
X	Amplifier	EMCI	EMC05820SE	980362	2019/06/26	2020/06/25
	Amplifier	EMCI	EMC051845SE	SN980632	2019/08/08	2020/08/07
X	Horn Antenna	Com-Power	AH-1840	101101	2019/10/31	2020/10/30
X	Amplifier + Cable	EMCI	EMC184045SE	980369	2019/04/16	2020/04/15
	Bilog Antenna	Schaffner Chase	CBL6112B	2916	2019/06/23	2020/06/22
	Coaxial Cable	DEKRA	L1907-003C	00100A1B3A120M	2019/07/10	2020/07/09
	Amplifier	EMCI	EMC001330	980255	2019/06/28	2020/06/27
X	Filter	MICRO-TRONICS	BRM50702	G270	2019/08/08	2020/08/07
X	Filter	MICRO-TRONICS	BRM50716	G196	2019/08/08	2020/08/07

Note:

1. Loop Antenna is calibrated every two years, the other equipments are calibrated every one year.
2. The test instruments marked with "X" are used to measure the final test results.
3. Test Software version : DEKRA Test SystemV1.1.

2. Peak Power Output

2.1. Test Setup

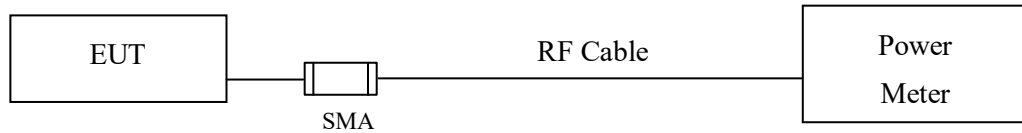

2.2. Limits

The maximum peak power shall be less 1 Watt.

2.3. Test Procedure

The EUT was tested according to DTS test procedure of KDB 558074 for compliance to FCC 47CFR 15.247 requirements. The maximum peak conducted output power using KDB 558074 D01 DTS Meas Guidance v04 section 9.1.3 PKPM1 Peak power meter method.

2.4. Uncertainty

± 1.27 dB

2.5. Test Result of Peak Power Output

Product : WiFi SOM Module
 Test Item : Peak Power Output Data
 Test date : 2019/12/27
 Test Mode : Transmit 802.11b

CHAIN A

Channel No	Frequency (MHz)	Average Power For different Data Rate (Mbps)				Required Limit	Result
		1	2	5.5	11		
		Measurement Level (dBm)					
01	2412	15.23	--	--	--	<30dBm	Pass
02	2417	15.30	15.24	15.20	15.09	<30dBm	Pass
03	2422	15.81	--	--	--	<30dBm	Pass
04	2427	16.94	--	--	--	<30dBm	Pass
06	2437	17.61	--	--	--	<30dBm	Pass
10	2457	17.83	--	--	--	<30dBm	Pass
11	2462	17.82	--	--	--	<30dBm	Pass

Note: Peak Power Output Value = Reading value on power meter + cable loss

CHAIN B

Channel No	Frequency (MHz)	Average Power For different Data Rate (Mbps)				Required Limit	Result
		1	2	5.5	11		
		Measurement Level (dBm)					
01	2412	16.15	--	--	--	<30dBm	Pass
02	2417	16.11	16.05	15.99	15.89	<30dBm	Pass
03	2422	16.39	--	--	--	<30dBm	Pass
04	2427	17.35	--	--	--	<30dBm	Pass
06	2437	18.21	--	--	--	<30dBm	Pass
10	2457	18.12	--	--	--	<30dBm	Pass
11	2462	18.02	--	--	--	<30dBm	Pass

Note: Peak Power Output Value = Reading value on power meter + cable loss

Product : WiFi SOM Module
 Test Item : Peak Power Output Data
 Test date : 2019/12/27
 Test Mode : Transmit 802.11g

CHAIN A

Channel No	Frequency (MHz)	Average Power								Required Limit	Result
		For different Data Rate (Mbps)									
		6	9	12	18	24	36	48	54		
Measurement Level (dBm)											
01	2412	13.27	--	--	--	--	--	--	--	<30dBm	Pass
02	2417	17.00	16.96	16.85	16.72	16.62	16.51	16.42	16.35	<30dBm	Pass
06	2437	17.79	--	--	--	--	--	--	--	<30dBm	Pass
10	2457	17.77	--	--	--	--	--	--	--	<30dBm	Pass
11	2462	16.12	--	--	--	--	--	--	--	<30dBm	Pass

Note: Peak Power Output Value = Reading value on power meter + cable loss

CHAIN B

Channel No	Frequency (MHz)	Average Power								Required Limit	Result
		For different Data Rate (Mbps)									
		6	9	12	18	24	36	48	54		
Measurement Level (dBm)											
01	2412	13.52	--	--	--	--	--	--	--	<30dBm	Pass
02	2417	18.44	18.31	18.20	18.11	17.98	17.87	17.79	17.72	<30dBm	Pass
06	2437	18.22	--	--	--	--	--	--	--	<30dBm	Pass
10	2457	18.13	--	--	--	--	--	--	--	<30dBm	Pass
11	2462	16.31	--	--	--	--	--	--	--	<30dBm	Pass

Note: Peak Power Output Value = Reading value on power meter + cable loss

Product : WiFi SOM Module
 Test Item : Peak Power Output Data
 Test date : 2019/12/27
 Test Mode : Transmit 802.11n20

CHAIN A

Channel No	Frequency (MHz)	Average Power							
		For different Data Rate (Mbps)							
		HT8	HT9	HT10	HT11	HT12	HT13	HT14	HT15
Measurement Level (dBm)									
01	2412	12.17	--	--	--	--	--	--	--
02	2417	16.72	16.68	16.57	16.47	16.44	16.35	16.31	16.28
06	2437	16.69	--	--	--	--	--	--	--
10	2457	16.7	--	--	--	--	--	--	--
11	2462	15.62	--	--	--	--	--	--	--

Note: Peak Power Output Value = Reading value on power meter + cable loss

CHAIN B

Channel No	Frequency (MHz)	Average Power							
		For different Data Rate (Mbps)							
		HT8	HT9	HT10	HT11	HT12	HT13	HT14	HT15
Measurement Level (dBm)									
01	2412	12.52	--	--	--	--	--	--	--
02	2417	17.24	17.21	17.08	17.02	16.89	16.85	16.74	16.65
06	2437	17.16	--	--	--	--	--	--	--
10	2457	16.91	--	--	--	--	--	--	--
11	2462	15.46	--	--	--	--	--	--	--

Note: Peak Power Output Value = Reading value on power meter + cable loss

CHAIN A+B

Channel	Frequency (MHz)	Data Rate (Mbps)	Chain A Power (dBm)	Chain B Power (dBm)	Chain A+B Power (dBm)	Limit (dBm)	Result
01	2412	HT8	12.17	12.52	15.36	<30dBm	Pass
02	2417	HT8	16.72	17.24	20.00	<30dBm	Pass
06	2437	HT8	16.69	17.16	19.94	<30dBm	Pass
10	2457	HT8	16.70	16.91	19.82	<30dBm	Pass
11	2462	HT8	15.62	15.46	18.55	<30dBm	Pass

Note: Peak Power Output Value (dBm) = 10*LOG (Chain A (mW)+ Chain B (mW))

Product : WiFi SOM Module
 Test Item : Peak Power Output Data
 Test date : 2019/12/27
 Test Mode : Transmit 802.11n40

CHAIN A

Channel No	Frequency (MHz)	Average Power								
		For different Data Rate (Mbps)								
		HT8	HT9	HT10	HT11	HT12	HT13	HT14	HT15	
Measurement Level (dBm)										
03	2422	13.42	--	--	--	--	--	--	--	--
04	2427	15.47	15.37	15.31	15.27	15.16	15.05	14.98	14.85	
05	2432	16.37	--	--	--	--	--	--	--	--
06	2437	16.61	--	--	--	--	--	--	--	--
07	2442	15.92	--	--	--	--	--	--	--	--
08	2447	13.64	--	--	--	--	--	--	--	--
09	2452	14.21	--	--	--	--	--	--	--	--

Note: Peak Power Output Value = Reading value on power meter + cable loss

CHAIN B

Channel No	Frequency (MHz)	Average Power								
		For different Data Rate (Mbps)								
		HT8	HT9	HT10	HT11	HT12	HT13	HT14	HT15	
Measurement Level (dBm)										
03	2422	13.89	--	--	--	--	--	--	--	--
04	2427	15.85	15.75	15.70	15.62	15.53	15.49	15.38	15.31	
05	2432	16.77	--	--	--	--	--	--	--	--
06	2437	17.12	--	--	--	--	--	--	--	--
07	2442	16.26	--	--	--	--	--	--	--	--
08	2447	14.43	--	--	--	--	--	--	--	--
09	2452	14.72	--	--	--	--	--	--	--	--

Note: Peak Power Output Value = Reading value on power meter + cable loss

CHAIN A+B

Channel	Frequency (MHz)	Data Rate (Mbps)	Chain A Power (dBm)	Chain B Power (dBm)	Chain A+B Power (dBm)	Limit (dBm)	Result
03	2422	HT8	13.42	13.89	16.67	<30dBm	Pass
04	2427	HT8	15.47	15.85	18.67	<30dBm	Pass
05	2432	HT8	16.37	16.77	19.58	<30dBm	Pass
06	2437	HT8	16.61	17.12	19.88	<30dBm	Pass
07	2442	HT8	15.92	16.26	19.10	<30dBm	Pass
08	2447	HT8	13.64	14.43	17.06	<30dBm	Pass
09	2452	HT8	14.21	14.72	17.48	<30dBm	Pass

Note: Peak Power Output Value (dBm) = 10*LOG (Chain A (mW)+ Chain B (mW))

3. Radiated Emission

3.1. Test Setup

Under 30MHz

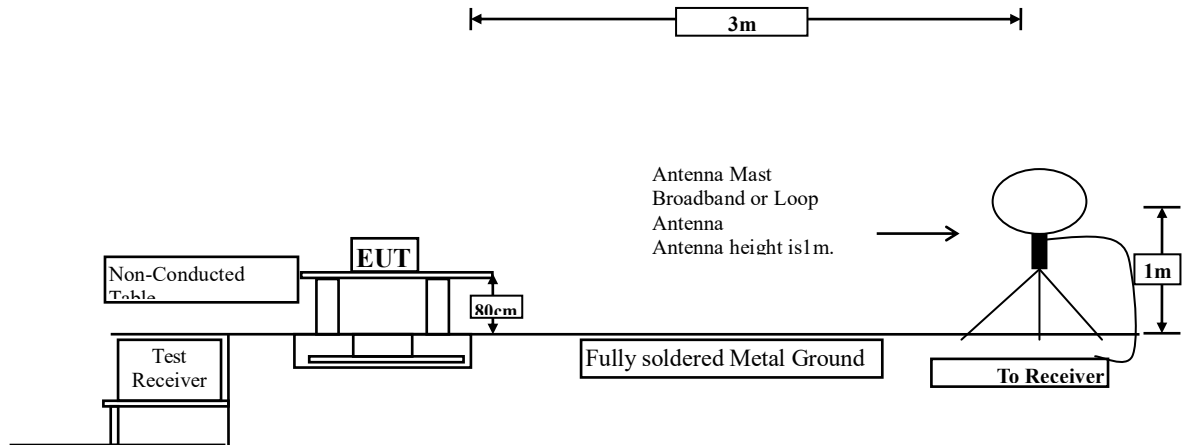

Below 1GHz

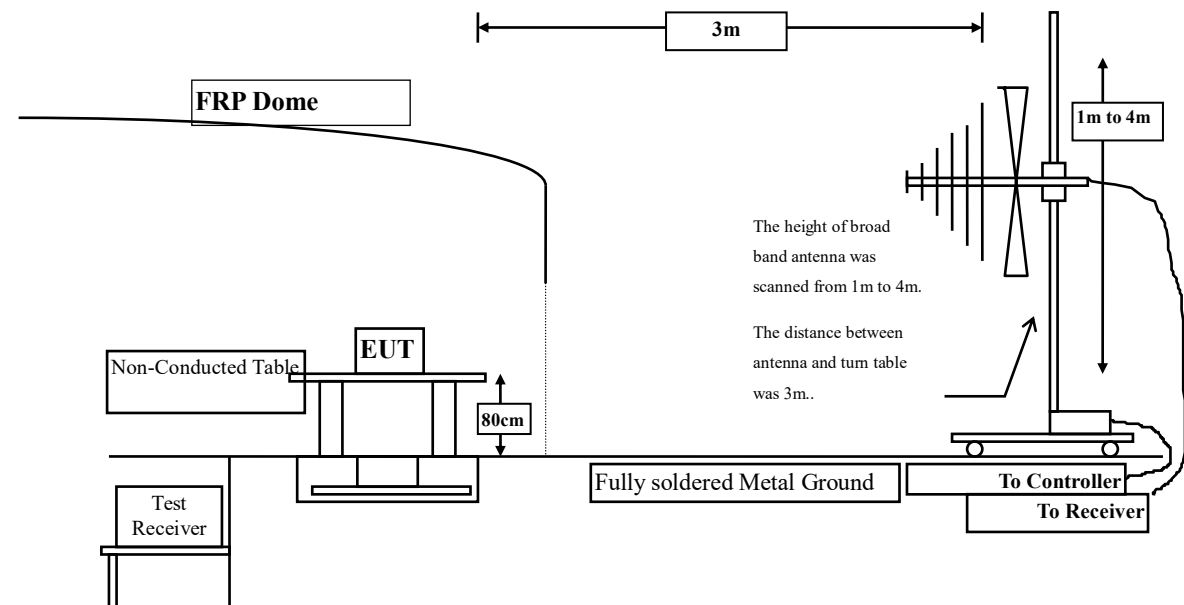

Above 1GHz

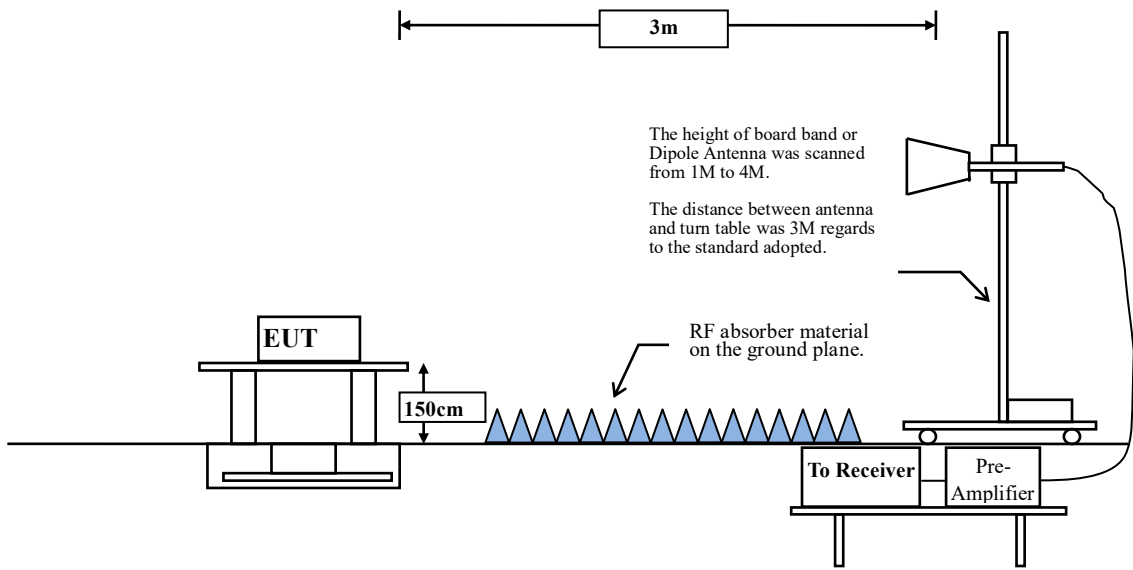

3.2. Limits

Emissions radiated outside of the specified frequency bands, except for harmonics, shall be attenuated by at least 20dB below the level of the fundamental or to the general radiated emission limits in paragraph 15.209, whichever is the lesser attenuation.

FCC Part 15 Subpart C Paragraph 15.209(a) Limits		
Frequency MHz	Field strength (microvolts/meter)	Measurement distance (meter)
0.009-0.490	2400/F(kHz)	300
0.490-1.705	24000/F(kHz)	30
1.705-30	30	30
30-88	100	3
88-216	150	3
216-960	200	3
Above 960	500	3

Remarks: E field strength (dBuV/m) = 20 log E field strength (uV/m)

3.3. Test Procedure

The EUT was setup according to ANSI C63.10: 2013 and tested according to DTS test procedure of KDB558074 for compliance to FCC 47CFR 15.247 requirements.

Measuring the frequency range below 1GHz, the EUT is placed on a turn table which is 0.8 meter above ground, when measuring the frequency range above 1GHz, the EUT is placed on a turn table which is 1.5 meter above ground.

The turn table is rotated 360 degrees to determine the position of the maximum emission level.

The EUT was positioned such that the distance from antenna to the EUT was 3 meters.

The antenna is scanned between 1 meter and 4 meters to find out the maximum emission level. This is repeated for both horizontal and vertical polarization of the antenna. In order to find the maximum emission, all of the interface cables were manipulated according to ANSI C63.10: 2013 on radiated measurement.

The resolution bandwidth below 30MHz setting on the field strength meter is 9kHz and 30MHz~1GHz is 120kHz and above 1GHz is 1MHz.

Radiated emission measurements below 30MHz are made using Loop Antenna and 30MHz~1GHz are made using broadband Bilog antenna and above 1GHz are made using Horn Antennas.

The measurement is divided into the Preliminary Measurement and the Final Measurement.

The suspected frequencies are searched for in Preliminary Measurement with the measurement antenna kept pointed at the source of the emission both in azimuth and elevation, with the polarization of the antenna oriented for maximum response. The antenna is pointed at an angle towards the source of the emission, and the EUT is rotated in both height and polarization to maximize the measured emission. The emission is kept within the illumination area of the 3 dB bandwidth of the antenna.

The worst radiated emission is measured in the Open Area Test Site on the Final Measurement.

The measurement frequency range from 9kHz - 10th Harmonic of fundamental was investigated.

RBW and VBW Parameter setting:

According to KDB 558074 Peak power measurement procedure

RBW = as specified in Table 1.

$VBW \geq 3 \times RBW$.

Table 1 —RBW as a function of frequency

Frequency	RBW
9-150 kHz	200-300 Hz
0.15-30 MHz	9-10 kHz
30-1000 MHz	100-120 kHz
> 1000 MHz	1 MHz

According to KDB 558074 Average power measurement procedure

RBW = 1MHz.

$VBW = 10\text{Hz}$, when duty cycle $\geq 98\%$

$VBW \geq 1/T$, when duty cycle $< 98\%$

(T refers to the minimum transmission duration over which the transmitter is on and is transmitting at its maximum power control level for the tested mode of operation.)

2.4GHz band	Duty Cycle (%)	T (ms)	1/T (Hz)	VBW (Hz)
802.11b	98.83	12.3180	81	--
802.11g	94.63	2.0435	489	500
802.11 n20	89.33	0.9710	1030	2000
802.11 n40	83.74	0.4928	2029	3000

Note: Duty Cycle Refer to Section 5

3.4. Uncertainty

± 4.08 dB above 1GHz

± 4.22 dB below 1GHz

3.5. Test Result of Radiated Emission

Product : WiFi SOM Module
 Test Item : Harmonic Radiated Emission Data
 Test Date : 2019/12/31
 Test Mode : Mode 1:802.11b (2412MHz)

Horizontal

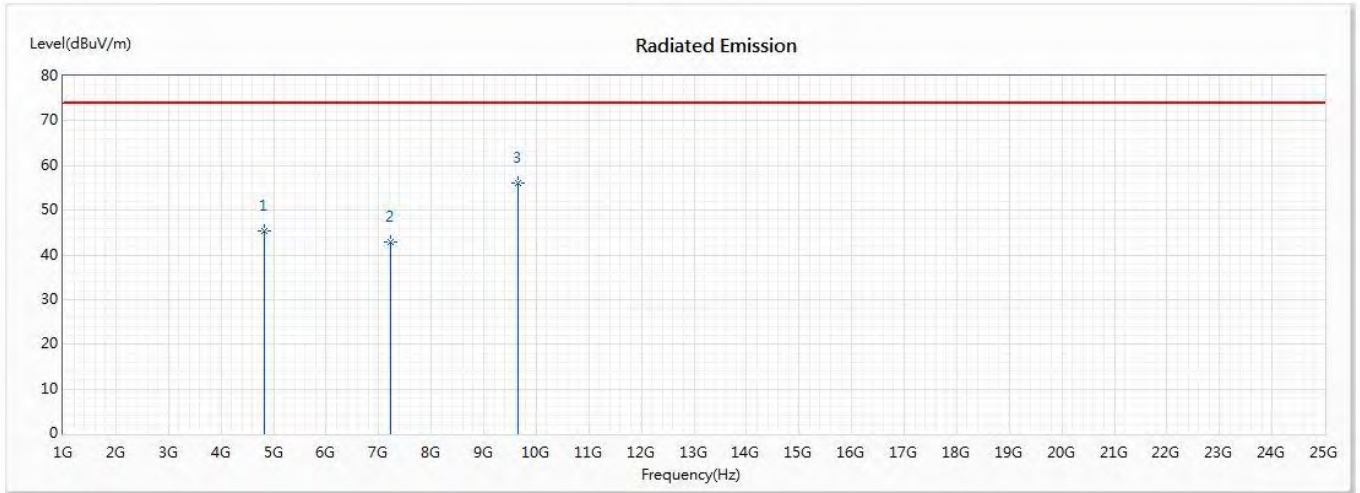

No	Frequency (MHz)	Emission Level (dBuV/m)	Limit (dBuV/m)	Margin (dB)	Reading Level (dBuV)	Correct Factor (dB/m)	Detector Type
1	4824	45.49	74.00	-28.51	57.48	-11.99	PK
2	7236	42.77	74.00	-31.23	55.73	-12.96	PK
* 3	9648	56.03	74.00	-17.97	69.13	-13.10	PK

Note:

1. All Readings below 1GHz are Quasi-Peak, above 1GHz are performed with peak and/or average measurements as necessary.
2. Measurement Level = Reading Level + Correct Factor.
3. Correct Factor = Antenna factor + Cable loss – Amplifier gain.
4. The average measurement was not performed when the peak measured data under the limit of average detection.
5. The emission levels of other frequencies are very lower than the limit and not show in test report.

Product : WiFi SOM Module
 Test Item : Harmonic Radiated Emission Data
 Test Date : 2019/12/31
 Test Mode : Mode 1:802.11b (2412MHz)

Horizontal

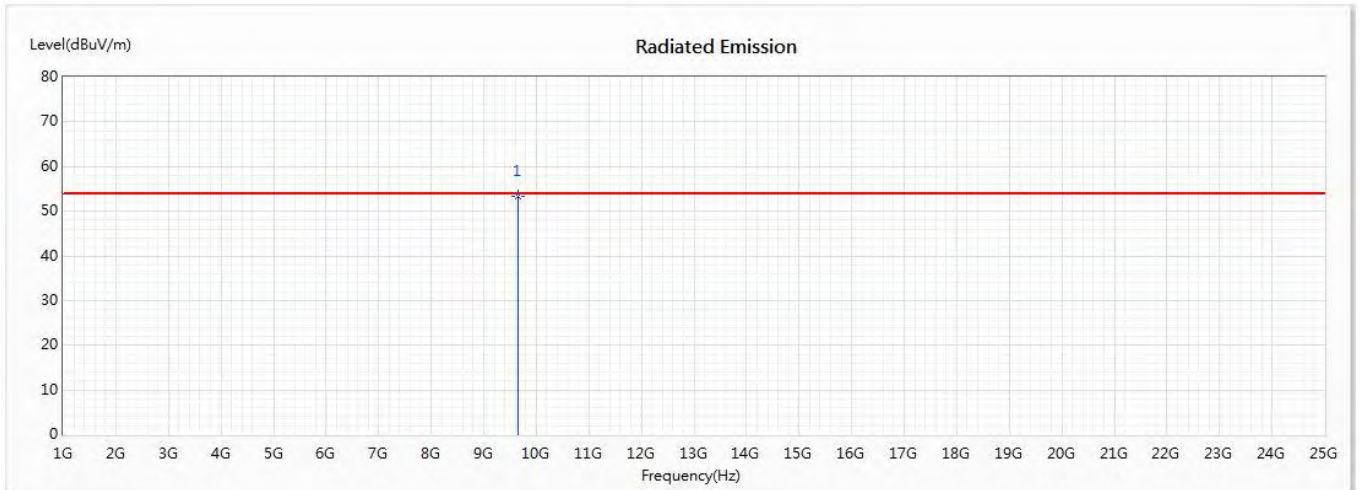

No	Frequency (MHz)	Emission Level (dBuV/m)	Limit (dBuV/m)	Margin (dB)	Reading Level (dBuV)	Correct Factor (dB/m)	Detector Type
* 1	9648	53.26	54.00	-0.74	66.36	-13.10	AV

Note:

1. All Readings below 1GHz are Quasi-Peak, above 1GHz are performed with peak and/or average measurements as necessary.
2. Measurement Level = Reading Level + Correct Factor.
3. Correct Factor = Antenna factor + Cable loss – Amplifier gain.
4. The average measurement was not performed when the peak measured data under the limit of average detection.
5. The emission levels of other frequencies are very lower than the limit and not show in test report.

Product : WiFi SOM Module
 Test Item : Harmonic Radiated Emission Data
 Test Date : 2019/12/31
 Test Mode : Mode 1:802.11b (2412MHz)

Vertical

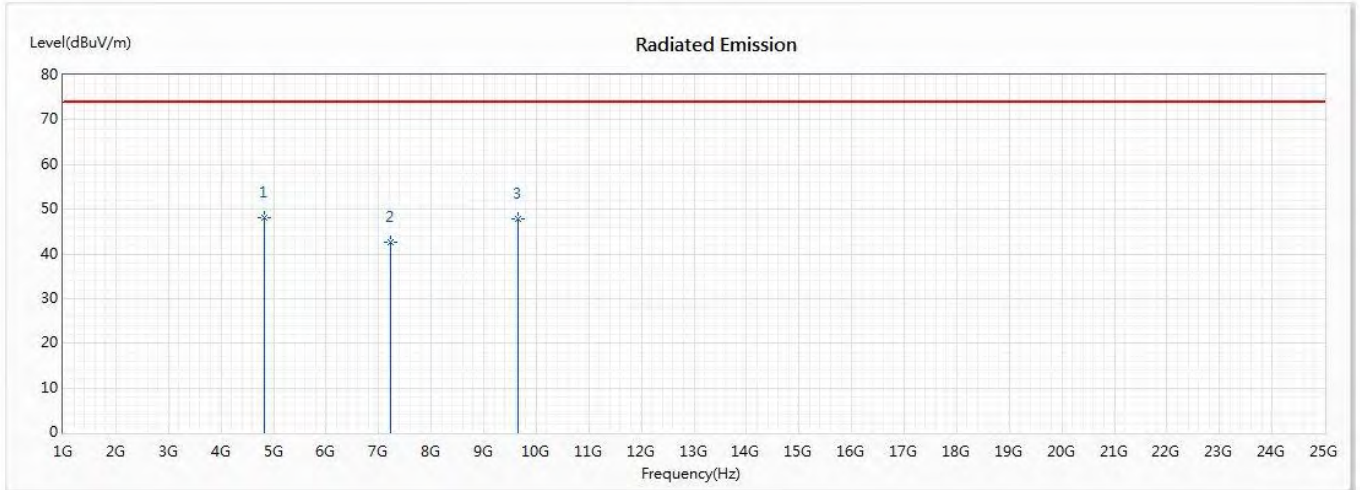

No	Frequency (MHz)	Emission Level (dBuV/m)	Limit (dBuV/m)	Margin (dB)	Reading Level (dBuV)	Correct Factor (dB/m)	Detector Type
* 1	4824	48.20	74.00	-25.80	60.19	-11.99	PK
2	7236	42.72	74.00	-31.28	55.68	-12.96	PK
3	9648	47.83	74.00	-26.17	60.93	-13.10	PK

Note:

1. All Readings below 1GHz are Quasi-Peak, above 1GHz are performed with peak and/or average measurements as necessary.
2. Measurement Level = Reading Level + Correct Factor.
3. Correct Factor = Antenna factor + Cable loss – Amplifier gain.
4. The average measurement was not performed when the peak measured data under the limit of average detection.
5. The emission levels of other frequencies are very lower than the limit and not show in test report.

Product : WiFi SOM Module
 Test Item : Harmonic Radiated Emission Data
 Test Date : 2019/12/31
 Test Mode : Mode 1:802.11b (2417 MHz)

Horizontal

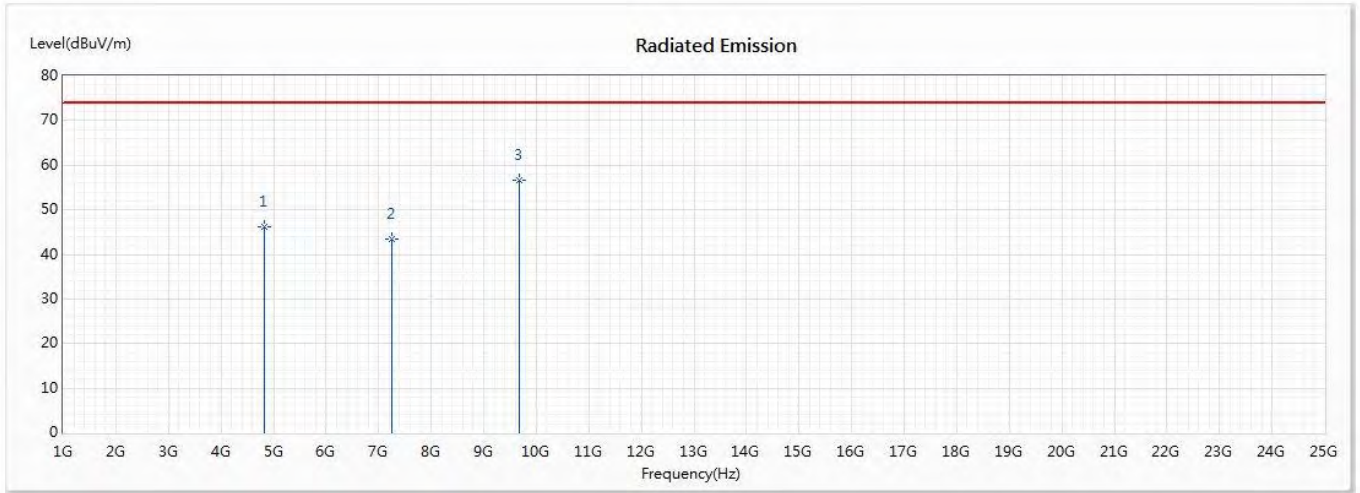

No	Frequency (MHz)	Emission Level (dBuV/m)	Limit (dBuV/m)	Margin (dB)	Reading Level (dBuV)	Correct Factor (dB/m)	Detector Type
1	4834	46.07	74.00	-27.93	57.98	-11.91	PK
2	7251	43.35	74.00	-30.65	56.23	-12.88	PK
* 3	9668	56.69	74.00	-17.31	69.63	-12.94	PK

Note:

1. All Readings below 1GHz are Quasi-Peak, above 1GHz are performed with peak and/or average measurements as necessary.
2. Measurement Level = Reading Level + Correct Factor.
3. Correct Factor = Antenna factor + Cable loss – Amplifier gain.
4. The average measurement was not performed when the peak measured data under the limit of average detection.
5. The emission levels of other frequencies are very lower than the limit and not show in test report.

Product : WiFi SOM Module
 Test Item : Harmonic Radiated Emission Data
 Test Date : 2019/12/31
 Test Mode : Mode 1:802.11b (2417 MHz)

Horizontal

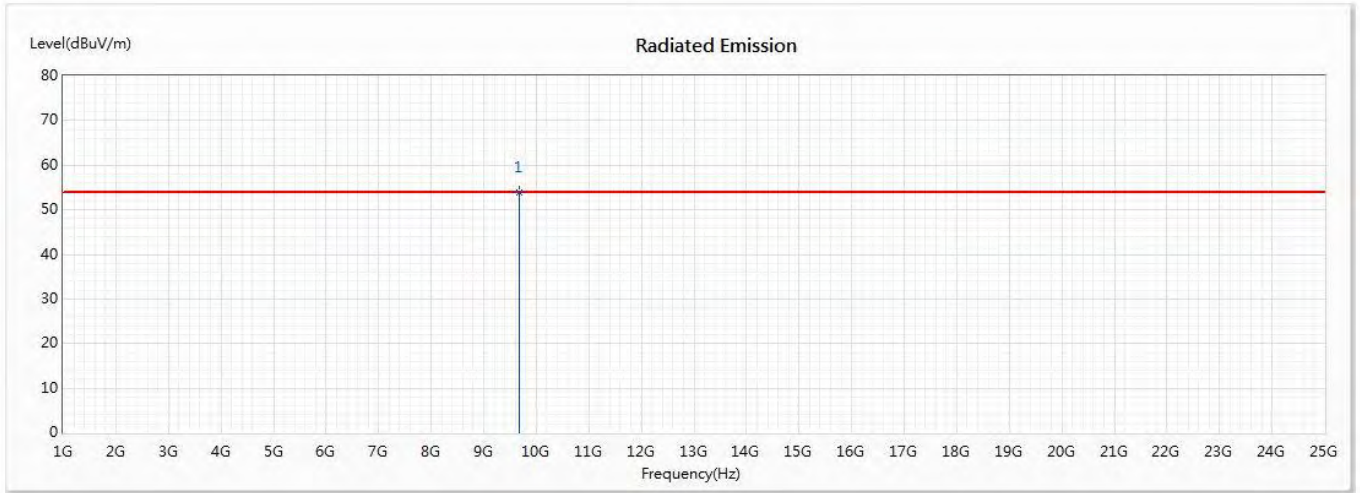

No	Frequency (MHz)	Emission Level (dBuV/m)	Limit (dBuV/m)	Margin (dB)	Reading Level (dBuV)	Correct Factor (dB/m)	Detector Type
* 1	9668	53.78	54.00	-0.22	66.72	-12.94	AV

Note:

1. All Readings below 1GHz are Quasi-Peak, above 1GHz are performed with peak and/or average measurements as necessary.
2. Measurement Level = Reading Level + Correct Factor.
3. Correct Factor = Antenna factor + Cable loss – Amplifier gain.
4. The average measurement was not performed when the peak measured data under the limit of average detection.
5. The emission levels of other frequencies are very lower than the limit and not show in test report.

Product : WiFi SOM Module
 Test Item : Harmonic Radiated Emission Data
 Test Date : 2019/12/31
 Test Mode : Mode 1:802.11b (2417 MHz)

Vertical

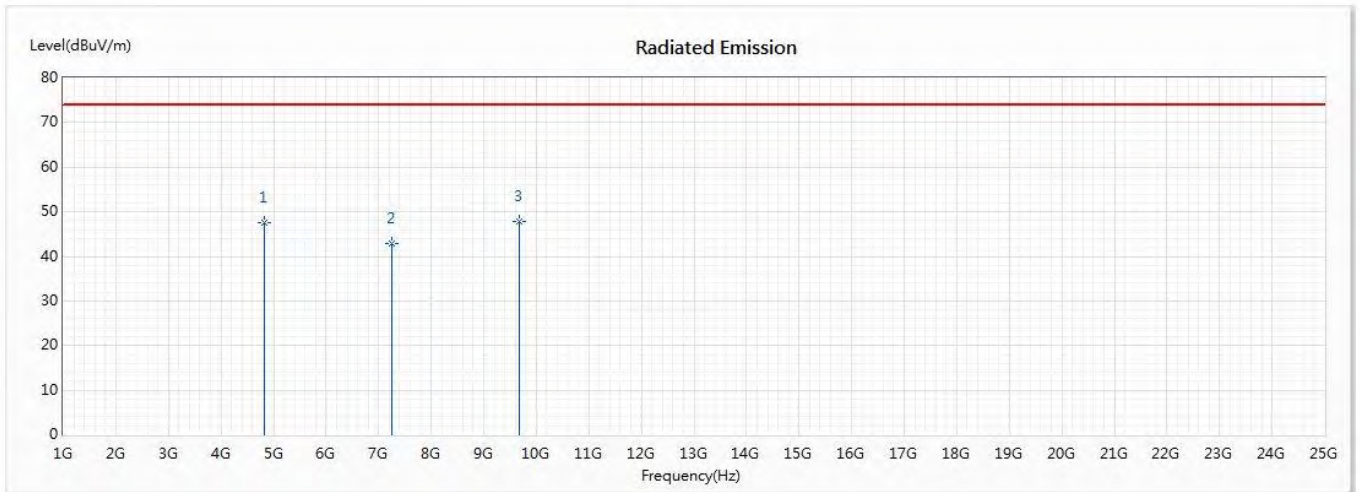

No	Frequency (MHz)	Emission Level (dBuV/m)	Limit (dBuV/m)	Margin (dB)	Reading Level (dBuV)	Correct Factor (dB/m)	Detector Type
1	4834	47.43	74.00	-26.57	59.34	-11.91	PK
2	7251	42.87	74.00	-31.13	55.75	-12.88	PK
* 3	9668	47.88	74.00	-26.12	60.82	-12.94	PK

Note:

1. All Readings below 1GHz are Quasi-Peak, above 1GHz are performed with peak and/or average measurements as necessary.
2. Measurement Level = Reading Level + Correct Factor.
3. Correct Factor = Antenna factor + Cable loss – Amplifier gain.
4. The average measurement was not performed when the peak measured data under the limit of average detection.
5. The emission levels of other frequencies are very lower than the limit and not show in test report.

Product : WiFi SOM Module
 Test Item : Harmonic Radiated Emission Data
 Test Date : 2019/12/31
 Test Mode : Mode 1:802.11b (2422 MHz)

Horizontal

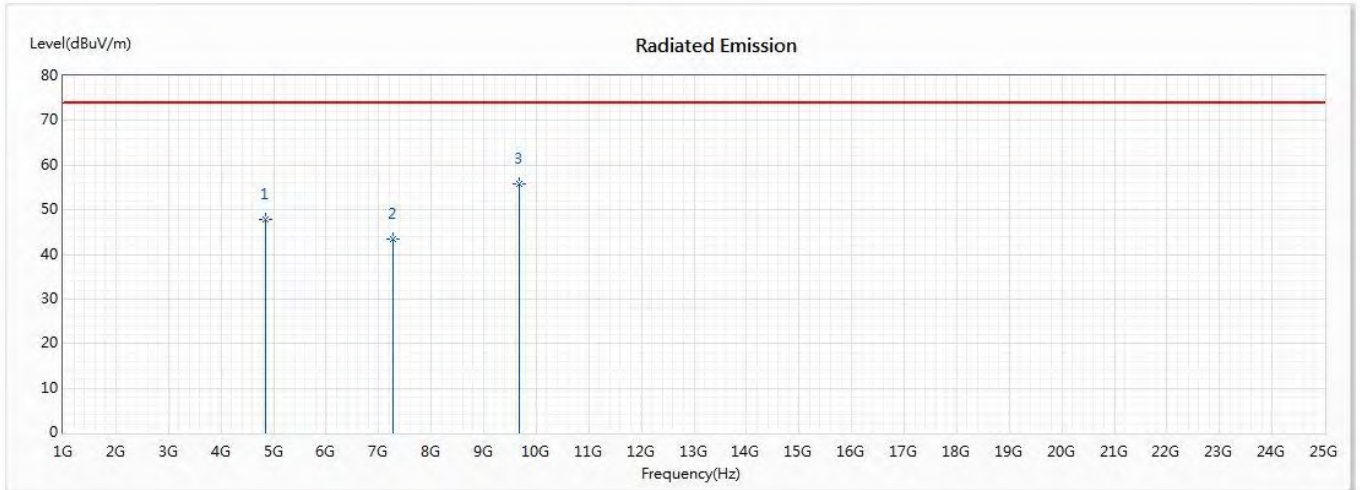

No	Frequency (MHz)	Emission Level (dBuV/m)	Limit (dBuV/m)	Margin (dB)	Reading Level (dBuV)	Correct Factor (dB/m)	Detector Type
1	4844	47.80	74.00	-26.20	59.63	-11.83	PK
2	7266	43.39	74.00	-30.61	56.42	-13.03	PK
* 3	9688	55.79	74.00	-18.21	68.57	-12.78	PK

Note:

1. All Readings below 1GHz are Quasi-Peak, above 1GHz are performed with peak and/or average measurements as necessary.
2. Measurement Level = Reading Level + Correct Factor.
3. Correct Factor = Antenna factor + Cable loss – Amplifier gain.
4. The average measurement was not performed when the peak measured data under the limit of average detection.
5. The emission levels of other frequencies are very lower than the limit and not show in test report.

Product : WiFi SOM Module
 Test Item : Harmonic Radiated Emission Data
 Test Date : 2019/12/31
 Test Mode : Mode 1:802.11b (2422 MHz)

Horizontal

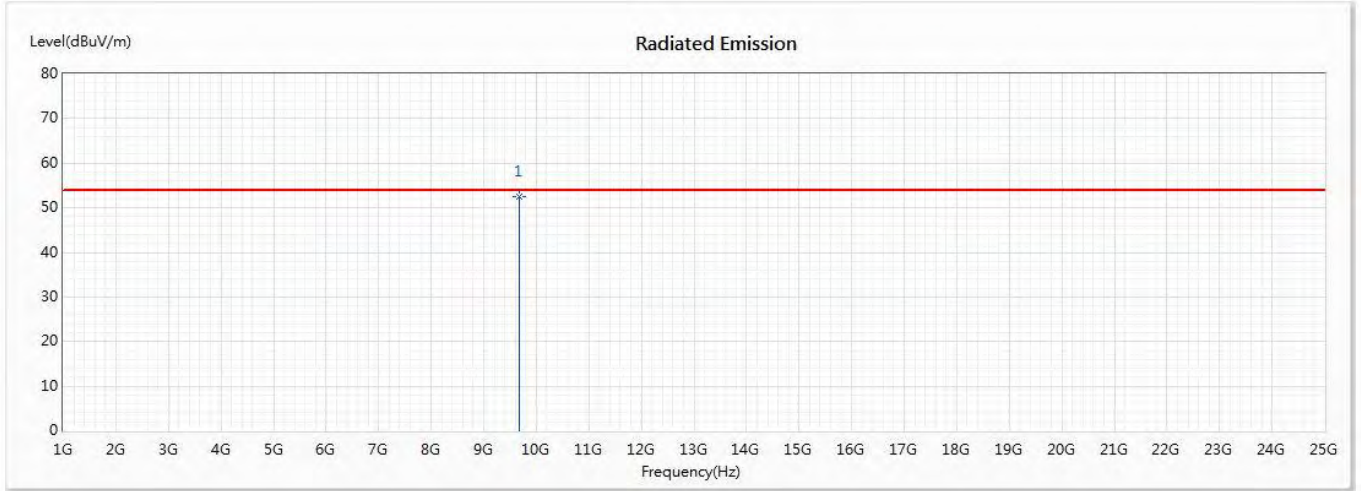

No	Frequency (MHz)	Emission Level (dBuV/m)	Limit (dBuV/m)	Margin (dB)	Reading Level (dBuV)	Correct Factor (dB/m)	Detector Type
* 1	9688	52.61	54.00	-1.39	65.39	-12.78	AV

Note:

1. All Readings below 1GHz are Quasi-Peak, above 1GHz are performed with peak and/or average measurements as necessary.
2. Measurement Level = Reading Level + Correct Factor.
3. Correct Factor = Antenna factor + Cable loss –Amplifier gain.
4. The average measurement was not performed when the peak measured data under the limit of average detection.
5. The emission levels of other frequencies are very lower than the limit and not show in test report.

Product : WiFi SOM Module
 Test Item : Harmonic Radiated Emission Data
 Test Date : 2019/12/31
 Test Mode : Mode 1:802.11b (2422 MHz)

Vertical

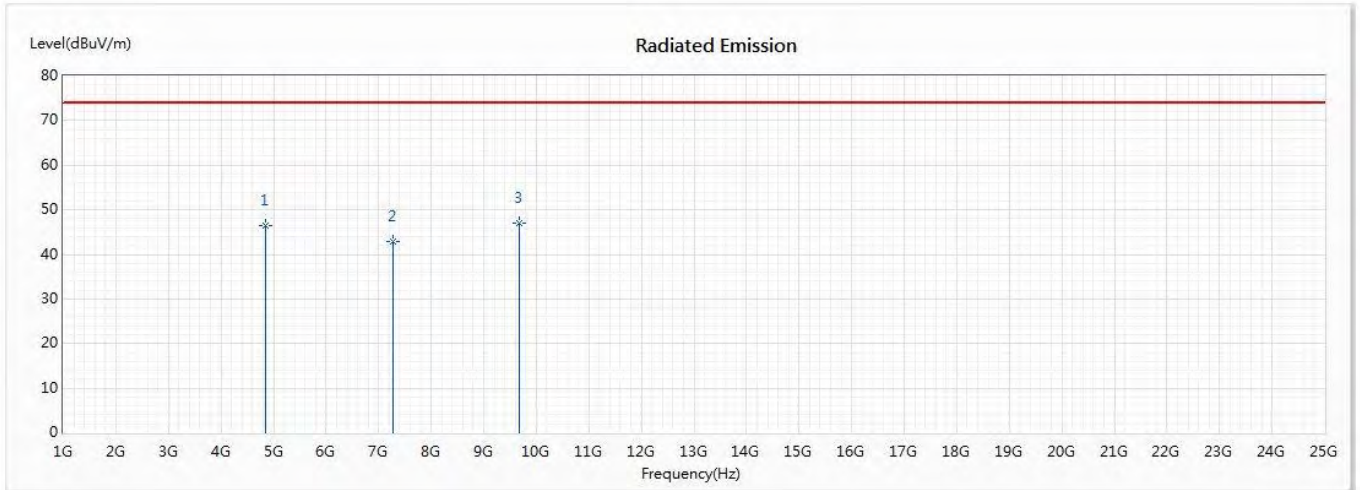

No	Frequency (MHz)	Emission Level (dBuV/m)	Limit (dBuV/m)	Margin (dB)	Reading Level (dBuV)	Correct Factor (dB/m)	Detector Type
1	4844	46.39	74.00	-27.61	58.22	-11.83	AV
2	7266	42.86	74.00	-31.14	55.89	-13.03	AV
* 3	9688	46.97	74.00	-27.03	59.75	-12.78	PK

Note:

1. All Readings below 1GHz are Quasi-Peak, above 1GHz are performed with peak and/or average measurements as necessary.
2. Measurement Level = Reading Level + Correct Factor.
3. Correct Factor = Antenna factor + Cable loss – Amplifier gain.
4. The average measurement was not performed when the peak measured data under the limit of average detection.
5. The emission levels of other frequencies are very lower than the limit and not show in test report.

Product : WiFi SOM Module
 Test Item : Harmonic Radiated Emission Data
 Test Date : 2019/12/31
 Test Mode : Mode 1:802.11b (2427 MHz)

Horizontal

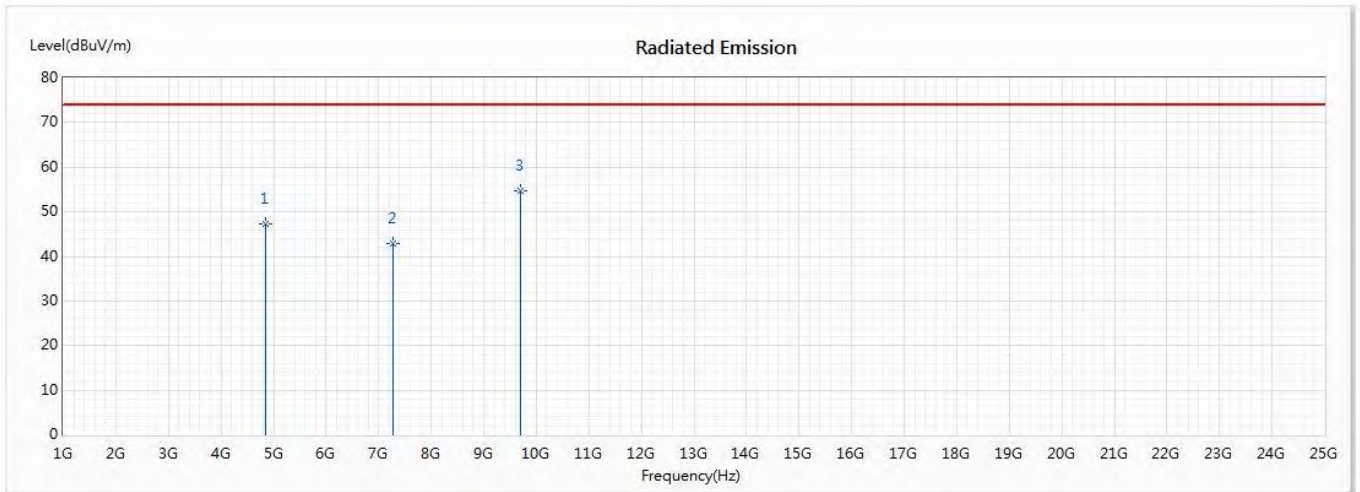

No	Frequency (MHz)	Emission Level (dBuV/m)	Limit (dBuV/m)	Margin (dB)	Reading Level (dBuV)	Correct Factor (dB/m)	Detector Type
1	4854	47.29	74.00	-26.71	59.05	-11.76	PK
2	7281	42.97	74.00	-31.03	56.15	-13.18	PK
* 3	9708	54.80	74.00	-19.20	67.43	-12.63	PK

Note:

1. All Readings below 1GHz are Quasi-Peak, above 1GHz are performed with peak and/or average measurements as necessary.
2. Measurement Level = Reading Level + Correct Factor.
3. Correct Factor = Antenna factor + Cable loss – Amplifier gain.
4. The average measurement was not performed when the peak measured data under the limit of average detection.
5. The emission levels of other frequencies are very lower than the limit and not show in test report.

Product : WiFi SOM Module
 Test Item : Harmonic Radiated Emission Data
 Test Date : 2019/12/31
 Test Mode : Mode 1:802.11b (2427 MHz)

Horizontal

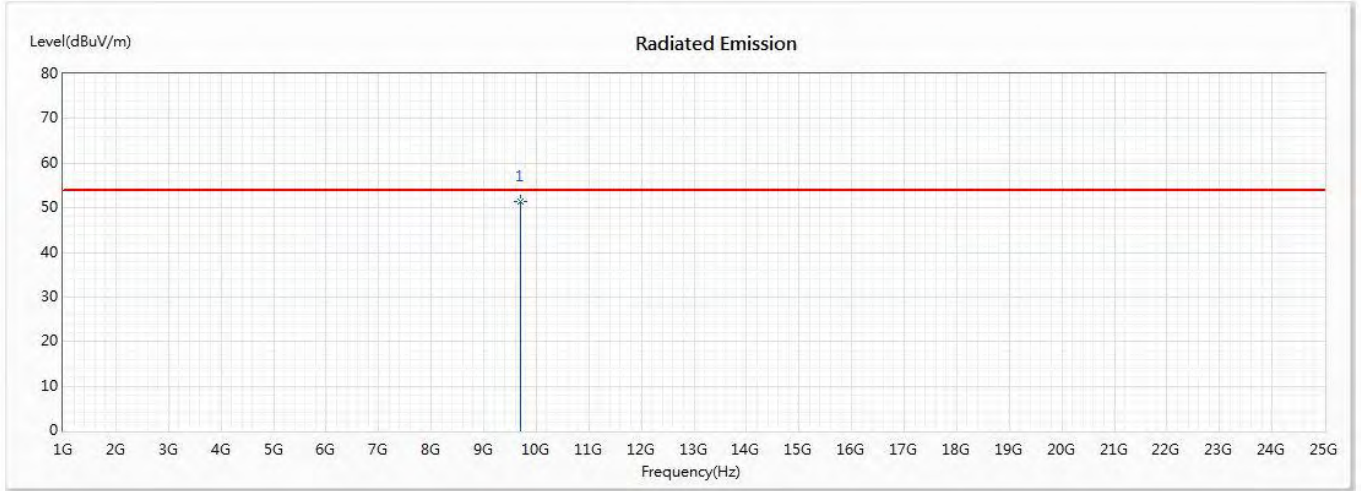

No	Frequency (MHz)	Emission Level (dBuV/m)	Limit (dBuV/m)	Margin (dB)	Reading Level (dBuV)	Correct Factor (dB/m)	Detector Type
* 1	9708	51.40	54.00	-2.60	64.03	-12.63	AV

Note:

1. All Readings below 1GHz are Quasi-Peak, above 1GHz are performed with peak and/or average measurements as necessary.
2. Measurement Level = Reading Level + Correct Factor.
3. Correct Factor = Antenna factor + Cable loss – Amplifier gain.
4. The average measurement was not performed when the peak measured data under the limit of average detection.
5. The emission levels of other frequencies are very lower than the limit and not show in test report.

Product : WiFi SOM Module
 Test Item : Harmonic Radiated Emission Data
 Test Date : 2019/12/31
 Test Mode : Mode 1:802.11b (2427 MHz)

Vertical

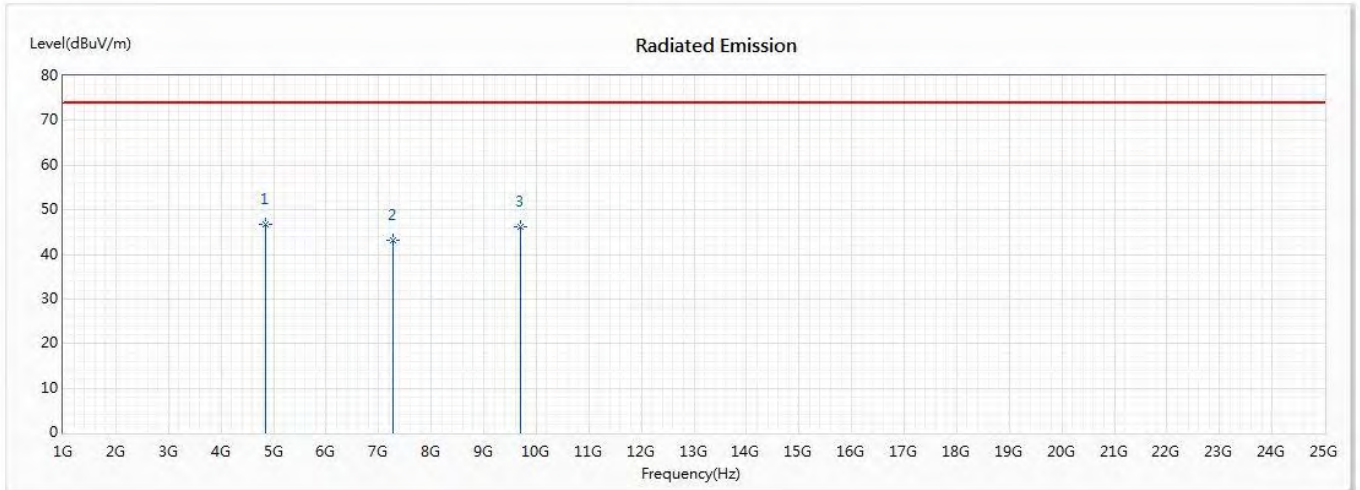

No	Frequency (MHz)	Emission Level (dBuV/m)	Limit (dBuV/m)	Margin (dB)	Reading Level (dBuV)	Correct Factor (dB/m)	Detector Type
* 1	4854	46.70	74.00	-27.30	58.46	-11.76	PK
2	7281	43.28	74.00	-30.72	56.46	-13.18	PK
3	9708	46.30	74.00	-27.70	58.93	-12.63	PK

Note:

1. All Readings below 1GHz are Quasi-Peak, above 1GHz are performed with peak and/or average measurements as necessary.
2. Measurement Level = Reading Level + Correct Factor.
3. Correct Factor = Antenna factor + Cable loss – Amplifier gain.
4. The average measurement was not performed when the peak measured data under the limit of average detection.
5. The emission levels of other frequencies are very lower than the limit and not show in test report.

Product : WiFi SOM Module
 Test Item : Harmonic Radiated Emission Data
 Test Date : 2019/12/31
 Test Mode : Mode 1:802.11b (2437 MHz)

Horizontal

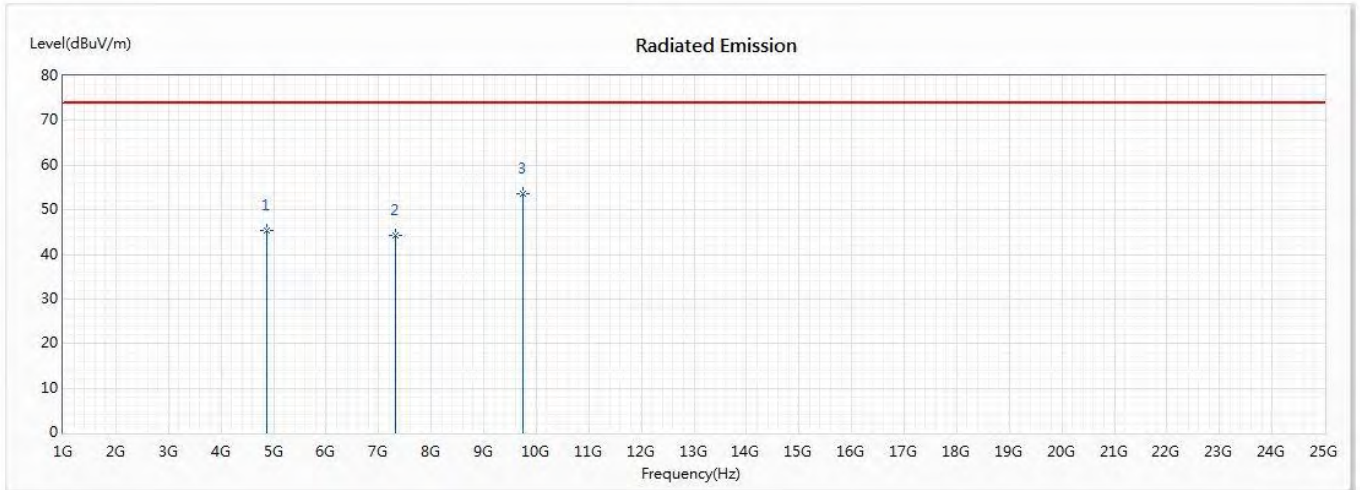

No	Frequency (MHz)	Emission Level (dBuV/m)	Limit (dBuV/m)	Margin (dB)	Reading Level (dBuV)	Correct Factor (dB/m)	Detector Type
1	4874	45.28	74.00	-28.72	56.92	-11.64	PK
2	7311	44.34	74.00	-29.66	57.82	-13.48	PK
* 3	9748	53.48	74.00	-20.52	65.87	-12.39	PK

Note:

1. All Readings below 1GHz are Quasi-Peak, above 1GHz are performed with peak and/or average measurements as necessary.
2. Measurement Level = Reading Level + Correct Factor.
3. Correct Factor = Antenna factor + Cable loss – Amplifier gain.
4. The average measurement was not performed when the peak measured data under the limit of average detection.
5. The emission levels of other frequencies are very lower than the limit and not show in test report.

Product : WiFi SOM Module
 Test Item : Harmonic Radiated Emission Data
 Test Date : 2019/12/31
 Test Mode : Mode 1:802.11b (2437 MHz)

Vertical

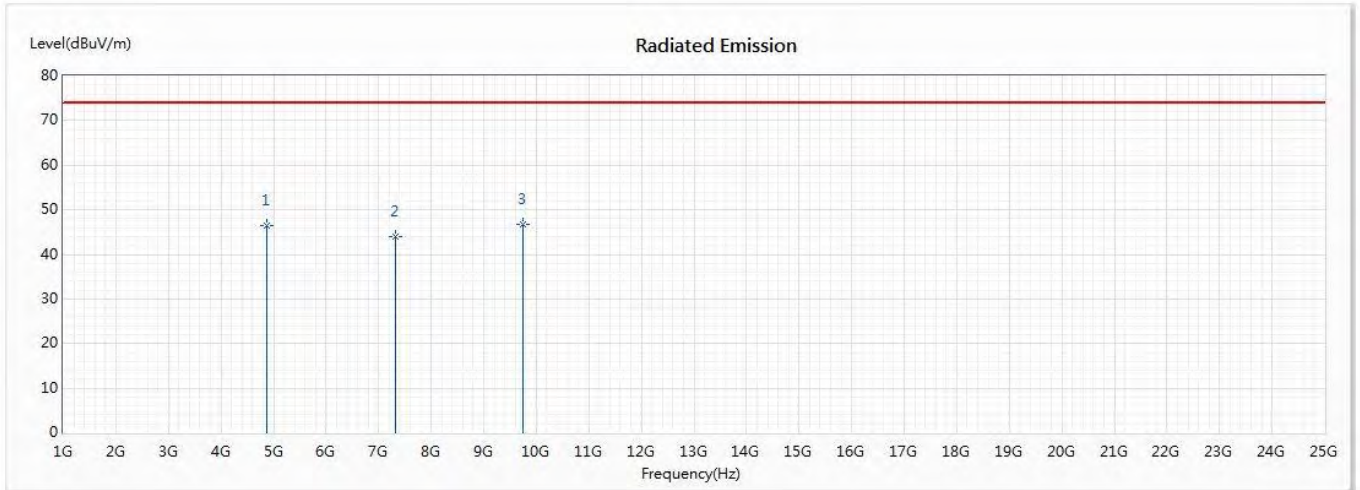

No	Frequency (MHz)	Emission Level (dBuV/m)	Limit (dBuV/m)	Margin (dB)	Reading Level (dBuV)	Correct Factor (dB/m)	Detector Type
1	4874	46.45	74.00	-27.55	58.09	-11.64	PK
2	7311	43.99	74.00	-30.01	57.47	-13.48	PK
* 3	9748	46.71	74.00	-27.29	59.10	-12.39	PK

Note:

1. All Readings below 1GHz are Quasi-Peak, above 1GHz are performed with peak and/or average measurements as necessary.
2. Measurement Level = Reading Level + Correct Factor.
3. Correct Factor = Antenna factor + Cable loss – Amplifier gain.
4. The average measurement was not performed when the peak measured data under the limit of average detection.
5. The emission levels of other frequencies are very lower than the limit and not show in test report.

Product : WiFi SOM Module
 Test Item : Harmonic Radiated Emission Data
 Test Date : 2019/12/31
 Test Mode : Mode 1:802.11b (2457 MHz)

Horizontal

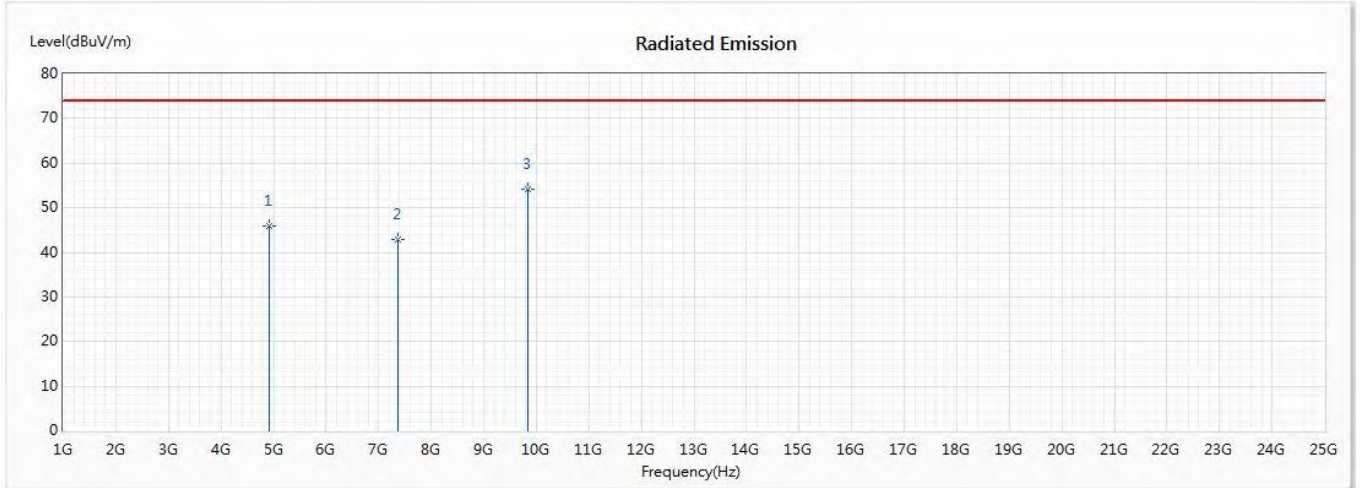

No	Frequency (MHz)	Emission Level (dBuV/m)	Limit (dBuV/m)	Margin (dB)	Reading Level (dBuV)	Correct Factor (dB/m)	Detector Type
1	4914	45.99	74.00	-28.01	57.33	-11.34	PK
2	7371	42.81	74.00	-31.19	56.79	-13.98	PK
* 3	9828	54.18	74.00	-19.82	67.41	-13.23	PK

Note:

1. All Readings below 1GHz are Quasi-Peak, above 1GHz are performed with peak and/or average measurements as necessary.
2. Measurement Level = Reading Level + Correct Factor.
3. Correct Factor = Antenna factor + Cable loss – Amplifier gain.
4. The average measurement was not performed when the peak measured data under the limit of average detection.
5. The emission levels of other frequencies are very lower than the limit and not show in test report.

Product : WiFi SOM Module
 Test Item : Harmonic Radiated Emission Data
 Test Date : 2019/12/31
 Test Mode : Mode 1:802.11b (2457 MHz)

Horizontal

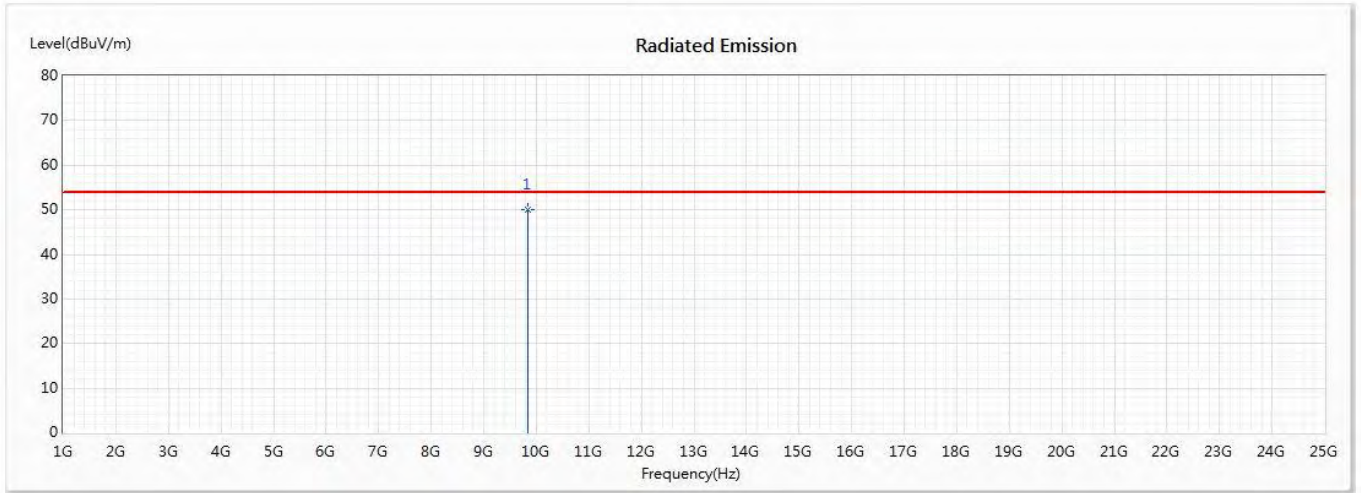

No	Frequency (MHz)	Emission Level (dBuV/m)	Limit (dBuV/m)	Margin (dB)	Reading Level (dBuV)	Correct Factor (dB/m)	Detector Type
* 1	9828	49.97	54.00	-4.03	63.20	-13.23	AV

Note:

1. All Readings below 1GHz are Quasi-Peak, above 1GHz are performed with peak and/or average measurements as necessary.
2. Measurement Level = Reading Level + Correct Factor.
3. Correct Factor = Antenna factor + Cable loss –Amplifier gain.
4. The average measurement was not performed when the peak measured data under the limit of average detection.
5. The emission levels of other frequencies are very lower than the limit and not show in test report.

Product : WiFi SOM Module
 Test Item : Harmonic Radiated Emission Data
 Test Date : 2019/12/31
 Test Mode : Mode 1:802.11b (2457 MHz)

Vertical

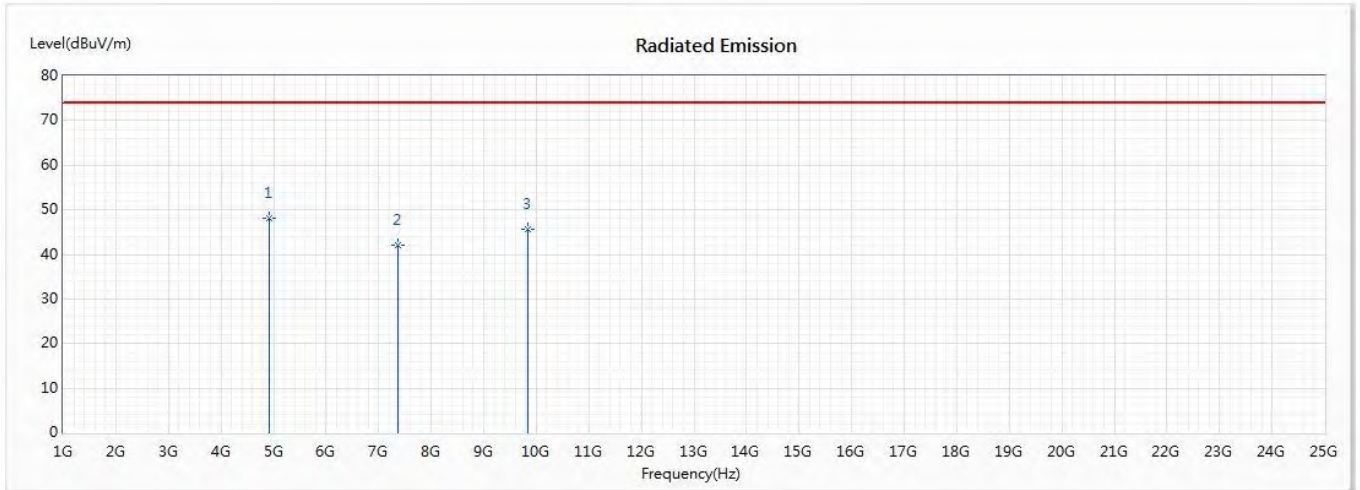

No	Frequency (MHz)	Emission Level (dBuV/m)	Limit (dBuV/m)	Margin (dB)	Reading Level (dBuV)	Correct Factor (dB/m)	Detector Type
* 1	4914	48.09	74.00	-25.91	59.43	-11.34	PK
2	7371	42.01	74.00	-31.99	55.99	-13.98	PK
3	9828	45.58	74.00	-28.42	58.81	-13.23	PK

Note:

1. All Readings below 1GHz are Quasi-Peak, above 1GHz are performed with peak and/or average measurements as necessary.
2. Measurement Level = Reading Level + Correct Factor.
3. Correct Factor = Antenna factor + Cable loss – Amplifier gain.
4. The average measurement was not performed when the peak measured data under the limit of average detection.
5. The emission levels of other frequencies are very lower than the limit and not show in test report.

Product : WiFi SOM Module
 Test Item : Harmonic Radiated Emission Data
 Test Date : 2019/12/31
 Test Mode : Mode 1:802.11b (2462 MHz)

Horizontal

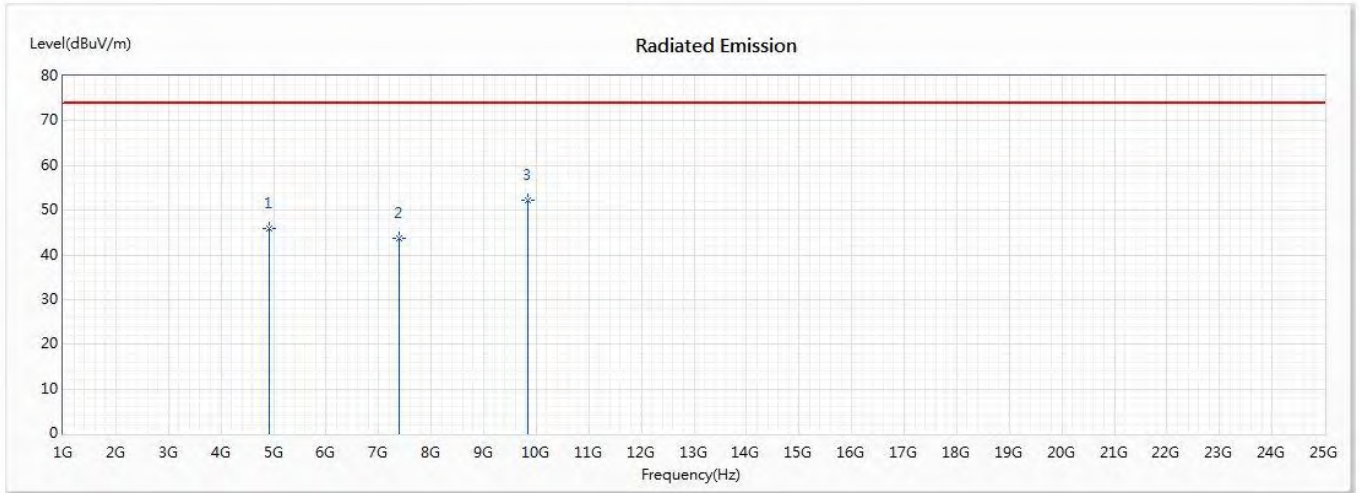

No	Frequency (MHz)	Emission Level (dBuV/m)	Limit (dBuV/m)	Margin (dB)	Reading Level (dBuV)	Correct Factor (dB/m)	Detector Type
1	4924	46.04	74.00	-27.96	57.28	-11.24	PK
2	7386	43.63	74.00	-30.37	57.73	-14.10	PK
* 3	9848	52.25	74.00	-21.75	65.69	-13.44	PK

Note:

1. All Readings below 1GHz are Quasi-Peak, above 1GHz are performed with peak and/or average measurements as necessary.
2. Measurement Level = Reading Level + Correct Factor.
3. Correct Factor = Antenna factor + Cable loss – Amplifier gain.
4. The average measurement was not performed when the peak measured data under the limit of average detection.
5. The emission levels of other frequencies are very lower than the limit and not show in test report.

Product : WiFi SOM Module
 Test Item : Harmonic Radiated Emission Data
 Test Date : 2019/12/31
 Test Mode : Mode 1:802.11b (2462 MHz)

Vertical

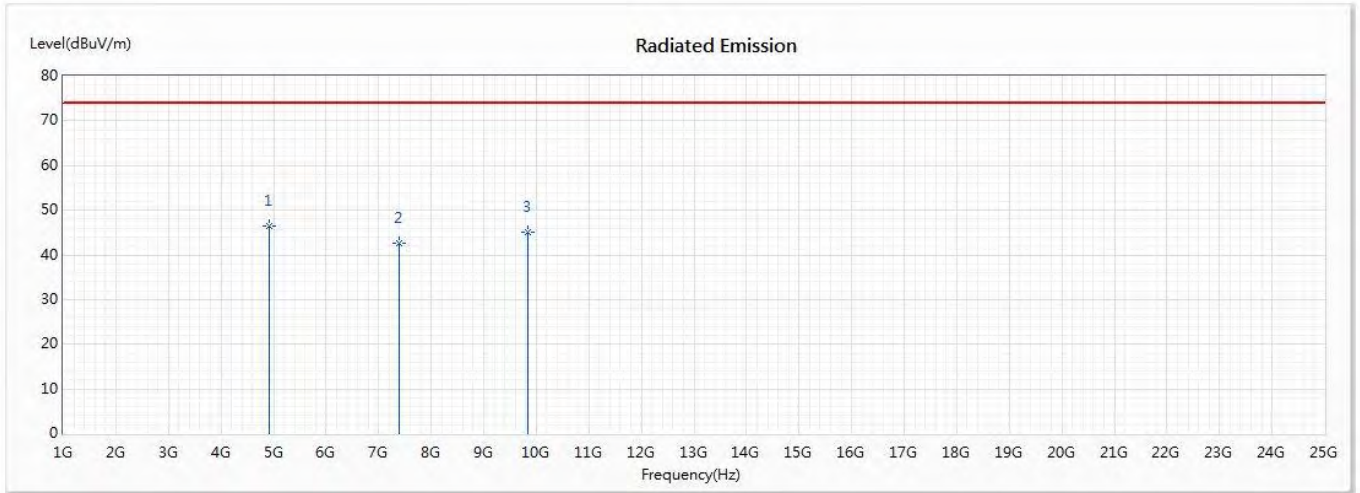

No	Frequency (MHz)	Emission Level (dBuV/m)	Limit (dBuV/m)	Margin (dB)	Reading Level (dBuV)	Correct Factor (dB/m)	Detector Type
* 1	4924	46.38	74.00	-27.62	57.62	-11.24	PK
2	7386	42.61	74.00	-31.39	56.71	-14.10	PK
3	9848	45.06	74.00	-28.94	58.50	-13.44	PK

Note:

1. All Readings below 1GHz are Quasi-Peak, above 1GHz are performed with peak and/or average measurements as necessary.
2. Measurement Level = Reading Level + Correct Factor.
3. Correct Factor = Antenna factor + Cable loss – Amplifier gain.
4. The average measurement was not performed when the peak measured data under the limit of average detection.
5. The emission levels of other frequencies are very lower than the limit and not show in test report.

Product : WiFi SOM Module
 Test Item : Harmonic Radiated Emission Data
 Test Date : 2019/12/31
 Test Mode : Mode 2:802.11g (2412 MHz)

Horizontal

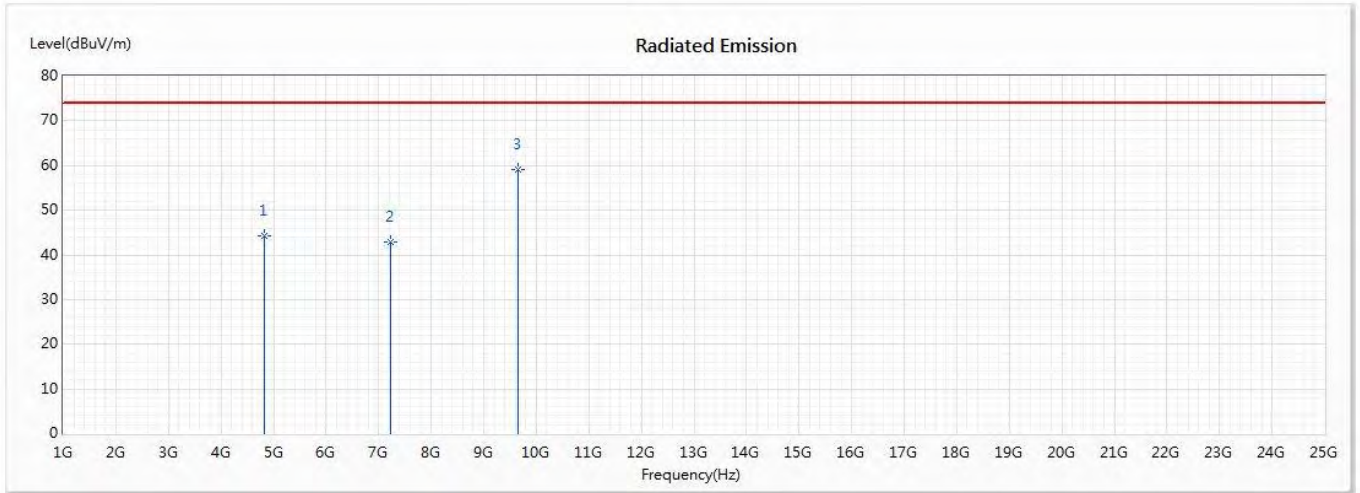

No	Frequency (MHz)	Emission Level (dBuV/m)	Limit (dBuV/m)	Margin (dB)	Reading Level (dBuV)	Correct Factor (dB/m)	Detector Type
1	4824	44.36	74.00	-29.64	56.35	-11.99	PK
2	7236	42.87	74.00	-31.13	55.83	-12.96	PK
* 3	9648	58.97	74.00	-15.03	72.07	-13.10	PK

Note:

1. All Readings below 1GHz are Quasi-Peak, above 1GHz are performed with peak and/or average measurements as necessary.
2. Measurement Level = Reading Level + Correct Factor.
3. Correct Factor = Antenna factor + Cable loss – Amplifier gain.
4. The average measurement was not performed when the peak measured data under the limit of average detection.
5. The emission levels of other frequencies are very lower than the limit and not show in test report.

Product : WiFi SOM Module
 Test Item : Harmonic Radiated Emission Data
 Test Date : 2019/12/31
 Test Mode : Mode 2:802.11g (2412 MHz)

Horizontal

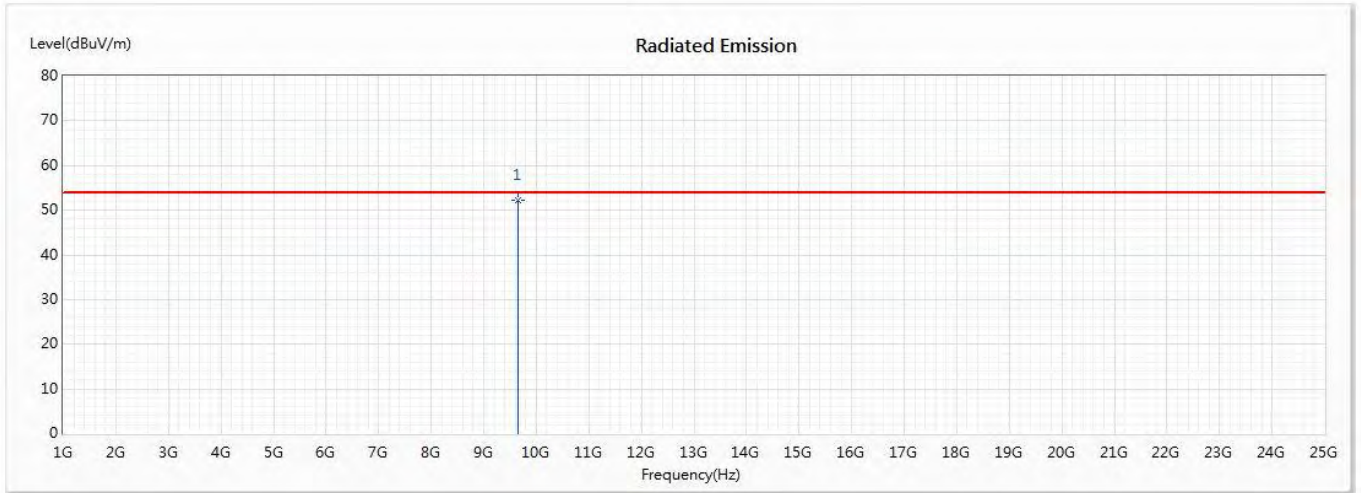

No	Frequency (MHz)	Emission Level (dBuV/m)	Limit (dBuV/m)	Margin (dB)	Reading Level (dBuV)	Correct Factor (dB/m)	Detector Type
* 1	9648	52.27	54.00	-1.73	65.37	-13.10	AV

Note:

1. All Readings below 1GHz are Quasi-Peak, above 1GHz are performed with peak and/or average measurements as necessary.
2. Measurement Level = Reading Level + Correct Factor.
3. Correct Factor = Antenna factor + Cable loss –Amplifier gain.
4. The average measurement was not performed when the peak measured data under the limit of average detection.
5. The emission levels of other frequencies are very lower than the limit and not show in test report.

Product : WiFi SOM Module
 Test Item : Harmonic Radiated Emission Data
 Test Date : 2019/12/31
 Test Mode : Mode 2:802.11g (2412 MHz)

Vertical

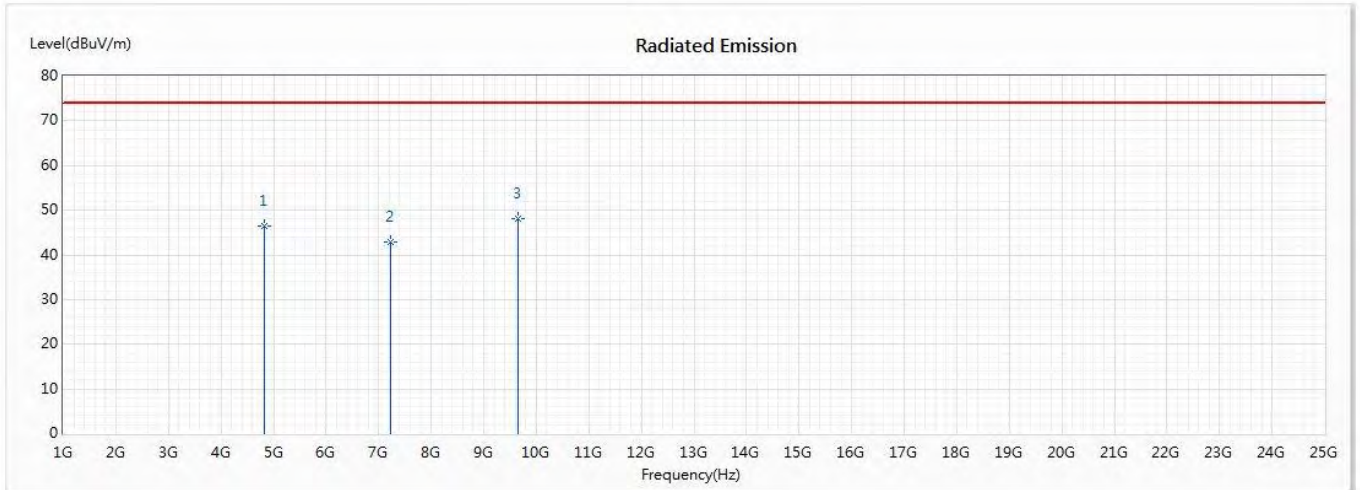

No	Frequency (MHz)	Emission Level (dBuV/m)	Limit (dBuV/m)	Margin (dB)	Reading Level (dBuV)	Correct Factor (dB/m)	Detector Type
1	4824	46.37	74.00	-27.63	58.36	-11.99	PK
2	7236	42.78	74.00	-31.22	55.74	-12.96	PK
* 3	9648	48.07	74.00	-25.93	61.17	-13.10	PK

Note:

1. All Readings below 1GHz are Quasi-Peak, above 1GHz are performed with peak and/or average measurements as necessary.
2. Measurement Level = Reading Level + Correct Factor.
3. Correct Factor = Antenna factor + Cable loss – Amplifier gain.
4. The average measurement was not performed when the peak measured data under the limit of average detection.
5. The emission levels of other frequencies are very lower than the limit and not show in test report.

Product : WiFi SOM Module
 Test Item : Harmonic Radiated Emission Data
 Test Date : 2019/12/31
 Test Mode : Mode 2:802.11g (2417 MHz)

Horizontal

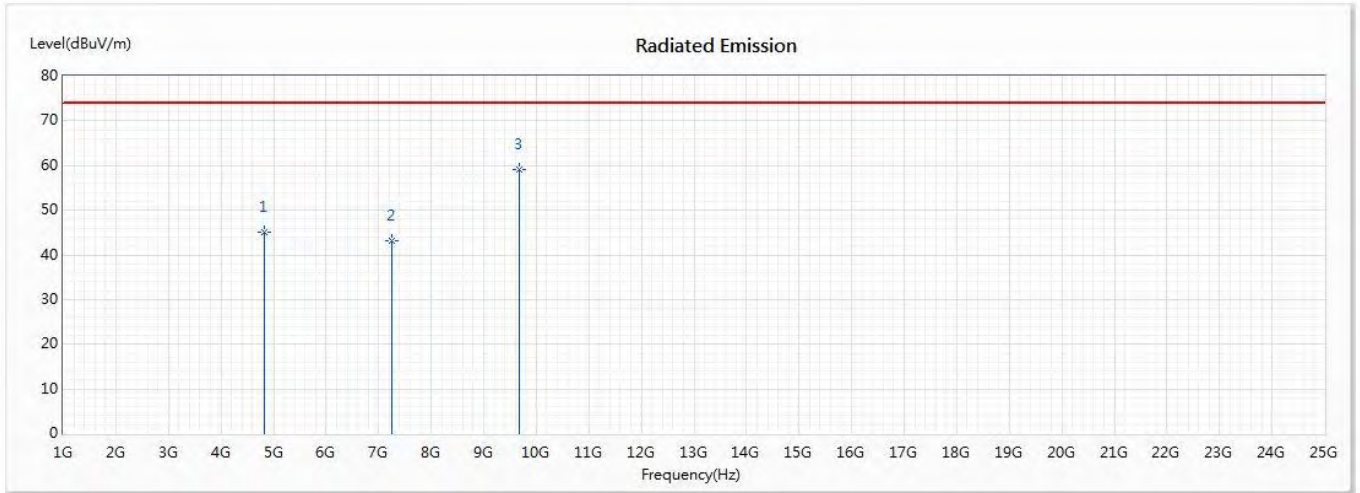

No	Frequency (MHz)	Emission Level (dBuV/m)	Limit (dBuV/m)	Margin (dB)	Reading Level (dBuV)	Correct Factor (dB/m)	Detector Type
1	4834	45.01	74.00	-28.99	56.92	-11.91	PK
2	7251	43.14	74.00	-30.86	56.02	-12.88	PK
* 3	9668	58.98	74.00	-15.02	71.92	-12.94	PK

Note:

1. All Readings below 1GHz are Quasi-Peak, above 1GHz are performed with peak and/or average measurements as necessary.
2. Measurement Level = Reading Level + Correct Factor.
3. Correct Factor = Antenna factor + Cable loss – Amplifier gain.
4. The average measurement was not performed when the peak measured data under the limit of average detection.
5. The emission levels of other frequencies are very lower than the limit and not show in test report.

Product : WiFi SOM Module
 Test Item : Harmonic Radiated Emission Data
 Test Date : 2019/12/31
 Test Mode : Mode 2:802.11g (2417 MHz)

Horizontal

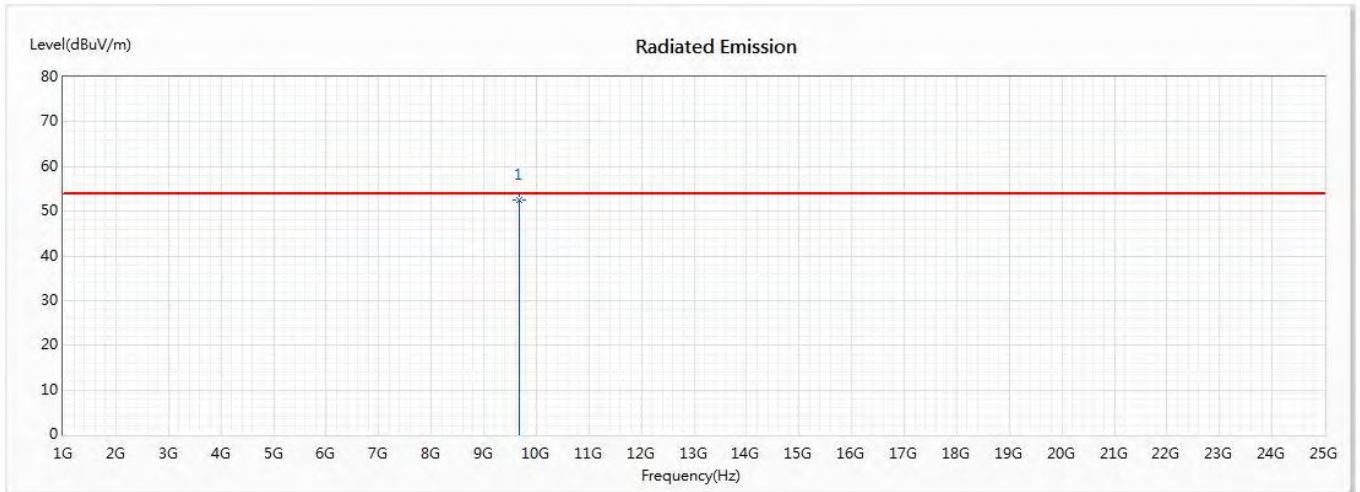

No	Frequency (MHz)	Emission Level (dBuV/m)	Limit (dBuV/m)	Margin (dB)	Reading Level (dBuV)	Correct Factor (dB/m)	Detector Type
* 1	9668	52.48	54.00	-1.52	65.42	-12.94	AV

Note:

1. All Readings below 1GHz are Quasi-Peak, above 1GHz are performed with peak and/or average measurements as necessary.
2. Measurement Level = Reading Level + Correct Factor.
3. Correct Factor = Antenna factor + Cable loss – Amplifier gain.
4. The average measurement was not performed when the peak measured data under the limit of average detection.
5. The emission levels of other frequencies are very lower than the limit and not show in test report.

Product : WiFi SOM Module
 Test Item : Harmonic Radiated Emission Data
 Test Date : 2019/12/31
 Test Mode : Mode 2:802.11g (2417 MHz)

Vertical

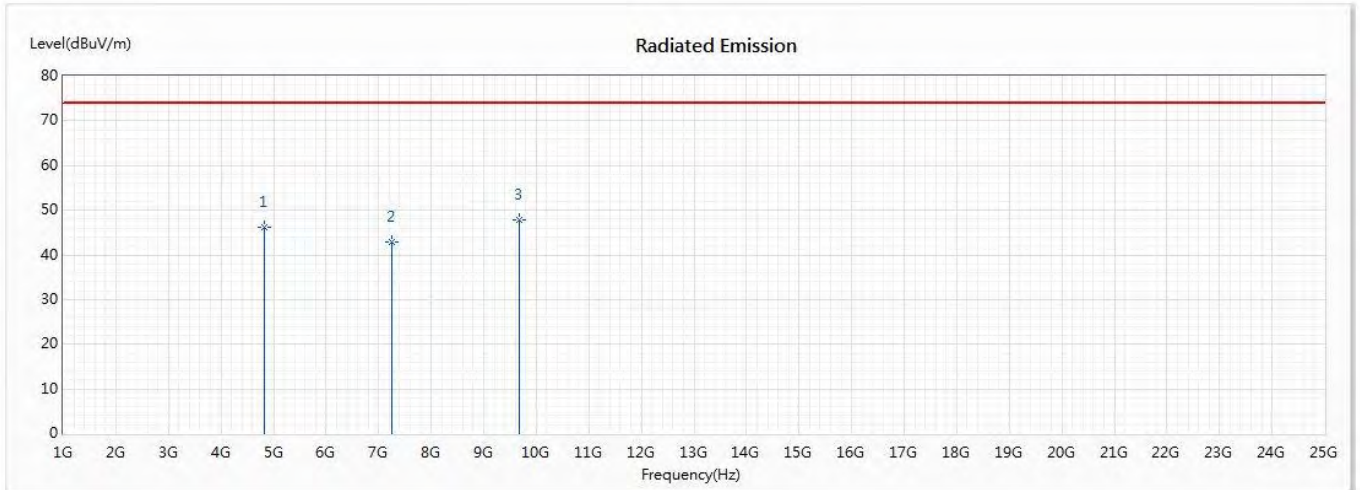

No	Frequency (MHz)	Emission Level (dBuV/m)	Limit (dBuV/m)	Margin (dB)	Reading Level (dBuV)	Correct Factor (dB/m)	Detector Type
1	4834	46.22	74.00	-27.78	58.13	-11.91	PK
2	7251	42.75	74.00	-31.25	55.63	-12.88	PK
* 3	9668	47.82	74.00	-26.18	60.76	-12.94	PK

Note:

1. All Readings below 1GHz are Quasi-Peak, above 1GHz are performed with peak and/or average measurements as necessary.
2. Measurement Level = Reading Level + Correct Factor.
3. Correct Factor = Antenna factor + Cable loss – Amplifier gain.
4. The average measurement was not performed when the peak measured data under the limit of average detection.
5. The emission levels of other frequencies are very lower than the limit and not show in test report.

Product : WiFi SOM Module
 Test Item : Harmonic Radiated Emission Data
 Test Date : 2019/12/31
 Test Mode : Mode 2:802.11g (2437 MHz)

Horizontal

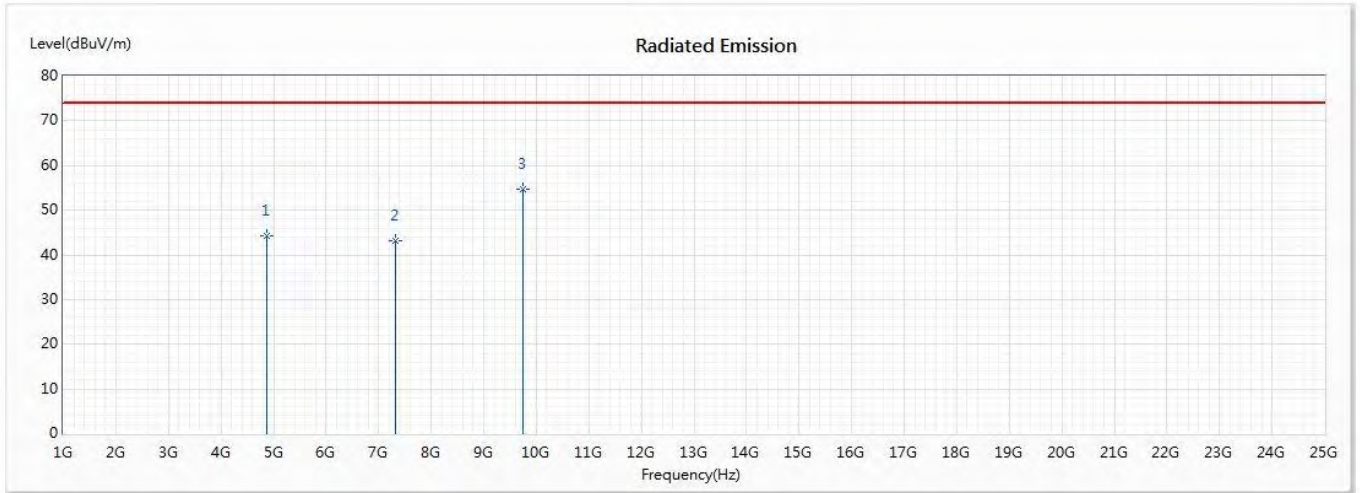

No	Frequency (MHz)	Emission Level (dBuV/m)	Limit (dBuV/m)	Margin (dB)	Reading Level (dBuV)	Correct Factor (dB/m)	Detector Type
1	4874	44.39	74.00	-29.61	56.03	-11.64	PK
2	7311	43.10	74.00	-30.90	56.58	-13.48	PK
* 3	9748	54.83	74.00	-19.17	67.22	-12.39	PK

Note:

1. All Readings below 1GHz are Quasi-Peak, above 1GHz are performed with peak and/or average measurements as necessary.
2. Measurement Level = Reading Level + Correct Factor.
3. Correct Factor = Antenna factor + Cable loss – Amplifier gain.
4. The average measurement was not performed when the peak measured data under the limit of average detection.
5. The emission levels of other frequencies are very lower than the limit and not show in test report.

Product : WiFi SOM Module
 Test Item : Harmonic Radiated Emission Data
 Test Date : 2019/12/31
 Test Mode : Mode 2:802.11g (2437 MHz)

Horizontal

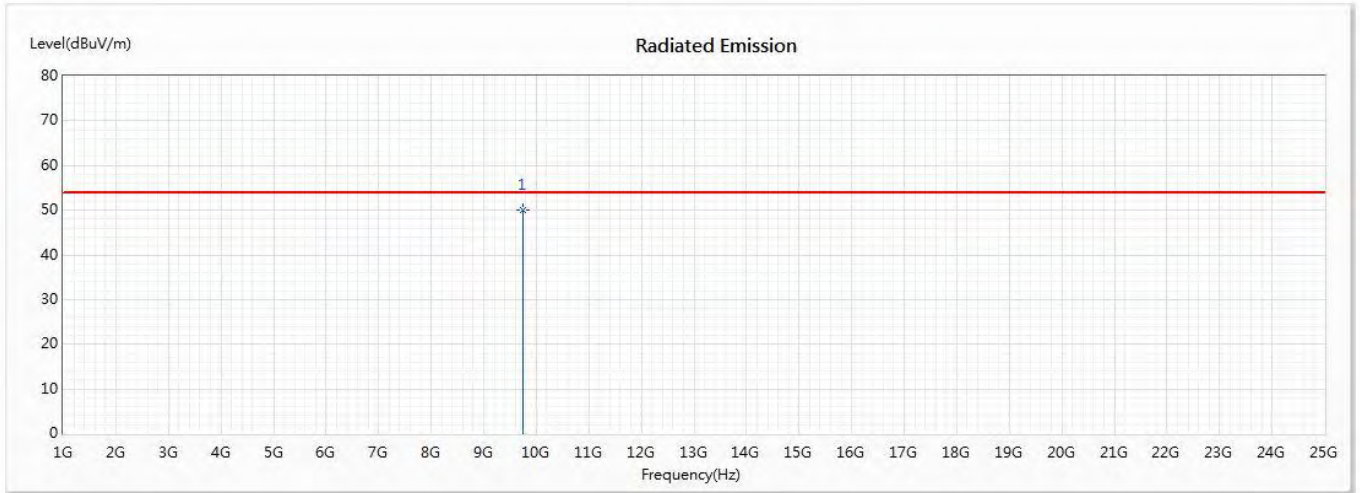

No	Frequency (MHz)	Emission Level (dBuV/m)	Limit (dBuV/m)	Margin (dB)	Reading Level (dBuV)	Correct Factor (dB/m)	Detector Type
* 1	9748	50.10	54.00	-3.90	62.49	-12.39	AV

Note:

1. All Readings below 1GHz are Quasi-Peak, above 1GHz are performed with peak and/or average measurements as necessary.
2. Measurement Level = Reading Level + Correct Factor.
3. Correct Factor = Antenna factor + Cable loss – Amplifier gain.
4. The average measurement was not performed when the peak measured data under the limit of average detection.
5. The emission levels of other frequencies are very lower than the limit and not show in test report.

Product : WiFi SOM Module
 Test Item : Harmonic Radiated Emission Data
 Test Date : 2019/12/31
 Test Mode : Mode 2:802.11g (2437 MHz)

Vertical

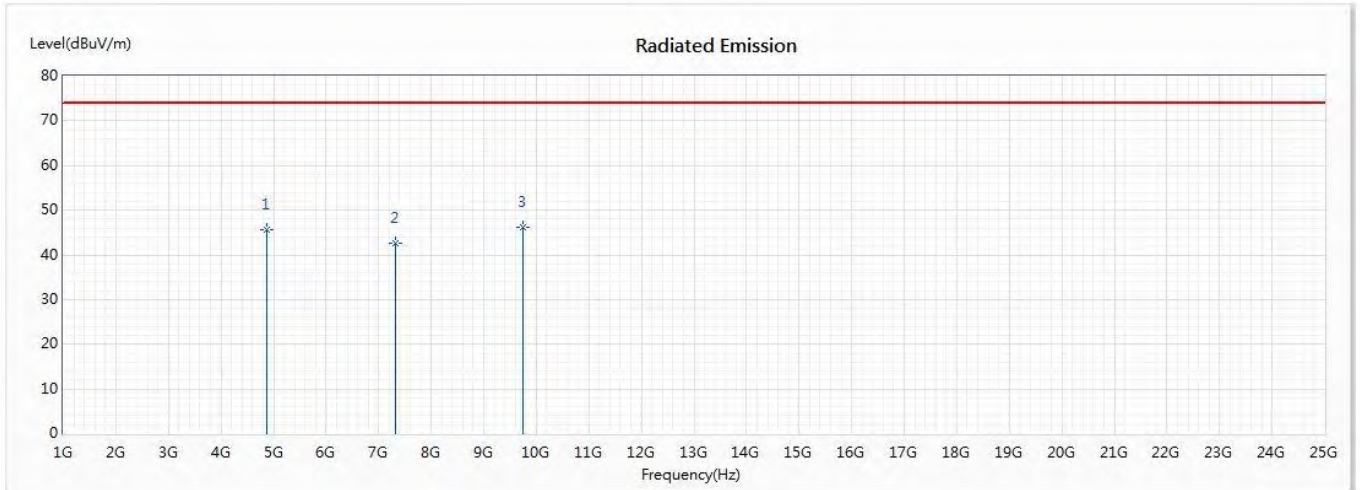

No	Frequency (MHz)	Emission Level (dBuV/m)	Limit (dBuV/m)	Margin (dB)	Reading Level (dBuV)	Correct Factor (dB/m)	Detector Type
1	4874	45.73	74.00	-28.27	57.37	-11.64	PK
2	7311	42.60	74.00	-31.40	56.08	-13.48	PK
* 3	9748	46.12	74.00	-27.88	58.51	-12.39	PK

Note:

1. All Readings below 1GHz are Quasi-Peak, above 1GHz are performed with peak and/or average measurements as necessary.
2. Measurement Level = Reading Level + Correct Factor.
3. Correct Factor = Antenna factor + Cable loss – Amplifier gain.
4. The average measurement was not performed when the peak measured data under the limit of average detection.
5. The emission levels of other frequencies are very lower than the limit and not show in test report.

Product : WiFi SOM Module
 Test Item : Harmonic Radiated Emission Data
 Test Date : 2019/12/31
 Test Mode : Mode 2:802.11g (2457 MHz)

Horizontal

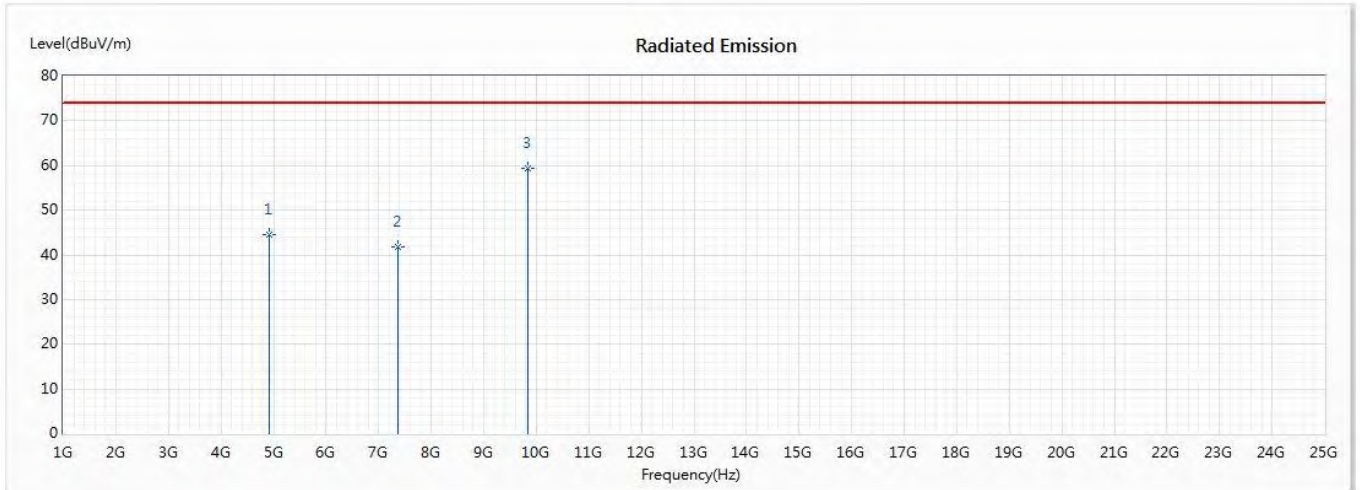

No	Frequency (MHz)	Emission Level (dBuV/m)	Limit (dBuV/m)	Margin (dB)	Reading Level (dBuV)	Correct Factor (dB/m)	Detector Type
1	4914	44.56	74.00	-29.44	55.90	-11.34	PK
2	7371	41.65	74.00	-32.35	55.63	-13.98	PK
* 3	9828	59.43	74.00	-14.57	72.66	-13.23	PK

Note:

1. All Readings below 1GHz are Quasi-Peak, above 1GHz are performed with peak and/or average measurements as necessary.
2. Measurement Level = Reading Level + Correct Factor.
3. Correct Factor = Antenna factor + Cable loss – Amplifier gain.
4. The average measurement was not performed when the peak measured data under the limit of average detection.
5. The emission levels of other frequencies are very lower than the limit and not show in test report.

Product : WiFi SOM Module
 Test Item : Harmonic Radiated Emission Data
 Test Date : 2019/12/31
 Test Mode : Mode 2:802.11g (2457 MHz)

Horizontal

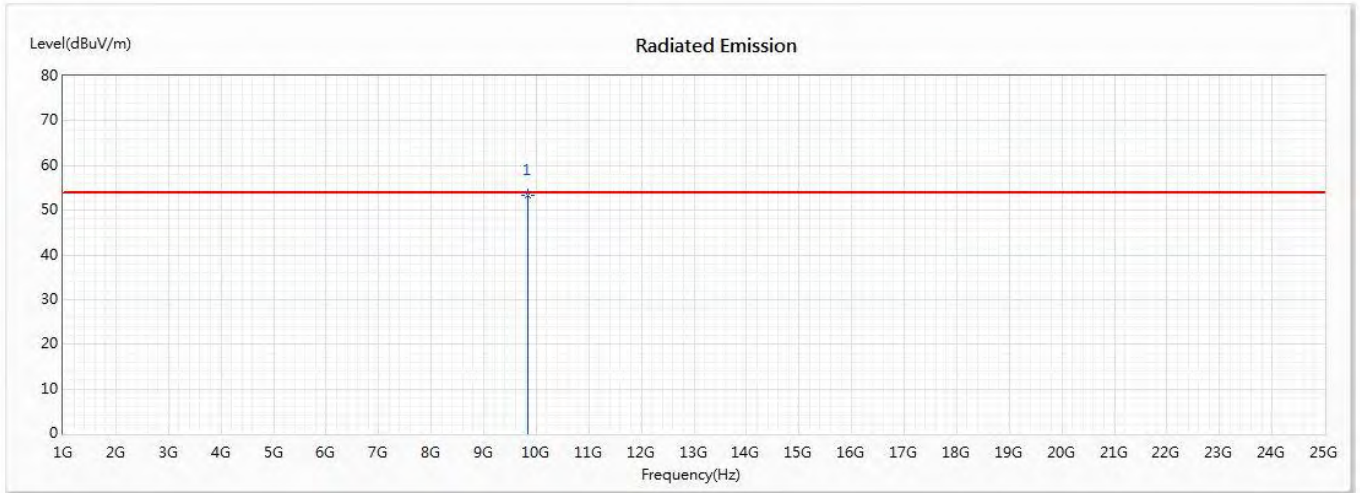

No	Frequency (MHz)	Emission Level (dBuV/m)	Limit (dBuV/m)	Margin (dB)	Reading Level (dBuV)	Correct Factor (dB/m)	Detector Type
* 1	9828	53.31	54.00	-0.69	66.54	-13.23	AV

Note:

1. All Readings below 1GHz are Quasi-Peak, above 1GHz are performed with peak and/or average measurements as necessary.
2. Measurement Level = Reading Level + Correct Factor.
3. Correct Factor = Antenna factor + Cable loss – Amplifier gain.
4. The average measurement was not performed when the peak measured data under the limit of average detection.
5. The emission levels of other frequencies are very lower than the limit and not show in test report.

Product : WiFi SOM Module
 Test Item : Harmonic Radiated Emission Data
 Test Date : 2019/12/31
 Test Mode : Mode 2:802.11g (2457 MHz)

Vertical

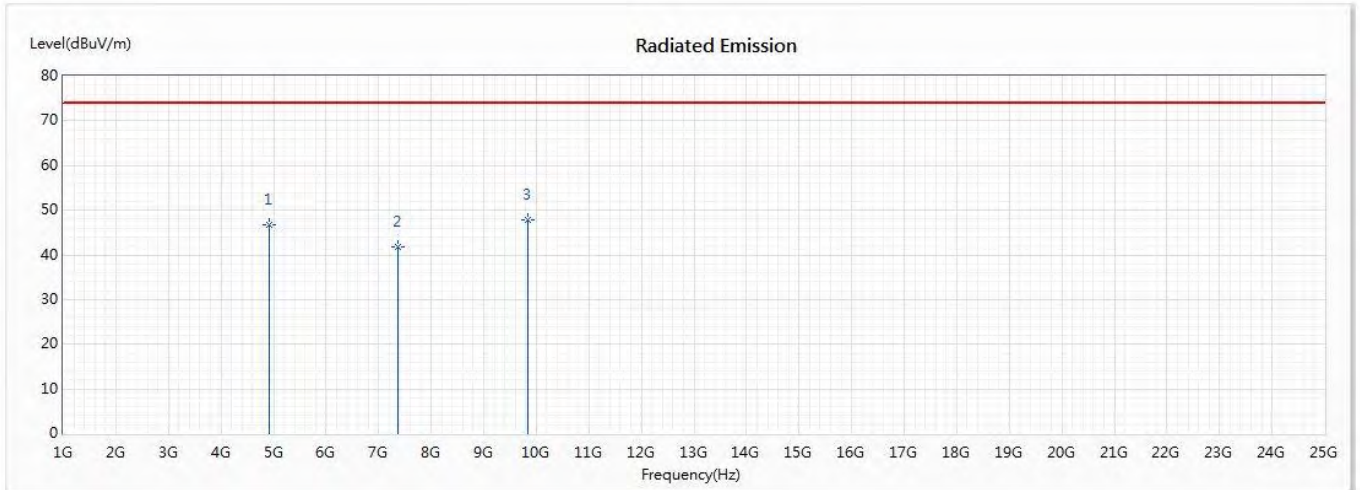

No	Frequency (MHz)	Emission Level (dBuV/m)	Limit (dBuV/m)	Margin (dB)	Reading Level (dBuV)	Correct Factor (dB/m)	Detector Type
1	4914	46.72	74.00	-27.28	58.06	-11.34	PK
2	7371	41.84	74.00	-32.16	55.82	-13.98	PK
* 3	9828	47.74	74.00	-26.26	60.97	-13.23	PK

Note:

1. All Readings below 1GHz are Quasi-Peak, above 1GHz are performed with peak and/or average measurements as necessary.
2. Measurement Level = Reading Level + Correct Factor.
3. Correct Factor = Antenna factor + Cable loss – Amplifier gain.
4. The average measurement was not performed when the peak measured data under the limit of average detection.
5. The emission levels of other frequencies are very lower than the limit and not show in test report.

Product : WiFi SOM Module
 Test Item : Harmonic Radiated Emission Data
 Test Date : 2019/12/31
 Test Mode : Mode 2:802.11g (2462MHz)

Horizontal

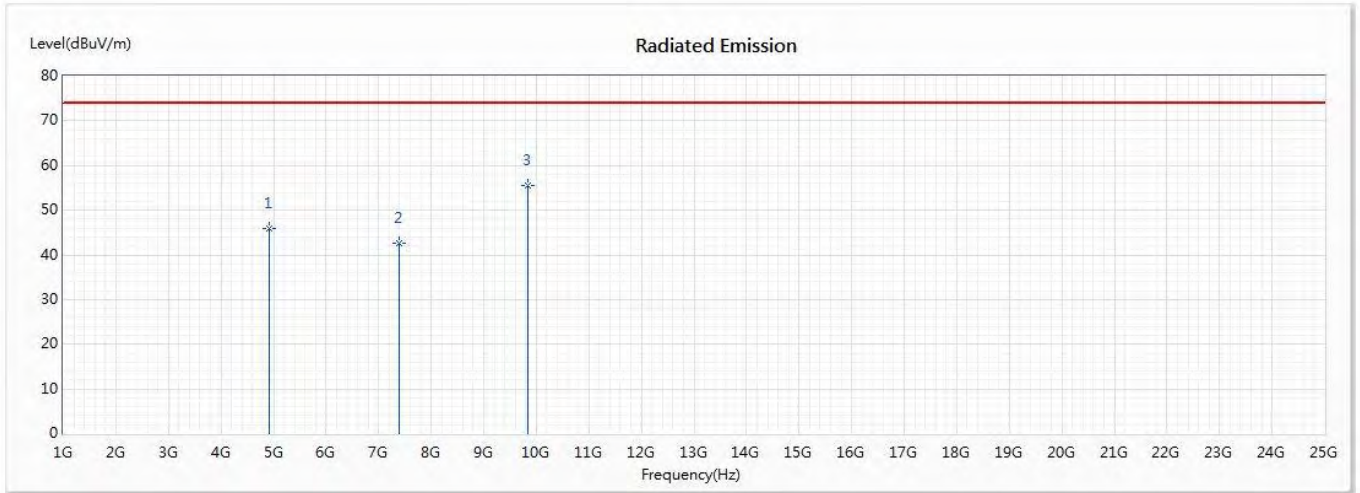

No	Frequency (MHz)	Emission Level (dBuV/m)	Limit (dBuV/m)	Margin (dB)	Reading Level (dBuV)	Correct Factor (dB/m)	Detector Type
1	4924	45.87	74.00	-28.13	57.11	-11.24	PK
2	7386	42.73	74.00	-31.27	56.83	-14.10	PK
* 3	9848	55.60	74.00	-18.40	69.04	-13.44	PK

Note:

1. All Readings below 1GHz are Quasi-Peak, above 1GHz are performed with peak and/or average measurements as necessary.
2. Measurement Level = Reading Level + Correct Factor.
3. Correct Factor = Antenna factor + Cable loss – Amplifier gain.
4. The average measurement was not performed when the peak measured data under the limit of average detection.
5. The emission levels of other frequencies are very lower than the limit and not show in test report.

Product : WiFi SOM Module
 Test Item : Harmonic Radiated Emission Data
 Test Date : 2019/12/31
 Test Mode : Mode 2:802.11g (2462MHz)

Horizontal

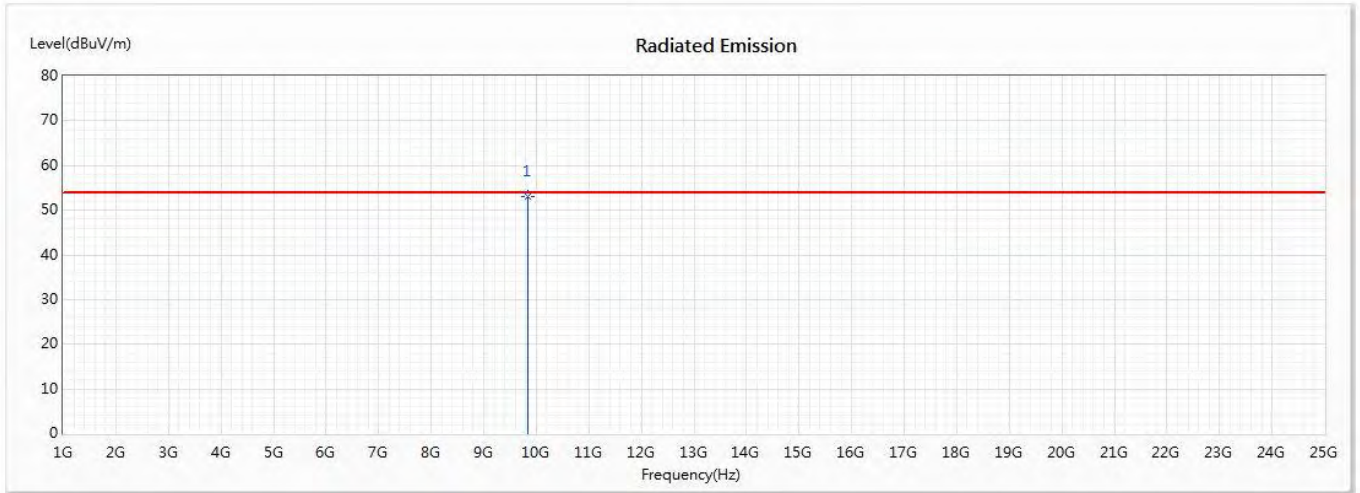

No	Frequency (MHz)	Emission Level (dBuV/m)	Limit (dBuV/m)	Margin (dB)	Reading Level (dBuV)	Correct Factor (dB/m)	Detector Type
* 1	9848	53.19	54.00	-0.81	66.63	-13.44	AV

Note:

1. All Readings below 1GHz are Quasi-Peak, above 1GHz are performed with peak and/or average measurements as necessary.
2. Measurement Level = Reading Level + Correct Factor.
3. Correct Factor = Antenna factor + Cable loss – Amplifier gain.
4. The average measurement was not performed when the peak measured data under the limit of average detection.
5. The emission levels of other frequencies are very lower than the limit and not show in test report.

Product : WiFi SOM Module
 Test Item : Harmonic Radiated Emission Data
 Test Date : 2019/12/31
 Test Mode : Mode 2:802.11g (2462MHz)

Vertical

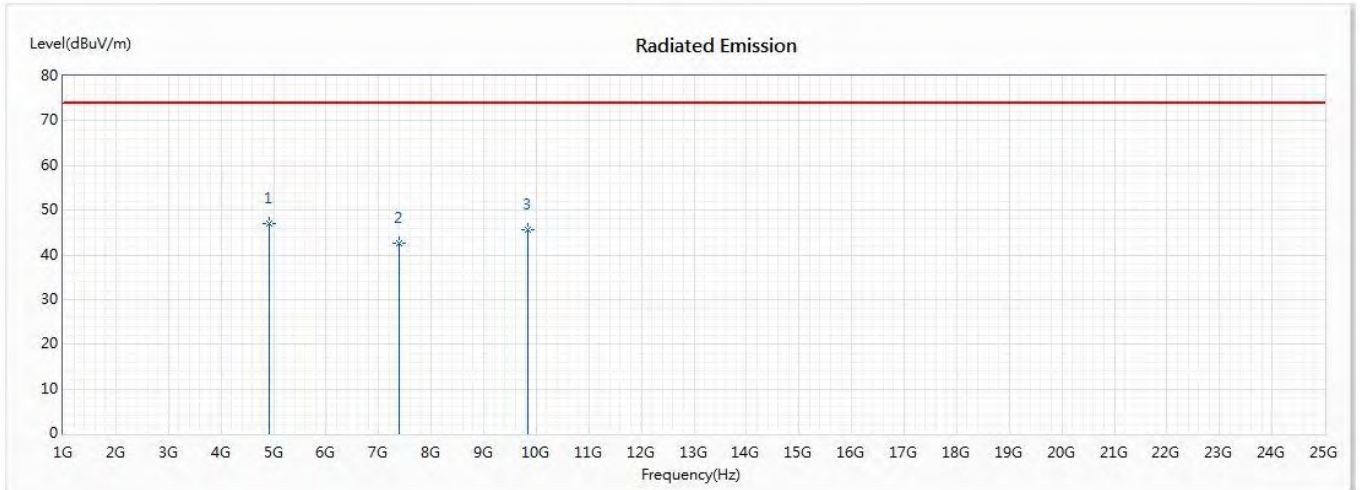

No	Frequency (MHz)	Emission Level (dBuV/m)	Limit (dBuV/m)	Margin (dB)	Reading Level (dBuV)	Correct Factor (dB/m)	Detector Type
* 1	4924	47.14	74.00	-26.86	58.38	-11.24	PK
2	7386	42.61	74.00	-31.39	56.71	-14.10	PK
3	9848	45.74	74.00	-28.26	59.18	-13.44	PK

Note:

1. All Readings below 1GHz are Quasi-Peak, above 1GHz are performed with peak and/or average measurements as necessary.
2. Measurement Level = Reading Level + Correct Factor.
3. Correct Factor = Antenna factor + Cable loss – Amplifier gain.
4. The average measurement was not performed when the peak measured data under the limit of average detection.
5. The emission levels of other frequencies are very lower than the limit and not show in test report.

Product : WiFi SOM Module
 Test Item : Harmonic Radiated Emission Data
 Test Date : 2019/12/31
 Test Mode : Mode 3:802.11n-20 (2412 MHz)

Horizontal

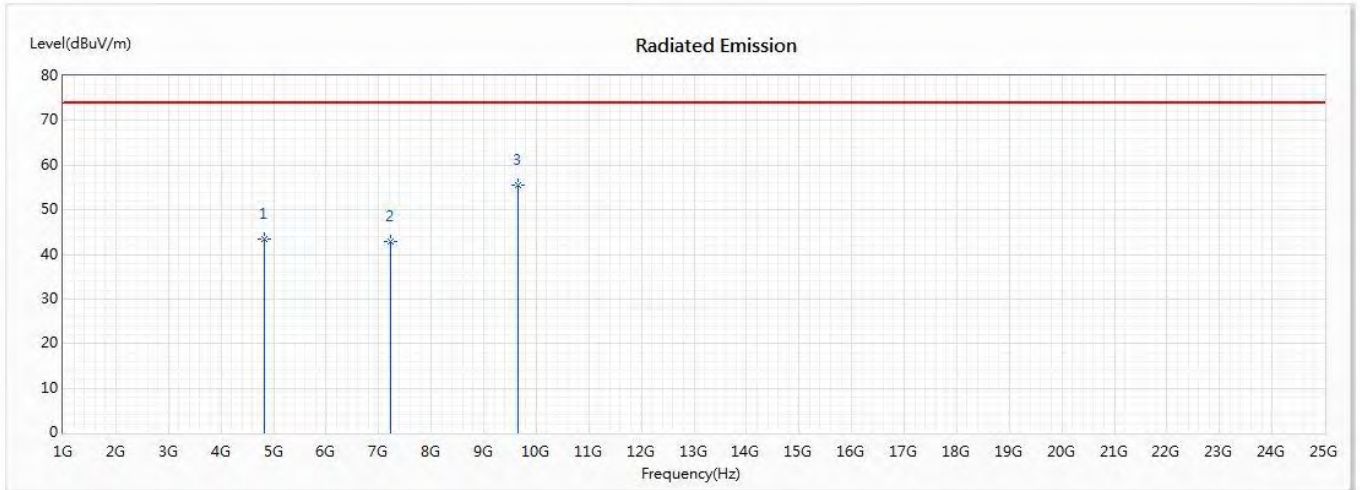

No	Frequency (MHz)	Emission Level (dBuV/m)	Limit (dBuV/m)	Margin (dB)	Reading Level (dBuV)	Correct Factor (dB/m)	Detector Type
1	4824	43.53	74.00	-30.47	55.52	-11.99	PK
2	7236	42.75	74.00	-31.25	55.71	-12.96	PK
* 3	9648	55.61	74.00	-18.39	68.71	-13.10	PK

Note:

1. All Readings below 1GHz are Quasi-Peak, above 1GHz are performed with peak and/or average measurements as necessary.
2. Measurement Level = Reading Level + Correct Factor.
3. Correct Factor = Antenna factor + Cable loss – Amplifier gain.
4. The average measurement was not performed when the peak measured data under the limit of average detection.
5. The emission levels of other frequencies are very lower than the limit and not show in test report.

Product : WiFi SOM Module
 Test Item : Harmonic Radiated Emission Data
 Test Date : 2019/12/31
 Test Mode : Mode 3:802.11n-20 (2412 MHz)

Horizontal

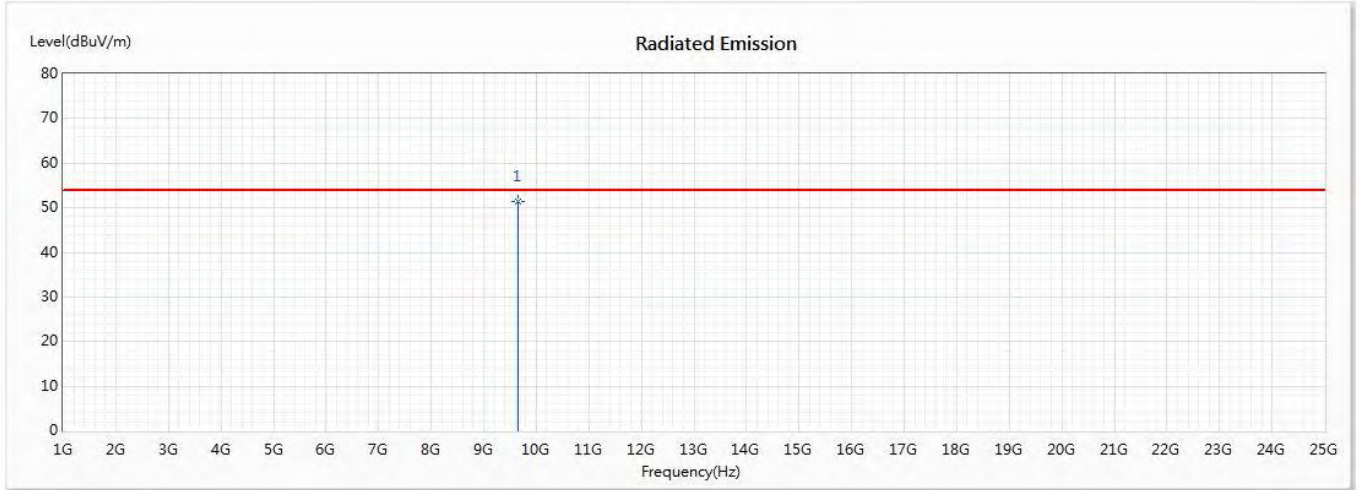

No	Frequency (MHz)	Emission Level (dBuV/m)	Limit (dBuV/m)	Margin (dB)	Reading Level (dBuV)	Correct Factor (dB/m)	Detector Type
* 1	9648	51.54	54.00	-2.46	64.64	-13.10	AV

Note:

1. All Readings below 1GHz are Quasi-Peak, above 1GHz are performed with peak and/or average measurements as necessary.
2. Measurement Level = Reading Level + Correct Factor.
3. Correct Factor = Antenna factor + Cable loss – Amplifier gain.
4. The average measurement was not performed when the peak measured data under the limit of average detection.
5. The emission levels of other frequencies are very lower than the limit and not show in test report.

Product : WiFi SOM Module
 Test Item : Harmonic Radiated Emission Data
 Test Date : 2019/12/31
 Test Mode : Mode 3:802.11n-20 (2412 MHz)

Vertical

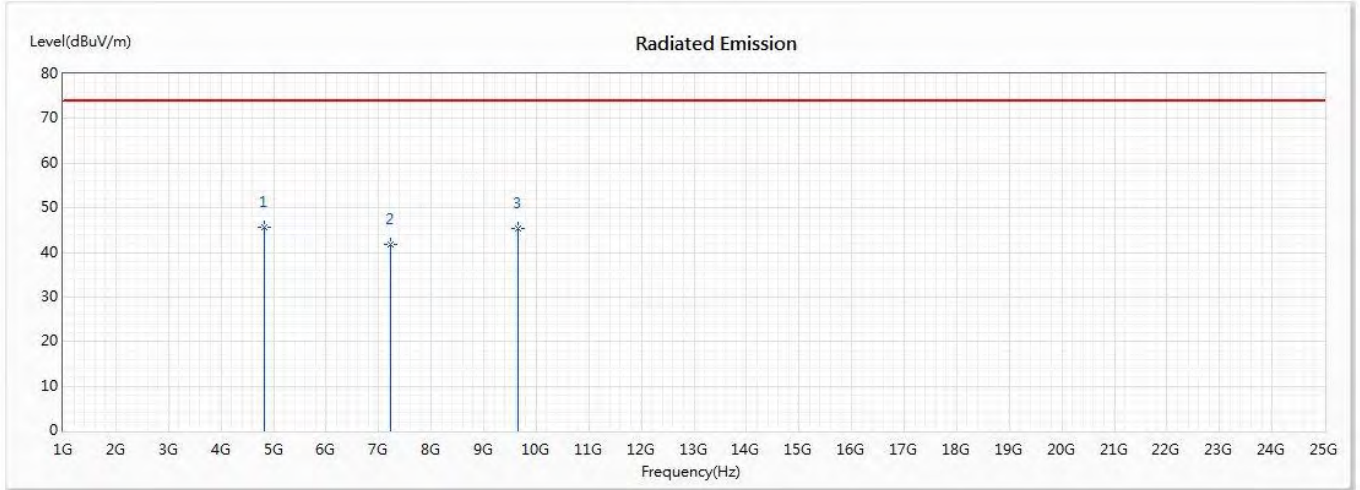

No	Frequency (MHz)	Emission Level (dBuV/m)	Limit (dBuV/m)	Margin (dB)	Reading Level (dBuV)	Correct Factor (dB/m)	Detector Type
* 1	4824	45.72	74.00	-28.28	57.71	-11.99	PK
2	7236	41.76	74.00	-32.24	54.72	-12.96	PK
3	9648	45.40	74.00	-28.60	58.50	-13.10	PK

Note:

1. All Readings below 1GHz are Quasi-Peak, above 1GHz are performed with peak and/or average measurements as necessary.
2. Measurement Level = Reading Level + Correct Factor.
3. Correct Factor = Antenna factor + Cable loss – Amplifier gain.
4. The average measurement was not performed when the peak measured data under the limit of average detection.
5. The emission levels of other frequencies are very lower than the limit and not show in test report.

Product : WiFi SOM Module
 Test Item : Harmonic Radiated Emission Data
 Test Date : 2019/12/31
 Test Mode : Mode 3:802.11n-20 (2417 MHz)

Horizontal

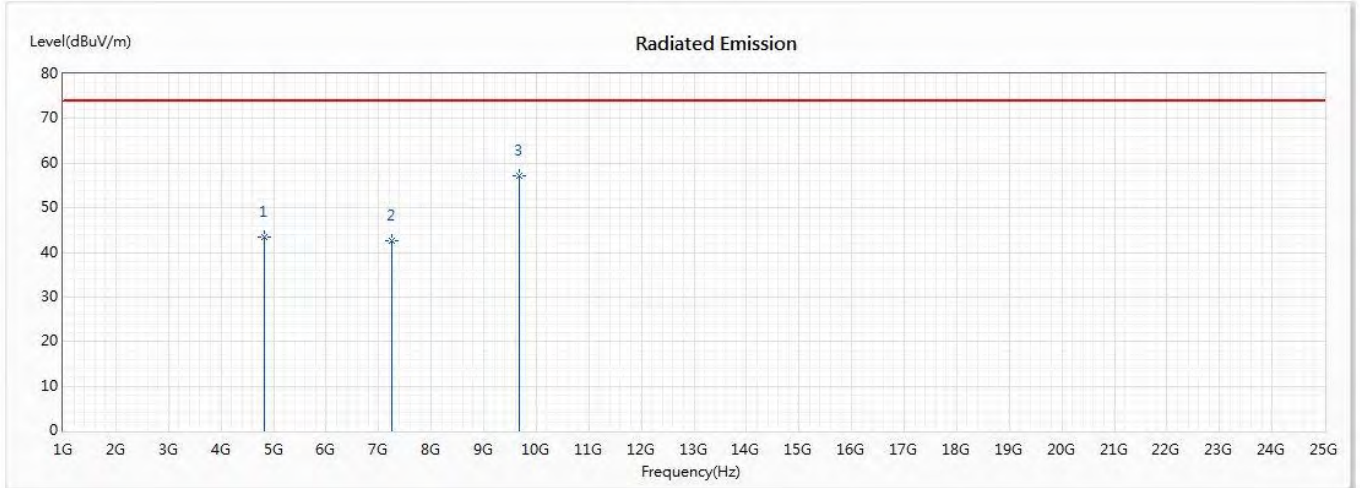

No	Frequency (MHz)	Emission Level (dBuV/m)	Limit (dBuV/m)	Margin (dB)	Reading Level (dBuV)	Correct Factor (dB/m)	Detector Type
1	4834	43.45	74.00	-30.55	55.36	-11.91	PK
2	7251	42.52	74.00	-31.48	55.40	-12.88	PK
* 3	9668	57.28	74.00	-16.72	70.22	-12.94	PK

Note:

1. All Readings below 1GHz are Quasi-Peak, above 1GHz are performed with peak and/or average measurements as necessary.
2. Measurement Level = Reading Level + Correct Factor.
3. Correct Factor = Antenna factor + Cable loss – Amplifier gain.
4. The average measurement was not performed when the peak measured data under the limit of average detection.
5. The emission levels of other frequencies are very lower than the limit and not show in test report.

Product : WiFi SOM Module
 Test Item : Harmonic Radiated Emission Data
 Test Date : 2019/12/31
 Test Mode : Mode 3:802.11n-20 (2417 MHz)

Horizontal

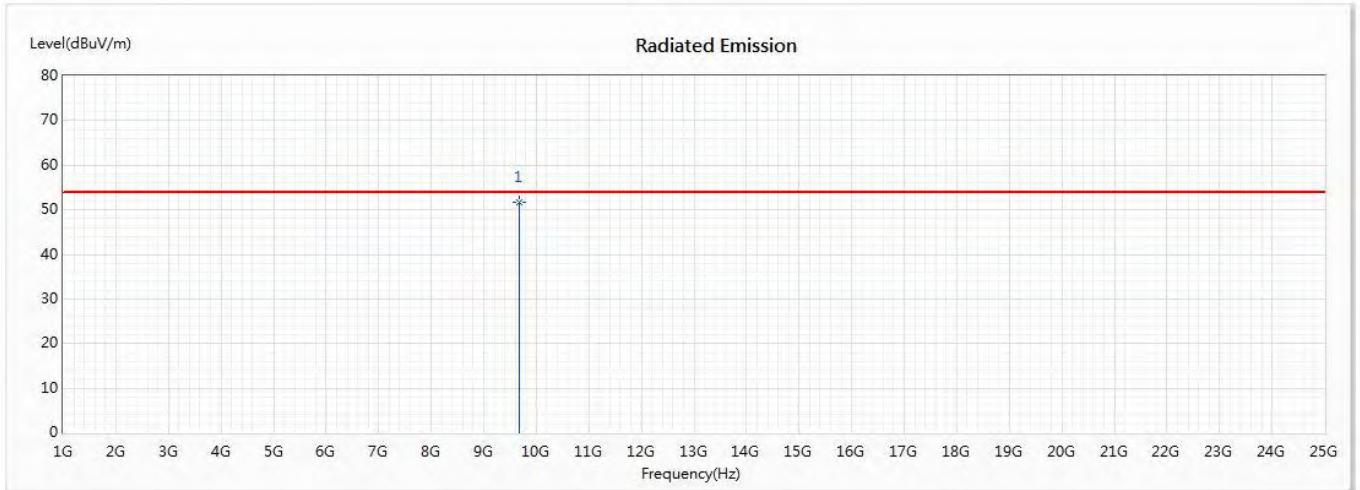

No	Frequency (MHz)	Emission Level (dBuV/m)	Limit (dBuV/m)	Margin (dB)	Reading Level (dBuV)	Correct Factor (dB/m)	Detector Type
* 1	9668	51.66	54.00	-2.34	64.60	-12.94	AV

Note:

1. All Readings below 1GHz are Quasi-Peak, above 1GHz are performed with peak and/or average measurements as necessary.
2. Measurement Level = Reading Level + Correct Factor.
3. Correct Factor = Antenna factor + Cable loss – Amplifier gain.
4. The average measurement was not performed when the peak measured data under the limit of average detection.
5. The emission levels of other frequencies are very lower than the limit and not show in test report.

Product : WiFi SOM Module
 Test Item : Harmonic Radiated Emission Data
 Test Date : 2019/12/31
 Test Mode : Mode 3:802.11n-20 (2417 MHz)

Vertical

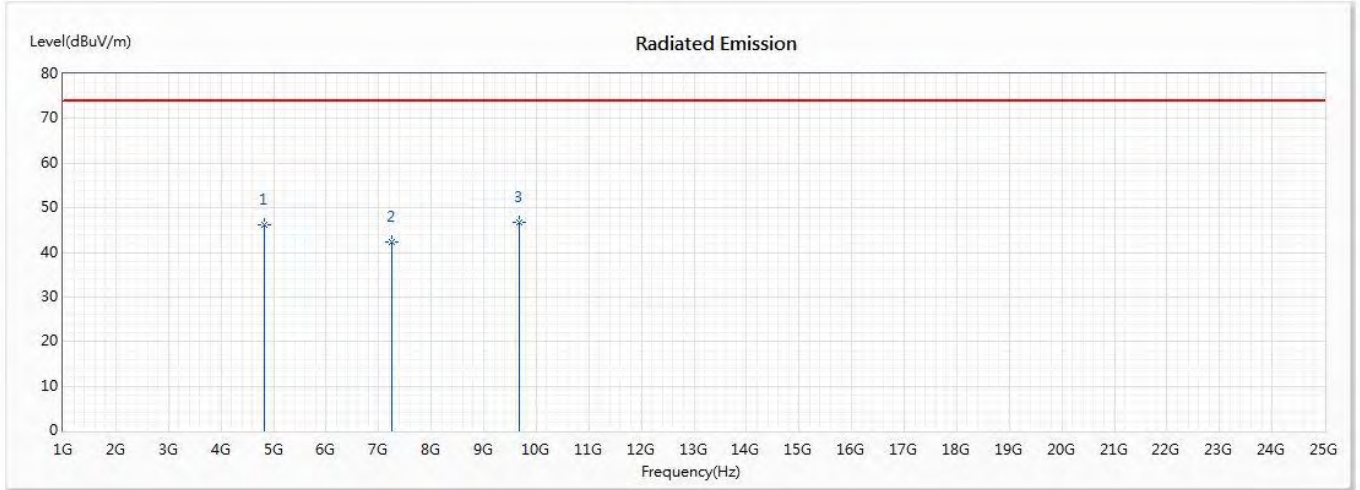

No	Frequency (MHz)	Emission Level (dBuV/m)	Limit (dBuV/m)	Margin (dB)	Reading Level (dBuV)	Correct Factor (dB/m)	Detector Type
1	4834	46.28	74.00	-27.72	58.19	-11.91	PK
2	7251	42.44	74.00	-31.56	55.32	-12.88	PK
* 3	9668	46.72	74.00	-27.28	59.66	-12.94	PK

Note:

1. All Readings below 1GHz are Quasi-Peak, above 1GHz are performed with peak and/or average measurements as necessary.
2. Measurement Level = Reading Level + Correct Factor.
3. Correct Factor = Antenna factor + Cable loss – Amplifier gain.
4. The average measurement was not performed when the peak measured data under the limit of average detection.
5. The emission levels of other frequencies are very lower than the limit and not show in test report.

Product : WiFi SOM Module
 Test Item : Harmonic Radiated Emission Data
 Test Date : 2019/12/31
 Test Mode : Mode 3:802.11n-20 (2437 MHz)

Horizontal

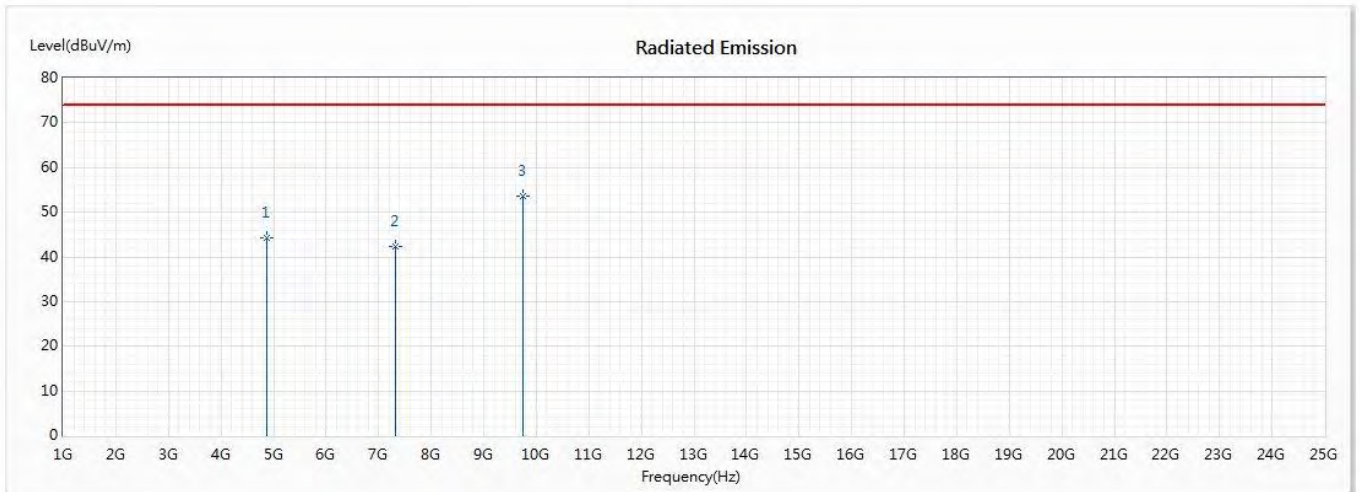

No	Frequency (MHz)	Emission Level (dBuV/m)	Limit (dBuV/m)	Margin (dB)	Reading Level (dBuV)	Correct Factor (dB/m)	Detector Type
1	4874	44.34	74.00	-29.66	55.98	-11.64	PK
2	7311	42.26	74.00	-31.74	55.74	-13.48	PK
* 3	9748	53.61	74.00	-20.39	66.00	-12.39	PK

Note:

1. All Readings below 1GHz are Quasi-Peak, above 1GHz are performed with peak and/or average measurements as necessary.
2. Measurement Level = Reading Level + Correct Factor.
3. Correct Factor = Antenna factor + Cable loss – Amplifier gain.
4. The average measurement was not performed when the peak measured data under the limit of average detection.
5. The emission levels of other frequencies are very lower than the limit and not show in test report.

Product : WiFi SOM Module
 Test Item : Harmonic Radiated Emission Data
 Test Date : 2019/12/31
 Test Mode : Mode 3:802.11n-20 (2437 MHz)

Vertical

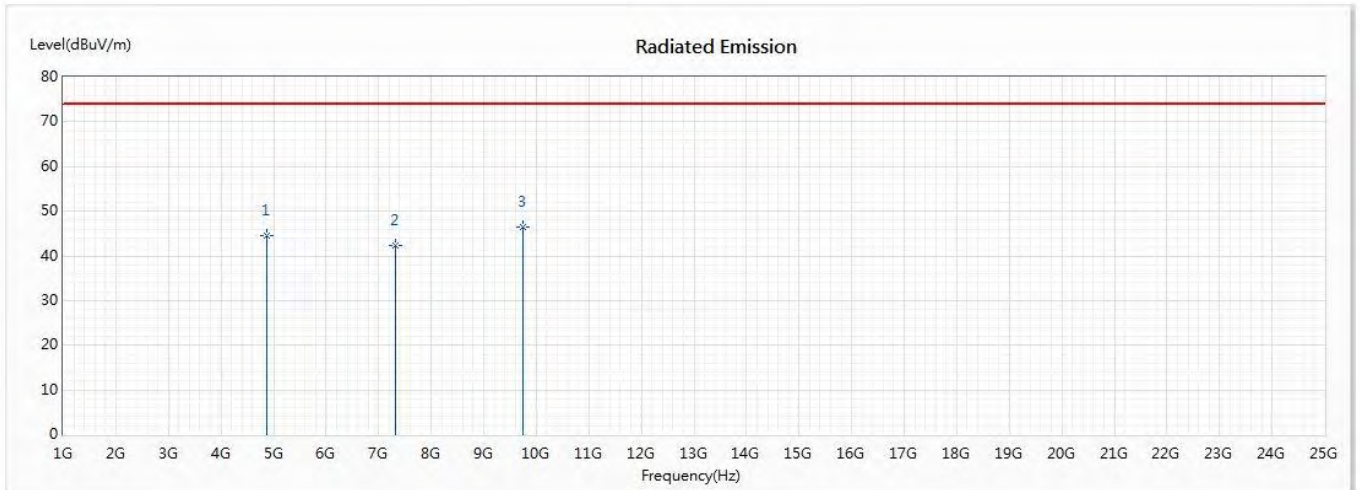

No	Frequency (MHz)	Emission Level (dBuV/m)	Limit (dBuV/m)	Margin (dB)	Reading Level (dBuV)	Correct Factor (dB/m)	Detector Type
1	4874	44.57	74.00	-29.43	56.21	-11.64	PK
2	7311	42.45	74.00	-31.55	55.93	-13.48	PK
* 3	9748	46.44	74.00	-27.56	58.83	-12.39	PK

Note:

1. All Readings below 1GHz are Quasi-Peak, above 1GHz are performed with peak and/or average measurements as necessary.
2. Measurement Level = Reading Level + Correct Factor.
3. Correct Factor = Antenna factor + Cable loss – Amplifier gain.
4. The average measurement was not performed when the peak measured data under the limit of average detection.
5. The emission levels of other frequencies are very lower than the limit and not show in test report.

Product : WiFi SOM Module
 Test Item : Harmonic Radiated Emission Data
 Test Date : 2019/12/31
 Test Mode : Mode 3:802.11n-20 (2457 MHz)

Horizontal

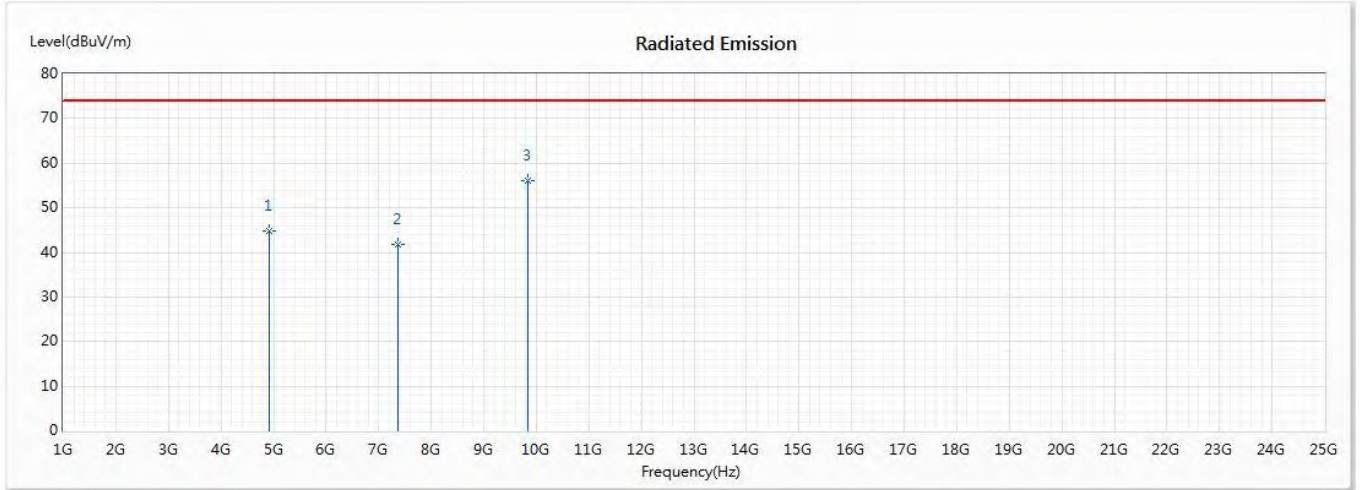

No	Frequency (MHz)	Emission Level (dBuV/m)	Limit (dBuV/m)	Margin (dB)	Reading Level (dBuV)	Correct Factor (dB/m)	Detector Type
1	4914	44.78	74.00	-29.22	56.12	-11.34	PK
2	7371	41.76	74.00	-32.24	55.74	-13.98	PK
* 3	9828	56.12	74.00	-17.88	69.35	-13.23	PK

Note:

1. All Readings below 1GHz are Quasi-Peak, above 1GHz are performed with peak and/or average measurements as necessary.
2. Measurement Level = Reading Level + Correct Factor.
3. Correct Factor = Antenna factor + Cable loss – Amplifier gain.
4. The average measurement was not performed when the peak measured data under the limit of average detection.
5. The emission levels of other frequencies are very lower than the limit and not show in test report.

Product : WiFi SOM Module
 Test Item : Harmonic Radiated Emission Data
 Test Date : 2019/12/31
 Test Mode : Mode 3:802.11n-20 (2457 MHz)

Horizontal

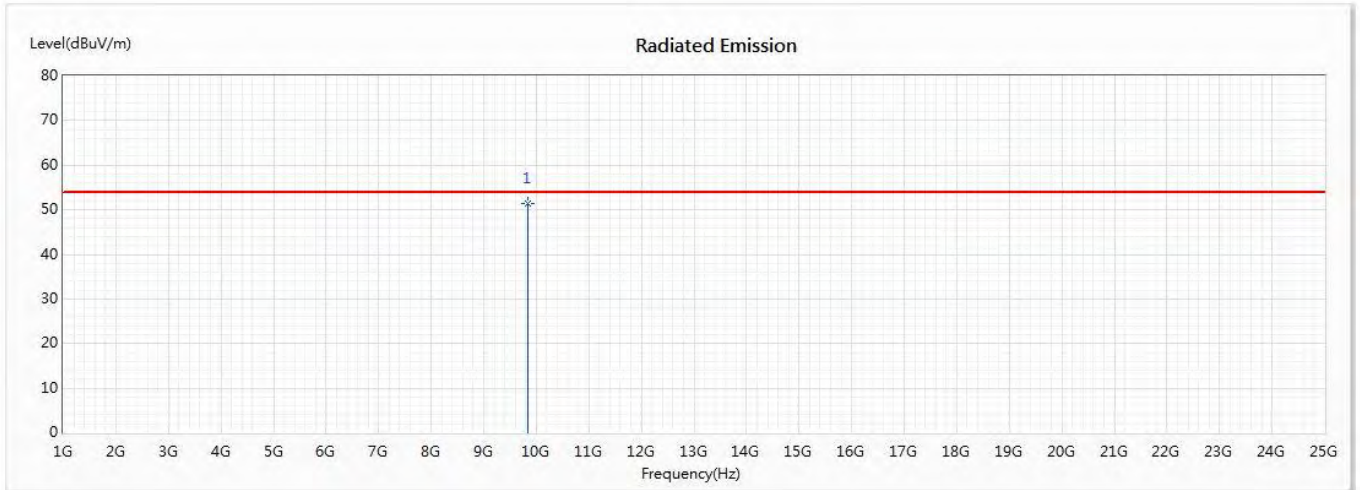

No	Frequency (MHz)	Emission Level (dBuV/m)	Limit (dBuV/m)	Margin (dB)	Reading Level (dBuV)	Correct Factor (dB/m)	Detector Type
* 1	9828	51.45	54.00	-2.55	64.68	-13.23	AV

Note:

1. All Readings below 1GHz are Quasi-Peak, above 1GHz are performed with peak and/or average measurements as necessary.
2. Measurement Level = Reading Level + Correct Factor.
3. Correct Factor = Antenna factor + Cable loss – Amplifier gain.
4. The average measurement was not performed when the peak measured data under the limit of average detection.
5. The emission levels of other frequencies are very lower than the limit and not show in test report.

Product : WiFi SOM Module
 Test Item : Harmonic Radiated Emission Data
 Test Date : 2019/12/31
 Test Mode : Mode 3:802.11n-20 (2457 MHz)

Vertical

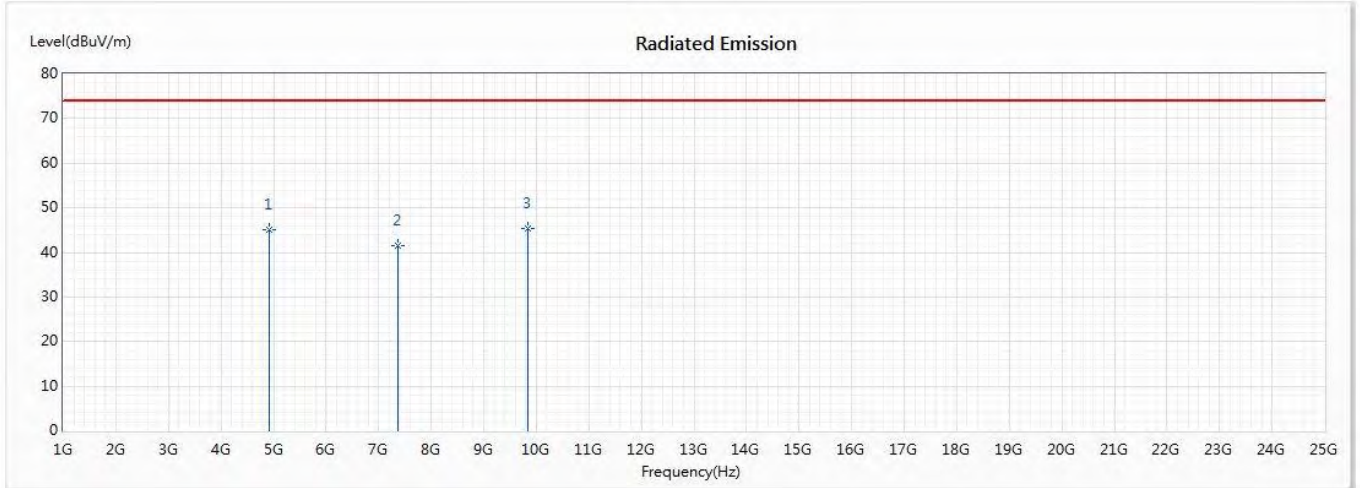

No	Frequency (MHz)	Emission Level (dBuV/m)	Limit (dBuV/m)	Margin (dB)	Reading Level (dBuV)	Correct Factor (dB/m)	Detector Type
1	4914	45.14	74.00	-28.86	56.48	-11.34	PK
2	7371	41.46	74.00	-32.54	55.44	-13.98	PK
* 3	9828	45.24	74.00	-28.76	58.47	-13.23	PK

Note:

1. All Readings below 1GHz are Quasi-Peak, above 1GHz are performed with peak and/or average measurements as necessary.
2. Measurement Level = Reading Level + Correct Factor.
3. Correct Factor = Antenna factor + Cable loss – Amplifier gain.
4. The average measurement was not performed when the peak measured data under the limit of average detection.
5. The emission levels of other frequencies are very lower than the limit and not show in test report.

Product : WiFi SOM Module
 Test Item : Harmonic Radiated Emission Data
 Test Date : 2019/12/31
 Test Mode : Mode 3:802.11n-20 (2462 MHz)

Horizontal

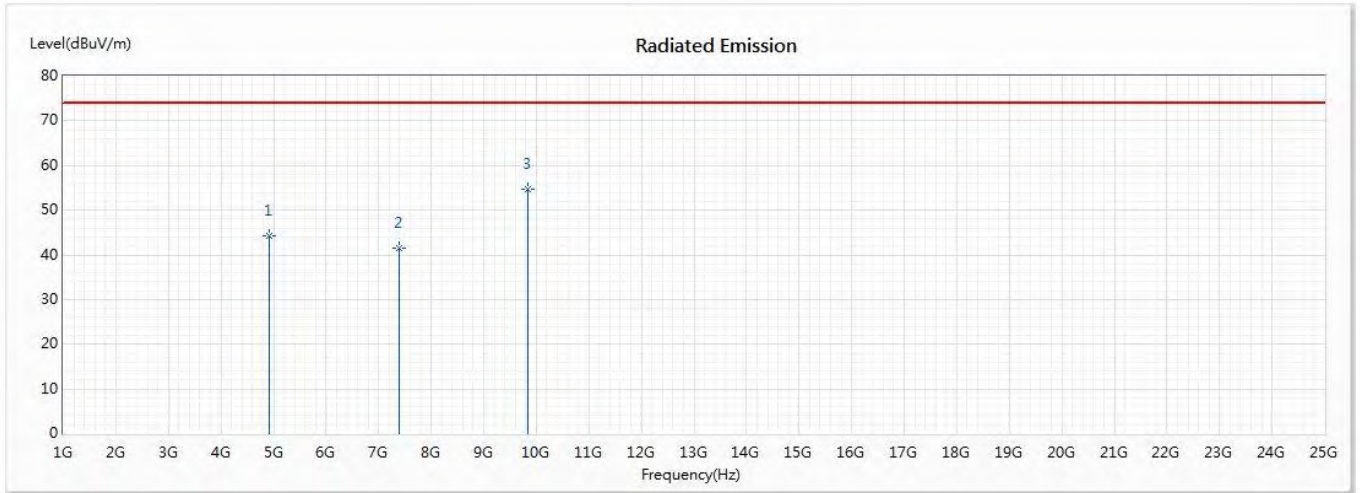

No	Frequency (MHz)	Emission Level (dBuV/m)	Limit (dBuV/m)	Margin (dB)	Reading Level (dBuV)	Correct Factor (dB/m)	Detector Type
1	4924	44.35	74.00	-29.65	55.59	-11.24	PK
2	7386	41.48	74.00	-32.52	55.58	-14.10	PK
* 3	9848	54.65	74.00	-19.35	68.09	-13.44	PK

Note:

1. All Readings below 1GHz are Quasi-Peak, above 1GHz are performed with peak and/or average measurements as necessary.
2. Measurement Level = Reading Level + Correct Factor.
3. Correct Factor = Antenna factor + Cable loss – Amplifier gain.
4. The average measurement was not performed when the peak measured data under the limit of average detection.
5. The emission levels of other frequencies are very lower than the limit and not show in test report.

Product : WiFi SOM Module
 Test Item : Harmonic Radiated Emission Data
 Test Date : 2019/12/31
 Test Mode : Mode 3:802.11n-20 (2462 MHz)

Horizontal

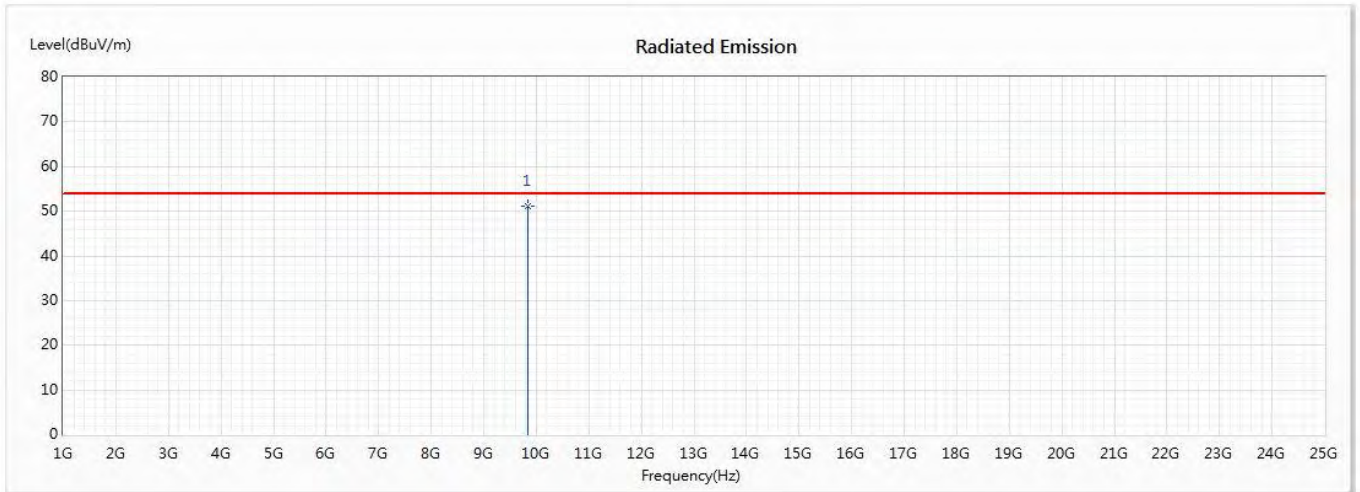

No	Frequency (MHz)	Emission Level (dBuV/m)	Limit (dBuV/m)	Margin (dB)	Reading Level (dBuV)	Correct Factor (dB/m)	Detector Type
* 1	9848	51.26	54.00	-2.74	64.70	-13.44	AV

Note:

1. All Readings below 1GHz are Quasi-Peak, above 1GHz are performed with peak and/or average measurements as necessary.
2. Measurement Level = Reading Level + Correct Factor.
3. Correct Factor = Antenna factor + Cable loss – Amplifier gain.
4. The average measurement was not performed when the peak measured data under the limit of average detection.
5. The emission levels of other frequencies are very lower than the limit and not show in test report.

Product : WiFi SOM Module
 Test Item : Harmonic Radiated Emission Data
 Test Date : 2018/08/30
 Test Mode : Mode 3:802.11n-20 (2462 MHz)

Vertical

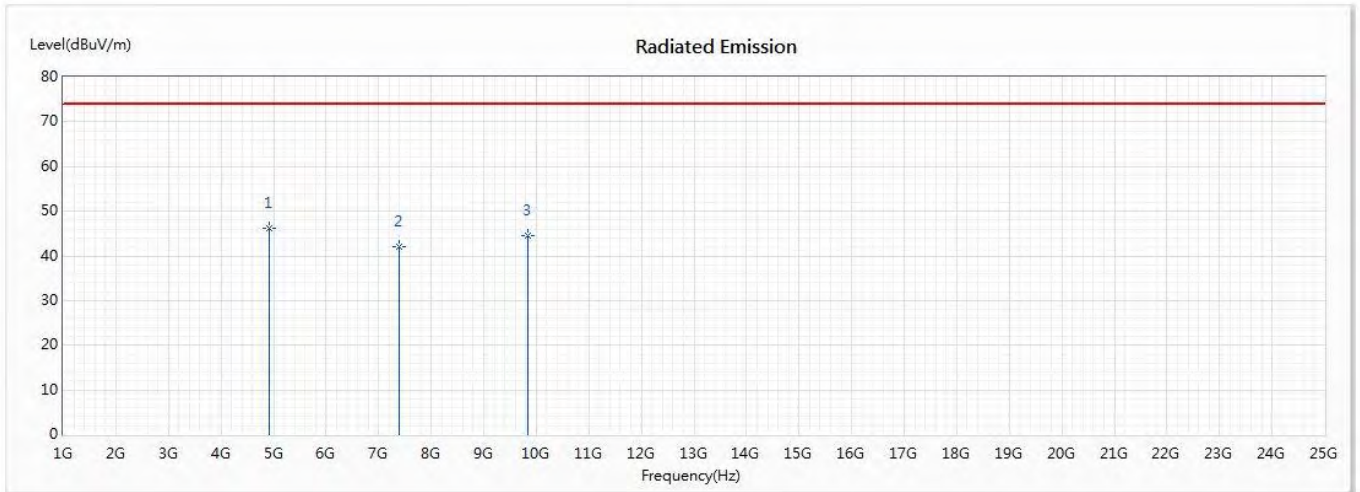

No	Frequency (MHz)	Emission Level (dBuV/m)	Limit (dBuV/m)	Margin (dB)	Reading Level (dBuV)	Correct Factor (dB/m)	Detector Type
* 1	4924	46.22	74.00	-27.78	57.46	-11.24	PK
2	7386	42.14	74.00	-31.86	56.24	-14.10	PK
3	9848	44.52	74.00	-29.48	57.96	-13.44	PK

Note:

1. All Readings below 1GHz are Quasi-Peak, above 1GHz are performed with peak and/or average measurements as necessary.
2. Measurement Level = Reading Level + Correct Factor.
3. Correct Factor = Antenna factor + Cable loss – Amplifier gain.
4. The average measurement was not performed when the peak measured data under the limit of average detection.
5. The emission levels of other frequencies are very lower than the limit and not show in test report.

Product : WiFi SOM Module
 Test Item : Harmonic Radiated Emission Data
 Test Date : 2019/12/31
 Test Mode : Mode 4:802.11n-40 (2422 MHz)

Horizontal

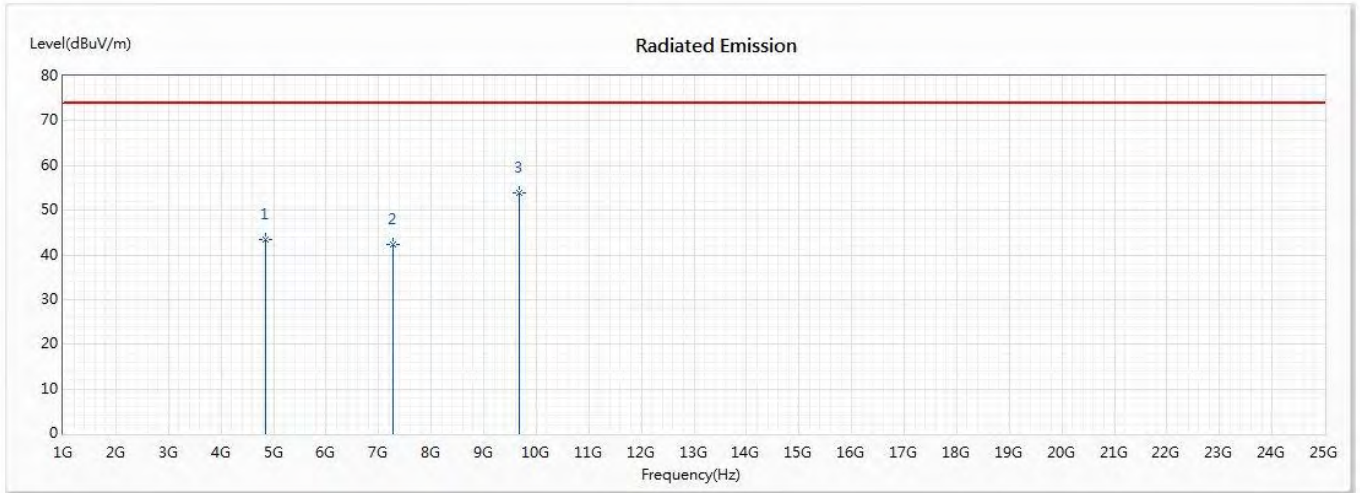

No	Frequency (MHz)	Emission Level (dBuV/m)	Limit (dBuV/m)	Margin (dB)	Reading Level (dBuV)	Correct Factor (dB/m)	Detector Type
1	4844	43.36	74.00	-30.64	55.19	-11.83	PK
2	7266	42.29	74.00	-31.71	55.32	-13.03	PK
* 3	9688	53.76	74.00	-20.24	66.54	-12.78	PK

Note:

1. All Readings below 1GHz are Quasi-Peak, above 1GHz are performed with peak and/or average measurements as necessary.
2. Measurement Level = Reading Level + Correct Factor.
3. Correct Factor = Antenna factor + Cable loss – Amplifier gain.
4. The average measurement was not performed when the peak measured data under the limit of average detection.
5. The emission levels of other frequencies are very lower than the limit and not show in test report.

Product : WiFi SOM Module
 Test Item : Harmonic Radiated Emission Data
 Test Date : 2019/12/31
 Test Mode : Mode 4:802.11n-40 (2422 MHz)

Vertical

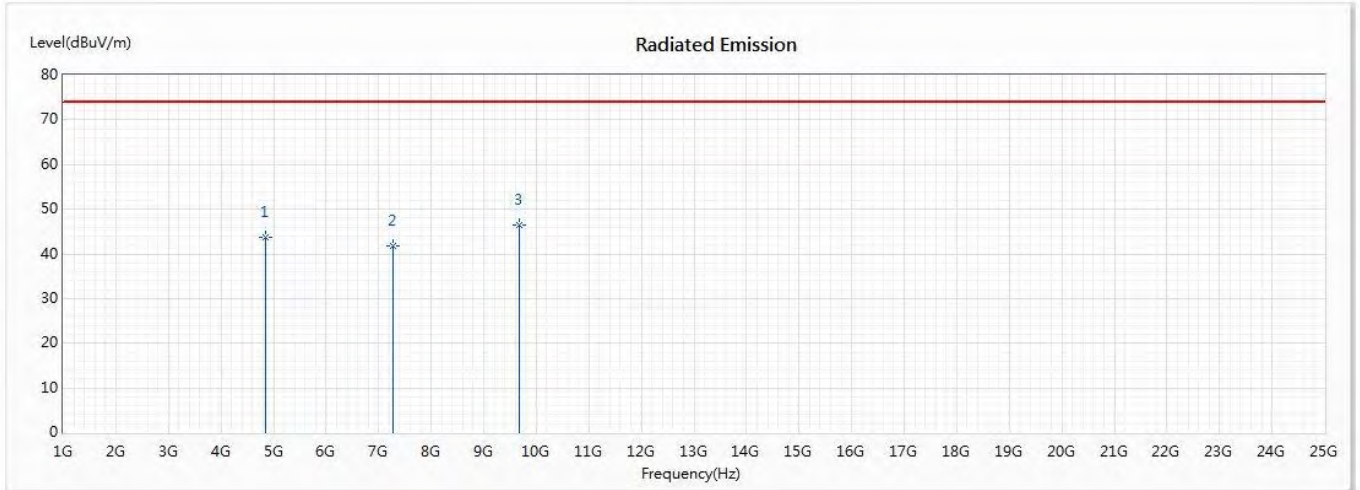

No	Frequency (MHz)	Emission Level (dBuV/m)	Limit (dBuV/m)	Margin (dB)	Reading Level (dBuV)	Correct Factor (dB/m)	Detector Type
1	4844	43.71	74.00	-30.29	55.54	-11.83	PK
2	7266	41.78	74.00	-32.22	54.81	-13.03	PK
* 3	9688	46.35	74.00	-27.65	59.13	-12.78	PK

Note:

1. All Readings below 1GHz are Quasi-Peak, above 1GHz are performed with peak and/or average measurements as necessary.
2. Measurement Level = Reading Level + Correct Factor.
3. Correct Factor = Antenna factor + Cable loss – Amplifier gain.
4. The average measurement was not performed when the peak measured data under the limit of average detection.
5. The emission levels of other frequencies are very lower than the limit and not show in test report.

Product : WiFi SOM Module
 Test Item : Harmonic Radiated Emission Data
 Test Date : 2019/12/31
 Test Mode : Mode 4:802.11n-40 (2427 MHz)

Horizontal

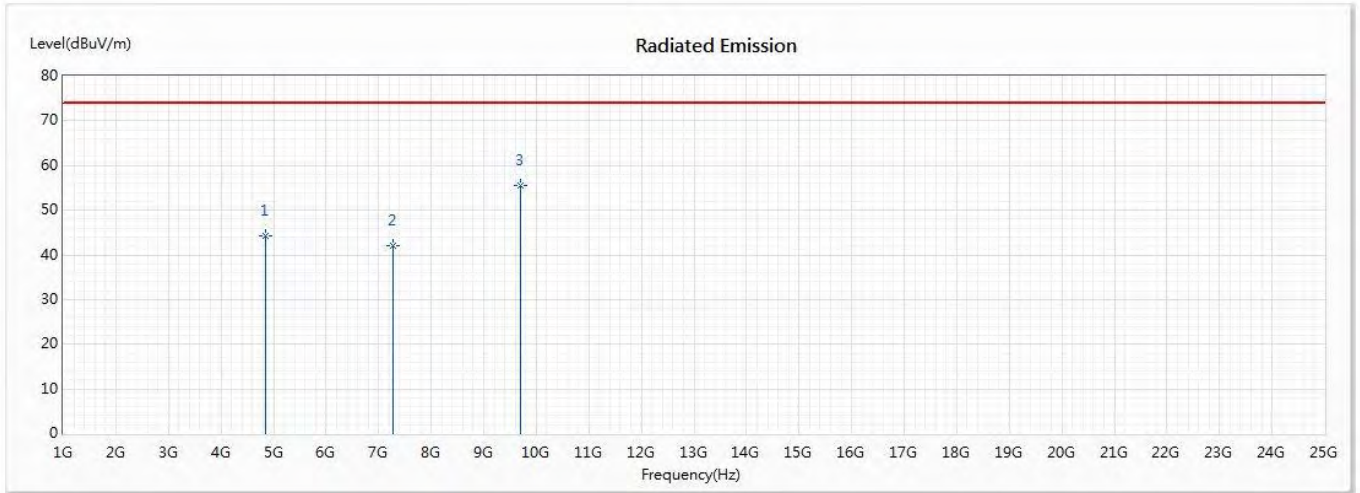

No	Frequency (MHz)	Emission Level (dBuV/m)	Limit (dBuV/m)	Margin (dB)	Reading Level (dBuV)	Correct Factor (dB/m)	Detector Type
1	4854	44.28	74.00	-29.72	56.04	-11.76	PK
2	7281	42.09	74.00	-31.91	55.27	-13.18	PK
* 3	9708	55.58	74.00	-18.42	68.21	-12.63	PK

Note:

1. All Readings below 1GHz are Quasi-Peak, above 1GHz are performed with peak and/or average measurements as necessary.
2. Measurement Level = Reading Level + Correct Factor.
3. Correct Factor = Antenna factor + Cable loss – Amplifier gain.
4. The average measurement was not performed when the peak measured data under the limit of average detection.
5. The emission levels of other frequencies are very lower than the limit and not show in test report.

Product : WiFi SOM Module
 Test Item : Harmonic Radiated Emission Data
 Test Date : 2019/12/31
 Test Mode : Mode 4:802.11n-40 (2427 MHz)

Horizontal

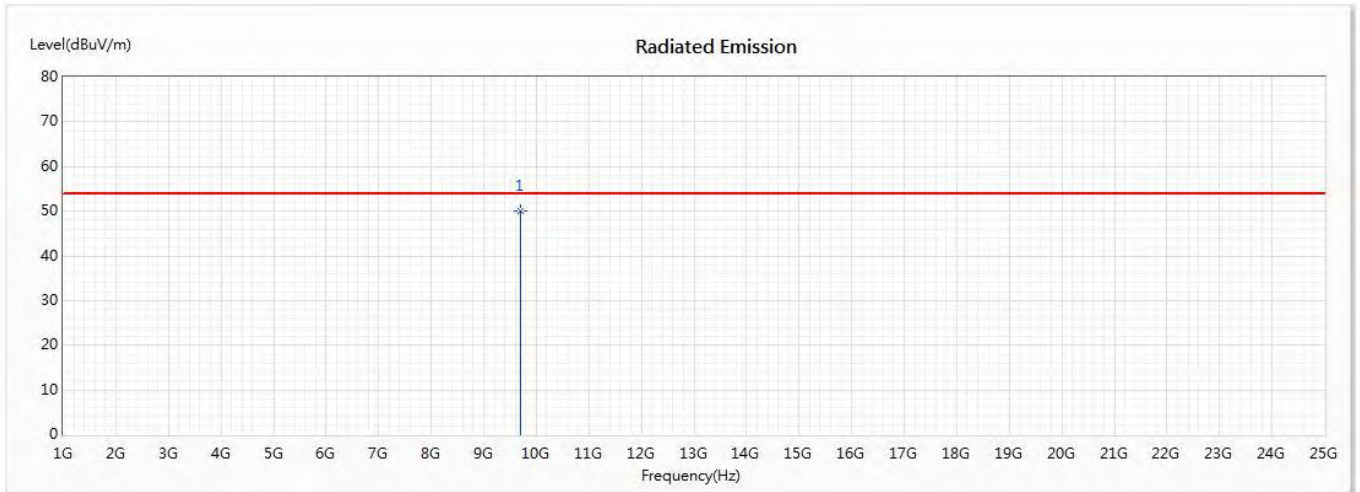

No	Frequency (MHz)	Emission Level (dBuV/m)	Limit (dBuV/m)	Margin (dB)	Reading Level (dBuV)	Correct Factor (dB/m)	Detector Type
* 1	9708	50.15	54.00	-3.85	62.78	-12.63	AV

Note:

1. All Readings below 1GHz are Quasi-Peak, above 1GHz are performed with peak and/or average measurements as necessary.
2. Measurement Level = Reading Level + Correct Factor.
3. Correct Factor = Antenna factor + Cable loss – Amplifier gain.
4. The average measurement was not performed when the peak measured data under the limit of average detection.
5. The emission levels of other frequencies are very lower than the limit and not show in test report.

Product : WiFi SOM Module
 Test Item : Harmonic Radiated Emission Data
 Test Date : 2019/12/31
 Test Mode : Mode 4:802.11n-40 (2427 MHz)

Vertical

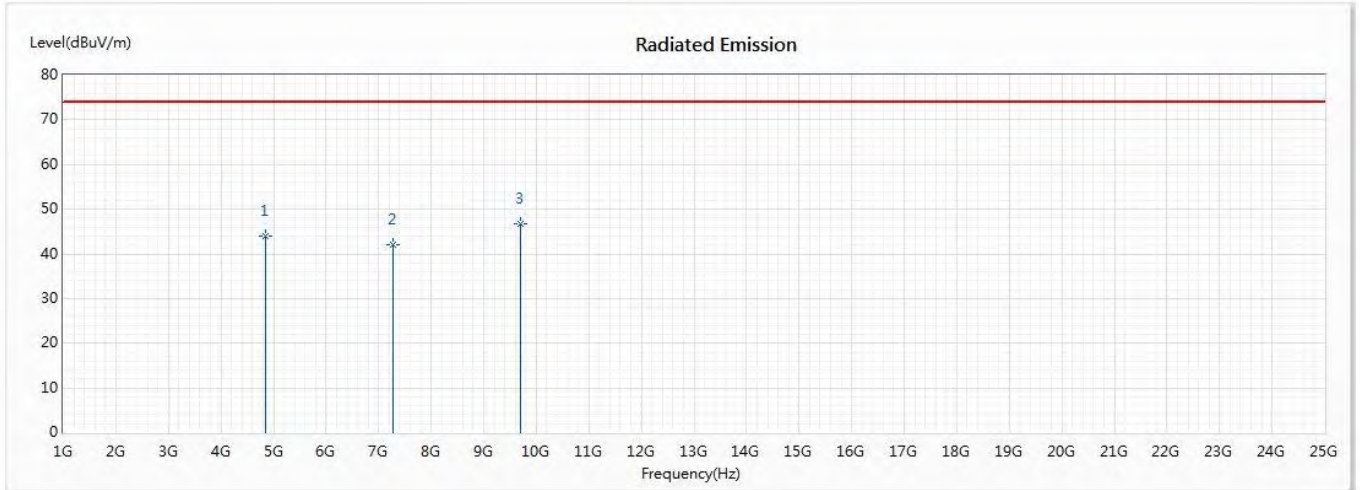

No	Frequency (MHz)	Emission Level (dBuV/m)	Limit (dBuV/m)	Margin (dB)	Reading Level (dBuV)	Correct Factor (dB/m)	Detector Type
1	4854	43.93	74.00	-30.07	55.69	-11.76	PK
2	7281	42.15	74.00	-31.85	55.33	-13.18	PK
* 3	9708	46.60	74.00	-27.40	59.23	-12.63	PK

Note:

1. All Readings below 1GHz are Quasi-Peak, above 1GHz are performed with peak and/or average measurements as necessary.
2. Measurement Level = Reading Level + Correct Factor.
3. Correct Factor = Antenna factor + Cable loss – Amplifier gain.
4. The average measurement was not performed when the peak measured data under the limit of average detection.
5. The emission levels of other frequencies are very lower than the limit and not show in test report.

Product : WiFi SOM Module
 Test Item : Harmonic Radiated Emission Data
 Test Date : 2019/12/31
 Test Mode : Mode 4:802.11n-40 (2432 MHz)

Horizontal

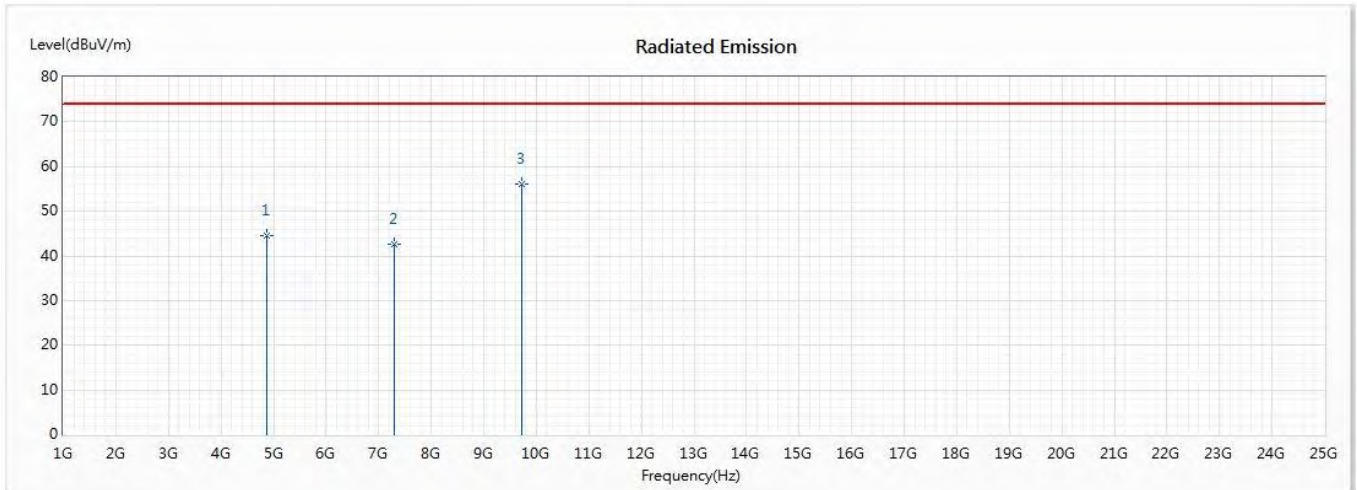

No	Frequency (MHz)	Emission Level (dBuV/m)	Limit (dBuV/m)	Margin (dB)	Reading Level (dBuV)	Correct Factor (dB/m)	Detector Type
1	4864	44.42	74.00	-29.58	56.12	-11.70	PK
2	7296	42.49	74.00	-31.51	55.83	-13.34	PK
* 3	9728	56.02	74.00	-17.98	68.54	-12.52	PK

Note:

1. All Readings below 1GHz are Quasi-Peak, above 1GHz are performed with peak and/or average measurements as necessary.
2. Measurement Level = Reading Level + Correct Factor.
3. Correct Factor = Antenna factor + Cable loss – Amplifier gain.
4. The average measurement was not performed when the peak measured data under the limit of average detection.
5. The emission levels of other frequencies are very lower than the limit and not show in test report.

Product : WiFi SOM Module
 Test Item : Harmonic Radiated Emission Data
 Test Date : 2019/12/31
 Test Mode : Mode 4:802.11n-40 (2432 MHz)

Horizontal

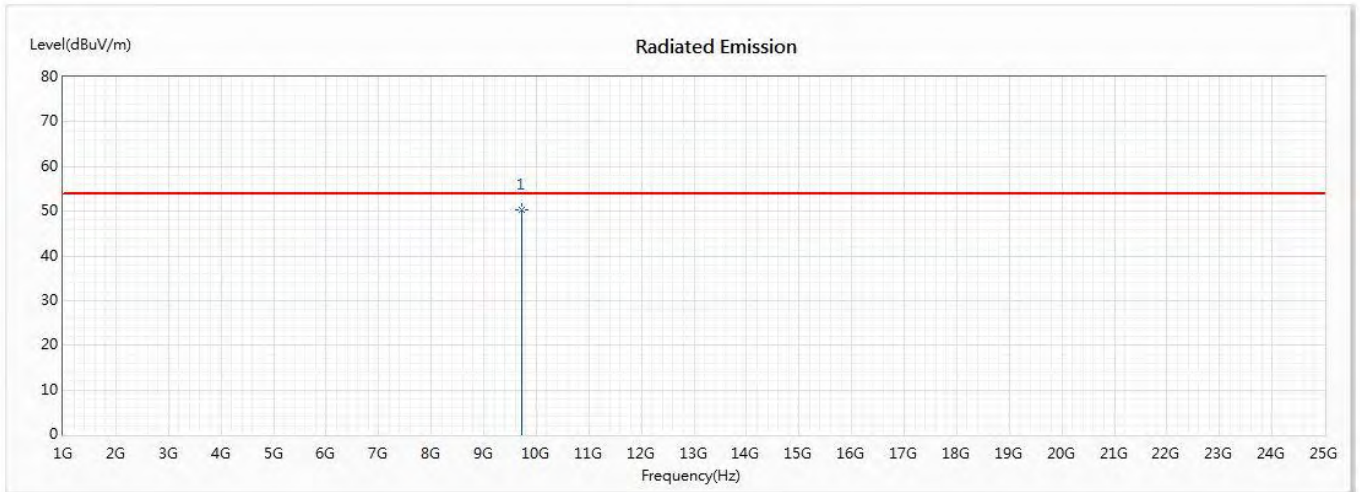

No	Frequency (MHz)	Emission Level (dBuV/m)	Limit (dBuV/m)	Margin (dB)	Reading Level (dBuV)	Correct Factor (dB/m)	Detector Type
* 1	9728	50.38	54.00	-3.62	62.90	-12.52	AV

Note:

1. All Readings below 1GHz are Quasi-Peak, above 1GHz are performed with peak and/or average measurements as necessary.
2. Measurement Level = Reading Level + Correct Factor.
3. Correct Factor = Antenna factor + Cable loss – Amplifier gain.
4. The average measurement was not performed when the peak measured data under the limit of average detection.
5. The emission levels of other frequencies are very lower than the limit and not show in test report.

Product : WiFi SOM Module
 Test Item : Harmonic Radiated Emission Data
 Test Date : 2019/12/31
 Test Mode : Mode 4:802.11n-40 (2432 MHz)

Vertical

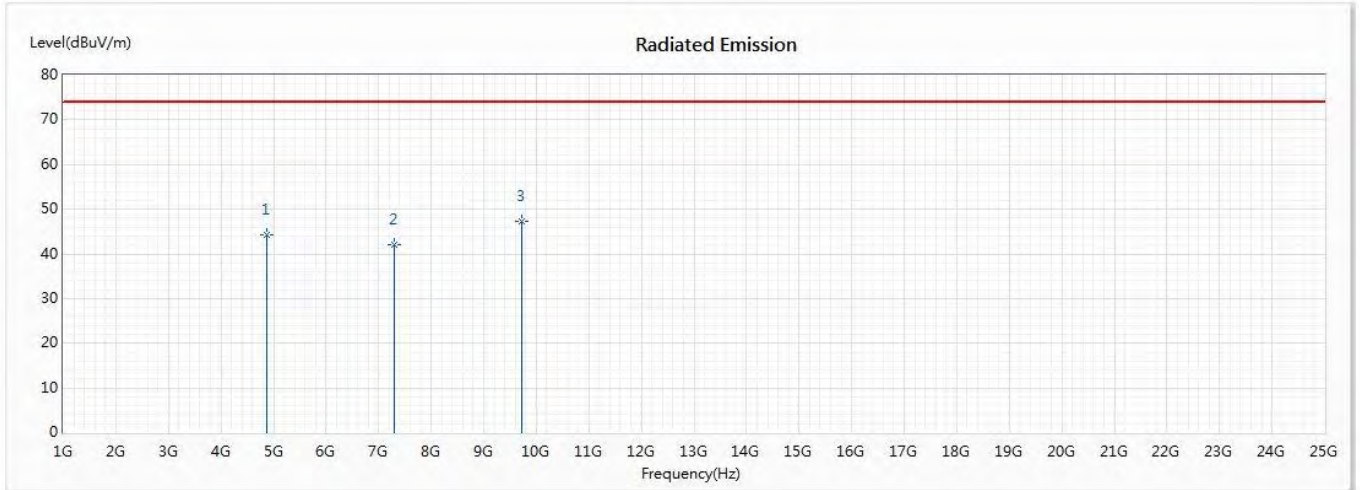

No	Frequency (MHz)	Emission Level (dBuV/m)	Limit (dBuV/m)	Margin (dB)	Reading Level (dBuV)	Correct Factor (dB/m)	Detector Type
1	4864	44.39	74.00	-29.61	56.09	-11.70	PK
2	7296	42.16	74.00	-31.84	55.50	-13.34	PK
* 3	9728	47.35	74.00	-26.65	59.87	-12.52	PK

Note:

1. All Readings below 1GHz are Quasi-Peak, above 1GHz are performed with peak and/or average measurements as necessary.
2. Measurement Level = Reading Level + Correct Factor.
3. Correct Factor = Antenna factor + Cable loss – Amplifier gain.
4. The average measurement was not performed when the peak measured data under the limit of average detection.
5. The emission levels of other frequencies are very lower than the limit and not show in test report.

Product : WiFi SOM Module
 Test Item : Harmonic Radiated Emission Data
 Test Date : 2019/12/31
 Test Mode : Mode 4:802.11n-40 (2437MHz)

Horizontal

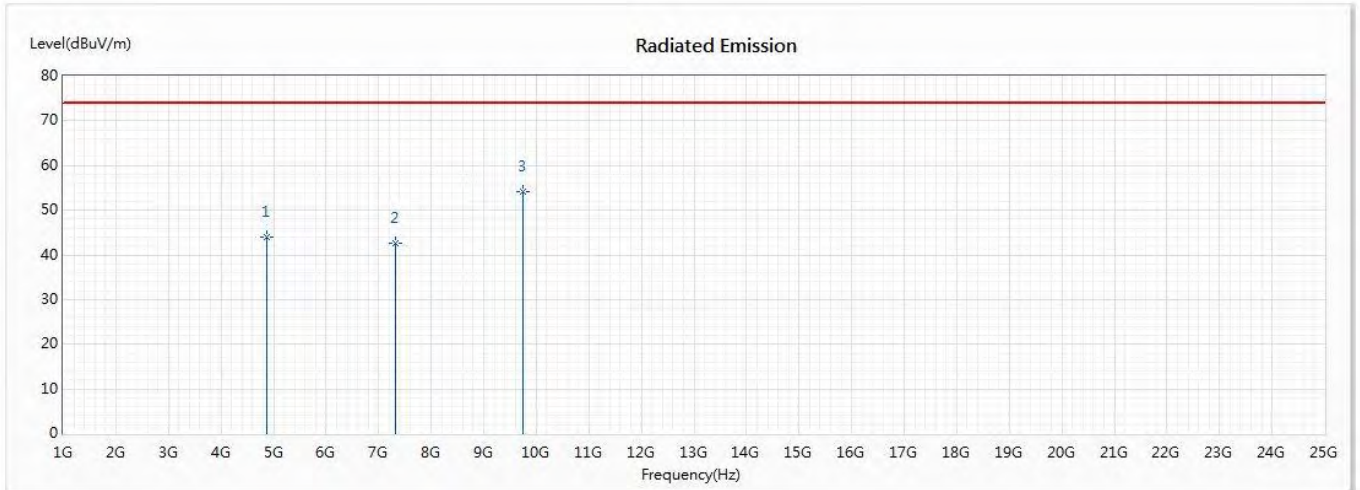

No	Frequency (MHz)	Emission Level (dBuV/m)	Limit (dBuV/m)	Margin (dB)	Reading Level (dBuV)	Correct Factor (dB/m)	Detector Type
1	4874	43.90	74.00	-30.10	55.54	-11.64	PK
2	7311	42.52	74.00	-31.48	56.00	-13.48	PK
* 3	9748	54.26	74.00	-19.74	66.65	-12.39	PK

Note:

1. All Readings below 1GHz are Quasi-Peak, above 1GHz are performed with peak and/or average measurements as necessary.
2. Measurement Level = Reading Level + Correct Factor.
3. Correct Factor = Antenna factor + Cable loss – Amplifier gain.
4. The average measurement was not performed when the peak measured data under the limit of average detection.
5. The emission levels of other frequencies are very lower than the limit and not show in test report.

Product : WiFi SOM Module
 Test Item : Harmonic Radiated Emission Data
 Test Date : 2019/12/31
 Test Mode : Mode 4:802.11n-40 (2437MHz)

Horizontal

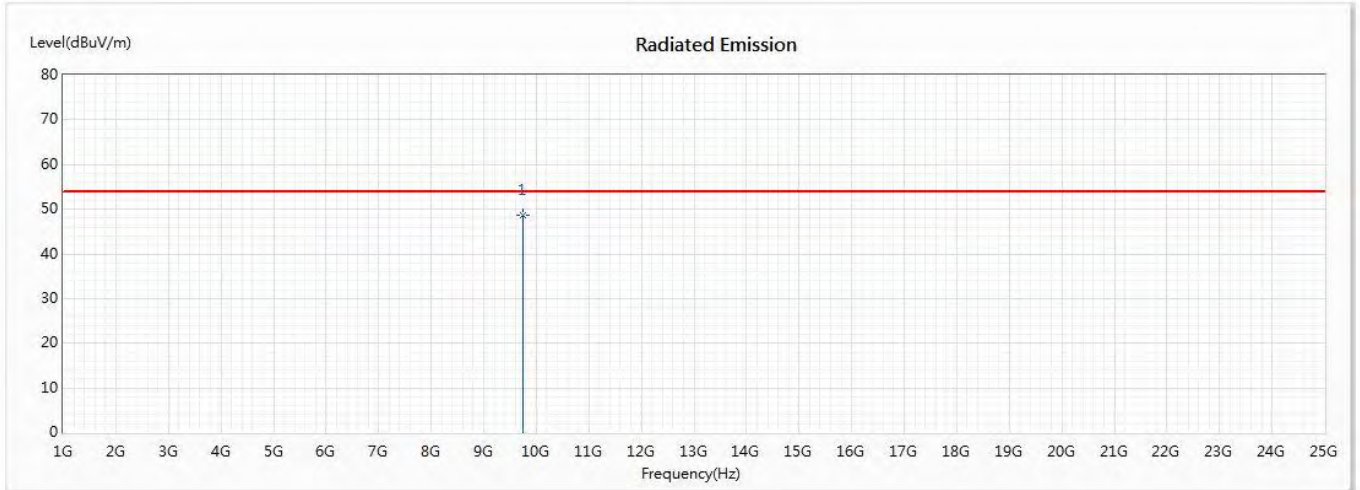

No	Frequency (MHz)	Emission Level (dBuV/m)	Limit (dBuV/m)	Margin (dB)	Reading Level (dBuV)	Correct Factor (dB/m)	Detector Type
* 1	9748	48.59	54.00	-5.41	60.98	-12.39	AV

Note:

1. All Readings below 1GHz are Quasi-Peak, above 1GHz are performed with peak and/or average measurements as necessary.
2. Measurement Level = Reading Level + Correct Factor.
3. Correct Factor = Antenna factor + Cable loss – Amplifier gain.
4. The average measurement was not performed when the peak measured data under the limit of average detection.
5. The emission levels of other frequencies are very lower than the limit and not show in test report.

Product : WiFi SOM Module
 Test Item : Harmonic Radiated Emission Data
 Test Date : 2019/12/31
 Test Mode : Mode 4:802.11n-40 (2437MHz)

Vertical

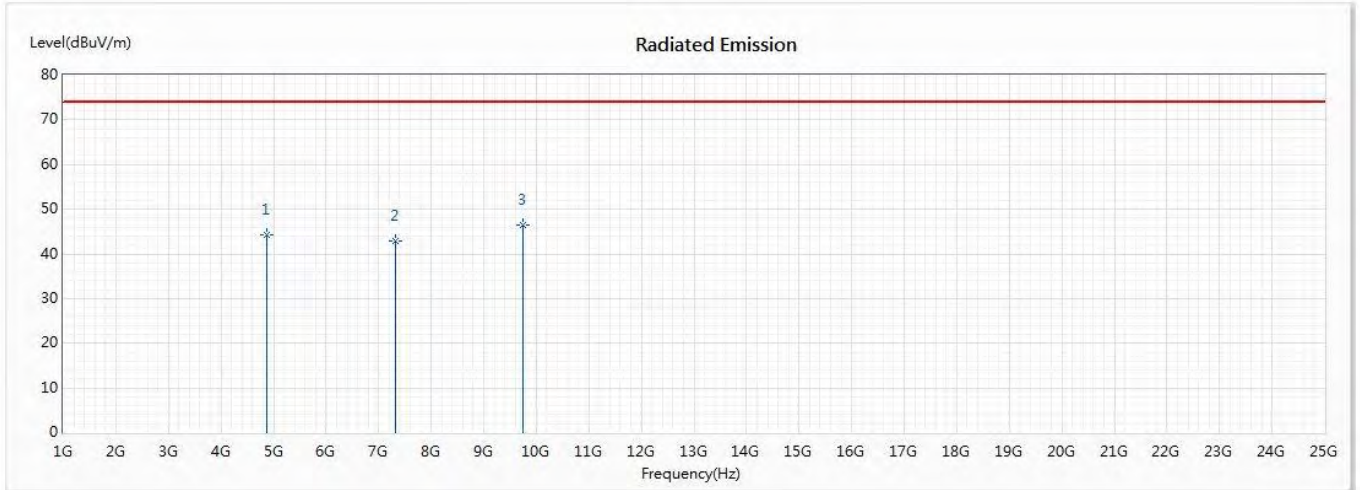

No	Frequency (MHz)	Emission Level (dBuV/m)	Limit (dBuV/m)	Margin (dB)	Reading Level (dBuV)	Correct Factor (dB/m)	Detector Type
1	4874	44.14	74.00	-29.86	55.78	-11.64	AV
2	7311	42.81	74.00	-31.19	56.29	-13.48	AV
* 3	9748	46.44	74.00	-27.56	58.83	-12.39	PK

Note:

1. All Readings below 1GHz are Quasi-Peak, above 1GHz are performed with peak and/or average measurements as necessary.
2. Measurement Level = Reading Level + Correct Factor.
3. Correct Factor = Antenna factor + Cable loss – Amplifier gain.
4. The average measurement was not performed when the peak measured data under the limit of average detection.
5. The emission levels of other frequencies are very lower than the limit and not show in test report.

Product : WiFi SOM Module
 Test Item : Harmonic Radiated Emission Data
 Test Date : 2019/12/31
 Test Mode : Mode 4:802.11n-40 (2442MHz)

Horizontal

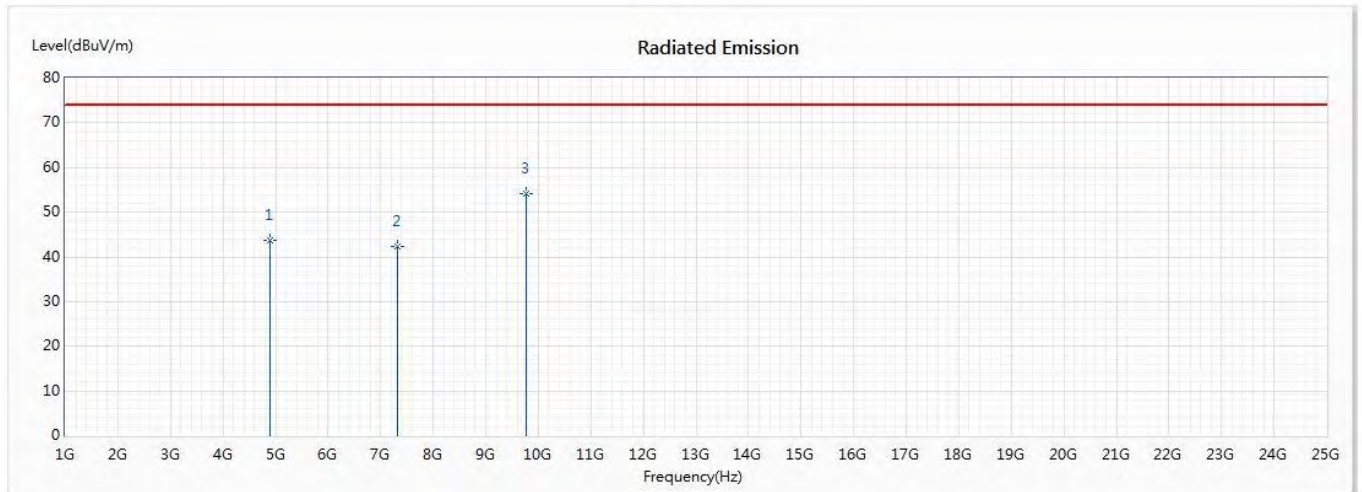

No	Frequency (MHz)	Emission Level (dBuV/m)	Limit (dBuV/m)	Margin (dB)	Reading Level (dBuV)	Correct Factor (dB/m)	Detector Type
1	4884	43.79	74.00	-30.21	55.37	-11.58	PK
2	7326	42.42	74.00	-31.58	56.02	-13.60	PK
* 3	9768	54.07	74.00	-19.93	66.64	-12.57	PK

Note:

1. All Readings below 1GHz are Quasi-Peak, above 1GHz are performed with peak and/or average measurements as necessary.
2. Measurement Level = Reading Level + Correct Factor.
3. Correct Factor = Antenna factor + Cable loss – Amplifier gain.
4. The average measurement was not performed when the peak measured data under the limit of average detection.
5. The emission levels of other frequencies are very lower than the limit and not show in test report.

Product : WiFi SOM Module
 Test Item : Harmonic Radiated Emission Data
 Test Date : 2019/12/31
 Test Mode : Mode 4:802.11n-40 (2442MHz)

Horizontal

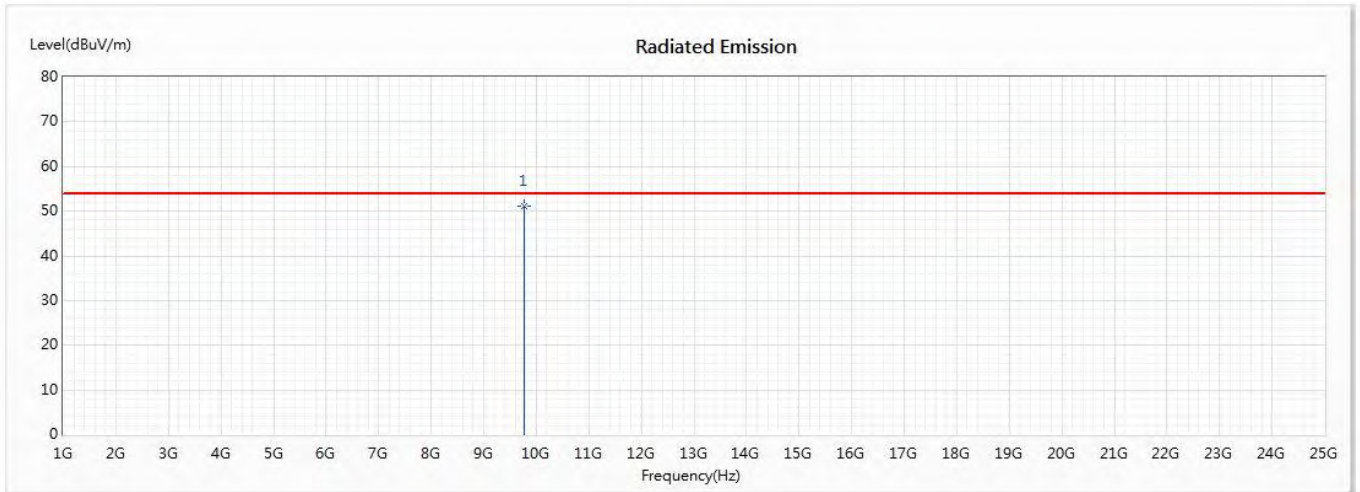

No	Frequency (MHz)	Emission Level (dBuV/m)	Limit (dBuV/m)	Margin (dB)	Reading Level (dBuV)	Correct Factor (dB/m)	Detector Type
* 1	9768	51.23	54.00	-2.77	63.80	-12.57	AV

Note:

1. All Readings below 1GHz are Quasi-Peak, above 1GHz are performed with peak and/or average measurements as necessary.
2. Measurement Level = Reading Level + Correct Factor.
3. Correct Factor = Antenna factor + Cable loss – Amplifier gain.
4. The average measurement was not performed when the peak measured data under the limit of average detection.
5. The emission levels of other frequencies are very lower than the limit and not show in test report.

Product : WiFi SOM Module
 Test Item : Harmonic Radiated Emission Data
 Test Date : 2019/12/31
 Test Mode : Mode 4:802.11n-40 (2442MHz)

Vertical

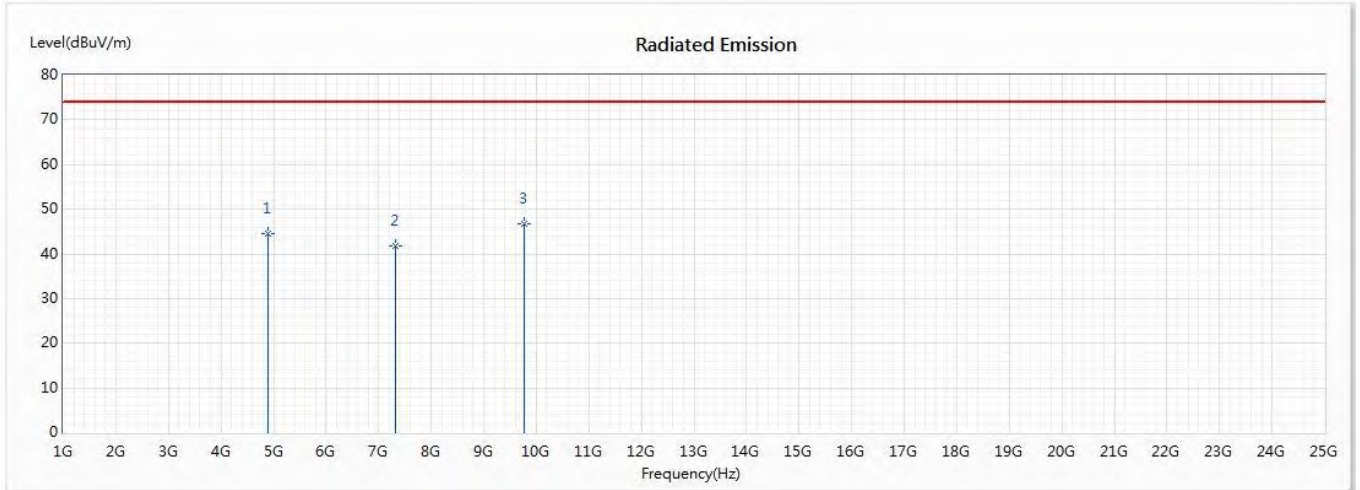

No	Frequency (MHz)	Emission Level (dBuV/m)	Limit (dBuV/m)	Margin (dB)	Reading Level (dBuV)	Correct Factor (dB/m)	Detector Type
1	4884	44.43	74.00	-29.57	56.01	-11.58	PK
2	7326	41.82	74.00	-32.18	55.42	-13.60	PK
* 3	9768	46.75	74.00	-27.25	59.32	-12.57	PK

Note:

1. All Readings below 1GHz are Quasi-Peak, above 1GHz are performed with peak and/or average measurements as necessary.
2. Measurement Level = Reading Level + Correct Factor.
3. Correct Factor = Antenna factor + Cable loss – Amplifier gain.
4. The average measurement was not performed when the peak measured data under the limit of average detection.
5. The emission levels of other frequencies are very lower than the limit and not show in test report.

Product : WiFi SOM Module
 Test Item : Harmonic Radiated Emission Data
 Test Date : 2019/12/31
 Test Mode : Mode 4:802.11n-40 (2447 MHz)

Horizontal

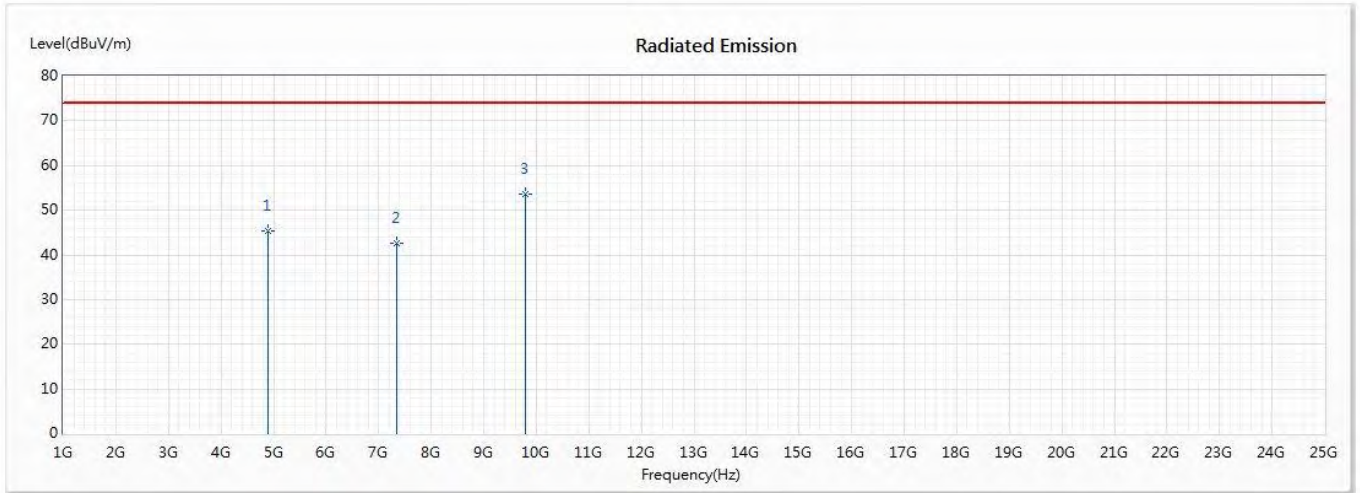

No	Frequency (MHz)	Emission Level (dBuV/m)	Limit (dBuV/m)	Margin (dB)	Reading Level (dBuV)	Correct Factor (dB/m)	Detector Type
1	4894	45.30	74.00	-28.70	56.82	-11.52	PK
2	7341	42.66	74.00	-31.34	56.38	-13.72	PK
* 3	9788	53.66	74.00	-20.34	66.45	-12.79	PK

Note:

1. All Readings below 1GHz are Quasi-Peak, above 1GHz are performed with peak and/or average measurements as necessary.
2. Measurement Level = Reading Level + Correct Factor.
3. Correct Factor = Antenna factor + Cable loss – Amplifier gain.
4. The average measurement was not performed when the peak measured data under the limit of average detection.
5. The emission levels of other frequencies are very lower than the limit and not show in test report.

Product : WiFi SOM Module
 Test Item : Harmonic Radiated Emission Data
 Test Date : 2019/12/31
 Test Mode : Mode 4:802.11n-40 (2447 MHz)

Vertical

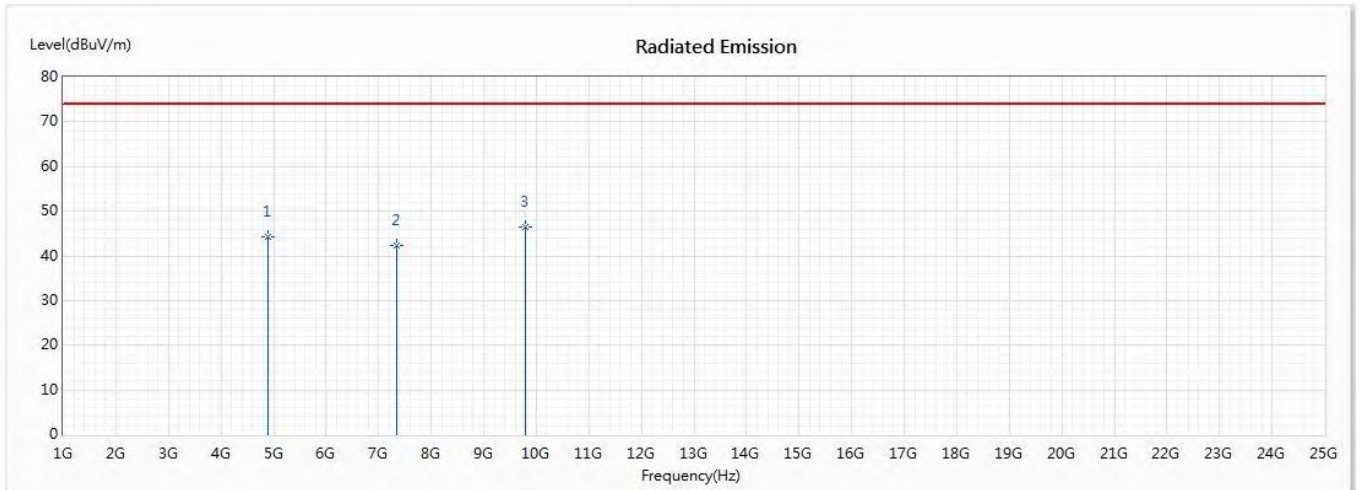

No	Frequency (MHz)	Emission Level (dBuV/m)	Limit (dBuV/m)	Margin (dB)	Reading Level (dBuV)	Correct Factor (dB/m)	Detector Type
1	4894	44.33	74.00	-29.67	55.85	-11.52	PK
2	7341	42.47	74.00	-31.53	56.19	-13.72	PK
* 3	9788	46.42	74.00	-27.58	59.21	-12.79	PK

Note:

1. All Readings below 1GHz are Quasi-Peak, above 1GHz are performed with peak and/or average measurements as necessary.
2. Measurement Level = Reading Level + Correct Factor.
3. Correct Factor = Antenna factor + Cable loss – Amplifier gain.
4. The average measurement was not performed when the peak measured data under the limit of average detection.
5. The emission levels of other frequencies are very lower than the limit and not show in test report.

Product : WiFi SOM Module
 Test Item : Harmonic Radiated Emission Data
 Test Date : 2019/12/31
 Test Mode : Mode 4:802.11n-40 (2452 MHz)

Horizontal

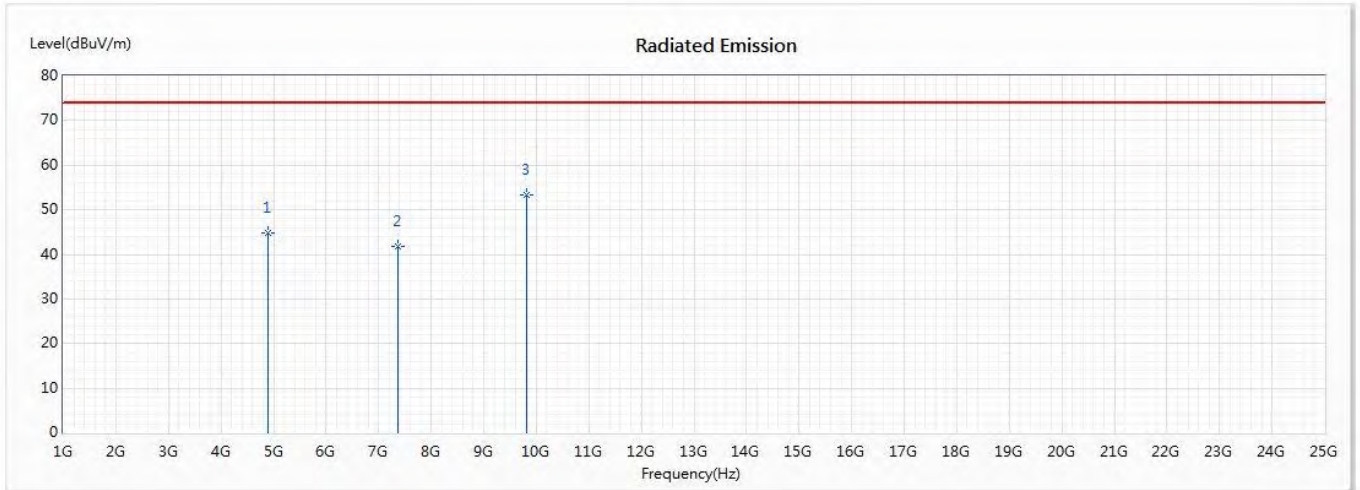

No	Frequency (MHz)	Emission Level (dBuV/m)	Limit (dBuV/m)	Margin (dB)	Reading Level (dBuV)	Correct Factor (dB/m)	Detector Type
1	4904	44.81	74.00	-29.19	56.25	-11.44	PK
2	7356	41.84	74.00	-32.16	55.68	-13.84	PK
* 3	9808	53.41	74.00	-20.59	66.41	-13.00	PK

Note:

1. All Readings below 1GHz are Quasi-Peak, above 1GHz are performed with peak and/or average measurements as necessary.
2. Measurement Level = Reading Level + Correct Factor.
3. Correct Factor = Antenna factor + Cable loss – Amplifier gain.
4. The average measurement was not performed when the peak measured data under the limit of average detection.
5. The emission levels of other frequencies are very lower than the limit and not show in test report.

Product : WiFi SOM Module
 Test Item : Harmonic Radiated Emission Data
 Test Date : 2019/12/31
 Test Mode : Mode 4:802.11n-40 (2452 MHz)

Vertical

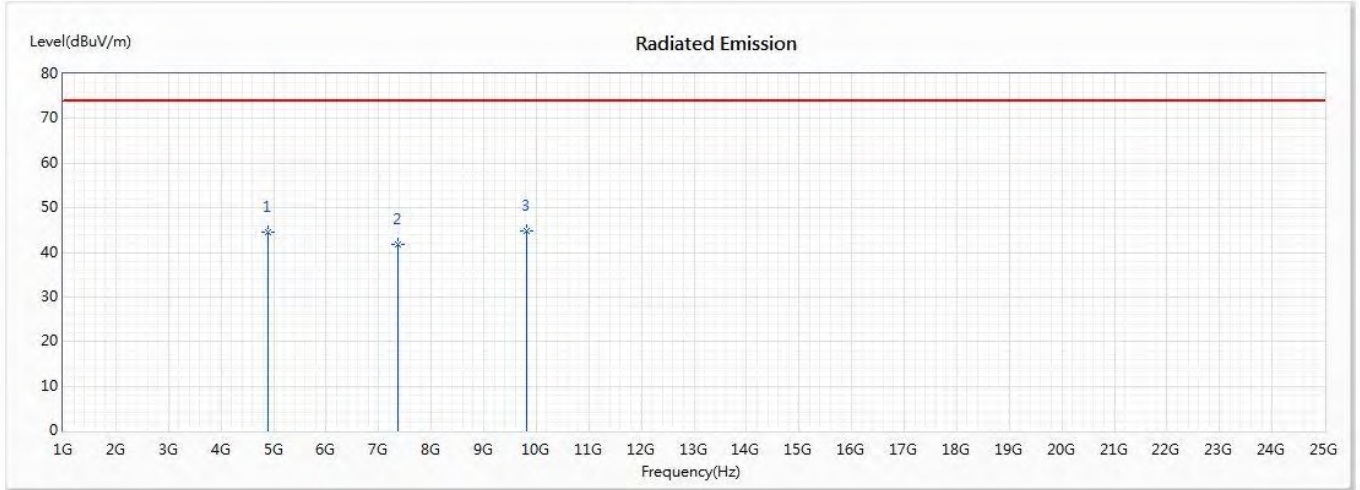

No	Frequency (MHz)	Emission Level (dBuV/m)	Limit (dBuV/m)	Margin (dB)	Reading Level (dBuV)	Correct Factor (dB/m)	Detector Type
1	4904	44.46	74.00	-29.54	55.90	-11.44	PK
2	7356	41.91	74.00	-32.09	55.75	-13.84	PK
* 3	9808	44.93	74.00	-29.07	57.93	-13.00	PK

Note:

1. All Readings below 1GHz are Quasi-Peak, above 1GHz are performed with peak and/or average measurements as necessary.
2. Measurement Level = Reading Level + Correct Factor.
3. Correct Factor = Antenna factor + Cable loss – Amplifier gain.
4. The average measurement was not performed when the peak measured data under the limit of average detection.
5. The emission levels of other frequencies are very lower than the limit and not show in test report.

Product : WiFi SOM Module
 Test Item : General Radiated Emission Data
 Test Date : 2020/01/02
 Test Mode : Mode 1:802.11b (2437 MHz)

Horizontal

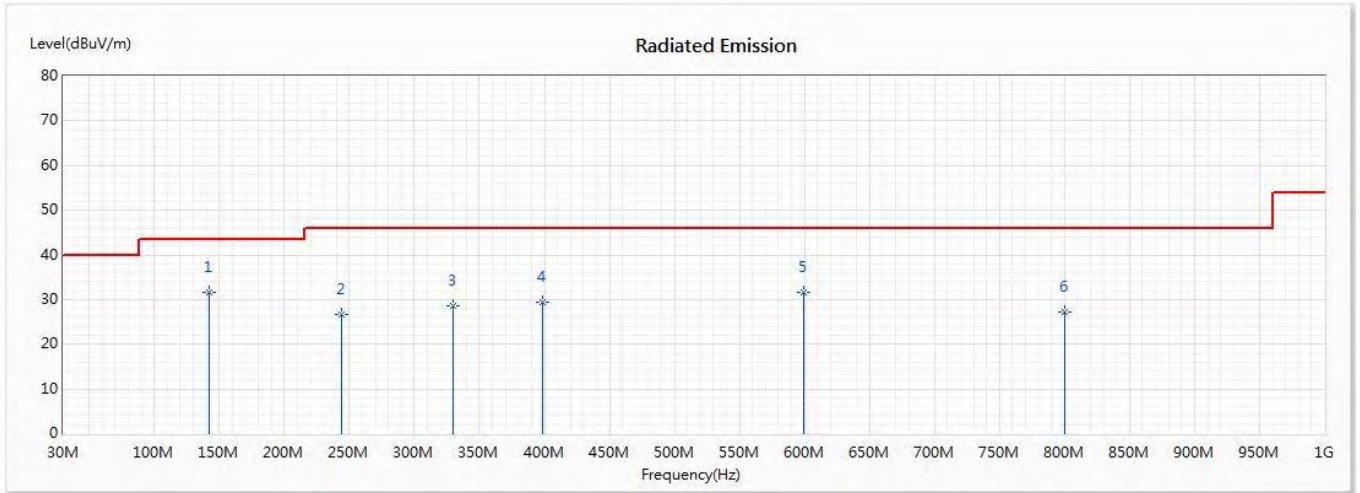

No	Frequency (MHz)	Emission Level (dBuV/m)	Limit (dBuV/m)	Margin (dB)	Reading Level (dBuV)	Correct Factor (dB/m)	Detector Type
* 1	142.464	31.51	43.50	-11.99	49.68	-18.17	QP
2	243.681	26.65	46.00	-19.35	44.99	-18.34	QP
3	329.435	28.47	46.00	-17.53	42.48	-14.01	QP
4	398.319	29.51	46.00	-16.49	43.06	-13.55	QP
5	599.348	31.54	46.00	-14.46	38.17	-6.63	QP
6	800.377	27.29	46.00	-18.71	36.22	-8.93	QP

Note:

1. All Readings below 1GHz are Quasi-Peak, above 1GHz are performed with peak and/or average measurements as necessary.
2. Measurement Level = Reading Level + Correct Factor.
3. Correct Factor = Antenna factor + Cable loss – Amplifier gain.
4. The emission levels of other frequencies are very lower than the limit and not show in test report.
5. No emission found between lowest internal used/generated frequency to 30MHz.

Product : WiFi SOM Module
 Test Item : General Radiated Emission Data
 Test Date : 2020/01/02
 Test Mode : Mode 1:802.11b (2437 MHz)

Vertical

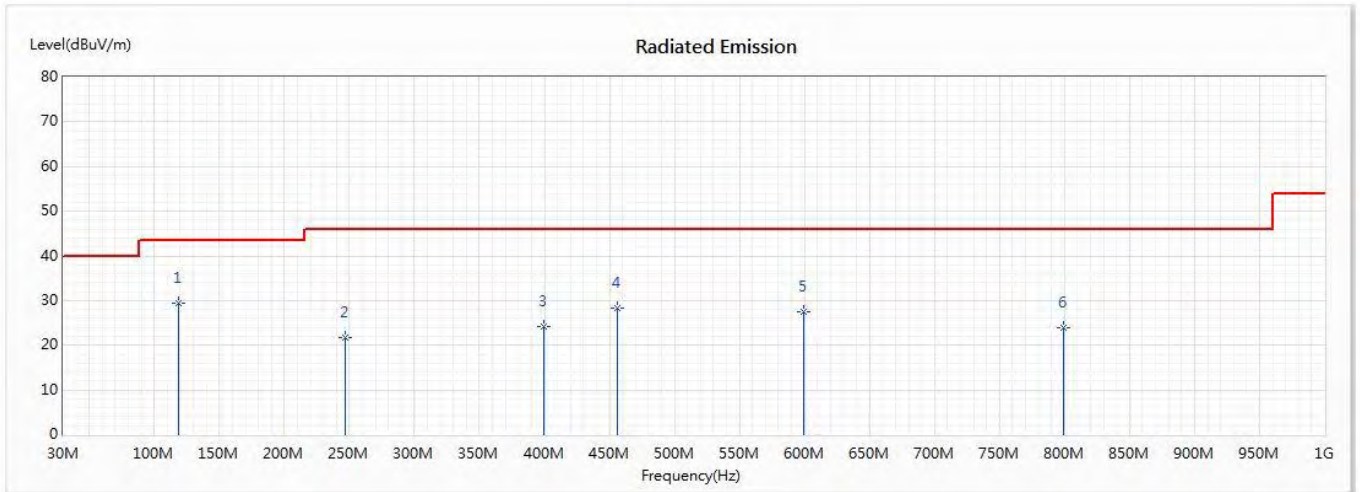

No	Frequency (MHz)	Emission Level (dBuV/m)	Limit (dBuV/m)	Margin (dB)	Reading Level (dBuV)	Correct Factor (dB/m)	Detector Type
* 1	118.565	29.50	43.50	-14.00	46.40	-16.90	QP
2	246.493	21.59	46.00	-24.41	39.74	-18.15	QP
3	399.725	24.10	46.00	-21.90	37.77	-13.67	QP
4	455.957	28.20	46.00	-17.80	38.55	-10.35	QP
5	599.348	27.60	46.00	-18.40	34.23	-6.63	QP
6	798.971	23.83	46.00	-22.17	32.74	-8.91	QP

Note:

1. All Readings below 1GHz are Quasi-Peak, above 1GHz are performed with peak and/or average measurements as necessary.
2. Measurement Level = Reading Level + Correct Factor.
3. Correct Factor = Antenna factor + Cable loss – Amplifier gain.
4. The emission levels of other frequencies are very lower than the limit and not show in test report.
5. No emission found between lowest internal used/generated frequency to 30MHz.

Product : WiFi SOM Module
 Test Item : General Radiated Emission Data
 Test Date : 2020/01/02
 Test Mode : Mode 2:802.11g (2437 MHz)

Horizontal

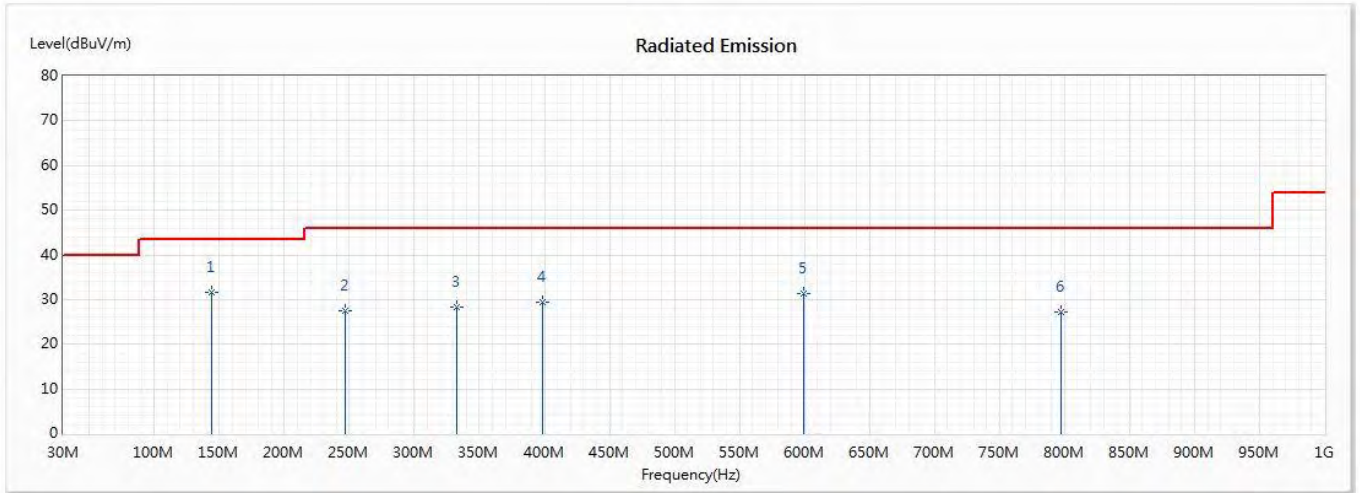

No	Frequency (MHz)	Emission Level (dBuV/m)	Limit (dBuV/m)	Margin (dB)	Reading Level (dBuV)	Correct Factor (dB/m)	Detector Type
* 1	143.87	31.61	43.50	-11.89	50.08	-18.47	QP
2	246.493	27.52	46.00	-18.48	45.67	-18.15	QP
3	332.246	28.34	46.00	-17.66	42.33	-13.99	QP
4	398.319	29.50	46.00	-16.50	43.05	-13.55	QP
5	599.348	31.45	46.00	-14.55	38.08	-6.63	QP
6	797.565	27.25	46.00	-18.75	36.14	-8.89	QP

Note:

1. All Readings below 1GHz are Quasi-Peak, above 1GHz are performed with peak and/or average measurements as necessary.
2. Measurement Level = Reading Level + Correct Factor.
3. Correct Factor = Antenna factor + Cable loss – Amplifier gain.
4. The emission levels of other frequencies are very lower than the limit and not show in test report.
5. No emission found between lowest internal used/generated frequency to 30MHz.

Product : WiFi SOM Module
 Test Item : General Radiated Emission Data
 Test Date : 2020/01/02
 Test Mode : Mode 2:802.11g (2437 MHz)

Vertical

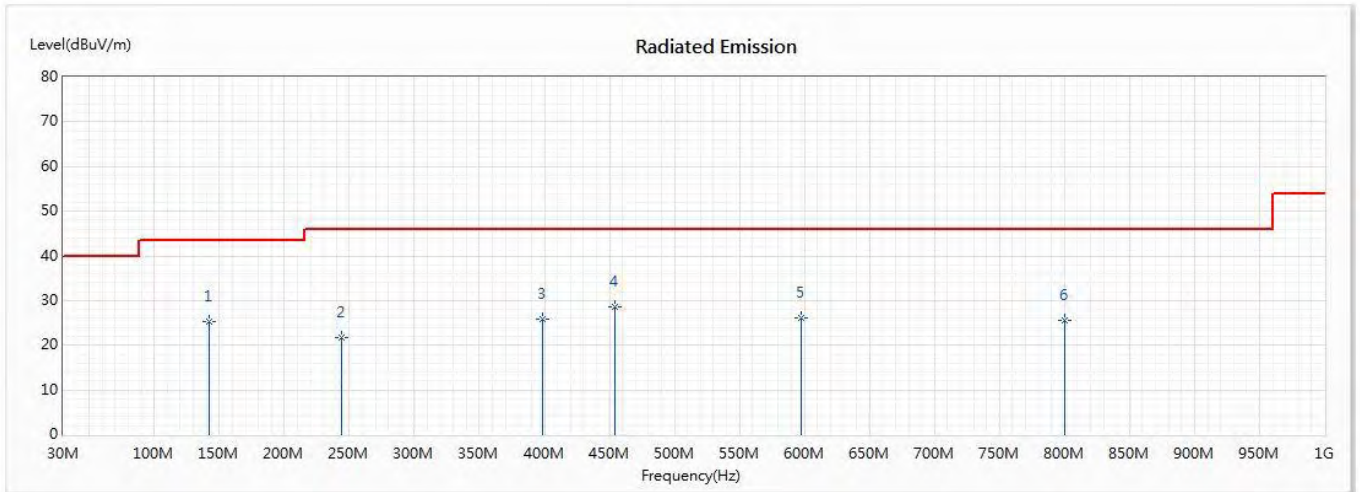

No	Frequency (MHz)	Emission Level (dBuV/m)	Limit (dBuV/m)	Margin (dB)	Reading Level (dBuV)	Correct Factor (dB/m)	Detector Type
1	142.464	25.24	43.50	-18.26	43.41	-18.17	QP
2	243.681	21.73	46.00	-24.27	40.07	-18.34	QP
3	398.319	25.86	46.00	-20.14	39.41	-13.55	QP
* 4	454.551	28.55	46.00	-17.45	38.84	-10.29	QP
5	597.942	26.16	46.00	-19.84	32.86	-6.70	QP
6	800.377	25.68	46.00	-20.32	34.61	-8.93	QP

Note:

1. All Readings below 1GHz are Quasi-Peak, above 1GHz are performed with peak and/or average measurements as necessary.
2. Measurement Level = Reading Level + Correct Factor.
3. Correct Factor = Antenna factor + Cable loss – Amplifier gain.
4. The emission levels of other frequencies are very lower than the limit and not show in test report.
5. No emission found between lowest internal used/generated frequency to 30MHz.

Product : WiFi SOM Module
 Test Item : General Radiated Emission Data
 Test Date : 2020/01/02
 Test Mode : Mode 3:802.11n-20 (2437 MHz)

Horizontal

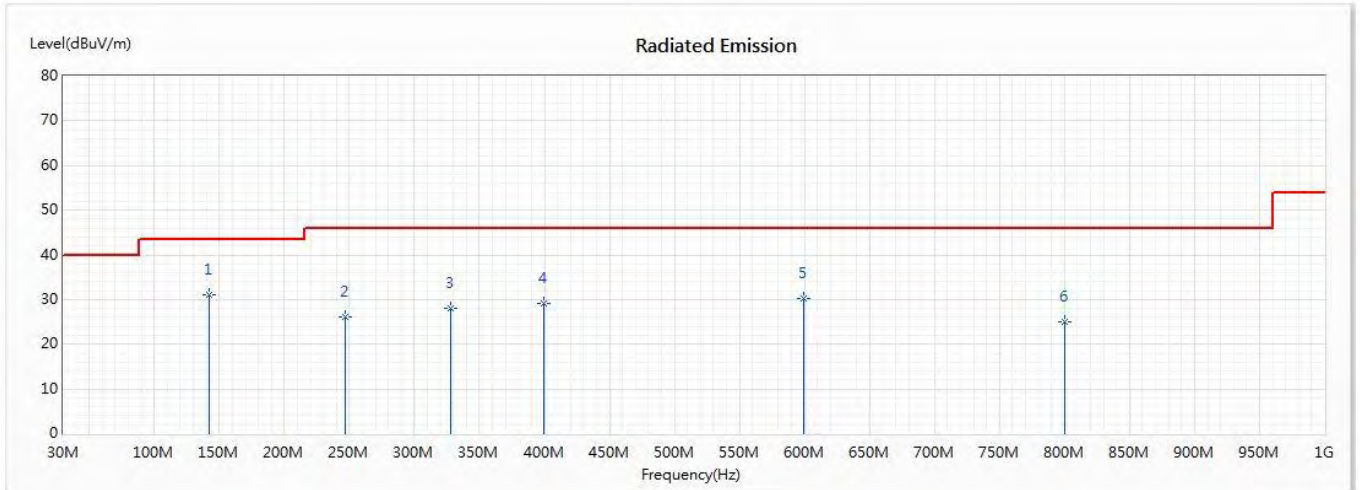

No	Frequency (MHz)	Emission Level (dBuV/m)	Limit (dBuV/m)	Margin (dB)	Reading Level (dBuV)	Correct Factor (dB/m)	Detector Type
* 1	142.464	31.02	43.50	-12.48	49.19	-18.17	QP
2	246.493	26.22	46.00	-19.78	44.37	-18.15	QP
3	328.029	28.05	46.00	-17.95	42.07	-14.02	QP
4	399.725	29.21	46.00	-16.79	42.88	-13.67	QP
5	599.348	30.32	46.00	-15.68	36.95	-6.63	QP
6	800.377	25.08	46.00	-20.92	34.01	-8.93	QP

Note:

1. All Readings below 1GHz are Quasi-Peak, above 1GHz are performed with peak and/or average measurements as necessary.
2. Measurement Level = Reading Level + Correct Factor.
3. Correct Factor = Antenna factor + Cable loss – Amplifier gain.
4. The emission levels of other frequencies are very lower than the limit and not show in test report.
5. No emission found between lowest internal used/generated frequency to 30MHz.

Product : WiFi SOM Module
 Test Item : General Radiated Emission Data
 Test Date : 2020/01/02
 Test Mode : Mode 3:802.11n-20 (2437 MHz)

Vertical

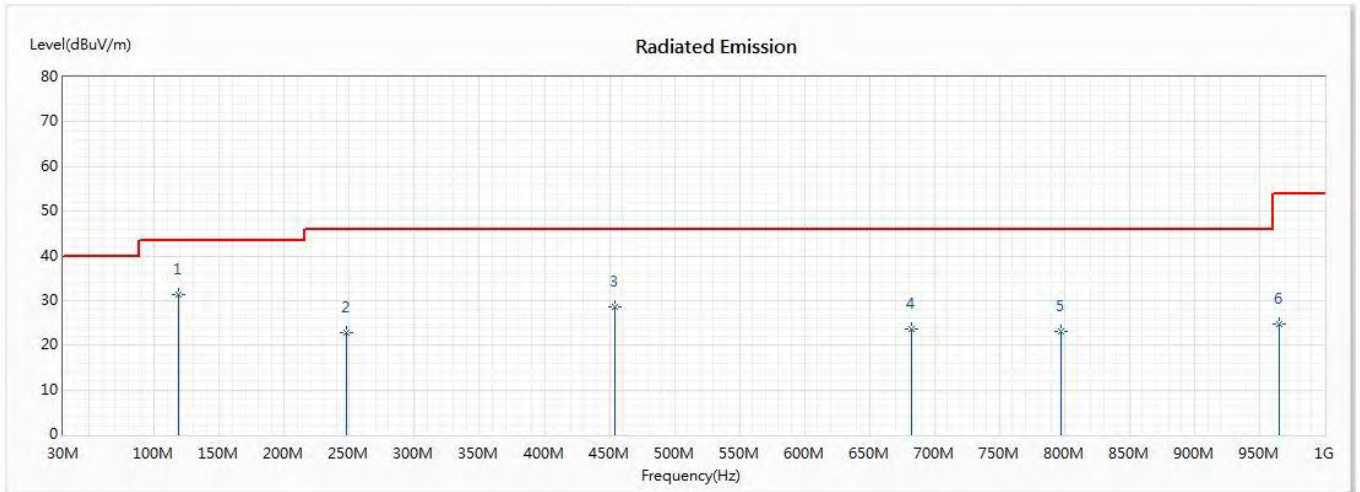

No	Frequency (MHz)	Emission Level (dBuV/m)	Limit (dBuV/m)	Margin (dB)	Reading Level (dBuV)	Correct Factor (dB/m)	Detector Type
* 1	118.565	31.43	43.50	-12.07	48.33	-16.90	QP
2	247.899	22.70	46.00	-23.30	40.76	-18.06	QP
3	454.551	28.72	46.00	-17.28	39.01	-10.29	QP
4	682.29	23.67	46.00	-22.33	32.94	-9.27	QP
5	797.565	23.10	46.00	-22.90	31.99	-8.89	QP
6	964.855	24.73	54.00	-29.27	33.03	-8.30	QP

Note:

1. All Readings below 1GHz are Quasi-Peak, above 1GHz are performed with peak and/or average measurements as necessary.
2. Measurement Level = Reading Level + Correct Factor.
3. Correct Factor = Antenna factor + Cable loss – Amplifier gain.
4. The emission levels of other frequencies are very lower than the limit and not show in test report.
5. No emission found between lowest internal used/generated frequency to 30MHz.

Product : WiFi SOM Module
 Test Item : General Radiated Emission Data
 Test Date : 2020/01/02
 Test Mode : Mode 4:802.11n-40 (2437Hz)

Horizontal

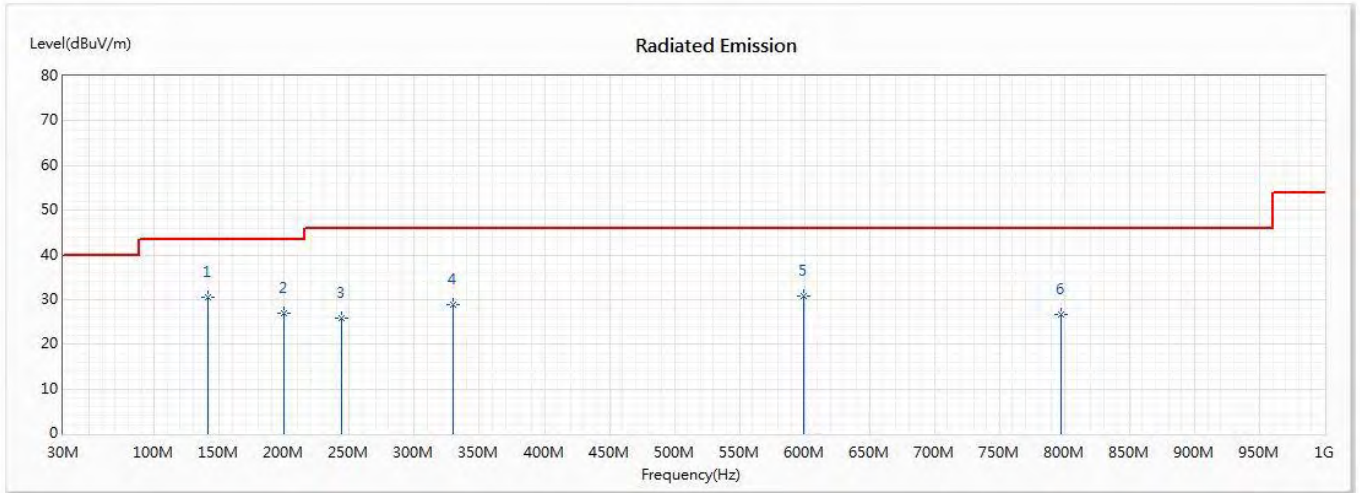

No	Frequency (MHz)	Emission Level (dBuV/m)	Limit (dBuV/m)	Margin (dB)	Reading Level (dBuV)	Correct Factor (dB/m)	Detector Type
* 1	141.058	30.47	43.50	-13.03	48.32	-17.85	QP
2	200.101	26.82	43.50	-16.68	44.96	-18.14	QP
3	243.681	25.91	46.00	-20.09	44.25	-18.34	QP
4	329.435	28.76	46.00	-17.24	42.77	-14.01	QP
5	599.348	30.73	46.00	-15.27	37.36	-6.63	QP
6	797.565	26.80	46.00	-19.20	35.69	-8.89	QP

Note:

1. All Readings below 1GHz are Quasi-Peak, above 1GHz are performed with peak and/or average measurements as necessary.
2. Measurement Level = Reading Level + Correct Factor.
3. Correct Factor = Antenna factor + Cable loss – Amplifier gain.
4. The emission levels of other frequencies are very lower than the limit and not show in test report.
5. No emission found between lowest internal used/generated frequency to 30MHz.

Product : WiFi SOM Module
 Test Item : General Radiated Emission Data
 Test Date : 2020/01/02
 Test Mode : Mode 4:802.11n-40 (2437 MHz)

Vertical

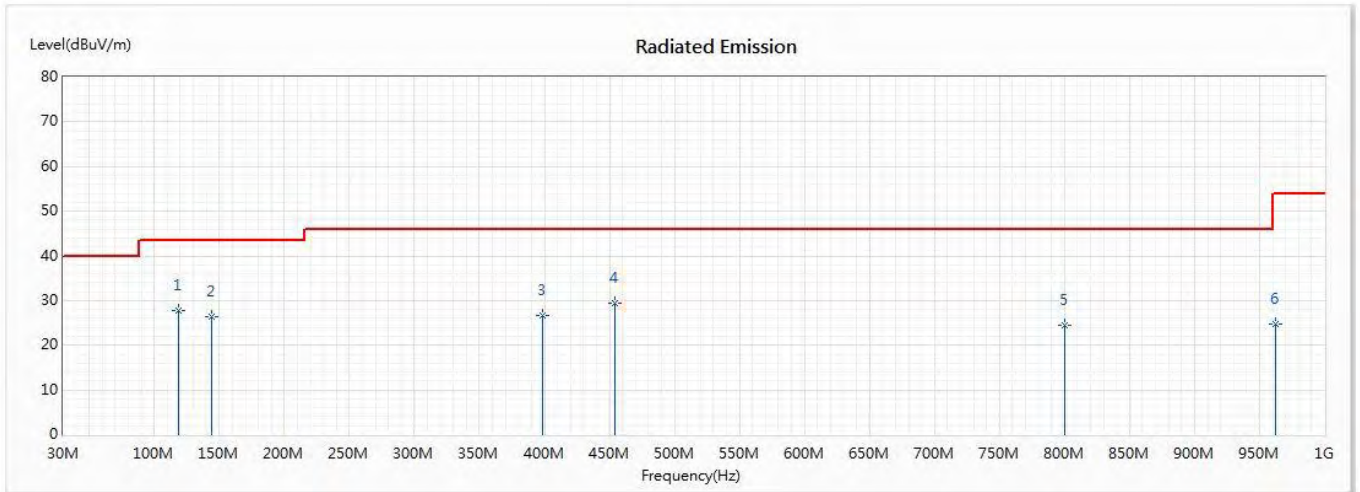

No	Frequency (MHz)	Emission Level (dBuV/m)	Limit (dBuV/m)	Margin (dB)	Reading Level (dBuV)	Correct Factor (dB/m)	Detector Type
* 1	118.565	27.81	43.50	-15.69	44.71	-16.90	QP
2	143.87	26.45	43.50	-17.05	44.92	-18.47	QP
3	398.319	26.74	46.00	-19.26	40.29	-13.55	QP
4	454.551	29.35	46.00	-16.65	39.64	-10.29	QP
5	800.377	24.55	46.00	-21.45	33.48	-8.93	QP
6	962.043	24.84	54.00	-29.16	33.21	-8.37	QP

Note:

1. All Readings below 1GHz are Quasi-Peak, above 1GHz are performed with peak and/or average measurements as necessary.
2. Measurement Level = Reading Level + Correct Factor.
3. Correct Factor = Antenna factor + Cable loss – Amplifier gain.
4. The emission levels of other frequencies are very lower than the limit and not show in test report.
5. No emission found between lowest internal used/generated frequency to 30MHz.

4. Band Edge

4.1. Test Setup

RF Radiated Measurement:

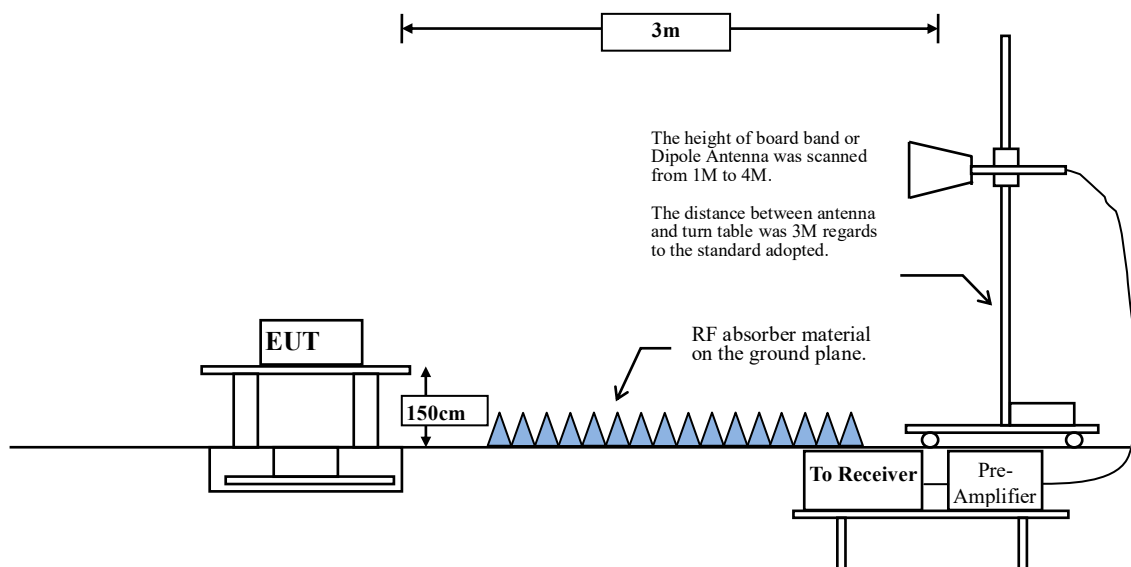

4.2. Limits

Emissions radiated outside of the specified frequency bands, except for harmonics, shall be attenuated by at least 20dB below the level of the fundamental or to the general radiated emission limits in paragraph 15.209, whichever is the lesser attenuation.

4.3. Test Procedure

The EUT was setup according to ANSI C63.10, 2013 and tested according to DTS test procedure of KDB558074 for compliance to FCC 47CFR 15.247 requirements.

The EUT is placed on a turn table which is 1.5 meter above ground. The turn table is rotated 360 degrees to determine the position of the maximum emission level. The EUT was positioned such that the distance from antenna to the EUT was 3 meters.

The antenna is scanned from 1 meter to 4 meters to find out the maximum emission level. This is repeated for both horizontal and vertical polarization of the antenna. In order to find the maximum emission, all of the interface cables were manipulated according to ANSI C63.10:2013 on radiated measurement.

RBW and VBW Parameter setting:

According to KDB 558074 Peak power measurement procedure

RBW = as specified in Table 1.

VBW \geq 3 x RBW.

Table 1 —RBW as a function of frequency

Frequency	RBW
9-150 kHz	200-300 Hz
0.15-30 MHz	9-10 kHz
30-1000 MHz	100-120 kHz
> 1000 MHz	1 MHz

According to KDB 558074 Average power measurement procedure

RBW = 1MHz.

VBW = 10Hz, when duty cycle \geq 98 %

VBW \geq 1/T, when duty cycle < 98 %

(T refers to the minimum transmission duration over which the transmitter is on and is transmitting at its maximum power control level for the tested mode of operation.)

2.4GHz band	Duty Cycle (%)	T (ms)	1/T (Hz)	VBW (Hz)
802.11b	98.83	12.3180	81	--
802.11g	94.63	2.0435	489	500
802.11n20	89.33	0.9710	1030	2000
802.11n40	83.74	0.4928	2029	3000

Note: Duty Cycle Refer to Section 5

4.4. Uncertainty

± 4.08 dB above 1GHz

± 4.22 dB below 1GHz

4.5. Test Result of Band Edge

Product : WiFi SOM Module
 Test Item : Band Edge
 Test Date : 2019/12/27
 Test Mode : Mode 1:802.11b (2412MHz)

Horizontal

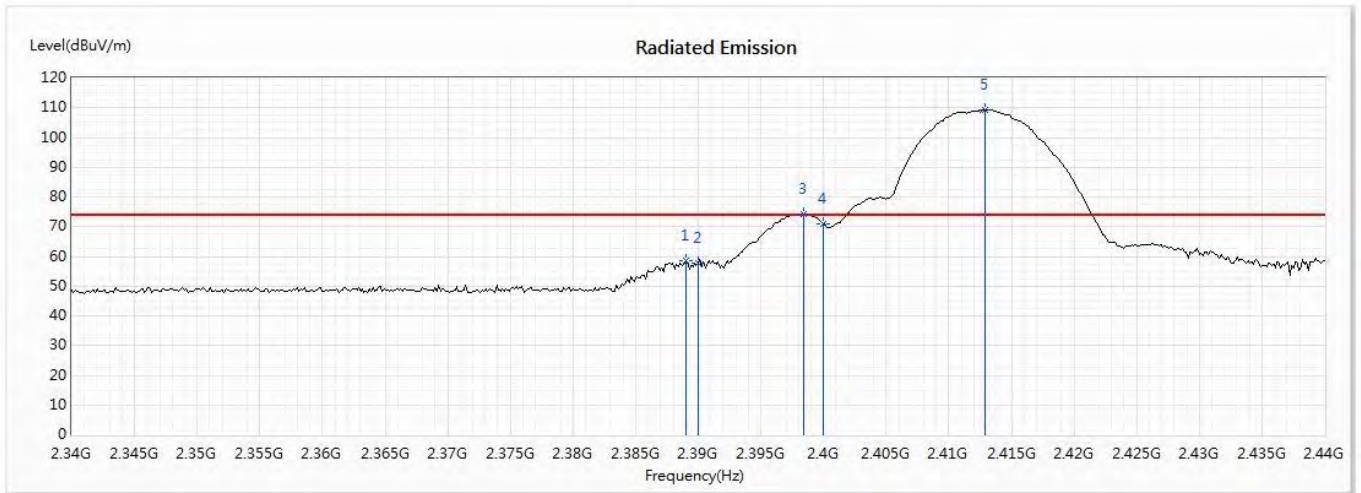

No	Frequency (MHz)	Emission Level (dBuV/m)	Limit (dBuV/m)	Margin (dB)	Reading Level (dBuV)	Correct Factor (dB/m)	Detector Type
1	2388.986	58.74	74.00	-15.26	45.85	12.89	PK
2	2390	57.70	74.00	-16.30	44.81	12.89	PK
! 3	2398.406	74.29	--	--	61.34	12.95	PK
4	2400	70.94	--	--	57.98	12.96	PK
! 5	2412.899	109.47	--	--	96.42	13.05	PK

Note:

1. All readings above 1GHz are performed with peak and/or average measurements as necessary.
2. Measurement Level = Reading Level + Correct Factor.
3. The average measurement was not performed when the peak measured data under the limit of average detection.

Product : WiFi SOM Module
 Test Item : Band Edge
 Test Date : 2019/12/27
 Test Mode : Mode 1:802.11b (2412MHz)

Horizontal

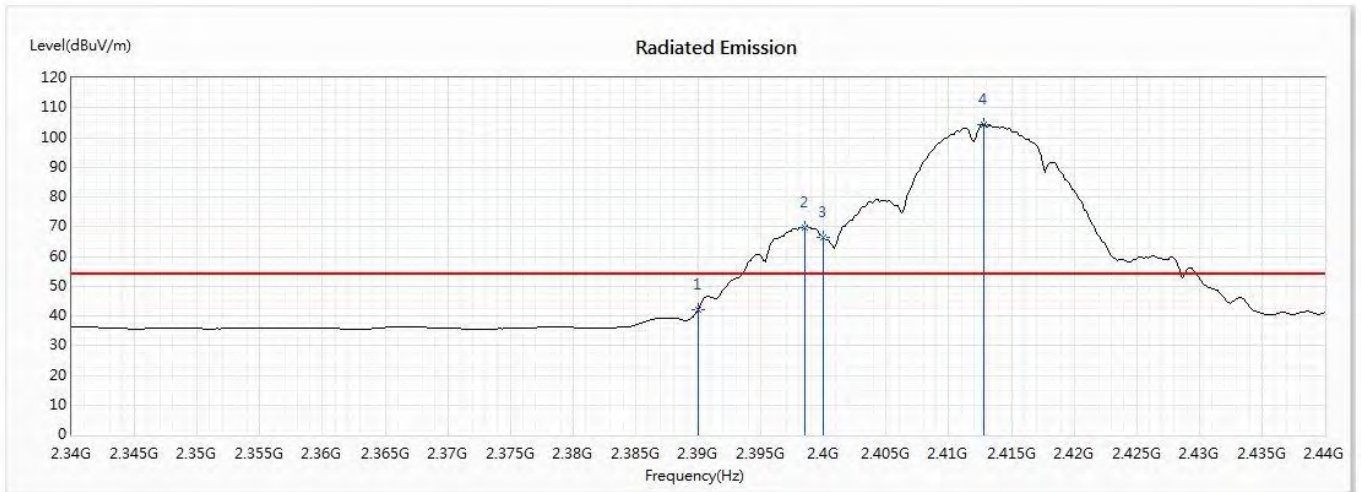

No	Frequency (MHz)	Emission Level (dBuV/m)	Limit (dBuV/m)	Margin (dB)	Reading Level (dBuV)	Correct Factor (dB/m)	Detector Type
1	2390	42.22	54.00	-11.78	29.33	12.89	AV
! 2	2398.551	69.72	--	--	56.77	12.95	AV
! 3	2400	66.26	--	--	53.30	12.96	AV
! 4	2412.754	104.35	--	--	91.30	13.05	AV

Note:

1. All readings above 1GHz are performed with peak and/or average measurements as necessary.
2. Measurement Level = Reading Level + Correct Factor.
3. The average measurement was not performed when the peak measured data under the limit of average detection.