



A D T

DFS TEST REPORT

REPORT NO.: RF130927E08D-2

MODEL NO.: FiOS-G1100

FCC ID: 2ABTEG1100

RECEIVED: Dec. 25, 2013

TESTED: Sep. 05, 2014

ISSUED: Sep. 16, 2014

APPLICANT: Verizon Online LLC

ADDRESS: 1300 I Street NW, Room 400W, Washington,
District of Columbia, 20005 United State

ISSUED BY: Bureau Veritas Consumer Products Services
(H.K.) Ltd., Taoyuan Branch Hsin Chu Laboratory

LAB ADDRESS : No. 81-1, Lu Liao Keng, 9th Ling, Wu Lung Tsuen,
Chiung Lin Hsiang, Hsin Chu Hsien 307, Taiwan,
R.O.C.

This report should not be used by the client to claim product certification, approval, or endorsement by TAF or any government agencies.



This report is for your exclusive use. Any copying or replication of this report to or for any other person or entity, or use of our name or trademark, is permitted only with our prior written permission. This report sets forth our findings solely with respect to the test samples identified herein. The results set forth in this report are not indicative or representative of the quality or characteristics of the lot from which a test sample was taken or any similar or identical product unless specifically and expressly noted. Our report includes all of the tests requested by you and the results thereof based upon the information that you provided to us. You have 60 days from date of issuance of this report to notify us of any material error or omission caused by our negligence, provided, however, that such notice shall be in writing and shall specifically address the issue you wish to raise. A failure to raise such issue within the prescribed time shall constitute your unqualified acceptance of the completeness of this report, the tests conducted and the correctness of the report contents. Unless specific mention, the uncertainty of measurement has been explicitly taken into account to declare the compliance or non-compliance to the specification



Table of Contents

- RELEASE CONTROL RECORD 3
- 1. CERTIFICATION 4
- 2. EUT INFORMATION 5
 - 2.1 OPERATING FREQUENCY BANDS AND MODE OF EUT 5
 - 2.2 EUT SOFTWARE AND FIRMWARE VERSION 5
 - 2.3 DESCRIPTION OF AVAILABLE ANTENNAS TO THE EUT 6
 - 2.4 EUT MAXIMUM CONDUCTED POWER 7
 - 2.5 EUT MAXIMUM EIRP POWER 16
 - 2.6 TRANSMIT POWER CONTROL (TPC) 25
 - 2.7 STATEMENT OF MAUNFACTURER 25
- 3. U-NII DFS RULE REQUIREMENTS 26
 - 3.1 WORKING MODES AND REQUIRED TEST ITEMS 26
 - 3.2 TEST LIMITS AND RADAR SIGNAL PARAMETERS 27
- 4. TEST & SUPPORT EQUIPMENT LIST 29
 - 4.1 TEST INSTRUMENTS 29
 - 4.2 DESCRIPTION OF SUPPORT UNITS 29
- 5. TEST PROCEDURE 30
 - 5.1 BVADT DFS MEASUREMENT SYSTEM: 30
 - 5.2 CALIBRATION OF DFS DETECTION THRESHOLD LEVEL: 31
 - 5.3 DEVIATION FROM TEST STANDARD 32
 - 5.4 CONDUCTED TEST SETUP CONFIGURATION 32
- 6.2.2 MASTER MODE 32
- 6. TEST RESULTS 33
 - 6.1 SUMMARY OF TEST RESULT 33
 - 6.1.1 MASTER MODE 33
 - 6.2 DETAILED TEST RESULTS 34
 - 6.2.1. TEST MODE: DEVICE OPERATING IN MASTER MODE 34
 - 6.2.1.1 DFS DETECTION THRESHOLD 34
 - 6.2.1.2 CHANNEL AVAILABILITY CHECK TIME 41
 - 6.2.1.3 CHANNEL CLOSING TRANSMISSION AND CHANNEL MOVE TIME 43
 - 6.2.1.4 NON- OCCUPANCY PERIOD 75
 - 6.2.1.5 UNIFORM SPREADING 77
 - 6.2.1.6 U-NII DETECTION BANDWIDTH 77
 - 6.2.1.7 NON-CO-CHANNEL TEST 84
- 7 INFORMATION ON THE TESTING LABORATORIES 85
- 8 APPENDIX-A 86
- 9 APPENDIX-B 87
- 10 APPENDIX-C 239



A D T

RELEASE CONTROL RECORD

ISSUE NO.	REASON FOR CHANGE	DATE ISSUED
RF130927E8D-2	Original release	Sep. 16, 2014



A D T

1. CERTIFICATION

PRODUCT: FiOS Quantum Gateway
BRAND NAME: Verizon
MODEL NO.: FiOS-G1100
TEST SAMPLE: ENGINEERING SAMPLE
APPLICANT: Verizon Online LLC
TESTED: Sep. 05, 2014
STANDARDS: FCC Part 15, Subpart E (Section 15.407)
FCC KDB 905462 D01

The above equipment (Model: FiOS-G1100) has been tested by **Bureau Veritas Consumer Products Services (H.K.) Ltd., Taoyuan Branch**, and was in compliance with the requirement of the above standards. The test record, data evaluation & Equipment Under Test (EUT) configurations represented herein are true and accurate accounts of the measurements of the sample's EMC characteristics under the conditions specified in this report.

PREPARED BY :  , **DATE:** Sep. 16, 2014
(Lori Chung, Specialist)

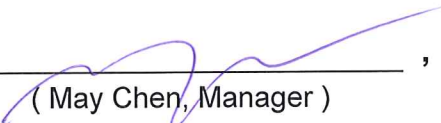
APPROVED BY :  , **DATE:** Sep. 16, 2014
(May Chen, Manager)



2. EUT INFORMATION

2.1 OPERATING FREQUENCY BANDS AND MODE OF EUT

Table 1: Operating frequency bands and mode of EUT.

Operational Mode	Operating Frequency Range	
	5250~5350MHz	5470~5725MHz (5600~5650MHz will be disable)
Master	✓	✓

2.2 EUT SOFTWARE AND FIRMWARE VERSION

Table 2: The EUT software/firmware version.

No.	Product	Model No.	Software/Firmware Version
1	FiOS Quantum Gateway	FiOS-G1100	0.18.4-bhr4-DFS



2.3 DESCRIPTION OF AVAILABLE ANTENNAS TO THE EUT

Table 3: Antenna list.

WLAN Antenna Spec.				
Transmitter Circuit	Gain (dBi) (Include cable loss)	Antenna Type	Connector Type	Frequency range (GHz to GHz)
Chain (0)	3.97	Metal	NA	2.4~2.4835
	3.56			5.15~5.25
	3.86			5.25~5.35
	4.05			5.47~5.725
	4.05			5.725~5.85
Chain (1)	4.1	Metal	NA	2.4~2.4835
	5.3			5.15~5.25
	5.75			5.25~5.35
	5.75			5.47~5.725
	5.71			5.725~5.85
Chain (2)	3.36	Metal	NA	2.4~2.4835
	4.6			5.15~5.25
	4.35			5.25~5.35
	4.35			5.47~5.725
	4.21			5.725~5.85
Z-Wave Antenna Spec.				
Gain (dBi) (Include cable loss)	Antenna Type	Connector Type	Frequency range (MHz to MHz)	
1.73	Metal	NA	902~928	

Summary antenna

Mode 1	3TX / Beamforming Mode MCS0NSS1	5.25~5.35	9.46
		5.47~5.725	9.52
Mode 2	3TX / CDD Mode	5.25~5.35	5.75
		5.47~5.725	5.75
Mode 3	3TX / STBC Mode	5.25~5.35	5.75
		5.47~5.725	5.75
Mode 4	3TX/ SDM Mode	5.25~5.35	5.75
		5.47~5.725	5.75
Mode 5	3TX / Beamforming Mode MCS0NSS2	5.25~5.35	7.51
		5.47~5.725	7.51
Mode 6	3TX / Beamforming Mode MCS0NSS3	5.25~5.35	5.75
		5.47~5.725	5.75
Mode7	2TX / Beamforming Mode MCS0NSS1	5.25~5.35	7.87
		5.47~5.725	7.95
Mode 8	2TX / Beamforming Mode MCS0NSS2	5.25~5.35	5.75
		5.47~5.725	5.75
Mode 9	2TX / CDD Mode	5.25~5.35	5.75
		5.47~5.725	5.75
Mode 10	2TX / STBC Mode	5.25~5.35	5.75
		5.47~5.725	5.75
Mode 11	2TX / SDM Mode	5.25~5.35	5.75
		5.47~5.725	5.75



2.4 EUT MAXIMUM CONDUCTED POWER

TABLE 4: THE MEASURED CONDUCTED OUTPUT POWER

IEEE 802.11a

Frequency Band(MHz)	MAX. Power	
	Output Power(mW)	Output Power(dBm)
5250~5350MHz	7.834	8.94
5470~5725MHz	14.028	11.47

IEEE 802.11ac VHT20

Mode 1. : 3TX / Beamforming Mode MCS0NSS1

Frequency Band(MHz)	MAX. Power	
	Output Power(mW)	Output Power(dBm)
5250~5350MHz	13.547	11.32
5470~5725MHz	67.047	18.26

Mode 2. : 3TX / CDD Mode

Frequency Band(MHz)	MAX. Power	
	Output Power(mW)	Output Power(dBm)
5250~5350MHz	13.547	11.32
5470~5725MHz	67.047	18.26

Mode 3. : 3TX / STBC Mode

Frequency Band(MHz)	MAX. Power	
	Output Power(mW)	Output Power(dBm)
5250~5350MHz	13.547	11.32
5470~5725MHz	51.213	17.09



A D T

Mode 4. : 3TX/ SDM Mode

Frequency Band(MHz)	MAX. Power	
	Output Power(mW)	Output Power(dBm)
5250~5350MHz	13.547	11.32
5470~5725MHz	67.047	18.26

Mode 5. : 3TX / Beamforming Mode MCS0NSS2

Frequency Band(MHz)	MAX. Power	
	Output Power(mW)	Output Power(dBm)
5250~5350MHz	13.547	11.32
5470~5725MHz	67.047	18.26

Mode 6. : 3TX / Beamforming Mode MCS0NSS3

Frequency Band(MHz)	MAX. Power	
	Output Power(mW)	Output Power(dBm)
5250~5350MHz	13.547	11.32
5470~5725MHz	67.047	18.26

Mode 7. : 2TX / Beamforming Mode MCS0NSS1

Frequency Band(MHz)	MAX. Power	
	Output Power(mW)	Output Power(dBm)
5250~5350MHz	17.589	12.45
5470~5725MHz	55.855	17.47

Mode 8. : 2TX / Beamforming Mode MCS0NSS2

Frequency Band(MHz)	MAX. Power	
	Output Power(mW)	Output Power(dBm)
5250~5350MHz	17.589	12.45
5470~5725MHz	55.855	17.47



A D T

Mode 9. : 2TX / CDD Mode

Frequency Band(MHz)	MAX. Power	
	Output Power(mW)	Output Power(dBm)
5250~5350MHz	17.589	12.45
5470~5725MHz	55.855	17.47

Mode 10. : 2TX / STBC Mode

Frequency Band(MHz)	MAX. Power	
	Output Power(mW)	Output Power(dBm)
5250~5350MHz	19.453	12.89
5470~5725MHz	63.341	18.02

Mode 11. : 2TX / SDM Mode

Frequency Band(MHz)	MAX. Power	
	Output Power(mW)	Output Power(dBm)
5250~5350MHz	17.589	12.45
5470~5725MHz	55.855	17.47



A D T

IEEE 802.11ac VHT40

Mode 1. : 3TX / Beamforming Mode MCS0NSS1

Frequency Band(MHz)	MAX. Power	
	Output Power(mW)	Output Power(dBm)
5250~5350MHz	32.593	15.13
5470~5725MHz	52.93	17.24

Mode 2. : 3TX / CDD Mode

Frequency Band(MHz)	MAX. Power	
	Output Power(mW)	Output Power(dBm)
5250~5350MHz	32.593	15.13
5470~5725MHz	52.93	17.24

Mode 3. : 3TX / STBC Mode

Frequency Band(MHz)	MAX. Power	
	Output Power(mW)	Output Power(dBm)
5250~5350MHz	32.593	15.13
5470~5725MHz	82.107	19.14

Mode 4. : 3TX / SDM Mode

Frequency Band(MHz)	MAX. Power	
	Output Power(mW)	Output Power(dBm)
5250~5350MHz	32.593	15.13
5470~5725MHz	52.93	17.24



A D T

Mode 5. : 3TX / Beamforming Mode MCS0NSS2

Frequency Band(MHz)	MAX. Power	
	Output Power(mW)	Output Power(dBm)
5250~5350MHz	32.593	15.13
5470~5725MHz	52.93	17.24

Mode 6. : 3TX / Beamforming Mode MCS0NSS3

Frequency Band(MHz)	MAX. Power	
	Output Power(mW)	Output Power(dBm)
5250~5350MHz	32.593	15.13
5470~5725MHz	52.93	17.24

Mode 7. : 2TX / Beamforming Mode MCS0NSS1

Frequency Band(MHz)	MAX. Power	
	Output Power(mW)	Output Power(dBm)
5250~5350MHz	37.456	15.74
5470~5725MHz	80.528	19.06

Mode 8. : 2TX / Beamforming Mode MCS0NSS2

Frequency Band(MHz)	MAX. Power	
	Output Power(mW)	Output Power(dBm)
5250~5350MHz	37.456	15.74
5470~5725MHz	80.528	19.06



A D T

Mode 9. : 2TX / CDD Mode

Frequency Band(MHz)	MAX. Power	
	Output Power(mW)	Output Power(dBm)
5250~5350MHz	37.456	15.74
5470~5725MHz	80.528	19.06

Mode 10. : 2TX / STBC Mode

Frequency Band(MHz)	MAX. Power	
	Output Power(mW)	Output Power(dBm)
5250~5350MHz	41.538	16.18
5470~5725MHz	93.307	19.7

Mode 11. : 2TX / SDM Mode

Frequency Band(MHz)	MAX. Power	
	Output Power(mW)	Output Power(dBm)
5250~5350MHz	37.456	15.74
5470~5725MHz	80.528	19.06

IEEE 802.11ac VHT80

Mode 1. : 3TX / Beamforming Mode MCS0NSS1

Frequency Band(MHz)	MAX. Power	
	Output Power(mW)	Output Power(dBm)
5250~5350MHz	39.38	15.95
5470~5725MHz	52.37	17.19



A D T

Mode 2. : 3TX / CDD Mode

Frequency Band(MHz)	MAX. Power	
	Output Power(mW)	Output Power(dBm)
5250~5350MHz	39.38	15.95
5470~5725MHz	52.37	17.19

Mode 3. : 3TX / STBC Mode

Frequency Band(MHz)	MAX. Power	
	Output Power(mW)	Output Power(dBm)
5250~5350MHz	39.38	15.95
5470~5725MHz	83.069	19.19

Mode 4. : 3TX / SDM Mode

Frequency Band(MHz)	MAX. Power	
	Output Power(mW)	Output Power(dBm)
5250~5350MHz	39.38	15.95
5470~5725MHz	52.37	17.19

Mode 5. : 3TX / Beamforming Mode MCS0NSS2

Frequency Band(MHz)	MAX. Power	
	Output Power(mW)	Output Power(dBm)
5250~5350MHz	39.38	15.95
5470~5725MHz	52.37	17.19



A D T

Mode 6. : 3TX / Beamforming Mode MCS0NSS3

Frequency Band(MHz)	MAX. Power	
	Output Power(mW)	Output Power(dBm)
5250~5350MHz	39.38	15.95
5470~5725MHz	52.37	17.19

Mode 7. : 2TX / Beamforming Mode MCS0NSS1

Frequency Band(MHz)	MAX. Power	
	Output Power(mW)	Output Power(dBm)
5250~5350MHz	47.709	16.79
5470~5725MHz	96.912	19.86

Mode 8. : 2TX / Beamforming Mode MCS0NSS2

Frequency Band(MHz)	MAX. Power	
	Output Power(mW)	Output Power(dBm)
5250~5350MHz	47.709	16.79
5470~5725MHz	96.912	19.86

Mode 9. : 2TX / CDD Mode

Frequency Band(MHz)	MAX. Power	
	Output Power(mW)	Output Power(dBm)
5250~5350MHz	47.709	16.79
5470~5725MHz	96.912	19.86



A D T

Mode 10. : 2TX / STBC Mode

Frequency Band(MHz)	MAX. Power	
	Output Power(mW)	Output Power(dBm)
5250~5350MHz	69.627	18.43
5470~5725MHz	96.912	19.86

Mode 11. : 2TX / SDM Mode

Frequency Band(MHz)	MAX. Power	
	Output Power(mW)	Output Power(dBm)
5250~5350MHz	47.709	16.79
5470~5725MHz	96.912	19.86



2.5 EUT MAXIMUM EIRP POWER

TABLE 5: THE EIRP OUTPUT POWER LIST

IEEE 802.11a

Frequency Band(MHz)	MAX. Power	
	Output Power(mW)	Output Power(dBm)
5250~5350MHz	19.054	12.8
5470~5725MHz	35.645	15.52

IEEE 802.11ac VHT20

Mode 1. : 3TX / Beamforming Mode MCS0NSS1

Frequency Band(MHz)	MAX. Power	
	Output Power(mW)	Output Power(dBm)
5250~5350MHz	119.631	20.78
5470~5725MHz	600.315	27.78

Mode 2. : 3TX / CDD Mode

Frequency Band(MHz)	MAX. Power	
	Output Power(mW)	Output Power(dBm)
5250~5350MHz	50.915	17.07
5470~5725MHz	251.988	24.01

Mode 3. : 3TX / STBC Mode

Frequency Band(MHz)	MAX. Power	
	Output Power(mW)	Output Power(dBm)
5250~5350MHz	50.915	17.07
5470~5725MHz	192.478	22.84



A D T

Mode 4. : 3TX / SDM Mode

Frequency Band(MHz)	MAX. Power	
	Output Power(mW)	Output Power(dBm)
5250~5350MHz	50.915	17.07
5470~5725MHz	251.988	24.01

Mode 5. : 3TX / Beamforming Mode MCS0NSS2

Frequency Band(MHz)	MAX. Power	
	Output Power(mW)	Output Power(dBm)
5250~5350MHz	76.356	18.83
5470~5725MHz	377.902	25.77

Mode 6. : 3TX / Beamforming Mode MCS0NSS3

Frequency Band(MHz)	MAX. Power	
	Output Power(mW)	Output Power(dBm)
5250~5350MHz	50.915	17.07
5470~5725MHz	251.988	24.01

Mode 7. : 2TX / Beamforming Mode MCS0NSS1

Frequency Band(MHz)	MAX. Power	
	Output Power(mW)	Output Power(dBm)
5250~5350MHz	107.706	20.32
5470~5725MHz	348.387	25.42



A D T

Mode 8. : 2TX/ Beamforming Mode MCS0NSS2

Frequency Band(MHz)	MAX. Power	
	Output Power(mW)	Output Power(dBm)
5250~5350MHz	66.106	18.2
5470~5725MHz	209.924	23.22

Mode 9. : 2TX /CDD Mode

Frequency Band(MHz)	MAX. Power	
	Output Power(mW)	Output Power(dBm)
5250~5350MHz	66.106	18.2
5470~5725MHz	209.924	23.22

Mode 10. : 2TX / STBC Mode

Frequency Band(MHz)	MAX. Power	
	Output Power(mW)	Output Power(dBm)
5250~5350MHz	73.112	18.64
5470~5725MHz	238.059	23.77

Mode 11. : 2TX / SDM Mode

Frequency Band(MHz)	MAX. Power	
	Output Power(mW)	Output Power(dBm)
5250~5350MHz	66.106	18.2
5470~5725MHz	209.924	23.22



IEEE 802.11ac VHT40

Mode 1. : 3TX / Beamforming Mode MCS0NSS1

Frequency Band(MHz)	MAX. Power	
	Output Power(mW)	Output Power(dBm)
5250~5350MHz	287.822	24.59
5470~5725MHz	473.917	26.76

Mode 2. : 3TX / CDD Mode

Frequency Band(MHz)	MAX. Power	
	Output Power(mW)	Output Power(dBm)
5250~5350MHz	122.497	20.88
5470~5725MHz	198.931	22.99

Mode 3. : 3TX / STBC Mode

Frequency Band(MHz)	MAX. Power	
	Output Power(mW)	Output Power(dBm)
5250~5350MHz	122.497	20.88
5470~5725MHz	308.589	24.89

Mode 4. : 3TX / SDM Mode

Frequency Band(MHz)	MAX. Power	
	Output Power(mW)	Output Power(dBm)
5250~5350MHz	122.497	20.88
5470~5725MHz	198.931	22.99



Mode 5. : 3TX / Beamforming Mode MCS0NSS2

Frequency Band(MHz)	MAX. Power	
	Output Power(mW)	Output Power(dBm)
5250~5350MHz	183.706	22.64
5470~5725MHz	298.333	24.75

Mode 6. : 3TX / Beamforming Mode MCS0NSS3

Frequency Band(MHz)	MAX. Power	
	Output Power(mW)	Output Power(dBm)
5250~5350MHz	122.497	20.88
5470~5725MHz	198.931	22.99

Mode 7. : 2TX / Beamforming Mode MCS0NSS1

Frequency Band(MHz)	MAX. Power	
	Output Power(mW)	Output Power(dBm)
5250~5350MHz	229.362	23.61
5470~5725MHz	502.281	27.01

Mode 8. : 2TX / Beamforming Mode MCS0NSS2

Frequency Band(MHz)	MAX. Power	
	Output Power(mW)	Output Power(dBm)
5250~5350MHz	140.774	21.49
5470~5725MHz	302.654	24.81



A D T

Mode 9. : 2TX / CDD Mode

Frequency Band(MHz)	MAX. Power	
	Output Power(mW)	Output Power(dBm)
5250~5350MHz	140.774	21.49
5470~5725MHz	302.654	24.81

Mode 10. : 2TX /STBC Mode

Frequency Band(MHz)	MAX. Power	
	Output Power(mW)	Output Power(dBm)
5250~5350MHz	156.115	21.93
5470~5725MHz	350.683	25.45

Mode 11. : 2TX / SDM Mode

Frequency Band(MHz)	MAX. Power	
	Output Power(mW)	Output Power(dBm)
5250~5350MHz	140.774	21.49
5470~5725MHz	302.654	24.81



A D T

IEEE 802.11ac VHT80

Mode 1. : 3TX / Beamforming Mode MCS0NSS1

Frequency Band(MHz)	MAX. Power	
	Output Power(mW)	Output Power(dBm)
5250~5350MHz	347.757	25.41
5470~5725MHz	468.903	26.71

Mode 2. : 3TX / CDD Mode

Frequency Band(MHz)	MAX. Power	
	Output Power(mW)	Output Power(dBm)
5250~5350MHz	148.005	21.7
5470~5725MHz	196.826	22.94

Mode 3. : 3TX / STBC Mode

Frequency Band(MHz)	MAX. Power	
	Output Power(mW)	Output Power(dBm)
5250~5350MHz	148.005	21.7
5470~5725MHz	312.204	24.94

Mode 4. : 3TX / SDM Mode

Frequency Band(MHz)	MAX. Power	
	Output Power(mW)	Output Power(dBm)
5250~5350MHz	148.005	21.7
5470~5725MHz	196.826	22.94



Mode 5. : 3TX / Beamforming Mode MCS0NSS2

Frequency Band(MHz)	MAX. Power	
	Output Power(mW)	Output Power(dBm)
5250~5350MHz	221.961	23.46
5470~5725MHz	295.177	24.7

Mode 6. : 3TX / Beamforming Mode MCS0NSS3

Frequency Band(MHz)	MAX. Power	
	Output Power(mW)	Output Power(dBm)
5250~5350MHz	148.005	21.7
5470~5725MHz	196.826	22.94

Mode 7. : 2TX / Beamforming Mode MCS0NSS1

Frequency Band(MHz)	MAX. Power	
	Output Power(mW)	Output Power(dBm)
5250~5350MHz	292.146	24.66
5470~5725MHz	604.474	27.81

Mode 8. : 2TX / Beamforming Mode MCS0NSS2

Frequency Band(MHz)	MAX. Power	
	Output Power(mW)	Output Power(dBm)
5250~5350MHz	179.308	22.54
5470~5725MHz	364.232	25.61



A D T

Mode 9. : 2TX / CDD Mode

Frequency Band(MHz)	MAX. Power	
	Output Power(mW)	Output Power(dBm)
5250~5350MHz	179.308	22.54
5470~5725MHz	364.232	25.61

Mode 10. : 2TX / STBC Mode

Frequency Band(MHz)	MAX. Power	
	Output Power(mW)	Output Power(dBm)
5250~5350MHz	261.684	24.18
5470~5725MHz	364.232	25.61

Mode 11. : 2TX / SDM Mode

Frequency Band(MHz)	MAX. Power	
	Output Power(mW)	Output Power(dBm)
5250~5350MHz	179.308	22.54
5470~5725MHz	364.232	25.61



A D T

2.6 TRANSMIT POWER CONTROL (TPC)

U-NII devices operating in the 5.25-5.35 GHz band and the 5.47-5.725 GHz band shall employ a TPC mechanism. The U-NII device is required to have the capability to operate at least 6 dB below the mean EIRP value of 30 dBm. A TPC mechanism is not required for systems with an EIRP of less than 500 mW.

Maximum EIRP of this device is 604.474mW which more than 500mW, therefore it's require TPC function.

The UUT can adjust a transmitter's output power based on the signal level present at the receiver.

TPC is controlled by software and the user may adjust the Transmit Power level from web interface that may adjust the transmit power among Max,-3dB,-6dB, from web manually when the power needs to be increased or decreased.

The interface is for WLAN purpose that is installed fixedly, so we implement manual TPC instead of automatic TPC on the product.

2.7 STATEMENT OF MAUNFACTURER

Manufacturer statement confirming that information regarding the parameters of the detected Radar Waveforms is not available to the end user.



3. U-NII DFS RULE REQUIREMENTS

3.1 WORKING MODES AND REQUIRED TEST ITEMS

The manufacturer shall state whether the UUT is capable of operating as a Master and/or a Client. If the UUT is capable of operating in more than one operating mode then each operating mode shall be tested separately. See tables 6 and 7 for the applicability of DFS requirements for each of the operational modes.

Table 6: Applicability of DFS requirements prior to use a channel

Requirement	Operational Mode		
	Master	Client without radar detection	Client with radar detection
Non-Occupancy Period	✓	✓	✓
DFS Detection Threshold	✓	Not required	✓
Channel Availability Check Time	✓	Not required	Not required
Uniform Spreading	✓	Not required	Not required
U-NII Detection Bandwidth	✓	Not required	✓

Table 7: Applicability of DFS requirements during normal operation

Requirement	Operational Mode		
	Master	Client without radar detection	Client with radar detection
DFS Detection Threshold	✓	Not required	✓
Channel Closing Transmission Time	✓	✓	✓
Channel Move Time	✓	✓	✓
U-NII Detection Bandwidth	✓	Not required	✓



3.2 TEST LIMITS AND RADAR SIGNAL PARAMETERS

DETECTION THRESHOLD VALUES

Table 8: DFS Detection Thresholds for Master Devices and Client Devices With Radar Detection

Maximum Transmit Power	Value (See Notes 1 and 2)
≥ 200 milliwatt	-64 dBm
< 200 milliwatt	-62 dBm

Note 1: This is the level at the input of the receiver assuming a 0 dBi receive antenna.
 Note 2: Throughout these test procedures an additional 1 dB has been added to the amplitude of the test transmission waveforms to account for variations in measurement equipment. This will ensure that the test signal is at or above the detection threshold level to trigger a DFS response.

Table 9: DFS Response Requirement Values

Parameter	Value
Non-occupancy period	Minimum 30 minutes
Channel Availability Check Time	60 seconds
Channel Move Time	10 seconds See Note 1.
Channel Closing Transmission Time	200 milliseconds + an aggregate of 60 milliseconds over remaining 10 second period. See Notes 1 and 2.
U-NII Detection Bandwidth	Minimum 80% of the UNII 99% transmission power bandwidth. See Note 3.

Note 1: The instant that the Channel Move Time and the Channel Closing Transmission Time begins is as follows:

- For the Short Pulse Radar Test Signals this instant is the end of the Burst.
- For the Frequency Hopping radar Test Signal, this instant is the end of the last radar Burst generated.
- For the Long Pulse Radar Test Signal this instant is the end of the 12 second period defining the Radar Waveform.

Note 2: The Channel Closing Transmission Time is comprised of 200 milliseconds starting at the beginning of the Channel Move Time plus any additional intermittent control signals required to facilitate a Channel move (an aggregate of 60 milliseconds) during the remainder of the 10 second period. The aggregate duration of control signals will not count quiet periods in between transmissions.

Note 3: During the U-NII Detection Bandwidth detection test, radar type 1 is used and for each frequency step the minimum percentage of detection is 90 percent. Measurements are performed with no data traffic.



PARAMETERS OF DFS TEST SIGNALS

Step intervals of 0.1 microsecond for Pulse Width, 1 microsecond for PRI, 1 MHz for chirp width and 1 for the number of pulses will be utilized for the random determination of specific test waveforms.

Table 10: Short Pulse Radar Test Waveforms

Radar Type	Pulse Width (µsec)	PRI (µsec)	Number of Pulses	Minimum Percentage of Successful Detection	Minimum Number of Trials
1	1	1428	18	60%	30
2	1-5	150-230	23-29	60%	30
3	6-10	200-500	16-18	60%	30
4	11-20	200-500	12-16	60%	30
Aggregate (Radar Types 1-4)				80%	120

Table 11: Long Pulse Radar Test Waveform

Radar Type	Pulse Width (µsec)	Chirp Width (MHz)	PRI (µsec)	Number of Pulses per Burst	Number of Bursts	Minimum Percentage of Successful Detection	Minimum Number of Trials
5	50-100	5-20	1000-2000	1-3	8-20	80%	30

Table 12: Frequency Hopping Radar Test Waveform

Radar Type	Pulse Width (µsec)	PRI (µsec)	Pulses per Hop	Hopping Rate (kHz)	Hopping Sequence Length (msec)	Minimum Percentage of Successful Detection	Minimum Number of Trials
6	1	333	9	0.333	300	70%	30



A D T

4. TEST & SUPPORT EQUIPMENT LIST

4.1 TEST INSTRUMENTS

Table 13: Test instruments list

DESCRIPTION & MANUFACTURER	MODEL NO.	SERILA NO.	CALIBRATED DATE	CALIBRATED UNTIL
Spectrum Analyzer R&S	FSW8	101497	Aug. 06, 2014	Aug. 05, 2015
Vector Signal Generator R&S	SMJ100A	101878	Aug. 12, 2014	Aug. 11, 2015

4.2 DESCRIPTION OF SUPPORT UNITS

Table 14: Support Unit information

No.	Product	Brand	Model No.	FCC ID	Spec.
1	FIOS™ IPC2100 IP CLIENT	Verizon	IPC2100	2ABTEIPC2100	

Note: This device was functioned as a Master Slave device during the DFS test.

Table 15: Software/Firmware information

No.	Product	Model No.	Software/Firmware Version
1	FIOS™ IPC2100 IP CLIENT	IPC2100	6.37 RC14.67 w10: Jan 23 2014 Version 6.37.14.67



5. TEST PROCEDURE

5.1 BVADT DFS MEASUREMENT SYSTEM:

A complete ADT DFS Measurement System consists of two subsystems: (1) the Radar Signal Generating Subsystem and (2) the Traffic Monitoring Subsystem. The control PC is necessary for generating the Radar waveforms in Table 10, 11 and 12. The traffic monitoring subsystem is specified to the type of unit under test (UUT).

Conducted setup configuration of ADT DFS Measurement System

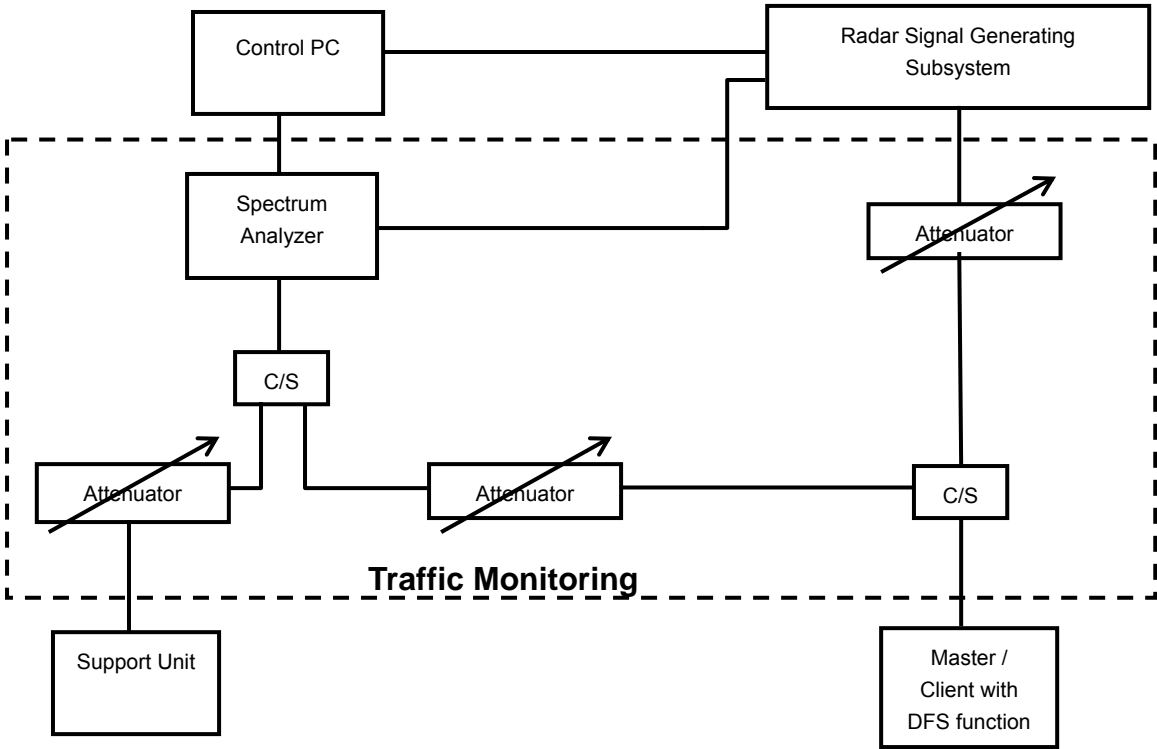

The test transmission will always be from the Master Device to the Client Device. While the Client device is set up to associate with the Master device and play the MPEG file (6 1/2 Magic Hours) from Master device, the designated MPEG test file and instructions are located at:

<http://ntiacsd.ntia.doc.gov/dfs/>.



5.2 CALIBRATION OF DFS DETECTION THRESHOLD LEVEL:

The measured channel is 5500MHz in 20MHz and 5510MHz in 40MHz and 5530 in 80MHz. The radar signal was the same as transmitted channels, and injected into the antenna port of UUT (master) or Client Device with Radar Detection, measured the channel closing transmission time and channel move time.

5.2.2 MASTER MODE

The Master antenna net gain is 3.86dBi and required detection threshold is -59.14dBm (= -64 +3.86+1)dBm. The calibrated conducted detection threshold level is set to -59.14 dBm.

Conducted setup configuration of Calibration of DFS Detection Threshold Level

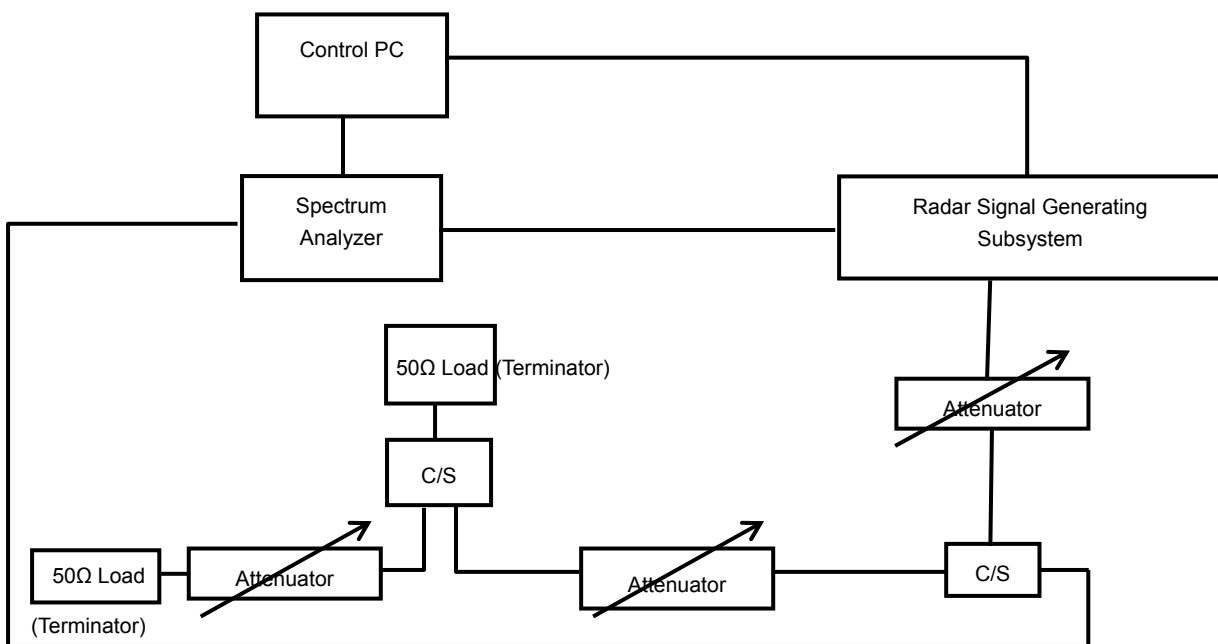

5.3 DEVIATION FROM TEST STANDARD

No deviation.

5.4 CONDUCTED TEST SETUP CONFIGURATION

5.4.1 MASTER MODE

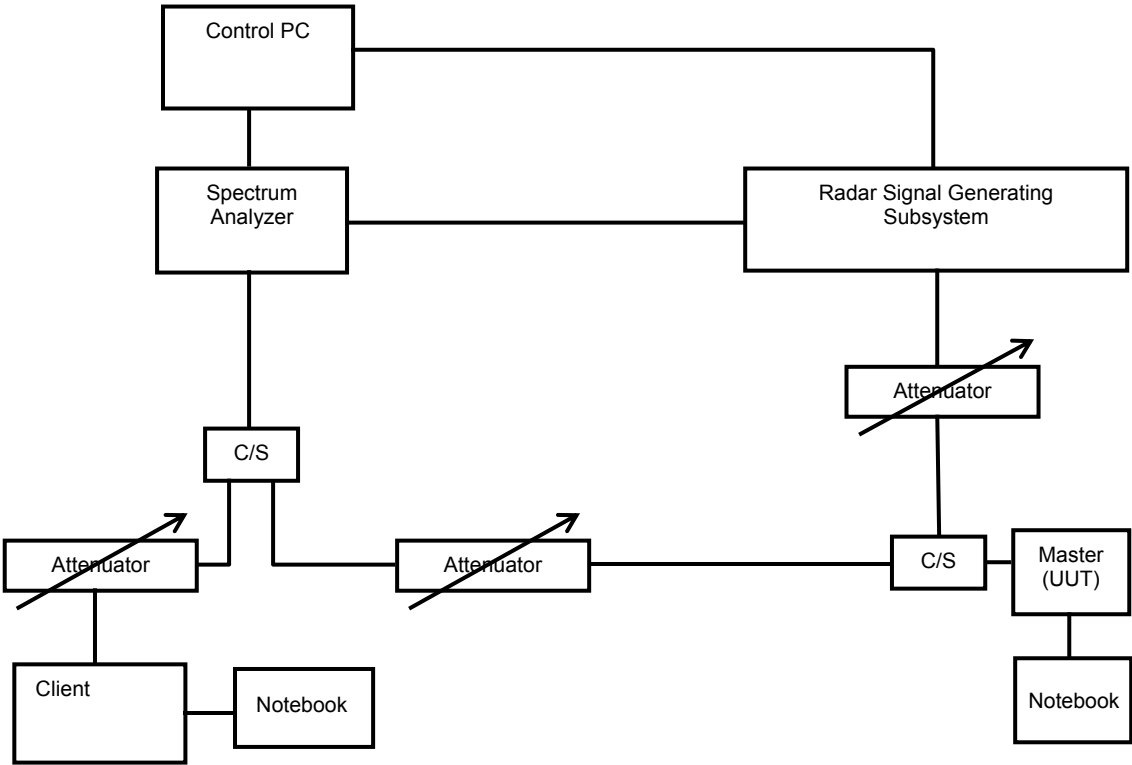

The UUT is a U-NII Device operating in Master mode. The radar test signals are injected into the Master Device.



A D T

6. TEST RESULTS

6.1 SUMMARY OF TEST RESULT

6.1.1 MASTER MODE

Clause	Test Parameter	Remarks	Pass/Fail
15.407	DFS Detection Threshold	Applicable	Pass
15.407	Channel Availability Check Time	Applicable	Pass
15.407	Channel Move Time	Applicable	Pass
15.407	Channel Closing Transmission Time	Applicable	Pass
15.407	Non- Occupancy Period	Applicable	Pass
15.407	Uniform Spreading	Applicable	Pass
15.407	U-NII Detection Bandwidth	Applicable	Pass
15.407	Non-Co-Channel test	Applicable	Pass

6.2 DETAILED TEST RESULTS

6.2.1. TEST MODE: DEVICE OPERATING IN MASTER MODE

Radar with injection at the Master. (Radar Test Waveforms are injected into the Master.

This test was investigated for different bandwidth (20MHz 、 40MHz 、 80MHz). The following plots was done on 80MHz as a representative.

After pretest, the worst mode of the device operating in 3TX/CDD mode.

6.2.1.1 DFS DETECTION THRESHOLD

The required detection threshold is -59.14dBm ($= -64 + 3.86 + 1$) dBm. The conducted radar burst level is set to -59.14dBm .

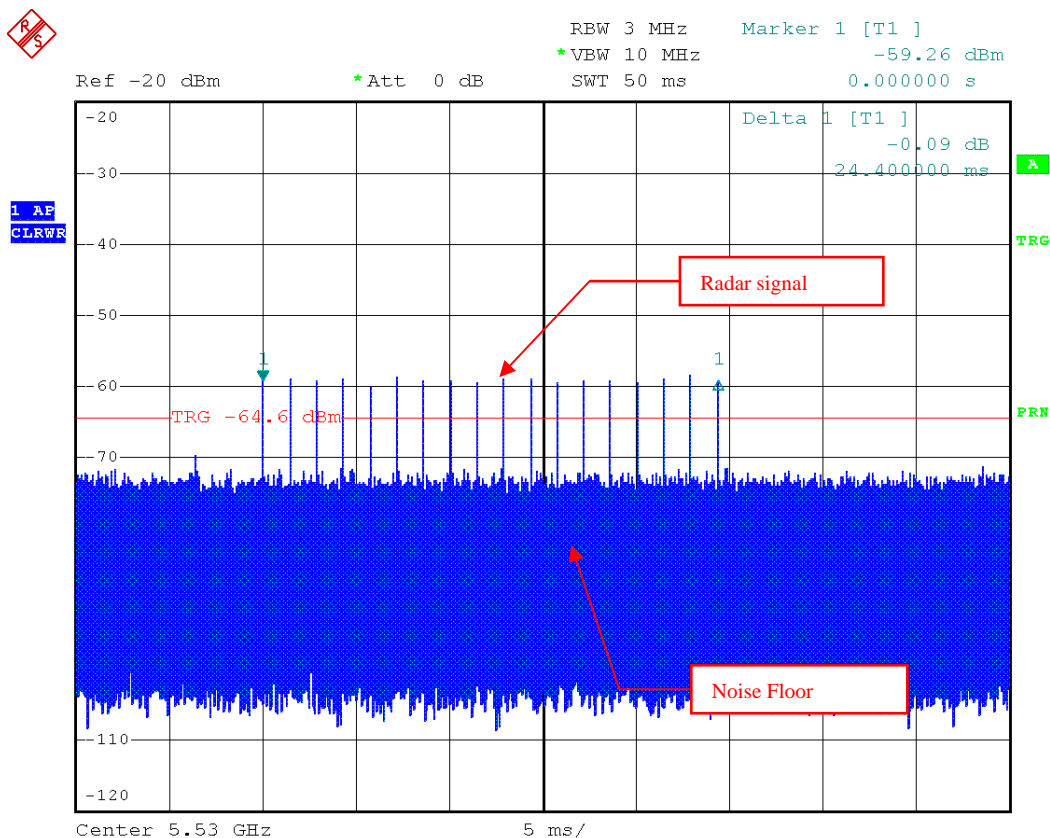

Radar Signal 1



A D T



1 AP
CLRWR

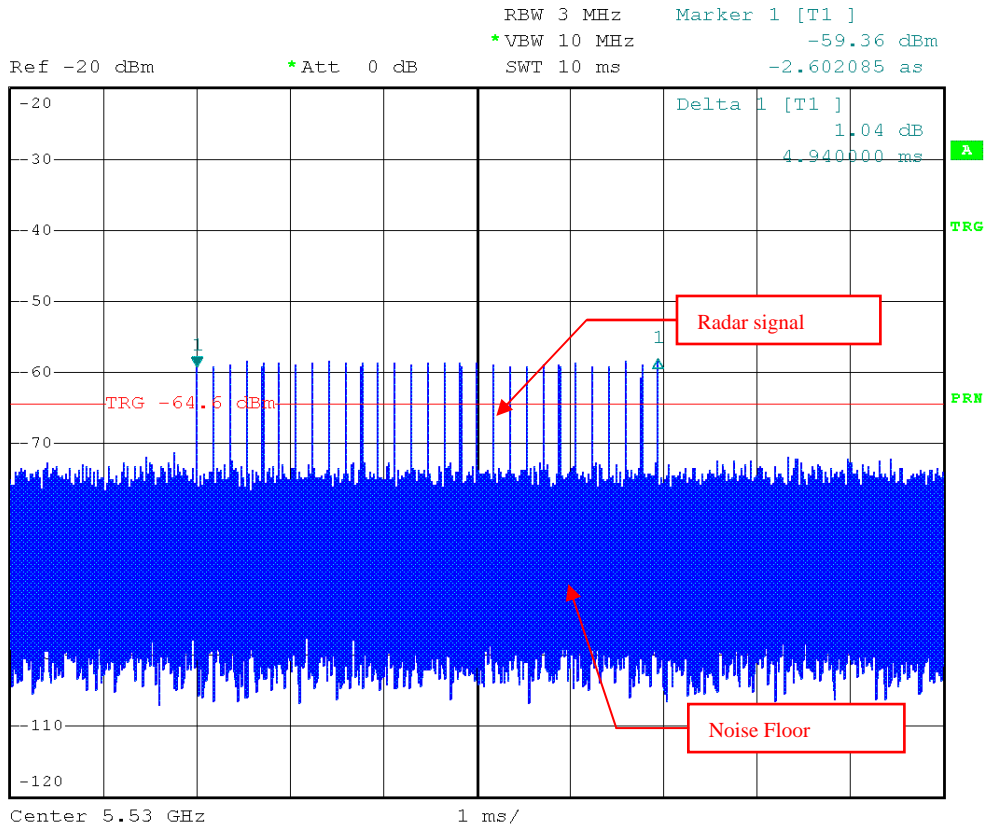

Radar Signal 2



A D T



1 AP
CLRWR

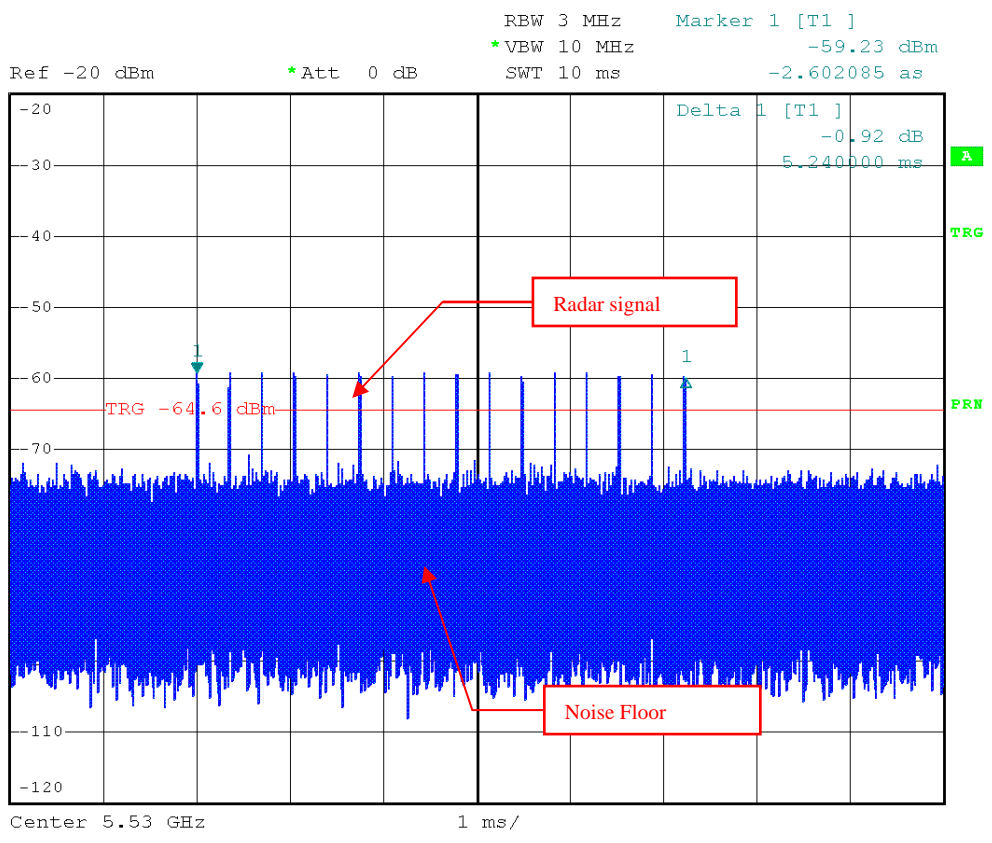

Radar Signal 3



A D T

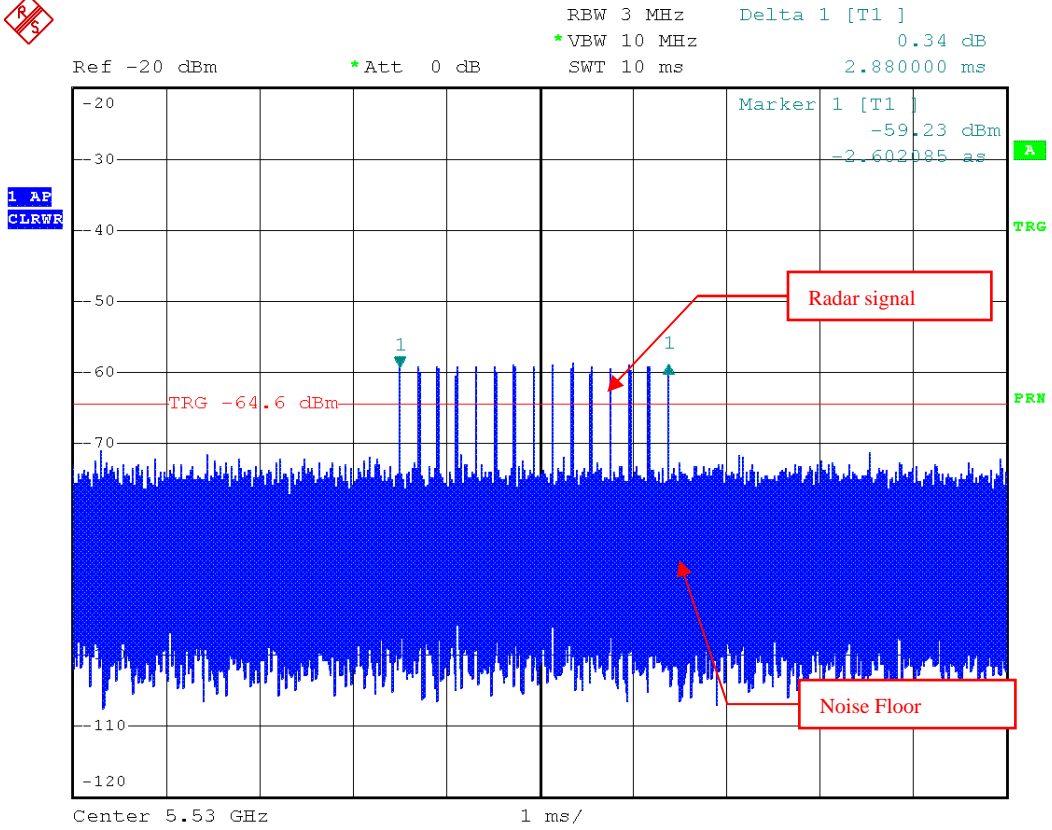

Radar Signal 4



A D T



1 AP
CLRWR

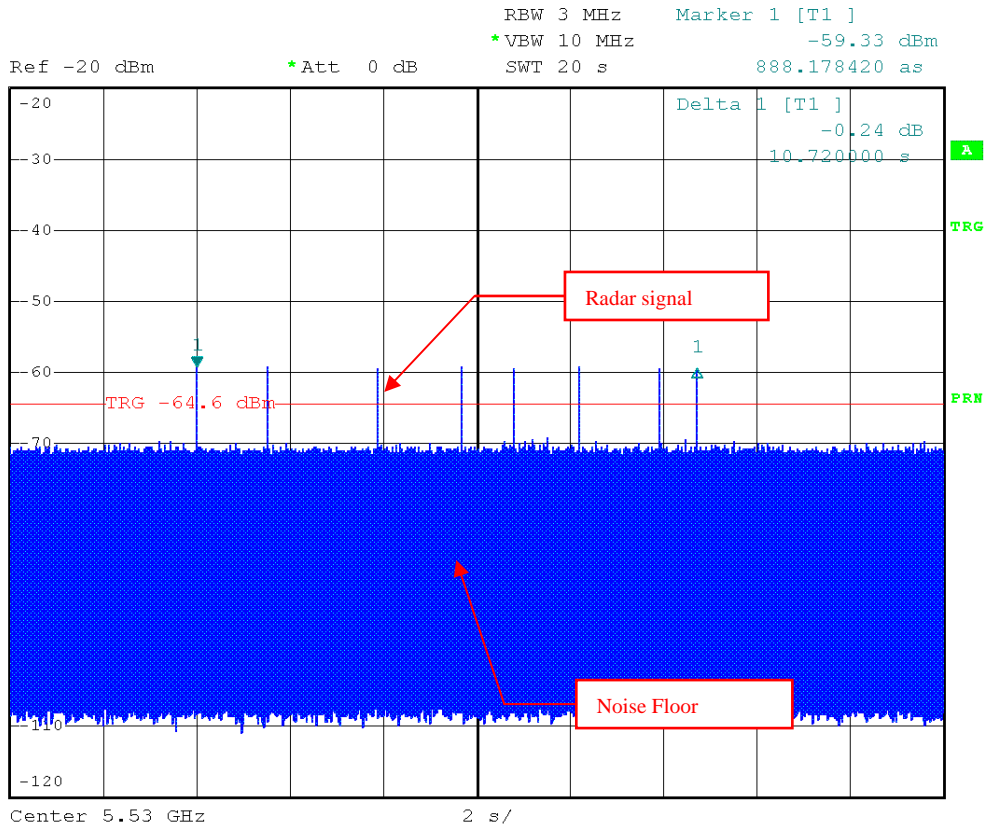

Radar Signal 5



A D T



1 AP
VIEW

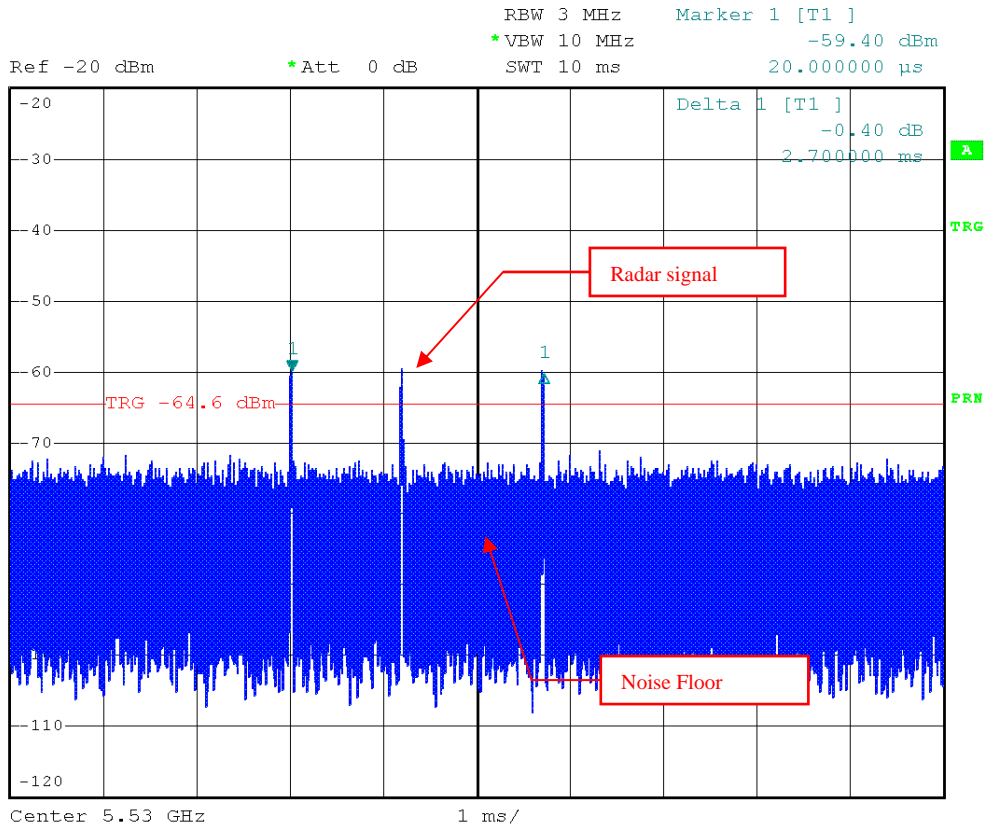

Single Burst of Radar Signal 5



A D T



1 AP
CLRWR

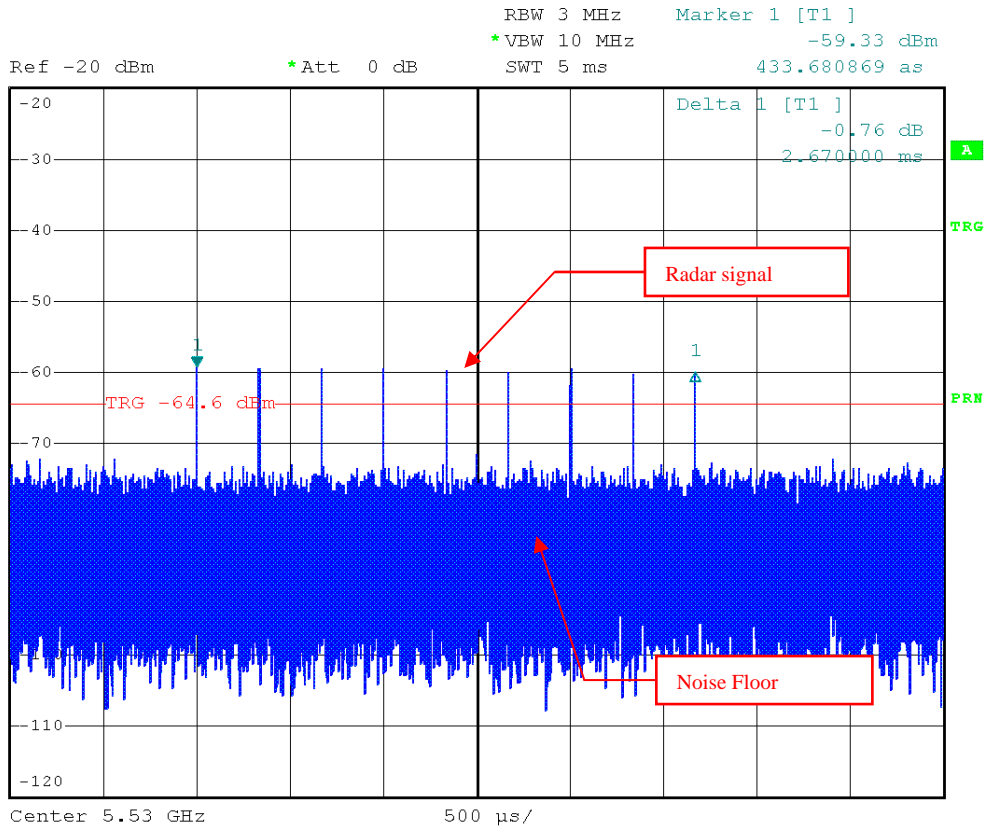

Radar Signal 6

6.2.1.2 CHANNEL AVAILABILITY CHECK TIME

If the EUT successfully detected the radar burst, it should be observed as the EUT has no transmissions occurred until the EUT starts transmitting on another channel.

Timing of Radar Signal	Observation	
	EUT	Spectrum Analyzer
Within 1 to 6 second	Detected	No transmissions
Within 54 to 60 second	Detected	No transmissions

Initial Channel Availability Check Time

Channel Availability Check

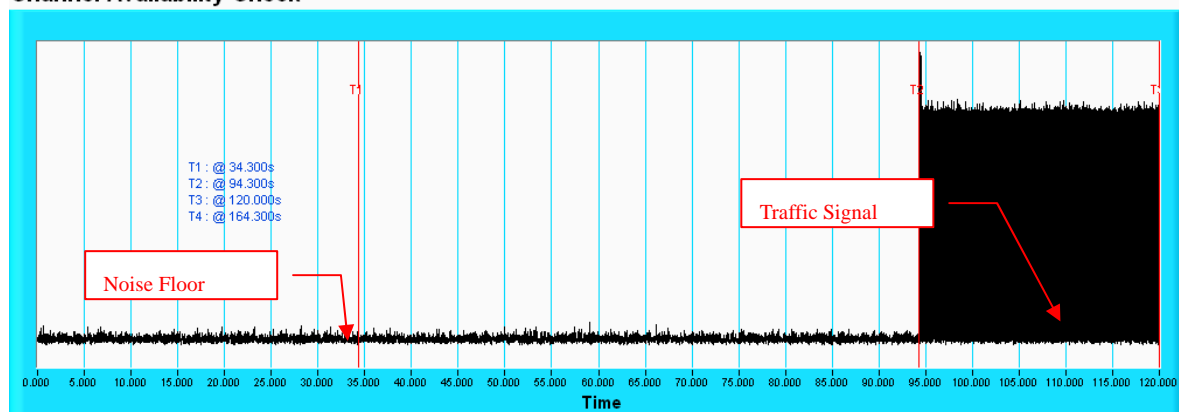

NOTE: T1 denotes the end of power-up time period is 34.3th second. T2 denotes the end of Channel Availability Check time is 94.3th second. Channel Availability Check time is equal to (T2 – T1) 60 seconds.

Radar Burst at the Beginning of the Channel Availability Check Time

Channel Availability Check

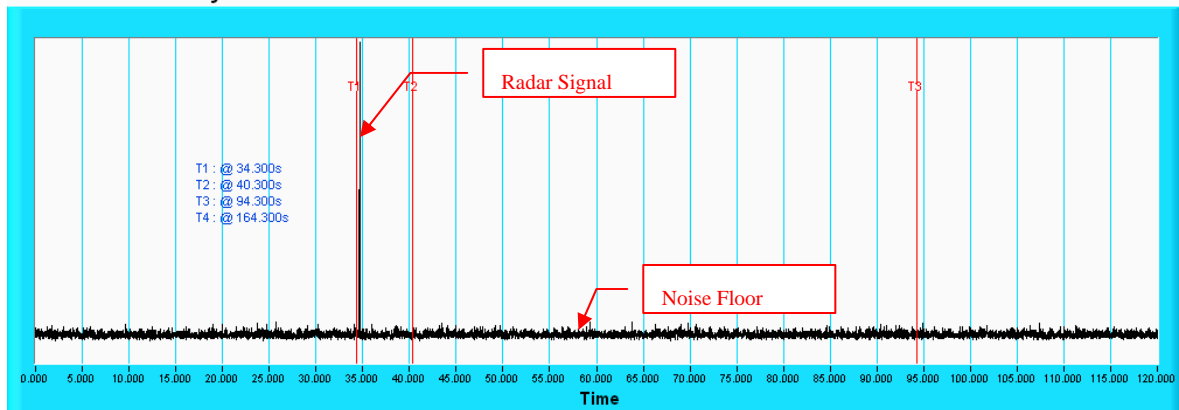

NOTE: T1 denotes the end of power up time period is 34.3th second. T2 denotes 40.3th second and the radar burst was commenced within a 6 second window starting from the end of power-up sequence. T3 denotes the 94.3th second.

Radar Burst at the End of the Channel Availability Check Time

Channel Availability Check

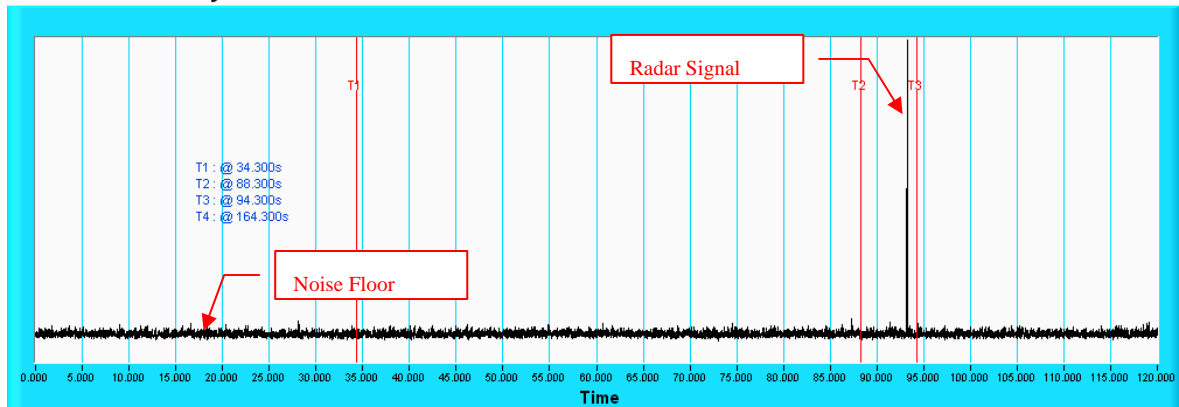

NOTE: T1 denotes the end of power up time period is 34.3th second. T2 denotes 88.3th second and the radar burst was commenced within 6 second from the last of Channel Available Check time. T3 denotes the 94.3th second.



A D T

6.2.1.3 CHANNEL CLOSING TRANSMISSION AND CHANNEL MOVE TIME 802.11ac VHT20

Short Pulse Radar Test Waveforms

Radar Type	Pulse Width (µsec)	PRI (µsec)	Number of Pulses	Number of Trials(Times)	Percentage of Successful Detection (%)
1	1	1428	18	30	83.3
2	1-5	150-230	23-29	30	80
3	6-10	200-500	16-18	30	80
4	11-20	200-500	12-16	30	83.3
Aggregate (Radar Types 1-4)				120	81.65

Long Pulse Radar Test Waveform

Radar Type	Pulse Width (µsec)	Chirp Width (MHz)	PRI (µsec)	Number of Pulses per Burst	Number of Bursts	Number of Trials(Times)	Percentage of Successful Detection (%)
5	50-100	5-20	1000-2000	1-3	8-20	30	83.3

Frequency Hopping Radar Test Waveform

Radar Type	Pulse Width (µsec)	PRI (µsec)	Pulses per Hop	Hopping Rate (kHz)	Hopping Sequence Length (msec)	Number of Trials(Times)	Percentage of Successful Detection (%)
6	1	333	9	0.333	300	30	80



A D T

802.11ac VHT40

Short Pulse Radar Test Waveforms

Radar Type	Pulse Width (µsec)	PRI (µsec)	Number of Pulses	Number of Trials(Times)	Percentage of Successful Detection (%)
1	1	1428	18	30	80
2	1-5	150-230	23-29	30	80
3	6-10	200-500	16-18	30	86.7
4	11-20	200-500	12-16	30	83.3
Aggregate (Radar Types 1-4)				120	82.5

Long Pulse Radar Test Waveform

Radar Type	Pulse Width (µsec)	Chirp Width (MHz)	PRI (µsec)	Number of Pulses per Burst	Number of Bursts	Number of Trials(Times)	Percentage of Successful Detection (%)
5	50-100	5-20	1000-2000	1-3	8-20	30	83.3

Frequency Hopping Radar Test Waveform

Radar Type	Pulse Width (µsec)	PRI (µsec)	Pulses per Hop	Hopping Rate (kHz)	Hopping Sequence Length (msec)	Number of Trials(Times)	Percentage of Successful Detection (%)
6	1	333	9	0.333	300	30	83.3



A D T

802.11ac VHT80

Short Pulse Radar Test Waveforms

Radar Type	Pulse Width (µsec)	PRI (µsec)	Number of Pulses	Number of Trials(Times)	Percentage of Successful Detection (%)
1	1	1428	18	30	86.7
2	1-5	150-230	23-29	30	80
3	6-10	200-500	16-18	30	83.3
4	11-20	200-500	12-16	30	80
Aggregate (Radar Types 1-4)				120	82.5

Long Pulse Radar Test Waveform

Radar Type	Pulse Width (µsec)	Chirp Width (MHz)	PRI (µsec)	Number of Pulses per Burst	Number of Bursts	Number of Trials(Times)	Percentage of Successful Detection (%)
5	50-100	5-20	1000-2000	1-3	8-20	30	80

Frequency Hopping Radar Test Waveform

Radar Type	Pulse Width (µsec)	PRI (µsec)	Pulses per Hop	Hopping Rate (kHz)	Hopping Sequence Length (msec)	Number of Trials(Times)	Percentage of Successful Detection (%)
6	1	333	9	0.333	300	30	83.3

Wireless Traffic Loading

802.11ac VHT20

Duty Cycle

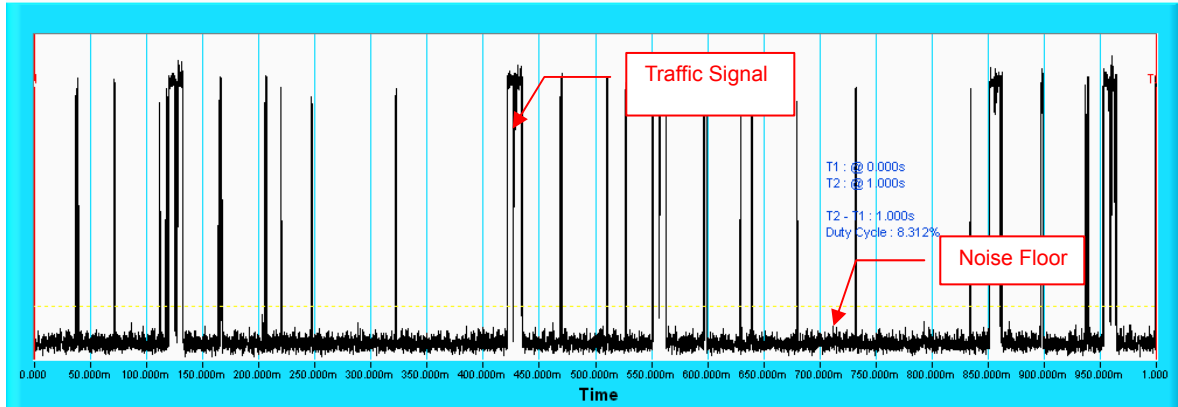

NOTE: T1 denotes the start of duty cycle period is 0th second. T2 denotes the end of duty cycle period is 1th second. T2 – T1= 1 seconds. Duty Cycle = 8.312%

802.11ac VHT40

Duty Cycle

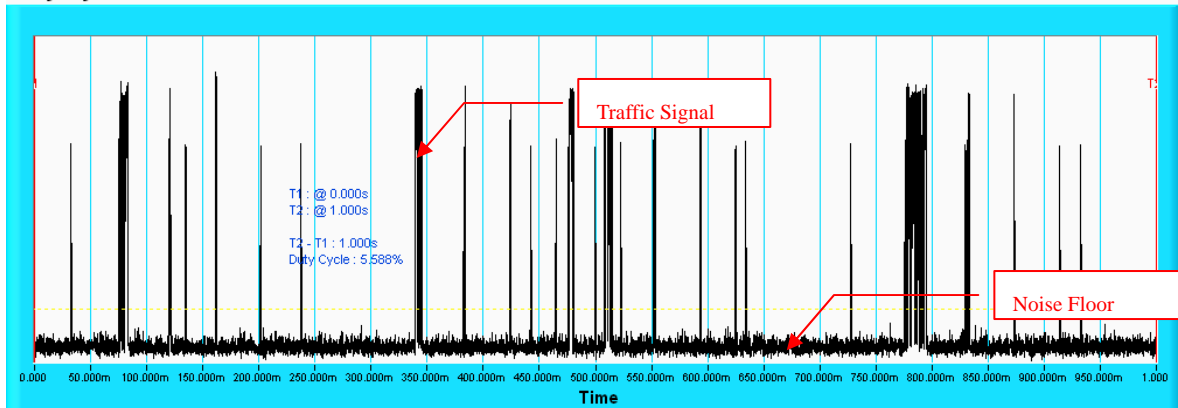

NOTE: T1 denotes the start of duty cycle period is 0th second. T2 denotes the end of duty cycle period is 1th second. T2 – T1= 1 seconds. Duty Cycle = 5.588%



A D T

802.11ac VHT80

Duty Cycle

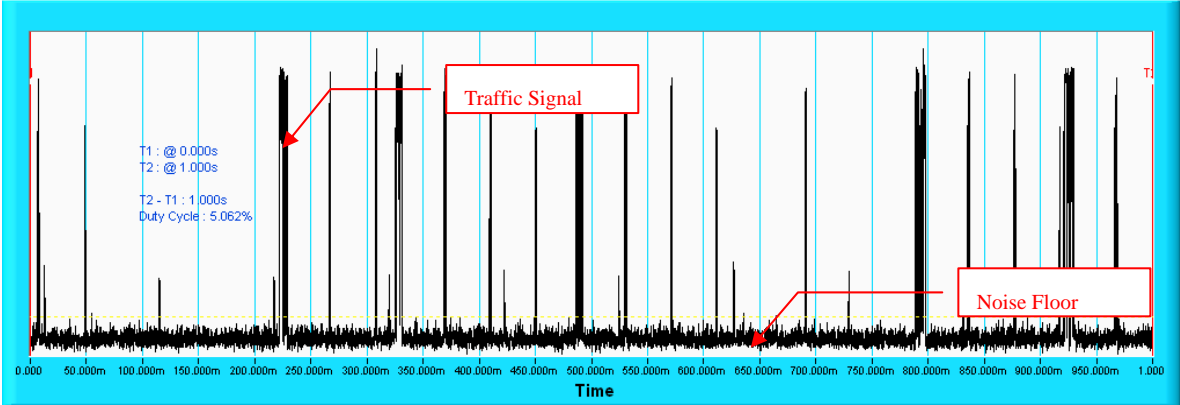

NOTE: T1 denotes the start of duty cycle period is 0th second. T2 denotes the end of duty cycle period is 1th second. T2 – T1= 1 seconds. Duty Cycle = 5.062%

Radar signal 1

Channel Closing Transmission Time & Channel Move Time @ ac80 - ch106

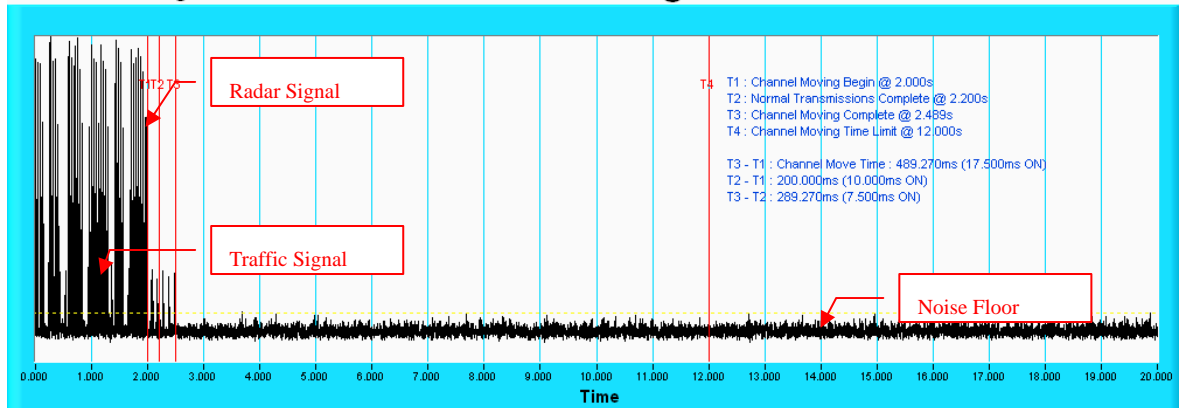

NOTE: T1 denotes the start of Channel Move Time upon the end of the last Radar burst. T2 denotes the data transmission time of 200ms from T1. T3 denotes the end of Channel Move Time. T4 denotes the 10 second from T1 to observe the aggregate duration of transmissions.

Channel Closing Transmission Time & Channel Move Time @ ac80 - ch106

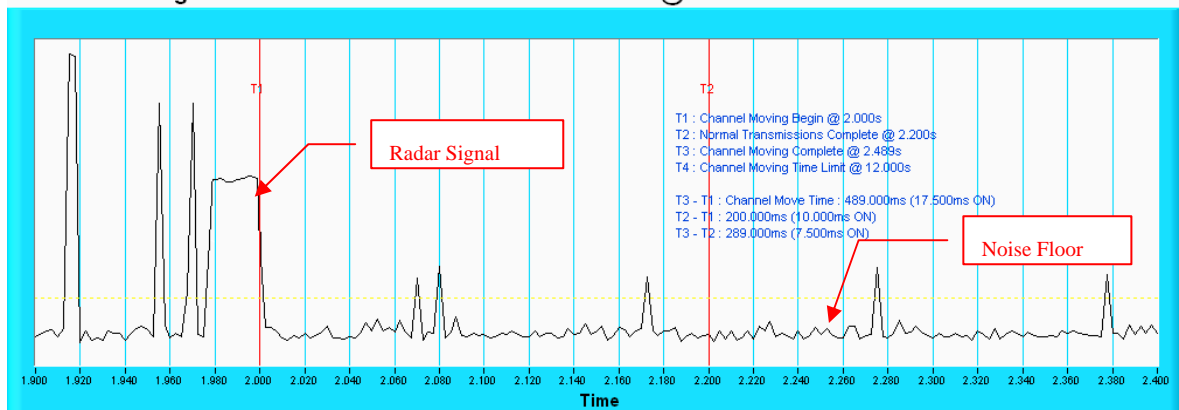

NOTE: An expanded plot for the device vacates the channel in the required 500ms.

Radar signal 2

Channel Closing Transmission Time & Channel Move Time @ ac80 - ch106

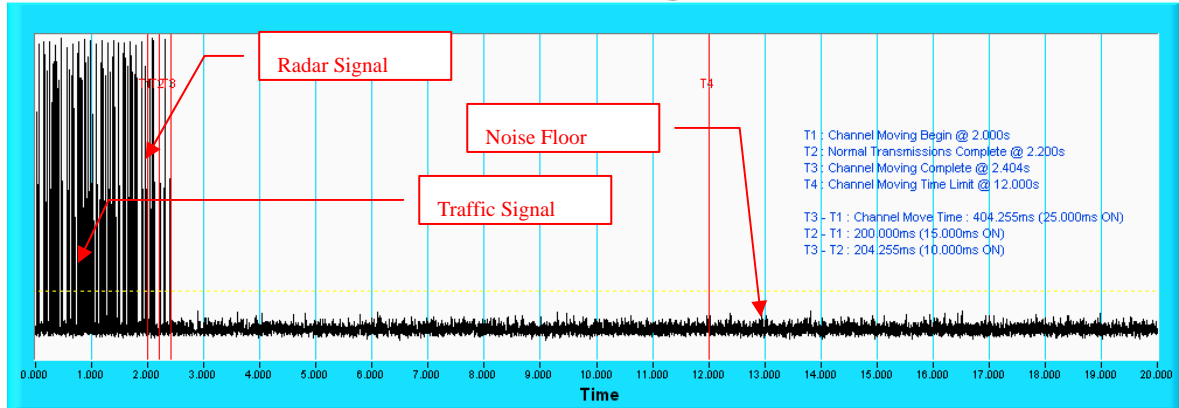

NOTE: T1 denotes the start of Channel Move Time upon the end of the last Radar burst. T2 denotes the data transmission time of 200ms from T1. T3 denotes the end of Channel Move Time. T4 denotes the 10 second from T1 to observe the aggregate duration of transmissions.

Channel Closing Transmission Time & Channel Move Time @ ac80 - ch106

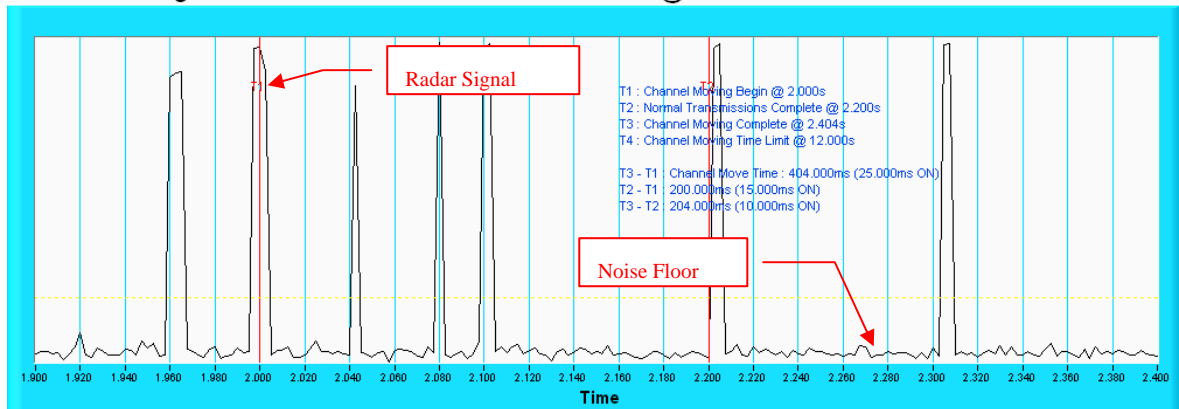

NOTE: An expanded plot for the device vacates the channel in the required 500ms.



A D T

Radar signal 3

Channel Closing Transmission Time & Channel Move Time @ ac80 - ch106

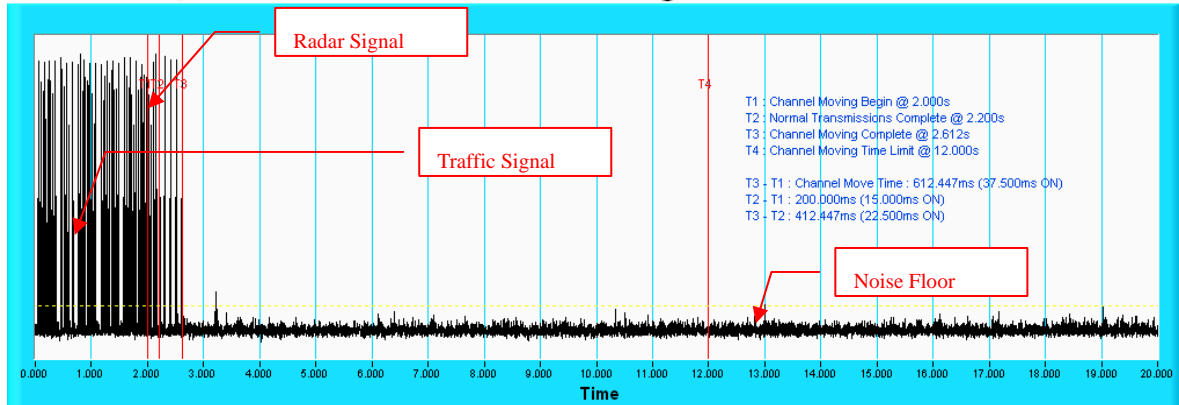

NOTE: T1 denotes the start of Channel Move Time upon the end of the last Radar burst. T2 denotes the data transmission time of 200ms from T1. T3 denotes the end of Channel Move Time. T4 denotes the 10 second from T1 to observe the aggregate duration of transmissions.

Channel Closing Transmission Time & Channel Move Time @ ac80 - ch106

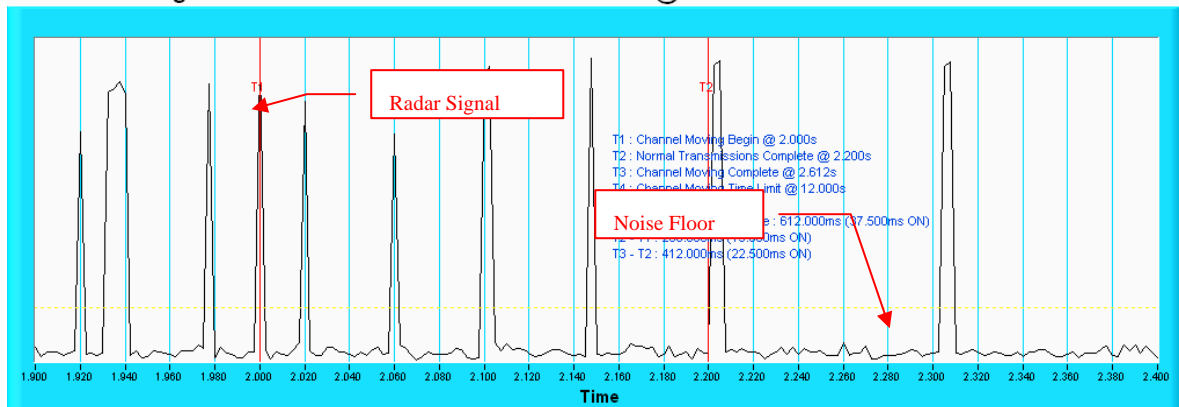

NOTE: An expanded plot for the device vacates the channel in the required 500ms.



A D T

Radar signal 4

Channel Closing Transmission Time & Channel Move Time @ ac80 - ch106

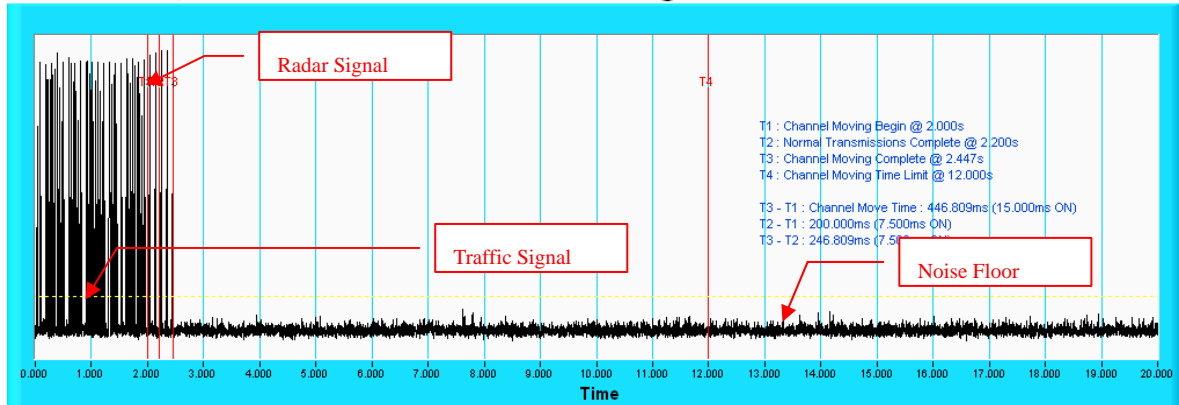

NOTE: T1 denotes the start of Channel Move Time upon the end of the last Radar burst. T2 denotes the data transmission time of 200ms from T1. T3 denotes the end of Channel Move Time. T4 denotes the 10 second from T1 to observe the aggregate duration of transmissions.

Channel Closing Transmission Time & Channel Move Time @ ac80 - ch106

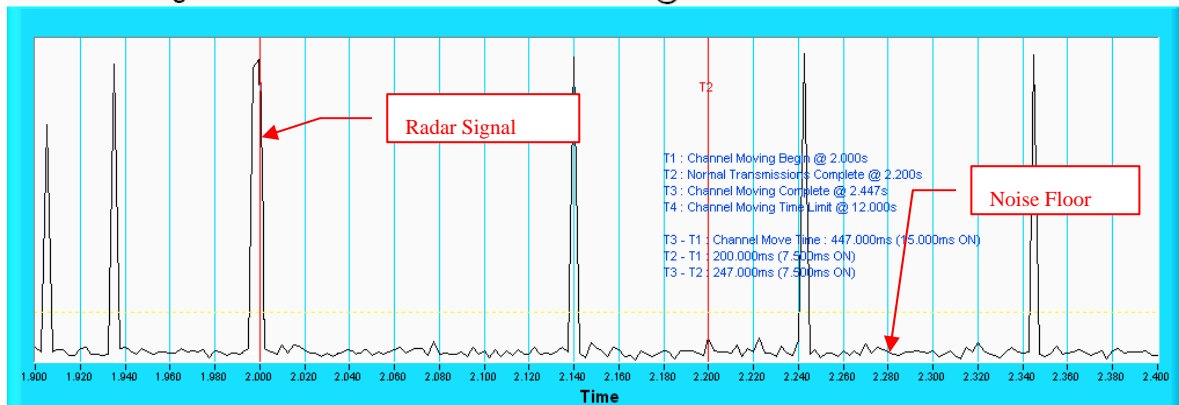

NOTE: An expanded plot for the device vacates the channel in the required 500ms.



A D T

Radar signal 5

Channel Closing Transmission Time & Channel Move Time @ AC80 - 106

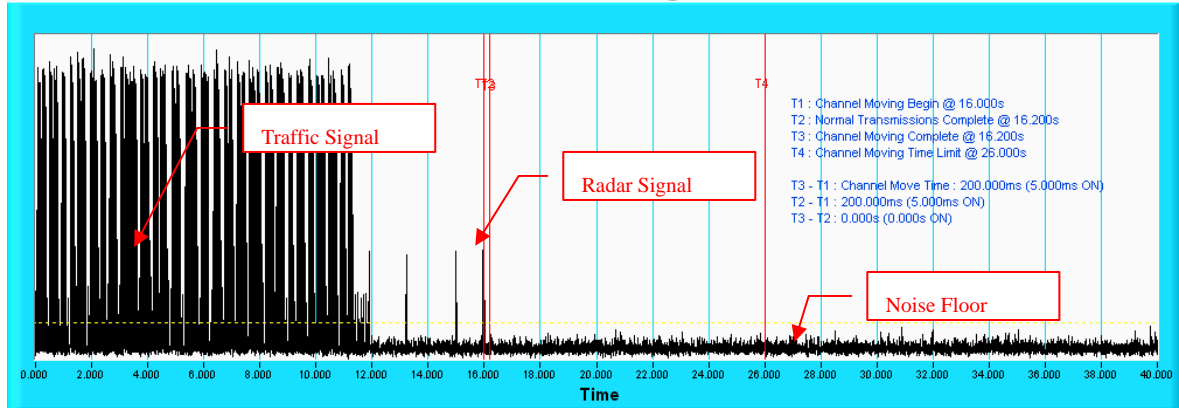

NOTE: T1 denotes the start of Channel Move Time upon the end of the last Radar burst. T2 denotes the data transmission time of 200ms from T1. T3 denotes the end of Channel Move Time. T4 denotes the 10 second from T1 to observe the aggregate duration of transmissions.

Channel Closing Transmission Time & Channel Move Time @ AC80 - 106

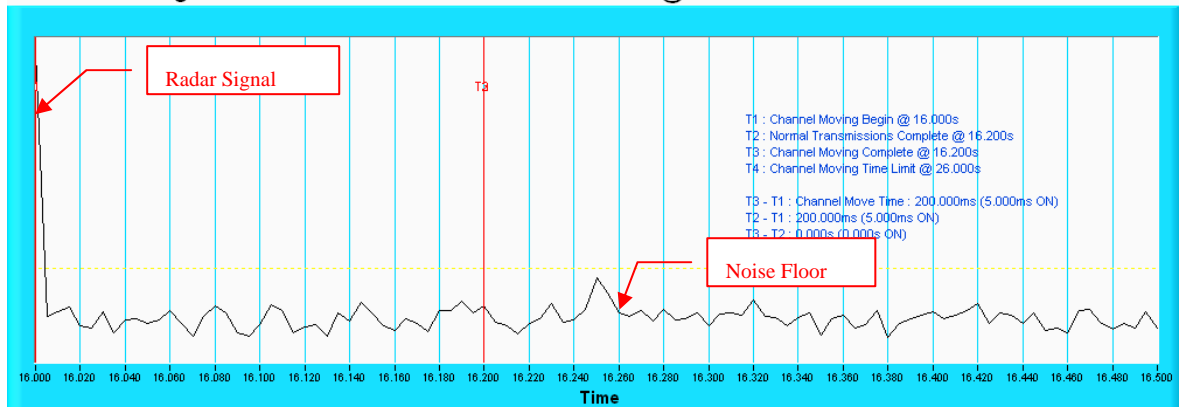

NOTE: An expanded plot for the device vacates the channel in the required 500ms.



A D T

Radar signal 6

Channel Closing Transmission Time & Channel Move Time @ AC80 - 106

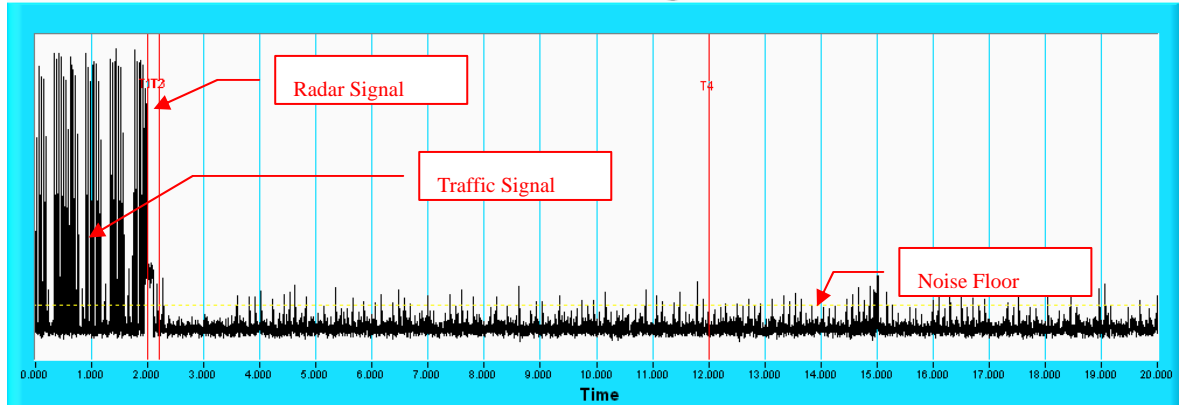

NOTE: T1 denotes the start of Channel Move Time upon the end of the last Radar burst. T2 denotes the data transmission time of 200ms from T1. T3 denotes the end of Channel Move Time. T4 denotes the 10 second from T1 to observe the aggregate duration of transmissions.

Channel Closing Transmission Time & Channel Move Time @ AC80 - 106

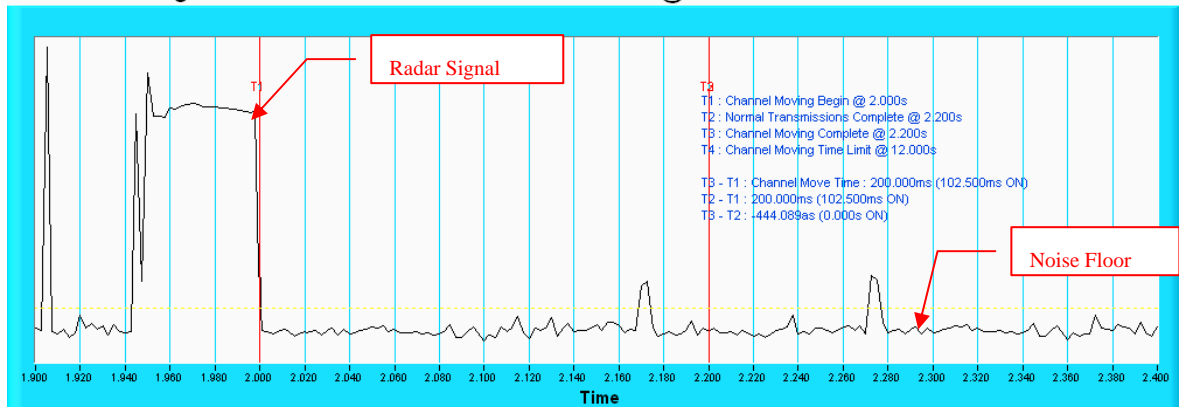

NOTE: An expanded plot for the device vacates the channel in the required 500ms.



A D T

802.11ac VHT20

Type 1 Radar Statistical Performances

Trial #	Pulses per Burst	Pulse Width (s)	PRI (s)	Detection
1	18	1.0u	1.428m	Yes
2	18	1.0u	1.428m	Yes
3	18	1.0u	1.428m	Yes
4	18	1.0u	1.428m	No
5	18	1.0u	1.428m	Yes
6	18	1.0u	1.428m	No
7	18	1.0u	1.428m	Yes
8	18	1.0u	1.428m	Yes
9	18	1.0u	1.428m	Yes
10	18	1.0u	1.428m	No
11	18	1.0u	1.428m	Yes
12	18	1.0u	1.428m	Yes
13	18	1.0u	1.428m	Yes
14	18	1.0u	1.428m	Yes
15	18	1.0u	1.428m	Yes
16	18	1.0u	1.428m	No
17	18	1.0u	1.428m	Yes
18	18	1.0u	1.428m	Yes
19	18	1.0u	1.428m	Yes
20	18	1.0u	1.428m	Yes
21	18	1.0u	1.428m	Yes
22	18	1.0u	1.428m	Yes
23	18	1.0u	1.428m	Yes
24	18	1.0u	1.428m	No
25	18	1.0u	1.428m	Yes
26	18	1.0u	1.428m	Yes
27	18	1.0u	1.428m	Yes
28	18	1.0u	1.428m	Yes
29	18	1.0u	1.428m	Yes
30	18	1.0u	1.428m	Yes

Detection Rate: 83.3 %



A D T

802.11ac VHT20

Type 2 Radar Statistical Performances				
Trial #	Pulses per Burst	Pulse Width (s)	PRI (s)	Detection
1	28	2.3u	151.0u	Yes
2	25	4.6u	163.0u	Yes
3	24	1.4u	214.0u	Yes
4	24	4.0u	217.0u	Yes
5	29	4.2u	191.0u	Yes
6	26	1.4u	158.0u	Yes
7	26	2.8u	187.0u	Yes
8	24	4.2u	216.0u	Yes
9	28	1.4u	183.0u	Yes
10	25	2.9u	161.0u	Yes
11	24	3.8u	188.0u	Yes
12	27	1.5u	180.0u	Yes
13	26	2.3u	179.0u	No
14	25	3.7u	203.0u	No
15	23	3.0u	192.0u	No
16	28	2.1u	182.0u	Yes
17	24	3.3u	175.0u	Yes
18	23	1.3u	170.0u	Yes
19	27	1.0u	193.0u	Yes
20	27	4.7u	162.0u	Yes
21	24	2.7u	178.0u	Yes
22	24	1.6u	169.0u	Yes
23	23	1.2u	209.0u	No
24	29	1.1u	200.0u	Yes
25	28	1.6u	174.0u	Yes
26	29	1.7u	186.0u	No
27	26	3.1u	198.0u	Yes
28	23	1.1u	209.0u	No
29	27	2.5u	229.0u	Yes
30	26	3.5u	195.0u	Yes
				Detection Rate: 80 %



A D T

802.11ac VHT20

Type 3 Radar Statistical Performances				
Trial #	Pulses per Burst	Pulse Width (s)	PRI (s)	Detection
1	17	7.8u	353u	Yes
2	16	7.4u	319u	Yes
3	18	9.2u	327u	Yes
4	17	9.9u	331u	No
5	17	7.8u	483u	Yes
6	16	6u	324u	No
7	17	6.9u	334u	Yes
8	16	6.6u	420u	Yes
9	17	10u	363u	Yes
10	17	7.7u	338u	No
11	17	6.5u	398u	Yes
12	16	8.9u	405u	Yes
13	18	8.8u	489u	Yes
14	17	7.9u	387u	Yes
15	17	9.4u	284u	Yes
16	17	9.8u	419u	Yes
17	17	7.7u	292u	No
18	17	10u	209u	Yes
19	18	6.3u	423u	Yes
20	17	8.3u	398u	Yes
21	17	7.7u	266u	No
22	16	7.7u	281u	Yes
23	17	7.8u	474u	Yes
24	17	9.1u	373u	Yes
25	18	6.8u	497u	Yes
26	18	6.2u	214u	Yes
27	16	9.3u	452u	Yes
28	16	9.4u	268u	Yes
29	17	7.7u	360u	Yes
30	17	9.4u	339u	No
				Detection Rate: 80 %



A D T

802.11ac VHT20

Type 4 Radar Statistical Performances				
Trial #	Pulses per Burst	Pulse Width (s)	PRI (s)	Detection
1	12	19.9u	365u	No
2	14	17.1u	494u	Yes
3	13	11.1u	449u	Yes
4	13	13.7u	492u	Yes
5	15	15u	337u	Yes
6	13	13.2u	473u	Yes
7	13	14.2u	242u	Yes
8	13	18.8u	320u	Yes
9	14	16.4u	325u	Yes
10	16	11.4u	292u	Yes
11	13	14.5u	406u	Yes
12	16	19.7u	341u	Yes
13	16	15.1u	405u	Yes
14	12	11.4u	207u	Yes
15	13	19.8u	411u	Yes
16	15	16.6u	276u	Yes
17	13	14u	434u	Yes
18	13	12.7u	294u	Yes
19	16	11.2u	359u	Yes
20	13	11.3u	494u	Yes
21	15	17.6u	402u	No
22	14	12.1u	322u	No
23	13	18.5u	364u	Yes
24	16	14.2u	297u	Yes
25	13	17.4u	271u	Yes
26	14	12.7u	242u	No
27	13	18.5u	320u	Yes
28	16	11.1u	424u	Yes
29	13	11.4u	361u	No
30	13	12.2u	375u	Yes

Detection Rate: 83.3 %



Type 5 Radar Statistical Performances

Trial #	Test Signal Name	Detection
1	LP_Signal_01	Yes
2	LP_Signal_02	Yes
3	LP_Signal_03	Yes
4	LP_Signal_04	Yes
5	LP_Signal_05	Yes
6	LP_Signal_06	Yes
7	LP_Signal_07	Yes
8	LP_Signal_08	Yes
9	LP_Signal_09	No
10	LP_Signal_10	Yes
11	LP_Signal_11	Yes
12	LP_Signal_12	Yes
13	LP_Signal_13	Yes
14	LP_Signal_14	No
15	LP_Signal_15	Yes
16	LP_Signal_16	Yes
17	LP_Signal_17	Yes
18	LP_Signal_18	Yes
19	LP_Signal_19	Yes
20	LP_Signal_20	Yes
21	LP_Signal_21	Yes
22	LP_Signal_22	Yes
23	LP_Signal_23	No
24	LP_Signal_24	Yes
25	LP_Signal_25	Yes
26	LP_Signal_26	No
27	LP_Signal_27	No
28	LP_Signal_28	Yes
29	LP_Signal_29	Yes
30	LP_Signal_30	Yes
		Detection Rate: 83.3 %

The Long Pulse Radar pattern shown in Annex B.1



A D T

802.11ac VHT20

Type 6 Radar Statistical Performances				
Trial #	Pulses per Burst	Pulse Width (s)	PRI (s)	Detection
1	9	1.0u	333.0u	Yes
2	9	1.0u	333.0u	Yes
3	9	1.0u	333.0u	Yes
4	9	1.0u	333.0u	Yes
5	9	1.0u	333.0u	Yes
6	9	1.0u	333.0u	Yes
7	9	1.0u	333.0u	Yes
8	9	1.0u	333.0u	No
9	9	1.0u	333.0u	Yes
10	9	1.0u	333.0u	No
11	9	1.0u	333.0u	Yes
12	9	1.0u	333.0u	Yes
13	9	1.0u	333.0u	Yes
14	9	1.0u	333.0u	Yes
15	9	1.0u	333.0u	Yes
16	9	1.0u	333.0u	Yes
17	9	1.0u	333.0u	Yes
18	9	1.0u	333.0u	Yes
19	9	1.0u	333.0u	Yes
20	9	1.0u	333.0u	Yes
21	9	1.0u	333.0u	Yes
22	9	1.0u	333.0u	No
23	9	1.0u	333.0u	Yes
24	9	1.0u	333.0u	Yes
25	9	1.0u	333.0u	No
26	9	1.0u	333.0u	Yes
27	9	1.0u	333.0u	Yes
28	9	1.0u	333.0u	No
29	9	1.0u	333.0u	No
30	9	1.0u	333.0u	Yes

Detection Rate: 80 %



802.11ac VHT20

Type 6 Radar Statistical Performances

Trial #	Hopping Frequency Sequence Name	Detection
1	HOP_FREQ_SEQ_01	Yes
2	HOP_FREQ_SEQ_02	Yes
3	HOP_FREQ_SEQ_03	Yes
4	HOP_FREQ_SEQ_04	Yes
5	HOP_FREQ_SEQ_05	Yes
6	HOP_FREQ_SEQ_06	Yes
7	HOP_FREQ_SEQ_07	Yes
8	HOP_FREQ_SEQ_08	No
9	HOP_FREQ_SEQ_09	Yes
10	HOP_FREQ_SEQ_10	No
11	HOP_FREQ_SEQ_11	Yes
12	HOP_FREQ_SEQ_12	Yes
13	HOP_FREQ_SEQ_13	Yes
14	HOP_FREQ_SEQ_14	Yes
15	HOP_FREQ_SEQ_15	Yes
16	HOP_FREQ_SEQ_16	Yes
17	HOP_FREQ_SEQ_17	Yes
18	HOP_FREQ_SEQ_18	Yes
19	HOP_FREQ_SEQ_19	Yes
20	HOP_FREQ_SEQ_20	Yes
21	HOP_FREQ_SEQ_21	Yes
22	HOP_FREQ_SEQ_22	No
23	HOP_FREQ_SEQ_23	Yes
24	HOP_FREQ_SEQ_24	Yes
25	HOP_FREQ_SEQ_25	No
26	HOP_FREQ_SEQ_26	Yes
27	HOP_FREQ_SEQ_27	Yes
28	HOP_FREQ_SEQ_28	No
29	HOP_FREQ_SEQ_29	No
30	HOP_FREQ_SEQ_30	Yes

Detection Rate: 80 %

The Frequency Hopping Radar pattern shown in Annex B.2



A D T

802.11ac VHT40

Type 1 Radar Statistical Performances				
Trial #	Pulses per Burst	Pulse Width (s)	PRI (s)	Detection
1	18	1.0u	1.428m	Yes
2	18	1.0u	1.428m	Yes
3	18	1.0u	1.428m	Yes
4	18	1.0u	1.428m	No
5	18	1.0u	1.428m	Yes
6	18	1.0u	1.428m	Yes
7	18	1.0u	1.428m	Yes
8	18	1.0u	1.428m	Yes
9	18	1.0u	1.428m	Yes
10	18	1.0u	1.428m	Yes
11	18	1.0u	1.428m	Yes
12	18	1.0u	1.428m	Yes
13	18	1.0u	1.428m	Yes
14	18	1.0u	1.428m	No
15	18	1.0u	1.428m	Yes
16	18	1.0u	1.428m	Yes
17	18	1.0u	1.428m	Yes
18	18	1.0u	1.428m	Yes
19	18	1.0u	1.428m	Yes
20	18	1.0u	1.428m	No
21	18	1.0u	1.428m	No
22	18	1.0u	1.428m	Yes
23	18	1.0u	1.428m	Yes
24	18	1.0u	1.428m	Yes
25	18	1.0u	1.428m	No
26	18	1.0u	1.428m	Yes
27	18	1.0u	1.428m	Yes
28	18	1.0u	1.428m	Yes
29	18	1.0u	1.428m	No
30	18	1.0u	1.428m	Yes
				Detection Rate: 80 %



A D T

802.11ac VHT40

Type 2 Radar Statistical Performances				
Trial #	Pulses per Burst	Pulse Width (s)	PRI (s)	Detection
1	26	1.5u	167u	No
2	25	3.2u	206u	Yes
3	24	2.9u	190u	No
4	24	1u	196u	Yes
5	24	1.2u	176u	Yes
6	26	2.1u	202u	Yes
7	26	2.3u	165u	Yes
8	27	2.9u	195u	Yes
9	28	4.4u	179u	Yes
10	28	2.7u	157u	Yes
11	26	4.2u	170u	Yes
12	27	4.6u	206u	Yes
13	24	4.1u	201u	Yes
14	26	4.6u	158u	Yes
15	25	1.6u	166u	Yes
16	25	5u	215u	No
17	26	1.6u	192u	Yes
18	23	2.7u	230u	Yes
19	26	3.3u	173u	Yes
20	25	1.2u	172u	No
21	25	3u	201u	No
22	28	1.7u	187u	Yes
23	25	1u	216u	Yes
24	28	4u	189u	Yes
25	26	4.4u	160u	No
26	24	1.7u	182u	Yes
27	24	2.9u	166u	Yes
28	29	4.2u	192u	Yes
29	23	4.8u	176u	Yes
30	26	3.7u	177u	Yes
				Detection Rate: 80 %



A D T

802.11ac VHT40

Type 3 Radar Statistical Performances

Trial #	Pulses per Burst	Pulse Width (s)	PRI (s)	Detection
1	16	9.5u	416u	Yes
2	17	6.7u	407u	Yes
3	16	8.8u	342u	Yes
4	17	7.4u	333u	Yes
5	16	8.1u	405u	Yes
6	17	6.9u	304u	Yes
7	17	7.4u	310u	Yes
8	18	9.2u	332u	Yes
9	16	8.7u	305u	Yes
10	17	6.6u	343u	Yes
11	18	7.8u	283u	Yes
12	18	6.9u	339u	Yes
13	17	7u	265u	Yes
14	16	9.6u	364u	Yes
15	17	8.5u	331u	Yes
16	18	10u	221u	No
17	18	9.1u	369u	Yes
18	17	9.8u	360u	Yes
19	17	6.8u	337u	Yes
20	17	9.6u	264u	No
21	17	7.5u	379u	Yes
22	16	6.9u	467u	Yes
23	18	7.9u	371u	No
24	16	9.4u	454u	Yes
25	17	8.2u	250u	No
26	18	9u	438u	Yes
27	17	9.2u	482u	Yes
28	17	6.2u	326u	Yes
29	17	7.7u	449u	Yes
30	17	9.4u	212u	Yes

Detection Rate: 86.7 %



A D T

802.11ac VHT40

Type 4 Radar Statistical Performances

Trial #	Pulses per Burst	Pulse Width (s)	PRI (s)	Detection
1	13	20u	434u	Yes
2	15	15.2u	457u	Yes
3	16	17.7u	475u	No
4	13	12u	492u	Yes
5	14	12.2u	235u	Yes
6	13	17.3u	281u	Yes
7	15	12.4u	231u	Yes
8	12	15.7u	364u	Yes
9	14	17.4u	217u	No
10	12	18.9u	209u	Yes
11	13	17.1u	235u	No
12	14	15.8u	468u	Yes
13	13	18.9u	205u	Yes
14	16	19u	317u	Yes
15	15	13.6u	419u	Yes
16	16	12.5u	212u	Yes
17	14	12.5u	353u	No
18	12	17.7u	301u	Yes
19	14	16.5u	481u	Yes
20	13	17.7u	275u	Yes
21	12	16.7u	415u	Yes
22	12	17.6u	287u	Yes
23	16	17.6u	402u	Yes
24	14	18.2u	206u	Yes
25	15	12.4u	312u	Yes
26	13	13.3u	325u	Yes
27	15	15u	286u	No
28	14	19.6u	306u	Yes
29	13	12.8u	219u	Yes
30	13	13.2u	447u	Yes

Detection Rate: 83.3 %



A D T

802.11ac VHT40

Type 5 Radar Statistical Performances		
Trial #	Test Signal Name	Detection
1	LP_Signal_01	Yes
2	LP_Signal_02	Yes
3	LP_Signal_03	Yes
4	LP_Signal_04	Yes
5	LP_Signal_05	Yes
6	LP_Signal_06	Yes
7	LP_Signal_07	No
8	LP_Signal_08	Yes
9	LP_Signal_09	Yes
10	LP_Signal_10	No
11	LP_Signal_11	Yes
12	LP_Signal_12	Yes
13	LP_Signal_13	No
14	LP_Signal_14	Yes
15	LP_Signal_15	Yes
16	LP_Signal_16	Yes
17	LP_Signal_17	Yes
18	LP_Signal_18	Yes
19	LP_Signal_19	Yes
20	LP_Signal_20	Yes
21	LP_Signal_21	Yes
22	LP_Signal_22	Yes
23	LP_Signal_23	Yes
24	LP_Signal_24	Yes
25	LP_Signal_25	No
26	LP_Signal_26	Yes
27	LP_Signal_27	No
28	LP_Signal_28	Yes
29	LP_Signal_29	Yes
30	LP_Signal_30	Yes

Detection Rate: 83.3 %

The Long Pulse Radar pattern shown in Annex B.1



802.11ac VHT40

A D T

Type 6 Radar Statistical Performances

Trial #	Pulses per Burst	Pulse Width (s)	PRI (s)	Detection
1	9	1.0u	333.0u	Yes
2	9	1.0u	333.0u	No
3	9	1.0u	333.0u	Yes
4	9	1.0u	333.0u	Yes
5	9	1.0u	333.0u	Yes
6	9	1.0u	333.0u	No
7	9	1.0u	333.0u	Yes
8	9	1.0u	333.0u	Yes
9	9	1.0u	333.0u	Yes
10	9	1.0u	333.0u	Yes
11	9	1.0u	333.0u	Yes
12	9	1.0u	333.0u	Yes
13	9	1.0u	333.0u	Yes
14	9	1.0u	333.0u	No
15	9	1.0u	333.0u	No
16	9	1.0u	333.0u	Yes
17	9	1.0u	333.0u	Yes
18	9	1.0u	333.0u	Yes
19	9	1.0u	333.0u	Yes
20	9	1.0u	333.0u	Yes
21	9	1.0u	333.0u	Yes
22	9	1.0u	333.0u	Yes
23	9	1.0u	333.0u	Yes
24	9	1.0u	333.0u	Yes
25	9	1.0u	333.0u	Yes
26	9	1.0u	333.0u	Yes
27	9	1.0u	333.0u	Yes
28	9	1.0u	333.0u	Yes
29	9	1.0u	333.0u	No
30	9	1.0u	333.0u	Yes

Detection Rate: 83.3 %



802.11ac VHT40

A D T

Type 6 Radar Statistical Performances

Trial #	Hopping Frequency Sequence Name	Detection
1	HOP_FREQ_SEQ_01	Yes
2	HOP_FREQ_SEQ_02	No
3	HOP_FREQ_SEQ_03	Yes
4	HOP_FREQ_SEQ_04	Yes
5	HOP_FREQ_SEQ_05	Yes
6	HOP_FREQ_SEQ_06	No
7	HOP_FREQ_SEQ_07	Yes
8	HOP_FREQ_SEQ_08	Yes
9	HOP_FREQ_SEQ_09	Yes
10	HOP_FREQ_SEQ_10	Yes
11	HOP_FREQ_SEQ_11	Yes
12	HOP_FREQ_SEQ_12	Yes
13	HOP_FREQ_SEQ_13	Yes
14	HOP_FREQ_SEQ_14	No
15	HOP_FREQ_SEQ_15	No
16	HOP_FREQ_SEQ_16	Yes
17	HOP_FREQ_SEQ_17	Yes
18	HOP_FREQ_SEQ_18	Yes
19	HOP_FREQ_SEQ_19	Yes
20	HOP_FREQ_SEQ_20	Yes
21	HOP_FREQ_SEQ_21	Yes
22	HOP_FREQ_SEQ_22	Yes
23	HOP_FREQ_SEQ_23	Yes
24	HOP_FREQ_SEQ_24	Yes
25	HOP_FREQ_SEQ_25	Yes
26	HOP_FREQ_SEQ_26	Yes
27	HOP_FREQ_SEQ_27	Yes
28	HOP_FREQ_SEQ_28	Yes
29	HOP_FREQ_SEQ_29	No
30	HOP_FREQ_SEQ_30	Yes

Detection Rate: 83.3 %

The Frequency Hopping Radar pattern shown in Annex B.2



A D T

802.11ac VHT80

Type 1 Radar Statistical Performances				
Trial #	Pulses per Burst	Pulse Width (s)	PRI (s)	Detection
1	18	1.0u	1.428m	Yes
2	18	1.0u	1.428m	Yes
3	18	1.0u	1.428m	Yes
4	18	1.0u	1.428m	No
5	18	1.0u	1.428m	Yes
6	18	1.0u	1.428m	Yes
7	18	1.0u	1.428m	Yes
8	18	1.0u	1.428m	Yes
9	18	1.0u	1.428m	Yes
10	18	1.0u	1.428m	Yes
11	18	1.0u	1.428m	Yes
12	18	1.0u	1.428m	Yes
13	18	1.0u	1.428m	Yes
14	18	1.0u	1.428m	No
15	18	1.0u	1.428m	Yes
16	18	1.0u	1.428m	Yes
17	18	1.0u	1.428m	Yes
18	18	1.0u	1.428m	Yes
19	18	1.0u	1.428m	Yes
20	18	1.0u	1.428m	No
21	18	1.0u	1.428m	Yes
22	18	1.0u	1.428m	Yes
23	18	1.0u	1.428m	Yes
24	18	1.0u	1.428m	Yes
25	18	1.0u	1.428m	Yes
26	18	1.0u	1.428m	Yes
27	18	1.0u	1.428m	Yes
28	18	1.0u	1.428m	Yes
29	18	1.0u	1.428m	No
30	18	1.0u	1.428m	Yes
				Detection Rate: 86.7 %



A D T

802.11ac VHT80

Type 2 Radar Statistical Performances				
Trial #	Pulses per Burst	Pulse Width (s)	PRI (s)	Detection
1	29	3.2u	176u	No
2	28	4.5u	171u	Yes
3	24	2.1u	175u	Yes
4	28	2.8u	154u	Yes
5	26	4.1u	226u	No
6	24	1.3u	174u	No
7	23	2.3u	175u	Yes
8	28	1.1u	202u	Yes
9	28	4.8u	195u	Yes
10	26	1.5u	160u	Yes
11	28	4.5u	157u	Yes
12	23	1.4u	187u	Yes
13	28	1.2u	151u	Yes
14	27	3.2u	170u	Yes
15	25	5u	228u	Yes
16	23	2.9u	161u	No
17	26	3u	219u	Yes
18	27	1.8u	190u	Yes
19	28	4.5u	158u	Yes
20	28	3.1u	229u	Yes
21	25	3.3u	218u	Yes
22	28	3.9u	183u	Yes
23	25	1.5u	200u	No
24	29	2.3u	203u	Yes
25	26	3.5u	201u	Yes
26	29	1.2u	169u	Yes
27	26	1.8u	186u	No
28	27	2.7u	164u	Yes
29	27	3.5u	169u	Yes
30	23	1.5u	215u	Yes
				Detection Rate: 80 %



A D T

802.11ac VHT80

Type 3 Radar Statistical Performances				
Trial #	Pulses per Burst	Pulse Width (s)	PRI (s)	Detection
1	16	8.6u	347u	Yes
2	18	7.1u	426u	Yes
3	16	9.3u	463u	No
4	18	8.4u	222u	Yes
5	17	7u	251u	Yes
6	18	9.6u	450u	Yes
7	18	6.9u	355u	Yes
8	16	7.6u	413u	Yes
9	16	7.6u	258u	Yes
10	17	6.1u	339u	Yes
11	18	7.5u	376u	Yes
12	17	9.8u	348u	Yes
13	17	7.3u	401u	Yes
14	16	8.5u	303u	Yes
15	18	6u	231u	Yes
16	16	7u	448u	No
17	18	6.8u	464u	Yes
18	17	6u	356u	Yes
19	18	9.1u	281u	Yes
20	17	10u	440u	No
21	16	8.1u	215u	Yes
22	17	8.5u	305u	Yes
23	18	8.3u	320u	No
24	17	7.8u	312u	Yes
25	17	7.3u	462u	No
26	16	8.6u	323u	Yes
27	16	7.4u	237u	Yes
28	17	8.9u	275u	Yes
29	16	7.7u	328u	Yes
30	17	8u	219u	Yes
				Detection Rate: 83.3 %



A D T

802.11ac VHT80

Type 4 Radar Statistical Performances				
Trial #	Pulses per Burst	Pulse Width (s)	PRI (s)	Detection
1	15	12.6u	205u	Yes
2	14	14u	404u	Yes
3	13	13.1u	359u	No
4	16	13.1u	454u	Yes
5	14	19.1u	322u	Yes
6	15	11.2u	359u	Yes
7	13	12.9u	272u	Yes
8	13	17u	407u	Yes
9	14	11.8u	269u	No
10	13	14.7u	236u	Yes
11	13	14.6u	382u	No
12	13	11.4u	296u	Yes
13	15	19u	246u	Yes
14	12	17.7u	381u	Yes
15	15	11u	458u	Yes
16	14	16.4u	234u	Yes
17	13	11.4u	446u	No
18	14	18.7u	337u	Yes
19	14	16.9u	204u	Yes
20	13	17.2u	311u	No
21	15	18.8u	308u	Yes
22	14	17.2u	267u	Yes
23	13	13u	243u	Yes
24	16	11.5u	276u	Yes
25	14	14.8u	254u	Yes
26	14	17.7u	437u	Yes
27	13	15.7u	366u	No
28	15	18.6u	484u	Yes
29	14	17.1u	380u	Yes
30	15	11.6u	228u	Yes
				Detection Rate: 80 %



A D T

802.11ac VHT80

Type 5 Radar Statistical Performances		
Trial #	Test Signal Name	Detection
1	LP_Signal_01	Yes
2	LP_Signal_02	Yes
3	LP_Signal_03	Yes
4	LP_Signal_04	Yes
5	LP_Signal_05	Yes
6	LP_Signal_06	Yes
7	LP_Signal_07	No
8	LP_Signal_08	Yes
9	LP_Signal_09	Yes
10	LP_Signal_10	No
11	LP_Signal_11	Yes
12	LP_Signal_12	Yes
13	LP_Signal_13	No
14	LP_Signal_14	Yes
15	LP_Signal_15	Yes
16	LP_Signal_16	Yes
17	LP_Signal_17	Yes
18	LP_Signal_18	Yes
19	LP_Signal_19	Yes
20	LP_Signal_20	Yes
21	LP_Signal_21	Yes
22	LP_Signal_22	Yes
23	LP_Signal_23	Yes
24	LP_Signal_24	Yes
25	LP_Signal_25	No
26	LP_Signal_26	Yes
27	LP_Signal_27	Yes
28	LP_Signal_28	No
29	LP_Signal_29	No
30	LP_Signal_30	Yes

Detection Rate: 80 %

The Long Pulse Radar pattern shown in Annex B.1



802.11ac VHT80

A D T

Type 6 Radar Statistical Performances

Trial #	Pulses per Burst	Pulse Width (s)	PRI (s)	Detection
1	9	1.0u	333.0u	Yes
2	9	1.0u	333.0u	No
3	9	1.0u	333.0u	Yes
4	9	1.0u	333.0u	Yes
5	9	1.0u	333.0u	Yes
6	9	1.0u	333.0u	No
7	9	1.0u	333.0u	Yes
8	9	1.0u	333.0u	Yes
9	9	1.0u	333.0u	Yes
10	9	1.0u	333.0u	Yes
11	9	1.0u	333.0u	Yes
12	9	1.0u	333.0u	Yes
13	9	1.0u	333.0u	Yes
14	9	1.0u	333.0u	No
15	9	1.0u	333.0u	No
16	9	1.0u	333.0u	Yes
17	9	1.0u	333.0u	Yes
18	9	1.0u	333.0u	Yes
19	9	1.0u	333.0u	Yes
20	9	1.0u	333.0u	Yes
21	9	1.0u	333.0u	Yes
22	9	1.0u	333.0u	Yes
23	9	1.0u	333.0u	Yes
24	9	1.0u	333.0u	Yes
25	9	1.0u	333.0u	Yes
26	9	1.0u	333.0u	No
27	9	1.0u	333.0u	Yes
28	9	1.0u	333.0u	Yes
29	9	1.0u	333.0u	Yes
30	9	1.0u	333.0u	Yes

Detection Rate: 83.3 %



802.11ac VHT80

A D T

Type 6 Radar Statistical Performances

Trial #	Hopping Frequency Sequence Name	Detection
1	HOP_FREQ_SEQ_01	Yes
2	HOP_FREQ_SEQ_02	No
3	HOP_FREQ_SEQ_03	Yes
4	HOP_FREQ_SEQ_04	Yes
5	HOP_FREQ_SEQ_05	Yes
6	HOP_FREQ_SEQ_06	No
7	HOP_FREQ_SEQ_07	Yes
8	HOP_FREQ_SEQ_08	Yes
9	HOP_FREQ_SEQ_09	Yes
10	HOP_FREQ_SEQ_10	Yes
11	HOP_FREQ_SEQ_11	Yes
12	HOP_FREQ_SEQ_12	Yes
13	HOP_FREQ_SEQ_13	Yes
14	HOP_FREQ_SEQ_14	No
15	HOP_FREQ_SEQ_15	No
16	HOP_FREQ_SEQ_16	Yes
17	HOP_FREQ_SEQ_17	Yes
18	HOP_FREQ_SEQ_18	Yes
19	HOP_FREQ_SEQ_19	Yes
20	HOP_FREQ_SEQ_20	Yes
21	HOP_FREQ_SEQ_21	Yes
22	HOP_FREQ_SEQ_22	Yes
23	HOP_FREQ_SEQ_23	Yes
24	HOP_FREQ_SEQ_24	Yes
25	HOP_FREQ_SEQ_25	Yes
26	HOP_FREQ_SEQ_26	No
27	HOP_FREQ_SEQ_27	Yes
28	HOP_FREQ_SEQ_28	Yes
29	HOP_FREQ_SEQ_29	Yes
30	HOP_FREQ_SEQ_30	Yes

Detection Rate: 83.3 %

The Frequency Hopping Radar pattern shown in Annex B.2



A D T

6.2.1.4 NON- OCCUPANCY PERIOD

1) Test results demonstrating an associated client link is established with the master on a test frequency.

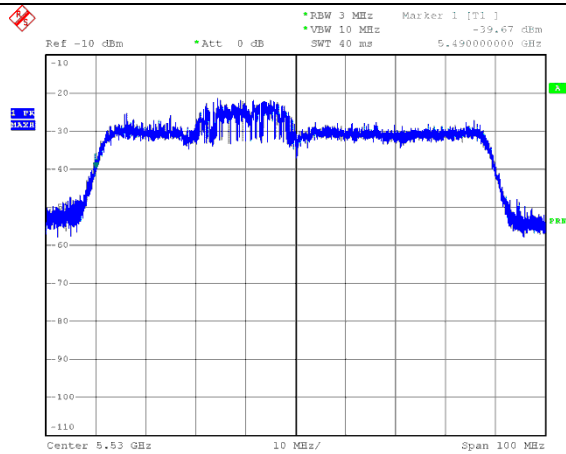

EUT (master) links with Client on 5530MHz

2) The master and DFS-certified client device are associated, and the movie can be streamed as specified in the DFS Order for a non-occupancy period test.

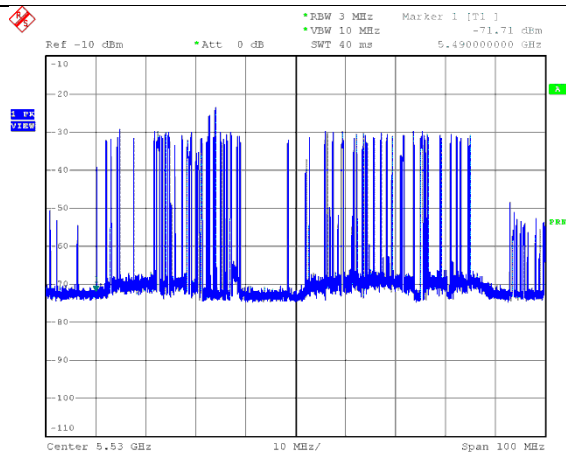

Client plays a specified files via master.



A D T

6.2.1.5 UNIFORM SPREADING

The manufacturer declare:

The intention of the uniform spreading is to provide, on aggregate, a uniform loading of the spectrum. The UUT using the bands 5150 to 5350MHz and 5470 to 5850 MHz shall select an operating channel out of the 22 channels, so that the probability of selecting a given channel shall be the same for all channels.

The UUT will select channel by random mode and remember this channel when detect radar signal, so that will select unused channel by random mode.

6.2.1.6 U-NII DETECTION BANDWIDTH

802.11ac VHT20

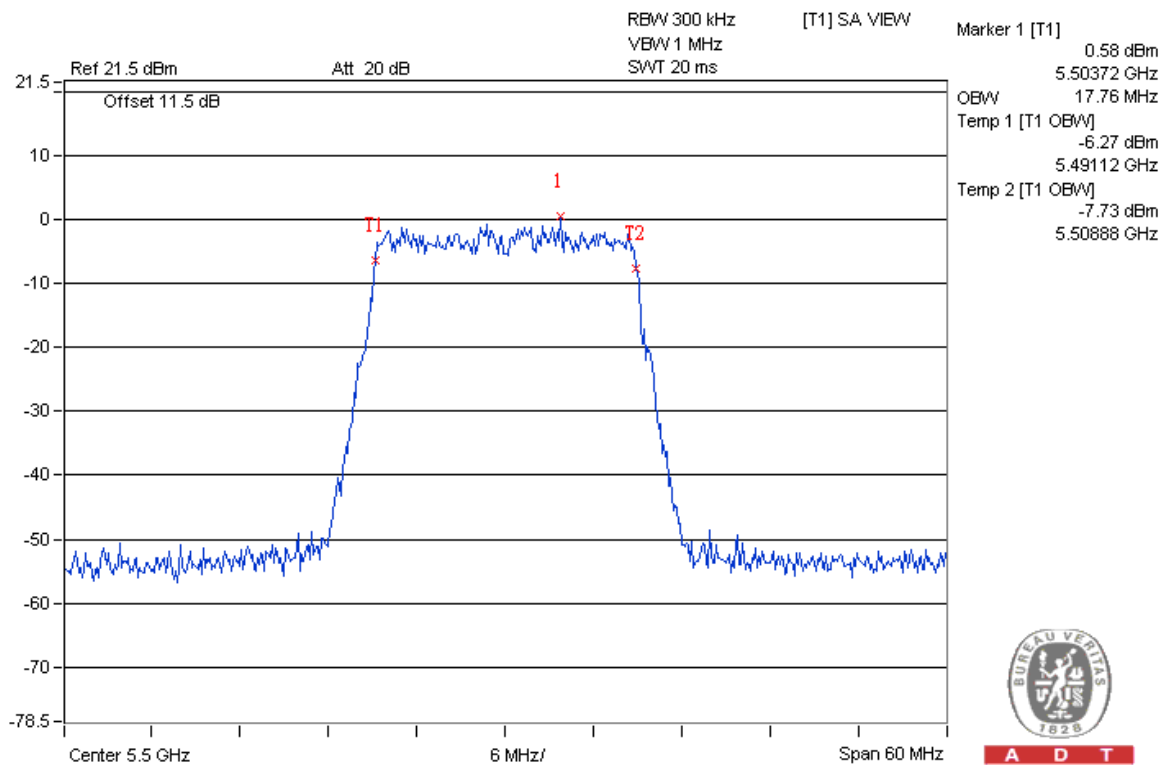

A D T

U-NII 99% Channel bandwidth

802.11ac VHT20



Detection Bandwidth Test
 EUT Frequency: 5.500GHz
 EUT 99% Power bandwidth: 17.76MHz
 Detection bandwidth limit (80% of EUT 99% Power bandwidth): 14.21MHz
 Detection Bandwidth (FH - FL): 16MHz
 Test Result : PASS

Radar Frequency (Hz)	Trial Number / Detection										Detection Rate (%)
	1	2	3	4	5	6	7	8	9	10	
5.490G	No	No	No	No	No	No	No	No	No	No	0
5.491G	No	No	No	No	No	No	No	No	No	No	0
5.492G(FL)	No	Yes	Yes	Yes	Yes	Yes	Yes	Yes	Yes	Yes	90
5.493G	Yes	Yes	Yes	Yes	Yes	Yes	Yes	Yes	Yes	Yes	100
5.494G	Yes	Yes	Yes	Yes	Yes	Yes	Yes	Yes	Yes	Yes	100
5.495G	Yes	Yes	Yes	Yes	Yes	Yes	Yes	Yes	Yes	Yes	100
5.496G	Yes	Yes	Yes	Yes	Yes	Yes	Yes	Yes	Yes	Yes	100
5.497G	Yes	Yes	Yes	Yes	Yes	Yes	Yes	Yes	Yes	Yes	100
5.498G	Yes	Yes	Yes	Yes	Yes	Yes	Yes	Yes	Yes	Yes	100
5.499G	Yes	Yes	Yes	Yes	Yes	Yes	Yes	Yes	Yes	Yes	100
5.500G	Yes	Yes	Yes	Yes	Yes	Yes	Yes	Yes	Yes	Yes	100
5.501G	Yes	Yes	Yes	Yes	Yes	Yes	Yes	Yes	Yes	Yes	100
5.502G	Yes	Yes	Yes	Yes	Yes	Yes	Yes	Yes	Yes	Yes	100
5.503G	Yes	Yes	Yes	Yes	Yes	Yes	Yes	Yes	Yes	Yes	100
5.504G	Yes	Yes	Yes	Yes	Yes	Yes	Yes	Yes	Yes	Yes	100
5.505G	Yes	Yes	Yes	Yes	Yes	Yes	Yes	Yes	Yes	Yes	100
5.506G	Yes	Yes	Yes	Yes	Yes	Yes	Yes	Yes	Yes	Yes	100
5.507G	Yes	Yes	Yes	Yes	Yes	Yes	Yes	Yes	Yes	Yes	100
5.508G(FH)	No	Yes	Yes	Yes	Yes	Yes	Yes	Yes	Yes	Yes	90
5.509G	No	No	No	No	No	No	No	No	No	No	0
5.510G	No	No	No	No	No	No	No	No	No	No	0

802.11ac VHT40

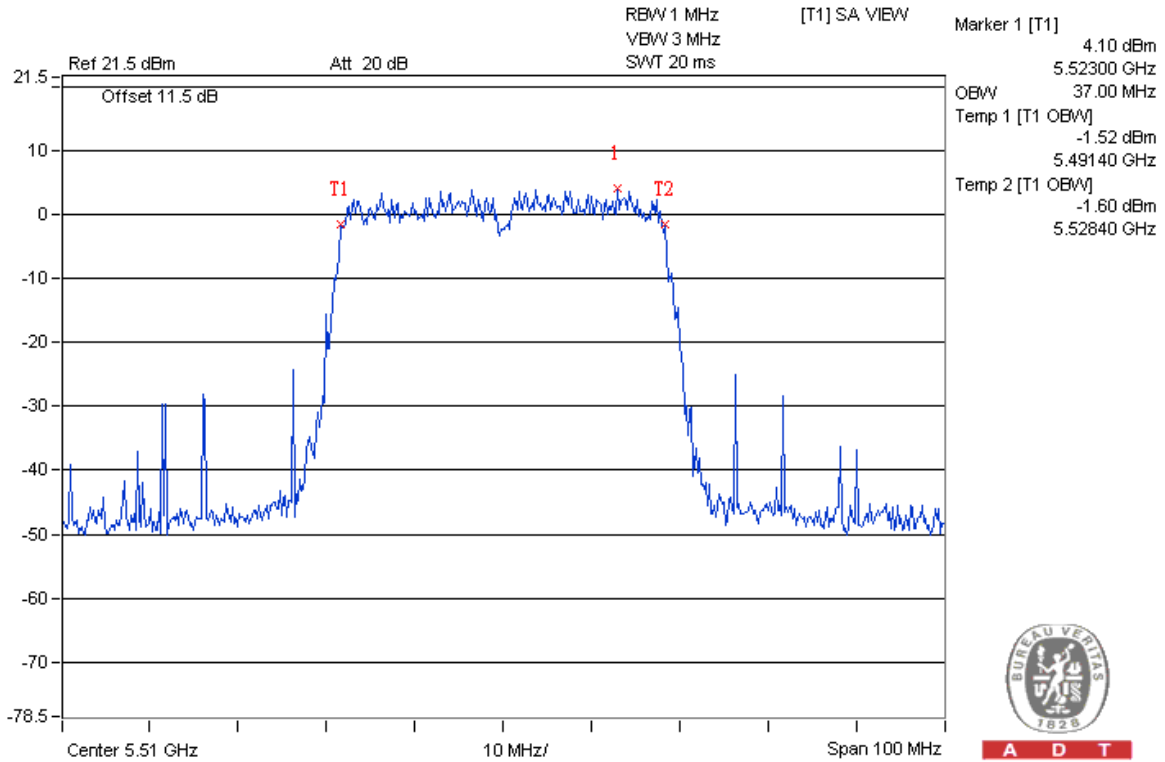

U-NII 99% Channel bandwidth



A D T

802.11ac VHT40

Detection Bandwidth Test
 EUT Frequency: 5.510GHz
 EUT 99% Power bandwidth: 37MHz
 Detection bandwidth limit (80% of EUT 99% Power bandwidth): 29.6MHz
 Detection Bandwidth (FH - FL): 30MHz
 Test Result : PASS

Radar Frequency (Hz)	Trial Number / Detection										Detection Rate (%)
	1	2	3	4	5	6	7	8	9	10	
5.490G	No	No	No	No	No	No	No	No	No	No	0
5.491G	No	No	No	No	No	No	No	No	No	No	0
5.492G	No	No	No	No	No	No	No	No	No	No	0
5.493G	No	No	No	No	No	No	No	No	No	No	0
5.494G	No	No	No	No	No	No	No	No	No	No	0
5.495G(FL)	No	Yes	Yes	Yes	Yes	Yes	Yes	Yes	Yes	Yes	90
5.496G	Yes	Yes	Yes	Yes	Yes	Yes	Yes	Yes	Yes	Yes	100
5.497G	Yes	Yes	Yes	Yes	Yes	Yes	Yes	Yes	Yes	Yes	100
5.498G	Yes	Yes	Yes	Yes	Yes	Yes	Yes	Yes	Yes	Yes	100
5.499G	Yes	Yes	Yes	Yes	Yes	Yes	Yes	Yes	Yes	Yes	100
5.500G	Yes	Yes	Yes	Yes	Yes	Yes	Yes	Yes	Yes	Yes	100
5.501G	Yes	Yes	Yes	Yes	Yes	Yes	Yes	Yes	Yes	Yes	100
5.502G	Yes	Yes	Yes	Yes	Yes	Yes	Yes	Yes	Yes	Yes	100
5.503G	Yes	Yes	Yes	Yes	Yes	Yes	Yes	Yes	Yes	Yes	100
5.504G	Yes	Yes	Yes	Yes	Yes	Yes	Yes	Yes	Yes	Yes	100
5.505G	Yes	Yes	Yes	Yes	Yes	Yes	Yes	Yes	Yes	Yes	100
5.506G	Yes	Yes	Yes	Yes	Yes	Yes	Yes	Yes	Yes	Yes	100
5.507G	Yes	Yes	Yes	Yes	Yes	Yes	Yes	Yes	Yes	Yes	100
5.508G	Yes	Yes	Yes	Yes	Yes	Yes	Yes	Yes	Yes	Yes	100
5.509G	Yes	Yes	Yes	Yes	Yes	Yes	Yes	Yes	Yes	Yes	100
5.510G	Yes	Yes	Yes	Yes	Yes	Yes	Yes	Yes	Yes	Yes	100
5.511G	Yes	Yes	Yes	Yes	Yes	Yes	Yes	Yes	Yes	Yes	100
5.512G	Yes	Yes	Yes	Yes	Yes	Yes	Yes	Yes	Yes	Yes	100
5.513G	Yes	Yes	Yes	Yes	Yes	Yes	Yes	Yes	Yes	Yes	100
5.514G	Yes	Yes	Yes	Yes	Yes	Yes	Yes	Yes	Yes	Yes	100
5.515G	Yes	Yes	Yes	Yes	Yes	Yes	Yes	Yes	Yes	Yes	100
5.516G	Yes	Yes	Yes	Yes	Yes	Yes	Yes	Yes	Yes	Yes	100
5.517G	Yes	Yes	Yes	Yes	Yes	Yes	Yes	Yes	Yes	Yes	100
5.518G	Yes	Yes	Yes	Yes	Yes	Yes	Yes	Yes	Yes	Yes	100
5.519G	Yes	Yes	Yes	Yes	Yes	Yes	Yes	Yes	Yes	Yes	100
5.520G	Yes	Yes	Yes	Yes	Yes	Yes	Yes	Yes	Yes	Yes	100
5.521G	Yes	Yes	Yes	Yes	Yes	Yes	Yes	Yes	Yes	Yes	100
5.522G	Yes	Yes	Yes	Yes	Yes	Yes	Yes	Yes	Yes	Yes	100
5.523G	Yes	Yes	Yes	Yes	Yes	Yes	Yes	Yes	Yes	Yes	100
5.524G	Yes	Yes	Yes	Yes	Yes	Yes	Yes	Yes	Yes	Yes	100
5.525G (FH)	No	Yes	Yes	Yes	Yes	Yes	Yes	Yes	Yes	Yes	90
5.526G	No	No	No	No	No	No	No	No	No	No	0
5.527G	No	No	No	No	No	No	No	No	No	No	0
5.528G	No	No	No	No	No	No	No	No	No	No	0
5.529G	No	No	No	No	No	No	No	No	No	No	0
5.530G	No	No	No	No	No	No	No	No	No	No	0

802.11ac VHT80



A D T

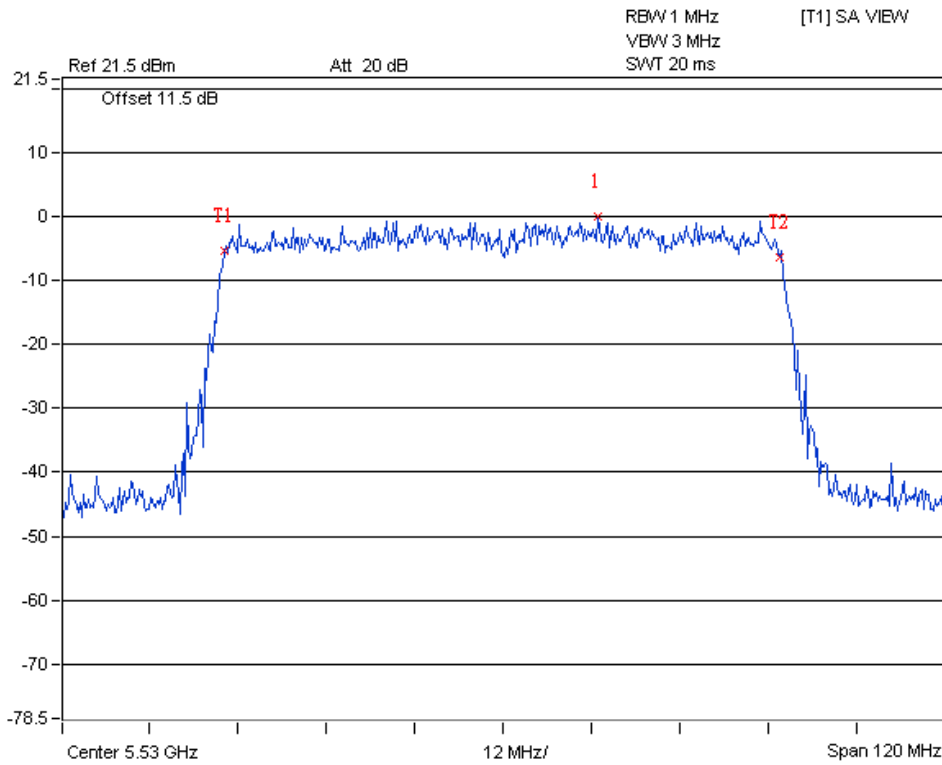

Marker 1 [T1] -0.06 dBm
5.54296 GHz
OBW 75.84 MHz
Temp 1 [T1 OBW] -5.25 dBm
5.49184 GHz
Temp 2 [T1 OBW] -6.30 dBm
5.56768 GHz



A D T

U-NII 99% Channel bandwidth



A D T

802.11ac VHT80

Detection Bandwidth Test
 EUT Frequency: 5.530GHz
 EUT 99% Power bandwidth: 75.84MHz
 Detection bandwidth limit (80% of EUT 99% Power bandwidth): 60.672MHz
 Detection Bandwidth (FH - FL): 61MHz
 Test Result : PASS

Radar Frequency (Hz)	Trial Number / Detection										Detection Rate (%)
	1	2	3	4	5	6	7	8	9	10	
5.490G	No	No	No	No	No	No	No	No	No	No	0
5.491G	No	No	No	No	No	No	No	No	No	No	0
5.492G	No	No	No	No	No	No	No	No	No	No	0
5.493G	No	No	No	No	No	No	No	No	No	No	0
5.494G	No	No	No	No	No	No	No	No	No	No	0
5.495G	No	No	No	No	No	No	No	No	No	No	0
5.496G	No	No	No	No	No	No	No	No	No	No	0
5.497G	No	No	No	No	No	No	No	No	No	No	0
5.498G	No	No	No	No	No	No	No	No	No	No	0
5.499G(FL)	No	Yes	Yes	Yes	Yes	Yes	Yes	Yes	Yes	Yes	90
5.500G	Yes	Yes	Yes	Yes	Yes	Yes	Yes	Yes	Yes	Yes	100
5.501G	Yes	Yes	Yes	Yes	Yes	Yes	Yes	Yes	Yes	Yes	100
5.502G	No	Yes	Yes	Yes	Yes	Yes	Yes	Yes	Yes	Yes	90
5.503G	Yes	Yes	Yes	Yes	Yes	Yes	Yes	Yes	Yes	Yes	100
5.504G	Yes	Yes	Yes	Yes	Yes	Yes	Yes	Yes	Yes	Yes	100
5.505G	Yes	Yes	Yes	Yes	Yes	Yes	Yes	Yes	Yes	Yes	100
5.506G	Yes	Yes	Yes	Yes	Yes	Yes	Yes	Yes	Yes	Yes	100
5.507G	No	Yes	Yes	Yes	Yes	Yes	Yes	Yes	Yes	Yes	90
5.508G	Yes	Yes	Yes	Yes	Yes	Yes	Yes	Yes	Yes	Yes	100
5.509G	Yes	Yes	Yes	Yes	Yes	Yes	Yes	Yes	Yes	Yes	100
5.510G	Yes	Yes	Yes	Yes	Yes	Yes	Yes	Yes	Yes	Yes	100
5.511G	No	Yes	Yes	Yes	Yes	Yes	Yes	Yes	Yes	Yes	90
5.512G	Yes	Yes	Yes	Yes	Yes	Yes	Yes	Yes	Yes	Yes	100
5.513G	Yes	Yes	Yes	Yes	Yes	Yes	Yes	Yes	Yes	Yes	100
5.514G	Yes	Yes	Yes	Yes	Yes	Yes	Yes	Yes	Yes	Yes	100
5.515G	Yes	Yes	Yes	Yes	Yes	Yes	Yes	Yes	Yes	Yes	100
5.516G	Yes	Yes	Yes	Yes	Yes	Yes	Yes	Yes	Yes	Yes	100
5.517G	Yes	Yes	Yes	Yes	Yes	Yes	Yes	Yes	Yes	Yes	100
5.518G	Yes	Yes	Yes	Yes	Yes	Yes	Yes	Yes	Yes	Yes	100
5.519G	Yes	Yes	Yes	Yes	Yes	Yes	Yes	Yes	Yes	Yes	100
5.520G	No	Yes	Yes	Yes	Yes	Yes	Yes	Yes	Yes	Yes	90
5.521G	Yes	Yes	Yes	Yes	Yes	Yes	Yes	Yes	Yes	Yes	100
5.522G	Yes	Yes	Yes	Yes	Yes	Yes	Yes	Yes	Yes	Yes	100
5.523G	Yes	Yes	Yes	Yes	Yes	Yes	Yes	Yes	Yes	Yes	100
5.524G	Yes	Yes	Yes	Yes	Yes	Yes	Yes	Yes	Yes	Yes	100
5.525G	Yes	Yes	Yes	Yes	Yes	Yes	Yes	Yes	Yes	Yes	100
5.526G	Yes	Yes	Yes	Yes	Yes	Yes	Yes	Yes	Yes	Yes	100
5.527G	Yes	Yes	Yes	Yes	Yes	Yes	Yes	Yes	Yes	Yes	100
5.528G	Yes	Yes	Yes	Yes	Yes	Yes	Yes	Yes	Yes	Yes	100
5.529G	Yes	Yes	Yes	Yes	Yes	Yes	Yes	Yes	Yes	Yes	100
5.530G	No	Yes	Yes	Yes	Yes	Yes	Yes	Yes	Yes	Yes	90
5.531G	Yes	Yes	Yes	Yes	Yes	Yes	Yes	Yes	Yes	Yes	100
5.532G	Yes	Yes	Yes	Yes	Yes	Yes	Yes	Yes	Yes	Yes	100
5.533G	Yes	Yes	Yes	Yes	Yes	Yes	Yes	Yes	Yes	Yes	100



A D T

Radar Frequency (Hz)	Trial Number / Detection										Detection Rate (%)
	1	2	3	4	5	6	7	8	9	10	
5.534G	Yes	Yes	Yes	Yes	Yes	Yes	Yes	Yes	Yes	Yes	100
5.535G	Yes	Yes	Yes	Yes	Yes	Yes	Yes	Yes	Yes	Yes	100
5.536G	Yes	Yes	Yes	Yes	Yes	Yes	Yes	Yes	Yes	Yes	100
5.537G	Yes	Yes	Yes	Yes	Yes	Yes	Yes	Yes	Yes	Yes	100
5.538G	Yes	Yes	Yes	Yes	Yes	Yes	Yes	Yes	Yes	Yes	100
5.539G	Yes	Yes	Yes	Yes	Yes	Yes	Yes	Yes	Yes	Yes	100
5.540G	Yes	Yes	Yes	Yes	Yes	Yes	Yes	Yes	Yes	Yes	100
5.541G	Yes	Yes	Yes	Yes	Yes	Yes	Yes	Yes	Yes	Yes	100
5.542G	No	Yes	Yes	Yes	Yes	Yes	Yes	Yes	Yes	Yes	90
5.543G	Yes	Yes	Yes	Yes	Yes	Yes	Yes	Yes	Yes	Yes	100
5.544G	Yes	Yes	Yes	Yes	Yes	Yes	Yes	Yes	Yes	Yes	100
5.545G	Yes	Yes	Yes	Yes	Yes	Yes	Yes	Yes	Yes	Yes	100
5.546G	Yes	Yes	Yes	Yes	Yes	Yes	Yes	Yes	Yes	Yes	100
5.547G	No	Yes	Yes	Yes	Yes	Yes	Yes	Yes	Yes	Yes	90
5.548G	Yes	Yes	Yes	Yes	Yes	Yes	Yes	Yes	Yes	Yes	100
5.549G	Yes	Yes	Yes	Yes	Yes	Yes	Yes	Yes	Yes	Yes	100
5.550G	Yes	Yes	Yes	Yes	Yes	Yes	Yes	Yes	Yes	Yes	100
5.551G	Yes	Yes	Yes	Yes	Yes	Yes	Yes	Yes	Yes	Yes	100
5.552G	No	Yes	Yes	Yes	Yes	Yes	Yes	Yes	Yes	Yes	90
5.553G	Yes	Yes	Yes	Yes	Yes	Yes	Yes	Yes	Yes	Yes	100
5.554G	Yes	Yes	Yes	Yes	Yes	Yes	Yes	Yes	Yes	Yes	100
5.555G	Yes	Yes	Yes	Yes	Yes	Yes	Yes	Yes	Yes	Yes	100
5.556G	No	Yes	Yes	Yes	Yes	Yes	Yes	Yes	Yes	Yes	90
5.557G	Yes	Yes	Yes	Yes	Yes	Yes	Yes	Yes	Yes	Yes	100
5.558G	Yes	Yes	Yes	Yes	Yes	Yes	Yes	Yes	Yes	Yes	100
5.559G	Yes	Yes	Yes	Yes	Yes	Yes	Yes	Yes	Yes	Yes	100
5.560G(FH)	No	Yes	Yes	Yes	Yes	Yes	Yes	Yes	Yes	Yes	90
5.561G	No	No	No	No	No	No	No	No	No	No	0
5.562G	No	No	No	No	No	No	No	No	No	No	0
5.563G	No	No	No	No	No	No	No	No	No	No	0
5.564G	No	No	No	No	No	No	No	No	No	No	0
5.565G	No	No	No	No	No	No	No	No	No	No	0
5.566G	No	No	No	No	No	No	No	No	No	No	0
5.567G	No	No	No	No	No	No	No	No	No	No	0
5.568G	No	No	No	No	No	No	No	No	No	No	0
5.569G	No	No	No	No	No	No	No	No	No	No	0
5.570G	No	No	No	No	No	No	No	No	No	No	0



A D T

6.2.1.7 NON-CO-CHANNEL TEST

The UUT was investigated after radar was detected the channel and made sure no co-channel operation with radars.



A D T

7 INFORMATION ON THE TESTING LABORATORIES

We, Bureau Veritas Consumer Products Services (H.K.) Ltd., Taoyuan Branch, were founded in 1988 to provide our best service in EMC, Radio, Telecom and Safety consultation. Our laboratories are accredited and approved according to ISO/IEC 17025.

If you have any comments, please feel free to contact us at the following:

Linko EMC/RF Lab:

Tel: 886-2-26052180

Fax: 886-2-26052943

Hsin Chu EMC/RF/Telecom Lab:

Tel: 886-3-5935343

Fax: 886-3-5935342

Hwa Ya EMC/RF/Safety Lab:

Tel: 886-3-3183232

Fax: 886-3-3270892

Email: service.adt@tw.bureauveritas.com

Web Site: www.bureauveritas-adt.com

The address and road map of all our labs can be found in our web site also.



A D T

8 APPENDIX-A

Modifications or adding components during the test

No any modifications are made to the EUT by the lab during the test.



9 APPENDIX-B

RADAR TEST SIGNAL

B.1 The Long Pulse Radar Pattern

802.11ac VHT20

Long Pulse Radar Test Signal						
Test Signal Name: LP_Signal_01						
Number of Bursts in Trial: 8						
Burst	Pulses per Burst	Chrip (Hz)	Pulse Width (s)	Pulse 1 to 2 Spacing (s)	Pulse 2 to 3 Spacing (s)	Start Location (s)
1	3	5M	85.3u	1.167m	1.633m	482m
2	2	17M	82.2u	1.069m	0m	674m
3	3	5M	73.1u	1.445m	1.688m	249m
4	3	8M	83.7u	1.643m	1.446m	1205m
5	1	13M	98.6u	-	-	1152m
6	1	15M	99.2u	-	-	490m
7	1	18M	53.9u	-	-	1487m
8	1	19M	86.6u	-	-	1445m

Long Pulse Radar Test Signal						
Test Signal Name: LP_Signal_02						
Number of Bursts in Trial: 9						
Burst	Pulses per Burst	Chrip (Hz)	Pulse Width (s)	Pulse 1 to 2 Spacing (s)	Pulse 2 to 3 Spacing (s)	Start Location (s)
1	2	6M	98.6u	1.218m	0m	1282m
2	1	13M	60.1u	-	-	1200m
3	3	8M	78.7u	1.117m	1.805m	891m
4	3	9M	58.8u	1.748m	1.409m	30m
5	3	7M	53.4u	1.622m	1.219m	533m
6	1	13M	50.9u	-	-	227m
7	2	7M	94.1u	1.295m	-	391m
8	2	10M	50.9u	1.237m	-	1304m
9	2	8M	60.9u	1.126m	-	303m



A D T

Long Pulse Radar Test Signal
Test Signal Name: LP_Signal_03
Number of Bursts in Trial: 10

Burst	Pulses per Burst	Chrip (Hz)	Pulse Width (s)	Pulse 1 to 2 Spacing (s)	Pulse 2 to 3 Spacing (s)	Start Location (s)
1	3	9M	79.8u	1.491m	1.415m	848m
2	3	9M	60.9u	1.101m	0.958m	173m
3	1	7M	56.6u	-	-	499m
4	2	18M	78.1u	1.616m	-	254m
5	3	10M	57.8u	1.325m	1.941m	575m
6	2	10M	64.1u	1.276m	-	835m
7	3	14M	79.3u	1.616m	1.29m	456m
8	2	9M	54.4u	1.865m	-	997m
9	2	19M	57.8u	1.048m	-	827m
10	2	18M	99.7u	1.511m	-	660m

Long Pulse Radar Test Signal
Test Signal Name: LP_Signal_04
Number of Bursts in Trial: 11

Burst	Pulses per Burst	Chrip (Hz)	Pulse Width (s)	Pulse 1 to 2 Spacing (s)	Pulse 2 to 3 Spacing (s)	Start Location (s)
1	1	18M	59.2u	-	-	783m
2	3	8M	67.3u	0.961m	1.467m	695m
3	1	15M	83.5u	-	-	789m
4	3	14M	92.4u	1.868m	1.569m	399m
5	2	7M	76.3u	0.983m	-	429m
6	2	6M	80.3u	1.181m	-	636m
7	2	15M	85.4u	1.562m	-	1049m
8	1	18M	66.4u	-	-	889m
9	1	6M	91.8u	-	-	268m
10	1	13M	62.3u	-	-	717m
11	1	8M	69u	-	-	991m



A D T

Long Pulse Radar Test Signal						
Test Signal Name: LP_Signal_05						
Number of Bursts in Trial: 12						
Burst	Pulses per Burst	Chrip (Hz)	Pulse Width (s)	Pulse 1 to 2 Spacing (s)	Pulse 2 to 3 Spacing (s)	Start Location (s)
1	3	13M	76.1u	1.832m	1.139m	88m
2	1	19M	97.7u	-	-	528m
3	2	12M	82.8u	1.12m	-	748m
4	1	8M	78.5u	0m	-	783m
5	2	13M	97.4u	1.068m	-	328m
6	1	5M	76.8u	-	-	692m
7	1	7M	62.8u	-	-	102m
8	1	8M	97.4u	-	-	133m
9	2	13M	65.1u	1.255m	-	419m
10	1	8M	79u	-	-	849m
11	2	8M	51.8u	1.108m	-	169m
12	2	14M	52u	1.921m	-	89m

Long Pulse Radar Test Signal						
Test Signal Name: LP_Signal_06						
Number of Bursts in Trial: 13						
Burst	Pulses per Burst	Chrip (Hz)	Pulse Width (s)	Pulse 1 to 2 Spacing (s)	Pulse 2 to 3 Spacing (s)	Start Location (s)
1	2	17M	81.2u	1.044m	-	294m
2	2	15M	51.3u	1.248m	-	175m
3	2	13M	54.4u	1.602m	-	58m
4	1	8M	71.6u	-	-	16m
5	1	9M	95.9u	-	-	320m
6	3	6M	77.5u	1.146m	1.279m	426m
7	1	18M	69u	-	-	137m
8	2	10M	58.5u	1.793m	-	607m
9	3	14M	59u	1.775m	1.878m	184m
10	1	5M	65.7u	-	-	900m
11	3	7M	57.1u	1.862m	1.413m	426m
12	2	14M	71.3u	1.159m	-	872m
13	3	17M	96.4u	1.476m	1.741m	144m



A D T

Long Pulse Radar Test Signal
Test Signal Name: LP_Signal_07
Number of Bursts in Trial: 14

Burst	Pulses per Burst	Chrip (Hz)	Pulse Width (s)	Pulse 1 to 2 Spacing (s)	Pulse 2 to 3 Spacing (s)	Start Location (s)
1	1	5M	57.3u	-	-	184m
2	2	15M	76.4u	1.04m	-	738m
3	3	6M	75.7u	1.584m	1.334m	326m
4	2	14M	68.1u	1.539m	-	61m
5	2	14M	77.9u	1.778m	-	325m
6	2	10M	60.6u	1.487m	-	80m
7	1	20M	88.6u	0m	-	679m
8	2	14M	75.4u	1.346m	-	1m
9	1	15M	97.4u	-	-	437m
10	2	20M	68u	1.875m	-	782m
11	2	14M	85.4u	1.34m	-	763m
12	1	9M	70.8u	-	-	281m
13	1	11M	63.8u	-	-	246m
14	3	15M	82.6u	1.232m	1.246m	420m

Long Pulse Radar Test Signal
Test Signal Name: LP_Signal_08
Number of Bursts in Trial: 15

Burst	Pulses per Burst	Chrip (Hz)	Pulse Width (s)	Pulse 1 to 2 Spacing (s)	Pulse 2 to 3 Spacing (s)	Start Location (s)
1	2	6M	95u	1.807m	-	236m
2	3	12M	67.5u	1.608m	1.188m	710m
3	1	15M	71.2u	-	-	419m
4	2	7M	61.9u	1.346m	-	254m
5	2	17M	55.6u	1.639m	-	414m
6	3	20M	91.8u	1.127m	1.006m	121m
7	3	20M	53.3u	1.52m	1.408m	315m
8	3	12M	77.6u	1.214m	1.679m	468m
9	2	13M	83.7u	1.122m	-	713m
10	2	9M	77.5u	1.368m	-	40m
11	1	12M	67.3u	-	-	266m
12	3	18M	60.1u	0.997m	1.337m	545m
13	1	15M	99.9u	-	-	650m
14	3	7M	66.7u	1.605m	1.737m	19m
15	1	7M	86.9u	-	-	396m



A D T

Long Pulse Radar Test Signal
Test Signal Name: LP_Signal_09
Number of Bursts in Trial: 16

Burst	Pulses per Burst	Chrip (Hz)	Pulse Width (s)	Pulse 1 to 2 Spacing (s)	Pulse 2 to 3 Spacing (s)	Start Location (s)
1	1	10M	95.4u	-	-	362m
2	3	9M	81.1u	1.052m	1.537m	421m
3	3	19M	96u	0.905m	0.947m	517m
4	2	11M	76.7u	1.755m	-	491m
5	1	8M	51.1u	-	-	383m
6	1	14M	60.8u	-	-	416m
7	1	5M	79.9u	-	-	222m
8	2	7M	56.9u	1.039m	-	168m
9	3	13M	78u	1.307m	1.36m	445m
10	1	11M	74.9u	-	-	136m
11	3	15M	55.5u	1.227m	1.147m	315m
12	3	9M	93.7u	1.425m	1.763m	477m
13	3	9M	61.6u	1.759m	1.525m	288m
14	3	19M	60.6u	1.247m	1.646m	364m
15	2	12M	73.5u	0.991m	-	554m
16	2	5M	57.4u	1.785m	-	695m



A D T

Long Pulse Radar Test Signal
Test Signal Name: LP_Signal_10
Number of Bursts in Trial: 17

Burst	Pulses per Burst	Chrip (Hz)	Pulse Width (s)	Pulse 1 to 2 Spacing (s)	Pulse 2 to 3 Spacing (s)	Start Location (s)
1	1	13M	54.6u	-	-	291m
2	2	5M	54.5u	1.615m	-	449m
3	1	5M	75.8u	-	-	36m
4	3	13M	50.8u	1.032m	0.954m	24m
5	1	19M	71.1u	-	-	581m
6	2	14M	66u	0.966m	-	512m
7	1	13M	91.1u	-	-	6m
8	2	17M	57.3u	1.699m	-	492m
9	3	19M	96.8u	1.86m	1.39m	596m
10	1	6M	87.5u	-	-	80m
11	1	11M	57.3u	-	-	86m
12	3	9M	100u	1.413m	1.044m	652m
13	2	12M	62.6u	1.364m	-	577m
14	2	18M	96.3u	1.097m	-	182m
15	3	20M	76.4u	1.45m	1.753m	509m
16	2	9M	99.8u	1.441m	-	157m
17	1	19M	60.3u	-	-	64m



A D T

Long Pulse Radar Test Signal
Test Signal Name: LP_Signal_11
Number of Bursts in Trial: 18

Burst	Pulses per Burst	Chrip (Hz)	Pulse Width (s)	Pulse 1 to 2 Spacing (s)	Pulse 2 to 3 Spacing (s)	Start Location (s)
1	2	13M	85.2u	1.705m	-	52m
2	2	13M	69.2u	1.21m	-	145m
3	2	13M	84.6u	1.253m	-	36m
4	2	20M	74.5u	1.415m	-	64m
5	2	9M	59.6u	1.074m	-	639m
6	3	17M	96.3u	1.34m	1.536m	335m
7	3	15M	67u	1.207m	1.428m	469m
8	2	8M	55.5u	1.414m	-	642m
9	3	19M	53.1u	1.451m	1.644m	487m
10	2	10M	52.7u	1.907m	-	9m
11	2	6M	85.2u	1.771m	-	35m
12	1	13M	50.1u	-	-	371m
13	2	12M	82.2u	1.578m	-	388m
14	3	11M	69.7u	1.294m	1.454m	201m
15	2	13M	50.1u	1.933m	-	10m
16	3	13M	86.7u	1.391m	1.228m	22m
17	2	10M	59.3u	1.561m	-	346m
18	2	11M	53.6u	1.471m	-	240m



A D T

Long Pulse Radar Test Signal
Test Signal Name: LP_Signal_12
Number of Bursts in Trial: 19

Burst	Pulses per Burst	Chrip (Hz)	Pulse Width (s)	Pulse 1 to 2 Spacing (s)	Pulse 2 to 3 Spacing (s)	Start Location (s)
1	3	14M	64.8u	1.875m	1.02m	249m
2	1	13M	66.1u	0m	0m	1m
3	3	13M	91.9u	1.095m	1.219m	332m
4	1	18M	67.9u	-	-	350m
5	1	8M	93.3u	-	-	40m
6	1	13M	77.5u	-	-	310m
7	1	6M	95.7u	-	-	326m
8	1	13M	77.7u	-	-	601m
9	2	5M	72.4u	0.973m	-	304m
10	1	13M	89.3u	-	-	389m
11	3	19M	53.4u	1.824m	1.439m	137m
12	3	13M	68.8u	1.496m	1.861m	267m
13	1	10M	69.4u	-	-	559m
14	2	17M	95.1u	1.84m	-	461m
15	2	14M	79.5u	1.302m	-	455m
16	1	13M	63.3u	-	-	214m
17	2	12M	66.5u	1.088m	-	71m
18	2	14M	61.9u	1.022m	-	519m
19	2	11M	57.3u	0.995m	-	619m



A D T

Long Pulse Radar Test Signal						
Test Signal Name: LP_Signal_13						
Number of Bursts in Trial: 20						
Burst	Pulses per Burst	Chrip (Hz)	Pulse Width (s)	Pulse 1 to 2 Spacing (s)	Pulse 2 to 3 Spacing (s)	Start Location (s)
1	1	13M	74.8u	0m	-	273m
2	2	5M	57.4u	1.139m	-	527m
3	1	19M	62.7u	-	-	413m
4	1	10M	95u	-	-	351m
5	1	6M	63.3u	-	-	141m
6	2	18M	58.5u	1.245m	-	65m
7	1	11M	96.6u	-	-	372m
8	1	5M	93.1u	-	-	160m
9	3	13M	66u	1.101m	1.28m	68m
10	2	6M	83.8u	1.019m	-	306m
11	2	10M	99.1u	1.148m	-	262m
12	2	6M	86.1u	1.704m	-	112m
13	1	15M	60.2u	-	-	19m
14	2	7M	93.5u	1.012m	-	102m
15	1	7M	68.3u	-	-	518m
16	3	13M	56.5u	1.182m	1.183m	154m
17	2	15M	52u	1.9m	-	157m
18	3	13M	55.6u	1.464m	1.407m	135m
19	2	13M	75.5u	1.058m	-	518m
20	2	17M	76.4u	1.769m	-	586m

Long Pulse Radar Test Signal						
Test Signal Name: LP_Signal_14						
Number of Bursts in Trial: 8						
Burst	Pulses per Burst	Chrip (Hz)	Pulse Width (s)	Pulse 1 to 2 Spacing (s)	Pulse 2 to 3 Spacing (s)	Start Location (s)
1	3	18M	87.1u	1.847m	1.188m	1057m
2	1	9M	92.6u	-	-	349m
3	2	11M	86.1u	1.4m	-	1242m
4	1	7M	78.1u	-	-	907m
5	2	14M	75.2u	1.578m	-	429m
6	1	10M	60.3u	-	-	320m
7	2	20M	68.3u	1.097m	-	724m
8	2	11M	91.7u	1.076m	-	1426m



A D T

Long Pulse Radar Test Signal
Test Signal Name: LP_Signal_15
Number of Bursts in Trial: 10

Burst	Pulses per Burst	Chrip (Hz)	Pulse Width (s)	Pulse 1 to 2 Spacing (s)	Pulse 2 to 3 Spacing (s)	Start Location (s)
1	3	19M	79.7u	1.401m	1.726m	1070m
2	2	8M	72.9u	1.152m	-	885m
3	2	14M	83.4u	1.81m	-	431m
4	1	13M	65.8u	-	-	542m
5	3	15M	59.9u	0.975m	1.34m	814m
6	2	11M	68.3u	1.039m	0m	785m
7	3	5M	59.5u	1.776m	1.442m	477m
8	1	19M	90.2u	-	-	297m
9	2	11M	57.1u	1.937m	-	849m
10	2	18M	90.3u	1.601m	-	163m

Long Pulse Radar Test Signal
Test Signal Name: LP_Signal_16
Number of Bursts in Trial: 12

Burst	Pulses per Burst	Chrip (Hz)	Pulse Width (s)	Pulse 1 to 2 Spacing (s)	Pulse 2 to 3 Spacing (s)	Start Location (s)
1	2	8M	70.7u	0.987m	-	456m
2	2	18M	55.7u	1.521m	-	905m
3	3	11M	55.3u	1.51m	1.132m	632m
4	2	13M	53.2u	1.216m	-	987m
5	3	8M	77.9u	1.431m	1.17m	22m
6	1	8M	53.9u	-	-	238m
7	2	14M	73.5u	1.735m	-	139m
8	3	6M	100u	1.625m	1.183m	807m
9	1	13M	75.3u	-	-	204m
10	3	19M	64.2u	1.658m	1.218m	313m
11	2	7M	75.1u	1.151m	-	977m
12	2	20M	54.3u	0.952m	-	771m



A D T

Long Pulse Radar Test Signal
 Test Signal Name: LP_Signal_17
 Number of Bursts in Trial: 14

Burst	Pulses per Burst	Chrip (Hz)	Pulse Width (s)	Pulse 1 to 2 Spacing (s)	Pulse 2 to 3 Spacing (s)	Start Location (s)
1	2	19M	90.2u	1.208m	-	447m
2	1	8M	70.5u	-	-	310m
3	1	7M	98.4u	-	-	390m
4	1	20M	77.1u	-	-	124m
5	3	7M	94.6u	0.954m	1.612m	548m
6	3	13M	77.5u	1.29m	1.731m	362m
7	3	10M	80.5u	1.179m	1.262m	211m
8	1	10M	55.8u	-	-	605m
9	1	13M	53u	-	-	121m
10	2	19M	83.7u	1.887m	-	278m
11	2	11M	98.7u	1.005m	-	650m
12	2	10M	58.8u	1.866m	-	279m
13	3	11M	64u	1.574m	1.623m	387m
14	2	20M	94.6u	1.516m	-	127m

Long Pulse Radar Test Signal
 Test Signal Name: LP_Signal_18
 Number of Bursts in Trial: 16

Burst	Pulses per Burst	Chrip (Hz)	Pulse Width (s)	Pulse 1 to 2 Spacing (s)	Pulse 2 to 3 Spacing (s)	Start Location (s)
1	3	12M	50u	1.449m	1.508m	116m
2	2	15M	80.7u	1.756m	-	726m
3	1	13M	73.6u	-	-	535m
4	1	7M	74.9u	-	-	427m
5	3	17M	50.2u	1.191m	1.117m	225m
6	1	8M	85.5u	-	-	152m
7	3	18M	92.4u	1.238m	1.624m	296m
8	3	19M	77.5u	1.184m	1.67m	192m
9	3	19M	81.5u	1.772m	1.179m	67m
10	1	5M	69.8u	-	-	94m
11	3	11M	70.4u	1.475m	1.415m	519m
12	2	20M	64.5u	1.548m	-	115m
13	1	14M	88.4u	-	-	134m
14	2	13M	71.9u	1.173m	-	378m
15	2	17M	89.9u	1.501m	-	390m
16	1	11M	93.1u	-	-	672m



A D T

Long Pulse Radar Test Signal
Test Signal Name: LP_Signal_19
Number of Bursts in Trial: 18

Burst	Pulses per Burst	Chrip (Hz)	Pulse Width (s)	Pulse 1 to 2 Spacing (s)	Pulse 2 to 3 Spacing (s)	Start Location (s)
1	2	7M	83.3u	1.027m	-	473m
2	2	8M	83.8u	1.235m	-	19m
3	2	13M	96.3u	1.074m	-	159m
4	1	9M	83.8u	-	-	367m
5	2	13M	89.4u	1.901m	-	47m
6	2	6M	57.5u	1.488m	-	485m
7	2	15M	70.9u	1.364m	-	296m
8	1	9M	73.9u	-	-	546m
9	2	13M	74.8u	1.409m	-	83m
10	2	8M	64.6u	1.457m	-	75m
11	3	11M	97.7u	1.79m	1.027m	258m
12	2	5M	64.5u	1.597m	-	336m
13	2	20M	71.6u	0.936m	-	342m
14	1	5M	69.9u	-	-	372m
15	2	5M	74.4u	1.229m	-	19m
16	2	13M	59.7u	1.818m	-	67m
17	3	15M	58.8u	1.553m	1.809m	567m
18	2	20M	97.3u	1.39m	-	381m



A D T

Long Pulse Radar Test Signal
 Test Signal Name: LP_Signal_20
 Number of Bursts in Trial: 20

Burst	Pulses per Burst	Chrip (Hz)	Pulse Width (s)	Pulse 1 to 2 Spacing (s)	Pulse 2 to 3 Spacing (s)	Start Location (s)
1	1	10M	56.6u	-	-	542m
2	1	6M	61.6u	-	-	384m
3	3	8M	97.5u	1.135m	1.695m	153m
4	2	6M	73.3u	1.349m	-	238m
5	1	9M	96.3u	-	-	532m
6	2	7M	98.4u	1.154m	-	580m
7	2	20M	82.1u	1.496m	-	537m
8	2	11M	99.2u	1.673m	-	504m
9	1	20M	92.8u	-	-	559m
10	1	13M	74.3u	-	-	323m
11	1	17M	73.7u	-	-	0m
12	2	10M	61.8u	1.481m	-	312m
13	1	17M	59.6u	-	-	344m
14	2	5M	97.3u	1.255m	-	203m
15	1	15M	77.1u	-	-	244m
16	3	12M	73.9u	1.406m	1.447m	391m
17	2	13M	83.5u	1.143m	-	401m
18	3	6M	86.7u	1.195m	-	512m
19	1	6M	93.1u	-	-	108m
20	1	15M	50.6u	-	-	135m

Long Pulse Radar Test Signal
 Test Signal Name: LP_Signal_21
 Number of Bursts in Trial: 9

Burst	Pulses per Burst	Chrip (Hz)	Pulse Width (s)	Pulse 1 to 2 Spacing (s)	Pulse 2 to 3 Spacing (s)	Start Location (s)
1	2	5M	76.8u	1.83m	-	63m
2	2	7M	85.5u	1.836m	-	474m
3	1	12M	52.4u	-	-	1319m
4	1	6M	70.1u	-	-	748m
5	2	13M	65.5u	1.558m	-	197m
6	3	19M	68.9u	1.742m	1.849m	634m
7	2	13M	75.4u	1.896m	-	563m
8	3	6M	55.9u	0.973m	1.273m	1047m
9	1	13M	59.2u	-	-	1277m



A D T

Long Pulse Radar Test Signal						
Test Signal Name: LP_Signal_22						
Number of Bursts in Trial: 11						
Burst	Pulses per Burst	Chrip (Hz)	Pulse Width (s)	Pulse 1 to 2 Spacing (s)	Pulse 2 to 3 Spacing (s)	Start Location (s)
1	3	17M	55.4u	1.013m	1.262m	59m
2	1	15M	85.5u	-	-	631m
3	2	20M	74.1u	1.853m	-	685m
4	1	14M	68.2u	-	-	677m
5	2	14M	87.3u	1.314m	-	567m
6	2	20M	65.9u	1.071m	-	448m
7	2	19M	93.2u	1.339m	-	602m
8	2	15M	99.3u	1.313m	-	133m
9	2	18M	65.9u	0.985m	-	1002m
10	1	13M	64.6u	-	-	343m
11	2	14M	57.6u	1.412m	-	96m

Long Pulse Radar Test Signal						
Test Signal Name: LP_Signal_23						
Number of Bursts in Trial: 13						
Burst	Pulses per Burst	Chrip (Hz)	Pulse Width (s)	Pulse 1 to 2 Spacing (s)	Pulse 2 to 3 Spacing (s)	Start Location (s)
1	2	15M	58.1u	1.75m	-	82m
2	3	9M	68.5u	1.552m	1.481m	119m
3	3	8M	94.1u	1.51m	1.493m	325m
4	3	19M	53.6u	1.027m	1.489m	677m
5	2	19M	60.8u	1.227m	-	897m
6	1	6M	64.6u	-	-	746m
7	1	12M	85.7u	-	-	783m
8	2	10M	52.1u	1.087m	-	283m
9	3	13M	82.9u	1.309m	1.865m	144m
10	2	17M	89u	1.62m	-	176m
11	2	10M	89.9u	1.489m	-	569m
12	2	5M	91.3u	1.561m	-	707m
13	2	11M	55.7u	1.237m	-	678m



A D T

Long Pulse Radar Test Signal
Test Signal Name: LP_Signal_24
Number of Bursts in Trial: 15

Burst	Pulses per Burst	Chrip (Hz)	Pulse Width (s)	Pulse 1 to 2 Spacing (s)	Pulse 2 to 3 Spacing (s)	Start Location (s)
1	2	20M	74.1u	0.941m	-	202m
2	1	7M	70.6u	-	-	666m
3	1	10M	52.4u	-	-	733m
4	3	8M	96.8u	1.497m	1.771m	575m
5	1	14M	70.1u	-	-	225m
6	2	10M	82.8u	1.612m	-	113m
7	2	18M	80.8u	1.03m	-	551m
8	3	6M	76.4u	0.958m	1.191m	206m
9	2	20M	74.7u	1.094m	-	639m
10	2	13M	74.7u	1.655m	-	564m
11	3	8M	58.5u	1.335m	1.439m	430m
12	2	11M	93.5u	1.454m	-	632m
13	2	10M	70.5u	1.169m	-	679m
14	1	5M	92.1u	-	-	708m
15	1	13M	72.6u	-	-	548m



A D T

Long Pulse Radar Test Signal
Test Signal Name: LP_Signal_25
Number of Bursts in Trial: 15

Burst	Pulses per Burst	Chrip (Hz)	Pulse Width (s)	Pulse 1 to 2 Spacing (s)	Pulse 2 to 3 Spacing (s)	Start Location (s)
1	1	18M	59.8u	-	-	315m
2	1	12M	53.6u	-	-	685m
3	3	18M	78.7u	0.931m	1.083m	714m
4	2	10M	66.2u	1.173m	-	285m
5	2	8M	56.1u	1.552m	-	641m
6	3	9M	87.6u	1.221m	1.291m	411m
7	2	12M	67.7u	1.808m	-	43m
8	1	19M	63.3u	-	-	732m
9	2	15M	99.9u	1.764m	-	11m
10	3	20M	78.6u	0.934m	1.324m	203m
11	2	15M	69.8u	1.276m	-	537m
12	2	7M	68u	0.958m	-	657m
13	2	13M	70.8u	1.76m	-	317m
14	2	19M	78.7u	1.441m	-	460m
15	2	13M	92.5u	1.189m	-	570m
16	2	6M	57.3u	1.275m	-	195m



A D T

Long Pulse Radar Test Signal
Test Signal Name: LP_Signal_26
Number of Bursts in Trial: 17

Burst	Pulses per Burst	Chrip (Hz)	Pulse Width (s)	Pulse 1 to 2 Spacing (s)	Pulse 2 to 3 Spacing (s)	Start Location (s)
1	2	13M	87u	0.939m	-	384m
2	1	17M	67.7u	-	-	144m
3	2	8M	63.7u	1.328m	-	246m
4	2	5M	86u	1.437m	-	676m
5	2	11M	86.2u	0.953m	-	277m
6	1	13M	73.1u	-	-	389m
7	3	7M	61.2u	1.536m	1.434m	549m
8	1	13M	98.6u	-	-	352m
9	2	10M	90.8u	1.273m	-	229m
10	2	12M	70.6u	1.466m	-	43m
11	2	8M	53.7u	1.485m	-	296m
12	3	13M	51.4u	1.554m	1.9m	657m
13	2	14M	75.2u	1.505m	-	339m
14	1	19M	71.6u	-	-	413m
15	1	10M	94.8u	-	-	436m
16	1	20M	91.4u	-	-	400m
17	2	20M	80.2u	1.244m	-	385m



A D T

Long Pulse Radar Test Signal
Test Signal Name: LP_Signal_27
Number of Bursts in Trial: 18

Burst	Pulses per Burst	Chrip (Hz)	Pulse Width (s)	Pulse 1 to 2 Spacing (s)	Pulse 2 to 3 Spacing (s)	Start Location (s)
1	3	12M	80.9u	1.883m	1.573m	53m
2	3	15M	94.1u	1.682m	1.577m	101m
3	2	5M	96.4u	1.442m	-	40m
4	2	8M	96.6u	1.552m	-	173m
5	2	7M	90.1u	1.038m	-	597m
6	3	20M	78.7u	1.911m	1.856m	612m
7	1	12M	81.1u	-	-	610m
8	2	11M	66.1u	1.693m	-	67m
9	2	6M	85.8u	1.827m	-	193m
10	2	14M	50.7u	1.124m	-	107m
11	1	5M	85.3u	-	-	565m
12	3	5M	75u	1.169m	1.563m	128m
13	2	18M	58.4u	1.869m	-	53m
14	3	20M	66.5u	1.476m	1.54m	487m
15	2	15M	96.5u	1.597m	-	537m
16	1	14M	81.1u	-	-	612m
17	1	19M	98.7u	-	-	435m
18	1	20M	51.8u	-	-	628m



A D T

Long Pulse Radar Test Signal
Test Signal Name: LP_Signal_28
Number of Bursts in Trial: 19

Burst	Pulses per Burst	Chrip (Hz)	Pulse Width (s)	Pulse 1 to 2 Spacing (s)	Pulse 2 to 3 Spacing (s)	Start Location (s)
1	2	18M	56.2u	1.863m	-	511m
2	2	6M	64.4u	1.234m	-	620m
3	1	10M	83.3u	-	-	613m
4	1	9M	99.3u	-	-	476m
5	2	20M	80.1u	1.615m	-	584m
6	2	13M	82u	0.971m	-	467m
7	2	10M	79.6u	0.949m	-	430m
8	2	13M	69.5u	1.26m	-	357m
10	3	20M	92u	1.801m	0.995m	165m
11	2	9M	97.1u	1.74m	-	456m
12	2	8M	98.9u	1.427m	-	17m
13	3	18M	77.9u	1.797m	1.319m	269m
14	1	18M	90.4u	-	-	203m
15	3	5M	90u	1.897m	1.544m	295m
16	2	15M	67.1u	1.31m	-	554m
17	3	10M	71.9u	1.63m	1.633m	66m
18	3	18M	61.1u	1.256m	1.263m	573m
19	2	13M	95.9u	1.803m	-	215m



A D T

Long Pulse Radar Test Signal
Test Signal Name: LP_Signal_29
Number of Bursts in Trial: 20

Burst	Pulses per Burst	Chrip (Hz)	Pulse Width (s)	Pulse 1 to 2 Spacing (s)	Pulse 2 to 3 Spacing (s)	Start Location (s)
1	3	13M	54.7u	0.986m	1.475m	121m
2	1	14M	91.8u	-	-	109m
3	3	6M	72.8u	1.282m	1.174m	476m
4	2	13M	79.2u	1.821m	-	425m
5	3	10M	52.3u	1.232m	1.89m	225m
6	1	20M	70u	-	-	222m
7	2	19M	55.9u	1.901m	-	452m
8	3	13M	83.7u	1.2m	1.221m	152m
9	1	13M	83.4u	-	-	397m
10	3	18M	67u	1.698m	1.315m	142m
11	3	14M	65.1u	1.5m	1.212m	272m
12	1	11M	54.1u	-	-	570m
13	1	11M	73.2u	-	-	12m
14	2	14M	73.1u	1.336m	-	149m
15	2	8M	75.3u	1.18m	-	103m
16	2	20M	50.3u	1.197m	-	183m
17	2	13M	81.3u	0.969m	-	368m
18	1	20M	97.9u	-	-	332m
19	2	14M	91.2u	1.048m	-	57m
20	2	12M	62.1u	1.604m	-	89m



A D T

Long Pulse Radar Test Signal
Test Signal Name: LP_Signal_30
Number of Bursts in Trial: 11

Burst	Pulses per Burst	Chrip (Hz)	Pulse Width (s)	Pulse 1 to 2 Spacing (s)	Pulse 2 to 3 Spacing (s)	Start Location (s)
1	1	13M	74.4u	-	-	277m
2	2	12M	84.2u	1.131m	-	832m
3	2	11M	55.9u	1.24m	-	790m
4	1	11M	64.7u	-	-	190m
5	2	13M	60.4u	0.949m	-	519m
6	2	9M	66u	1.046m	-	375m
7	2	5M	63.8u	1.721m	-	240m
8	1	10M	87.3u	-	-	583m
9	2	14M	97.6u	1.473m	-	548m
10	1	17M	99u	-	-	896m
11	1	12M	65.5u	-	-	246m
12	1	10M	57.5u	-	-	464m
13	2	12M	88.2u	1.403m	-	878m



A D T

Hopping Frequency Sequence Name: HOP_FREQ_SEQ_01

SEQ#	Frequency (Hz)	SEQ#	Frequency (Hz)	SEQ#	Frequency (Hz)	SEQ#	Frequency (Hz)
1	5.644G	2	5.606G	3	5.613G	4	5.652G
5	5.614G	6	5.587G	7	5.591G	8	5.664G
9	5.449G	10	5.288G	11	5.501G	12	5.327G
13	5.458G	14	5.323G	15	5.315G	16	5.375G
17	5.256G	18	5.662G	19	5.389G	20	5.630G
21	5.477G	22	5.474G	23	5.523G	24	5.420G
25	5.277G	26	5.553G	27	5.427G	28	5.302G
29	5.642G	30	5.251G	31	5.611G	32	5.410G
33	5.439G	34	5.491G	35	5.397G	36	5.295G
37	5.402G	38	5.568G	39	5.536G	40	5.685G
41	5.678G	42	5.326G	43	5.309G	44	5.510G
45	5.486G	46	5.365G	47	5.450G	48	5.285G
49	5.257G	50	5.371G	51	5.668G	52	5.473G
53	5.634G	54	5.658G	55	5.681G	56	5.287G
57	5.711G	58	5.503G	59	5.452G	60	5.496G
61	5.595G	62	5.274G	63	5.325G	64	5.519G
65	5.338G	66	5.412G	67	5.352G	68	5.647G
69	5.705G	70	5.262G	71	5.554G	72	5.341G
73	5.290G	74	5.381G	75	5.625G	76	5.329G
77	5.603G	78	5.317G	79	5.666G	80	5.314G
81	5.476G	82	5.319G	83	5.385G	84	5.561G
85	5.268G	86	5.298G	87	5.672G	88	5.388G
89	5.331G	90	5.350G	91	5.322G	92	5.455G
93	5.631G	94	5.456G	95	5.708G	96	5.548G
97	5.407G	98	5.332G	99	5.471G	100	5.294G



A D T

Hopping Frequency Sequence Name: HOP_FREQ_SEQ_02

SEQ#	Frequency (Hz)	SEQ#	Frequency (Hz)	SEQ#	Frequency (Hz)	SEQ#	Frequency (Hz)
1	5.515G	2	5.542G	3	5.379G	4	5.647G
5	5.587G	6	5.263G	7	5.469G	8	5.317G
9	5.609G	10	5.385G	11	5.303G	12	5.630G
13	5.606G	14	5.402G	15	5.451G	16	5.510G
17	5.605G	18	5.487G	19	5.582G	20	5.304G
21	5.288G	22	5.636G	23	5.700G	24	5.395G
25	5.624G	26	5.439G	27	5.610G	28	5.571G
29	5.500G	30	5.503G	31	5.559G	32	5.532G
33	5.579G	34	5.631G	35	5.396G	36	5.604G
37	5.583G	38	5.634G	39	5.285G	40	5.294G
41	5.652G	42	5.438G	43	5.589G	44	5.381G
45	5.262G	46	5.709G	47	5.387G	48	5.261G
49	5.615G	50	5.270G	51	5.704G	52	5.554G
53	5.352G	54	5.688G	55	5.295G	56	5.657G
57	5.428G	58	5.300G	59	5.292G	60	5.569G
61	5.324G	62	5.702G	63	5.390G	64	5.564G
65	5.266G	66	5.674G	67	5.680G	68	5.454G
69	5.341G	70	5.373G	71	5.348G	72	5.409G
73	5.432G	74	5.457G	75	5.573G	76	5.715G
77	5.664G	78	5.535G	79	5.653G	80	5.346G
81	5.540G	82	5.599G	83	5.638G	84	5.689G
85	5.544G	86	5.567G	87	5.628G	88	5.685G
89	5.718G	90	5.412G	91	5.449G	92	5.533G
93	5.401G	94	5.371G	95	5.264G	96	5.260G
97	5.530G	98	5.370G	99	5.458G	100	5.531G



A D T

Hopping Frequency Sequence Name: HOP_FREQ_SEQ_03

SEQ#	Frequency (Hz)	SEQ#	Frequency (Hz)	SEQ#	Frequency (Hz)	SEQ#	Frequency (Hz)
1	5.554G	2	5.487G	3	5.465G	4	5.390G
5	5.471G	6	5.555G	7	5.349G	8	5.341G
9	5.433G	10	5.629G	11	5.339G	12	5.395G
13	5.442G	14	5.266G	15	5.391G	16	5.269G
17	5.301G	18	5.511G	19	5.384G	20	5.637G
21	5.376G	22	5.389G	23	5.531G	24	5.601G
25	5.437G	26	5.696G	27	5.642G	28	5.552G
29	5.481G	30	5.512G	31	5.659G	32	5.595G
33	5.287G	34	5.259G	35	5.271G	36	5.663G
37	5.460G	38	5.316G	39	5.310G	40	5.365G
41	5.523G	42	5.399G	43	5.568G	44	5.565G
45	5.408G	46	5.598G	47	5.600G	48	5.463G
49	5.283G	50	5.567G	51	5.574G	52	5.358G
53	5.650G	54	5.711G	55	5.416G	56	5.291G
57	5.457G	58	5.682G	59	5.353G	60	5.331G
61	5.615G	62	5.692G	63	5.270G	64	5.676G
65	5.551G	66	5.651G	67	5.371G	68	5.397G
69	5.323G	70	5.453G	71	5.559G	72	5.516G
73	5.613G	74	5.355G	75	5.467G	76	5.529G
77	5.661G	78	5.444G	79	5.265G	80	5.667G
81	5.721G	82	5.528G	83	5.627G	84	5.326G
85	5.375G	86	5.401G	87	5.298G	88	5.592G
89	5.541G	90	5.403G	91	5.363G	92	5.616G
93	5.633G	94	5.385G	95	5.643G	96	5.312G
97	5.497G	98	5.434G	99	5.332G	100	5.372G



A D T

Hopping Frequency Sequence Name: HOP_FREQ_SEQ_04

SEQ#	Frequency (Hz)	SEQ#	Frequency (Hz)	SEQ#	Frequency (Hz)	SEQ#	Frequency (Hz)
1	5.378G	2	5.615G	3	5.335G	4	5.624G
5	5.644G	6	5.371G	7	5.670G	8	5.420G
9	5.461G	10	5.488G	11	5.600G	12	5.534G
13	5.347G	14	5.611G	15	5.275G	16	5.672G
17	5.631G	18	5.279G	19	5.582G	20	5.281G
21	5.302G	22	5.614G	23	5.540G	24	5.379G
25	5.276G	26	5.393G	27	5.294G	28	5.712G
29	5.723G	30	5.586G	31	5.303G	32	5.438G
33	5.563G	34	5.637G	35	5.405G	36	5.520G
37	5.667G	38	5.657G	39	5.418G	40	5.436G
41	5.636G	42	5.352G	43	5.616G	44	5.267G
45	5.687G	46	5.559G	47	5.460G	48	5.499G
49	5.663G	50	5.609G	51	5.295G	52	5.290G
53	5.565G	54	5.260G	55	5.634G	56	5.272G
57	5.304G	58	5.567G	59	5.478G	60	5.388G
61	5.472G	62	5.376G	63	5.601G	64	5.332G
65	5.452G	66	5.669G	67	5.312G	68	5.359G
69	5.480G	70	5.501G	71	5.608G	72	5.363G
73	5.702G	74	5.623G	75	5.626G	76	5.557G
77	5.251G	78	5.553G	79	5.724G	80	5.585G
81	5.423G	82	5.673G	83	5.529G	84	5.296G
85	5.581G	86	5.593G	87	5.689G	88	5.482G
89	5.402G	90	5.377G	91	5.464G	92	5.314G
93	5.430G	94	5.341G	95	5.398G	96	5.630G
97	5.447G	98	5.479G	99	5.612G	100	5.532G



A D T

Hopping Frequency Sequence Name: HOP_FREQ_SEQ_05

SEQ#	Frequency (Hz)	SEQ#	Frequency (Hz)	SEQ#	Frequency (Hz)	SEQ#	Frequency (Hz)
1	5.331G	2	5.438G	3	5.578G	4	5.610G
5	5.401G	6	5.643G	7	5.339G	8	5.649G
9	5.679G	10	5.464G	11	5.337G	12	5.504G
13	5.461G	14	5.332G	15	5.519G	16	5.648G
17	5.321G	18	5.377G	19	5.287G	20	5.397G
21	5.575G	22	5.328G	23	5.687G	24	5.552G
25	5.592G	26	5.548G	27	5.535G	28	5.301G
29	5.629G	30	5.564G	31	5.686G	32	5.482G
33	5.360G	34	5.476G	35	5.500G	36	5.608G
37	5.650G	38	5.458G	39	5.594G	40	5.251G
41	5.344G	42	5.334G	43	5.451G	44	5.704G
45	5.356G	46	5.405G	47	5.690G	48	5.657G
49	5.695G	50	5.396G	51	5.342G	52	5.265G
53	5.585G	54	5.672G	55	5.580G	56	5.442G
57	5.560G	58	5.435G	59	5.335G	60	5.273G
61	5.710G	62	5.512G	63	5.264G	64	5.538G
65	5.570G	66	5.601G	67	5.618G	68	5.474G
69	5.693G	70	5.325G	71	5.465G	72	5.306G
73	5.347G	74	5.691G	75	5.662G	76	5.409G
77	5.700G	78	5.539G	79	5.348G	80	5.448G
81	5.338G	82	5.268G	83	5.350G	84	5.557G
85	5.681G	86	5.485G	87	5.503G	88	5.518G
89	5.692G	90	5.613G	91	5.270G	92	5.511G
93	5.545G	94	5.297G	95	5.510G	96	5.371G
97	5.667G	98	5.547G	99	5.637G	100	5.524G



A D T

Hopping Frequency Sequence Name: HOP_FREQ_SEQ_06

SEQ#	Frequency (Hz)	SEQ#	Frequency (Hz)	SEQ#	Frequency (Hz)	SEQ#	Frequency (Hz)
1	5.299G	2	5.662G	3	5.279G	4	5.598G
5	5.537G	6	5.519G	7	5.386G	8	5.670G
9	5.380G	10	5.388G	11	5.651G	12	5.456G
13	5.409G	14	5.330G	15	5.333G	16	5.560G
17	5.700G	18	5.469G	19	5.718G	20	5.410G
21	5.259G	22	5.431G	23	5.339G	24	5.313G
25	5.567G	26	5.483G	27	5.428G	28	5.363G
29	5.680G	30	5.480G	31	5.298G	32	5.701G
33	5.698G	34	5.506G	35	5.317G	36	5.566G
37	5.526G	38	5.510G	39	5.324G	40	5.292G
41	5.498G	42	5.658G	43	5.633G	44	5.638G
45	5.572G	46	5.580G	47	5.357G	48	5.302G
49	5.591G	50	5.520G	51	5.418G	52	5.689G
53	5.281G	54	5.544G	55	5.252G	56	5.322G
57	5.476G	58	5.405G	59	5.479G	60	5.668G
61	5.535G	62	5.641G	63	5.397G	64	5.627G
65	5.375G	66	5.597G	67	5.723G	68	5.678G
69	5.600G	70	5.503G	71	5.590G	72	5.715G
73	5.353G	74	5.509G	75	5.681G	76	5.604G
77	5.554G	78	5.387G	79	5.500G	80	5.533G
81	5.648G	82	5.329G	83	5.512G	84	5.414G
85	5.286G	86	5.461G	87	5.559G	88	5.288G
89	5.295G	90	5.643G	91	5.427G	92	5.639G
93	5.278G	94	5.620G	95	5.684G	96	5.398G
97	5.542G	98	5.577G	99	5.709G	100	5.381G



A D T

Hopping Frequency Sequence Name: HOP_FREQ_SEQ_07

SEQ#	Frequency (Hz)	SEQ#	Frequency (Hz)	SEQ#	Frequency (Hz)	SEQ#	Frequency (Hz)
1	5.439G	2	5.472G	3	5.348G	4	5.618G
5	5.536G	6	5.525G	7	5.364G	8	5.336G
9	5.350G	10	5.278G	11	5.253G	12	5.266G
13	5.706G	14	5.633G	15	5.524G	16	5.496G
17	5.436G	18	5.631G	19	5.495G	20	5.483G
21	5.434G	22	5.427G	23	5.292G	24	5.347G
25	5.357G	26	5.319G	27	5.693G	28	5.328G
29	5.466G	30	5.658G	31	5.355G	32	5.558G
33	5.648G	34	5.506G	35	5.556G	36	5.683G
37	5.697G	38	5.368G	39	5.378G	40	5.263G
41	5.324G	42	5.402G	43	5.284G	44	5.672G
45	5.316G	46	5.295G	47	5.687G	48	5.304G
49	5.588G	50	5.274G	51	5.600G	52	5.442G
53	5.532G	54	5.623G	55	5.327G	56	5.641G
57	5.363G	58	5.538G	59	5.371G	60	5.509G
61	5.391G	62	5.579G	63	5.460G	64	5.441G
65	5.258G	66	5.611G	67	5.367G	68	5.333G
69	5.251G	70	5.487G	71	5.640G	72	5.691G
73	5.409G	74	5.438G	75	5.392G	76	5.612G
77	5.530G	78	5.652G	79	5.644G	80	5.548G
81	5.280G	82	5.424G	83	5.521G	84	5.594G
85	5.546G	86	5.534G	87	5.685G	88	5.390G
89	5.709G	90	5.275G	91	5.335G	92	5.662G
93	5.320G	94	5.281G	95	5.312G	96	5.676G
97	5.360G	98	5.616G	99	5.568G	100	5.332G



A D T

Hopping Frequency Sequence Name: HOP_FREQ_SEQ_08

SEQ#	Frequency (Hz)	SEQ#	Frequency (Hz)	SEQ#	Frequency (Hz)	SEQ#	Frequency (Hz)
1	5.550G	2	5.390G	3	5.719G	4	5.646G
5	5.588G	6	5.338G	7	5.596G	8	5.549G
9	5.706G	10	5.628G	11	5.521G	12	5.503G
13	5.383G	14	5.472G	15	5.264G	16	5.631G
17	5.625G	18	5.513G	19	5.558G	20	5.599G
21	5.424G	22	5.315G	23	5.702G	24	5.354G
25	5.324G	26	5.720G	27	5.446G	28	5.284G
29	5.488G	30	5.572G	31	5.613G	32	5.369G
33	5.401G	34	5.590G	35	5.531G	36	5.313G
37	5.373G	38	5.651G	39	5.535G	40	5.504G
41	5.615G	42	5.335G	43	5.381G	44	5.695G
45	5.686G	46	5.317G	47	5.693G	48	5.411G
49	5.667G	50	5.672G	51	5.420G	52	5.544G
53	5.459G	54	5.517G	55	5.700G	56	5.668G
57	5.666G	58	5.376G	59	5.582G	60	5.568G
61	5.458G	62	5.416G	63	5.485G	64	5.536G
65	5.421G	66	5.622G	67	5.724G	68	5.664G
69	5.292G	70	5.694G	71	5.413G	72	5.461G
73	5.692G	74	5.282G	75	5.592G	76	5.635G
77	5.630G	78	5.362G	79	5.548G	80	5.495G
81	5.654G	82	5.542G	83	5.476G	84	5.326G
85	5.518G	86	5.453G	87	5.711G	88	5.448G
89	5.410G	90	5.261G	91	5.368G	92	5.649G
93	5.333G	94	5.345G	95	5.270G	96	5.678G
97	5.340G	98	5.594G	99	5.565G	100	5.291G



A D T

Hopping Frequency Sequence Name: HOP_FREQ_SEQ_09

SEQ#	Frequency (Hz)	SEQ#	Frequency (Hz)	SEQ#	Frequency (Hz)	SEQ#	Frequency (Hz)
1	5.482G	2	5.469G	3	5.570G	4	5.476G
5	5.716G	6	5.464G	7	5.361G	8	5.551G
9	5.368G	10	5.708G	11	5.592G	12	5.594G
13	5.398G	14	5.683G	15	5.355G	16	5.473G
17	5.326G	18	5.624G	19	5.513G	20	5.393G
21	5.560G	22	5.515G	23	5.339G	24	5.447G
25	5.395G	26	5.385G	27	5.269G	28	5.419G
29	5.640G	30	5.431G	31	5.693G	32	5.455G
33	5.306G	34	5.386G	35	5.510G	36	5.565G
37	5.424G	38	5.631G	39	5.373G	40	5.350G
41	5.294G	42	5.620G	43	5.664G	44	5.540G
45	5.604G	46	5.602G	47	5.275G	48	5.460G
49	5.615G	50	5.541G	51	5.526G	52	5.273G
53	5.636G	54	5.418G	55	5.512G	56	5.650G
57	5.523G	58	5.670G	59	5.383G	60	5.282G
61	5.583G	62	5.619G	63	5.550G	64	5.384G
65	5.659G	66	5.365G	67	5.586G	68	5.528G
69	5.718G	70	5.388G	71	5.711G	72	5.441G
73	5.430G	74	5.676G	75	5.332G	76	5.707G
77	5.446G	78	5.713G	79	5.639G	80	5.584G
81	5.366G	82	5.257G	83	5.525G	84	5.440G
85	5.556G	86	5.607G	87	5.688G	88	5.704G
89	5.414G	90	5.276G	91	5.675G	92	5.256G
93	5.502G	94	5.491G	95	5.348G	96	5.375G
97	5.495G	98	5.390G	99	5.303G	100	5.319G



A D T

Hopping Frequency Sequence Name: HOP_FREQ_SEQ_10

SEQ#	Frequency (Hz)	SEQ#	Frequency (Hz)	SEQ#	Frequency (Hz)	SEQ#	Frequency (Hz)
1	5.412G	2	5.304G	3	5.530G	4	5.533G
5	5.575G	6	5.560G	7	5.499G	8	5.553G
9	5.651G	10	5.615G	11	5.334G	12	5.500G
13	5.685G	14	5.586G	15	5.406G	16	5.434G
17	5.339G	18	5.644G	19	5.314G	20	5.490G
21	5.525G	22	5.724G	23	5.588G	24	5.562G
25	5.710G	26	5.557G	27	5.723G	28	5.463G
29	5.413G	30	5.443G	31	5.717G	32	5.628G
33	5.457G	34	5.283G	35	5.254G	36	5.714G
37	5.261G	38	5.589G	39	5.252G	40	5.346G
41	5.336G	42	5.716G	43	5.257G	44	5.402G
45	5.559G	46	5.646G	47	5.719G	48	5.693G
49	5.423G	50	5.700G	51	5.601G	52	5.539G
53	5.585G	54	5.473G	55	5.479G	56	5.271G
57	5.265G	58	5.411G	59	5.389G	60	5.498G
61	5.272G	62	5.619G	63	5.424G	64	5.268G
65	5.622G	66	5.527G	67	5.554G	68	5.594G
69	5.603G	70	5.421G	71	5.683G	72	5.355G
73	5.307G	74	5.676G	75	5.616G	76	5.491G
77	5.258G	78	5.581G	79	5.407G	80	5.367G
81	5.250G	82	5.415G	83	5.659G	84	5.548G
85	5.432G	86	5.516G	87	5.460G	88	5.570G
89	5.695G	90	5.362G	91	5.613G	92	5.623G
93	5.366G	94	5.263G	95	5.656G	96	5.377G
97	5.722G	98	5.627G	99	5.453G	100	5.275G



A D T

Hopping Frequency Sequence Name: HOP_FREQ_SEQ_11

SEQ#	Frequency (Hz)	SEQ#	Frequency (Hz)	SEQ#	Frequency (Hz)	SEQ#	Frequency (Hz)
1	5.642G	2	5.396G	3	5.409G	4	5.265G
5	5.632G	6	5.317G	7	5.387G	8	5.670G
9	5.411G	10	5.597G	11	5.267G	12	5.546G
13	5.560G	14	5.694G	15	5.568G	16	5.415G
17	5.650G	18	5.645G	19	5.268G	20	5.709G
21	5.327G	22	5.695G	23	5.393G	24	5.356G
25	5.256G	26	5.444G	27	5.290G	28	5.515G
29	5.407G	30	5.358G	31	5.395G	32	5.721G
33	5.250G	34	5.410G	35	5.583G	36	5.697G
37	5.682G	38	5.379G	39	5.455G	40	5.578G
41	5.707G	42	5.676G	43	5.329G	44	5.604G
45	5.438G	46	5.287G	47	5.254G	48	5.289G
49	5.281G	50	5.470G	51	5.554G	52	5.599G
53	5.559G	54	5.347G	55	5.484G	56	5.630G
57	5.328G	58	5.563G	59	5.363G	60	5.333G
61	5.408G	62	5.702G	63	5.294G	64	5.664G
65	5.276G	66	5.648G	67	5.338G	68	5.712G
69	5.629G	70	5.549G	71	5.286G	72	5.258G
73	5.660G	74	5.443G	75	5.616G	76	5.691G
77	5.579G	78	5.305G	79	5.466G	80	5.401G
81	5.391G	82	5.669G	83	5.339G	84	5.440G
85	5.550G	86	5.598G	87	5.360G	88	5.362G
89	5.503G	90	5.433G	91	5.459G	92	5.375G
93	5.713G	94	5.679G	95	5.532G	96	5.394G
97	5.412G	98	5.586G	99	5.404G	100	5.639G



A D T

Hopping Frequency Sequence Name: HOP_FREQ_SEQ_12

SEQ#	Frequency (Hz)	SEQ#	Frequency (Hz)	SEQ#	Frequency (Hz)	SEQ#	Frequency (Hz)
1	5.485G	2	5.667G	3	5.358G	4	5.569G
5	5.612G	6	5.560G	7	5.509G	8	5.716G
9	5.543G	10	5.326G	11	5.450G	12	5.709G
13	5.302G	14	5.523G	15	5.435G	16	5.303G
17	5.378G	18	5.306G	19	5.721G	20	5.657G
21	5.470G	22	5.289G	23	5.407G	24	5.540G
25	5.714G	26	5.333G	27	5.353G	28	5.596G
29	5.562G	30	5.471G	31	5.475G	32	5.718G
33	5.385G	34	5.258G	35	5.381G	36	5.421G
37	5.600G	38	5.400G	39	5.627G	40	5.576G
41	5.628G	42	5.257G	43	5.547G	44	5.553G
45	5.412G	46	5.678G	47	5.423G	48	5.701G
49	5.632G	50	5.719G	51	5.559G	52	5.389G
53	5.516G	54	5.439G	55	5.319G	56	5.371G
57	5.489G	58	5.707G	59	5.643G	60	5.324G
61	5.582G	62	5.360G	63	5.608G	64	5.398G
65	5.646G	66	5.256G	67	5.614G	68	5.606G
69	5.588G	70	5.528G	71	5.654G	72	5.441G
73	5.607G	74	5.537G	75	5.465G	76	5.573G
77	5.297G	78	5.635G	79	5.376G	80	5.655G
81	5.473G	82	5.309G	83	5.300G	84	5.392G
85	5.323G	86	5.272G	87	5.432G	88	5.336G
89	5.357G	90	5.365G	91	5.495G	92	5.344G
93	5.517G	94	5.529G	95	5.416G	96	5.488G
97	5.330G	98	5.425G	99	5.698G	100	5.702G



A D T

Hopping Frequency Sequence Name: HOP_FREQ_SEQ_13

SEQ#	Frequency (Hz)	SEQ#	Frequency (Hz)	SEQ#	Frequency (Hz)	SEQ#	Frequency (Hz)
1	5.554G	2	5.339G	3	5.473G	4	5.716G
5	5.354G	6	5.420G	7	5.475G	8	5.371G
9	5.293G	10	5.514G	11	5.681G	12	5.694G
13	5.400G	14	5.600G	15	5.485G	16	5.422G
17	5.701G	18	5.430G	19	5.484G	20	5.525G
21	5.335G	22	5.633G	23	5.382G	24	5.334G
25	5.709G	26	5.601G	27	5.405G	28	5.496G
29	5.577G	30	5.642G	31	5.536G	32	5.678G
33	5.640G	34	5.280G	35	5.440G	36	5.486G
37	5.307G	38	5.450G	39	5.361G	40	5.381G
41	5.670G	42	5.444G	43	5.513G	44	5.629G
45	5.671G	46	5.596G	47	5.490G	48	5.713G
49	5.661G	50	5.589G	51	5.380G	52	5.294G
53	5.636G	54	5.660G	55	5.313G	56	5.369G
57	5.673G	58	5.375G	59	5.411G	60	5.394G
61	5.279G	62	5.689G	63	5.386G	64	5.721G
65	5.693G	66	5.291G	67	5.521G	68	5.252G
69	5.613G	70	5.489G	71	5.590G	72	5.635G
73	5.346G	74	5.540G	75	5.612G	76	5.479G
77	5.463G	78	5.568G	79	5.690G	80	5.580G
81	5.618G	82	5.446G	83	5.555G	84	5.338G
85	5.570G	86	5.413G	87	5.309G	88	5.653G
89	5.328G	90	5.719G	91	5.662G	92	5.553G
93	5.620G	94	5.482G	95	5.686G	96	5.616G
97	5.604G	98	5.263G	99	5.650G	100	5.594G



A D T

Hopping Frequency Sequence Name: HOP_FREQ_SEQ_14

SEQ#	Frequency (Hz)	SEQ#	Frequency (Hz)	SEQ#	Frequency (Hz)	SEQ#	Frequency (Hz)
1	5.323G	2	5.598G	3	5.610G	4	5.326G
5	5.690G	6	5.286G	7	5.349G	8	5.635G
9	5.449G	10	5.297G	11	5.302G	12	5.412G
13	5.464G	14	5.590G	15	5.676G	16	5.593G
17	5.589G	18	5.259G	19	5.705G	20	5.291G
21	5.518G	22	5.641G	23	5.530G	24	5.418G
25	5.715G	26	5.702G	27	5.312G	28	5.613G
29	5.271G	30	5.649G	31	5.495G	32	5.350G
33	5.434G	34	5.441G	35	5.547G	36	5.696G
37	5.383G	38	5.670G	39	5.375G	40	5.275G
41	5.369G	42	5.654G	43	5.565G	44	5.513G
45	5.336G	46	5.473G	47	5.459G	48	5.561G
49	5.652G	50	5.311G	51	5.537G	52	5.656G
53	5.425G	54	5.340G	55	5.477G	56	5.299G
57	5.555G	58	5.722G	59	5.470G	60	5.454G
61	5.519G	62	5.574G	63	5.416G	64	5.345G
65	5.435G	66	5.298G	67	5.611G	68	5.430G
69	5.691G	70	5.503G	71	5.528G	72	5.556G
73	5.422G	74	5.389G	75	5.629G	76	5.606G
77	5.264G	78	5.577G	79	5.544G	80	5.329G
81	5.660G	82	5.285G	83	5.420G	84	5.276G
85	5.623G	86	5.562G	87	5.272G	88	5.253G
89	5.269G	90	5.357G	91	5.668G	92	5.282G
93	5.583G	94	5.559G	95	5.347G	96	5.687G
97	5.487G	98	5.467G	99	5.663G	100	5.472G



A D T

Hopping Frequency Sequence Name: HOP_FREQ_SEQ_15

SEQ#	Frequency (Hz)	SEQ#	Frequency (Hz)	SEQ#	Frequency (Hz)	SEQ#	Frequency (Hz)
1	5.656G	2	5.610G	3	5.682G	4	5.267G
5	5.632G	6	5.494G	7	5.325G	8	5.706G
9	5.489G	10	5.424G	11	5.272G	12	5.648G
13	5.708G	14	5.373G	15	5.376G	16	5.720G
17	5.490G	18	5.392G	19	5.268G	20	5.363G
21	5.623G	22	5.683G	23	5.669G	24	5.629G
25	5.331G	26	5.497G	27	5.568G	28	5.592G
29	5.349G	30	5.608G	31	5.432G	32	5.606G
33	5.572G	34	5.577G	35	5.564G	36	5.628G
37	5.535G	38	5.478G	39	5.501G	40	5.689G
41	5.356G	42	5.516G	43	5.677G	44	5.634G
45	5.724G	46	5.318G	47	5.470G	48	5.471G
49	5.431G	50	5.457G	51	5.652G	52	5.596G
53	5.583G	54	5.305G	55	5.459G	56	5.281G
57	5.555G	58	5.250G	59	5.460G	60	5.361G
61	5.274G	62	5.716G	63	5.464G	64	5.679G
65	5.456G	66	5.463G	67	5.694G	68	5.389G
69	5.558G	70	5.259G	71	5.509G	72	5.334G
73	5.541G	74	5.260G	75	5.598G	76	5.622G
77	5.263G	78	5.703G	79	5.384G	80	5.680G
81	5.688G	82	5.719G	83	5.391G	84	5.718G
85	5.532G	86	5.654G	87	5.638G	88	5.676G
89	5.257G	90	5.407G	91	5.687G	92	5.288G
93	5.351G	94	5.721G	95	5.297G	96	5.549G
97	5.390G	98	5.520G	99	5.481G	100	5.355G



A D T

Hopping Frequency Sequence Name: HOP_FREQ_SEQ_16

SEQ#	Frequency (Hz)	SEQ#	Frequency (Hz)	SEQ#	Frequency (Hz)	SEQ#	Frequency (Hz)
1	5.376G	2	5.411G	3	5.420G	4	5.382G
5	5.595G	6	5.641G	7	5.333G	8	5.469G
9	5.718G	10	5.255G	11	5.511G	12	5.421G
13	5.381G	14	5.348G	15	5.572G	16	5.582G
17	5.486G	18	5.672G	19	5.518G	20	5.403G
21	5.373G	22	5.644G	23	5.336G	24	5.642G
25	5.513G	26	5.251G	27	5.337G	28	5.269G
29	5.580G	30	5.499G	31	5.588G	32	5.622G
33	5.361G	34	5.419G	35	5.667G	36	5.664G
37	5.276G	38	5.467G	39	5.324G	40	5.601G
41	5.298G	42	5.264G	43	5.554G	44	5.280G
45	5.510G	46	5.610G	47	5.687G	48	5.540G
49	5.671G	50	5.666G	51	5.709G	52	5.458G
53	5.316G	54	5.380G	55	5.425G	56	5.653G
57	5.536G	58	5.439G	59	5.440G	60	5.282G
61	5.487G	62	5.327G	63	5.717G	64	5.483G
65	5.332G	66	5.466G	67	5.322G	68	5.585G
69	5.402G	70	5.713G	71	5.451G	72	5.533G
73	5.637G	74	5.532G	75	5.385G	76	5.360G
77	5.613G	78	5.538G	79	5.364G	80	5.573G
81	5.627G	82	5.313G	83	5.428G	84	5.543G
85	5.436G	86	5.557G	87	5.609G	88	5.295G
89	5.640G	90	5.591G	91	5.629G	92	5.462G
93	5.553G	94	5.498G	95	5.683G	96	5.619G
97	5.648G	98	5.571G	99	5.686G	100	5.638G



A D T

Hopping Frequency Sequence Name: HOP_FREQ_SEQ_17

SEQ#	Frequency (Hz)	SEQ#	Frequency (Hz)	SEQ#	Frequency (Hz)	SEQ#	Frequency (Hz)
1	5.505G	2	5.663G	3	5.609G	4	5.332G
5	5.272G	6	5.655G	7	5.639G	8	5.514G
9	5.448G	10	5.343G	11	5.468G	12	5.592G
13	5.577G	14	5.647G	15	5.535G	16	5.268G
17	5.624G	18	5.360G	19	5.701G	20	5.607G
21	5.517G	22	5.503G	23	5.706G	24	5.537G
25	5.676G	26	5.308G	27	5.722G	28	5.474G
29	5.496G	30	5.617G	31	5.416G	32	5.480G
33	5.491G	34	5.584G	35	5.574G	36	5.499G
37	5.585G	38	5.712G	39	5.254G	40	5.409G
41	5.386G	42	5.320G	43	5.501G	44	5.397G
45	5.456G	46	5.363G	47	5.667G	48	5.575G
49	5.290G	50	5.572G	51	5.682G	52	5.553G
53	5.349G	54	5.539G	55	5.666G	56	5.305G
57	5.616G	58	5.672G	59	5.371G	60	5.408G
61	5.623G	62	5.334G	63	5.504G	64	5.433G
65	5.678G	66	5.315G	67	5.326G	68	5.569G
69	5.621G	70	5.311G	71	5.353G	72	5.403G
73	5.567G	74	5.679G	75	5.436G	76	5.370G
77	5.710G	78	5.516G	79	5.372G	80	5.396G
81	5.323G	82	5.698G	83	5.452G	84	5.359G
85	5.637G	86	5.407G	87	5.285G	88	5.294G
89	5.275G	90	5.292G	91	5.458G	92	5.587G
93	5.411G	94	5.306G	95	5.697G	96	5.545G
97	5.358G	98	5.464G	99	5.362G	100	5.604G



A D T

Hopping Frequency Sequence Name: HOP_FREQ_SEQ_18

SEQ#	Frequency (Hz)	SEQ#	Frequency (Hz)	SEQ#	Frequency (Hz)	SEQ#	Frequency (Hz)
1	5.526G	2	5.603G	3	5.488G	4	5.354G
5	5.306G	6	5.703G	7	5.701G	8	5.491G
9	5.360G	10	5.537G	11	5.375G	12	5.609G
13	5.545G	14	5.303G	15	5.277G	16	5.717G
17	5.386G	18	5.449G	19	5.681G	20	5.564G
21	5.275G	22	5.437G	23	5.400G	24	5.405G
25	5.585G	26	5.392G	27	5.334G	28	5.255G
29	5.459G	30	5.435G	31	5.613G	32	5.331G
33	5.524G	34	5.712G	35	5.608G	36	5.440G
37	5.709G	38	5.396G	39	5.479G	40	5.338G
41	5.558G	42	5.409G	43	5.604G	44	5.458G
45	5.428G	46	5.328G	47	5.265G	48	5.576G
49	5.305G	50	5.308G	51	5.404G	52	5.672G
53	5.393G	54	5.517G	55	5.642G	56	5.504G
57	5.402G	58	5.302G	59	5.582G	60	5.647G
61	5.610G	62	5.589G	63	5.263G	64	5.473G
65	5.552G	66	5.500G	67	5.563G	68	5.679G
69	5.535G	70	5.390G	71	5.676G	72	5.485G
73	5.299G	74	5.287G	75	5.273G	76	5.664G
77	5.515G	78	5.617G	79	5.501G	80	5.293G
81	5.476G	82	5.665G	83	5.381G	84	5.695G
85	5.675G	86	5.694G	87	5.571G	88	5.341G
89	5.462G	90	5.629G	91	5.707G	92	5.519G
93	5.611G	94	5.278G	95	5.522G	96	5.258G
97	5.259G	98	5.316G	99	5.322G	100	5.592G



A D T

Hopping Frequency Sequence Name: HOP_FREQ_SEQ_19

SEQ#	Frequency (Hz)	SEQ#	Frequency (Hz)	SEQ#	Frequency (Hz)	SEQ#	Frequency (Hz)
1	5.312G	2	5.604G	3	5.533G	4	5.267G
5	5.434G	6	5.379G	7	5.641G	8	5.290G
9	5.478G	10	5.586G	11	5.693G	12	5.404G
13	5.403G	14	5.616G	15	5.344G	16	5.703G
17	5.431G	18	5.347G	19	5.383G	20	5.292G
21	5.619G	22	5.690G	23	5.618G	24	5.473G
25	5.333G	26	5.400G	27	5.567G	28	5.562G
29	5.498G	30	5.490G	31	5.340G	32	5.585G
33	5.514G	34	5.356G	35	5.352G	36	5.362G
37	5.553G	38	5.354G	39	5.668G	40	5.510G
41	5.391G	42	5.623G	43	5.259G	44	5.457G
45	5.392G	46	5.399G	47	5.513G	48	5.371G
49	5.699G	50	5.484G	51	5.556G	52	5.470G
53	5.609G	54	5.504G	55	5.686G	56	5.582G
57	5.416G	58	5.430G	59	5.291G	60	5.658G
61	5.688G	62	5.575G	63	5.319G	64	5.511G
65	5.528G	66	5.525G	67	5.401G	68	5.468G
69	5.324G	70	5.328G	71	5.480G	72	5.464G
73	5.440G	74	5.348G	75	5.601G	76	5.422G
77	5.550G	78	5.302G	79	5.318G	80	5.602G
81	5.417G	82	5.327G	83	5.370G	84	5.269G
85	5.589G	86	5.573G	87	5.460G	88	5.286G
89	5.487G	90	5.313G	91	5.564G	92	5.520G
93	5.713G	94	5.509G	95	5.349G	96	5.529G
97	5.709G	98	5.305G	99	5.516G	100	5.326G



A D T

Hopping Frequency Sequence Name: HOP_FREQ_SEQ_20

SEQ#	Frequency (Hz)	SEQ#	Frequency (Hz)	SEQ#	Frequency (Hz)	SEQ#	Frequency (Hz)
1	5.421G	2	5.373G	3	5.407G	4	5.565G
5	5.613G	6	5.412G	7	5.617G	8	5.506G
9	5.599G	10	5.583G	11	5.252G	12	5.269G
13	5.317G	14	5.521G	15	5.483G	16	5.606G
17	5.403G	18	5.396G	19	5.712G	20	5.628G
21	5.688G	22	5.320G	23	5.401G	24	5.655G
25	5.301G	26	5.271G	27	5.516G	28	5.698G
29	5.641G	30	5.285G	31	5.338G	32	5.316G
33	5.691G	34	5.609G	35	5.294G	36	5.560G
37	5.310G	38	5.422G	39	5.489G	40	5.652G
41	5.279G	42	5.662G	43	5.399G	44	5.255G
45	5.579G	46	5.562G	47	5.568G	48	5.488G
49	5.430G	50	5.335G	51	5.487G	52	5.308G
53	5.547G	54	5.626G	55	5.558G	56	5.367G
57	5.305G	58	5.485G	59	5.679G	60	5.673G
61	5.588G	62	5.561G	63	5.549G	64	5.325G
65	5.555G	66	5.716G	67	5.333G	68	5.633G
69	5.524G	70	5.515G	71	5.345G	72	5.371G
73	5.434G	74	5.494G	75	5.690G	76	5.518G
77	5.542G	78	5.306G	79	5.321G	80	5.677G
81	5.630G	82	5.625G	83	5.364G	84	5.663G
85	5.624G	86	5.602G	87	5.525G	88	5.395G
89	5.413G	90	5.277G	91	5.393G	92	5.546G
93	5.551G	94	5.498G	95	5.302G	96	5.447G
97	5.484G	98	5.436G	99	5.468G	100	5.595G



A D T

Hopping Frequency Sequence Name: HOP_FREQ_SEQ_21

SEQ#	Frequency (Hz)	SEQ#	Frequency (Hz)	SEQ#	Frequency (Hz)	SEQ#	Frequency (Hz)
1	5.466G	2	5.650G	3	5.663G	4	5.337G
5	5.681G	6	5.447G	7	5.449G	8	5.634G
9	5.514G	10	5.409G	11	5.440G	12	5.658G
13	5.636G	14	5.529G	15	5.698G	16	5.354G
17	5.651G	18	5.332G	19	5.533G	20	5.496G
21	5.574G	22	5.416G	23	5.573G	24	5.586G
25	5.250G	26	5.283G	27	5.369G	28	5.431G
29	5.302G	30	5.683G	31	5.319G	32	5.605G
33	5.408G	34	5.263G	35	5.344G	36	5.699G
37	5.345G	38	5.500G	39	5.353G	40	5.421G
41	5.407G	42	5.710G	43	5.535G	44	5.256G
45	5.499G	46	5.267G	47	5.309G	48	5.497G
49	5.341G	50	5.525G	51	5.435G	52	5.595G
53	5.624G	54	5.428G	55	5.590G	56	5.376G
57	5.433G	58	5.272G	59	5.591G	60	5.274G
61	5.513G	62	5.314G	63	5.360G	64	5.688G
65	5.290G	66	5.637G	67	5.424G	68	5.482G
69	5.568G	70	5.648G	71	5.671G	72	5.384G
73	5.606G	74	5.473G	75	5.478G	76	5.287G
77	5.410G	78	5.656G	79	5.599G	80	5.406G
81	5.286G	82	5.580G	83	5.559G	84	5.653G
85	5.429G	86	5.669G	87	5.266G	88	5.587G
89	5.453G	90	5.709G	91	5.544G	92	5.457G
93	5.642G	94	5.678G	95	5.674G	96	5.589G
97	5.588G	98	5.545G	99	5.666G	100	5.675G



A D T

Hopping Frequency Sequence Name: HOP_FREQ_SEQ_22

SEQ#	Frequency (Hz)	SEQ#	Frequency (Hz)	SEQ#	Frequency (Hz)	SEQ#	Frequency (Hz)
1	5.534G	2	5.412G	3	5.286G	4	5.461G
5	5.592G	6	5.615G	7	5.560G	8	5.275G
9	5.380G	10	5.400G	11	5.626G	12	5.596G
13	5.582G	14	5.278G	15	5.659G	16	5.540G
17	5.677G	18	5.477G	19	5.705G	20	5.428G
21	5.702G	22	5.682G	23	5.566G	24	5.312G
25	5.561G	26	5.294G	27	5.374G	28	5.716G
29	5.678G	30	5.494G	31	5.621G	32	5.522G
33	5.264G	34	5.448G	35	5.467G	36	5.701G
37	5.413G	38	5.408G	39	5.665G	40	5.311G
41	5.536G	42	5.346G	43	5.372G	44	5.688G
45	5.502G	46	5.478G	47	5.535G	48	5.496G
49	5.694G	50	5.354G	51	5.452G	52	5.622G
53	5.337G	54	5.585G	55	5.470G	56	5.415G
57	5.340G	58	5.308G	59	5.285G	60	5.634G
61	5.515G	62	5.680G	63	5.572G	64	5.640G
65	5.717G	66	5.295G	67	5.511G	68	5.383G
69	5.396G	70	5.435G	71	5.425G	72	5.319G
73	5.607G	74	5.393G	75	5.484G	76	5.324G
77	5.359G	78	5.696G	79	5.331G	80	5.480G
81	5.595G	82	5.471G	83	5.277G	84	5.559G
85	5.608G	86	5.555G	87	5.410G	88	5.318G
89	5.646G	90	5.584G	91	5.504G	92	5.436G
93	5.314G	94	5.703G	95	5.366G	96	5.644G
97	5.509G	98	5.683G	99	5.417G	100	5.339G



A D T

Hopping Frequency Sequence Name: HOP_FREQ_SEQ_23

SEQ#	Frequency (Hz)	SEQ#	Frequency (Hz)	SEQ#	Frequency (Hz)	SEQ#	Frequency (Hz)
1	5.326G	2	5.554G	3	5.445G	4	5.388G
5	5.662G	6	5.600G	7	5.649G	8	5.313G
9	5.595G	10	5.481G	11	5.416G	12	5.599G
13	5.401G	14	5.552G	15	5.449G	16	5.321G
17	5.419G	18	5.538G	19	5.338G	20	5.717G
21	5.579G	22	5.324G	23	5.331G	24	5.562G
25	5.664G	26	5.718G	27	5.462G	28	5.409G
29	5.634G	30	5.387G	31	5.681G	32	5.444G
33	5.344G	34	5.603G	35	5.412G	36	5.515G
37	5.573G	38	5.575G	39	5.258G	40	5.460G
41	5.527G	42	5.290G	43	5.688G	44	5.656G
45	5.472G	46	5.304G	47	5.415G	48	5.417G
49	5.255G	50	5.418G	51	5.479G	52	5.422G
53	5.525G	54	5.499G	55	5.488G	56	5.267G
57	5.616G	58	5.639G	59	5.420G	60	5.638G
61	5.559G	62	5.456G	63	5.297G	64	5.336G
65	5.474G	66	5.360G	67	5.454G	68	5.433G
69	5.379G	70	5.642G	71	5.524G	72	5.252G
73	5.621G	74	5.674G	75	5.516G	76	5.350G
77	5.645G	78	5.679G	79	5.580G	80	5.410G
81	5.442G	82	5.486G	83	5.582G	84	5.609G
85	5.269G	86	5.309G	87	5.332G	88	5.380G
89	5.275G	90	5.637G	91	5.539G	92	5.394G
93	5.458G	94	5.578G	95	5.337G	96	5.622G
97	5.251G	98	5.542G	99	5.391G	100	5.623G



A D T

Hopping Frequency Sequence Name: HOP_FREQ_SEQ_24

SEQ#	Frequency (Hz)	SEQ#	Frequency (Hz)	SEQ#	Frequency (Hz)	SEQ#	Frequency (Hz)
1	5.625G	2	5.694G	3	5.545G	4	5.705G
5	5.580G	6	5.340G	7	5.559G	8	5.313G
9	5.721G	10	5.718G	11	5.301G	12	5.354G
13	5.603G	14	5.527G	15	5.361G	16	5.716G
17	5.584G	18	5.433G	19	5.499G	20	5.321G
21	5.394G	22	5.429G	23	5.352G	24	5.335G
25	5.261G	26	5.374G	27	5.280G	28	5.258G
29	5.414G	30	5.635G	31	5.500G	32	5.269G
33	5.441G	34	5.494G	35	5.710G	36	5.552G
37	5.659G	38	5.459G	39	5.323G	40	5.477G
41	5.723G	42	5.342G	43	5.311G	44	5.438G
45	5.286G	46	5.687G	47	5.677G	48	5.307G
49	5.693G	50	5.568G	51	5.380G	52	5.357G
53	5.712G	54	5.362G	55	5.582G	56	5.686G
57	5.586G	58	5.474G	59	5.596G	60	5.606G
61	5.537G	62	5.522G	63	5.642G	64	5.631G
65	5.556G	66	5.462G	67	5.419G	68	5.369G
69	5.657G	70	5.417G	71	5.547G	72	5.707G
73	5.574G	74	5.425G	75	5.616G	76	5.263G
77	5.251G	78	5.502G	79	5.479G	80	5.684G
81	5.515G	82	5.412G	83	5.293G	84	5.561G
85	5.399G	86	5.314G	87	5.341G	88	5.542G
89	5.632G	90	5.481G	91	5.283G	92	5.447G
93	5.567G	94	5.588G	95	5.578G	96	5.519G
97	5.396G	98	5.407G	99	5.454G	100	5.512G



A D T

Hopping Frequency Sequence Name: HOP_FREQ_SEQ_25

SEQ#	Frequency (Hz)	SEQ#	Frequency (Hz)	SEQ#	Frequency (Hz)	SEQ#	Frequency (Hz)
1	5.641G	2	5.311G	3	5.354G	4	5.556G
5	5.435G	6	5.483G	7	5.346G	8	5.257G
9	5.540G	10	5.555G	11	5.301G	12	5.405G
13	5.541G	14	5.266G	15	5.520G	16	5.413G
17	5.273G	18	5.467G	19	5.332G	20	5.365G
21	5.367G	22	5.282G	23	5.447G	24	5.422G
25	5.299G	26	5.628G	27	5.337G	28	5.252G
29	5.345G	30	5.704G	31	5.419G	32	5.394G
33	5.522G	34	5.275G	35	5.355G	36	5.646G
37	5.343G	38	5.459G	39	5.481G	40	5.318G
41	5.455G	42	5.674G	43	5.284G	44	5.496G
45	5.283G	46	5.331G	47	5.347G	48	5.603G
49	5.581G	50	5.416G	51	5.351G	52	5.714G
53	5.427G	54	5.378G	55	5.412G	56	5.293G
57	5.617G	58	5.404G	59	5.683G	60	5.539G
61	5.611G	62	5.370G	63	5.504G	64	5.295G
65	5.532G	66	5.458G	67	5.577G	68	5.321G
69	5.401G	70	5.300G	71	5.398G	72	5.657G
73	5.482G	74	5.644G	75	5.688G	76	5.679G
77	5.469G	78	5.610G	79	5.376G	80	5.267G
81	5.517G	82	5.551G	83	5.285G	84	5.528G
85	5.671G	86	5.583G	87	5.702G	88	5.664G
89	5.329G	90	5.660G	91	5.442G	92	5.339G
93	5.387G	94	5.599G	95	5.684G	96	5.718G
97	5.701G	98	5.470G	99	5.716G	100	5.545G



A D T

Hopping Frequency Sequence Name: HOP_FREQ_SEQ_26

SEQ#	Frequency (Hz)	SEQ#	Frequency (Hz)	SEQ#	Frequency (Hz)	SEQ#	Frequency (Hz)
1	5.585G	2	5.540G	3	5.264G	4	5.523G
5	5.578G	6	5.456G	7	5.516G	8	5.396G
9	5.496G	10	5.390G	11	5.683G	12	5.417G
13	5.322G	14	5.611G	15	5.488G	16	5.308G
17	5.470G	18	5.319G	19	5.706G	20	5.345G
21	5.577G	22	5.689G	23	5.555G	24	5.418G
25	5.530G	26	5.347G	27	5.344G	28	5.563G
29	5.423G	30	5.401G	31	5.403G	32	5.665G
33	5.595G	34	5.522G	35	5.637G	36	5.394G
37	5.556G	38	5.543G	39	5.616G	40	5.583G
41	5.479G	42	5.294G	43	5.550G	44	5.533G
45	5.512G	46	5.335G	47	5.457G	48	5.501G
49	5.594G	50	5.485G	51	5.653G	52	5.565G
53	5.591G	54	5.561G	55	5.692G	56	5.669G
57	5.685G	58	5.291G	59	5.672G	60	5.295G
61	5.663G	62	5.252G	63	5.666G	64	5.639G
65	5.440G	66	5.686G	67	5.338G	68	5.615G
69	5.499G	70	5.539G	71	5.343G	72	5.385G
73	5.695G	74	5.504G	75	5.438G	76	5.408G
77	5.453G	78	5.298G	79	5.531G	80	5.442G
81	5.589G	82	5.386G	83	5.303G	84	5.429G
85	5.599G	86	5.597G	87	5.519G	88	5.635G
89	5.668G	90	5.328G	91	5.571G	92	5.510G
93	5.664G	94	5.560G	95	5.490G	96	5.250G
97	5.392G	98	5.282G	99	5.357G	100	5.460G



A D T

Hopping Frequency Sequence Name: HOP_FREQ_SEQ_27

SEQ#	Frequency (Hz)	SEQ#	Frequency (Hz)	SEQ#	Frequency (Hz)	SEQ#	Frequency (Hz)
1	5.343G	2	5.685G	3	5.522G	4	5.577G
5	5.558G	6	5.584G	7	5.263G	8	5.478G
9	5.495G	10	5.400G	11	5.567G	12	5.663G
13	5.274G	14	5.374G	15	5.676G	16	5.695G
17	5.258G	18	5.572G	19	5.336G	20	5.389G
21	5.505G	22	5.636G	23	5.309G	24	5.250G
25	5.710G	26	5.483G	27	5.417G	28	5.352G
29	5.429G	30	5.490G	31	5.593G	32	5.291G
33	5.690G	34	5.621G	35	5.442G	36	5.486G
37	5.713G	38	5.470G	39	5.703G	40	5.694G
41	5.267G	42	5.317G	43	5.600G	44	5.361G
45	5.481G	46	5.452G	47	5.475G	48	5.551G
49	5.559G	50	5.455G	51	5.255G	52	5.697G
53	5.719G	54	5.441G	55	5.571G	56	5.325G
57	5.284G	58	5.362G	59	5.306G	60	5.582G
61	5.403G	62	5.597G	63	5.323G	64	5.605G
65	5.393G	66	5.687G	67	5.428G	68	5.615G
69	5.278G	70	5.264G	71	5.359G	72	5.388G
73	5.565G	74	5.589G	75	5.721G	76	5.271G
77	5.383G	78	5.353G	79	5.626G	80	5.402G
81	5.448G	82	5.531G	83	5.543G	84	5.337G
85	5.556G	86	5.645G	87	5.408G	88	5.350G
89	5.319G	90	5.560G	91	5.544G	92	5.326G
93	5.327G	94	5.569G	95	5.351G	96	5.290G
97	5.480G	98	5.604G	99	5.527G	100	5.430G



A D T

Hopping Frequency Sequence Name: HOP_FREQ_SEQ_28

SEQ#	Frequency (Hz)	SEQ#	Frequency (Hz)	SEQ#	Frequency (Hz)	SEQ#	Frequency (Hz)
1	5.589G	2	5.698G	3	5.259G	4	5.718G
5	5.692G	6	5.506G	7	5.711G	8	5.365G
9	5.335G	10	5.527G	11	5.331G	12	5.639G
13	5.655G	14	5.594G	15	5.552G	16	5.428G
17	5.670G	18	5.669G	19	5.450G	20	5.399G
21	5.462G	22	5.677G	23	5.273G	24	5.582G
25	5.675G	26	5.553G	27	5.674G	28	5.550G
29	5.608G	30	5.632G	31	5.724G	32	5.444G
33	5.438G	34	5.557G	35	5.256G	36	5.437G
37	5.633G	38	5.705G	39	5.384G	40	5.661G
41	5.446G	42	5.592G	43	5.403G	44	5.498G
45	5.551G	46	5.296G	47	5.696G	48	5.631G
49	5.515G	50	5.358G	51	5.641G	52	5.600G
53	5.372G	54	5.473G	55	5.389G	56	5.489G
57	5.643G	58	5.572G	59	5.361G	60	5.288G
61	5.337G	62	5.320G	63	5.503G	64	5.285G
65	5.665G	66	5.647G	67	5.426G	68	5.667G
69	5.545G	70	5.362G	71	5.424G	72	5.420G
73	5.445G	74	5.636G	75	5.559G	76	5.699G
77	5.360G	78	5.367G	79	5.588G	80	5.448G
81	5.276G	82	5.429G	83	5.412G	84	5.634G
85	5.590G	86	5.518G	87	5.401G	88	5.642G
89	5.487G	90	5.286G	91	5.717G	92	5.452G
93	5.681G	94	5.266G	95	5.618G	96	5.306G
97	5.271G	98	5.525G	99	5.345G	100	5.704G



A D T

Hopping Frequency Sequence Name: HOP_FREQ_SEQ_29

SEQ#	Frequency (Hz)	SEQ#	Frequency (Hz)	SEQ#	Frequency (Hz)	SEQ#	Frequency (Hz)
1	5.561G	2	5.633G	3	5.325G	4	5.671G
5	5.426G	6	5.643G	7	5.433G	8	5.617G
9	5.575G	10	5.721G	11	5.288G	12	5.498G
13	5.705G	14	5.347G	15	5.542G	16	5.590G
17	5.692G	18	5.648G	19	5.449G	20	5.571G
21	5.708G	22	5.618G	23	5.640G	24	5.327G
25	5.584G	26	5.399G	27	5.724G	28	5.444G
29	5.357G	30	5.489G	31	5.375G	32	5.654G
33	5.621G	34	5.478G	35	5.647G	36	5.286G
37	5.438G	38	5.656G	39	5.574G	40	5.570G
41	5.324G	42	5.650G	43	5.471G	44	5.465G
45	5.350G	46	5.259G	47	5.481G	48	5.699G
49	5.270G	50	5.667G	51	5.497G	52	5.440G
53	5.553G	54	5.672G	55	5.551G	56	5.530G
57	5.332G	58	5.700G	59	5.342G	60	5.410G
61	5.374G	62	5.689G	63	5.421G	64	5.282G
65	5.293G	66	5.717G	67	5.369G	68	5.277G
69	5.635G	70	5.591G	71	5.505G	72	5.281G
73	5.317G	74	5.469G	75	5.547G	76	5.425G
77	5.641G	78	5.582G	79	5.696G	80	5.670G
81	5.628G	82	5.525G	83	5.434G	84	5.567G
85	5.607G	86	5.362G	87	5.514G	88	5.612G
89	5.568G	90	5.664G	91	5.255G	92	5.632G
93	5.704G	94	5.653G	95	5.468G	96	5.297G
97	5.435G	98	5.388G	99	5.663G	100	5.284G



A D T

Hopping Frequency Sequence Name: HOP_FREQ_SEQ_30

SEQ#	Frequency (Hz)	SEQ#	Frequency (Hz)	SEQ#	Frequency (Hz)	SEQ#	Frequency (Hz)
1	5.291G	2	5.434G	3	5.520G	4	5.570G
5	5.521G	6	5.563G	7	5.667G	8	5.271G
9	5.540G	10	5.357G	11	5.282G	12	5.280G
13	5.513G	14	5.284G	15	5.301G	16	5.618G
17	5.587G	18	5.277G	19	5.457G	20	5.586G
21	5.575G	22	5.594G	23	5.428G	24	5.488G
25	5.657G	26	5.589G	27	5.666G	28	5.701G
29	5.354G	30	5.687G	31	5.698G	32	5.709G
33	5.459G	34	5.320G	35	5.433G	36	5.373G
37	5.416G	38	5.640G	39	5.634G	40	5.352G
41	5.315G	42	5.617G	43	5.505G	44	5.438G
45	5.643G	46	5.281G	47	5.360G	48	5.574G
49	5.539G	50	5.422G	51	5.326G	52	5.342G
53	5.345G	54	5.663G	55	5.414G	56	5.386G
57	5.695G	58	5.571G	59	5.547G	60	5.337G
61	5.639G	62	5.447G	63	5.630G	64	5.395G
65	5.307G	66	5.361G	67	5.553G	68	5.316G
69	5.515G	70	5.467G	71	5.263G	72	5.371G
73	5.638G	74	5.480G	75	5.413G	76	5.330G
77	5.446G	78	5.533G	79	5.669G	80	5.399G
81	5.298G	82	5.411G	83	5.622G	84	5.283G
85	5.677G	86	5.323G	87	5.319G	88	5.260G
89	5.528G	90	5.344G	91	5.660G	92	5.475G
93	5.292G	94	5.706G	95	5.546G	96	5.604G
97	5.527G	98	5.655G	99	5.299G	100	5.369G



A D T

802.11ac VHT40

Long Pulse Radar Test Signal						
Test Signal Name: LP_Signal_01						
Number of Bursts in Trial: 8						
Burst	Pulses per Burst	Chrip (Hz)	Pulse Width (s)	Pulse 1 to 2 Spacing (s)	Pulse 2 to 3 Spacing (s)	Start Location (s)
1	2	11M	87.4u	1.047m	-	325m
2	1	14M	51.5u	-	-	137m
3	3	15M	76.8u	1.478m	1.366m	609m
4	1	19M	54.9u	-	-	113m
5	2	13M	85.8u	1.857m	-	1391m
6	1	15M	64.5u	-	-	1038m
7	2	10M	62.2u	1.756m	-	861m
8	1	6M	96.9u	-	-	644m

Long Pulse Radar Test Signal						
Test Signal Name: LP_Signal_02						
Number of Bursts in Trial: 9						
Burst	Pulses per Burst	Chrip (Hz)	Pulse Width (s)	Pulse 1 to 2 Spacing (s)	Pulse 2 to 3 Spacing (s)	Start Location (s)
1	2	13M	88u	1.456m	-	264m
2	2	8M	87.8u	1.09m	-	1037m
3	3	7M	96.5u	0.966m	1.228m	1233m
4	3	13M	71.5u	1.491m	1.772m	689m
5	2	18M	63.8u	1.457m	-	1113m
6	2	10M	70.8u	1.446m	-	1096m
7	3	10M	87.8u	1.762m	1.673m	285m
8	1	8M	56.1u	-	-	1288m
9	2	10M	75.2u	1.535m	-	647m



A D T

Long Pulse Radar Test Signal						
Test Signal Name: LP_Signal_03						
Number of Bursts in Trial: 10						
Burst	Pulses per Burst	Chrip (Hz)	Pulse Width (s)	Pulse 1 to 2 Spacing (s)	Pulse 2 to 3 Spacing (s)	Start Location (s)
1	1	18M	60.1u	-	-	656m
2	1	14M	60.5u	-	-	482m
3	2	13M	58.1u	1.477m	-	1066m
4	2	20M	92.1u	1.188m	-	232m
5	2	9M	87.9u	0.999m	-	661m
6	2	18M	62.1u	1.231m	-	663m
7	1	20M	66.6u	-	-	783m
8	2	10M	76.7u	1.503m	-	541m
9	2	9M	56.6u	0.98m	-	728m
10	1	20M	66u	-	-	614m

Long Pulse Radar Test Signal						
Test Signal Name: LP_Signal_04						
Number of Bursts in Trial: 11						
Burst	Pulses per Burst	Chrip (Hz)	Pulse Width (s)	Pulse 1 to 2 Spacing (s)	Pulse 2 to 3 Spacing (s)	Start Location (s)
1	1	20M	76.9u	-	-	716m
2	2	12M	72.8u	1.922m	-	259m
3	2	6M	77.6u	1.211m	-	229m
4	1	11M	83.9u	-	-	265m
5	1	9M	88.8u	-	-	863m
6	3	7M	71.3u	1.157m	1.022m	440m
7	2	8M	63.2u	1.439m	-	701m
8	1	13M	85.8u	-	-	256m
9	2	7M	95.1u	1.733m	-	1016m
10	2	14M	70u	1.425m	-	1035m
11	2	10M	52.3u	1.257m	-	6m



A D T

Long Pulse Radar Test Signal
 Test Signal Name: LP_Signal_05
 Number of Bursts in Trial: 12

Burst	Pulses per Burst	Chrip (Hz)	Pulse Width (s)	Pulse 1 to 2 Spacing (s)	Pulse 2 to 3 Spacing (s)	Start Location (s)
1	1	7M	84.3u	-	-	559m
2	3	18M	52.4u	1.242m	1.867m	857m
3	2	19M	73u	1.409m	-	615m
4	3	15M	73u	1.115m	1.828m	694m
5	3	11M	85.1u	1.287m	0.938m	120m
6	2	17M	75.8u	1.907m	-	774m
7	2	18M	70.9u	1.525m	-	900m
8	3	19M	80.6u	1.009m	1.648m	932m
9	2	5M	82.6u	1.503m	-	910m
10	1	7M	88.3u	-	-	577m
11	2	18M	75.4u	1.536m	-	130m
12	3	18M	77.5u	1.043m	1.551m	233m

Long Pulse Radar Test Signal
 Test Signal Name: LP_Signal_06
 Number of Bursts in Trial: 13

Burst	Pulses per Burst	Chrip (Hz)	Pulse Width (s)	Pulse 1 to 2 Spacing (s)	Pulse 2 to 3 Spacing (s)	Start Location (s)
1	2	9M	55.5u	1.544m	-	642m
2	3	18M	73.1u	1.281m	1.399m	383m
3	2	20M	89.3u	1.462m	-	112m
4	1	20M	61.7u	-	-	267m
5	2	18M	76.9u	1.234m	-	766m
6	1	20M	89.4u	-	-	820m
7	2	9M	62u	1.299m	-	806m
8	2	6M	86.8u	1.284m	-	466m
9	2	11M	62.3u	1.483m	-	250m
10	2	20M	86.6u	1.393m	-	364m
11	1	9M	91u	-	-	894m
12	2	8M	51u	1.889m	-	631m
13	3	6M	93.8u	1.277m	1.77m	631m



A D T

Long Pulse Radar Test Signal
Test Signal Name: LP_Signal_07
Number of Bursts in Trial: 14

Burst	Pulses per Burst	Chrip (Hz)	Pulse Width (s)	Pulse 1 to 2 Spacing (s)	Pulse 2 to 3 Spacing (s)	Start Location (s)
1	1	10M	50.4u	-	-	688m
2	2	13M	75.4u	0.969m	-	391m
3	1	12M	62.3u	-	-	450m
4	3	7M	54.6u	1.564m	1.275m	153m
5	1	5M	74.1u	-	-	648m
6	2	7M	64.8u	1.887m	-	492m
7	1	12M	75.3u	-	-	52m
8	2	8M	59.9u	1.645m	-	628m
9	3	6M	54u	1.701m	1.813m	225m
10	1	8M	60.5u	-	-	644m
11	1	19M	53.9u	-	-	333m
12	1	20M	50.8u	-	-	394m
13	2	5M	57u	1.878m	-	474m
14	2	7M	71.9u	1.333m	-	505m

Long Pulse Radar Test Signal
Test Signal Name: LP_Signal_08
Number of Bursts in Trial: 15

Burst	Pulses per Burst	Chrip (Hz)	Pulse Width (s)	Pulse 1 to 2 Spacing (s)	Pulse 2 to 3 Spacing (s)	Start Location (s)
1	2	17M	65.9u	1.907m	-	173m
2	3	13M	61.3u	1.066m	1.207m	298m
3	3	9M	63.4u	1.84m	1.733m	684m
4	1	13M	65.2u	-	-	24m
5	2	9M	52.1u	1.597m	-	226m
6	2	10M	80.6u	1.662m	-	791m
7	2	18M	92.5u	1.008m	-	786m
8	2	13M	97.2u	1.827m	-	94m
9	1	20M	59.6u	-	-	352m
10	1	15M	96.4u	-	-	658m
11	1	15M	92.3u	-	-	122m
12	2	8M	92.1u	1.824m	-	282m
13	1	13M	68.5u	-	-	99m
14	1	13M	65.6u	-	-	537m
15	2	11M	73.9u	1.91m	-	105m



A D T

Long Pulse Radar Test Signal
Test Signal Name: LP_Signal_09
Number of Bursts in Trial: 16

Burst	Pulses per Burst	Chrip (Hz)	Pulse Width (s)	Pulse 1 to 2 Spacing (s)	Pulse 2 to 3 Spacing (s)	Start Location (s)
1	3	20M	71u	1.195m	1.292m	190m
2	1	6M	61u	-	-	617m
3	2	20M	65.8u	1.718m	-	6m
4	2	12M	87.4u	1.592m	-	286m
5	2	12M	58.9u	1.029m	-	141m
6	3	17M	67.4u	1.245m	1.226m	721m
7	2	8M	91.7u	0.968m	-	80m
8	2	15M	73.7u	1.354m	-	334m
9	1	15M	89.7u	-	-	94m
10	2	6M	82.5u	1.07m	-	113m
11	3	18M	74.9u	1.723m	1.815m	373m
12	2	10M	69u	1.31m	-	70m
13	1	18M	70.9u	-	-	76m
14	3	15M	77.5u	1.442m	1.683m	403m
15	2	15M	78.5u	1.37m	-	551m
16	2	15M	63u	1.574m	-	539m



A D T

Long Pulse Radar Test Signal
Test Signal Name: LP_Signal_10
Number of Bursts in Trial: 17

Burst	Pulses per Burst	Chrip (Hz)	Pulse Width (s)	Pulse 1 to 2 Spacing (s)	Pulse 2 to 3 Spacing (s)	Start Location (s)
1	2	9M	97.3u	1.812m	-	425m
2	1	17M	76.2u	-	-	214m
3	3	17M	63.6u	1.221m	1.531m	16m
4	2	11M	91.9u	1.448m	-	263m
5	2	15M	61.6u	1.803m	-	471m
6	2	12M	92.4u	1.197m	-	48m
7	2	11M	92.3u	1.593m	-	137m
8	2	9M	93.3u	1.41m	-	349m
9	2	5M	86.5u	1.521m	-	219m
10	1	8M	54.7u	-	-	195m
11	3	7M	69.6u	1.325m	1.172m	230m
12	2	12M	87.1u	1.131m	-	693m
13	2	13M	83.1u	1.59m	-	688m
14	3	17M	82.1u	1.91m	1.472m	80m
15	2	18M	56u	1.268m	-	416m
16	2	10M	98.2u	1.583m	-	410m
17	1	13M	80.1u	-	-	172m



A D T

Long Pulse Radar Test Signal
Test Signal Name: LP_Signal_11
Number of Bursts in Trial: 18

Burst	Pulses per Burst	Chrip (Hz)	Pulse Width (s)	Pulse 1 to 2 Spacing (s)	Pulse 2 to 3 Spacing (s)	Start Location (s)
1	2	9M	63.7u	1.689m	-	538m
2	2	12M	77.5u	1.792m	-	642m
3	2	13M	83.4u	1.755m	-	248m
4	2	15M	59.2u	1.688m	-	190m
5	2	17M	64.2u	1.389m	-	378m
6	2	10M	92.3u	1.662m	-	538m
7	2	19M	53.9u	1.747m	-	6m
8	3	6M	72.3u	1.072m	1.077m	152m
9	3	19M	51u	1.429m	1.567m	461m
10	2	6M	61.3u	1.465m	-	381m
11	1	13M	98.2u	-	-	554m
12	3	17M	85u	1.258m	1.25m	631m
13	1	9M	75.7u	-	-	573m
14	1	12M	92.2u	-	-	554m
15	2	18M	51.5u	1.753m	-	53m
16	1	8M	50.1u	-	-	513m
17	2	5M	59.9u	1.865m	-	400m
18	2	13M	85.7u	1.712m	-	45m



A D T

Long Pulse Radar Test Signal
Test Signal Name: LP_Signal_12
Number of Bursts in Trial: 19

Burst	Pulses per Burst	Chrip (Hz)	Pulse Width (s)	Pulse 1 to 2 Spacing (s)	Pulse 2 to 3 Spacing (s)	Start Location (s)
1	2	11M	68.3u	1.23m	-	372m
2	2	6M	98.9u	1.464m	-	180m
3	2	9M	53.9u	1.301m	-	617m
4	2	13M	68.1u	1.886m	-	476m
5	2	7M	77.4u	1.083m	-	431m
6	1	10M	63.4u	-	-	524m
7	2	13M	69.3u	1.815m	-	93m
8	3	7M	96.3u	0.969m	1.557m	451m
9	1	6M	62.2u	-	-	70m
10	2	7M	73.9u	1.028m	-	536m
11	2	15M	86.8u	1.908m	-	432m
12	3	7M	75.5u	1.342m	1.785m	99m
13	3	15M	94.5u	1.377m	1.739m	25m
14	2	19M	68.2u	1.26m	-	394m
15	1	13M	84.8u	-	-	47m
16	3	12M	92.5u	1.259m	1.282m	551m
17	2	13M	50.6u	1.904m	-	19m
18	1	9M	68.5u	-	-	188m
19	2	12M	85.5u	1.727m	-	510m



A D T

Long Pulse Radar Test Signal
 Test Signal Name: LP_Signal_13
 Number of Bursts in Trial: 20

Burst	Pulses per Burst	Chrip (Hz)	Pulse Width (s)	Pulse 1 to 2 Spacing (s)	Pulse 2 to 3 Spacing (s)	Start Location (s)
1	1	13M	72u	-	-	55m
2	1	13M	93.7u	-	-	197m
3	3	9M	86.7u	1.166m	1.036m	143m
4	2	19M	70.9u	0.974m	-	145m
5	3	19M	56.8u	1.119m	1.42m	169m
6	1	14M	97.7u	-	-	181m
7	1	5M	58.1u	-	-	390m
8	1	13M	95.6u	-	-	261m
9	2	10M	61u	1.469m	-	326m
10	2	12M	65.7u	0.981m	-	230m
11	1	5M	57.5u	-	-	52m
12	2	12M	91.4u	1.538m	-	482m
13	2	18M	98.3u	1.474m	-	474m
14	1	11M	92.7u	-	-	447m
15	3	18M	66.9u	1.495m	-	57m
16	1	18M	87u	-	-	393m
17	3	18M	61.7u	1.907m	1.488m	337m
18	2	12M	61.3u	1.452m	-	140m
19	2	12M	89.7u	0.963m	-	528m
20	1	8M	60.8u	-	-	362m

Long Pulse Radar Test Signal
 Test Signal Name: LP_Signal_14
 Number of Bursts in Trial: 8

Burst	Pulses per Burst	Chrip (Hz)	Pulse Width (s)	Pulse 1 to 2 Spacing (s)	Pulse 2 to 3 Spacing (s)	Start Location (s)
1	3	18M	87.1u	1.847m	1.188m	1057m
2	1	9M	92.6u	-	-	349m
3	2	11M	86.1u	1.4m	-	1242m
4	1	7M	78.1u	-	-	907m
5	2	14M	75.2u	1.578m	-	429m
6	1	10M	60.3u	-	-	320m
7	2	20M	68.3u	1.097m	-	724m
8	2	11M	91.7u	1.076m	-	1426m



A D T

Long Pulse Radar Test Signal
Test Signal Name: LP_Signal_15
Number of Bursts in Trial: 10

Burst	Pulses per Burst	Chrip (Hz)	Pulse Width (s)	Pulse 1 to 2 Spacing (s)	Pulse 2 to 3 Spacing (s)	Start Location (s)
1	3	19M	79.7u	1.401m	1.726m	1070m
2	2	8M	72.9u	1.152m	-	885m
3	2	14M	83.4u	1.81m	-	431m
4	1	13M	65.8u	-	-	542m
5	3	15M	59.9u	0.975m	1.34m	814m
6	2	11M	68.3u	1.039m	0m	785m
7	3	5M	59.5u	1.776m	1.442m	477m
8	1	19M	90.2u	-	-	297m
9	2	11M	57.1u	1.937m	-	849m
10	2	18M	90.3u	1.601m	-	163m

Long Pulse Radar Test Signal
Test Signal Name: LP_Signal_16
Number of Bursts in Trial: 12

Burst	Pulses per Burst	Chrip (Hz)	Pulse Width (s)	Pulse 1 to 2 Spacing (s)	Pulse 2 to 3 Spacing (s)	Start Location (s)
1	2	8M	70.7u	0.987m	-	456m
2	2	18M	55.7u	1.521m	-	905m
3	3	11M	55.3u	1.51m	1.132m	632m
4	2	13M	53.2u	1.216m	-	987m
5	3	8M	77.9u	1.431m	1.17m	22m
6	1	8M	53.9u	-	-	238m
7	2	14M	73.5u	1.735m	-	139m
8	3	6M	100u	1.625m	1.183m	807m
9	1	13M	75.3u	-	-	204m
10	3	19M	64.2u	1.658m	1.218m	313m
11	2	7M	75.1u	1.151m	-	977m
12	2	20M	54.3u	0.952m	-	771m



A D T

Long Pulse Radar Test Signal
 Test Signal Name: LP_Signal_17
 Number of Bursts in Trial: 14

Burst	Pulses per Burst	Chrip (Hz)	Pulse Width (s)	Pulse 1 to 2 Spacing (s)	Pulse 2 to 3 Spacing (s)	Start Location (s)
1	2	19M	90.2u	1.208m	-	447m
2	1	8M	70.5u	-	-	310m
3	1	7M	98.4u	-	-	390m
4	1	20M	77.1u	-	-	124m
5	3	7M	94.6u	0.954m	1.612m	548m
6	3	13M	77.5u	1.29m	1.731m	362m
7	3	10M	80.5u	1.179m	1.262m	211m
8	1	10M	55.8u	-	-	605m
9	1	13M	53u	-	-	121m
10	2	19M	83.7u	1.887m	-	278m
11	2	11M	98.7u	1.005m	-	650m
12	2	10M	58.8u	1.866m	-	279m
13	3	11M	64u	1.574m	1.623m	387m
14	2	20M	94.6u	1.516m	-	127m

Long Pulse Radar Test Signal
 Test Signal Name: LP_Signal_18
 Number of Bursts in Trial: 16

Burst	Pulses per Burst	Chrip (Hz)	Pulse Width (s)	Pulse 1 to 2 Spacing (s)	Pulse 2 to 3 Spacing (s)	Start Location (s)
1	3	12M	50u	1.449m	1.508m	116m
2	2	15M	80.7u	1.756m	-	726m
3	1	13M	73.6u	-	-	535m
4	1	7M	74.9u	-	-	427m
5	3	17M	50.2u	1.191m	1.117m	225m
6	1	8M	85.5u	-	-	152m
7	3	18M	92.4u	1.238m	1.624m	296m
8	3	19M	77.5u	1.184m	1.67m	192m
9	3	19M	81.5u	1.772m	1.179m	67m
10	1	5M	69.8u	-	-	94m
11	3	11M	70.4u	1.475m	1.415m	519m
12	2	20M	64.5u	1.548m	-	115m
13	1	14M	88.4u	-	-	134m
14	2	13M	71.9u	1.173m	-	378m
15	2	17M	89.9u	1.501m	-	390m
16	1	11M	93.1u	-	-	672m



A D T

Long Pulse Radar Test Signal
Test Signal Name: LP_Signal_19
Number of Bursts in Trial: 18

Burst	Pulses per Burst	Chrip (Hz)	Pulse Width (s)	Pulse 1 to 2 Spacing (s)	Pulse 2 to 3 Spacing (s)	Start Location (s)
1	2	7M	83.3u	1.027m	-	473m
2	2	8M	83.8u	1.235m	-	19m
3	2	13M	96.3u	1.074m	-	159m
4	1	9M	83.8u	-	-	367m
5	2	13M	89.4u	1.901m	-	47m
6	2	6M	57.5u	1.488m	-	485m
7	2	15M	70.9u	1.364m	-	296m
8	1	9M	73.9u	-	-	546m
9	2	13M	74.8u	1.409m	-	83m
10	2	8M	64.6u	1.457m	-	75m
11	3	11M	97.7u	1.79m	1.027m	258m
12	2	5M	64.5u	1.597m	-	336m
13	2	20M	71.6u	0.936m	-	342m
14	1	5M	69.9u	-	-	372m
15	2	5M	74.4u	1.229m	-	19m
16	2	13M	59.7u	1.818m	-	67m
17	3	15M	58.8u	1.553m	1.809m	567m
18	2	20M	97.3u	1.39m	-	381m



A D T

Long Pulse Radar Test Signal						
Test Signal Name: LP_Signal_20						
Number of Bursts in Trial: 20						
Burst	Pulses per Burst	Chrip (Hz)	Pulse Width (s)	Pulse 1 to 2 Spacing (s)	Pulse 2 to 3 Spacing (s)	Start Location (s)
1	1	10M	56.6u	-	-	542m
2	1	6M	61.6u	-	-	384m
3	3	8M	97.5u	1.135m	1.695m	153m
4	2	6M	73.3u	1.349m	-	238m
5	1	9M	96.3u	-	-	532m
6	2	7M	98.4u	1.154m	-	580m
7	2	20M	82.1u	1.496m	-	537m
8	2	11M	99.2u	1.673m	-	504m
9	1	20M	92.8u	-	-	559m
10	1	13M	74.3u	-	-	323m
11	1	17M	73.7u	-	-	0m
12	2	10M	61.8u	1.481m	-	312m
13	1	17M	59.6u	-	-	344m
14	2	5M	97.3u	1.255m	-	203m
15	1	15M	77.1u	-	-	244m
16	3	12M	73.9u	1.406m	1.447m	391m
17	2	13M	83.5u	1.143m	-	401m
18	3	6M	86.7u	1.195m	0.973m	512m
19	1	6M	93.1u	-	-	108m
20	1	15M	50.6u	-	-	135m

Long Pulse Radar Test Signal						
Test Signal Name: LP_Signal_21						
Number of Bursts in Trial: 9						
Burst	Pulses per Burst	Chrip (Hz)	Pulse Width (s)	Pulse 1 to 2 Spacing (s)	Pulse 2 to 3 Spacing (s)	Start Location (s)
1	2	5M	76.8u	1.83m	-	63m
2	2	7M	85.5u	1.836m	-	474m
3	1	12M	52.4u	-	-	1319m
4	1	6M	70.1u	-	-	748m
5	2	13M	65.5u	1.558m	-	197m
6	3	19M	68.9u	1.742m	1.849m	634m
7	2	13M	75.4u	1.896m	-	563m
8	3	6M	55.9u	0.973m	1.273m	1047m
9	1	13M	59.2u	-	-	1277m



A D T

Long Pulse Radar Test Signal						
Test Signal Name: LP_Signal_22						
Number of Bursts in Trial: 11						
Burst	Pulses per Burst	Chrip (Hz)	Pulse Width (s)	Pulse 1 to 2 Spacing (s)	Pulse 2 to 3 Spacing (s)	Start Location (s)
1	3	17M	55.4u	1.013m	1.262m	59m
2	1	15M	85.5u	-	-	631m
3	2	20M	74.1u	1.853m	-	685m
4	1	14M	68.2u	-	-	677m
5	2	14M	87.3u	1.314m	-	567m
6	2	20M	65.9u	1.071m	-	448m
7	2	19M	93.2u	1.339m	-	602m
8	2	15M	99.3u	1.313m	-	133m
9	2	18M	65.9u	0.985m	-	1002m
10	1	13M	64.6u	-	-	343m
11	2	14M	57.6u	1.412m	-	96m

Long Pulse Radar Test Signal						
Test Signal Name: LP_Signal_23						
Number of Bursts in Trial: 13						
Burst	Pulses per Burst	Chrip (Hz)	Pulse Width (s)	Pulse 1 to 2 Spacing (s)	Pulse 2 to 3 Spacing (s)	Start Location (s)
1	2	15M	58.1u	1.75m	-	82m
2	3	9M	68.5u	1.552m	1.481m	119m
3	3	8M	94.1u	1.51m	1.493m	325m
4	3	19M	53.6u	1.027m	1.489m	677m
5	2	19M	60.8u	1.227m	-	897m
6	1	6M	64.6u	-	-	746m
7	1	12M	85.7u	-	-	783m
8	2	10M	52.1u	1.087m	-	283m
9	3	13M	82.9u	1.309m	1.865m	144m
10	2	17M	89u	1.62m	-	176m
11	2	10M	89.9u	1.489m	-	569m
12	2	5M	91.3u	1.561m	-	707m
13	2	11M	55.7u	1.237m	-	678m



A D T

Long Pulse Radar Test Signal
Test Signal Name: LP_Signal_24
Number of Bursts in Trial: 15

Burst	Pulses per Burst	Chrip (Hz)	Pulse Width (s)	Pulse 1 to 2 Spacing (s)	Pulse 2 to 3 Spacing (s)	Start Location (s)
1	2	20M	74.1u	0.941m	-	202m
2	1	7M	70.6u	-	-	666m
3	1	10M	52.4u	-	-	733m
4	3	8M	96.8u	1.497m	1.771m	575m
5	1	14M	70.1u	-	-	225m
6	2	10M	82.8u	1.612m	-	113m
7	2	18M	80.8u	1.03m	-	551m
8	3	6M	76.4u	0.958m	1.191m	206m
9	2	20M	74.7u	1.094m	-	639m
10	2	13M	74.7u	1.655m	-	564m
11	3	8M	58.5u	1.335m	1.439m	430m
12	2	11M	93.5u	1.454m	-	632m
13	2	10M	70.5u	1.169m	-	679m
14	1	5M	92.1u	-	-	708m
15	1	13M	72.6u	-	-	548m



A D T

Long Pulse Radar Test Signal
Test Signal Name: LP_Signal_25
Number of Bursts in Trial: 16

Burst	Pulses per Burst	Chrip (Hz)	Pulse Width (s)	Pulse 1 to 2 Spacing (s)	Pulse 2 to 3 Spacing (s)	Start Location (s)
1	1	18M	59.8u	-	-	315m
2	1	12M	53.6u	-	-	685m
3	3	18M	78.7u	0.931m	1.083m	714m
4	2	10M	66.2u	1.173m	-	285m
5	2	8M	56.1u	1.552m	-	641m
6	3	9M	87.6u	1.221m	1.291m	411m
7	2	12M	67.7u	1.808m	-	43m
8	1	19M	63.3u	-	-	732m
9	2	15M	99.9u	1.764m	-	11m
10	3	20M	78.6u	0.934m	1.324m	203m
11	2	15M	69.8u	1.276m	-	537m
12	2	7M	68u	0.958m	-	657m
13	2	13M	70.8u	1.76m	-	317m
14	2	19M	78.7u	1.441m	-	460m
15	2	13M	92.5u	1.189m	-	570m
16	2	6M	57.3u	1.275m	-	195m



A D T

Long Pulse Radar Test Signal
Test Signal Name: LP_Signal_26
Number of Bursts in Trial: 17

Burst	Pulses per Burst	Chrip (Hz)	Pulse Width (s)	Pulse 1 to 2 Spacing (s)	Pulse 2 to 3 Spacing (s)	Start Location (s)
1	2	13M	87u	0.939m	-	384m
2	1	17M	67.7u	-	-	144m
3	2	8M	63.7u	1.328m	-	246m
4	2	5M	86u	1.437m	-	676m
5	2	11M	86.2u	0.953m	-	277m
6	1	13M	73.1u	-	-	389m
7	3	7M	61.2u	1.536m	1.434m	549m
8	1	13M	98.6u	-	-	352m
9	2	10M	90.8u	1.273m	-	229m
10	2	12M	70.6u	1.466m	-	43m
11	2	8M	53.7u	1.485m	-	296m
12	3	13M	51.4u	1.554m	1.9m	657m
13	2	14M	75.2u	1.505m	-	339m
14	1	19M	71.6u	-	-	413m
15	1	10M	94.8u	-	-	436m
16	1	20M	91.4u	-	-	400m
17	2	20M	80.2u	1.244m	-	385m



A D T

Long Pulse Radar Test Signal
Test Signal Name: LP_Signal_27
Number of Bursts in Trial: 18

Burst	Pulses per Burst	Chrip (Hz)	Pulse Width (s)	Pulse 1 to 2 Spacing (s)	Pulse 2 to 3 Spacing (s)	Start Location (s)
1	3	12M	80.9u	1.883m	1.573m	53m
2	3	15M	94.1u	1.682m	1.577m	101m
3	2	5M	96.4u	1.442m	-	40m
4	2	8M	96.6u	1.552m	-	173m
5	2	7M	90.1u	1.038m	-	597m
6	3	20M	78.7u	1.911m	1.856m	612m
7	1	12M	81.1u	-	-	610m
8	2	11M	66.1u	1.693m	-	67m
9	2	6M	85.8u	1.827m	-	193m
10	2	14M	50.7u	1.124m	-	107m
11	1	5M	85.3u	-	-	565m
12	3	5M	75u	1.169m	1.563m	128m
13	2	18M	58.4u	1.869m	0m	53m
14	3	20M	66.5u	1.476m	1.54m	487m
15	2	15M	96.5u	1.597m	-	537m
16	1	14M	81.1u	-	-	612m
17	1	19M	98.7u	-	-	435m
18	1	20M	51.8u	-	-	628m



A D T

Long Pulse Radar Test Signal
Test Signal Name: LP_Signal_28
Number of Bursts in Trial: 19

Burst	Pulses per Burst	Chrip (Hz)	Pulse Width (s)	Pulse 1 to 2 Spacing (s)	Pulse 2 to 3 Spacing (s)	Start Location (s)
1	2	18M	56.2u	1.863m	-	511m
2	2	6M	64.4u	1.234m	-	620m
3	1	10M	83.3u	-	-	613m
4	1	9M	99.3u	-	-	476m
5	2	20M	80.1u	1.615m	-	584m
6	2	13M	82u	0.971m	-	467m
7	2	10M	79.6u	0.949m	-	430m
8	2	13M	69.5u	1.26m	-	357m
9	3	20M	92u	1.801m	0.995m	165m
10	2	9M	97.1u	1.74m	-	456m
11	2	8M	98.9u	1.427m	-	17m
12	3	18M	77.9u	1.797m	1.319m	269m
13	1	18M	90.4u	-	-	203m
14	3	5M	90u	1.897m	1.544m	295m
15	2	15M	67.1u	1.31m	-	554m
16	3	10M	71.9u	1.63m	1.633m	66m
17	3	18M	61.1u	1.256m	1.263m	573m
18	2	13M	95.9u	1.803m	-	215m
19	3	18M	88u	0.99m	1.152m	234m



A D T

Long Pulse Radar Test Signal
Test Signal Name: LP_Signal_29
Number of Bursts in Trial: 20

Burst	Pulses per Burst	Chrip (Hz)	Pulse Width (s)	Pulse 1 to 2 Spacing (s)	Pulse 2 to 3 Spacing (s)	Start Location (s)
1	3	13M	54.7u	0.986m	1.475m	121m
2	1	14M	91.8u	-	-	109m
3	3	6M	72.8u	1.282m	1.174m	476m
4	2	13M	79.2u	1.821m	-	425m
5	3	10M	52.3u	1.232m	1.89m	225m
6	1	20M	70u	-	-	222m
7	2	19M	55.9u	1.901m	-	452m
8	3	13M	83.7u	1.2m	1.221m	152m
9	1	13M	83.4u	-	-	397m
10	3	18M	67u	1.698m	1.315m	142m
11	3	14M	65.1u	1.5m	1.212m	272m
12	1	11M	54.1u	-	-	570m
13	1	11M	73.2u	-	-	12m
14	2	14M	73.1u	1.336m	-	149m
15	2	8M	75.3u	1.18m	-	103m
16	2	20M	50.3u	1.197m	-	183m
17	2	13M	81.3u	0.969m	-	368m
18	1	20M	97.9u	-	-	332m
19	2	14M	91.2u	1.048m	-	57m
20	2	12M	62.1u	1.604m	-	89m



A D T

Long Pulse Radar Test Signal
Test Signal Name: LP_Signal_30
Number of Bursts in Trial: 10

Burst	Pulses per Burst	Chrip (Hz)	Pulse Width (s)	Pulse 1 to 2 Spacing (s)	Pulse 2 to 3 Spacing (s)	Start Location (s)
1	1	13M	74.4u	-	-	277m
2	2	12M	84.2u	1.131m	-	832m
3	2	11M	55.9u	1.24m	-	790m
4	1	11M	64.7u	-	-	190m
5	2	13M	60.4u	0.949m	-	519m
6	2	9M	66u	1.046m	-	375m
7	2	5M	63.8u	1.721m	-	240m
8	1	10M	87.3u	-	-	583m
9	2	14M	97.6u	1.473m	-	548m
10	1	17M	99u	-	-	896m
11	1	12M	65.5u	-	-	246m
12	1	10M	57.5u	-	-	464m
13	2	12M	88.2u	1.403m	-	878m



A D T

Hopping Frequency Sequence Name: HOP_FREQ_SEQ_01

SEQ#	Frequency (Hz)	SEQ#	Frequency (Hz)	SEQ#	Frequency (Hz)	SEQ#	Frequency (Hz)
1	5.375G	2	5.350G	3	5.537G	4	5.429G
5	5.588G	6	5.630G	7	5.709G	8	5.607G
9	5.615G	10	5.386G	11	5.395G	12	5.531G
13	5.597G	14	5.300G	15	5.475G	16	5.721G
17	5.297G	18	5.412G	19	5.560G	20	5.674G
21	5.434G	22	5.611G	23	5.397G	24	5.487G
25	5.440G	26	5.645G	27	5.405G	28	5.643G
29	5.540G	30	5.401G	31	5.418G	32	5.298G
33	5.345G	34	5.290G	35	5.632G	36	5.456G
37	5.301G	38	5.578G	39	5.341G	40	5.714G
41	5.668G	42	5.305G	43	5.717G	44	5.317G
45	5.378G	46	5.640G	47	5.332G	48	5.711G
49	5.439G	50	5.454G	51	5.690G	52	5.653G
53	5.564G	54	5.295G	55	5.415G	56	5.263G
57	5.329G	58	5.552G	59	5.589G	60	5.428G
61	5.417G	62	5.385G	63	5.634G	64	5.536G
65	5.593G	66	5.330G	67	5.606G	68	5.265G
69	5.281G	70	5.406G	71	5.636G	72	5.320G
73	5.601G	74	5.525G	75	5.485G	76	5.496G
77	5.369G	78	5.678G	79	5.574G	80	5.699G
81	5.514G	82	5.720G	83	5.679G	84	5.359G
85	5.381G	86	5.374G	87	5.539G	88	5.670G
89	5.464G	90	5.530G	91	5.259G	92	5.448G
93	5.432G	94	5.404G	95	5.571G	96	5.551G
97	5.622G	98	5.503G	99	5.580G	100	5.623G



A D T

Hopping Frequency Sequence Name: HOP_FREQ_SEQ_02

SEQ#	Frequency (Hz)	SEQ#	Frequency (Hz)	SEQ#	Frequency (Hz)	SEQ#	Frequency (Hz)
1	5.430G	2	5.504G	3	5.460G	4	5.715G
5	5.550G	6	5.445G	7	5.645G	8	5.387G
9	5.297G	10	5.388G	11	5.670G	12	5.526G
13	5.618G	14	5.688G	15	5.523G	16	5.707G
17	5.381G	18	5.431G	19	5.609G	20	5.702G
21	5.710G	22	5.411G	23	5.628G	24	5.438G
25	5.414G	26	5.443G	27	5.623G	28	5.432G
29	5.257G	30	5.499G	31	5.630G	32	5.586G
33	5.266G	34	5.677G	35	5.290G	36	5.552G
37	5.485G	38	5.402G	39	5.650G	40	5.624G
41	5.451G	42	5.488G	43	5.513G	44	5.283G
45	5.433G	46	5.310G	47	5.380G	48	5.556G
49	5.512G	50	5.508G	51	5.269G	52	5.477G
53	5.580G	54	5.489G	55	5.329G	56	5.436G
57	5.683G	58	5.357G	59	5.360G	60	5.263G
61	5.617G	62	5.415G	63	5.275G	64	5.337G
65	5.377G	66	5.425G	67	5.698G	68	5.446G
69	5.549G	70	5.256G	71	5.553G	72	5.519G
73	5.334G	74	5.480G	75	5.394G	76	5.404G
77	5.319G	78	5.475G	79	5.459G	80	5.554G
81	5.711G	82	5.522G	83	5.268G	84	5.718G
85	5.453G	86	5.594G	87	5.482G	88	5.312G
89	5.627G	90	5.306G	91	5.264G	92	5.662G
93	5.463G	94	5.576G	95	5.561G	96	5.392G
97	5.267G	98	5.311G	99	5.547G	100	5.604G



A D T

Hopping Frequency Sequence Name: HOP_FREQ_SEQ_03

SEQ#	Frequency (Hz)	SEQ#	Frequency (Hz)	SEQ#	Frequency (Hz)	SEQ#	Frequency (Hz)
1	5.422G	2	5.483G	3	5.430G	4	5.441G
5	5.406G	6	5.624G	7	5.553G	8	5.292G
9	5.705G	10	5.334G	11	5.325G	12	5.429G
13	5.540G	14	5.600G	15	5.386G	16	5.515G
17	5.658G	18	5.561G	19	5.267G	20	5.333G
21	5.465G	22	5.470G	23	5.355G	24	5.307G
25	5.661G	26	5.688G	27	5.656G	28	5.535G
29	5.518G	30	5.388G	31	5.693G	32	5.338G
33	5.719G	34	5.274G	35	5.667G	36	5.717G
37	5.530G	38	5.684G	39	5.611G	40	5.512G
41	5.627G	42	5.517G	43	5.678G	44	5.598G
45	5.545G	46	5.573G	47	5.698G	48	5.504G
49	5.718G	50	5.544G	51	5.692G	52	5.391G
53	5.721G	54	5.567G	55	5.374G	56	5.716G
57	5.319G	58	5.642G	59	5.385G	60	5.255G
61	5.264G	62	5.445G	63	5.260G	64	5.566G
65	5.256G	66	5.593G	67	5.579G	68	5.364G
69	5.289G	70	5.612G	71	5.384G	72	5.341G
73	5.383G	74	5.715G	75	5.546G	76	5.250G
77	5.291G	78	5.257G	79	5.331G	80	5.674G
81	5.621G	82	5.452G	83	5.413G	84	5.702G
85	5.711G	86	5.575G	87	5.451G	88	5.637G
89	5.662G	90	5.657G	91	5.378G	92	5.411G
93	5.358G	94	5.426G	95	5.592G	96	5.699G
97	5.610G	98	5.668G	99	5.555G	100	5.332G



A D T

Hopping Frequency Sequence Name: HOP_FREQ_SEQ_04

SEQ#	Frequency (Hz)	SEQ#	Frequency (Hz)	SEQ#	Frequency (Hz)	SEQ#	Frequency (Hz)
1	5.624G	2	5.432G	3	5.409G	4	5.721G
5	5.685G	6	5.368G	7	5.253G	8	5.450G
9	5.378G	10	5.361G	11	5.330G	12	5.254G
13	5.564G	14	5.252G	15	5.640G	16	5.494G
17	5.439G	18	5.465G	19	5.476G	20	5.382G
21	5.397G	22	5.567G	23	5.578G	24	5.538G
25	5.250G	26	5.591G	27	5.531G	28	5.703G
29	5.699G	30	5.276G	31	5.575G	32	5.400G
33	5.285G	34	5.629G	35	5.308G	36	5.542G
37	5.714G	38	5.296G	39	5.560G	40	5.394G
41	5.387G	42	5.481G	43	5.440G	44	5.429G
45	5.552G	46	5.697G	47	5.724G	48	5.483G
49	5.600G	50	5.668G	51	5.369G	52	5.712G
53	5.696G	54	5.503G	55	5.637G	56	5.445G
57	5.456G	58	5.334G	59	5.665G	60	5.659G
61	5.601G	62	5.541G	63	5.707G	64	5.499G
65	5.583G	66	5.422G	67	5.303G	68	5.356G
69	5.302G	70	5.479G	71	5.620G	72	5.587G
73	5.335G	74	5.550G	75	5.331G	76	5.458G
77	5.618G	78	5.636G	79	5.305G	80	5.520G
81	5.454G	82	5.304G	83	5.348G	84	5.314G
85	5.627G	86	5.510G	87	5.284G	88	5.373G
89	5.594G	90	5.599G	91	5.525G	92	5.532G
93	5.364G	94	5.437G	95	5.319G	96	5.405G
97	5.598G	98	5.266G	99	5.654G	100	5.370G



A D T

Hopping Frequency Sequence Name: HOP_FREQ_SEQ_05

SEQ#	Frequency (Hz)	SEQ#	Frequency (Hz)	SEQ#	Frequency (Hz)	SEQ#	Frequency (Hz)
1	5.250G	2	5.611G	3	5.718G	4	5.672G
5	5.519G	6	5.566G	7	5.565G	8	5.426G
9	5.678G	10	5.449G	11	5.505G	12	5.608G
13	5.597G	14	5.430G	15	5.564G	16	5.431G
17	5.310G	18	5.283G	19	5.434G	20	5.629G
21	5.690G	22	5.405G	23	5.722G	24	5.582G
25	5.494G	26	5.497G	27	5.347G	28	5.578G
29	5.495G	30	5.270G	31	5.259G	32	5.401G
33	5.393G	34	5.635G	35	5.715G	36	5.575G
37	5.507G	38	5.311G	39	5.542G	40	5.482G
41	5.523G	42	5.386G	43	5.634G	44	5.344G
45	5.277G	46	5.654G	47	5.532G	48	5.636G
49	5.313G	50	5.370G	51	5.374G	52	5.640G
53	5.624G	54	5.559G	55	5.512G	56	5.391G
57	5.341G	58	5.649G	59	5.255G	60	5.657G
61	5.681G	62	5.577G	63	5.613G	64	5.424G
65	5.271G	66	5.335G	67	5.406G	68	5.444G
69	5.536G	70	5.579G	71	5.432G	72	5.315G
73	5.398G	74	5.307G	75	5.489G	76	5.274G
77	5.439G	78	5.358G	79	5.682G	80	5.256G
81	5.440G	82	5.327G	83	5.619G	84	5.616G
85	5.272G	86	5.585G	87	5.568G	88	5.339G
89	5.375G	90	5.661G	91	5.463G	92	5.527G
93	5.502G	94	5.404G	95	5.447G	96	5.670G
97	5.436G	98	5.388G	99	5.366G	100	5.389G



A D T

Hopping Frequency Sequence Name: HOP_FREQ_SEQ_06

SEQ#	Frequency (Hz)	SEQ#	Frequency (Hz)	SEQ#	Frequency (Hz)	SEQ#	Frequency (Hz)
1	5.290G	2	5.671G	3	5.334G	4	5.490G
5	5.471G	6	5.442G	7	5.461G	8	5.365G
9	5.287G	10	5.604G	11	5.482G	12	5.360G
13	5.642G	14	5.677G	15	5.514G	16	5.353G
17	5.576G	18	5.637G	19	5.617G	20	5.723G
21	5.675G	22	5.311G	23	5.487G	24	5.551G
25	5.250G	26	5.280G	27	5.644G	28	5.615G
29	5.521G	30	5.292G	31	5.393G	32	5.679G
33	5.574G	34	5.607G	35	5.619G	36	5.708G
37	5.668G	38	5.646G	39	5.443G	40	5.697G
41	5.689G	42	5.688G	43	5.251G	44	5.271G
45	5.446G	46	5.337G	47	5.269G	48	5.355G
49	5.426G	50	5.325G	51	5.463G	52	5.445G
53	5.447G	54	5.614G	55	5.400G	56	5.357G
57	5.323G	58	5.350G	59	5.583G	60	5.718G
61	5.684G	62	5.411G	63	5.584G	64	5.716G
65	5.432G	66	5.567G	67	5.453G	68	5.408G
69	5.421G	70	5.282G	71	5.466G	72	5.717G
73	5.441G	74	5.618G	75	5.259G	76	5.603G
77	5.516G	78	5.485G	79	5.258G	80	5.364G
81	5.253G	82	5.279G	83	5.517G	84	5.452G
85	5.685G	86	5.327G	87	5.527G	88	5.611G
89	5.462G	90	5.719G	91	5.257G	92	5.451G
93	5.464G	94	5.303G	95	5.662G	96	5.252G
97	5.621G	98	5.379G	99	5.695G	100	5.440G



A D T

Hopping Frequency Sequence Name: HOP_FREQ_SEQ_07

SEQ#	Frequency (Hz)	SEQ#	Frequency (Hz)	SEQ#	Frequency (Hz)	SEQ#	Frequency (Hz)
1	5.566G	2	5.590G	3	5.699G	4	5.654G
5	5.423G	6	5.671G	7	5.623G	8	5.466G
9	5.621G	10	5.404G	11	5.367G	12	5.526G
13	5.480G	14	5.292G	15	5.343G	16	5.273G
17	5.640G	18	5.296G	19	5.596G	20	5.339G
21	5.417G	22	5.568G	23	5.585G	24	5.382G
25	5.597G	26	5.524G	27	5.684G	28	5.416G
29	5.589G	30	5.444G	31	5.313G	32	5.253G
33	5.452G	34	5.707G	35	5.539G	36	5.279G
37	5.646G	38	5.459G	39	5.401G	40	5.294G
41	5.357G	42	5.697G	43	5.312G	44	5.675G
45	5.573G	46	5.587G	47	5.254G	48	5.358G
49	5.632G	50	5.530G	51	5.479G	52	5.668G
53	5.322G	54	5.543G	55	5.691G	56	5.460G
57	5.354G	58	5.648G	59	5.355G	60	5.455G
61	5.265G	62	5.482G	63	5.595G	64	5.657G
65	5.344G	66	5.462G	67	5.437G	68	5.614G
69	5.581G	70	5.516G	71	5.506G	72	5.264G
73	5.708G	74	5.394G	75	5.282G	76	5.510G
77	5.696G	78	5.332G	79	5.680G	80	5.703G
81	5.564G	82	5.353G	83	5.660G	84	5.341G
85	5.638G	86	5.287G	87	5.315G	88	5.569G
89	5.392G	90	5.486G	91	5.421G	92	5.398G
93	5.370G	94	5.373G	95	5.650G	96	5.721G
97	5.352G	98	5.299G	99	5.384G	100	5.266G



A D T

Hopping Frequency Sequence Name: HOP_FREQ_SEQ_08

SEQ#	Frequency (Hz)	SEQ#	Frequency (Hz)	SEQ#	Frequency (Hz)	SEQ#	Frequency (Hz)
1	5.370G	2	5.716G	3	5.450G	4	5.713G
5	5.672G	6	5.516G	7	5.351G	8	5.545G
9	5.526G	10	5.704G	11	5.655G	12	5.362G
13	5.539G	14	5.405G	15	5.547G	16	5.532G
17	5.693G	18	5.338G	19	5.392G	20	5.389G
21	5.388G	22	5.576G	23	5.564G	24	5.514G
25	5.355G	26	5.578G	27	5.317G	28	5.654G
29	5.500G	30	5.479G	31	5.323G	32	5.297G
33	5.324G	34	5.318G	35	5.430G	36	5.546G
37	5.395G	38	5.721G	39	5.463G	40	5.710G
41	5.705G	42	5.490G	43	5.290G	44	5.524G
45	5.606G	46	5.321G	47	5.364G	48	5.435G
49	5.373G	50	5.254G	51	5.311G	52	5.699G
53	5.587G	54	5.431G	55	5.403G	56	5.406G
57	5.382G	58	5.305G	59	5.593G	60	5.459G
61	5.628G	62	5.268G	63	5.697G	64	5.688G
65	5.685G	66	5.691G	67	5.385G	68	5.503G
69	5.683G	70	5.277G	71	5.447G	72	5.334G
73	5.263G	74	5.497G	75	5.402G	76	5.645G
77	5.678G	78	5.433G	79	5.276G	80	5.575G
81	5.279G	82	5.562G	83	5.549G	84	5.614G
85	5.622G	86	5.581G	87	5.411G	88	5.296G
89	5.711G	90	5.722G	91	5.295G	92	5.621G
93	5.292G	94	5.566G	95	5.504G	96	5.718G
97	5.397G	98	5.368G	99	5.425G	100	5.307G



A D T

Hopping Frequency Sequence Name: HOP_FREQ_SEQ_09

SEQ#	Frequency (Hz)	SEQ#	Frequency (Hz)	SEQ#	Frequency (Hz)	SEQ#	Frequency (Hz)
1	5.449G	2	5.485G	3	5.671G	4	5.666G
5	5.578G	6	5.643G	7	5.287G	8	5.598G
9	5.320G	10	5.570G	11	5.518G	12	5.692G
13	5.486G	14	5.440G	15	5.681G	16	5.346G
17	5.504G	18	5.482G	19	5.694G	20	5.704G
21	5.438G	22	5.543G	23	5.582G	24	5.305G
25	5.723G	26	5.698G	27	5.308G	28	5.527G
29	5.336G	30	5.373G	31	5.670G	32	5.416G
33	5.379G	34	5.488G	35	5.624G	36	5.338G
37	5.585G	38	5.502G	39	5.382G	40	5.524G
41	5.469G	42	5.641G	43	5.633G	44	5.591G
45	5.265G	46	5.597G	47	5.696G	48	5.271G
49	5.278G	50	5.378G	51	5.370G	52	5.625G
53	5.425G	54	5.703G	55	5.408G	56	5.350G
57	5.693G	58	5.540G	59	5.626G	60	5.435G
61	5.384G	62	5.688G	63	5.460G	64	5.722G
65	5.636G	66	5.711G	67	5.429G	68	5.535G
69	5.593G	70	5.567G	71	5.255G	72	5.342G
73	5.615G	74	5.546G	75	5.352G	76	5.622G
77	5.418G	78	5.619G	79	5.296G	80	5.655G
81	5.522G	82	5.385G	83	5.562G	84	5.479G
85	5.490G	86	5.637G	87	5.678G	88	5.422G
89	5.493G	90	5.483G	91	5.611G	92	5.559G
93	5.695G	94	5.714G	95	5.380G	96	5.293G
97	5.580G	98	5.668G	99	5.399G	100	5.383G



A D T

Hopping Frequency Sequence Name: HOP_FREQ_SEQ_10

SEQ#	Frequency (Hz)	SEQ#	Frequency (Hz)	SEQ#	Frequency (Hz)	SEQ#	Frequency (Hz)
1	5.596G	2	5.256G	3	5.442G	4	5.536G
5	5.405G	6	5.615G	7	5.480G	8	5.707G
9	5.701G	10	5.429G	11	5.597G	12	5.445G
13	5.504G	14	5.614G	15	5.354G	16	5.260G
17	5.449G	18	5.416G	19	5.660G	20	5.472G
21	5.500G	22	5.497G	23	5.339G	24	5.537G
25	5.313G	26	5.576G	27	5.443G	28	5.531G
29	5.607G	30	5.519G	31	5.378G	32	5.301G
33	5.593G	34	5.465G	35	5.268G	36	5.261G
37	5.652G	38	5.494G	39	5.451G	40	5.377G
41	5.365G	42	5.695G	43	5.668G	44	5.606G
45	5.664G	46	5.540G	47	5.306G	48	5.452G
49	5.360G	50	5.394G	51	5.619G	52	5.302G
53	5.356G	54	5.523G	55	5.696G	56	5.283G
57	5.298G	58	5.630G	59	5.399G	60	5.712G
61	5.533G	62	5.317G	63	5.632G	64	5.390G
65	5.485G	66	5.512G	67	5.645G	68	5.279G
69	5.653G	70	5.560G	71	5.572G	72	5.592G
73	5.402G	74	5.380G	75	5.352G	76	5.588G
77	5.372G	78	5.366G	79	5.287G	80	5.342G
81	5.400G	82	5.672G	83	5.639G	84	5.376G
85	5.527G	86	5.609G	87	5.461G	88	5.322G
89	5.698G	90	5.577G	91	5.534G	92	5.617G
93	5.476G	94	5.310G	95	5.435G	96	5.307G
97	5.420G	98	5.677G	99	5.264G	100	5.477G



A D T

Hopping Frequency Sequence Name: HOP_FREQ_SEQ_11

SEQ#	Frequency (Hz)	SEQ#	Frequency (Hz)	SEQ#	Frequency (Hz)	SEQ#	Frequency (Hz)
1	5.677G	2	5.546G	3	5.363G	4	5.410G
5	5.657G	6	5.505G	7	5.454G	8	5.287G
9	5.448G	10	5.308G	11	5.270G	12	5.352G
13	5.404G	14	5.288G	15	5.396G	16	5.329G
17	5.637G	18	5.615G	19	5.488G	20	5.651G
21	5.522G	22	5.428G	23	5.644G	24	5.366G
25	5.485G	26	5.399G	27	5.444G	28	5.384G
29	5.709G	30	5.369G	31	5.672G	32	5.594G
33	5.693G	34	5.527G	35	5.283G	36	5.456G
37	5.421G	38	5.306G	39	5.513G	40	5.678G
41	5.282G	42	5.392G	43	5.302G	44	5.626G
45	5.452G	46	5.310G	47	5.323G	48	5.474G
49	5.279G	50	5.297G	51	5.584G	52	5.397G
53	5.324G	54	5.342G	55	5.702G	56	5.469G
57	5.331G	58	5.427G	59	5.640G	60	5.660G
61	5.436G	62	5.322G	63	5.684G	64	5.557G
65	5.708G	66	5.692G	67	5.659G	68	5.263G
69	5.367G	70	5.408G	71	5.387G	72	5.405G
73	5.432G	74	5.353G	75	5.276G	76	5.616G
77	5.554G	78	5.446G	79	5.281G	80	5.670G
81	5.252G	82	5.258G	83	5.704G	84	5.443G
85	5.538G	86	5.630G	87	5.273G	88	5.261G
89	5.535G	90	5.305G	91	5.477G	92	5.537G
93	5.580G	94	5.536G	95	5.567G	96	5.268G
97	5.402G	98	5.449G	99	5.391G	100	5.633G



A D T

Hopping Frequency Sequence Name: HOP_FREQ_SEQ_12

SEQ#	Frequency (Hz)	SEQ#	Frequency (Hz)	SEQ#	Frequency (Hz)	SEQ#	Frequency (Hz)
1	5.692G	2	5.551G	3	5.717G	4	5.480G
5	5.677G	6	5.287G	7	5.611G	8	5.398G
9	5.656G	10	5.385G	11	5.277G	12	5.603G
13	5.615G	14	5.581G	15	5.433G	16	5.576G
17	5.503G	18	5.260G	19	5.327G	20	5.545G
21	5.423G	22	5.485G	23	5.360G	24	5.614G
25	5.292G	26	5.537G	27	5.318G	28	5.350G
29	5.429G	30	5.282G	31	5.403G	32	5.587G
33	5.252G	34	5.687G	35	5.681G	36	5.259G
37	5.332G	38	5.434G	39	5.348G	40	5.265G
41	5.628G	42	5.303G	43	5.697G	44	5.365G
45	5.600G	46	5.560G	47	5.486G	48	5.460G
49	5.544G	50	5.302G	51	5.638G	52	5.408G
53	5.654G	54	5.580G	55	5.719G	56	5.720G
57	5.321G	58	5.499G	59	5.375G	60	5.451G
61	5.667G	62	5.686G	63	5.540G	64	5.696G
65	5.554G	66	5.394G	67	5.662G	68	5.716G
69	5.416G	70	5.272G	71	5.418G	72	5.607G
73	5.702G	74	5.472G	75	5.531G	76	5.558G
77	5.358G	78	5.406G	79	5.564G	80	5.326G
81	5.661G	82	5.694G	83	5.596G	84	5.432G
85	5.639G	86	5.629G	87	5.317G	88	5.363G
89	5.288G	90	5.583G	91	5.396G	92	5.701G
93	5.449G	94	5.315G	95	5.724G	96	5.640G
97	5.471G	98	5.646G	99	5.335G	100	5.414G



A D T

Hopping Frequency Sequence Name: HOP_FREQ_SEQ_13

SEQ#	Frequency (Hz)	SEQ#	Frequency (Hz)	SEQ#	Frequency (Hz)	SEQ#	Frequency (Hz)
1	5.688G	2	5.349G	3	5.609G	4	5.371G
5	5.589G	6	5.586G	7	5.409G	8	5.360G
9	5.551G	10	5.442G	11	5.657G	12	5.628G
13	5.481G	14	5.253G	15	5.692G	16	5.546G
17	5.672G	18	5.336G	19	5.364G	20	5.344G
21	5.440G	22	5.465G	23	5.645G	24	5.433G
25	5.538G	26	5.640G	27	5.421G	28	5.305G
29	5.295G	30	5.424G	31	5.535G	32	5.324G
33	5.316G	34	5.549G	35	5.261G	36	5.579G
37	5.321G	38	5.444G	39	5.329G	40	5.414G
41	5.694G	42	5.386G	43	5.673G	44	5.455G
45	5.262G	46	5.621G	47	5.713G	48	5.644G
49	5.294G	50	5.663G	51	5.273G	52	5.704G
53	5.485G	54	5.580G	55	5.462G	56	5.633G
57	5.276G	58	5.373G	59	5.398G	60	5.668G
61	5.646G	62	5.370G	63	5.709G	64	5.357G
65	5.541G	66	5.266G	67	5.583G	68	5.356G
69	5.681G	70	5.655G	71	5.578G	72	5.406G
73	5.445G	74	5.504G	75	5.700G	76	5.610G
77	5.304G	78	5.413G	79	5.301G	80	5.269G
81	5.417G	82	5.388G	83	5.447G	84	5.319G
85	5.394G	86	5.662G	87	5.677G	88	5.650G
89	5.454G	90	5.488G	91	5.616G	92	5.683G
93	5.293G	94	5.419G	95	5.315G	96	5.612G
97	5.439G	98	5.620G	99	5.510G	100	5.607G



A D T

Hopping Frequency Sequence Name: HOP_FREQ_SEQ_14

SEQ#	Frequency (Hz)	SEQ#	Frequency (Hz)	SEQ#	Frequency (Hz)	SEQ#	Frequency (Hz)
1	5.451G	2	5.652G	3	5.629G	4	5.575G
5	5.333G	6	5.608G	7	5.457G	8	5.412G
9	5.489G	10	5.712G	11	5.670G	12	5.322G
13	5.710G	14	5.686G	15	5.467G	16	5.666G
17	5.606G	18	5.471G	19	5.632G	20	5.396G
21	5.306G	22	5.722G	23	5.388G	24	5.264G
25	5.642G	26	5.393G	27	5.311G	28	5.336G
29	5.595G	30	5.588G	31	5.313G	32	5.625G
33	5.381G	34	5.346G	35	5.360G	36	5.603G
37	5.429G	38	5.366G	39	5.571G	40	5.312G
41	5.464G	42	5.605G	43	5.582G	44	5.522G
45	5.265G	46	5.447G	47	5.269G	48	5.455G
49	5.664G	50	5.676G	51	5.615G	52	5.359G
53	5.440G	54	5.651G	55	5.435G	56	5.287G
57	5.345G	58	5.696G	59	5.387G	60	5.680G
61	5.688G	62	5.690G	63	5.589G	64	5.383G
65	5.353G	66	5.573G	67	5.720G	68	5.508G
69	5.463G	70	5.420G	71	5.552G	72	5.636G
73	5.592G	74	5.501G	75	5.609G	76	5.481G
77	5.475G	78	5.494G	79	5.477G	80	5.442G
81	5.576G	82	5.620G	83	5.479G	84	5.268G
85	5.622G	86	5.506G	87	5.257G	88	5.254G
89	5.693G	90	5.669G	91	5.566G	92	5.279G
93	5.280G	94	5.252G	95	5.317G	96	5.290G
97	5.273G	98	5.503G	99	5.318G	100	5.341G



A D T

Hopping Frequency Sequence Name: HOP_FREQ_SEQ_15

SEQ#	Frequency (Hz)	SEQ#	Frequency (Hz)	SEQ#	Frequency (Hz)	SEQ#	Frequency (Hz)
1	5.290G	2	5.631G	3	5.588G	4	5.635G
5	5.634G	6	5.343G	7	5.509G	8	5.637G
9	5.362G	10	5.608G	11	5.401G	12	5.429G
13	5.652G	14	5.651G	15	5.615G	16	5.577G
17	5.633G	18	5.641G	19	5.602G	20	5.527G
21	5.355G	22	5.286G	23	5.610G	24	5.625G
25	5.710G	26	5.644G	27	5.360G	28	5.305G
29	5.525G	30	5.638G	31	5.629G	32	5.253G
33	5.543G	34	5.327G	35	5.260G	36	5.624G
37	5.425G	38	5.646G	39	5.280G	40	5.622G
41	5.489G	42	5.504G	43	5.645G	44	5.337G
45	5.463G	46	5.308G	47	5.338G	48	5.273G
49	5.552G	50	5.661G	51	5.667G	52	5.419G
53	5.346G	54	5.581G	55	5.388G	56	5.354G
57	5.451G	58	5.668G	59	5.287G	60	5.410G
61	5.689G	62	5.559G	63	5.267G	64	5.514G
65	5.414G	66	5.339G	67	5.402G	68	5.341G
69	5.450G	70	5.535G	71	5.485G	72	5.271G
73	5.518G	74	5.643G	75	5.364G	76	5.385G
77	5.393G	78	5.279G	79	5.686G	80	5.288G
81	5.422G	82	5.533G	83	5.513G	84	5.511G
85	5.467G	86	5.555G	87	5.415G	88	5.503G
89	5.456G	90	5.561G	91	5.717G	92	5.389G
93	5.587G	94	5.632G	95	5.270G	96	5.505G
97	5.673G	98	5.671G	99	5.421G	100	5.424G



A D T

Hopping Frequency Sequence Name: HOP_FREQ_SEQ_16

SEQ#	Frequency (Hz)	SEQ#	Frequency (Hz)	SEQ#	Frequency (Hz)	SEQ#	Frequency (Hz)
1	5.435G	2	5.574G	3	5.347G	4	5.630G
5	5.390G	6	5.262G	7	5.361G	8	5.402G
9	5.525G	10	5.430G	11	5.393G	12	5.694G
13	5.469G	14	5.604G	15	5.286G	16	5.310G
17	5.603G	18	5.433G	19	5.522G	20	5.626G
21	5.691G	22	5.510G	23	5.582G	24	5.464G
25	5.474G	26	5.559G	27	5.387G	28	5.645G
29	5.483G	30	5.571G	31	5.670G	32	5.369G
33	5.581G	34	5.642G	35	5.719G	36	5.308G
37	5.275G	38	5.319G	39	5.432G	40	5.677G
41	5.700G	42	5.533G	43	5.656G	44	5.467G
45	5.366G	46	5.396G	47	5.442G	48	5.482G
49	5.690G	50	5.671G	51	5.299G	52	5.460G
53	5.257G	54	5.405G	55	5.452G	56	5.616G
57	5.524G	58	5.305G	59	5.256G	60	5.539G
61	5.647G	62	5.536G	63	5.607G	64	5.359G
65	5.451G	66	5.588G	67	5.269G	68	5.596G
69	5.667G	70	5.444G	71	5.449G	72	5.277G
73	5.628G	74	5.599G	75	5.457G	76	5.354G
77	5.328G	78	5.404G	79	5.344G	80	5.698G
81	5.420G	82	5.349G	83	5.455G	84	5.343G
85	5.292G	86	5.274G	87	5.511G	88	5.385G
89	5.722G	90	5.360G	91	5.284G	92	5.663G
93	5.665G	94	5.414G	95	5.266G	96	5.475G
97	5.703G	98	5.441G	99	5.487G	100	5.493G



A D T

Hopping Frequency Sequence Name: HOP_FREQ_SEQ_17

SEQ#	Frequency (Hz)	SEQ#	Frequency (Hz)	SEQ#	Frequency (Hz)	SEQ#	Frequency (Hz)
1	5.619G	2	5.546G	3	5.402G	4	5.335G
5	5.598G	6	5.668G	7	5.555G	8	5.434G
9	5.253G	10	5.550G	11	5.525G	12	5.609G
13	5.250G	14	5.625G	15	5.324G	16	5.295G
17	5.486G	18	5.461G	19	5.321G	20	5.573G
21	5.331G	22	5.699G	23	5.397G	24	5.672G
25	5.701G	26	5.676G	27	5.364G	28	5.581G
29	5.472G	30	5.664G	31	5.622G	32	5.422G
33	5.570G	34	5.507G	35	5.370G	36	5.317G
37	5.362G	38	5.717G	39	5.334G	40	5.516G
41	5.547G	42	5.554G	43	5.264G	44	5.418G
45	5.452G	46	5.702G	47	5.430G	48	5.300G
49	5.411G	50	5.541G	51	5.512G	52	5.287G
53	5.608G	54	5.343G	55	5.404G	56	5.709G
57	5.359G	58	5.281G	59	5.438G	60	5.595G
61	5.591G	62	5.689G	63	5.607G	64	5.675G
65	5.623G	66	5.436G	67	5.408G	68	5.707G
69	5.720G	70	5.332G	71	5.275G	72	5.646G
73	5.351G	74	5.459G	75	5.513G	76	5.612G
77	5.540G	78	5.303G	79	5.533G	80	5.613G
81	5.583G	82	5.381G	83	5.611G	84	5.569G
85	5.478G	86	5.687G	87	5.344G	88	5.705G
89	5.666G	90	5.552G	91	5.368G	92	5.669G
93	5.462G	94	5.588G	95	5.318G	96	5.614G
97	5.639G	98	5.337G	99	5.415G	100	5.710G



A D T

Hopping Frequency Sequence Name: HOP_FREQ_SEQ_18

SEQ#	Frequency (Hz)	SEQ#	Frequency (Hz)	SEQ#	Frequency (Hz)	SEQ#	Frequency (Hz)
1	5.425G	2	5.273G	3	5.551G	4	5.616G
5	5.544G	6	5.661G	7	5.564G	8	5.331G
9	5.424G	10	5.277G	11	5.362G	12	5.289G
13	5.512G	14	5.274G	15	5.719G	16	5.296G
17	5.600G	18	5.275G	19	5.381G	20	5.430G
21	5.357G	22	5.603G	23	5.688G	24	5.263G
25	5.261G	26	5.606G	27	5.321G	28	5.355G
29	5.426G	30	5.637G	31	5.336G	32	5.462G
33	5.716G	34	5.380G	35	5.524G	36	5.718G
37	5.482G	38	5.648G	39	5.570G	40	5.436G
41	5.613G	42	5.588G	43	5.658G	44	5.579G
45	5.456G	46	5.660G	47	5.690G	48	5.541G
49	5.552G	50	5.646G	51	5.592G	52	5.560G
53	5.439G	54	5.666G	55	5.335G	56	5.382G
57	5.286G	58	5.677G	59	5.268G	60	5.258G
61	5.366G	62	5.583G	63	5.310G	64	5.653G
65	5.450G	66	5.615G	67	5.399G	68	5.440G
69	5.708G	70	5.547G	71	5.663G	72	5.610G
73	5.509G	74	5.536G	75	5.429G	76	5.611G
77	5.337G	78	5.408G	79	5.385G	80	5.481G
81	5.581G	82	5.452G	83	5.576G	84	5.605G
85	5.253G	86	5.252G	87	5.649G	88	5.589G
89	5.279G	90	5.657G	91	5.264G	92	5.532G
93	5.619G	94	5.416G	95	5.566G	96	5.396G
97	5.457G	98	5.503G	99	5.689G	100	5.530G



A D T

Hopping Frequency Sequence Name: HOP_FREQ_SEQ_19

SEQ#	Frequency (Hz)	SEQ#	Frequency (Hz)	SEQ#	Frequency (Hz)	SEQ#	Frequency (Hz)
1	5.636G	2	5.362G	3	5.640G	4	5.707G
5	5.631G	6	5.612G	7	5.547G	8	5.512G
9	5.708G	10	5.340G	11	5.575G	12	5.632G
13	5.619G	14	5.429G	15	5.513G	16	5.285G
17	5.546G	18	5.651G	19	5.509G	20	5.562G
21	5.526G	22	5.387G	23	5.471G	24	5.724G
25	5.372G	26	5.577G	27	5.331G	28	5.667G
29	5.684G	30	5.269G	31	5.678G	32	5.320G
33	5.325G	34	5.709G	35	5.654G	36	5.398G
37	5.599G	38	5.257G	39	5.352G	40	5.499G
41	5.385G	42	5.322G	43	5.449G	44	5.374G
45	5.616G	46	5.261G	47	5.722G	48	5.256G
49	5.596G	50	5.469G	51	5.291G	52	5.391G
53	5.602G	54	5.467G	55	5.506G	56	5.714G
57	5.572G	58	5.327G	59	5.618G	60	5.536G
61	5.595G	62	5.370G	63	5.675G	64	5.511G
65	5.671G	66	5.698G	67	5.461G	68	5.649G
69	5.415G	70	5.439G	71	5.333G	72	5.460G
73	5.552G	74	5.643G	75	5.669G	76	5.357G
77	5.306G	78	5.367G	79	5.271G	80	5.625G
81	5.589G	82	5.250G	83	5.605G	84	5.329G
85	5.534G	86	5.378G	87	5.427G	88	5.316G
89	5.425G	90	5.442G	91	5.313G	92	5.694G
93	5.652G	94	5.368G	95	5.576G	96	5.593G
97	5.701G	98	5.695G	99	5.590G	100	5.336G



A D T

Hopping Frequency Sequence Name: HOP_FREQ_SEQ_20

SEQ#	Frequency (Hz)	SEQ#	Frequency (Hz)	SEQ#	Frequency (Hz)	SEQ#	Frequency (Hz)
1	5.653G	2	5.657G	3	5.662G	4	5.407G
5	5.547G	6	5.250G	7	5.315G	8	5.420G
9	5.255G	10	5.336G	11	5.470G	12	5.544G
13	5.506G	14	5.468G	15	5.325G	16	5.437G
17	5.458G	18	5.526G	19	5.409G	20	5.604G
21	5.382G	22	5.259G	23	5.504G	24	5.354G
25	5.715G	26	5.462G	27	5.278G	28	5.419G
29	5.659G	30	5.519G	31	5.377G	32	5.610G
33	5.411G	34	5.329G	35	5.435G	36	5.539G
37	5.346G	38	5.582G	39	5.298G	40	5.321G
41	5.551G	42	5.630G	43	5.685G	44	5.313G
45	5.723G	46	5.485G	47	5.296G	48	5.357G
49	5.418G	50	5.460G	51	5.559G	52	5.312G
53	5.503G	54	5.631G	55	5.678G	56	5.548G
57	5.643G	58	5.615G	59	5.535G	60	5.280G
61	5.552G	62	5.432G	63	5.320G	64	5.294G
65	5.651G	66	5.546G	67	5.310G	68	5.683G
69	5.603G	70	5.658G	71	5.304G	72	5.684G
73	5.262G	74	5.521G	75	5.636G	76	5.380G
77	5.623G	78	5.512G	79	5.627G	80	5.300G
81	5.442G	82	5.363G	83	5.476G	84	5.405G
85	5.632G	86	5.426G	87	5.393G	88	5.395G
89	5.692G	90	5.400G	91	5.374G	92	5.510G
93	5.602G	94	5.440G	95	5.629G	96	5.253G
97	5.676G	98	5.495G	99	5.413G	100	5.560G



A D T

Hopping Frequency Sequence Name: HOP_FREQ_SEQ_21

SEQ#	Frequency (Hz)	SEQ#	Frequency (Hz)	SEQ#	Frequency (Hz)	SEQ#	Frequency (Hz)
1	5.258G	2	5.686G	3	5.465G	4	5.669G
5	5.663G	6	5.641G	7	5.666G	8	5.401G
9	5.622G	10	5.314G	11	5.611G	12	5.554G
13	5.411G	14	5.329G	15	5.664G	16	5.612G
17	5.333G	18	5.466G	19	5.559G	20	5.645G
21	5.397G	22	5.661G	23	5.541G	24	5.463G
25	5.621G	26	5.357G	27	5.443G	28	5.630G
29	5.345G	30	5.377G	31	5.681G	32	5.606G
33	5.313G	34	5.579G	35	5.402G	36	5.555G
37	5.253G	38	5.395G	39	5.711G	40	5.332G
41	5.670G	42	5.585G	43	5.429G	44	5.321G
45	5.499G	46	5.549G	47	5.317G	48	5.530G
49	5.582G	50	5.511G	51	5.454G	52	5.565G
53	5.507G	54	5.589G	55	5.588G	56	5.369G
57	5.659G	58	5.613G	59	5.483G	60	5.550G
61	5.422G	62	5.715G	63	5.707G	64	5.316G
65	5.644G	66	5.393G	67	5.400G	68	5.442G
69	5.510G	70	5.468G	71	5.291G	72	5.456G
73	5.327G	74	5.270G	75	5.724G	76	5.662G
77	5.349G	78	5.548G	79	5.282G	80	5.409G
81	5.515G	82	5.363G	83	5.427G	84	5.375G
85	5.286G	86	5.586G	87	5.343G	88	5.683G
89	5.413G	90	5.665G	91	5.602G	92	5.713G
93	5.275G	94	5.631G	95	5.473G	96	5.421G
97	5.410G	98	5.428G	99	5.497G	100	5.385G



A D T

Hopping Frequency Sequence Name: HOP_FREQ_SEQ_22

SEQ#	Frequency (Hz)	SEQ#	Frequency (Hz)	SEQ#	Frequency (Hz)	SEQ#	Frequency (Hz)
1	5.323G	2	5.273G	3	5.358G	4	5.468G
5	5.675G	6	5.611G	7	5.595G	8	5.687G
9	5.371G	10	5.692G	11	5.602G	12	5.493G
13	5.702G	14	5.658G	15	5.606G	16	5.410G
17	5.424G	18	5.325G	19	5.346G	20	5.524G
21	5.650G	22	5.661G	23	5.263G	24	5.604G
25	5.434G	26	5.472G	27	5.494G	28	5.430G
29	5.520G	30	5.499G	31	5.336G	32	5.587G
33	5.707G	34	5.582G	35	5.478G	36	5.555G
37	5.688G	38	5.578G	39	5.250G	40	5.635G
41	5.515G	42	5.394G	43	5.724G	44	5.706G
45	5.338G	46	5.666G	47	5.274G	48	5.384G
49	5.720G	50	5.397G	51	5.577G	52	5.662G
53	5.426G	54	5.668G	55	5.684G	56	5.613G
57	5.718G	58	5.257G	59	5.717G	60	5.289G
61	5.609G	62	5.417G	63	5.376G	64	5.281G
65	5.693G	66	5.387G	67	5.508G	68	5.597G
69	5.573G	70	5.329G	71	5.315G	72	5.505G
73	5.412G	74	5.653G	75	5.460G	76	5.554G
77	5.618G	78	5.416G	79	5.527G	80	5.617G
81	5.516G	82	5.560G	83	5.696G	84	5.470G
85	5.340G	86	5.415G	87	5.536G	88	5.377G
89	5.318G	90	5.535G	91	5.482G	92	5.659G
93	5.671G	94	5.380G	95	5.265G	96	5.261G
97	5.373G	98	5.665G	99	5.443G	100	5.694G



A D T

Hopping Frequency Sequence Name: HOP_FREQ_SEQ_23

SEQ#	Frequency (Hz)	SEQ#	Frequency (Hz)	SEQ#	Frequency (Hz)	SEQ#	Frequency (Hz)
1	5.632G	2	5.524G	3	5.364G	4	5.278G
5	5.542G	6	5.454G	7	5.269G	8	5.436G
9	5.399G	10	5.696G	11	5.435G	12	5.428G
13	5.674G	14	5.558G	15	5.429G	16	5.609G
17	5.340G	18	5.658G	19	5.280G	20	5.556G
21	5.585G	22	5.339G	23	5.356G	24	5.582G
25	5.718G	26	5.559G	27	5.622G	28	5.423G
29	5.432G	30	5.572G	31	5.293G	32	5.313G
33	5.640G	34	5.411G	35	5.693G	36	5.672G
37	5.498G	38	5.720G	39	5.378G	40	5.463G
41	5.403G	42	5.344G	43	5.611G	44	5.669G
45	5.388G	46	5.681G	47	5.407G	48	5.687G
49	5.439G	50	5.365G	51	5.449G	52	5.724G
53	5.494G	54	5.318G	55	5.665G	56	5.634G
57	5.471G	58	5.427G	59	5.692G	60	5.334G
61	5.333G	62	5.598G	63	5.551G	64	5.341G
65	5.268G	66	5.419G	67	5.688G	68	5.367G
69	5.581G	70	5.295G	71	5.251G	72	5.694G
73	5.265G	74	5.553G	75	5.643G	76	5.456G
77	5.490G	78	5.450G	79	5.415G	80	5.546G
81	5.288G	82	5.586G	83	5.495G	84	5.527G
85	5.618G	86	5.520G	87	5.332G	88	5.420G
89	5.704G	90	5.517G	91	5.308G	92	5.606G
93	5.387G	94	5.610G	95	5.413G	96	5.358G
97	5.462G	98	5.469G	99	5.484G	100	5.574G



A D T

Hopping Frequency Sequence Name: HOP_FREQ_SEQ_24

SEQ#	Frequency (Hz)	SEQ#	Frequency (Hz)	SEQ#	Frequency (Hz)	SEQ#	Frequency (Hz)
1	5.620G	2	5.479G	3	5.647G	4	5.596G
5	5.288G	6	5.548G	7	5.417G	8	5.628G
9	5.316G	10	5.301G	11	5.350G	12	5.259G
13	5.364G	14	5.442G	15	5.525G	16	5.488G
17	5.311G	18	5.391G	19	5.560G	20	5.621G
21	5.588G	22	5.604G	23	5.279G	24	5.652G
25	5.619G	26	5.445G	27	5.321G	28	5.444G
29	5.516G	30	5.490G	31	5.336G	32	5.277G
33	5.695G	34	5.473G	35	5.612G	36	5.702G
37	5.648G	38	5.414G	39	5.666G	40	5.340G
41	5.519G	42	5.396G	43	5.624G	44	5.434G
45	5.597G	46	5.281G	47	5.553G	48	5.703G
49	5.720G	50	5.532G	51	5.662G	52	5.595G
53	5.303G	54	5.459G	55	5.346G	56	5.269G
57	5.419G	58	5.511G	59	5.294G	60	5.284G
61	5.397G	62	5.398G	63	5.500G	64	5.724G
65	5.600G	66	5.305G	67	5.607G	68	5.437G
69	5.312G	70	5.598G	71	5.523G	72	5.670G
73	5.557G	74	5.335G	75	5.460G	76	5.570G
77	5.349G	78	5.561G	79	5.489G	80	5.377G
81	5.278G	82	5.627G	83	5.625G	84	5.324G
85	5.545G	86	5.330G	87	5.347G	88	5.425G
89	5.723G	90	5.711G	91	5.544G	92	5.691G
93	5.470G	94	5.307G	95	5.538G	96	5.370G
97	5.643G	98	5.332G	99	5.429G	100	5.339G



A D T

Hopping Frequency Sequence Name: HOP_FREQ_SEQ_25

SEQ#	Frequency (Hz)	SEQ#	Frequency (Hz)	SEQ#	Frequency (Hz)	SEQ#	Frequency (Hz)
1	5.643G	2	5.324G	3	5.452G	4	5.298G
5	5.310G	6	5.501G	7	5.404G	8	5.392G
9	5.628G	10	5.697G	11	5.339G	12	5.365G
13	5.559G	14	5.382G	15	5.505G	16	5.464G
17	5.350G	18	5.481G	19	5.470G	20	5.400G
21	5.634G	22	5.320G	23	5.645G	24	5.669G
25	5.498G	26	5.288G	27	5.605G	28	5.641G
29	5.348G	30	5.377G	31	5.340G	32	5.430G
33	5.389G	34	5.692G	35	5.564G	36	5.540G
37	5.433G	38	5.620G	39	5.352G	40	5.608G
41	5.551G	42	5.367G	43	5.343G	44	5.278G
45	5.425G	46	5.585G	47	5.259G	48	5.276G
49	5.336G	50	5.341G	51	5.632G	52	5.546G
53	5.337G	54	5.261G	55	5.396G	56	5.722G
57	5.654G	58	5.651G	59	5.369G	60	5.463G
61	5.524G	62	5.696G	63	5.332G	64	5.270G
65	5.284G	66	5.706G	67	5.414G	68	5.447G
69	5.359G	70	5.675G	71	5.423G	72	5.714G
73	5.314G	74	5.668G	75	5.597G	76	5.253G
77	5.642G	78	5.454G	79	5.676G	80	5.698G
81	5.691G	82	5.526G	83	5.709G	84	5.655G
85	5.321G	86	5.393G	87	5.677G	88	5.471G
89	5.718G	90	5.388G	91	5.617G	92	5.466G
93	5.682G	94	5.565G	95	5.552G	96	5.267G
97	5.383G	98	5.387G	99	5.301G	100	5.708G



A D T

Hopping Frequency Sequence Name: HOP_FREQ_SEQ_26

SEQ#	Frequency (Hz)	SEQ#	Frequency (Hz)	SEQ#	Frequency (Hz)	SEQ#	Frequency (Hz)
1	5.352G	2	5.641G	3	5.484G	4	5.503G
5	5.288G	6	5.690G	7	5.433G	8	5.355G
9	5.335G	10	5.699G	11	5.659G	12	5.393G
13	5.691G	14	5.452G	15	5.461G	16	5.330G
17	5.586G	18	5.554G	19	5.299G	20	5.717G
21	5.297G	22	5.477G	23	5.460G	24	5.307G
25	5.420G	26	5.566G	27	5.349G	28	5.406G
29	5.426G	30	5.317G	31	5.383G	32	5.502G
33	5.286G	34	5.334G	35	5.674G	36	5.559G
37	5.409G	38	5.351G	39	5.618G	40	5.395G
41	5.298G	42	5.532G	43	5.706G	44	5.629G
45	5.482G	46	5.403G	47	5.595G	48	5.591G
49	5.720G	50	5.483G	51	5.254G	52	5.637G
53	5.292G	54	5.404G	55	5.468G	56	5.700G
57	5.272G	58	5.411G	59	5.425G	60	5.516G
61	5.486G	62	5.373G	63	5.523G	64	5.285G
65	5.462G	66	5.342G	67	5.265G	68	5.382G
69	5.589G	70	5.407G	71	5.365G	72	5.709G
73	5.605G	74	5.434G	75	5.504G	76	5.530G
77	5.370G	78	5.430G	79	5.305G	80	5.536G
81	5.493G	82	5.487G	83	5.359G	84	5.594G
85	5.357G	86	5.423G	87	5.327G	88	5.304G
89	5.569G	90	5.428G	91	5.312G	92	5.608G
93	5.270G	94	5.281G	95	5.488G	96	5.387G
97	5.577G	98	5.644G	99	5.278G	100	5.565G



A D T

Hopping Frequency Sequence Name: HOP_FREQ_SEQ_27

SEQ#	Frequency (Hz)	SEQ#	Frequency (Hz)	SEQ#	Frequency (Hz)	SEQ#	Frequency (Hz)
1	5.481G	2	5.641G	3	5.534G	4	5.567G
5	5.653G	6	5.253G	7	5.583G	8	5.553G
9	5.535G	10	5.373G	11	5.408G	12	5.544G
13	5.572G	14	5.595G	15	5.283G	16	5.532G
17	5.438G	18	5.268G	19	5.546G	20	5.525G
21	5.676G	22	5.688G	23	5.696G	24	5.259G
25	5.670G	26	5.252G	27	5.719G	28	5.289G
29	5.464G	30	5.343G	31	5.394G	32	5.704G
33	5.549G	34	5.678G	35	5.666G	36	5.257G
37	5.513G	38	5.307G	39	5.381G	40	5.660G
41	5.357G	42	5.403G	43	5.643G	44	5.571G
45	5.286G	46	5.568G	47	5.423G	48	5.526G
49	5.405G	50	5.334G	51	5.320G	52	5.452G
53	5.316G	54	5.716G	55	5.302G	56	5.301G
57	5.263G	58	5.697G	59	5.556G	60	5.413G
61	5.262G	62	5.364G	63	5.557G	64	5.656G
65	5.655G	66	5.493G	67	5.375G	68	5.712G
69	5.606G	70	5.600G	71	5.596G	72	5.627G
73	5.707G	74	5.296G	75	5.684G	76	5.331G
77	5.453G	78	5.484G	79	5.498G	80	5.623G
81	5.311G	82	5.616G	83	5.540G	84	5.509G
85	5.531G	86	5.621G	87	5.501G	88	5.396G
89	5.647G	90	5.290G	91	5.477G	92	5.721G
93	5.494G	94	5.441G	95	5.322G	96	5.297G
97	5.694G	98	5.419G	99	5.640G	100	5.390G



A D T

Hopping Frequency Sequence Name: HOP_FREQ_SEQ_28

SEQ#	Frequency (Hz)	SEQ#	Frequency (Hz)	SEQ#	Frequency (Hz)	SEQ#	Frequency (Hz)
1	5.334G	2	5.703G	3	5.616G	4	5.535G
5	5.378G	6	5.294G	7	5.292G	8	5.511G
9	5.317G	10	5.318G	11	5.708G	12	5.470G
13	5.372G	14	5.392G	15	5.701G	16	5.328G
17	5.607G	18	5.593G	19	5.326G	20	5.667G
21	5.387G	22	5.719G	23	5.441G	24	5.319G
25	5.505G	26	5.281G	27	5.525G	28	5.570G
29	5.291G	30	5.693G	31	5.537G	32	5.303G
33	5.261G	34	5.552G	35	5.485G	36	5.343G
37	5.718G	38	5.347G	39	5.514G	40	5.262G
41	5.660G	42	5.436G	43	5.288G	44	5.723G
45	5.606G	46	5.380G	47	5.396G	48	5.381G
49	5.567G	50	5.527G	51	5.450G	52	5.601G
53	5.449G	54	5.373G	55	5.471G	56	5.510G
57	5.391G	58	5.507G	59	5.532G	60	5.300G
61	5.375G	62	5.561G	63	5.316G	64	5.661G
65	5.617G	66	5.563G	67	5.551G	68	5.595G
69	5.356G	70	5.289G	71	5.555G	72	5.560G
73	5.571G	74	5.681G	75	5.443G	76	5.501G
77	5.266G	78	5.293G	79	5.468G	80	5.274G
81	5.587G	82	5.698G	83	5.304G	84	5.553G
85	5.315G	86	5.455G	87	5.286G	88	5.500G
89	5.523G	90	5.482G	91	5.331G	92	5.348G
93	5.550G	94	5.631G	95	5.399G	96	5.598G
97	5.269G	98	5.576G	99	5.645G	100	5.388G



A D T

Hopping Frequency Sequence Name: HOP_FREQ_SEQ_29

SEQ#	Frequency (Hz)	SEQ#	Frequency (Hz)	SEQ#	Frequency (Hz)	SEQ#	Frequency (Hz)
1	5.662G	2	5.671G	3	5.616G	4	5.392G
5	5.430G	6	5.646G	7	5.562G	8	5.585G
9	5.438G	10	5.408G	11	5.680G	12	5.447G
13	5.356G	14	5.469G	15	5.336G	16	5.263G
17	5.665G	18	5.517G	19	5.419G	20	5.635G
21	5.645G	22	5.649G	23	5.565G	24	5.341G
25	5.677G	26	5.691G	27	5.655G	28	5.486G
29	5.395G	30	5.443G	31	5.368G	32	5.354G
33	5.632G	34	5.345G	35	5.493G	36	5.707G
37	5.637G	38	5.693G	39	5.320G	40	5.405G
41	5.316G	42	5.280G	43	5.603G	44	5.299G
45	5.559G	46	5.534G	47	5.396G	48	5.474G
49	5.436G	50	5.580G	51	5.310G	52	5.377G
53	5.407G	54	5.365G	55	5.488G	56	5.546G
57	5.512G	58	5.642G	59	5.629G	60	5.561G
61	5.448G	62	5.515G	63	5.291G	64	5.471G
65	5.433G	66	5.531G	67	5.541G	68	5.584G
69	5.483G	70	5.276G	71	5.473G	72	5.553G
73	5.681G	74	5.363G	75	5.720G	76	5.626G
77	5.315G	78	5.619G	79	5.458G	80	5.622G
81	5.527G	82	5.524G	83	5.284G	84	5.380G
85	5.312G	86	5.648G	87	5.435G	88	5.563G
89	5.321G	90	5.441G	91	5.523G	92	5.279G
93	5.636G	94	5.325G	95	5.409G	96	5.371G
97	5.570G	98	5.289G	99	5.372G	100	5.612G



A D T

Hopping Frequency Sequence Name: HOP_FREQ_SEQ_30

SEQ#	Frequency (Hz)	SEQ#	Frequency (Hz)	SEQ#	Frequency (Hz)	SEQ#	Frequency (Hz)
1	5.451G	2	5.338G	3	5.668G	4	5.349G
5	5.569G	6	5.350G	7	5.313G	8	5.255G
9	5.571G	10	5.593G	11	5.689G	12	5.647G
13	5.314G	14	5.400G	15	5.617G	16	5.665G
17	5.472G	18	5.613G	19	5.424G	20	5.573G
21	5.683G	22	5.440G	23	5.623G	24	5.361G
25	5.306G	26	5.384G	27	5.393G	28	5.420G
29	5.425G	30	5.310G	31	5.500G	32	5.336G
33	5.702G	34	5.457G	35	5.320G	36	5.327G
37	5.317G	38	5.651G	39	5.269G	40	5.601G
41	5.522G	42	5.690G	43	5.657G	44	5.254G
45	5.453G	46	5.341G	47	5.459G	48	5.456G
49	5.553G	50	5.597G	51	5.600G	52	5.275G
53	5.712G	54	5.693G	55	5.419G	56	5.606G
57	5.638G	58	5.707G	59	5.445G	60	5.497G
61	5.394G	62	5.330G	63	5.481G	64	5.403G
65	5.603G	66	5.517G	67	5.722G	68	5.589G
69	5.605G	70	5.256G	71	5.607G	72	5.305G
73	5.474G	74	5.509G	75	5.524G	76	5.292G
77	5.566G	78	5.405G	79	5.366G	80	5.532G
81	5.586G	82	5.257G	83	5.523G	84	5.409G
85	5.404G	86	5.549G	87	5.303G	88	5.563G
89	5.663G	90	5.590G	91	5.536G	92	5.598G
93	5.619G	94	5.541G	95	5.455G	96	5.599G
97	5.675G	98	5.273G	99	5.587G	100	5.643G



A D T

802.11ac VHT80

Long Pulse Radar Test Signal						
Test Signal Name: LP_Signal_01						
Number of Bursts in Trial: 8						
Burst	Pulses per Burst	Chrip (Hz)	Pulse Width (s)	Pulse 1 to 2 Spacing (s)	Pulse 2 to 3 Spacing (s)	Start Location (s)
1	2	20M	68.7u	1.327m	-	1135m
2	1	18M	81.7u	-	-	842m
3	3	20M	82.9u	1.693m	1.111m	589m
4	2	5M	55.8u	1.51m	-	182m
5	2	13M	67.9u	1.403m	-	464m
6	1	8M	64.8u	-	-	788m
7	1	13M	51.1u	-	-	407m
8	2	12M	98.9u	1.486m	-	1471m

Long Pulse Radar Test Signal						
Test Signal Name: LP_Signal_02						
Number of Bursts in Trial: 9						
Burst	Pulses per Burst	Chrip (Hz)	Pulse Width (s)	Pulse 1 to 2 Spacing (s)	Pulse 2 to 3 Spacing (s)	Start Location (s)
1	1	8M	89.2u	-	-	962m
2	2	9M	97.9u	1.785m	-	263m
3	2	13M	75u	1.195m	-	1151m
4	2	11M	95u	1.112m	-	533m
5	1	12M	54.1u	-	-	105m
6	2	18M	88.3u	1.178m	-	323m
7	3	18M	52u	1.534m	1.612m	644m
8	2	20M	87.1u	1.617m	-	432m
9	2	7M	91.3u	1.88m	-	414m



A D T

Long Pulse Radar Test Signal
Test Signal Name: LP_Signal_03
Number of Bursts in Trial: 10

Burst	Pulses per Burst	Chrip (Hz)	Pulse Width (s)	Pulse 1 to 2 Spacing (s)	Pulse 2 to 3 Spacing (s)	Start Location (s)
1	3	6M	84.3u	1.208m	1.166m	750m
2	3	10M	84.3u	1.806m	0.999m	808m
3	2	11M	68.8u	0.987m	-	863m
4	2	10M	90u	1.68m	-	358m
5	2	11M	96.8u	1.306m	-	618m
6	1	8M	87.6u	-	-	1134m
7	2	8M	96.4u	1.286m	-	11m
8	1	11M	57.3u	-	-	859m
9	1	12M	61.2u	-	-	148m
10	3	20M	92.5u	1.698m	1.806m	846m

Long Pulse Radar Test Signal
Test Signal Name: LP_Signal_04
Number of Bursts in Trial: 11

Burst	Pulses per Burst	Chrip (Hz)	Pulse Width (s)	Pulse 1 to 2 Spacing (s)	Pulse 2 to 3 Spacing (s)	Start Location (s)
1	3	7M	77.9u	1.179m	1.348m	503m
2	1	19M	91u	-	-	530m
3	3	7M	96.5u	1.205m	1.758m	174m
4	2	9M	61.2u	1.1m	-	152m
5	2	8M	94.2u	1.812m	-	857m
6	1	15M	61.6u	-	-	716m
7	1	13M	82.7u	-	-	8m
8	3	7M	85.1u	1.907m	1.122m	918m
9	1	17M	64.3u	-	-	31m
10	1	18M	53.2u	-	-	301m
11	3	8M	79.4u	1.869m	1.11m	832m



A D T

Long Pulse Radar Test Signal						
Test Signal Name: LP_Signal_05						
Number of Bursts in Trial: 12						
Burst	Pulses per Burst	Chrip (Hz)	Pulse Width (s)	Pulse 1 to 2 Spacing (s)	Pulse 2 to 3 Spacing (s)	Start Location (s)
1	2	17M	68.6u	1.216m	-	957m
2	1	9M	83.6u	-	-	850m
3	3	14M	85.2u	1.63m	1.694m	718m
4	1	15M	61u	-	-	592m
5	1	13M	55.5u	-	-	535m
6	2	13M	88.1u	1.294m	-	633m
7	1	17M	98.2u	-	-	278m
8	2	19M	70.4u	1.749m	-	9m
9	2	10M	71.3u	1.612m	-	670m
10	3	13M	58.5u	1.775m	1.469m	981m
11	2	5M	93.9u	1.149m	-	230m
12	2	19M	94u	1.876m	-	246m

Long Pulse Radar Test Signal						
Test Signal Name: LP_Signal_06						
Number of Bursts in Trial: 13						
Burst	Pulses per Burst	Chrip (Hz)	Pulse Width (s)	Pulse 1 to 2 Spacing (s)	Pulse 2 to 3 Spacing (s)	Start Location (s)
1	2	20M	74u	1.764m	-	60m
2	3	13M	53.6u	1.532m	1.425m	552m
3	2	12M	79u	1.56m	-	734m
4	2	9M	92.5u	0.962m	-	334m
5	3	15M	55.7u	1.27m	1.408m	634m
6	2	8M	80.9u	1.649m	-	166m
7	2	12M	72.8u	1.152m	-	80m
8	2	12M	71.6u	1.353m	-	9m
9	1	5M	51.2u	-	-	739m
10	3	7M	76.6u	1.847m	1.794m	768m
11	3	13M	97.9u	1.491m	1.309m	86m
12	3	13M	72.7u	1.356m	1.025m	60m
13	2	13M	77.2u	1.529m	-	448m



A D T

Long Pulse Radar Test Signal
Test Signal Name: LP_Signal_07
Number of Bursts in Trial: 14

Burst	Pulses per Burst	Chrip (Hz)	Pulse Width (s)	Pulse 1 to 2 Spacing (s)	Pulse 2 to 3 Spacing (s)	Start Location (s)
1	2	12M	65.7u	1.679m	-	499m
2	1	15M	74.3u	-	-	529m
3	1	13M	90.5u	-	-	835m
4	3	10M	56.9u	1.425m	1.73m	585m
5	2	11M	58.7u	1.449m	-	728m
6	3	18M	50.3u	1.066m	0.986m	177m
7	2	19M	79.8u	1.789m	-	306m
8	3	13M	77.7u	1.089m	1.701m	133m
9	2	13M	78.5u	1.72m	-	806m
10	2	11M	72.6u	1.877m	-	35m
11	1	9M	72.3u	-	-	339m
12	1	14M	83.9u	-	-	217m
13	1	13M	75.1u	-	-	221m
14	1	19M	53.8u	-	-	266m

Long Pulse Radar Test Signal
Test Signal Name: LP_Signal_08
Number of Bursts in Trial: 15

Burst	Pulses per Burst	Chrip (Hz)	Pulse Width (s)	Pulse 1 to 2 Spacing (s)	Pulse 2 to 3 Spacing (s)	Start Location (s)
1	2	13M	89.5u	0.926m	-	553m
2	2	11M	91.1u	1.328m	-	336m
3	1	13M	60.6u	-	-	197m
4	2	8M	71.4u	1.02m	-	585m
5	1	20M	68.1u	-	-	376m
6	2	14M	66.2u	1.214m	-	686m
7	1	15M	80.4u	-	-	743m
8	2	11M	72.4u	1.199m	-	174m
9	2	15M	60.7u	1.69m	-	536m
10	1	17M	80.1u	-	-	623m
11	2	14M	95.9u	1.596m	-	612m
12	3	18M	69u	1.232m	1.883m	391m
13	2	14M	56.7u	1.635m	-	182m
14	2	6M	74.6u	1.406m	-	532m
15	2	7M	94.5u	1.758m	-	387m



A D T

Long Pulse Radar Test Signal
Test Signal Name: LP_Signal_09
Number of Bursts in Trial: 16

Burst	Pulses per Burst	Chrip (Hz)	Pulse Width (s)	Pulse 1 to 2 Spacing (s)	Pulse 2 to 3 Spacing (s)	Start Location (s)
1	2	6M	93u	1.871m	-	430m
2	3	13M	62.1u	1.623m	1.862m	111m
3	2	10M	92.3u	1.348m	-	70m
4	2	7M	57.5u	1.346m	-	29m
5	3	20M	75.9u	1.723m	1.579m	415m
6	2	13M	88.6u	1.645m	-	242m
7	1	13M	52.4u	-	-	65m
8	1	20M	89.6u	-	-	692m
9	2	14M	62.5u	1.323m	-	549m
10	3	8M	68.7u	1.213m	1.25m	464m
11	1	18M	66.3u	-	-	740m
12	1	7M	53.2u	-	-	583m
13	1	10M	59.3u	-	-	602m
14	1	5M	73.7u	-	-	262m
15	2	15M	52.3u	1.422m	-	571m
16	2	12M	85.6u	1.142m	-	477m



A D T

Long Pulse Radar Test Signal
Test Signal Name: LP_Signal_10
Number of Bursts in Trial: 17

Burst	Pulses per Burst	Chrip (Hz)	Pulse Width (s)	Pulse 1 to 2 Spacing (s)	Pulse 2 to 3 Spacing (s)	Start Location (s)
1	2	15M	53.6u	1.192m	-	461m
2	2	20M	56.9u	1.23m	-	215m
3	2	19M	87.9u	0.934m	-	661m
4	2	18M	51.6u	1.932m	-	476m
5	1	13M	60.6u	-	-	459m
6	2	6M	87.4u	0.97m	-	28m
7	2	11M	52.4u	1.259m	-	416m
8	3	15M	96.9u	1.696m	1.295m	541m
9	2	5M	50.5u	1.62m	-	487m
10	2	19M	92.1u	1.756m	-	88m
11	1	9M	56.6u	-	-	278m
12	2	12M	69.1u	1.653m	-	86m
13	2	11M	61.9u	1.18m	-	208m
14	2	20M	56.3u	1.738m	-	114m
15	3	7M	72.5u	1.454m	1.651m	15m
16	2	20M	78.6u	1.649m	-	587m
17	1	10M	76.4u	-	-	518m



A D T

Long Pulse Radar Test Signal
Test Signal Name: LP_Signal_11
Number of Bursts in Trial: 18

Burst	Pulses per Burst	Chrip (Hz)	Pulse Width (s)	Pulse 1 to 2 Spacing (s)	Pulse 2 to 3 Spacing (s)	Start Location (s)
1	3	8M	64u	1.621m	1.533m	22m
2	2	14M	61.4u	1.281m	-	36m
3	3	8M	56.2u	0.946m	1.307m	572m
4	2	13M	70.8u	1.638m	-	125m
5	3	18M	75.2u	1.468m	1.384m	117m
6	2	15M	60.4u	1.216m	-	525m
7	2	11M	92.5u	0.975m	-	403m
8	3	7M	98.5u	1.377m	1.063m	344m
9	1	7M	63.5u	-	-	222m
10	3	14M	98.1u	1.036m	1.436m	163m
11	3	7M	83.1u	1.483m	1.652m	391m
12	2	13M	88.1u	1.218m	-	631m
13	2	19M	72.5u	1.707m	-	192m
14	2	18M	88.5u	1.712m	-	259m
15	2	8M	93.8u	1.906m	-	194m
16	3	10M	74.4u	1.73m	1.263m	644m
17	2	19M	99u	1.597m	-	366m
18	3	20M	54.2u	1.563m	1.766m	381m



A D T

Long Pulse Radar Test Signal
Test Signal Name: LP_Signal_12
Number of Bursts in Trial: 19

Burst	Pulses per Burst	Chrip (Hz)	Pulse Width (s)	Pulse 1 to 2 Spacing (s)	Pulse 2 to 3 Spacing (s)	Start Location (s)
1	3	13M	65.5u	1.499m	1.441m	427m
2	3	9M	83.5u	1.766m	1.458m	341m
3	3	10M	97.4u	1.061m	0.936m	273m
4	2	6M	98.7u	1.556m	-	209m
5	3	13M	56.3u	0.964m	1.348m	444m
6	2	12M	80u	1.061m	-	395m
7	3	14M	51.4u	1.82m	1.666m	153m
8	1	10M	55.8u	-	-	432m
9	2	15M	52.9u	1.327m	-	152m
10	2	9M	71.4u	1.409m	-	318m
11	2	11M	95u	1.863m	-	400m
12	3	9M	60.1u	1.229m	1.174m	562m
13	2	15M	50.5u	1.284m	-	54m
14	2	9M	62.8u	1.166m	-	82m
15	3	13M	81.9u	1.064m	1.342m	410m
16	3	12M	84u	1.538m	1.094m	26m
17	2	13M	52.6u	1.565m	-	617m
18	2	10M	78u	1.174m	-	555m
19	2	8M	83.8u	0.95m	-	321m



A D T

Long Pulse Radar Test Signal						
Test Signal Name: LP_Signal_13						
Number of Bursts in Trial: 20						
Burst	Pulses per Burst	Chrip (Hz)	Pulse Width (s)	Pulse 1 to 2 Spacing (s)	Pulse 2 to 3 Spacing (s)	Start Location (s)
1	2	20M	75.2u	1.217m	-	333m
2	2	15M	88.3u	0.984m	-	216m
3	2	12M	61.5u	1.347m	-	34m
4	1	17M	57.6u	-	-	324m
5	2	20M	81.2u	1.577m	-	504m
6	2	13M	87.6u	1.581m	-	530m
7	1	6M	57.1u	-	-	33m
8	3	19M	60.9u	1.83m	1.431m	68m
9	1	19M	75u	-	-	67m
10	2	19M	58.7u	1.556m	-	139m
11	2	15M	89u	1.766m	-	490m
12	1	13M	97.5u	-	-	209m
13	2	13M	66.6u	1.631m	-	216m
14	2	15M	51.1u	1.705m	-	14m
15	1	8M	56.3u	-	-	465m
16	2	17M	99.1u	1.269m	-	566m
17	2	18M	76.2u	1.586m	-	541m
18	2	10M	97.1u	1.725m	-	210m
19	1	14M	91.3u	-	-	342m
20	2	6M	79.3u	1.631m	-	410m

Long Pulse Radar Test Signal						
Test Signal Name: LP_Signal_14						
Number of Bursts in Trial: 8						
Burst	Pulses per Burst	Chrip (Hz)	Pulse Width (s)	Pulse 1 to 2 Spacing (s)	Pulse 2 to 3 Spacing (s)	Start Location (s)
1	2	20M	73.5u	1.403m	-	268m
2	2	9M	84.6u	1.767m	-	500m
3	1	12M	83.3u	-	-	757m
4	2	20M	82.5u	1.01m	-	22m
5	1	10M	97.4u	-	-	44m
6	2	10M	77.6u	1.281m	-	1367m
7	1	6M	52.1u	-	-	1237m
8	2	12M	64.9u	1.882m	-	1233m



A D T

Long Pulse Radar Test Signal
Test Signal Name: LP_Signal_15
Number of Bursts in Trial: 9

Burst	Pulses per Burst	Chrip (Hz)	Pulse Width (s)	Pulse 1 to 2 Spacing (s)	Pulse 2 to 3 Spacing (s)	Start Location (s)
1	3	17M	94.5u	1.124m	1.486m	1027m
2	2	12M	83.3u	1.813m	-	830m
3	2	11M	52u	1.904m	-	1228m
4	1	15M	62.6u	-	-	11m
5	2	8M	75u	1.665m	-	115m
6	2	20M	71.9u	1.379m	-	142m
7	2	13M	60.2u	1.78m	-	351m
8	2	5M	78u	1.241m	-	70m
9	1	17M	88.7u	-	-	464m

Long Pulse Radar Test Signal
Test Signal Name: LP_Signal_16
Number of Bursts in Trial: 10

Burst	Pulses per Burst	Chrip (Hz)	Pulse Width (s)	Pulse 1 to 2 Spacing (s)	Pulse 2 to 3 Spacing (s)	Start Location (s)
1	1	10M	71.8u	-	-	323m
2	3	18M	59.1u	1.914m	1.033m	953m
3	2	6M	66.1u	1.024m	-	887m
4	3	5M	89.4u	1.251m	1.126m	1138m
5	3	12M	95.4u	1.846m	1.863m	1168m
6	3	18M	74.3u	1.702m	1.708m	477m
7	1	18M	78.7u	-	-	3m
8	2	14M	97.4u	1.027m	-	689m
9	2	9M	51.8u	1.338m	-	580m
10	2	11M	80.8u	1.767m	-	323m



A D T

Long Pulse Radar Test Signal						
Test Signal Name: LP_Signal_17						
Number of Bursts in Trial: 11						
Burst	Pulses per Burst	Chrip (Hz)	Pulse Width (s)	Pulse 1 to 2 Spacing (s)	Pulse 2 to 3 Spacing (s)	Start Location (s)
1	2	10M	78.7u	1.902m	-	998m
2	2	13M	91.7u	1.234m	-	776m
3	2	5M	81.6u	1.441m	-	133m
4	1	14M	80.8u	-	-	1037m
5	3	6M	60.7u	1.562m	1.684m	950m
6	1	5M	80.2u	-	-	72m
7	2	9M	56.7u	1.166m	-	969m
8	1	18M	67.6u	-	-	655m
9	2	15M	73.1u	1.086m	-	400m
10	2	12M	69.7u	0.994m	-	615m
11	2	18M	60.9u	1.789m	-	557m

Long Pulse Radar Test Signal						
Test Signal Name: LP_Signal_18						
Number of Bursts in Trial: 12						
Burst	Pulses per Burst	Chrip (Hz)	Pulse Width (s)	Pulse 1 to 2 Spacing (s)	Pulse 2 to 3 Spacing (s)	Start Location (s)
1	2	13M	59.2u	1.818m	-	146m
2	1	6M	77.3u	-	-	632m
3	2	14M	92.4u	1.088m	-	936m
4	3	14M	59.1u	1.324m	1.198m	984m
5	1	17M	71.3u	-	-	799m
6	2	10M	95.3u	1.71m	-	376m
7	1	12M	54u	-	-	78m
8	3	6M	84.7u	1.894m	1.799m	812m
9	3	11M	98.1u	0.957m	1.482m	157m
10	1	19M	88.1u	-	-	821m
11	3	7M	99u	1.16m	1.604m	553m
12	3	13M	96u	0.929m	1.891m	880m



A D T

Long Pulse Radar Test Signal
 Test Signal Name: LP_Signal_19
 Number of Bursts in Trial: 13

Burst	Pulses per Burst	Chrip (Hz)	Pulse Width (s)	Pulse 1 to 2 Spacing (s)	Pulse 2 to 3 Spacing (s)	Start Location (s)
1	2	13M	64.1u	1.402m	-	1.030
2	2	14M	55.2u	1.656m	-	767.9m
3	1	19M	54.5u	-	-	1.061
4	1	8M	95.2u	-	-	162.4m
5	1	8M	63.8u	-	-	863.7m
6	2	10M	99.2u	1.096m	-	721.4m
7	2	5M	82.5u	1.698m	-	987.6m
8	3	19M	90.4u	1.171m	1.195m	512.4m
9	2	14M	79.6u	1.878m	-	1.114
10	2	8M	65.5u	1.288m	-	476.1m
11						
12						
13						

Long Pulse Radar Test Signal
 Test Signal Name: LP_Signal_20
 Number of Bursts in Trial: 14

Burst	Pulses per Burst	Chrip (Hz)	Pulse Width (s)	Pulse 1 to 2 Spacing (s)	Pulse 2 to 3 Spacing (s)	Start Location (s)
1	1	13M	94.7u	-	-	441m
2	3	6M	84.7u	1.659m	1.123m	533m
3	3	15M	62.1u	1.826m	1.911m	805m
4	3	12M	94.1u	1.347m	1.531m	459m
5	2	10M	74.8u	1.684m	-	95m
6	2	13M	76.1u	1.63m	-	631m
7	2	18M	65.8u	1.01m	-	493m
8	2	18M	95.8u	1.254m	-	275m
9	3	15M	67.8u	1.338m	1.476m	827m
10	1	12M	66.3u	-	-	631m
11	2	13M	68u	1.581m	-	266m
12	2	17M	66.5u	1.089m	-	496m
13	2	14M	90u	0.956m	-	564m
14	1	10M	70.8u	-	-	826m



A D T

Long Pulse Radar Test Signal
Test Signal Name: LP_Signal_21
Number of Bursts in Trial: 15

Burst	Pulses per Burst	Chrip (Hz)	Pulse Width (s)	Pulse 1 to 2 Spacing (s)	Pulse 2 to 3 Spacing (s)	Start Location (s)
1	2	12M	85.1u	0.982m	-	702m
2	1	12M	72.8u	-	-	282m
3	2	11M	59u	1.271m	-	435m
4	3	13M	82.7u	1.368m	1.623m	456m
5	2	20M	67.9u	1.648m	-	499m
6	2	14M	78.8u	1.116m	-	320m
7	2	13M	75.4u	1.492m	-	426m
8	2	20M	55.8u	1.138m	-	551m
9	1	18M	60u	-	-	1m
10	2	9M	92.1u	1.481m	-	716m
11	2	18M	85.4u	1.044m	-	173m
12	1	6M	55.7u	-	-	41m
13	2	11M	78.7u	1.338m	-	234m
14	2	8M	54.5u	1.547m	-	724m
15	1	7M	89.8u	-	-	757m



A D T

Long Pulse Radar Test Signal
Test Signal Name: LP_Signal_22
Number of Bursts in Trial: 16

Burst	Pulses per Burst	Chrip (Hz)	Pulse Width (s)	Pulse 1 to 2 Spacing (s)	Pulse 2 to 3 Spacing (s)	Start Location (s)
1	3	13M	100u	1.411m	1.51m	445m
2	1	7M	55.3u	-	-	162m
3	3	14M	94.9u	1.796m	1.624m	330m
4	2	15M	87.6u	1.85m	-	202m
5	2	19M	60u	1.835m	-	88m
6	2	5M	55.2u	1.351m	-	169m
7	2	18M	60.6u	1.361m	-	512m
8	1	20M	84.8u	-	-	275m
9	2	8M	93.2u	1.871m	-	54m
10	1	20M	58.2u	-	-	742m
11	2	12M	75.8u	0.976m	-	557m
12	3	13M	99.1u	0.905m	0.928m	172m
13	2	17M	96u	1.774m	-	446m
14	1	9M	56.6u	-	-	587m
15	2	11M	53.4u	1.813m	-	35m
16	1	11M	58.7u	-	-	189m



A D T

Long Pulse Radar Test Signal
Test Signal Name: LP_Signal_23
Number of Bursts in Trial: 17

Burst	Pulses per Burst	Chrip (Hz)	Pulse Width (s)	Pulse 1 to 2 Spacing (s)	Pulse 2 to 3 Spacing (s)	Start Location (s)
1	2	20M	72u	1.175m	-	546m
2	2	13M	64.4u	1.331m	-	17m
3	2	17M	87.7u	1.25m	-	157m
4	1	14M	74u	-	-	556m
5	1	14M	53.8u	-	-	126m
6	2	13M	61.6u	1.813m	-	16m
7	3	19M	95u	1.097m	1.335m	613m
8	1	18M	92.7u	-	-	620m
9	2	17M	88.1u	1.153m	-	480m
10	2	12M	91u	1.045m	-	384m
11	1	11M	73.6u	-	-	490m
12	2	13M	80.5u	1.525m	-	465m
13	3	13M	54.1u	1.577m	1.078m	612m
14	1	11M	59.7u	-	-	630m
15	1	8M	92.2u	-	-	449m
16	3	17M	62.4u	1.785m	1.798m	170m
17	3	13M	78.1u	1.437m	1.837m	510m



A D T

Long Pulse Radar Test Signal
Test Signal Name: LP_Signal_24
Number of Bursts in Trial: 18

Burst	Pulses per Burst	Chrip (Hz)	Pulse Width (s)	Pulse 1 to 2 Spacing (s)	Pulse 2 to 3 Spacing (s)	Start Location (s)
1	3	5M	75.3u	1.009m	1.701m	548m
2	1	11M	87.6u	-	-	563m
3	1	15M	51.1u	-	-	345m
4	2	11M	58.3u	1.086m	-	186m
5	1	7M	62.8u	-	-	270m
6	3	10M	59u	1.82m	1.89m	4m
7	1	14M	87.4u	-	-	426m
8	3	7M	76.4u	1.037m	1.811m	43m
9	2	18M	88.6u	1.088m	-	533m
10	3	13M	65.7u	1.613m	1.379m	586m
11	2	12M	94.1u	1.697m	-	86m
12	2	5M	51u	1.839m	-	97m
13	2	10M	96.2u	0.967m	-	172m
14	3	7M	77.3u	1.659m	1.184m	307m
15	2	19M	54.3u	1.082m	-	3m
16	2	13M	65.6u	1.576m	-	513m
17	2	8M	86u	1.703m	-	279m
18	2	5M	68.7u	1.064m	-	128m



A D T

Long Pulse Radar Test Signal
Test Signal Name: LP_Signal_25
Number of Bursts in Trial: 19

Burst	Pulses per Burst	Chrip (Hz)	Pulse Width (s)	Pulse 1 to 2 Spacing (s)	Pulse 2 to 3 Spacing (s)	Start Location (s)
1	1	9M	94.1u	-	-	222m
2	2	13M	70.4u	1.745m	-	295m
3	1	9M	69.9u	-	-	50m
4	2	13M	88.5u	1.402m	-	552m
5	2	20M	87.2u	1.326m	-	249m
6	1	17M	77.7u	-	-	488m
7	3	13M	77.7u	1.205m	1.83m	595m
8	1	13M	61u	-	-	418m
9	2	14M	64.7u	1.806m	-	594m
10	2	15M	50.5u	1.732m	-	203m
11	2	12M	80u	1.07m	-	464m
12	1	14M	93.8u	-	-	461m
13	2	9M	78.5u	1.184m	-	508m
14	3	15M	65.7u	1.885m	1.71m	42m
15	1	12M	81.3u	-	-	101m
16	1	6M	54.4u	-	-	419m
17	1	20M	78.2u	-	-	362m
18	3	13M	71.1u	1.558m	1.444m	134m
19	3	11M	90u	1.386m	1.183m	37m



A D T

Long Pulse Radar Test Signal
Test Signal Name: LP_Signal_26
Number of Bursts in Trial: 20

Burst	Pulses per Burst	Chrip (Hz)	Pulse Width (s)	Pulse 1 to 2 Spacing (s)	Pulse 2 to 3 Spacing (s)	Start Location (s)
1	2	8M	77u	1.003m	-	13m
2	1	8M	71.5u	-	-	456m
3	3	9M	84.8u	1.128m	1.294m	381m
4	1	9M	61u	-	-	239m
5	2	14M	97u	1.671m	-	354m
6	3	15M	58.4u	0.951m	1.635m	181m
7	2	5M	60.1u	1.387m	-	212m
8	2	12M	61.5u	1.836m	-	310m
9	3	9M	64.3u	1.135m	1.381m	19m
10	1	9M	90.2u	-	-	136m
11	2	11M	53.1u	1.862m	-	421m
12	3	11M	81.6u	1.289m	1.171m	375m
13	1	8M	96.4u	-	-	208m
14	2	8M	80.2u	1.202m	-	223m
15	3	6M	94.1u	0.971m	1.066m	343m
16	1	5M	76.5u	-	-	131m
17	2	15M	97u	0.974m	-	553m
18	2	19M	50.9u	1.489m	-	269m
19	1	5M	63.7u	-	-	335m
20	3	10M	66.8u	1.8m	1.654m	349m

Long Pulse Radar Test Signal
Test Signal Name: LP_Signal_27
Number of Bursts in Trial: 8

Burst	Pulses per Burst	Chrip (Hz)	Pulse Width (s)	Pulse 1 to 2 Spacing (s)	Pulse 2 to 3 Spacing (s)	Start Location (s)
1	2	13M	69.3u	1.606m	-	803m
2	3	5M	72.3u	0.963m	1.677m	461m
3	3	13M	80.5u	1.093m	1.855m	1265m
4	3	14M	67.2u	1.133m	0.992m	496m
5	2	13M	60.9u	1.896m	-	1160m
6	2	13M	85u	1.613m	-	500m
7	2	7M	75.6u	1.465m	-	124m
8	3	13M	73.2u	1.694m	1.384m	1414m



A D T

Long Pulse Radar Test Signal
 Test Signal Name: LP_Signal_28
 Number of Bursts in Trial: 13

Burst	Pulses per Burst	Chrip (Hz)	Pulse Width (s)	Pulse 1 to 2 Spacing (s)	Pulse 2 to 3 Spacing (s)	Start Location (s)
1	2	17M	69.6u	1.343m	-	503m
2	2	13M	78.7u	1.584m	-	254m
3	2	6M	77.5u	1.316m	-	565m
4	1	13M	50.8u	-	-	52m
5	2	6M	60.5u	1.03m	-	535m
6	2	20M	76.4u	1.146m	-	248m
7	2	6M	67.4u	1.023m	-	28m
8	3	18M	75u	1.79m	1.148m	410m
9	2	8M	94.8u	1.088m	-	779m
10	1	8M	85.1u	-	-	599m
11	2	12M	97.4u	1.375m	-	5m
12	2	13M	60.5u	1.319m	-	730m
13	3	6M	87.7u	1.713m	0.917m	163m

Long Pulse Radar Test Signal
 Test Signal Name: LP_Signal_29
 Number of Bursts in Trial: 17

Burst	Pulses per Burst	Chrip (Hz)	Pulse Width (s)	Pulse 1 to 2 Spacing (s)	Pulse 2 to 3 Spacing (s)	Start Location (s)
1	2	14M	85.2u	1.434m	-	489m
2	2	12M	78.5u	1.686m	-	374m
3	1	7M	53u	-	-	453m
4	3	19M	60.1u	1.055m	1.789m	356m
5	1	14M	91.3u	-	-	104m
6	2	10M	92.1u	1.458m	-	637m
7	1	8M	87.4u	-	-	641m
8	2	6M	93.2u	1.678m	-	325m
9	1	7M	58.3u	-	-	331m
10	1	14M	89.2u	-	-	378m
11	3	15M	81.4u	1.526m	1.16m	554m
12	3	11M	51.1u	1.885m	1.633m	287m
13	2	6M	75.3u	1.502m	-	612m
14	3	9M	96.7u	1.353m	1.804m	99m
15	2	17M	59.9u	1.271m	-	93m
16	2	17M	63u	1.1m	-	369m
17	1	15M	87.3u	-	-	2m



A D T

Long Pulse Radar Test Signal

Test Signal Name: LP_Signal_30

Number of Bursts in Trial: 20

Burst	Pulses per Burst	Chrip (Hz)	Pulse Width (s)	Pulse 1 to 2 Spacing (s)	Pulse 2 to 3 Spacing (s)	Start Location (s)
1	2	10M	65.1u	1.879m	-	576m
2	2	17M	96.3u	0.965m	-	508m
3	2	11M	72.7u	1.299m	-	591m
4	3	14M	57.9u	1.268m	1.133m	312m
5	2	6M	51.8u	1.207m	-	258m
6	1	11M	53.2u	-	-	462m
7	2	17M	69.5u	1.815m	-	486m
8	3	13M	98.9u	1.815m	1.815m	525m
9	2	7M	75.9u	1.268m	-	3m
10	3	13M	82.9u	0.928m	1.299m	176m
11	2	14M	74.2u	0.988m	-	99m
12	1	13M	78.9u	-	-	262m
13	1	11M	99.4u	-	-	363m
14	2	9M	65.2u	1.674m	-	27m
15	1	19M	77.9u	-	-	185m
16	2	17M	61.7u	1.367m	-	86m
17	3	18M	79.8u	0.937m	1.17m	272m
18	3	6M	73.5u	1.05m	1.321m	131m
19	1	17M	95.9u	-	-	73m
20	2	19M	82.8u	1.858m	-	186m



A D T

Hopping Frequency Sequence Name: HOP_FREQ_SEQ_01

SEQ#	Frequency (Hz)	SEQ#	Frequency (Hz)	SEQ#	Frequency (Hz)	SEQ#	Frequency (Hz)
1	5.354G	2	5.590G	3	5.543G	4	5.402G
5	5.323G	6	5.674G	7	5.577G	8	5.295G
9	5.675G	10	5.624G	11	5.647G	12	5.673G
13	5.651G	14	5.276G	15	5.335G	16	5.473G
17	5.700G	18	5.303G	19	5.652G	20	5.687G
21	5.713G	22	5.637G	23	5.383G	24	5.428G
25	5.320G	26	5.455G	27	5.696G	28	5.533G
29	5.395G	30	5.542G	31	5.483G	32	5.329G
33	5.530G	34	5.659G	35	5.569G	36	5.339G
37	5.545G	38	5.259G	39	5.630G	40	5.482G
41	5.337G	42	5.550G	43	5.635G	44	5.567G
45	5.250G	46	5.486G	47	5.294G	48	5.369G
49	5.631G	50	5.541G	51	5.515G	52	5.712G
53	5.683G	54	5.425G	55	5.589G	56	5.612G
57	5.516G	58	5.689G	59	5.686G	60	5.581G
61	5.657G	62	5.433G	63	5.555G	64	5.387G
65	5.427G	66	5.463G	67	5.266G	68	5.443G
69	5.682G	70	5.648G	71	5.507G	72	5.400G
73	5.540G	74	5.498G	75	5.285G	76	5.358G
77	5.378G	78	5.566G	79	5.468G	80	5.531G
81	5.628G	82	5.481G	83	5.684G	84	5.623G
85	5.376G	86	5.493G	87	5.392G	88	5.704G
89	5.340G	90	5.256G	91	5.401G	92	5.292G
93	5.264G	94	5.536G	95	5.271G	96	5.557G
97	5.287G	98	5.275G	99	5.570G	100	5.310G



A D T

Hopping Frequency Sequence Name: HOP_FREQ_SEQ_02

SEQ#	Frequency (Hz)	SEQ#	Frequency (Hz)	SEQ#	Frequency (Hz)	SEQ#	Frequency (Hz)
1	5.630G	2	5.480G	3	5.376G	4	5.537G
5	5.611G	6	5.438G	7	5.449G	8	5.263G
9	5.690G	10	5.684G	11	5.601G	12	5.312G
13	5.274G	14	5.664G	15	5.447G	16	5.674G
17	5.325G	18	5.400G	19	5.373G	20	5.661G
21	5.337G	22	5.555G	23	5.680G	24	5.709G
25	5.552G	26	5.368G	27	5.416G	28	5.252G
29	5.260G	30	5.606G	31	5.652G	32	5.596G
33	5.353G	34	5.633G	35	5.534G	36	5.613G
37	5.250G	38	5.719G	39	5.418G	40	5.565G
41	5.290G	42	5.722G	43	5.397G	44	5.432G
45	5.648G	46	5.258G	47	5.518G	48	5.314G
49	5.583G	50	5.627G	51	5.264G	52	5.504G
53	5.472G	54	5.446G	55	5.427G	56	5.403G
57	5.251G	58	5.677G	59	5.628G	60	5.315G
61	5.433G	62	5.338G	63	5.582G	64	5.687G
65	5.542G	66	5.654G	67	5.488G	68	5.618G
69	5.358G	70	5.639G	71	5.703G	72	5.387G
73	5.367G	74	5.371G	75	5.476G	76	5.459G
77	5.461G	78	5.333G	79	5.693G	80	5.378G
81	5.349G	82	5.465G	83	5.370G	84	5.331G
85	5.700G	86	5.291G	87	5.522G	88	5.528G
89	5.638G	90	5.313G	91	5.321G	92	5.607G
93	5.514G	94	5.484G	95	5.698G	96	5.669G
97	5.663G	98	5.468G	99	5.643G	100	5.612G



A D T

Hopping Frequency Sequence Name: HOP_FREQ_SEQ_03

SEQ#	Frequency (Hz)	SEQ#	Frequency (Hz)	SEQ#	Frequency (Hz)	SEQ#	Frequency (Hz)
1	5.272G	2	5.345G	3	5.318G	4	5.378G
5	5.305G	6	5.697G	7	5.620G	8	5.497G
9	5.576G	10	5.368G	11	5.398G	12	5.533G
13	5.334G	14	5.443G	15	5.506G	16	5.266G
17	5.625G	18	5.439G	19	5.303G	20	5.480G
21	5.714G	22	5.257G	23	5.644G	24	5.304G
25	5.539G	26	5.603G	27	5.421G	28	5.415G
29	5.298G	30	5.267G	31	5.705G	32	5.618G
33	5.569G	34	5.490G	35	5.624G	36	5.558G
37	5.709G	38	5.460G	39	5.648G	40	5.335G
41	5.374G	42	5.608G	43	5.587G	44	5.464G
45	5.566G	46	5.363G	47	5.250G	48	5.552G
49	5.476G	50	5.717G	51	5.532G	52	5.296G
53	5.468G	54	5.376G	55	5.409G	56	5.301G
57	5.589G	58	5.313G	59	5.687G	60	5.530G
61	5.628G	62	5.690G	63	5.708G	64	5.654G
65	5.332G	66	5.400G	67	5.432G	68	5.402G
69	5.356G	70	5.279G	71	5.656G	72	5.340G
73	5.386G	74	5.396G	75	5.445G	76	5.694G
77	5.650G	78	5.704G	79	5.372G	80	5.347G
81	5.684G	82	5.351G	83	5.336G	84	5.660G
85	5.696G	86	5.456G	87	5.489G	88	5.259G
89	5.412G	90	5.677G	91	5.482G	92	5.607G
93	5.399G	94	5.546G	95	5.453G	96	5.722G
97	5.316G	98	5.444G	99	5.308G	100	5.275G



A D T

Hopping Frequency Sequence Name: HOP_FREQ_SEQ_04

SEQ#	Frequency (Hz)	SEQ#	Frequency (Hz)	SEQ#	Frequency (Hz)	SEQ#	Frequency (Hz)
1	5.556G	2	5.483G	3	5.630G	4	5.436G
5	5.344G	6	5.451G	7	5.424G	8	5.682G
9	5.408G	10	5.411G	11	5.494G	12	5.371G
13	5.618G	14	5.378G	15	5.510G	16	5.364G
17	5.629G	18	5.643G	19	5.256G	20	5.310G
21	5.482G	22	5.374G	23	5.493G	24	5.513G
25	5.692G	26	5.645G	27	5.360G	28	5.676G
29	5.606G	30	5.580G	31	5.655G	32	5.627G
33	5.487G	34	5.348G	35	5.331G	36	5.498G
37	5.382G	38	5.398G	39	5.715G	40	5.701G
41	5.253G	42	5.386G	43	5.700G	44	5.623G
45	5.722G	46	5.551G	47	5.600G	48	5.554G
49	5.354G	50	5.634G	51	5.468G	52	5.691G
53	5.447G	54	5.265G	55	5.590G	56	5.559G
57	5.649G	58	5.533G	59	5.470G	60	5.582G
61	5.537G	62	5.567G	63	5.678G	64	5.573G
65	5.519G	66	5.666G	67	5.391G	68	5.522G
69	5.544G	70	5.284G	71	5.703G	72	5.466G
73	5.319G	74	5.417G	75	5.612G	76	5.696G
77	5.592G	78	5.349G	79	5.330G	80	5.292G
81	5.651G	82	5.329G	83	5.324G	84	5.648G
85	5.255G	86	5.478G	87	5.402G	88	5.293G
89	5.446G	90	5.327G	91	5.295G	92	5.338G
93	5.596G	94	5.622G	95	5.668G	96	5.492G
97	5.641G	98	5.611G	99	5.280G	100	5.303G



A D T

Hopping Frequency Sequence Name: HOP_FREQ_SEQ_05

SEQ#	Frequency (Hz)	SEQ#	Frequency (Hz)	SEQ#	Frequency (Hz)	SEQ#	Frequency (Hz)
1	5.481G	2	5.477G	3	5.697G	4	5.351G
5	5.305G	6	5.458G	7	5.645G	8	5.712G
9	5.346G	10	5.690G	11	5.297G	12	5.438G
13	5.648G	14	5.331G	15	5.421G	16	5.383G
17	5.388G	18	5.293G	19	5.541G	20	5.471G
21	5.394G	22	5.337G	23	5.275G	24	5.671G
25	5.534G	26	5.592G	27	5.663G	28	5.344G
29	5.405G	30	5.466G	31	5.487G	32	5.357G
33	5.404G	34	5.365G	35	5.446G	36	5.287G
37	5.267G	38	5.430G	39	5.256G	40	5.529G
41	5.547G	42	5.623G	43	5.622G	44	5.328G
45	5.646G	46	5.542G	47	5.625G	48	5.668G
49	5.396G	50	5.288G	51	5.439G	52	5.370G
53	5.657G	54	5.599G	55	5.516G	56	5.348G
57	5.407G	58	5.392G	59	5.567G	60	5.315G
61	5.555G	62	5.543G	63	5.710G	64	5.379G
65	5.473G	66	5.414G	67	5.286G	68	5.338G
69	5.462G	70	5.660G	71	5.461G	72	5.314G
73	5.569G	74	5.558G	75	5.403G	76	5.533G
77	5.590G	78	5.460G	79	5.384G	80	5.501G
81	5.300G	82	5.702G	83	5.377G	84	5.552G
85	5.456G	86	5.576G	87	5.480G	88	5.696G
89	5.719G	90	5.417G	91	5.551G	92	5.363G
93	5.494G	94	5.349G	95	5.643G	96	5.524G
97	5.391G	98	5.416G	99	5.526G	100	5.580G



A D T

Hopping Frequency Sequence Name: HOP_FREQ_SEQ_06

SEQ#	Frequency (Hz)	SEQ#	Frequency (Hz)	SEQ#	Frequency (Hz)	SEQ#	Frequency (Hz)
1	5.263G	2	5.590G	3	5.637G	4	5.550G
5	5.679G	6	5.622G	7	5.300G	8	5.593G
9	5.586G	10	5.584G	11	5.713G	12	5.484G
13	5.610G	14	5.356G	15	5.371G	16	5.602G
17	5.684G	18	5.294G	19	5.365G	20	5.358G
21	5.384G	22	5.483G	23	5.557G	24	5.495G
25	5.644G	26	5.613G	27	5.391G	28	5.311G
29	5.715G	30	5.597G	31	5.359G	32	5.705G
33	5.503G	34	5.554G	35	5.525G	36	5.580G
37	5.604G	38	5.299G	39	5.683G	40	5.284G
41	5.638G	42	5.400G	43	5.282G	44	5.456G
45	5.669G	46	5.581G	47	5.435G	48	5.505G
49	5.462G	50	5.313G	51	5.601G	52	5.459G
53	5.714G	54	5.362G	55	5.671G	56	5.433G
57	5.264G	58	5.398G	59	5.573G	60	5.497G
61	5.632G	62	5.512G	63	5.576G	64	5.514G
65	5.409G	66	5.548G	67	5.259G	68	5.583G
69	5.570G	70	5.361G	71	5.549G	72	5.393G
73	5.650G	74	5.535G	75	5.567G	76	5.463G
77	5.321G	78	5.340G	79	5.404G	80	5.292G
81	5.541G	82	5.352G	83	5.539G	84	5.466G
85	5.642G	86	5.413G	87	5.625G	88	5.534G
89	5.504G	90	5.494G	91	5.257G	92	5.416G
93	5.626G	94	5.332G	95	5.528G	96	5.357G
97	5.376G	98	5.588G	99	5.507G	100	5.480G



A D T

Hopping Frequency Sequence Name: HOP_FREQ_SEQ_07

SEQ#	Frequency (Hz)	SEQ#	Frequency (Hz)	SEQ#	Frequency (Hz)	SEQ#	Frequency (Hz)
1	5.299G	2	5.427G	3	5.498G	4	5.394G
5	5.630G	6	5.356G	7	5.504G	8	5.616G
9	5.568G	10	5.509G	11	5.699G	12	5.282G
13	5.571G	14	5.565G	15	5.279G	16	5.414G
17	5.702G	18	5.307G	19	5.642G	20	5.321G
21	5.475G	22	5.634G	23	5.448G	24	5.306G
25	5.541G	26	5.465G	27	5.540G	28	5.291G
29	5.489G	30	5.447G	31	5.662G	32	5.546G
33	5.277G	34	5.438G	35	5.395G	36	5.398G
37	5.289G	38	5.341G	39	5.379G	40	5.545G
41	5.329G	42	5.622G	43	5.483G	44	5.364G
45	5.641G	46	5.274G	47	5.375G	48	5.539G
49	5.358G	50	5.580G	51	5.353G	52	5.627G
53	5.315G	54	5.645G	55	5.488G	56	5.706G
57	5.531G	58	5.408G	59	5.367G	60	5.670G
61	5.342G	62	5.288G	63	5.265G	64	5.256G
65	5.328G	66	5.581G	67	5.718G	68	5.326G
69	5.374G	70	5.464G	71	5.435G	72	5.711G
73	5.275G	74	5.372G	75	5.672G	76	5.680G
77	5.618G	78	5.528G	79	5.536G	80	5.425G
81	5.599G	82	5.720G	83	5.436G	84	5.310G
85	5.647G	86	5.690G	87	5.410G	88	5.476G
89	5.522G	90	5.278G	91	5.481G	92	5.421G
93	5.719G	94	5.598G	95	5.664G	96	5.455G
97	5.626G	98	5.271G	99	5.261G	100	5.454G



A D T

Hopping Frequency Sequence Name: HOP_FREQ_SEQ_08

SEQ#	Frequency (Hz)	SEQ#	Frequency (Hz)	SEQ#	Frequency (Hz)	SEQ#	Frequency (Hz)
1	5.502G	2	5.421G	3	5.600G	4	5.369G
5	5.538G	6	5.668G	7	5.577G	8	5.393G
9	5.293G	10	5.440G	11	5.443G	12	5.428G
13	5.457G	14	5.501G	15	5.314G	16	5.663G
17	5.441G	18	5.622G	19	5.713G	20	5.377G
21	5.556G	22	5.451G	23	5.642G	24	5.483G
25	5.366G	26	5.515G	27	5.519G	28	5.354G
29	5.350G	30	5.541G	31	5.497G	32	5.266G
33	5.704G	34	5.631G	35	5.480G	36	5.425G
37	5.473G	38	5.372G	39	5.494G	40	5.290G
41	5.312G	42	5.635G	43	5.503G	44	5.558G
45	5.721G	46	5.522G	47	5.666G	48	5.564G
49	5.662G	50	5.528G	51	5.416G	52	5.614G
53	5.310G	54	5.422G	55	5.611G	56	5.482G
57	5.563G	58	5.339G	59	5.520G	60	5.346G
61	5.255G	62	5.653G	63	5.696G	64	5.648G
65	5.588G	66	5.460G	67	5.610G	68	5.537G
69	5.513G	70	5.529G	71	5.263G	72	5.636G
73	5.395G	74	5.338G	75	5.414G	76	5.326G
77	5.698G	78	5.613G	79	5.381G	80	5.295G
81	5.403G	82	5.415G	83	5.365G	84	5.722G
85	5.303G	86	5.568G	87	5.356G	88	5.569G
89	5.449G	90	5.536G	91	5.619G	92	5.435G
93	5.399G	94	5.378G	95	5.603G	96	5.554G
97	5.412G	98	5.257G	99	5.643G	100	5.300G



A D T

Hopping Frequency Sequence Name: HOP_FREQ_SEQ_09

SEQ#	Frequency (Hz)	SEQ#	Frequency (Hz)	SEQ#	Frequency (Hz)	SEQ#	Frequency (Hz)
1	5.604G	2	5.573G	3	5.390G	4	5.391G
5	5.654G	6	5.621G	7	5.523G	8	5.655G
9	5.675G	10	5.623G	11	5.564G	12	5.562G
13	5.605G	14	5.503G	15	5.535G	16	5.278G
17	5.607G	18	5.306G	19	5.307G	20	5.325G
21	5.633G	22	5.705G	23	5.570G	24	5.505G
25	5.648G	26	5.624G	27	5.323G	28	5.377G
29	5.431G	30	5.342G	31	5.664G	32	5.366G
33	5.606G	34	5.355G	35	5.474G	36	5.549G
37	5.646G	38	5.413G	39	5.311G	40	5.346G
41	5.387G	42	5.254G	43	5.271G	44	5.721G
45	5.662G	46	5.445G	47	5.494G	48	5.260G
49	5.448G	50	5.602G	51	5.489G	52	5.290G
53	5.344G	54	5.680G	55	5.250G	56	5.451G
57	5.716G	58	5.644G	59	5.555G	60	5.272G
61	5.398G	62	5.567G	63	5.481G	64	5.350G
65	5.530G	66	5.468G	67	5.361G	68	5.584G
69	5.629G	70	5.521G	71	5.598G	72	5.682G
73	5.324G	74	5.501G	75	5.587G	76	5.383G
77	5.421G	78	5.430G	79	5.717G	80	5.710G
81	5.517G	82	5.394G	83	5.656G	84	5.425G
85	5.360G	86	5.678G	87	5.666G	88	5.410G
89	5.658G	90	5.332G	91	5.408G	92	5.343G
93	5.502G	94	5.327G	95	5.495G	96	5.616G
97	5.469G	98	5.456G	99	5.685G	100	5.490G



A D T

Hopping Frequency Sequence Name: HOP_FREQ_SEQ_10

SEQ#	Frequency (Hz)	SEQ#	Frequency (Hz)	SEQ#	Frequency (Hz)	SEQ#	Frequency (Hz)
1	5.638G	2	5.659G	3	5.586G	4	5.268G
5	5.281G	6	5.322G	7	5.703G	8	5.275G
9	5.599G	10	5.400G	11	5.633G	12	5.373G
13	5.366G	14	5.613G	15	5.323G	16	5.395G
17	5.644G	18	5.628G	19	5.670G	20	5.505G
21	5.699G	22	5.270G	23	5.328G	24	5.585G
25	5.276G	26	5.523G	27	5.301G	28	5.407G
29	5.583G	30	5.342G	31	5.367G	32	5.619G
33	5.312G	34	5.677G	35	5.606G	36	5.307G
37	5.387G	38	5.556G	39	5.724G	40	5.511G
41	5.450G	42	5.664G	43	5.563G	44	5.471G
45	5.648G	46	5.577G	47	5.410G	48	5.712G
49	5.464G	50	5.460G	51	5.269G	52	5.310G
53	5.432G	54	5.384G	55	5.430G	56	5.601G
57	5.711G	58	5.568G	59	5.422G	60	5.414G
61	5.669G	62	5.681G	63	5.447G	64	5.542G
65	5.392G	66	5.689G	67	5.427G	68	5.558G
69	5.498G	70	5.337G	71	5.289G	72	5.452G
73	5.661G	74	5.679G	75	5.396G	76	5.512G
77	5.710G	78	5.313G	79	5.546G	80	5.306G
81	5.305G	82	5.451G	83	5.463G	84	5.416G
85	5.532G	86	5.324G	87	5.465G	88	5.401G
89	5.376G	90	5.442G	91	5.647G	92	5.543G
93	5.308G	94	5.424G	95	5.436G	96	5.445G
97	5.482G	98	5.615G	99	5.524G	100	5.356G



A D T

Hopping Frequency Sequence Name: HOP_FREQ_SEQ_11

SEQ#	Frequency (Hz)	SEQ#	Frequency (Hz)	SEQ#	Frequency (Hz)	SEQ#	Frequency (Hz)
1	5.574G	2	5.377G	3	5.482G	4	5.491G
5	5.581G	6	5.538G	7	5.518G	8	5.433G
9	5.671G	10	5.286G	11	5.714G	12	5.305G
13	5.709G	14	5.395G	15	5.430G	16	5.625G
17	5.363G	18	5.559G	19	5.406G	20	5.261G
21	5.616G	22	5.484G	23	5.718G	24	5.365G
25	5.549G	26	5.686G	27	5.539G	28	5.297G
29	5.503G	30	5.600G	31	5.417G	32	5.571G
33	5.510G	34	5.589G	35	5.552G	36	5.564G
37	5.656G	38	5.293G	39	5.403G	40	5.448G
41	5.278G	42	5.321G	43	5.350G	44	5.533G
45	5.525G	46	5.655G	47	5.679G	48	5.265G
49	5.516G	50	5.580G	51	5.511G	52	5.328G
53	5.347G	54	5.585G	55	5.694G	56	5.250G
57	5.255G	58	5.724G	59	5.474G	60	5.690G
61	5.478G	62	5.364G	63	5.256G	64	5.495G
65	5.594G	66	5.520G	67	5.573G	68	5.425G
69	5.543G	70	5.304G	71	5.575G	72	5.517G
73	5.338G	74	5.441G	75	5.631G	76	5.614G
77	5.514G	78	5.462G	79	5.419G	80	5.624G
81	5.665G	82	5.653G	83	5.413G	84	5.371G
85	5.515G	86	5.309G	87	5.567G	88	5.355G
89	5.530G	90	5.568G	91	5.407G	92	5.659G
93	5.432G	94	5.608G	95	5.572G	96	5.513G
97	5.537G	98	5.481G	99	5.290G	100	5.457G



A D T

Hopping Frequency Sequence Name: HOP_FREQ_SEQ_12

SEQ#	Frequency (Hz)	SEQ#	Frequency (Hz)	SEQ#	Frequency (Hz)	SEQ#	Frequency (Hz)
1	5.251G	2	5.361G	3	5.591G	4	5.423G
5	5.661G	6	5.587G	7	5.284G	8	5.326G
9	5.553G	10	5.473G	11	5.405G	12	5.307G
13	5.406G	14	5.679G	15	5.286G	16	5.386G
17	5.350G	18	5.722G	19	5.463G	20	5.717G
21	5.529G	22	5.552G	23	5.366G	24	5.604G
25	5.631G	26	5.283G	27	5.440G	28	5.673G
29	5.567G	30	5.373G	31	5.346G	32	5.514G
33	5.460G	34	5.483G	35	5.663G	36	5.376G
37	5.502G	38	5.676G	39	5.277G	40	5.582G
41	5.409G	42	5.407G	43	5.471G	44	5.319G
45	5.698G	46	5.709G	47	5.517G	48	5.312G
49	5.287G	50	5.316G	51	5.606G	52	5.691G
53	5.453G	54	5.571G	55	5.475G	56	5.608G
57	5.296G	58	5.370G	59	5.621G	60	5.416G
61	5.276G	62	5.524G	63	5.690G	64	5.624G
65	5.625G	66	5.262G	67	5.597G	68	5.570G
69	5.311G	70	5.428G	71	5.363G	72	5.340G
73	5.706G	74	5.546G	75	5.369G	76	5.258G
77	5.292G	78	5.466G	79	5.650G	80	5.305G
81	5.680G	82	5.254G	83	5.693G	84	5.531G
85	5.687G	86	5.308G	87	5.609G	88	5.404G
89	5.674G	90	5.374G	91	5.325G	92	5.352G
93	5.493G	94	5.572G	95	5.310G	96	5.309G
97	5.596G	98	5.575G	99	5.348G	100	5.593G



A D T

Hopping Frequency Sequence Name: HOP_FREQ_SEQ_13

SEQ#	Frequency (Hz)	SEQ#	Frequency (Hz)	SEQ#	Frequency (Hz)	SEQ#	Frequency (Hz)
1	5.597G	2	5.450G	3	5.357G	4	5.258G
5	5.633G	6	5.593G	7	5.270G	8	5.411G
9	5.428G	10	5.278G	11	5.328G	12	5.292G
13	5.408G	14	5.531G	15	5.261G	16	5.255G
17	5.715G	18	5.652G	19	5.629G	20	5.506G
21	5.552G	22	5.452G	23	5.382G	24	5.489G
25	5.441G	26	5.413G	27	5.601G	28	5.435G
29	5.708G	30	5.704G	31	5.569G	32	5.592G
33	5.298G	34	5.492G	35	5.681G	36	5.448G
37	5.464G	38	5.567G	39	5.551G	40	5.396G
41	5.596G	42	5.370G	43	5.321G	44	5.371G
45	5.463G	46	5.326G	47	5.451G	48	5.576G
49	5.524G	50	5.564G	51	5.680G	52	5.490G
53	5.513G	54	5.570G	55	5.306G	56	5.426G
57	5.643G	58	5.533G	59	5.478G	60	5.547G
61	5.716G	62	5.360G	63	5.623G	64	5.645G
65	5.277G	66	5.458G	67	5.491G	68	5.554G
69	5.259G	70	5.553G	71	5.445G	72	5.556G
73	5.703G	74	5.707G	75	5.467G	76	5.483G
77	5.347G	78	5.444G	79	5.594G	80	5.709G
81	5.339G	82	5.460G	83	5.406G	84	5.335G
85	5.293G	86	5.637G	87	5.301G	88	5.476G
89	5.568G	90	5.515G	91	5.700G	92	5.625G
93	5.575G	94	5.617G	95	5.361G	96	5.583G
97	5.522G	98	5.260G	99	5.485G	100	5.621G



A D T

Hopping Frequency Sequence Name: HOP_FREQ_SEQ_14

SEQ#	Frequency (Hz)	SEQ#	Frequency (Hz)	SEQ#	Frequency (Hz)	SEQ#	Frequency (Hz)
1	5.319G	2	5.724G	3	5.270G	4	5.309G
5	5.334G	6	5.451G	7	5.721G	8	5.483G
9	5.541G	10	5.361G	11	5.257G	12	5.501G
13	5.312G	14	5.343G	15	5.311G	16	5.405G
17	5.627G	18	5.388G	19	5.551G	20	5.513G
21	5.283G	22	5.477G	23	5.363G	24	5.559G
25	5.252G	26	5.717G	27	5.389G	28	5.317G
29	5.366G	30	5.653G	31	5.678G	32	5.410G
33	5.526G	34	5.700G	35	5.330G	36	5.255G
37	5.425G	38	5.497G	39	5.315G	40	5.652G
41	5.438G	42	5.594G	43	5.435G	44	5.375G
45	5.603G	46	5.693G	47	5.669G	48	5.267G
49	5.648G	50	5.352G	51	5.514G	52	5.619G
53	5.365G	54	5.543G	55	5.491G	56	5.299G
57	5.282G	58	5.519G	59	5.294G	60	5.547G
61	5.719G	62	5.478G	63	5.580G	64	5.609G
65	5.614G	66	5.601G	67	5.395G	68	5.530G
69	5.502G	70	5.291G	71	5.371G	72	5.401G
73	5.488G	74	5.412G	75	5.355G	76	5.453G
77	5.532G	78	5.384G	79	5.485G	80	5.656G
81	5.705G	82	5.344G	83	5.369G	84	5.347G
85	5.694G	86	5.335G	87	5.504G	88	5.489G
89	5.558G	90	5.539G	91	5.677G	92	5.307G
93	5.510G	94	5.617G	95	5.373G	96	5.676G
97	5.615G	98	5.578G	99	5.290G	100	5.690G



A D T

Hopping Frequency Sequence Name: HOP_FREQ_SEQ_15

SEQ#	Frequency (Hz)	SEQ#	Frequency (Hz)	SEQ#	Frequency (Hz)	SEQ#	Frequency (Hz)
1	5.482G	2	5.496G	3	5.370G	4	5.590G
5	5.410G	6	5.380G	7	5.520G	8	5.712G
9	5.464G	10	5.511G	11	5.361G	12	5.423G
13	5.301G	14	5.603G	15	5.478G	16	5.281G
17	5.715G	18	5.397G	19	5.541G	20	5.385G
21	5.353G	22	5.394G	23	5.384G	24	5.266G
25	5.518G	26	5.442G	27	5.653G	28	5.319G
29	5.539G	30	5.633G	31	5.601G	32	5.484G
33	5.521G	34	5.591G	35	5.491G	36	5.291G
37	5.631G	38	5.288G	39	5.497G	40	5.568G
41	5.400G	42	5.663G	43	5.571G	44	5.260G
45	5.253G	46	5.392G	47	5.669G	48	5.650G
49	5.717G	50	5.426G	51	5.585G	52	5.673G
53	5.476G	54	5.547G	55	5.276G	56	5.337G
57	5.604G	58	5.254G	59	5.272G	60	5.393G
61	5.687G	62	5.311G	63	5.383G	64	5.322G
65	5.317G	66	5.572G	67	5.593G	68	5.714G
69	5.583G	70	5.579G	71	5.444G	72	5.602G
73	5.293G	74	5.531G	75	5.408G	76	5.492G
77	5.666G	78	5.449G	79	5.536G	80	5.316G
81	5.695G	82	5.307G	83	5.675G	84	5.287G
85	5.588G	86	5.339G	87	5.264G	88	5.556G
89	5.369G	90	5.290G	91	5.289G	92	5.513G
93	5.460G	94	5.469G	95	5.679G	96	5.275G
97	5.507G	98	5.550G	99	5.551G	100	5.280G



A D T

Hopping Frequency Sequence Name: HOP_FREQ_SEQ_16

SEQ#	Frequency (Hz)	SEQ#	Frequency (Hz)	SEQ#	Frequency (Hz)	SEQ#	Frequency (Hz)
1	5.528G	2	5.421G	3	5.348G	4	5.552G
5	5.530G	6	5.538G	7	5.439G	8	5.417G
9	5.479G	10	5.660G	11	5.672G	12	5.706G
13	5.609G	14	5.462G	15	5.344G	16	5.265G
17	5.308G	18	5.683G	19	5.610G	20	5.687G
21	5.320G	22	5.535G	23	5.704G	24	5.526G
25	5.503G	26	5.427G	27	5.661G	28	5.603G
29	5.283G	30	5.563G	31	5.472G	32	5.547G
33	5.432G	34	5.635G	35	5.666G	36	5.276G
37	5.685G	38	5.302G	39	5.322G	40	5.670G
41	5.714G	42	5.422G	43	5.262G	44	5.446G
45	5.471G	46	5.470G	47	5.591G	48	5.255G
49	5.721G	50	5.688G	51	5.600G	52	5.536G
53	5.533G	54	5.273G	55	5.447G	56	5.679G
57	5.399G	58	5.357G	59	5.653G	60	5.643G
61	5.509G	62	5.463G	63	5.402G	64	5.299G
65	5.293G	66	5.680G	67	5.379G	68	5.566G
69	5.676G	70	5.347G	71	5.628G	72	5.712G
73	5.572G	74	5.708G	75	5.454G	76	5.638G
77	5.365G	78	5.381G	79	5.577G	80	5.703G
81	5.658G	82	5.678G	83	5.491G	84	5.345G
85	5.544G	86	5.263G	87	5.559G	88	5.406G
89	5.604G	90	5.298G	91	5.364G	92	5.481G
93	5.396G	94	5.490G	95	5.701G	96	5.512G
97	5.296G	98	5.327G	99	5.385G	100	5.458G



A D T

Hopping Frequency Sequence Name: HOP_FREQ_SEQ_17

SEQ#	Frequency (Hz)	SEQ#	Frequency (Hz)	SEQ#	Frequency (Hz)	SEQ#	Frequency (Hz)
1	5.625G	2	5.721G	3	5.313G	4	5.631G
5	5.685G	6	5.707G	7	5.509G	8	5.599G
9	5.367G	10	5.331G	11	5.601G	12	5.659G
13	5.493G	14	5.417G	15	5.264G	16	5.496G
17	5.664G	18	5.542G	19	5.401G	20	5.484G
21	5.698G	22	5.266G	23	5.467G	24	5.545G
25	5.645G	26	5.452G	27	5.723G	28	5.526G
29	5.392G	30	5.398G	31	5.259G	32	5.433G
33	5.656G	34	5.271G	35	5.472G	36	5.680G
37	5.559G	38	5.495G	39	5.250G	40	5.252G
41	5.407G	42	5.488G	43	5.717G	44	5.654G
45	5.290G	46	5.320G	47	5.514G	48	5.510G
49	5.386G	50	5.391G	51	5.485G	52	5.643G
53	5.265G	54	5.699G	55	5.347G	56	5.490G
57	5.605G	58	5.610G	59	5.598G	60	5.684G
61	5.466G	62	5.342G	63	5.486G	64	5.482G
65	5.444G	66	5.256G	67	5.658G	68	5.674G
69	5.289G	70	5.328G	71	5.616G	72	5.335G
73	5.661G	74	5.273G	75	5.704G	76	5.318G
77	5.520G	78	5.594G	79	5.695G	80	5.396G
81	5.298G	82	5.343G	83	5.562G	84	5.641G
85	5.263G	86	5.326G	87	5.635G	88	5.640G
89	5.299G	90	5.688G	91	5.352G	92	5.434G
93	5.618G	94	5.517G	95	5.501G	96	5.590G
97	5.295G	98	5.504G	99	5.515G	100	5.722G



A D T

Hopping Frequency Sequence Name: HOP_FREQ_SEQ_18

SEQ#	Frequency (Hz)	SEQ#	Frequency (Hz)	SEQ#	Frequency (Hz)	SEQ#	Frequency (Hz)
1	5.321G	2	5.627G	3	5.361G	4	5.630G
5	5.385G	6	5.400G	7	5.476G	8	5.571G
9	5.663G	10	5.543G	11	5.357G	12	5.337G
13	5.594G	14	5.601G	15	5.628G	16	5.715G
17	5.670G	18	5.269G	19	5.431G	20	5.490G
21	5.330G	22	5.328G	23	5.713G	24	5.324G
25	5.645G	26	5.464G	27	5.721G	28	5.293G
29	5.530G	30	5.345G	31	5.409G	32	5.568G
33	5.461G	34	5.302G	35	5.528G	36	5.277G
37	5.453G	38	5.283G	39	5.587G	40	5.335G
41	5.479G	42	5.333G	43	5.359G	44	5.651G
45	5.392G	46	5.550G	47	5.512G	48	5.552G
49	5.659G	50	5.681G	51	5.253G	52	5.653G
53	5.540G	54	5.373G	55	5.384G	56	5.421G
57	5.380G	58	5.612G	59	5.410G	60	5.557G
61	5.710G	62	5.718G	63	5.553G	64	5.494G
65	5.426G	66	5.712G	67	5.292G	68	5.507G
69	5.259G	70	5.297G	71	5.655G	72	5.573G
73	5.564G	74	5.396G	75	5.436G	76	5.474G
77	5.350G	78	5.580G	79	5.377G	80	5.270G
81	5.250G	82	5.658G	83	5.691G	84	5.675G
85	5.272G	86	5.332G	87	5.585G	88	5.478G
89	5.638G	90	5.646G	91	5.295G	92	5.418G
93	5.412G	94	5.656G	95	5.606G	96	5.579G
97	5.724G	98	5.446G	99	5.716G	100	5.556G



A D T

Hopping Frequency Sequence Name: HOP_FREQ_SEQ_19

SEQ#	Frequency (Hz)	SEQ#	Frequency (Hz)	SEQ#	Frequency (Hz)	SEQ#	Frequency (Hz)
1	5.251G	2	5.385G	3	5.719G	4	5.366G
5	5.342G	6	5.697G	7	5.480G	8	5.400G
9	5.276G	10	5.389G	11	5.514G	12	5.376G
13	5.260G	14	5.671G	15	5.642G	16	5.634G
17	5.534G	18	5.416G	19	5.265G	20	5.283G
21	5.443G	22	5.319G	23	5.648G	24	5.564G
25	5.493G	26	5.525G	27	5.430G	28	5.397G
29	5.355G	30	5.602G	31	5.510G	32	5.636G
33	5.441G	34	5.362G	35	5.427G	36	5.646G
37	5.584G	38	5.562G	39	5.565G	40	5.407G
41	5.439G	42	5.364G	43	5.613G	44	5.269G
45	5.567G	46	5.605G	47	5.554G	48	5.532G
49	5.432G	50	5.544G	51	5.340G	52	5.478G
53	5.379G	54	5.651G	55	5.424G	56	5.467G
57	5.406G	58	5.587G	59	5.264G	60	5.714G
61	5.286G	62	5.533G	63	5.657G	64	5.653G
65	5.431G	66	5.438G	67	5.701G	68	5.468G
69	5.473G	70	5.282G	71	5.512G	72	5.280G
73	5.635G	74	5.667G	75	5.536G	76	5.505G
77	5.637G	78	5.523G	79	5.549G	80	5.313G
81	5.307G	82	5.328G	83	5.581G	84	5.612G
85	5.520G	86	5.277G	87	5.552G	88	5.459G
89	5.403G	90	5.698G	91	5.509G	92	5.388G
93	5.381G	94	5.392G	95	5.469G	96	5.317G
97	5.252G	98	5.687G	99	5.259G	100	5.691G



A D T

Hopping Frequency Sequence Name: HOP_FREQ_SEQ_20

SEQ#	Frequency (Hz)	SEQ#	Frequency (Hz)	SEQ#	Frequency (Hz)	SEQ#	Frequency (Hz)
1	5.526G	2	5.374G	3	5.580G	4	5.630G
5	5.673G	6	5.724G	7	5.255G	8	5.592G
9	5.377G	10	5.492G	11	5.688G	12	5.331G
13	5.479G	14	5.482G	15	5.425G	16	5.590G
17	5.493G	18	5.709G	19	5.622G	20	5.628G
21	5.661G	22	5.652G	23	5.690G	24	5.278G
25	5.502G	26	5.582G	27	5.600G	28	5.456G
29	5.336G	30	5.615G	31	5.291G	32	5.485G
33	5.397G	34	5.354G	35	5.257G	36	5.597G
37	5.573G	38	5.287G	39	5.396G	40	5.406G
41	5.375G	42	5.651G	43	5.420G	44	5.490G
45	5.405G	46	5.504G	47	5.496G	48	5.455G
49	5.329G	50	5.704G	51	5.445G	52	5.327G
53	5.647G	54	5.344G	55	5.593G	56	5.454G
57	5.463G	58	5.667G	59	5.675G	60	5.541G
61	5.570G	62	5.439G	63	5.535G	64	5.609G
65	5.296G	66	5.293G	67	5.589G	68	5.607G
69	5.669G	70	5.385G	71	5.461G	72	5.521G
73	5.689G	74	5.288G	75	5.491G	76	5.292G
77	5.712G	78	5.509G	79	5.422G	80	5.370G
81	5.400G	82	5.598G	83	5.533G	84	5.612G
85	5.253G	86	5.575G	87	5.605G	88	5.446G
89	5.435G	90	5.294G	91	5.642G	92	5.635G
93	5.559G	94	5.507G	95	5.357G	96	5.555G
97	5.606G	98	5.259G	99	5.522G	100	5.376G



A D T

Hopping Frequency Sequence Name: HOP_FREQ_SEQ_21

SEQ#	Frequency (Hz)	SEQ#	Frequency (Hz)	SEQ#	Frequency (Hz)	SEQ#	Frequency (Hz)
1	5.362G	2	5.474G	3	5.562G	4	5.684G
5	5.412G	6	5.630G	7	5.641G	8	5.642G
9	5.602G	10	5.253G	11	5.667G	12	5.515G
13	5.448G	14	5.390G	15	5.459G	16	5.570G
17	5.688G	18	5.331G	19	5.620G	20	5.381G
21	5.464G	22	5.677G	23	5.647G	24	5.707G
25	5.565G	26	5.345G	27	5.324G	28	5.468G
29	5.375G	30	5.318G	31	5.554G	32	5.323G
33	5.427G	34	5.522G	35	5.446G	36	5.618G
37	5.527G	38	5.528G	39	5.495G	40	5.654G
41	5.542G	42	5.575G	43	5.292G	44	5.391G
45	5.658G	46	5.355G	47	5.550G	48	5.421G
49	5.258G	50	5.713G	51	5.479G	52	5.280G
53	5.690G	54	5.571G	55	5.272G	56	5.372G
57	5.675G	58	5.337G	59	5.447G	60	5.394G
61	5.507G	62	5.719G	63	5.436G	64	5.360G
65	5.505G	66	5.530G	67	5.319G	68	5.411G
69	5.627G	70	5.366G	71	5.549G	72	5.452G
73	5.343G	74	5.442G	75	5.569G	76	5.313G
77	5.722G	78	5.625G	79	5.632G	80	5.256G
81	5.409G	82	5.596G	83	5.568G	84	5.304G
85	5.591G	86	5.477G	87	5.404G	88	5.498G
89	5.638G	90	5.413G	91	5.441G	92	5.480G
93	5.357G	94	5.524G	95	5.695G	96	5.672G
97	5.358G	98	5.589G	99	5.388G	100	5.532G



A D T

Hopping Frequency Sequence Name: HOP_FREQ_SEQ_22

SEQ#	Frequency (Hz)	SEQ#	Frequency (Hz)	SEQ#	Frequency (Hz)	SEQ#	Frequency (Hz)
1	5.609G	2	5.681G	3	5.700G	4	5.467G
5	5.632G	6	5.707G	7	5.322G	8	5.720G
9	5.353G	10	5.358G	11	5.345G	12	5.288G
13	5.435G	14	5.487G	15	5.445G	16	5.628G
17	5.301G	18	5.407G	19	5.384G	20	5.405G
21	5.538G	22	5.389G	23	5.502G	24	5.618G
25	5.422G	26	5.477G	27	5.544G	28	5.608G
29	5.295G	30	5.434G	31	5.460G	32	5.501G
33	5.577G	34	5.250G	35	5.480G	36	5.368G
37	5.344G	38	5.364G	39	5.316G	40	5.663G
41	5.599G	42	5.570G	43	5.518G	44	5.615G
45	5.668G	46	5.592G	47	5.658G	48	5.470G
49	5.418G	50	5.319G	51	5.569G	52	5.597G
53	5.540G	54	5.254G	55	5.468G	56	5.340G
57	5.490G	58	5.542G	59	5.595G	60	5.588G
61	5.251G	62	5.693G	63	5.443G	64	5.530G
65	5.276G	66	5.335G	67	5.336G	68	5.448G
69	5.629G	70	5.385G	71	5.263G	72	5.713G
73	5.642G	74	5.328G	75	5.317G	76	5.382G
77	5.438G	78	5.498G	79	5.430G	80	5.647G
81	5.719G	82	5.352G	83	5.488G	84	5.521G
85	5.606G	86	5.639G	87	5.351G	88	5.617G
89	5.284G	90	5.440G	91	5.404G	92	5.267G
93	5.257G	94	5.721G	95	5.334G	96	5.323G
97	5.473G	98	5.311G	99	5.308G	100	5.641G



A D T

Hopping Frequency Sequence Name: HOP_FREQ_SEQ_23

SEQ#	Frequency (Hz)	SEQ#	Frequency (Hz)	SEQ#	Frequency (Hz)	SEQ#	Frequency (Hz)
1	5.503G	2	5.600G	3	5.520G	4	5.339G
5	5.611G	6	5.415G	7	5.658G	8	5.309G
9	5.318G	10	5.496G	11	5.590G	12	5.566G
13	5.461G	14	5.645G	15	5.276G	16	5.563G
17	5.453G	18	5.429G	19	5.329G	20	5.378G
21	5.554G	22	5.508G	23	5.359G	24	5.460G
25	5.528G	26	5.512G	27	5.366G	28	5.649G
29	5.521G	30	5.388G	31	5.706G	32	5.705G
33	5.258G	34	5.527G	35	5.622G	36	5.576G
37	5.484G	38	5.494G	39	5.328G	40	5.683G
41	5.550G	42	5.284G	43	5.565G	44	5.498G
45	5.666G	46	5.372G	47	5.458G	48	5.615G
49	5.529G	50	5.250G	51	5.694G	52	5.686G
53	5.333G	54	5.602G	55	5.463G	56	5.397G
57	5.436G	58	5.652G	59	5.648G	60	5.375G
61	5.383G	62	5.654G	63	5.677G	64	5.434G
65	5.721G	66	5.548G	67	5.709G	68	5.376G
69	5.435G	70	5.723G	71	5.588G	72	5.495G
73	5.291G	74	5.711G	75	5.641G	76	5.337G
77	5.268G	78	5.556G	79	5.564G	80	5.439G
81	5.646G	82	5.449G	83	5.431G	84	5.343G
85	5.509G	86	5.477G	87	5.708G	88	5.506G
89	5.678G	90	5.701G	91	5.570G	92	5.428G
93	5.719G	94	5.656G	95	5.432G	96	5.316G
97	5.323G	98	5.399G	99	5.673G	100	5.298G



A D T

Hopping Frequency Sequence Name: HOP_FREQ_SEQ_24

SEQ#	Frequency (Hz)	SEQ#	Frequency (Hz)	SEQ#	Frequency (Hz)	SEQ#	Frequency (Hz)
1	5.422G	2	5.279G	3	5.469G	4	5.476G
5	5.578G	6	5.473G	7	5.270G	8	5.586G
9	5.257G	10	5.381G	11	5.430G	12	5.274G
13	5.366G	14	5.637G	15	5.643G	16	5.365G
17	5.271G	18	5.337G	19	5.364G	20	5.335G
21	5.681G	22	5.583G	23	5.710G	24	5.719G
25	5.511G	26	5.339G	27	5.520G	28	5.713G
29	5.655G	30	5.522G	31	5.654G	32	5.566G
33	5.413G	34	5.355G	35	5.665G	36	5.577G
37	5.307G	38	5.541G	39	5.446G	40	5.384G
41	5.467G	42	5.659G	43	5.294G	44	5.409G
45	5.698G	46	5.595G	47	5.673G	48	5.718G
49	5.615G	50	5.574G	51	5.599G	52	5.449G
53	5.699G	54	5.526G	55	5.714G	56	5.405G
57	5.484G	58	5.516G	59	5.298G	60	5.720G
61	5.501G	62	5.275G	63	5.642G	64	5.519G
65	5.420G	66	5.267G	67	5.313G	68	5.724G
69	5.550G	70	5.706G	71	5.458G	72	5.453G
73	5.503G	74	5.291G	75	5.707G	76	5.354G
77	5.276G	78	5.660G	79	5.690G	80	5.609G
81	5.392G	82	5.356G	83	5.694G	84	5.489G
85	5.524G	86	5.554G	87	5.653G	88	5.407G
89	5.510G	90	5.532G	91	5.604G	92	5.549G
93	5.383G	94	5.296G	95	5.290G	96	5.629G
97	5.552G	98	5.260G	99	5.557G	100	5.486G



A D T

Hopping Frequency Sequence Name: HOP_FREQ_SEQ_25

SEQ#	Frequency (Hz)	SEQ#	Frequency (Hz)	SEQ#	Frequency (Hz)	SEQ#	Frequency (Hz)
1	5.279G	2	5.589G	3	5.460G	4	5.694G
5	5.399G	6	5.488G	7	5.325G	8	5.285G
9	5.673G	10	5.424G	11	5.449G	12	5.358G
13	5.410G	14	5.660G	15	5.544G	16	5.290G
17	5.698G	18	5.662G	19	5.478G	20	5.386G
21	5.485G	22	5.352G	23	5.640G	24	5.495G
25	5.548G	26	5.392G	27	5.295G	28	5.583G
29	5.395G	30	5.437G	31	5.648G	32	5.310G
33	5.251G	34	5.286G	35	5.263G	36	5.257G
37	5.710G	38	5.629G	39	5.655G	40	5.406G
41	5.387G	42	5.447G	43	5.714G	44	5.327G
45	5.281G	46	5.647G	47	5.627G	48	5.570G
49	5.618G	50	5.663G	51	5.323G	52	5.654G
53	5.556G	54	5.419G	55	5.553G	56	5.405G
57	5.684G	58	5.461G	59	5.309G	60	5.525G
61	5.703G	62	5.268G	63	5.377G	64	5.676G
65	5.600G	66	5.522G	67	5.577G	68	5.351G
69	5.670G	70	5.636G	71	5.657G	72	5.538G
73	5.288G	74	5.385G	75	5.479G	76	5.349G
77	5.622G	78	5.496G	79	5.282G	80	5.315G
81	5.704G	82	5.701G	83	5.321G	84	5.590G
85	5.547G	86	5.651G	87	5.659G	88	5.341G
89	5.320G	90	5.702G	91	5.412G	92	5.284G
93	5.619G	94	5.527G	95	5.343G	96	5.534G
97	5.579G	98	5.514G	99	5.299G	100	5.311G



A D T

Hopping Frequency Sequence Name: HOP_FREQ_SEQ_26

SEQ#	Frequency (Hz)	SEQ#	Frequency (Hz)	SEQ#	Frequency (Hz)	SEQ#	Frequency (Hz)
1	5.653G	2	5.565G	3	5.692G	4	5.359G
5	5.293G	6	5.329G	7	5.640G	8	5.397G
9	5.379G	10	5.283G	11	5.458G	12	5.470G
13	5.605G	14	5.563G	15	5.624G	16	5.722G
17	5.703G	18	5.442G	19	5.619G	20	5.256G
21	5.451G	22	5.273G	23	5.446G	24	5.559G
25	5.598G	26	5.346G	27	5.287G	28	5.543G
29	5.479G	30	5.617G	31	5.490G	32	5.634G
33	5.364G	34	5.591G	35	5.288G	36	5.693G
37	5.524G	38	5.448G	39	5.366G	40	5.302G
41	5.588G	42	5.400G	43	5.401G	44	5.507G
45	5.544G	46	5.393G	47	5.309G	48	5.518G
49	5.667G	50	5.553G	51	5.662G	52	5.552G
53	5.502G	54	5.331G	55	5.643G	56	5.682G
57	5.644G	58	5.686G	59	5.266G	60	5.271G
61	5.384G	62	5.721G	63	5.429G	64	5.596G
65	5.478G	66	5.652G	67	5.292G	68	5.403G
69	5.572G	70	5.656G	71	5.592G	72	5.465G
73	5.326G	74	5.540G	75	5.441G	76	5.408G
77	5.574G	78	5.387G	79	5.601G	80	5.411G
81	5.297G	82	5.564G	83	5.445G	84	5.421G
85	5.335G	86	5.466G	87	5.550G	88	5.269G
89	5.602G	90	5.386G	91	5.449G	92	5.528G
93	5.680G	94	5.623G	95	5.325G	96	5.435G
97	5.661G	98	5.671G	99	5.545G	100	5.321G



A D T

Hopping Frequency Sequence Name: HOP_FREQ_SEQ_27

SEQ#	Frequency (Hz)	SEQ#	Frequency (Hz)	SEQ#	Frequency (Hz)	SEQ#	Frequency (Hz)
1	5.299G	2	5.355G	3	5.568G	4	5.425G
5	5.344G	6	5.574G	7	5.667G	8	5.657G
9	5.412G	10	5.643G	11	5.705G	12	5.701G
13	5.595G	14	5.367G	15	5.695G	16	5.306G
17	5.684G	18	5.373G	19	5.569G	20	5.432G
21	5.527G	22	5.528G	23	5.268G	24	5.277G
25	5.482G	26	5.292G	27	5.342G	28	5.411G
29	5.602G	30	5.422G	31	5.583G	32	5.708G
33	5.653G	34	5.329G	35	5.286G	36	5.543G
37	5.537G	38	5.660G	39	5.511G	40	5.529G
41	5.699G	42	5.688G	43	5.496G	44	5.709G
45	5.489G	46	5.721G	47	5.281G	48	5.486G
49	5.433G	50	5.260G	51	5.673G	52	5.431G
53	5.659G	54	5.714G	55	5.501G	56	5.434G
57	5.530G	58	5.619G	59	5.460G	60	5.467G
61	5.672G	62	5.627G	63	5.541G	64	5.629G
65	5.722G	66	5.309G	67	5.493G	68	5.293G
69	5.477G	70	5.680G	71	5.371G	72	5.378G
73	5.417G	74	5.401G	75	5.648G	76	5.587G
77	5.718G	78	5.503G	79	5.663G	80	5.446G
81	5.698G	82	5.295G	83	5.420G	84	5.634G
85	5.483G	86	5.675G	87	5.683G	88	5.623G
89	5.414G	90	5.553G	91	5.494G	92	5.580G
93	5.713G	94	5.652G	95	5.313G	96	5.396G
97	5.429G	98	5.534G	99	5.251G	100	5.454G



A D T

Hopping Frequency Sequence Name: HOP_FREQ_SEQ_28

SEQ#	Frequency (Hz)	SEQ#	Frequency (Hz)	SEQ#	Frequency (Hz)	SEQ#	Frequency (Hz)
1	5.283G	2	5.630G	3	5.456G	4	5.251G
5	5.465G	6	5.669G	7	5.515G	8	5.603G
9	5.496G	10	5.633G	11	5.421G	12	5.485G
13	5.558G	14	5.423G	15	5.717G	16	5.289G
17	5.567G	18	5.654G	19	5.721G	20	5.508G
21	5.341G	22	5.552G	23	5.254G	24	5.427G
25	5.320G	26	5.555G	27	5.467G	28	5.405G
29	5.544G	30	5.698G	31	5.252G	32	5.287G
33	5.428G	34	5.493G	35	5.330G	36	5.344G
37	5.348G	38	5.374G	39	5.280G	40	5.398G
41	5.489G	42	5.466G	43	5.432G	44	5.645G
45	5.275G	46	5.337G	47	5.497G	48	5.471G
49	5.720G	50	5.667G	51	5.566G	52	5.712G
53	5.513G	54	5.676G	55	5.416G	56	5.477G
57	5.694G	58	5.589G	59	5.554G	60	5.569G
61	5.623G	62	5.672G	63	5.655G	64	5.675G
65	5.579G	66	5.487G	67	5.462G	68	5.636G
69	5.277G	70	5.559G	71	5.631G	72	5.680G
73	5.611G	74	5.649G	75	5.562G	76	5.479G
77	5.573G	78	5.671G	79	5.495G	80	5.627G
81	5.524G	82	5.470G	83	5.665G	84	5.590G
85	5.707G	86	5.461G	87	5.548G	88	5.392G
89	5.332G	90	5.434G	91	5.677G	92	5.424G
93	5.518G	94	5.259G	95	5.358G	96	5.378G
97	5.605G	98	5.526G	99	5.602G	100	5.290G



A D T

Hopping Frequency Sequence Name: HOP_FREQ_SEQ_29

SEQ#	Frequency (Hz)	SEQ#	Frequency (Hz)	SEQ#	Frequency (Hz)	SEQ#	Frequency (Hz)
1	5.643G	2	5.627G	3	5.509G	4	5.513G
5	5.614G	6	5.686G	7	5.286G	8	5.694G
9	5.458G	10	5.379G	11	5.630G	12	5.257G
13	5.579G	14	5.421G	15	5.538G	16	5.287G
17	5.360G	18	5.505G	19	5.467G	20	5.520G
21	5.527G	22	5.250G	23	5.451G	24	5.489G
25	5.518G	26	5.350G	27	5.439G	28	5.598G
29	5.311G	30	5.357G	31	5.670G	32	5.355G
33	5.335G	34	5.433G	35	5.480G	36	5.368G
37	5.268G	38	5.332G	39	5.650G	40	5.325G
41	5.625G	42	5.427G	43	5.645G	44	5.601G
45	5.547G	46	5.361G	47	5.385G	48	5.619G
49	5.536G	50	5.373G	51	5.511G	52	5.575G
53	5.569G	54	5.364G	55	5.673G	56	5.376G
57	5.352G	58	5.711G	59	5.664G	60	5.516G
61	5.454G	62	5.689G	63	5.543G	64	5.443G
65	5.626G	66	5.363G	67	5.578G	68	5.657G
69	5.265G	70	5.648G	71	5.521G	72	5.503G
73	5.395G	74	5.276G	75	5.484G	76	5.466G
77	5.636G	78	5.340G	79	5.346G	80	5.668G
81	5.291G	82	5.655G	83	5.683G	84	5.542G
85	5.618G	86	5.658G	87	5.426G	88	5.546G
89	5.529G	90	5.606G	91	5.556G	92	5.557G
93	5.367G	94	5.338G	95	5.501G	96	5.317G
97	5.440G	98	5.528G	99	5.494G	100	5.401G



A D T

Hopping Frequency Sequence Name: HOP_FREQ_SEQ_30

SEQ#	Frequency (Hz)	SEQ#	Frequency (Hz)	SEQ#	Frequency (Hz)	SEQ#	Frequency (Hz)
1	5.453G	2	5.662G	3	5.339G	4	5.638G
5	5.306G	6	5.537G	7	5.311G	8	5.312G
9	5.368G	10	5.323G	11	5.535G	12	5.512G
13	5.670G	14	5.354G	15	5.450G	16	5.267G
17	5.392G	18	5.454G	19	5.403G	20	5.709G
21	5.278G	22	5.582G	23	5.597G	24	5.447G
25	5.700G	26	5.482G	27	5.655G	28	5.559G
29	5.632G	30	5.536G	31	5.255G	32	5.291G
33	5.503G	34	5.723G	35	5.642G	36	5.346G
37	5.510G	38	5.690G	39	5.584G	40	5.321G
41	5.445G	42	5.434G	43	5.604G	44	5.551G
45	5.693G	46	5.279G	47	5.326G	48	5.350G
49	5.336G	50	5.334G	51	5.277G	52	5.438G
53	5.394G	54	5.583G	55	5.507G	56	5.379G
57	5.578G	58	5.457G	59	5.671G	60	5.579G
61	5.427G	62	5.477G	63	5.504G	64	5.437G
65	5.634G	66	5.563G	67	5.516G	68	5.573G
69	5.374G	70	5.692G	71	5.621G	72	5.414G
73	5.384G	74	5.474G	75	5.446G	76	5.449G
77	5.637G	78	5.708G	79	5.648G	80	5.687G
81	5.715G	82	5.554G	83	5.527G	84	5.399G
85	5.684G	86	5.362G	87	5.509G	88	5.282G
89	5.469G	90	5.689G	91	5.429G	92	5.703G
93	5.341G	94	5.607G	95	5.398G	96	5.406G
97	5.342G	98	5.382G	99	5.531G	100	5.600G

10 APPENDIX-C MASTER MODE



A D T

NOTCH BAND IN 5600-5650MHz

Verify that the 5600 - 5650 MHz band is notched.
Test results demonstrating last channel shall not exceed the band edge on 5600~5650MHz.

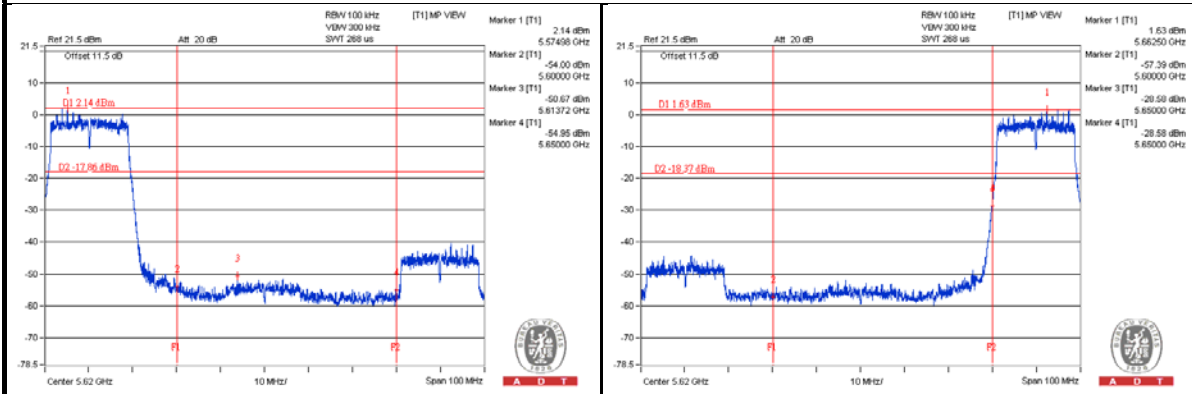

802.11ac (VHT20) MODULATION
(CH 116: 5580MHz)

802.11ac (VHT20) MODULATION
(CH 132: 5660MHz)

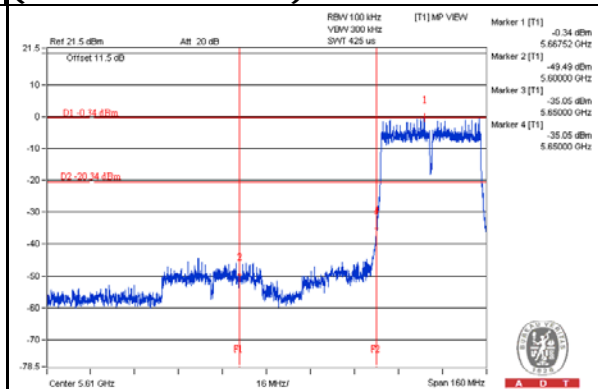
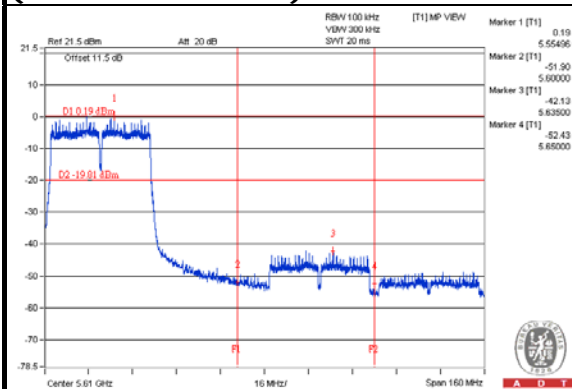

802.11ac (VHT40) MODULATION
(CH 110: 5550MHz)

802.11ac (VHT40) MODULATION
(CH 134: 5670MHz)

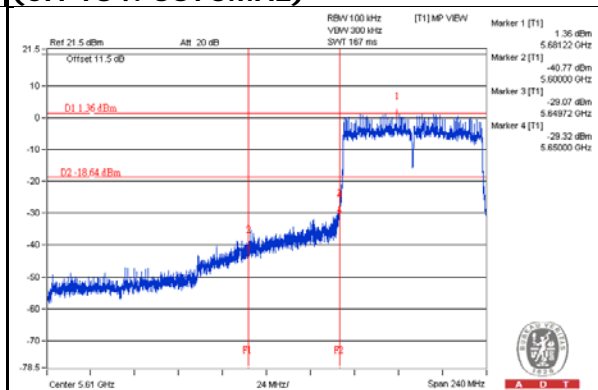
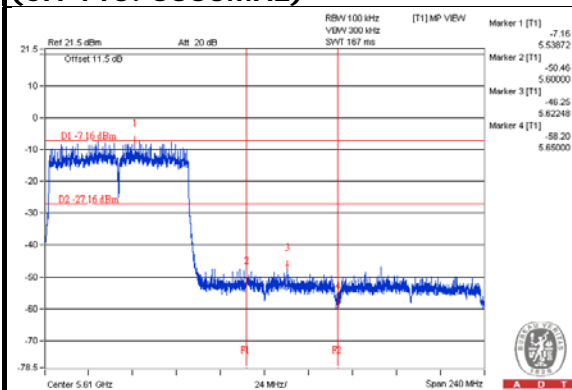

802.11ac (VHT80) MODULATION
(CH 106: 5530MHz)

802.11ac (VHT80) MODULATION
(CH 138: 5690MHz)

---END---