

Instruction Manual

Automatic Upper Arm Blood Pressure Monitor



Model No. HL858CJ

Table of Contents

Medical Disclaimer.....	03
Intended Use.....	03
About Blood Pressure.....	04
Measurement Method.....	06
Accuracy.....	07
Precautions.....	08
Device Overview.....	10
Symbol Definitions.....	12
Features.....	14
Installing Batteries.....	20
Using the AC/DC adapter.....	21
Applying the Cuff.....	22
Selecting the Correct Cuff Size.....	23
Measurement Procedure.....	24
Bluetooth Transmission.....	28
Memory Function.....	31
Storage and Maintenance.....	34
Troubleshooting.....	35
Warranty.....	36
Specifications.....	37
Note.....	39
Appendix.....	41
Blood Pressure Diary.....	43

Medical Disclaimer

This manual and product are not meant as a substitute for advice provided by your doctor.

You are not to use the information contained herein, or this product for diagnosing or treating a health problem or prescribing any medication. If you have or suspect that you have a medical problem, promptly consult your healthcare provider.

Intended Use

HL858CJ automatically measures human's Systolic, Diastolic blood pressure and heart rate by using the oscillometric method during inflation. All values can be read out in one LCD panel. Measurement position is at human being's upper arm. The intended use of this over-the-counter device is for adults aged 18 years and older with arm circumference ranging from 9 inches to 22 inches (approx.23 cm to 56 cm) and for home use.

The device can accurately measure blood pressure in pregnant patients including those with known or suspected in pre-eclampsia condition.

HL858CJ detects the appearance of irregular heartbeats during measurement; an indicated symbol will appear with measuring reading. And the Risk Category Indicator will show the information with the readings on the screen for the user tracking their blood pressure level.

Besides, the device features a built-in "Bluetooth Data Transmission" function, which enables the device automatically transmit measuring results to paired Bluetooth-enabled device. Also, users could simply synchronize the current date and time, and check the battery status of blood pressure monitor by means of DailyChek® application software with the paired Bluetooth-enabled device.

About Blood Pressure

1. What is blood pressure?

Blood pressure is the measurement of the force of blood pushing against the walls of the arteries. Arterial blood pressure is constantly fluctuating during the course of the cardiac cycle. The highest pressure in the cycle is called the systolic blood pressure, and represents the pressure in the artery when the heart is beating. The lowest pressure is the diastolic blood pressure, and represents the pressure in the artery when the heart is at rest. Both the systolic and the diastolic pressure are necessary for a physician to evaluate the status of a patient's blood pressure.

Many factors such as physical activity, anxiety or the time of day, can influence your blood pressure. Blood pressure is typically low in the mornings and increases from the afternoon to the evening. It is on average lower in the summer and higher in the winter.

2. Why is it useful to measure blood pressure at home?

Having one's blood pressure measured by a doctor in a hospital or a clinic, is often associated with an event called "White Coat Hypertension" where the patient becomes nervous or anxious, thus raising his blood pressure. There are also numerous other factors that might cause your blood pressure to be raised at a specific time of day. This is why medical physician recommend home monitoring as it is important to get readings of blood pressure during different times of the day to really get an idea of your real blood pressure.

Medical physicians generally recommend the "Rule of 3", where you are encouraged to take your blood pressure three times in a row (at 3 ~ 5 minute interval), three times a day for three days. After three days you can average all the results and this will give you an accurate idea of what your blood pressure really is.

About Blood Pressure

A. AHA blood pressure classifications:

Standards for assessment of high or low blood pressure without regard to age, have been established by the American Heart Association (AHA 2017), as shown in the below chart.

BLOOD PRESSURE CATEGORY	SYSTOLIC mm Hg (upper number)		DIASTOLIC mm Hg (lower number)
NORMAL	LESS THAN 120	and	LESS THAN 80
ELEVATED	120-129	and	LESS THAN 80
HIGH BLOOD PRESSURE (HYPERTENSION) STAGE 1	130-139	or	80-89
HIGH BLOOD PRESSURE (HYPERTENSION) STAGE 2	140 OR HIGHER	or	90 OR HIGHER
HYPERTENSIVE CRISIS (consult your doctor immediately)	HIGHER THAN 180	or	HIGHER THAN 120

However this chart is not exact for classification of blood pressure and it's intended to be used as a guide in understanding non-invasive blood pressure measurements. Please consult with your physician for proper diagnosis.

B. Variations in blood pressure:

Individual blood pressures vary greatly both on a daily and a seasonal basis. These variations are even more pronounced in hyper tense patients. Normally the blood pressure rises while at work and is at its lowest during sleeping period.

(hyper tense: means a person who has high blood pressure symptom.)

The graph below illustrated the variations in blood pressure over a whole day with measurement taken every five minutes.

The thick line represents sleep. The rise in blood pressure at 4 PM (A in the graph) and 12 AM (B in the graph) correspond to an attack of pain.

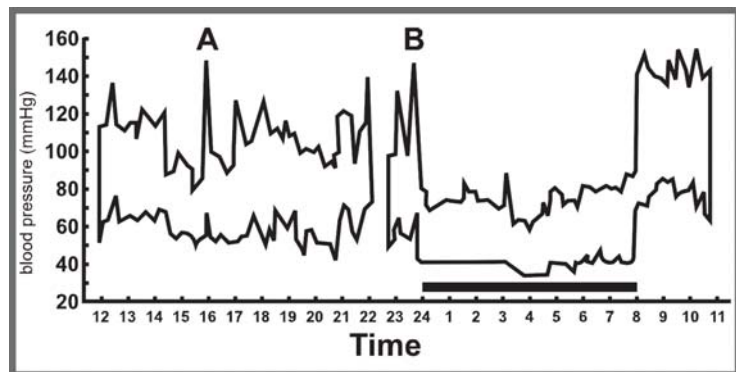

(Direct arterial pressure recording in unrestricted man. Beven, Honour & Stott: Clin. Sci. 36:329. 1969)

Measurement Method

HL858CJ Automatic Upper Arm Blood Pressure Monitor measures blood pressure and heart rate by oscillometric method, meaning the fluctuations in pressure are measured. Once the cuff is wrapped around your upper arm, just turn on the monitor and inflation automatically starts. The inflation of the cuff creates pressure around the arteries inside upper arm.

Within the cuff is a gauge which senses the fluctuations (oscillations) in pressure. The fluctuation measured represents the degree of intensity that your arteries contracting with each heart beat, and also a result of the pressure that the cuff has placed on the upper arm. The monitor measures these contractions and converts the information to a digital value. This is the result displayed on the monitor screen.

Once the measurement is complete, the cuff will automatically deflate.

Note!

- * The patient is an intended operator.
- * The applied part is the cuff.

Accuracy

HL858CJ Automatic Upper Arm Blood Pressure Monitor has been clinically tested against a scientific device called *mercury sphygmomanometer*, considered the gold standard in blood pressure measurement.

All HL858CJ Automatic Upper Arm Blood Pressure Monitors have performed equivalent to measurements taken with this scientific device and are within the accuracy limits prescribed by the American National Standard for Electronic or Automated Sphygmomanometers.

The SPHYGMOMANOMETER was clinically investigated according to the requirements of ISO 81060-2:2013.

In case it is needed to have the device checked for calibration, please consult the distributor.

Precautions

- * Read the Instruction Manual thoroughly before measuring and keep it at hand for your reference at any time.
- * The device is designed for home use and not suitable for clinical use.
- * This monitor is not intended for use in the MR environment.

- ❑ Do not take a measurement in a low (less than 41 °F/5 °C) and high (more than 104 °F/40 °C) temperature, nor in a place outside humidity ranges (15 % ~ 93 % R.H.), and atmospheric pressure ranges (700 ~ 1060 hPa), or you may get inaccurate readings.
- ❑ Wait 30 ~ 45 minutes before measurement if you've just consumed caffeinated beverages or smoked cigarettes.
- ❑ Rest at least 5 ~ 10 minutes before taking a measurement.
- ❑ To allow your blood vessels to return to the condition prior to taking the measurement, please wait at least 3 ~ 5 minutes in between measurements. You may need to adjust the wait time according to your personal physiological situation.
- ❑ We recommend you using the same arm (preferably the left arm) and measuring around the same time each day.
- ❑ Perform measurements in a quiet and relaxed environment at room temperature.
- ❑ Do not move or shake the device during a measurement. Please keep quiet and do not talk, move or shake during measurements.
- ❑ If the patient moves, the cuff is touched, or the cuff slipping during the measurement, this may be falsely detected as a pulse and cause inaccurate blood pressure measurement.
- ❑ If you are pregnant, you should pay more attention to your blood pressure changes, because during this time, it may change drastically.
- ❑ This monitor is clinically validated for use in pregnancy and pre-eclampsia. When you detect unusual readings in pregnancy, you should measure again after taking some rest. If the reading is still abnormal, consult your doctor or gynecologist.
- ❑ This product is not suitable for:
 - People with arrhythmias
 - Undergoing intravenous injection on any limb
 - Currently in a dialysis treatment

Precautions

- ❑ For those who have had mastectomy surgery (especially whose' lymph nodes removed), it's recommend take a measurement on the unaffected side.
- ❑ When used among medical electronic equipments on the same limb, pressurization of the cuff may cause temporarily malfunction to other devices.
- ❑ If you have one of the circulatory problems as arteriosclerosis, diabetes, liver disease, kidney disease, severe hypertension, peripheral circulation....., please consult your healthcare professional before using the device.
- ❑ If the cuff is worn improperly, or the shape of the upper arm is unusual (for example, the circumference of the upper arm differs largely from the circumference of the forearm), excessive gap might exist between the arm cuff and the arm, and it might lead to measurement errors or inaccuracies. If you have any question about the cuff wearing and/or measurement result, please consult your healthcare professional.
- ❑ Blood pressure measurements determined with this device are equivalent to those obtained by a trained observer using the cuff/stethoscope auscultation method and are within the accuracy limits prescribed by the American National Standard for Manual, electronic, or Automated Sphygmomanometers.

****Attention !***

1. Do not use the device on infants, children, or those who cannot express their own intention. To avoid accidental strangulation, keep this product away from children and do not drape tube around neck.
2. The medical device should not use adjacent to or stacked with other equipment. In case adjacent or stacked use is necessary. The medical device should be observed to verify normal operation in the configuration in which it will be used.
3. Consider the electromagnetic compatibility of the device (ex. power disturbance, radio frequency interference etc.) Please use it indoor only.
4. Over high frequency measurements may result in blood flow interference, which is likely to cause uncomfortable sensations, such as partial subcutaneous hemorrhage, or temporary numbness to your arm. In general, these symptoms should not last long. However, if you do not recover in time, please seek your medical practitioners for help.

Device Overview

◆ Part names and product components

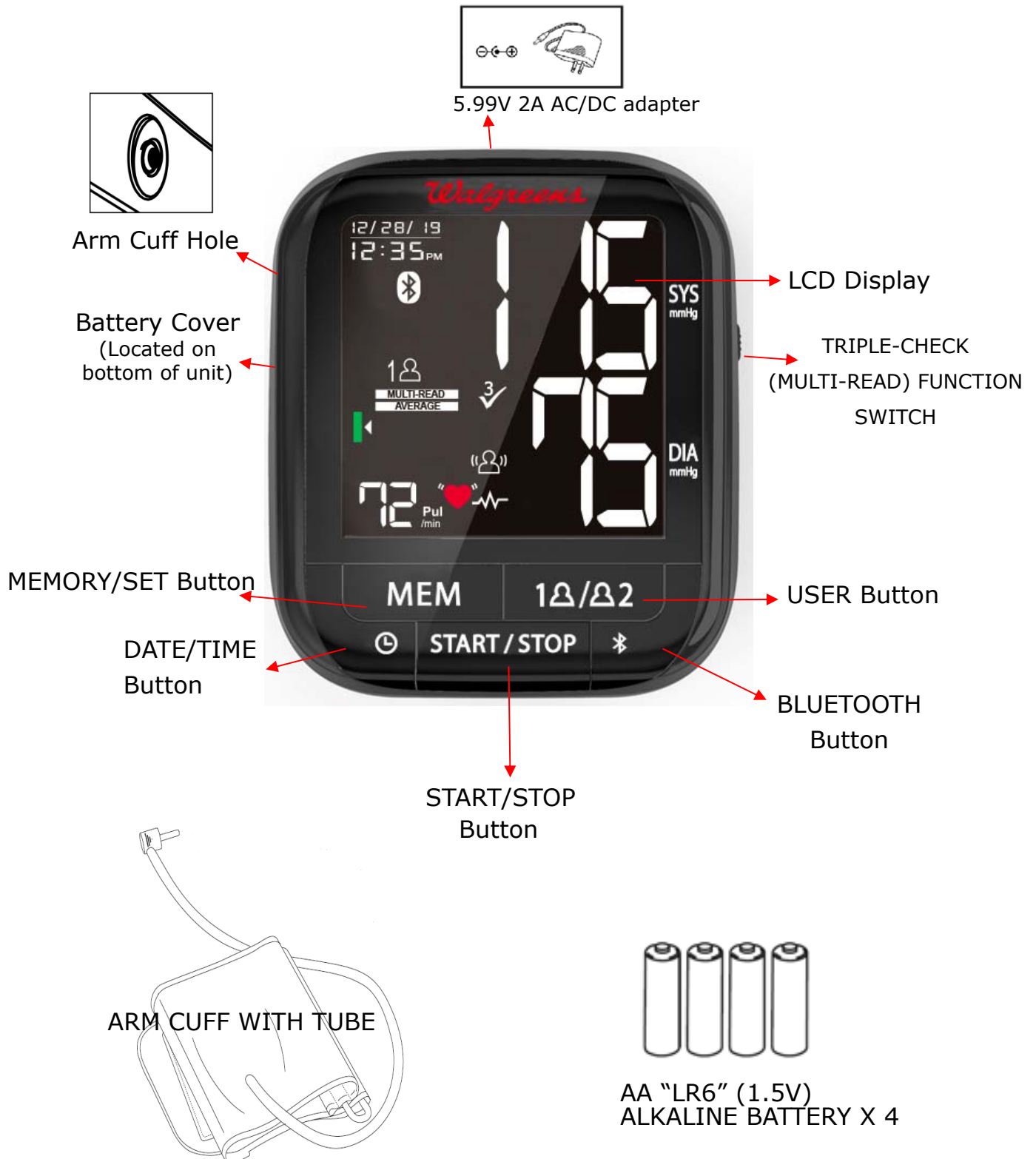





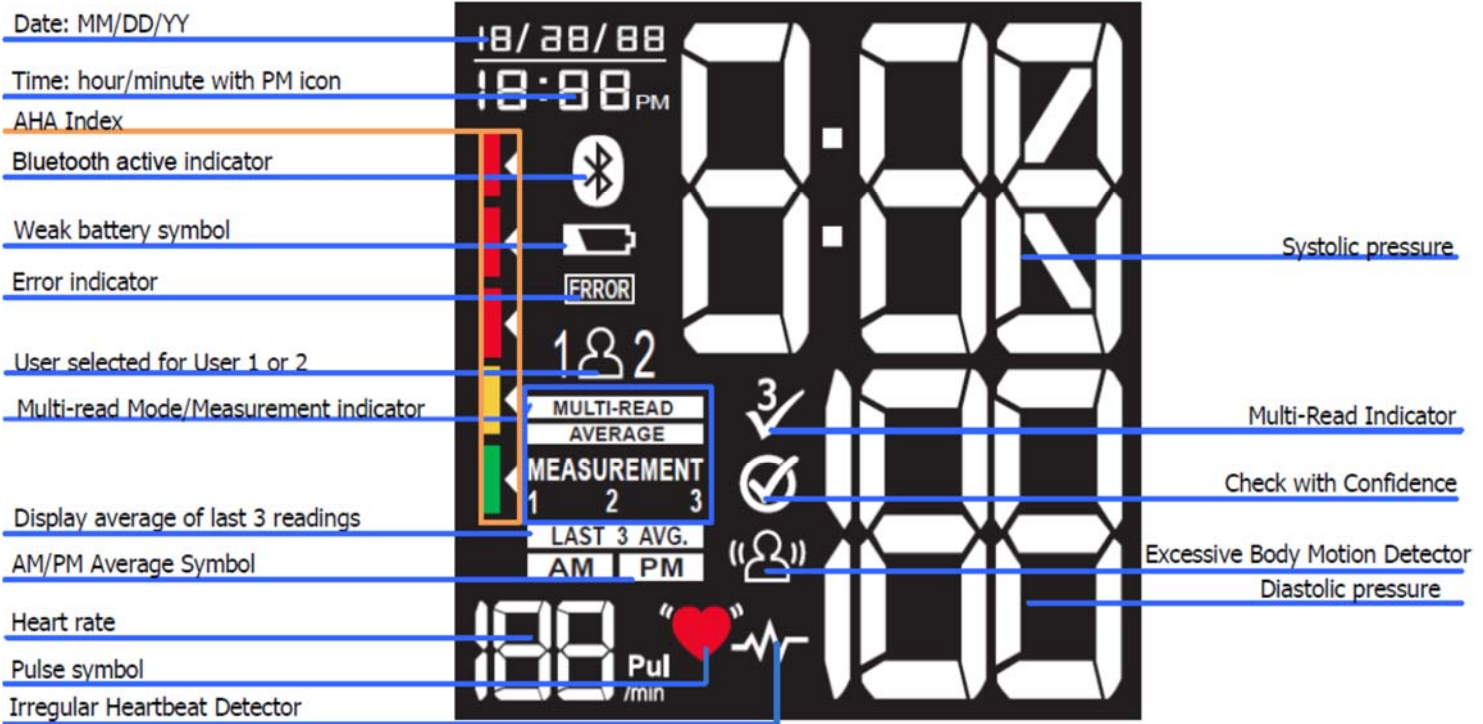







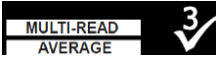

Device Overview

◆ Unit display



Symbol Definitions

SYMBOLS	Definitions
 Low Battery Symbol	<p>This symbol appears when the battery power is extremely low or the polarity reverses.</p> <p>➔ We suggest you replace all batteries with new ones, and make sure the +/- polarities are properly positioned.</p>
 Error Symbol	<p>Error Symbol: Error display.</p>
 AHA Index	<p>The arrowhead points out the specific Risk Category that your measurement reading fits in. See page 14 for more information.</p>
 Triple-Check (Multi-Read) Function Symbol	<p>Triple-Check (Multi-Read) Function Symbol: Appears when Triple-Check (Multi-Read) function is turned On.</p>
 Average Symbol	<p>Average Symbol: Displayed when viewing a Triple-Check average.</p>
 Bluetooth Symbol	<p>Under Bluetooth Data Transmission / Link Mode, LCD displays this symbol.</p>
 Triple-Check (Multi-Read) Function Result	<p>Triple-Check (Multi-Read) Function Result: Indicates which measurement is being taken, or which measurement is being viewed from a Triple-Check (Multi-Read) average reading.</p>
 Memory Average	<p>Memory Average: Display average of last 3 readings.</p>
 AM/PM Averaging	<p>AM/PM Averaging: Indicates the reading being displayed is an average from the last 3 morning or last 3 evening measurements.</p>
 User 1	<p>User 1: Appears when the monitor is operated by User 1.</p>
 User 2	<p>User 2: Appears when the monitor is operated by User 2.</p>
 Excessive Body Motion Detector	<p>Displayed if body movement is detected during measurement, especially, the movement on the arm the blood pressure monitor is worn on. Besides, if cuff is worn improperly, or the shape of the upper arm is unusual (for example, the circumference of the upper arm differs largely from the circumference of the forearm), excessive gap might exist between the arm cuff and the arm.</p>

	Notice: The measured blood pressure reading may not be accurate if the icon is displayed.
 Pulse Symbol	Once pulse is detected, the symbol flashes with each pulse beat.
 Irregular Heartbeat Detector	This symbol appears when an irregular heart beat was detected. → Our suggestion: Repeat the measurement after resting for at least 5 minutes, and restart your measurement while sitting down comfortably and quietly. If symbols appear frequently, please contact your physician.
 Check-with-Confidence	Appears during the "Check-with-Confidence" function is working.

Features

◆ Risk Category Indicator (AHA 2017)

This device is equipped with Risk Category Indicator which classifies your blood pressure measurements into five stages (Normal, Elevated, Hypertension stage 1, Hypertension stage 2 and Hypertensive crisis) based on the blood pressure standards established by the American Heart Association (AHA). Besides, for yours and your loved ones' health, we further classify the five stages into numeral ranges, which sorts out hypertension symptoms more clearly. Moreover, to your convenience and readability, we use three corresponding colors to represent your measuring result. Refer to below comparison chart for details:

BLOOD PRESSURE CATEGORY	SYSTOLIC mm Hg (upper number)		DIASTOLIC mm Hg (lower number)		INDICATOR COLOR
NORMAL	<120	and	< 80		Green
ELEVATED	120-129	and	< 80		Yellow
HIGH BLOOD PRESSURE (HYPERTENSION) STAGE 1	130-139	or	80-89		Red
HIGH BLOOD PRESSURE (HYPERTENSION) STAGE 2	140-180	or	90-120		
HYPERTENSIVE CRISIS (consult your doctor immediately)	>180	or	>120		

After measurement, LCD displays the systolic and diastolic pressure, heart rate, date and time along with Risk Category Indicator symbols. Compare the symbol of LCD display, to know the classification of your blood pressure based on American Heart Association standard (AHA 2017).

Features

***Note !**

When a person's systolic and diastolic pressures fall into different categories, the higher category should apply.

e.g. systolic rate 181 & diastolic rate 99 ⇒ Red category (Hypertensive crisis)

e.g. systolic rate 110 & diastolic rate 95 ⇒ Red category (Hypertension stage 2)

***Note !**

The above table is not exact for classification of blood pressure and it's intended to be used as a guide in understanding non-invasive blood pressure measurements.

Usually this is not a cause for concern; however we recommend you consult with your physician for proper diagnosis or seek medical advice according to our recommendation mentioned above. Please note that the device does not appropriate to diagnose hypertension, and it is only for user reference on blood pressure monitoring.

◆ Triple-Check (Multi-Read) Function

The Triple-Check (Multi-Read) Function automatically takes and averages 3 readings in a row, with 1 minute rest intervals in between each measurement. To deactivate this feature and take only a single reading, slide the switch on the back to the OFF position.

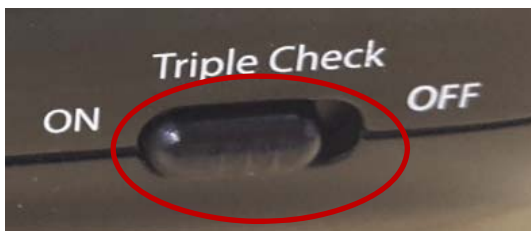

Features

◆ Irregular Heartbeat Detector

The symbol  will appear on screen indicating a certain heartbeat irregularity was detected during measurement.

The heartbeat rhythm that is more than or less than 25% from the average rhythm is usually defined as an irregular heartbeat rhythm. An irregular pulse during the measurement can result in the appearance of this symbol.

Usually this is not a cause for concern, however if the symbol appears often, we recommend you seek medical advice.

And please note that the device does not replace a cardiac examination, but serves to detect pulse irregularities at an early stage.

**Note !*

- The pulse display is not suitable for checking the frequency of heart pacemakers. If a certain pulse irregularity is detected during measurement often, we recommend you seek medical advice
- As a safeguard, we recommend that if you have arrhythmias such as atrial or ventricular premature beats and atrial fibrillation or any other special conditions you should check with your physician before using your device.
- The IHB function is not designed for use by people with arrhythmias nor for diagnosing or treating an arrhythmic problem. In order to filter the unstable status of user and avoid affecting the detection of heart rate from any movement, shaking or talking in the beginning of measurement, the method of averaging heart beat intervals of subject device is calculated with the three proper heart beat pulses detected in the beginning of measurement and that is different from a strict mathematical averaging of all recorded intervals.
- At least 3 beats with at least 25% difference from the average heart beat interval will generate the IHB icon on the screen.

Features

◆ Bluetooth Data Transmission

HL858CJ features a built-in "Bluetooth Data Transmission" function, which enables the device automatically transmit measuring results to paired Bluetooth-enabled device after measurement. When connection established, BPM would transmit memory data such as Measure Date, Systolic, Diastolic and Pulse to the Bluetooth enabled device.

If paired Bluetooth-enabled device is not working or is not within RF range of this device, the measuring results will be stored in the blood pressure monitor's memory. Besides, user can press "  " button for one time to open the Bluetooth function.

Bluetooth compatibility with blood pressure monitor for Bluetooth-enabled device is:

- Bluetooth 4.0 for Android 6.0 or above
- Bluetooth 4.0 for iOS 7.0 or above

**Note !*

- HL858CJ is subject to and complies with electromagnetic compatibility (EMC) standard of IEC 60601-1-2, EN 301 489-1, EN 301 489-17, EN 300 328 and U.S. federal guidelines, Part 15 of the FCC (Federal Communications Commission) rules for devices with RF capability. These guidelines help ensure that your device will not affect the operation of other nearby devices. Additionally, other devices should not affect the use of your device.
- Other wireless devices that are in use nearby, such as a cell or mobile phone, or a wireless network, may prevent or delay the transmission of data from your device to paired Bluetooth-enabled device. Moving away from the source of the interference or turning off these devices to resolve the problem.
- Make sure HL858CJ and paired Bluetooth-enabled device are within acceptable distance (no more than 10 meters) with each other. If not, put them closer.
- Be sure to select the correct User on the monitor before your blood pressure measurement begins.
- Bluetooth data transmission is not available under measurement.

Features

◆ Application Software for Bluetooth

To fully utilize this feature, users need to ensure Bluetooth support of Wireless (usually under settings menu) on their Android or iOS device for contactless data exchange. Then, download and install “**DailyChek®**” application software from Google Play on the Bluetooth-enabled device which is compatible with Android 6.0 or iOS 7.0 or above. Please follow the following steps for installing:

1. To install **DailyChek®** FREE APP, go to the Google Play™ APP store, and search for **DailyChek®**.
2. Click the **INSTALL** button. Once installed, click on **DailyChek®** APP icon.
3. Now you can start using your Android version or iOS version of **DailyChek®** APP with Bluetooth feature, it’s a simple tool to log, track and trend your test results from your Bluetooth-enabled Device.

**Note !*

1. **DailyChek®** Software Manual contains explanations of functions and instructions of how to activate them.
2. Access **DailyChek®** Software Manual via **DailyChek®** Application Software to completely utilize this feature.

Features

◆ Check-with-Confidence

This device features a built-in “Check-with-Confidence” function, which enables the device automatically perform a self-check. It provides a convenient way to check and ensure the device can be worked well.

The Check-with-Confidence default setting is “ON.” To turn this feature “OFF”, press the **START/STOP** button for 3 seconds in Sleeping Mode.



Check-with-Confidence
feature ON



Check-with-Confidence
feature OFF

On first use, then on every 30th use, the cuff will partially inflate and then deflate. The monitor will display “OK”, confirming the monitor is working properly. If the monitor is not working properly, “Err” will be displayed on the screen.



Note:

If you Press and hold **MEM** and **START/STOP** buttons at the same time, the “Check-with-Confidence” will be reset. The device will be automatically perform the function on the next measurement.

Installing Batteries

When LOW BATTERY SYMBOL  appears on the display, or no reaction toward operation, please change batteries.

Replace all worn-out batteries with new ones and do not mix new and used batteries. Do not mix alkaline, standard (carbon-zinc) or rechargeable (cadmium) batteries either. Such action may shorten the battery life or cause the device to malfunction.

Slide the battery cover and insert 4 AA (1.5V, LR6) alkaline batteries into the battery compartment as shown on the figure below. Make sure the polarities "+" and "-" ends are coinciding with similar markings engraved on the battery housing.

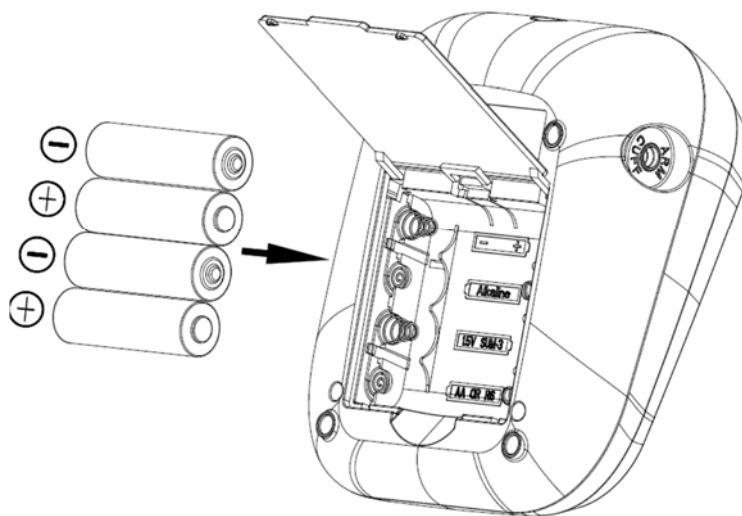

***Attention !**

- Batteries are hazardous waste. Do not dispose of them together with the household garbage. Please discard worn-out batteries to the recycling site according to local regulations.
- Keep the battery away from children in case they choke on it.
- To prolong the battery life and prevent damage caused by leakage, remove the batteries from the device if the device is not to be used for a long period.
- Memories (if any) will not be deleted during battery replacement.
- After replacing the batteries, reset date and time.
- Please replace all worn-out batteries with new ones when you are operating the Bluetooth transmission function, and the LOW BATTERY SYMBOL  appears on the display.

Using the AC/DC adapter

This monitor is designed for operation with batteries or an AC/DC adapter.

Please use only a compatible AC/DC adapter with required voltage and current as indicated in this manual.

**Note !*

No batteries are needed when operating with an AC/DC adapter.

Please unload the batteries when operating with an AC/DC adapter for an extended period of time.

Leaving the batteries in the compartment for a long time may cause leakage, which may lead to damage of the unit.

Recommend Adapter specification, do not use otherwise:

Model: SINPRO, HPU15-102

Rating:

Input: 100 ~ 240V, AC, 47 ~ 63 Hz, 0.4 ~ 0.2 A

Output: 5.99V, DC, 2A, 

**Note !*

When you use the blood pressure monitor with AC/DC adapter, do not position the device to make it difficult to disconnect the adapter plug.

Applying the Cuff

- ❑ Wrap the cuff on a bare arm or over thin clothing. Thick clothing or a rolled up sleeve will cause inaccurate blood pressure measurements.
- ❑ Press your brachial artery approximately 1 inch (2 ~ 3 cm) above the elbow on the inside of your left arm to determine where your strongest pulse is.
- ❑ Slide the end of arm cuff furthest from the tube through the metal ring to a loop. The smooth cloth should be on the inside of the cuff.
- ❑ If the cuff is located correctly, the velcro will be on the outside of the cuff and metal ring will not touch your skin.

- ❑ Put left arm through the cuff loop. The tube should lie over the brachial artery on the inner part of the arm.
 - Universal cuff 9 ~17 inches (23~43cm):
The bottom edge of the cuff should be 2 ~ 3 cm (approx. 1 inch) above the inner elbow.
 - Extra Large cuff: 17 ~22 inches (43~56 cm)
The bottom edge of the cuff should be above the inner elbow crease.
- ❑ Pull the cuff so that the top and bottom edges are tightened around your arm, please make sure the cuff do not slip during measurement, and the arrow falls within the Proper Fit Range.

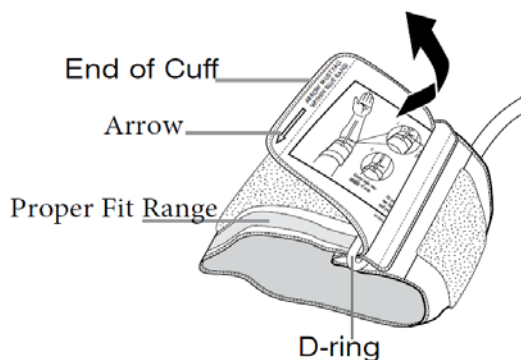

- ❑ When the cuff is positioned properly, press the velcro firmly against the pile side of the cuff.
- ❑ Sit on a chair comfortably, put your feet flat on the floor and lay your forearm on the table, make sure your back and arm supported, legs uncrossed, so that the cuff is at the same level as your heart.
- ❑ Relax your arm and turn your arm upward.
- ❑ Make sure there are no kinks in the air tube.

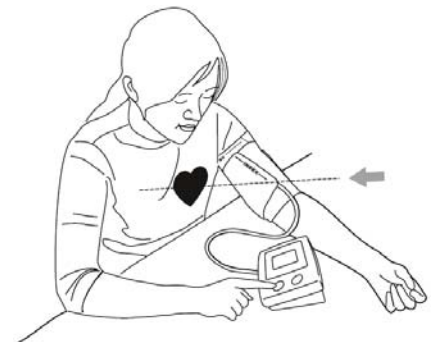

***Note !**

- Fit the cuff snugly, leaving enough space for 1 inch (2 ~ 3 cm) between the inner elbow and the lower edge of the cuff, or the measurement may not be accurate.
- This monitor available with two size arm cuffs: 9" ~ 17" (23 ~ 43 cm) and 17" ~ 22" (43 ~ 56 cm).
- In case the cuff kept pumping up non-stop, open the cuff at once.
- Do not wrap the cuff around any body part other than your arm.
- The device is not supposed to be used when your arm is wounded or injured.

Selecting the Correct Cuff Size

Please make sure you the appropriate cuff size is selected. Use the appropriate cuff size to ensure accurate measurements. If an oversized cuff is used, the measured blood pressure value tends to be lower than the actual blood pressure. If an undersized cuff is used, the measured blood pressure value tends to be higher.

This device available with two size cuffs, you can choose the appropriate cuff according to your arm size.

Universal cuff: 9 ~17 inches (23~43cm)

Extra Large cuff: 17 ~22 inches (43~56 cm)

Keeping your arm rests on the table, measure the circumference of your upper arm at the midpoint between the shoulder and elbow. Select the cuff that is suitable for you in below chart.

Cuff Size	Arm circumference
Universal	9" - 17" (23 - 43 cm)
Extra Large(XL)	17" - 22" (43 - 56 cm)

*Extra Large cuff is sold separately.

Measurement Procedure

◆ Switch on the Monitor

- Put in 4 AA 1.5V (LR6) alkaline batteries.
- All segments appear on the screen for 3 seconds.
- The monitor will automatically turn to sleeping mode (all LCD segment cleared).

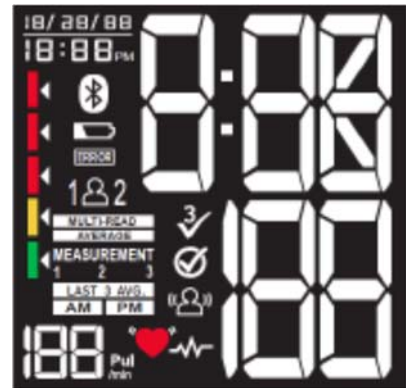

Note:

The Check-with-Confidence icon shown or not decided by the function enabled or disabled.

◆ Setting Year, Time and Date

- Press **⌚** button ("MONTH" flashes). Press **MEM** button to adjust MONTH value (1, 2, 3,....., 12).
- Press **⌚** button ("DATE" flashes). Use **MEM** button to adjust DATE value (1, 2, 3,....., 31).
- Adjust YEAR, HOUR (1, 2, 3,.....12^{PM}, 1^{PM},....., 12) and MINUTE (00,01,02,03,.....59) as described in Step A above.
- When settings are done, press **⌚** button to confirm the entries. The device is ready to measure.

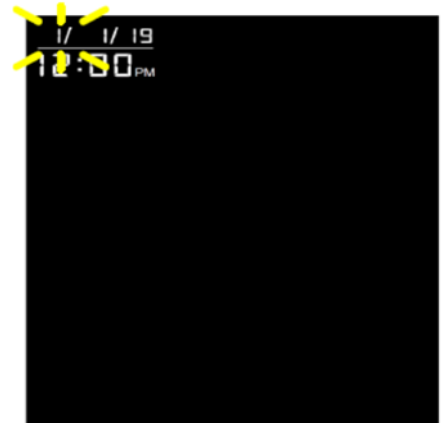

Measurement Procedure

◆ Turning Bluetooth Feature ON/OFF

User can press and hold  button 3 seconds to turn the Bluetooth feature ON/OFF in Sleeping Mode.

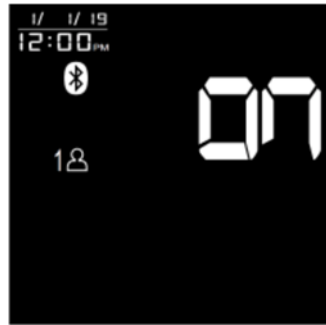

Bluetooth feature ON

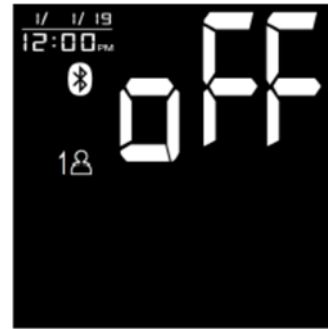

Bluetooth feature OFF

Note: The Bluetooth Feature Switch default setting is ON

◆ Taking a Measurement

- A. Check and select functions of Triple-Check (Multi-Read) Mode if needed.

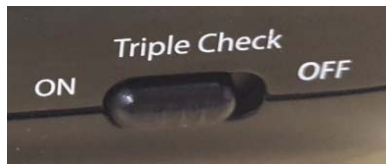

1. If functions of Triple-Check (Multi-Read) Mode is on, press **START/STOP** key to start multi-measurement.
2. If functions of Triple-Check (Multi-Read) Mode is off, press **START/STOP** key to start single measurement.

Note: The triple-check average Switch default setting is OFF

Measurement Procedure

- B. Under Standby Mode, press **1△/△2** button to select User 1, 2.

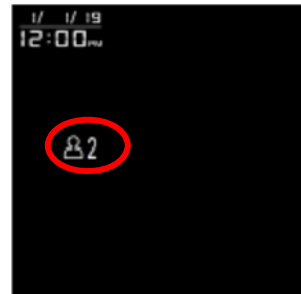
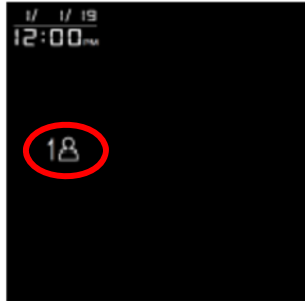

C. **Start a Single Measurement:**

1. Make sure the Triple-Check (Multi-Read) function switch turned off.
2. With the cuff wrapped around your upper arm, press **START/STOP** button to start the measurement. All display units appear on the screen for 1.5 seconds.
3. As the cuff inflates, the monitor automatically determines your ideal inflation level. This monitor detects your blood pressure and pulse rate during inflation. The Heartbeat Symbol (♥) flashes at every heartbeat. Remain still and do not move until the entire measurement process is completed. The device will detect your pulse and determine the measurement.

***Note !**

- If the cuff does not stop inflating, remove the cuff at once.
- To stop measurement, press **START/STOP** button. The cuff will deflate immediately after the button is pressed.

4. After the monitor has determine your blood pressure and heart rate, the cuff automatically deflates. Your systolic rate, diastolic rate, pulse rate and corresponding Risk Category Indicator and Irregular Heartbeat Detector (if any) are displayed with date and time for 1 minute and save results to memory automatically.

Measurement Procedure

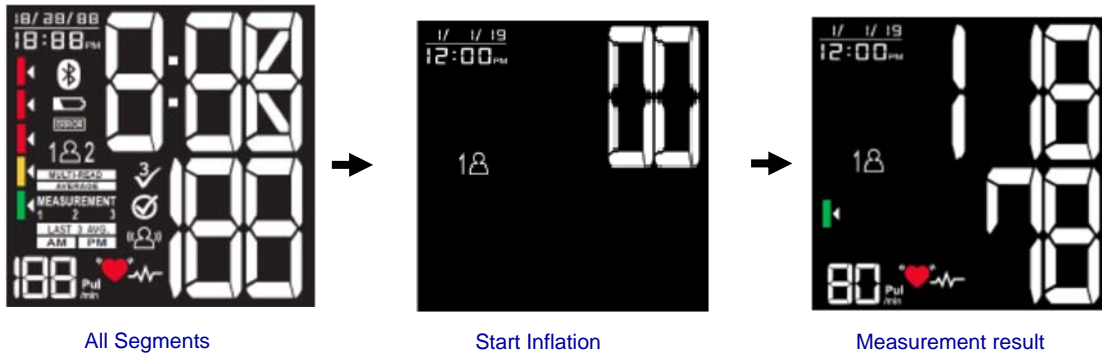

D. Start a Multi-Measurement: will take continuative 3 times measurements.

1. Make sure the triple-check function switch turned on.
With the cuff wrapped around your upper arm, press **START/STOP** button to start the measurement. All display units appear on the screen for 1.5 seconds, and will automatically start the 1st measurement ("MEASUREMENT 1" flash while measuring).
2. After the 1st measurement finished, measuring result will not be showed, and display turned to 1 minute countdown directly for the 2nd measurement.
3. Time end, starting the 2nd measurement ("MEASUREMENT 2" flash and "MEASUREMENT 1" non-flash while measuring).
4. After the 2nd measurement finished, measuring result will not be showed, and display turned to 1 minute countdown directly for the 3rd measurement.
5. Time end, starting the 3rd measurement ("MEASUREMENT 3" flash and "MEASUREMENT 1 & 2" non-flash while measuring)
6. As the cuff inflates, the monitor automatically determines your ideal inflation level. This monitor detects your blood pressure and pulse rate during inflation. The Heartbeat Symbol (♥) flashes at every heartbeat. Remain still and do not move until the entire measurement process is completed. The device will detect your pulse and determine measurement.

Measurement Procedure

- After the monitor has determine your blood pressure and pulse rate, the cuff automatically deflates. Your systolic rate, diastolic rate, pulse rate and corresponding Risk Category Indicator and Irregular Heartbeat Detector (if any) are displayed with date and time for 1 minute and save results to memory automatically.

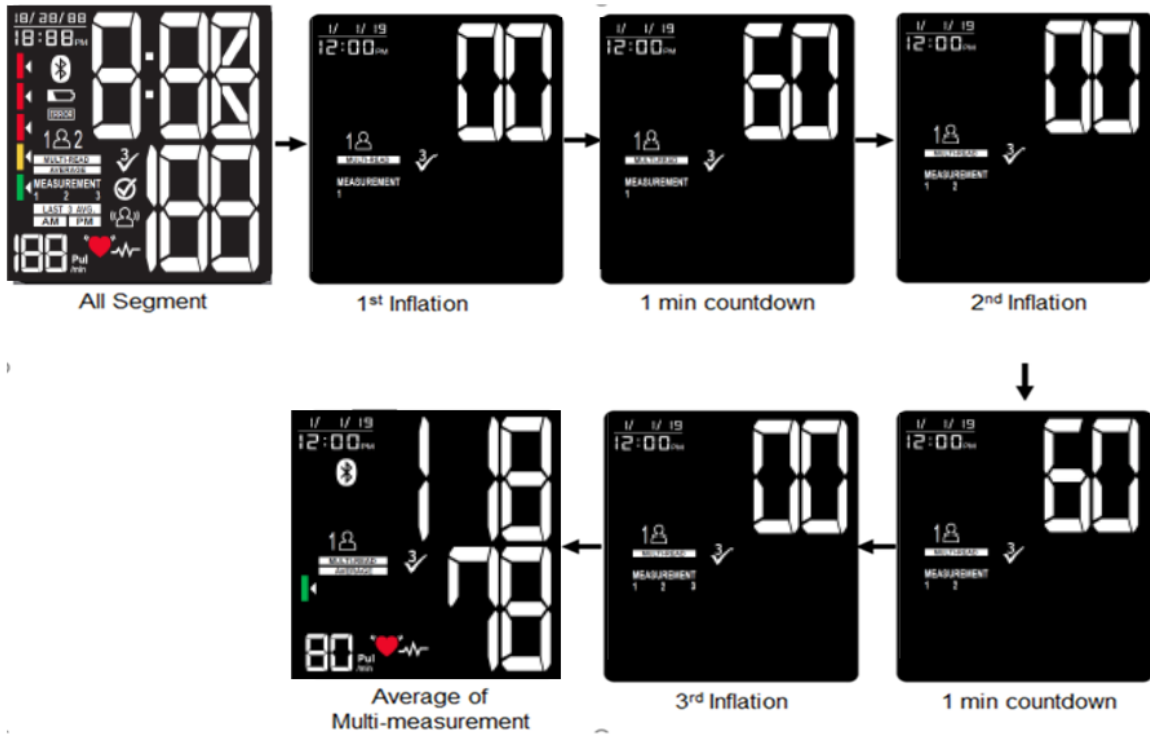

***Note !**

- Do not inflate the cuff until it is wrapped around your upper arm.
- Without any operation for 1 minute, device turns to the sleeping mode.
- To stop measurement, press **STAR/STOP** button.
- Press **MEM** key to memory mode.
- Press **⌚** key to Date/ Time Setting Mode.
- Press **1Δ/Δ2** to Change User.
- Press **STAR/STOP** key to stop measurement to Sleeping Mode.

Bluetooth Transmission

To activate Bluetooth function, please make sure your Bluetooth-enabled device have downloaded APP, and follow pairing instruction. There are 2 ways to process Bluetooth Transmission if Bluetooth function is ON:

Measurement Completed:

1. After measurement completed, the device activates Bluetooth function automatically, and the Bluetooth Symbol will begin flashing on the screen.

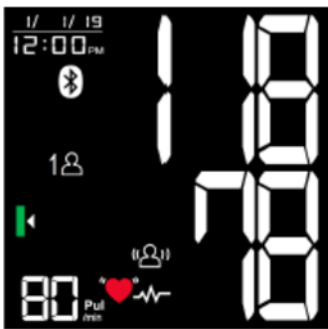

Single Measurement
Bluetooth Symbol



Multi Measurement
Bluetooth Symbol

2. While transmitting the reading to your Bluetooth-enabled Device, HL858CJ Bluetooth Symbol will remain steady on the screen.
3. HL858CJ can only pair up with one Bluetooth-enabled device at a time. To transmit measuring results to other Bluetooth-enabled device, please retry Steps 1 ~ 2.

Press button for one time:

Under Sleeping Mode and Standby Mode,

1. Press  button for one time to wake up the device and starting Bluetooth function (Bluetooth Symbol flashing).
2. While transmitting the reading to your Bluetooth-enabled Device, HL858CJ Bluetooth Symbol will remain steady on the screen.

Bluetooth Transmission

3. HL858CJ can only pair up with one Bluetooth-enabled device at a time.

To transmit measuring results to other Bluetooth-enabled device, please retry as mention above.

Fail connection:

If HL858CJ cannot be connected to paired Bluetooth-enabled device over 45 seconds, LCD will display Error message "E4" and Bluetooth will be turned off.

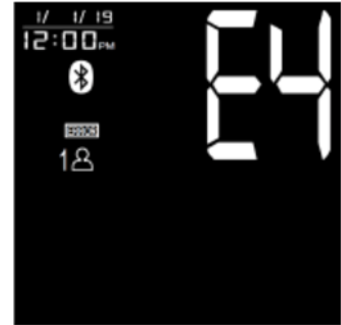

A. Date/Time Synchronization

1. The BPM's Date/Time Setting can be synchronized by Bluetooth-enabled device (e.g. smart phone) which has downloaded and installed DailyChek® application software.
2. When Bluetooth connection is established, the Bluetooth-enabled device can send commend with the date/time information to BPM and the BPM's date/time will be updated.

B. Battery Status Check

The feature provides users as a simple/convenient tool to check the battery status before measurement. Upon receiving the request from Bluetooth-enabled device either on Standby Mode or after measurement, the BPM will transmit the current battery status for user's reference.

****Note !***

- Without any operation in 1 minute, the device shuts off automatically and Bluetooth Transmission OFF.
- Standby Mode: Segments appeared but not under BPM measuring or data transmitting.
- Sleeping Mode: Clear all LCD segments.

Memory Function

◆ Storing data





After each measurement, the systolic and diastolic pressure, heart rate and Risk Category Indicator with the time and date will be automatically stored.

The monitor features 2 user memory capabilities. Each user holds the last 120 measurements, and automatically replacing the oldest data with new one.

◆ Memory Function

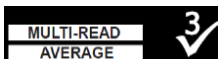
Press **MEM** button to see previous measuring results, including average of last 3 measurements and an average of 3 AM or PM measurements.

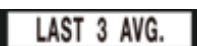
Reviewing your morning (AM) and nighttime (PM) blood pressure can provide important information about your health condition.

	An average of Triple-Check (Multi-Read) measurement (Press MEM key to review individual readings)
	
	An average of Last 3 Measurements
	An average of Last 3 Morning Measurements (4:00 AM – 12:00 PM)
	An average of Last 3 Nighttime Measurements (6:00 PM – 2:00 AM)
<p>Note: A Triple-Check (Multi-Read) average and its 3 individual measurements are counted as 4 readings when stored in memory.</p>	

Memory Function

◆ Recalling Data in Average Memory Mode

- A. Press **1Δ/Δ2** button to select User 1, 2.
- B. Press **MEM** button to enter Memory Mode, and LCD displays an average of the last 3 memories.

(If a Triple-Check (Multi-Read) result included, the average of it will be included, but its individual measurements will be not. See the example as below.)



Average of Last 3 Measurements

<e.g. 119th measurement is a Triple-Check (Multi-Read) result :>

- Press **MEM** key to read 3 results (118th, 117th and 116th) of Triple-Check (Multi-Read) average (119th)
- Average of the last 3 measurements is the average of 120th, 119th (118th, 117th and 116th individual results are excluded) and 115th results.

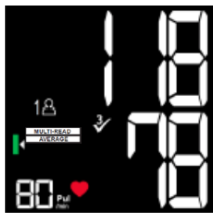

119th Triple-Check (Multi-Read) result
(Average of 118th, 117th, and 116th)

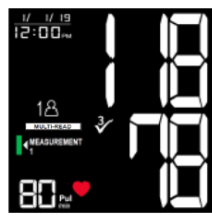

118th result

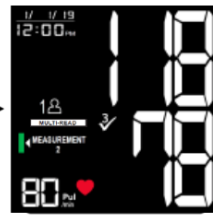

117th result

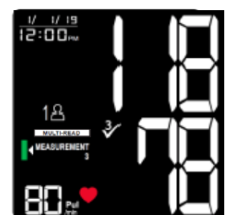

116th result

- C. Press **MEM** button again, LCD displays average of latest 3 AM measurements, and then is average of latest 3 PM measurements. If fewer than three measurements will not be displayed.



Average of Last 3 AM Measurement



Average of Last 3 PM Measurement

Memory Function

- D. Keep Pressing **MEM** button again to read the following measurements in sequence.
- E. To stop reading the memories, press **START/STOP** button and switch to Sleeping Mode.

◆ Erasing data

- A. Press **1Δ/Δ2** button to select User 1, 2.
- B. Press **MEM** button to enter Memory Mode.
- C. Press and hold **MEM** and **START/STOP** buttons at the same time, all the data for the selected user will be erased automatically.



Note:

1. Once deleted, your data can NOT be restored.
2. Once deleted, the device will be automatically perform a self-check on the next measurement.

Storage and Maintenance

◆ General Use

- Do not in any way twist the cuff.
- Do not press **START/STOP** button if the cuff is not wrapped around your upper arm.
- Do not drop the product and avoid any strong impacts.

◆ Maintenance

- Use a piece of cloth with 75% alcohol (ethanol) to wipe the device.
- Do not use detergent or any strong chemicals to clean the device.
- Disinfection - Use a piece of cloth with 75% alcohol (ethanol) to wipe the surface of the cuff for 10 seconds.
- Make sure the cuff is completely dry before using.
- Do not attempt to disassemble or change any parts of the monitor, including arm cuff, due to substitution of a component different from that supplied might result in measurement error.
- If any suggestion or service is requested, please consult your service station.
- Do not implement the maintenance procedures for equipment during measurement.
- Only trained technicians are allowed to repair and disassemble the device, including software upgrades, patches and maintenance.







**Note !*

- Water quality required for cleaning: Tap water.

◆ Storage

- If the device is not to be used for a long time, please remove the batteries from the device (leaking of battery acid can cause the device to malfunction).
- Always store the unit in the storage case after use. It is intended to be transported or stored in a carrying case between uses.
- Do not place the device directly under sunlight, in high temperature, or in humid or dusty places.

Troubleshooting

SYMBOLS/SYMPTOMS	CONDITIONS/CAUSES	INDICATION/ CORRECTION
Unit does not turn on when START/STOP button is pushed.	Worn-out batteries.	Replace them with 4 new AA (LR6) alkaline batteries.
	Battery polarities have been positioned incorrectly.	Re-insert the batteries in the correct positions.
 & EE Measuring Error Symbol appears when blood pressure value displayed is excessively low or high.	Cuff has been placed incorrectly.	Wrap the cuff properly so that it is positioned correctly.
 & E1 Measuring Error Symbol	Air circuit abnormality. Cuff tube may not be plugged into monitor correctly.	Check cuff connection. Measure again.
 & E2 Measuring Error Symbol	Inflation pressure exceeding 300 mmHg.	Switch the unit off, then measure again.
 & E3 Measuring Error Symbol	Can't determine blood pressure measurement data.	Wrap the cuff properly and keep steady. Measure again.
	Cuff is worn improperly, or the shape of the upper arm is unusual (for example, the circumference of the upper arm differs largely from the circumference of the forearm), excessive gap might exist between the arm cuff and the arm.	Wrap the cuff snugly so that it is positioned correctly. If you have any question about the cuff wearing and/or measurement result, please consult your healthcare professional.
 & E4 Measuring Error Symbol	If HL858CJ cannot be connected to paired Bluetooth-enabled device over 45 seconds, LCD will display Error message "E4" and Bluetooth will be turned off.	Please press  button for one time to start Bluetooth function.
 Excessive Body Motion Detector Notice: The measured blood pressure reading may not be accurate if the icon is displayed.	Body movement during measurement, especially, the movement on the arm the blood pressure monitor is worn on. e.g. Talking, moving or shaking of the arm with the cuff on while measurement.	Measure again. Keep arm steady during measurement.
	Cuff is worn improperly, or the shape of the upper arm is unusual (for example, the circumference of the upper arm differs largely from the circumference of the forearm), excessive gap might be exist between the arm cuff and the arm.	Wrap the cuff snugly so that it is positioned correctly. If you have any question about the cuff wearing and/or measurement result, please consult your healthcare professional.
BPM cannot communicate with	Paring has not been completed.	Please re-pairing the BPM and Bluetooth-enabled device with each other.

Bluetooth-enabled device	Bluetooth function is not turn on.	Please press  button for one time under sleep mode.
	The distance between BPM and Bluetooth-enabled device is out of transmitting range.	Please make sure the acceptable distance (≤ 10 meters) with each other.
	Use an incompatible Bluetooth-enabled device.	Please refer to "Bluetooth compatibility" & "RF Specification"
	Use non-Bluetooth-enabled device.	
	Unexpected loss of electrical/mechanical integrity.	Re-insert the batteries and try again.
Return the device to your local distributor or importer.		
Note: If "EP" appears on the display, just return the device to your local distributor or importer.		

Warranty

◆ Warranty For One Year from the manufacturing date

Please note that this warranty does not cover damage caused by misuse or abuse; accident; the attachment of any unauthorized accessory; alteration to the product; improper installation; unauthorized repairs or modifications; improper use of electrical/power supply; loss of power; dropped product; malfunction or damage of an operating part from failure to provide manufacturer's recommended maintenance; transportation damage; theft; neglect; vandalism; or environmental conditions; loss of use during the period the product is at a repair facility or otherwise awaiting parts or repair; or any other conditions whatsoever that are beyond the control of importers or distributors.

Specifications

Model Number	HL858CJ
Measurement Method	Oscillometric
Rated Range of Cuff Pressure	0 ~ 300 mmHg
Rated Range of Determination	40 ~ 280 mmHg
Measurement Range of Heart Rate	40 ~ 199 beats/minute
Accuracy	Pressure: ± 3 mmHg Pulse: ± 5 % Max.
Inflation	Automatic Inflation (Air Pump)
Deflation	Automatic Air Release Control Valve
Display	Liquid Crystal Display
Memory	240 Memory Total for 2 Users
Unit Dimensions	133 X 113 X 56 mm (L X W X H) 5.24X 4.45 X 2.2 inch (L X W X H)
Unit Weight (Cuff & Batteries Excluded)	303 \pm 5 g (10.7 \pm 0.18oz)
Cuff Size	Universal: 23 ~ 43cm (9 ~ 17 inch) Extra Large: 43~56cm(17~22 inch)
Storage/Transportation Environment	Temperature: -25 °C ~ 70 °C (-13 °F ~ 158 °F) Humidity: ≤ 93 % R.H.
Operation Environment	Temperature: 5 °C ~ 40 °C (41 °F ~ 104 °F) Humidity: 15 % ~ 93 % R.H. Atmospheric pressure: 700 hPa ~ 1060 hPa
Power Supply	1. AA "LR6" (1.5V) Alkaline Battery x 4 2. 5.99V 2A AC/DC adapter
Battery Life	Approx. 200 Measurements
Product Life	5 Years (4 times per day)
Sleeping Mode	Without any operation for 1 minute, device automatically shuts off
Accessories	4 AA 1.5V (LR6) Alkaline Batteries, 5.99V 2A AC/DC adapter, Arm Cuff with Tube, Instruction Manual.





*The contents of this manual and the specifications of the device covered by this manual are subject to change for improvement without notice.

Specifications

RF Type	Bluetooth 4.0 BLE
RF Modulation	GFSK
Equivalent Isotropic Radiated Power	3.91dBm
Data Throughput	1Mbps
Expected Delay (Latency Range) in Wireless (RF) Communication	The latency time is less than 0.3ms from sender to receiver.
Integrity	Channel Quality-Driven Data Rate (CQDDR) technology increases the effective data rate and integrity in noisy environments.
Security	AES-128 and application layer user defined
Wireless Operation Distance	Class 2 (Maximum: 10 meter)
RF Frequency / Need for Spectrum Management	2402 - 2480 MHz (allowing for guard bands)
Maximum Limitation	Unlimited
Maximum Permitted Power	1.5mW
Proximity of Other In-band Transmitters Used in Vicinity	up to 40 bands (2 MHz spacing; centered from 2402 to 2480 MHz)
Wireless Communication Profile	GATT – Client and Server
Wireless Coexistence	Support for 802.11 Coexistence
System requirement of the Bluetooth-enabled device	Bluetooth 4.0 for Android 4.3 or above Bluetooth 4.0 for iOS 7.0 or above

Note

Explanation of symbols :

Symbol	Explanation	Health & Life Information
	Refer to instruction manual/booklet	-
	TYPE BF Applied Part	-
	To avoid inaccurate results caused by electromagnetic interference	Warning: Portable RF communications equipment (including peripherals such as antenna cables and external antennas) should be used no closer than 30cm (12 inches) to any part of the device, Otherwise, degradation of the performance of this equipment could result.
	Waste of electrical and electronic equipment (WEEE)	-
SN	Serial number	SN YYMMXXXXXX
IP22	Ingress Protection Rating	First characteristic numeral- Degree of protection against access to hazardous parts and against solid foreign objects N1=2 (Protected against solid foreign objects of 12.5 mm Ø and greater) Second characteristic numeral- Degree of protection against ingress of water N2=2 (Protected against vertically falling water drops when ENCLOSURE tilted up to 15°)
	Non-ionizing electromagnetic radiation	-

Device information:

- Internally powered equipment
- Not suitable for use in presence of flammable anesthetic mixture with air or with Oxygen or nitrous oxide
- Continuous operation with short-time loading

Manufacturer: HEALTH & LIFE CO., LTD.

9F, No. 186, Jian Yi Road, Zhonghe District, New Taipei City, Taiwan

www.healthandlife.com.tw

Note

***Note !**

This equipment has been tested and found to comply with the limits for a Class B digital device, pursuant to Part 15 of the FCC Rules. These limits are designed to provide reasonable protection against harmful interference in a residential installation.

This equipment generates uses and can radiate radio frequency energy and, if not installed and used in accordance with the instructions, may cause harmful interference to radio communications. However, there is no guarantee that interference will not occur in a particular installation. If this equipment does cause harmful interference to radio or television reception, which can be determined by turning the equipment off and on, the user is encouraged to try to correct the interference by one or more of the following measures:

The user is encouraged to try to correct the interference by one or more of the following measures:

- Reorient or relocate the receiving antenna.
- Increase the separation between the equipment and the receiver.
- Connect the equipment into an outlet on a circuit different from that to which the receiver is connected.
- Consult the dealer or an experienced radio/TV technician for help.

CAUTION:

To assure continued FCC compliance:

Any changes or modifications not expressly approved by the grantee of this device could void the user's authority to operate the equipment.

RF exposure warning

1. The equipment complies with FCC RF exposure limits set forth for an uncontrolled environment.
2. The equipment must not be co-located or operation in conjunction with any other antenna or transmitter.

FCC Label Compliance Statement:

This device complies with Part 15 of the FCC Rules. Operation is subject to the following two conditions:

- (1) this device may not cause harmful interference, and
- (2) this device must accept any interference received, including interference that may cause undesired operation.

***Note !**

"Changes or modifications not expressly approved by the manufacturer could void the user's authority to operate the equipment".

HL858CJ essential performance per IEC 80601-2-30 additional essential performance requirements:

- 201.12.1.102 Limits of the error of the manometer from environmental conditions

Over the temperature range of 5 °C to 40 °C (41 °F ~ 104 °F) and the relative humidity range of 15 % to 93 %(non-condensing), the maximum error for the measurement of the CUFF pressure at any point of the NOMINAL measurement range shall be less than or equal to ± 3 mmHg (± 0.4 kPa) or 2 % of the reading, whichever is greater.

- 201.12.1.107 Reproducibility of the blood pressure determination
The laboratory Reproducibility of the BLOOD PRESSURE DETERMINATION of the AUTOMATED SPHYGMOMANOMETER shall be less than 3 mmHg (0.4 kPa).

Appendix

◆ Guidance and manufacturer's declaration – electromagnetic emissions

The device is intended for use in the electromagnetic environments listed below, and should only be used in such environments:

Emissions test	Compliance	Electromagnetic environment – guidance
RF emissions CISPR 11	Group 1	RF energy is used only to maintain device's operation. Therefore, its RF emissions are so low that it's not likely to cause any interference in nearby electronic equipment.
RF emissions CISPR 11	Class B	The device is suitable for use in all establishments, including domestic establishments, and those directly connected to the public low-voltage power supply network that supplies buildings used for domestic purposes.
Harmonic emissions IEC 61000-3-2	Class A	
Voltage fluctuations/ flicker emissions IEC 61000-3-3	Complies	

◆ Guidance and manufacturer's declaration – electromagnetic immunity

The device is intended for use in the electromagnetic environments listed below, and should only be used in such environments:

Immunity test	IEC 60601 test level	Compliance level	Electromagnetic environment – guidance
Electrostatic discharge (ESD) IEC 61000-4-2	± 8 kV contact discharge ± 15 kV air discharge	± 8 kV contact discharge ± 15 kV air discharge	In the case of air discharge testing, the climatic conditions shall be within the following ranges: Ambient Temperature: 15°C ~ 35°C, Relative Humidity: 30% ~ 60%.
Power frequency (50 or 60 Hz) magnetic field IEC 61000-4-8	30 A/m 50 or 60 Hz	30 A/m 50 or 60 Hz	Power frequency magnetic fields should be at levels characteristic of a typical location in a typical commercial or hospital environment.
Electrical fast transient/burst IEC 61000-4-4	± 2 kV for power supply lines ± 1 kV for input/output lines	± 2 kV for power supply lines ± 1 kV for input/output lines	Mains power quality should be that of a typical commercial or hospital environment.
Surge IEC 61000-4-5	±2 kV Power lines	±2 kV Power lines	Mains power quality should be that of a typical commercial or hospital environment.
interruptions and voltage variations on power supply input lines IEC 61000-4-11	0% UT; 0.5 cycle At 0°, 45°, 90°, 135°, 180°, 225°, 270° and 315°. 0 % UT; 1 cycles 70 % UT; 25/30 cycles 0 % UT; 250/300 cycle	0% UT; 0.5 cycle At 0°, 45°, 90°, 135°, 180°, 225°, 270° and 315°. 0 % UT; 1 cycles 70 % UT; 25 cycles 0 % UT; 250 cycle	Mains power quality should be that of a typical commercial or hospital environment. If the user of the device requires continued operation during power mains interruptions, it is recommended that the device be powered from an uninterruptible power supply or a battery.

Appendix

◆ Recommended separation distances between portable and mobile RF communication equipment and the device.

The device is intended for use in an electromagnetic environment where radiated RF disturbances are under control. User can help prevent electromagnetic interference by keeping the device at a minimum distance from portable and mobile RF communications equipment (transmitters). Below table details the maximum output power of transmitter:

Rated maximum output power of transmitter W	Separation distance according to frequency of transmitter m		
	150 kHz to 80 MHz $d = 1.2 \sqrt{P}$	80 MHz to 800 MHz $d = 1.2 \sqrt{P}$	800 MHz to 2.7 GHz $d = 2.3 \sqrt{P}$
0.01	0.12	0.12	0.23
0.1	0.38	0.38	0.73
1	1.2	1.2	2.3
10	3.8	3.8	7.3
100	12	12	23

For transmitters rated at a maximum output power not listed above, the recommended separation distance d in metres (m) can be estimated using the equation applicable to the frequency of the transmitter, where P is the maximum output power rating of the transmitter in watts (W) according to the transmitter manufacturer.

NOTE 1 At 80 MHz and 800 MHz, the separation distance for the higher frequency range applies.

NOTE 2 These guidelines may not apply in all situations. Electromagnetic propagation is affected by absorption and reflection from structures, objects and people.

◆ Guidance and manufacturer's declaration – electromagnetic immunity

The device is intended for use in the electromagnetic environments listed below, and should only be used in such environments:

Immunity test	IEC 60601 test level	Compliance level	Electromagnetic environment – guidance
Conducted RF IEC 61000-4-6	3V rms At 0.15-80 MHz 6V rms At ISM & Radio Amateur Freq.	3V rms At 0.15-80 MHz 6V rms At ISM & Radio Amateur Freq.	Portable and mobile RF communications equipment should be used no closer to any part of the device, including cables, than the recommended separation distance calculated from the equation applicable to the frequency of the transmitter.
Radiated RF IEC 61000-4-3 (Proximity fields from RF wireless communications equipment IEC 61000-4-3)	10 V/m at 80-2700 MHz AM Modulation And 9-28V/m at 385-6000MHz, Pulse Mode and other Modulation. The system shall be tested as specified in IEC60601-1-2 Table 9 for proximity fields from RF wireless communications equipment using the test methods specified in IEC 61000-4-3	10 V/m at 80-2700 MHz AM Modulation And 9-28V/m at 385-6000MHz, Pulse Mode and other Modulation. The system shall be tested as specified in IEC60601-1-2 Table 9 for proximity fields from RF wireless communications equipment using the test methods specified in IEC 61000-4-3	<p>Recommended separation distance $d = 1.2 \sqrt{P}$ $d = 1.2 \sqrt{P}$ 80 MHz to 800 MHz $d = 2.3 \sqrt{P}$ 800 MHz to 2.7 GHz where P is the maximum output power rating of the transmitter in watts (W) according to the transmitter manufacturer and d is the recommended separation distance in metres (m).</p> <p>Field strengths from fixed RF transmitters, as determined by an electromagnetic site survey, a should be less than the compliance level in each frequency range. b</p> <p>Interference may occur in the vicinity of equipment marked with the following symbol: </p>

NOTE 1 At 80 MHz and 800 MHz, the higher frequency range applies.

NOTE 2 These guidelines may not apply in all situations. Electromagnetic propagation is affected by absorption and reflection from structures, objects and people.

a. Field strengths from fixed transmitters, such as base stations for radio (cellular/cordless) telephones and land mobile radios, amateur radio, AM and FM radio broadcast and TV broadcast cannot be predicted theoretically with accuracy. To assess the electromagnetic environment due to fixed RF transmitters, an electromagnetic site survey should be considered. If the measured field strength in the location in which the device is used exceeds the applicable RF compliance level above, the device should be observed to verify normal operation. If abnormal performance is observed, additional measures may be necessary, such as reorienting or relocating the device.

b. Over the frequency range 150 kHz to 80 MHz, field strengths should be less than 3 V/m.

Blood Pressure Diary

Date :		Time :		<input type="checkbox"/> Before Meal <input type="checkbox"/> After
Systolic / Diastolic :				Pulse :
Date :		Time :		<input type="checkbox"/> Before Meal <input type="checkbox"/> After
Systolic / Diastolic :				Pulse :
Date :		Time :		<input type="checkbox"/> Before Meal <input type="checkbox"/> After
Systolic / Diastolic :				Pulse :
Date :		Time :		<input type="checkbox"/> Before Meal <input type="checkbox"/> After
Systolic / Diastolic :				Pulse :
Date :		Time :		<input type="checkbox"/> Before Meal <input type="checkbox"/> After
Systolic / Diastolic :				Pulse :
Date :		Time :		<input type="checkbox"/> Before Meal <input type="checkbox"/> After
Systolic / Diastolic :				Pulse :
Date :		Time :		<input type="checkbox"/> Before Meal <input type="checkbox"/> After
Systolic / Diastolic :				Pulse :
Date :		Time :		<input type="checkbox"/> Before Meal <input type="checkbox"/> After
Systolic / Diastolic :				Pulse :
Date :		Time :		<input type="checkbox"/> Before Meal <input type="checkbox"/> After
Systolic / Diastolic :				Pulse :
Date :		Time :		<input type="checkbox"/> Before Meal <input type="checkbox"/> After
Systolic / Diastolic :				Pulse :

P/N : 323103202

VER : A001

20190124