

Instruction Manual

Automatic Upper Arm Blood Pressure Monitor



Model No. HL858CB

Table of Contents

Medical Disclaimer.....	03
Intended Use.....	03
About Blood Pressure.....	04
Measurement Method.....	06
Accuracy.....	06
Precautions.....	07
Device Overview.....	09
Symbol Definitions.....	12
Features.....	13
Installing Batteries.....	18
Using the AC Adapter.....	19
Applying the Cuff.....	20
Measurement Procedure.....	21
Bluetooth Transmission.....	25
Memory Function.....	26
Storage and Maintenance.....	29
Troubleshooting.....	30
Warranty & Recalibration.....	31
Specifications.....	32
Note.....	34
Appendix.....	36
Blood Pressure Diary.....	38

Medical Disclaimer

This manual and product are not meant as a substitute for advice provided by your doctor.

You are not to use the information contained herein, or this product for diagnosing or treating a health problem or prescribing any medication. If you have or suspect that you have a medical problem, promptly consult your healthcare provider.

Intended Use

This device uses the oscillometric method to automatically measure systolic and diastolic blood pressure as well as heart rate.

The measurement position is at human being's arm.

All values can be read out in one LCD panel.

The device is designed and recommended for use by people over the age of 18 with arm circumference ranging from approx. 9 inches to 17 inches (23 cm to 43 cm) and for home use.

About Blood Pressure

1. What is blood pressure?

Blood pressure is the measurement of the force of blood pushing against the walls of the arteries. Arterial blood pressure is constantly fluctuating during the course of the cardiac cycle. The highest pressure in the cycle is called the systolic blood pressure, and represents the pressure in the artery when the heart is beating. The lowest pressure is the diastolic blood pressure, and represents the pressure in the artery when the heart is at rest. Both the systolic and the diastolic pressure are necessary for a physician to evaluate the status of a patient's blood pressure.

Many factors such as physical activity, anxiety or the time of day, can influence your blood pressure. Blood pressure is typically low in the mornings and increases from the afternoon to the evening. It is on average lower in the summer and higher in the winter.

2. Why is it useful to measure blood pressure at home?

Having one's blood pressure measured by a doctor in a hospital or a clinic, is often associated with an event called "White Coat Hypertension" where the patient becomes nervous or anxious, thus raising his blood pressure. There are also numerous other factors that might cause your blood pressure to be raised at a specific time of day. This is why medical physician recommend home monitoring as it is important to get readings of blood pressure during different times of the day to really get an idea of your real blood pressure.

Medical physicians generally recommend the "Rule of 3", where you are encouraged to take your blood pressure three times in a row (at 3 ~ 5 minute interval), three times a day for three days. After three days you can average all the results and this will give you an accurate idea of what your blood pressure really is.

About Blood Pressure

A. Standards for assessment of high or low blood pressure without regard to age, have been established by the WHO, and classifications adapted from JNC7:

WHO: World Health Organization

JNC 7: The Seventh Report of the Joint National Committee on Prevention, Detection, Evaluation, and Treatment of High Blood Pressure. NIH Publication No.04-5230 August 2004

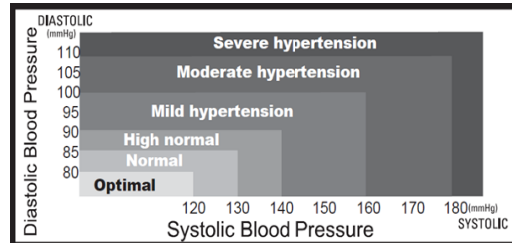

However the above chart is not exact for classification of blood pressure and it's intended to be used as a guide in understanding non-invasive blood pressure measurements. Please consult with your physician for proper diagnosis.

B. Variations in blood pressure:

Individual blood pressures vary greatly both on a daily and a seasonal basis. These variations are even more pronounced in hyper tense patients. Normally the blood pressure rises while at work and is at its lowest during sleeping period.

(hyper tense: means a person who has high blood pressure symptom.)

The graph below illustrated the variations in blood pressure over a whole day with measurement taken every five minutes.

The thick line represents sleep. The rise in blood pressure at 4 PM (A in the graph) and 12 PM (B in the graph) correspond to an attack of pain.

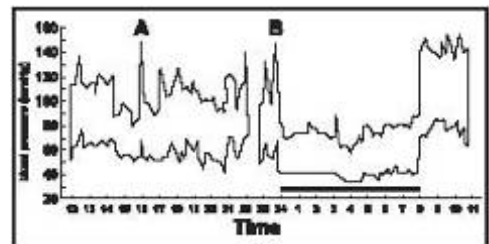

Measurement Method

HL858CB Automatic Upper Arm Blood Pressure Monitor measures blood pressure and heart rate by oscillometric method, meaning the fluctuations in pressure are measured. Once the cuff is wrapped around your upper arm, just turn on the monitor and inflation automatically starts. The inflation of the cuff creates pressure around the arteries inside upper arm.

Within the cuff is a gauge which senses the fluctuations (oscillations) in pressure. The fluctuation measured represents the degree of intensity that your arteries contracting with each heart beat, and also a result of the pressure that the cuff has placed on the upper arm. The monitor measures these contractions and converts the information into a digital value. This is the result displayed on the monitor screen.

Once the measurement is complete, the cuff will automatically deflate.

Accuracy

HL858CB Automatic Upper Arm Blood Pressure Monitor has been clinically tested against a scientific device called *sphygmomanometer*, considered the gold standard in blood pressure measurement.

All HL858CB Automatic Upper Arm Blood Pressure Monitors have performed equivalent to measurements taken with this scientific device and are within the accuracy limits prescribed by the American National Standard for Electronic or Automated Sphygmomanometers.

The SPHYGMOMANOMETER was clinically investigated according to the requirements of ISO 81060-2:2013.

***We suggest our users have their blood pressure monitor checked every 2 years. This operation should only be performed by Manufacturer or by authorized representatives.**

Precautions

- * Do not use this manual and product as a substitute for advice, diagnosing or treating a health problem or prescribing any medication by your doctor. If you have a medical problem, promptly consult your healthcare provider.
 - * Read the Instruction Manual thoroughly before measuring and keep it at hand for your reference at any time.
 - * This device uses the oscillometric method to measure systolic and diastolic blood pressure as well as your heart rate. It's recommended for use by people over the age of 18 and not to be used on infant or children.
 - * The device is designed for home use and not suitable for clinical use.
-
- Do not take a measurement in a low (less than 41°F/5°C) and high (more than 104 °F/40 °C) temperature, nor in a place outside humidity ranges (15 % ~ 93 % R.H.), and altitude ranges (700 ~ 1060 hPa), or you may get inaccurate readings.
 - Wait 30 ~ 45 minutes before measurement if you've just consumed caffeinated beverages or smoked cigarettes.
 - Rest at least 5 ~ 10 minutes before taking a measurement.
 - To allow your blood vessels to return to the condition prior to taking the measurement, please wait at least 3 ~ 5 minutes in between measurements. You may need to adjust the wait time according to your personal physiological situation.
 - We recommend you using the same arm (preferably the left arm) and measuring around the same time each day.
 - Sit down comfortably and place your elbow on the table with your feet flat on the floor, and back supported. Please do not cross your legs during measurements.
 - Keep the cuff at heart level. Relax your hand with the palm facing up.
 - Perform measurements in a quiet and relaxed environment at room temperature.
 - Do not move or shake the device during a measurement. Please keep quiet and do not talk during measurements.
 - This product is not suitable for:
 - Pregnant women.
 - People with arrhythmias
 - Undergoing intravenous injection on any limb
 - Currently in a dialysis treatment
 - In pre-eclampsia condition

Precautions

- ❑ For those who have had mastectomy surgery (especially whose lymph nodes removed), it's recommend take a measurement on the unaffected side.
- ❑ When used among medical electronic equipments on the same limb, pressurization of the cuff may cause temporarily malfunction toother devices.
- ❑ Keep in mind that blood pressure naturally varies from time to time throughout the day and is affected by lots of different factors such as stress, eating, smoking, alcohol consumption, medication, and physical activity, etc.
Normally the blood pressure rises while at work and is at its lowest during sleeping period.
- ❑ Blood pressure measurements should be interpreted by a physician or a trained health professional who is familiar with your medical history. Using the unit and recording the results regularly for your physician to interpret, you will keep your physician informed of the continuing changes in your blood pressure.
- ❑ If you have one of the circulatory problems as arteriosclerosis, diabetes, liver disease, kidney disease, severe hypertension, peripheral circulation....., please consult your healthcare professional before using the device.
- ❑ Blood pressure measurements determined with this device are equivalent to those obtained by a trained observer using the cuff/stethoscope auscultation method and are within the accuracy limits prescribed by the American National Standard for Manual, electronic, or Automated Sphygmomanometers.

****Attention !***

1. Do not use the device on infants, children, or those who cannot express their own intention.
2. The device is equipped with sensitive electronic components. While measuring, avoid strong electrical or electromagnetic fields, e.g. mobile phones, microwave ovens, etc; or it may lead to temporary reading error or inaccuracy.
3. To avoid accidental strangulation, keep thisproduct away from children and do not drapetube around neck.
4. Consider the electromagnetic compatibility of the device (ex. power disturbance, radio frequency interference etc.) Please use it indoor only.
5. Over high frequency measurements may result in blood flow interference, which is likely to cause uncomfortable sensations, such as partial subcutaneous hemorrhage, or temporary numbness to your arm. In general, these symptoms should not last long. However, if you do not recover in time, please seek your medical physicians for help.

Device Overview

◆ Part names and product components



Device Overview

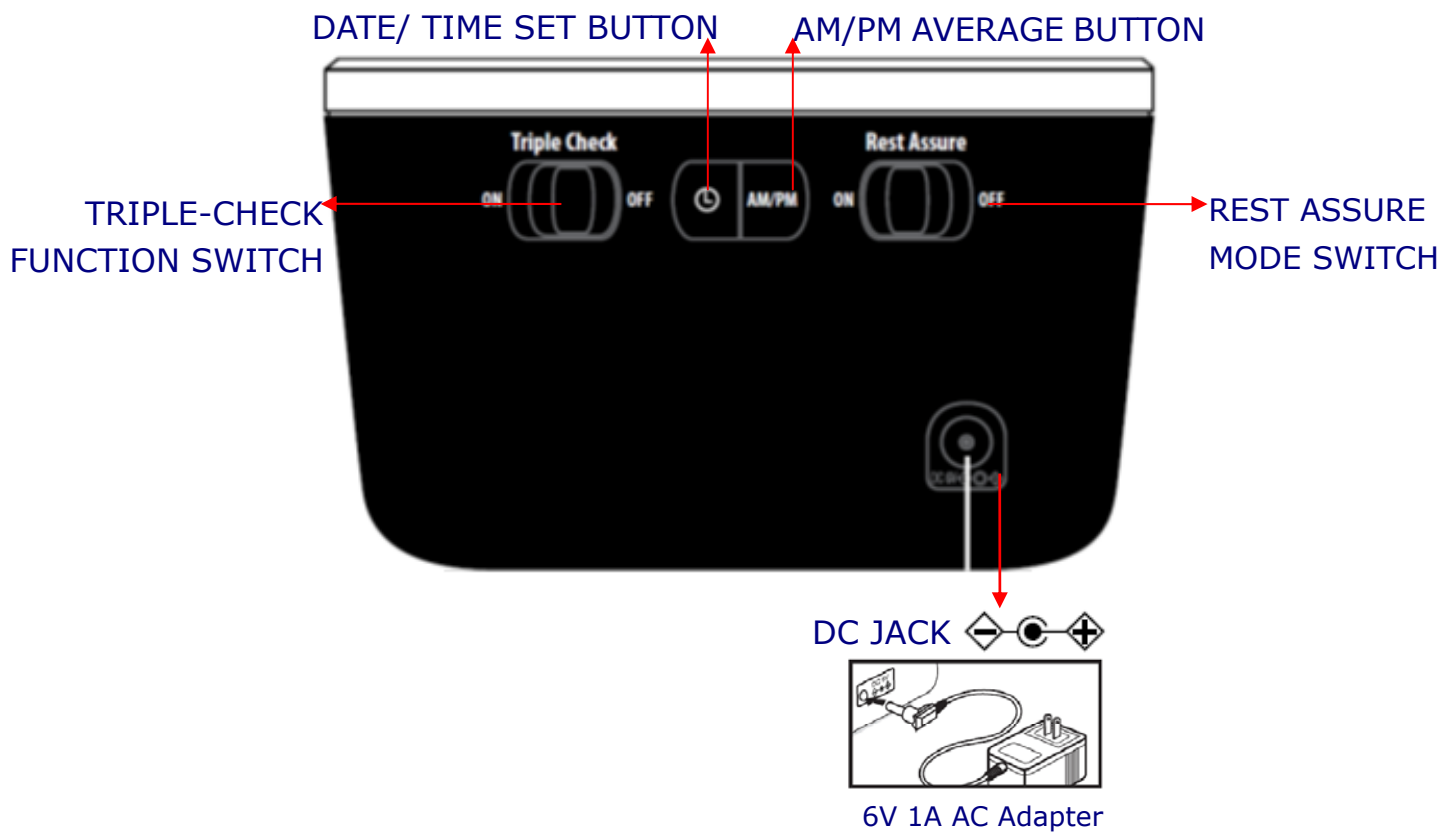







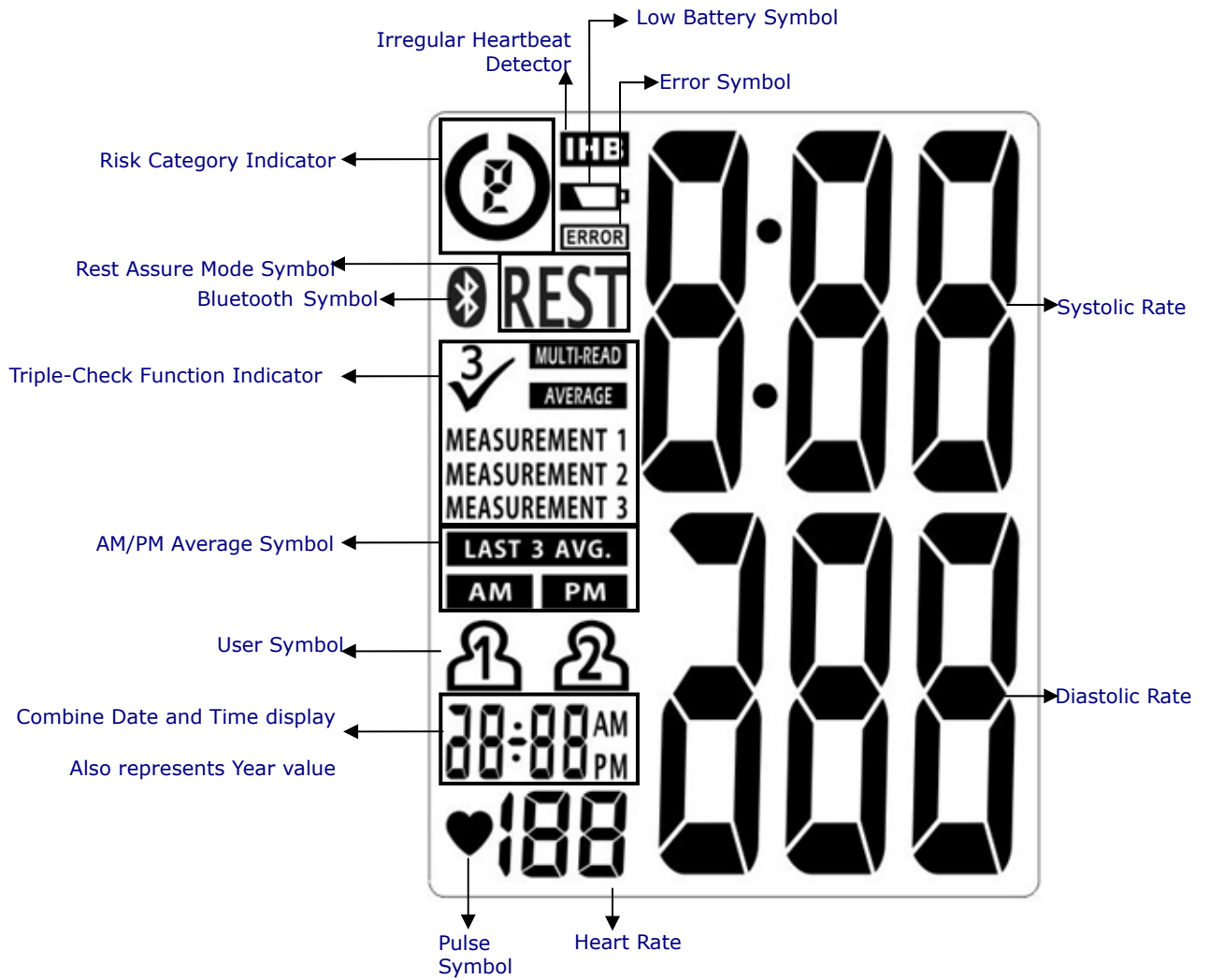



***Caution !**
Substitution of a component different from that supplied might result in measurement error.

Device Overview

◆ Unit display



Symbol Definitions

SYMBOLS	Definitions
 Low Battery Symbol	<p>This symbol appears when the battery power is excessively low or the polarity reverses.</p> <p>→ We suggest you replace all batteries with new ones, and make sure the +/- polarities are properly positioned.</p>
	<p>Error Symbol: Error display.</p>
 Pulse Symbol	<p>Once pulse is detected, the symbol flashes with each pulse beat.</p>
 Risk Category Indicator	<p>Compares readings against blood pressure guidelines. See next page for more information.</p>
	<p>Triple-Check Function Symbol: Appears when Triple-Check function is turned On.</p>
	<p>Average Symbol: Displayed when viewing a Triple-Check average.</p>
<p>REST</p>	<p>Rest Assure Mode Symbol:</p> <ol style="list-style-type: none"> 1. Rest mode on: The REST symbol will appear on monitor, that countdowns for 5 minutes before starting single measurement. 2. Triple check mode on: The REST symbol will flash among 3 measurements during countdown.
 Bluetooth Symbol	<p>Under Bluetooth Data Transmission/ Link Mode, LCD displays this symbol.</p>
<p>AVERAGE</p> <p>MEASUREMENT 1 MEASUREMENT 2 MEASUREMENT 3</p>	<p>Triple-Check Function Result: Indicates which measurement is being taken, or which measurement is being viewed from a Triple-Check average reading.</p>
<p>LAST 3 AVG.</p>	<p>Memory Average: Display average of last 3 readings.</p>
<p>LAST 3 AVG.</p> <p>AM PM</p>	<p>AM/PM Averaging: Indicates the reading being displayed is an average from the last 3 morning or last 3 evening measurements.</p>
 User 1	<p>User 1: Appears when the monitor is operated by User 1.</p>
 User 2	<p>User 2: Appears when the monitor is operated by User 2.</p>
 Irregular Heartbeat Detector	<p>This symbol appears when the user was talking, moving, shaking, or an irregular heart beat was detected during measurements.</p> <p>→ Our suggestion: Please do not talk or move during measurements. Repeat the measurement after resting for at least 5 minutes, and restart your measurement while sitting down comfortably and quietly.</p>

Features

◆ Risk Category Indicator

This device is equipped with Risk Category Indicator which classifies your blood pressure measurements into four stages (Normal, Pre-hypertension, Stage 1 Hypertension to Stage 2 Hypertension) based on the blood pressure standards established by the U.S. Department of Health and Human Services and the National Institutes of Health. The indicator symbols are defined as following classifications:

Symbol	Blood Pressure levels	Systolic (mmHg)	Diastolic (mmHg)
	Normal	< 120	< 80
Ⓟ	Pre-hypertension	120~139	80~89
Ⓢ	Stage1 hypertension	140~159	90~99
Ⓣ	Stage2 hypertension	≥ 160	≥ 100

Note: Systolic or diastolic over define value, then display the symbol

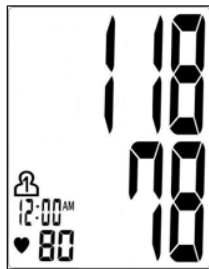

Normal

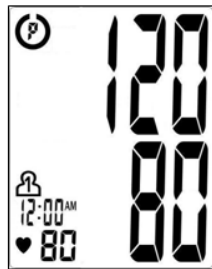

Pre-hypertension

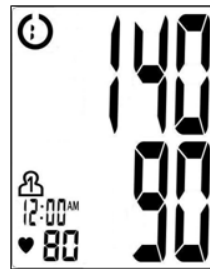

Stage1 hypertension



Stage2 hypertension

You may use the function to effectively track your blood pressure. Yet the above standards and classifications are general guidelines for your reference as an individual's blood pressure varies among different people, age groups, etc. It is important that you consult with your physician to know your normal blood pressure range as well as the point at which you will be considered at risk.

Features

For adults 18 and older who are not on medicine for high blood pressure, are not having a short-term serious illness, and do not have other conditions, such as diabetes and kidney disease. To determine category of risk when systolic and diastolic readings fall into two areas, use the higher of the two numbers for classification. There is an exception to the above definition of high blood pressure for people with diabetes and chronic kidney disease. A blood pressure of 130/80 mmHg or higher is considered high blood pressure for those individuals.

****Note !***

The above table is not exact for classification of blood pressure and it's intended to be used as a guide in understanding non-invasive blood pressure measurements.

Usually this is not a cause for concern; however we recommend you consult with your physician for proper diagnosis or seek medical advice. Please note that the device does not appropriate to diagnose hypertension, and it is only for user reference on blood pressure monitoring.

Features

◆ Rest Assure Function

Before measurement, it is suggested that you sit quietly for 5 minutes before measurement as measurements taken in a relaxed state according to JNC7 report to have a greater accuracy.

HL858CB provides users a helpful countdown function (REST ASSURE on/off switch) for 5 minutes before the measurement that helps users to get accurate results. To turn this feature OFF, slide the switch on the back to the OFF position.



JNC7: The Seventh Report of the Joint National Committee on Prevention, Detection, Evaluation, and Treatment of High Blood Pressure. NIH Publication No.04-5230 August 2004

◆ Triple-Check Function

The Triple-Check Function automatically takes and averages 3 readings in a row, with 1 minute rest intervals in between each measurement. To deactivate this feature and take only a single reading, slide the switch on the back to the OFF position.



Features

◆ Irregular Heartbeat Detector

The symbol **IHB** will appear on screen indicating a certain heartbeat irregularity was detected during measurement.

The heartbeat rhythm that is more than or less than 25% from the average rhythm is usually defined as an irregular heartbeat rhythm. Talking, moving, shaking or an irregular pulse during the measurement can result in the appearance of this symbol.

Usually this is not a cause for concern, however if the symbol appears often, we recommend you seek medical advice.

And please note that the device does not replace a cardiac examination, but serves to detect pulse irregularities at an early stage.

**Note !*

- The pulse display is not suitable for checking the frequency of heart pacemarkers. If a certain pulse irregularity is detected during measurement often, we recommend you seek medical advice
- As a safeguard, we recommend that if you have arrhythmias such as atrial or ventricular premature beats and atrial fibrillation or any other special conditions you should check with your physician before using your device.
- The IHB function is not designed for use by people with arrhythmias nor for diagnosing or treating an arrhythmic problem. In order to filter the unstable status of user and avoid affecting the detection of heart rate from any movement, shaking or talking in the beginning of measurement, the method of averaging heart beat intervals of subject device is calculated with the three proper heart beat pulses detected in the beginning of measurement and that is different from a strict mathematical averaging of all recorded intervals.
- At least 3 beats with at least 25% difference from the average heart beat interval will generate the IHB icon on the screen.

Features

◆ Bluetooth Data Transmission

HL858CB features a built-in “Bluetooth Data Transmission” function, which enables the device automatically transmit measuring results to paired Bluetooth device.

Bluetooth compatibility with blood pressure monitor for Bluetooth-enabled device is:

- Bluetooth 4.0 for Android 4.3 or above,
- Bluetooth 4.0 for iOS 5.0 or above

***Note !**

- HL858CB is subject to and complies with electromagnetic compatibility (EMC) standard of IEC 60601-1-2, EN 301 489-1, EN 301489-3, EN 302 291 and U.S. federal guidelines, Part 15 of the FCC (Federal Communications Commission) rules for devices with RF capability. These guidelines help ensure that your device will not affect the operation of other nearby devices. Additionally, other devices should not affect the use of your device.
- Other wireless devices that are in use nearby, such as a cell or mobile phone, or a wireless network, may prevent or delay the transmission of data from your device to paired Bluetooth device. Moving away from the source of the interference or turning off these devices to resolve the problem.
- Make sure HL858CB and paired Bluetooth device are within acceptable distance (no more than 10 meters) with each other. If not, put them closer.
- If you plan to transmit test results to paired Bluetooth device, be sure to select User 1, or 2 before measurements, in case other people’s results may be transmitted to your paired Bluetooth device or included in your past results.

About Bluetooth Data Transmission Function

The Bluetooth data transmission function might not be workable to some Bluetooth devices because of the compatibility of Android system. Some issues that the Bluetooth implementations on these devices have unresolved errors. It is not because of the Bluetooth module in monitor is not supported.

Installing Batteries

When LOW BATTERY SYMBOL  appears on the display, or no reaction toward operation, please change batteries.

Replace all worn-out batteries with new ones and do not mix new and used batteries. Do not mix alkaline, standard (carbon-zinc) or rechargeable (cadmium) batteries either. Such action may shorten the battery life or cause the device to malfunction.

Slide the battery cover and insert 4 AA (LR6) alkaline batteries into the battery compartment as shown on the figure below. Make sure the polarities "+" and "-" ends are coinciding with similar markings engraved on the battery housing.

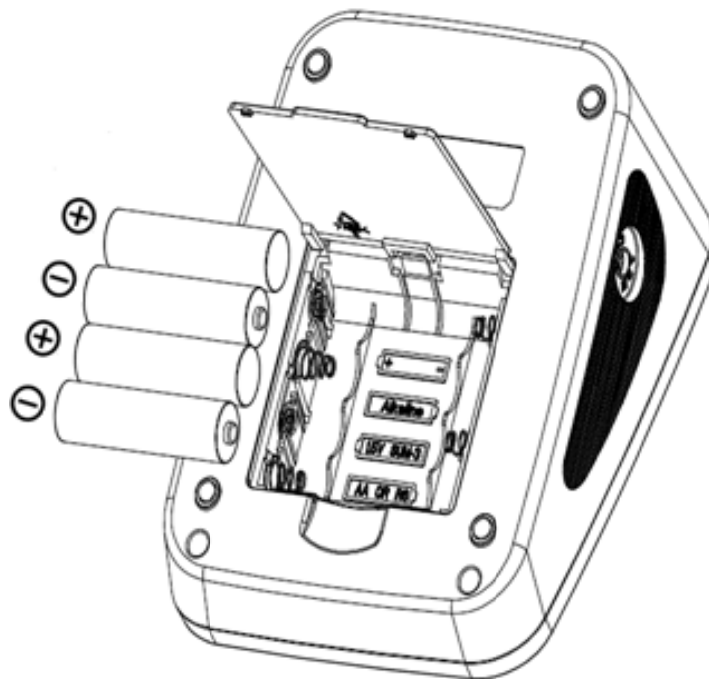

***Attention !**

- Batteries are hazardous waste. Do not dispose of them together with the household garbage. Please discard worn-out batteries to the recycling site according to local regulations.
- Keep the battery away from children in case they choke on it.
- If the device is not to be used for over 2 months, please remove the batteries from its compartment for power-saving.
- After replacing the batteries, reset date and time.
- Please replace all worn-out batteries with new ones when you are operating the Bluetooth transmission function, and the LOW BATTERY SYMBOL  appears on the display.

Using the AC Adapter

This monitor is designed for operation with batteries or an AC adapter. Please use only a compatible AC adapter with required voltage and current as indicated in this manual.

Note:

- No batteries are needed when operating with an AC adapter.
- Please unload the batteries when operating with an AC adapter for an extended period of time.
- Leaving the batteries in the compartment for a long time may cause leakage, which may lead to damage of the unit.
- Recommend Adapter specification:
Model: Fuhua, UE08WCP-060100SPA
Rating:
Input: 100 ~ 240V, AC, 50 ~ 60 Hz, 400mA
Output: 6V, DC, 1A, 

Note!

When you use the blood pressure monitor with AC adapter, do not position the device to make it difficult to disconnect the adapter plug.

Applying the Cuff

- ❑ Press your brachial artery approximately 1 inch (2 ~ 3 cm) above the elbow on the inside of your left arm to determine where your strongest pulse is.
- ❑ Slide the end of arm cuff furthest from the tube through the metal ring to a loop. The smooth cloth should be on the inside of the cuff.
- ❑ If the cuff is located correctly, the velcro will be on the outside of the cuff and metal ring will not touch your skin.
- ❑ Put left arm through the cuff loop.
The bottom of the cuff should be approximately 1 inch (2 ~ 3 cm) above the inner elbow. The tube should lie over the brachial artery on the inner part of the arm.
- ❑ Pull the cuff so that the top and bottom edges are tightened around your arm.
- ❑ When the cuff is positioned properly, press the velcro firmly against the pile side of the cuff.
- ❑ Sit on a chair and lay your forearm on the table so that the cuff is at the same level as your heart.
- ❑ Relax your arm and turn your arm upward.
- ❑ Make sure there are no kinks in the air tube.

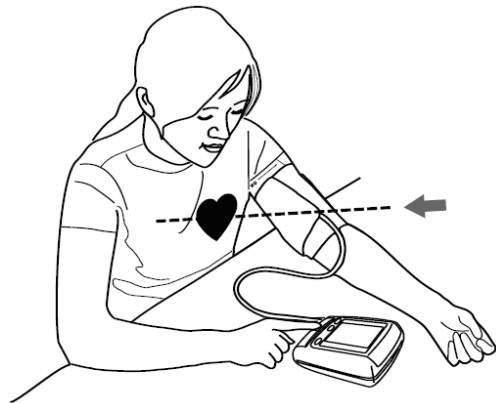

***Note !**

- Fit the cuff snugly, leaving enough space for 1 inch (2 ~ 3 cm) between the inner elbow and the lower edge of the cuff, or the measurement may not be accurate.
- This monitor comes with one size of arm cuff: 9" ~ 17" (23 ~ 43 cm).
- In case the cuff kept pumping up non-stop, open the cuff at once.
- Do not wrap the cuff around any body part other than your arm.
- The device is not supposed to be used when your arm is wounded or injured.

Measurement Procedure





◆ Switch on the Monitor

- Put in 4 AA (LR6) alkaline batteries
- All segments appear on the screen for 3 seconds.
- The monitor will automatically turn to power saving mode (all LCD segment cleared)

◆ Setting Year, Time and Date

- To adjust the date and time, press the **Date/ Time Set**  Button.



- Press  button ("YEAR" flashes). Pressor  but  to adjust YEAR value (2015 is defined initially). Press  again to confirm the entries, and the device turns to standby mode.
- Change the MONTH, DATE, HOUR and MINUTE as described in step B above.

◆ Taking a Measurement

- Check and select functions of Triple-Check Mode and Rest Assure Mode if needed.



- If functions of Triple-Check Mode and Rest Assure Mode are both on, press $\frac{\text{START}}{\text{STOP}}$ key to start 5 minute count down and have a multi-measurement.
- If functions of Triple-Check Mode is on and Rest Assure Mode are off, press $\frac{\text{START}}{\text{STOP}}$ key to start multi-measurement **without** 5 minute count down.
- If function of Triple-Check Mode is off and Rest Assure Mode is on, press $\frac{\text{START}}{\text{STOP}}$ key to start 5 minute count down and have a single measurement.
- If functions of Triple-Check Mode and Rest Assure Mode are both off, press $\frac{\text{START}}{\text{STOP}}$ key to start single measurement **without** 5 minute count down.

Measurement Procedure

B. Select User (see LCD Displays below).

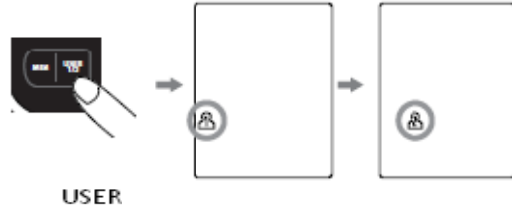

C. Press $1/2$ button to confirm the chosen user.

D-1. Start a Single Measurement:

1. Make sure the Triple-Checkfunctionswitch turned off.
2. If **REST ASSURE MODE is on**, with the cuff wrapped around your upper arm, press $\frac{\text{START}}{\text{STOP}}$ to start a 5 minutes countdown ("REST" flash).
3. Time end, all units appear on the screen for 3 seconds, and start the 1st measurement.
4. When the measurement is finished, the systolic pressure, diastolic pressure, and heart rate with RISK CATEGORY INDICATOR will be displayed and save results to memory automatically (Time & Date changed per 2 seconds).

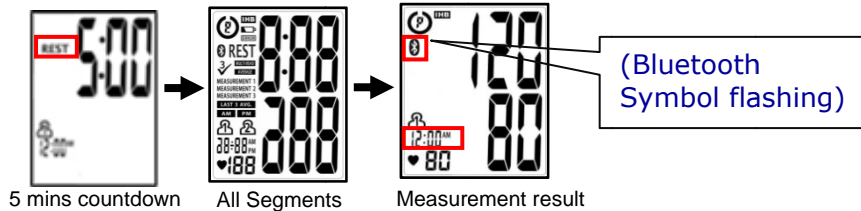

D-2. Start a Single Measurement:

1. Make sure the Triple-Checkfunctionswitch turned off.
2. If **REST ASSURE MODE is off**, with the cuff wrapped around your upper arm, press $\frac{\text{START}}{\text{STOP}}$ to start the measurement. All display units appear on the screen for 3 seconds.
3. When the measurement is finished, the systolic pressure, diastolic pressure, and heart rate with RISK CATEGORY INDICATOR will be displayed and save results to memory automatically (Time and Date changed per 2 seconds).

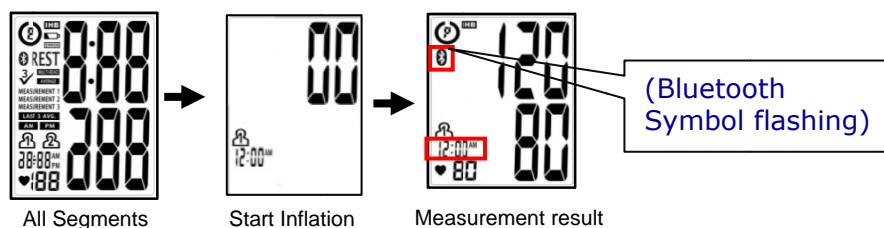

Measurement Procedure

E-1. Start a Multi-Measurement: will take continuative 3 times measurements.

1. Make sure the Triple-Check functions switch turned on.
2. If **REST ASSURE MODE is on**, with the cuff wrapped around your upper arm, press **START/STOP** to start a 5 minutes countdown ("REST" flash).
3. Time end, all units appear on the screen for 3 seconds, and start the 1st measurement. ("MEASUREMENT 1" flash while measuring).
4. After the 1st measurement finished, measuring result will not be showed, and display turned to 1 minute countdown directly ("REST" flash) for the 2nd measurement.
5. Time end, starting the 2nd measurement ("MEASUREMENT 2" flash and "MEASUREMENT 1" non-flash while measuring)
6. After the 2nd measurement finished, measuring result will not be showed, and display turned to 1 minute countdown directly ("REST" flash) for the 3rd measurement.
7. Time end, starting the 3rd measurement ("MEASUREMENT 3" flash and "MEASUREMENT 1 & 2" non-flash while measuring)
8. When the measurement is finished, the average of Multi-measurement (systolic pressure, diastolic pressure, and heart rate with RISK CATEGORY INDICATOR) will be displayed and save results to memory automatically.

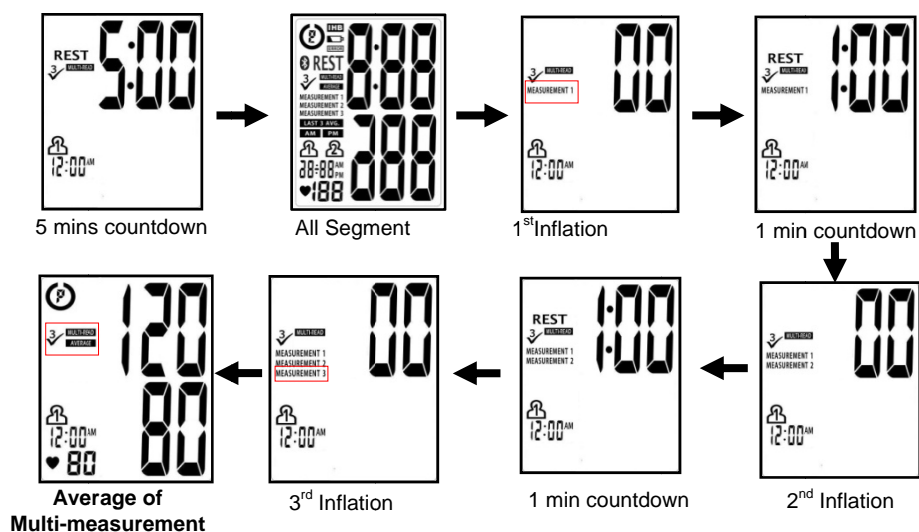

Measurement Procedure

E-2. Start a Multi-Measurement: will take continuative 3 times measurements.

1. Make sure the Triple-Check functions switch turned on.
2. If **REST ASSURE MODE** is off, with the cuff wrapped around your upper arm, press **START/STOP** on to start the measurement. All display units appear on the screen for 3 seconds, and will automatically start the 1st measurement ("MEASUREMENT 1" flash while measuring).
3. After the 1st measurement finished, measuring result will not be showed, and display turned to 1 minute countdown directly ("REST" flash) for the 2nd measurement.
4. Time end, starting the 2nd measurement ("MEASUREMENT 2" flash and "MEASUREMENT 1" non-flash while measuring)
5. After the 2nd measurement finished, measuring result will not be showed, and display turned to 1 minute countdown directly ("REST" flash) for the 3rd measurement.
6. Time end, starting the 3rd measurement ("MEASUREMENT 3" flash and "MEASUREMENT 1 & 2" non-flash while measuring)
7. When the measurement is finished, the average of Multi-measurement (systolic pressure, diastolic pressure, and heart rate with RISK CATEGORY INDICATOR) will be displayed and save results to memory automatically.

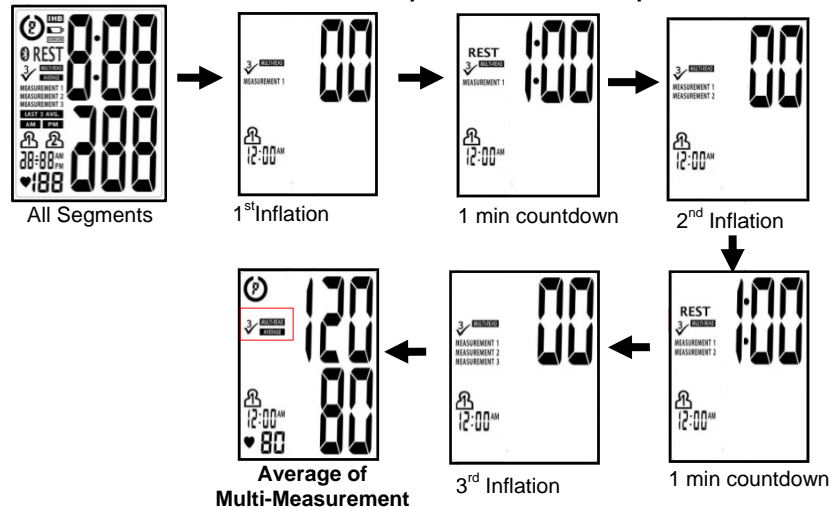

*Note !

1. Do not inflate the cuff until it is wrapped around your upper arm.
2. Without any operation for 1 minute, device turns to the power saving mode.
2. To stop measurement, press **START/STOP** button.
3. Press **MEM** key to memory mode.
4. Press **⌚** key to Date/ Time Setting Mode.
5. Press **USER 1/2** to Change User.
6. Press **START/STOP** key to stop measurement to Power Saving Mode.
7. Press **AM/PM Average** key to display AM/PM average.

Bluetooth Transmission

To activate Bluetooth function, please make sure your Android device have downloaded APP.

There are 2 ways to process Bluetooth function:

Measurement Completed:

1. After measurement completed, the device activates Bluetooth function automatically, (Bluetooth Symbol flashing)
2. HL858CB receive the data request from APP, paired Bluetooth device automatically starts downloading measuring results from blood pressure monitor if it's in an acceptable range (no more than 10 meters) with each other. (Bluetooth Symbol display constantly)
3. HL858CB can only pair up with one Bluetooth device at a time. To transmit measuring results to other Bluetooth device, please retry Steps 1 ~ 2.

Single Measurement Bluetooth Symbol Flash Multi Measurement Bluetooth Symbol Flash

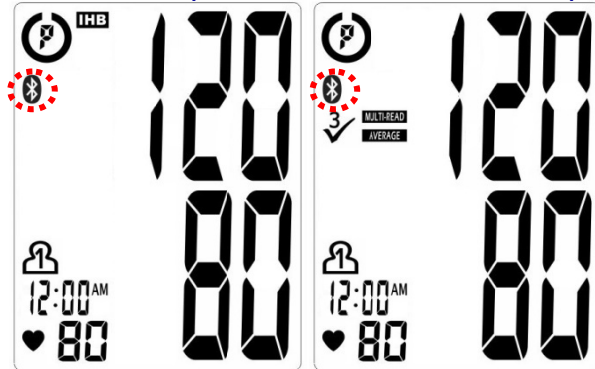

Press and hold ^{START}STOP button for 3 seconds:

1. Under sleep mode, pressing and hold ^{START}STOP button for 3 seconds to wake up the device and turn on Bluetooth function (Bluetooth Symbol flashing)
2. HL858CB receive the data request from APP, paired Bluetooth device automatically starts downloading measuring results from blood pressure monitor if it's in an acceptable range (no more than 10 meters) with each other. (Bluetooth Symbol display constantly)
3. HL858CB can only pair up with one Bluetooth device at a time. To transmit measuring results to other Bluetooth device, please retry as mention above.

Fail connection:

If HL858CB cannot connect to paired Bluetooth device over 15 seconds, LCD will display Error message "E4". (Bluetooth Symbol display constantly)

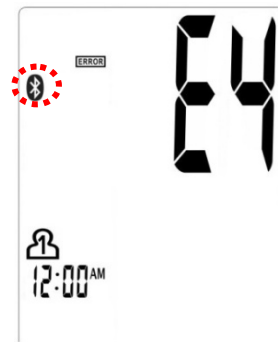

***Note !**

- Without any operation in 1 minute, the device shuts off automatically and Bluetooth Transmission OFF.
- Please do not turn on more than one Bluetooth transmission function of Monitors.

Memory Function

◆ Storing data





After each measurement, the systolic and diastolic pressure, heart rate, Risk Category Indicator and Irregular heartbeat detector (if any) with date and time will be automatically stored.

The monitor can store up to 120 memory sets for per user, and automatically replace the oldest data with new one.

◆ Memory Function

Press **MEM** and **AM/PM Average** key to activate Memory-Select Mode.

1. Press **MEM** button to see previous measuring results, including average of last 3 measurements, a Triple-Check measurement, and individual measurement (120th, 119th, ...1st result).
2. Press **AM/PM Average** button to select an average of 3 AM or PM measurements. Reviewing your morning (AM) and nighttime (PM) blood pressure can provide important information about your health condition.

	An average of Triple-Check measurement (Press ◀ / ▶ key to review individual readings)
	
	An average of Last 3 Measurements
	An average of Last 3 Morning Measurements (4:00 AM - 12:00 PM)
	An average of Last 3 Nighttime Measurements (6:00 PM - 2:00 AM)
Note: A Triple-Check average and its 3 individual measurements are counted as 4 readings when stored in memory.	

Memory Function

◆ Recalling Data in Average Memory Mode

- A. Select User first.
- B. Press MEM key to enter Memory Mode, and LCD displays an average of the last 3 memories. (If a Triple-Check result included, the average of it will be included, but its individual measurements will be not. See the example as below.)

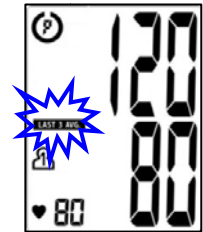

Average of Last 3 Measurements

<e.g. 119th measurement is a Triple-Check result :>

- Press/◀▶ to read 3 results (118th, 117th and 116th) of Triple-Check average (119th)

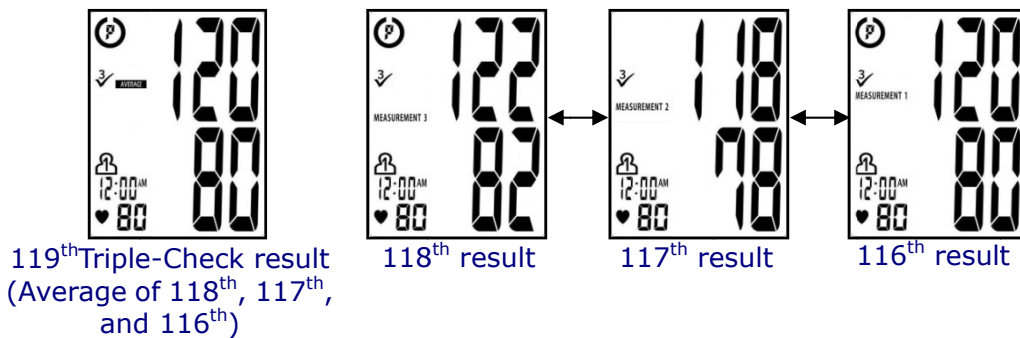

- Average of the last 3 measurements is the average of 120th, 119th (118th, 117th and 116th individual results are excluded) and 115th results.

- C. Keep pressing MEM button to scroll through all stored measuring results in sequence. (120th, 119th, ... 1st).



120th signal result

- D. Press MEM button again and return to Standby Mode.
- E. Press START/ STOP button to return to Power Saving Mode.

Memory Function

◆ Recalling Data in Average Memory Mode

- A. Select User first.
- B. Press AM/PM button to enter Memory Mode.
LCD displays average of latest 3 AM measurements.
- C. Press AM/PM button again, LCD displays average of latest 3 PM measurements.

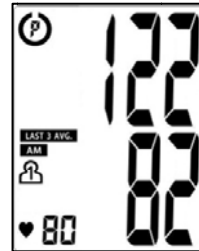

Average of Last 3 AM Measurement

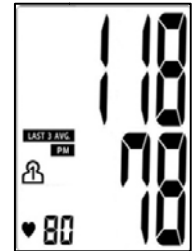

Average of Last 3 PM Measurement

- D. When done, press **MEM** button again and return to Standby Mode.

◆ Erasing data

- A. Select User first.
- B. Press **MEM** button to enter Memory Mode.
- C. Press and hold **▶** and **⌚** buttons at the same time, the data will be erased automatically. LCD Displays "CLR" for 3 seconds.
- D. To confirm deletion, press **MEM** button and no data should appear.

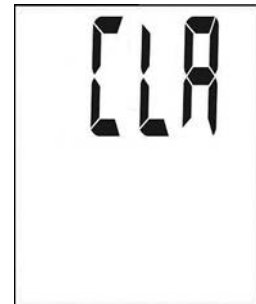

Note: Once deleted, your data can NOT be restored.

Storage and Maintenance

◆ General Use

- Do not in any way twist the cuff.
- Do not press ^{START}STOP button if the cuff is not wrapped around your upper arm.
- Do not drop the product and avoid any strong impacts.

◆ Maintenance

- Use a piece of cloth with water or mild cleansing agent to wipe the device and dry it immediately with a dry cloth.
- Do not use detergent or any strong chemicals to clean the device.
- Use only a dry cloth to wipe the cuff.
- Do not attempt to disassemble or change any parts of the monitor, including arm cuff, due to substitution of a component different from that supplied might result in measurement error.
- If any suggestion or service is requested, please consult your service station.

◆ Storage

- If the device is not to be used for a long time, please remove the batteries from the device (leaking of battery acid can cause the device to malfunction).
- Always store the unit in the storage case after use.
- Do not place the device directly under sunlight, in high temperature, or in humid or dusty places.
- Do not store the device in extremely low (less than $-13^{\circ}\text{F}/-25^{\circ}\text{C}$) and high (more than $158^{\circ}\text{F}/70^{\circ}\text{C}$) temperature, nor in a place its humidity exceeds 93% R.H.

Troubleshooting

SYMBOLS/SYMPTOMS	CONDITIONS/CAUSES	INDICATION/ CORRECTION
Unit does not turn on <u>START</u> when <u>STOP</u> button is pushed.	Worn-out batteries.	Replace them with 4 new AA (LR6) alkaline batteries.
	Battery polarities have been positioned incorrectly.	Re-insert the batteries in the correct positions.
EE Measuring Error Symbol appears when blood pressure value displayed is excessively low or high.	Cuff has been placed incorrectly.	Wrap the cuff properly so that it is positioned correctly.
	Did you talk or move during measurement?	Measure again. Keep arm steady during measurement.
	Shaking of the arm with the cuff on.	Measure again.
E1 Measuring Error Symbol	Air circuit abnormality. Cuff tube may not be plugged into monitor correctly.	Check cuff connection. Measure again.
E2 Measuring Error Symbol	Inflation pressure exceeding 300 mmHg.	Switch the unit off, then measure again.
E3 Measuring Error Symbol	Error determining measurement data.	Measure again.
E4 Fail Connection Error Symbol	HL858CB cannot connect to Bluetooth-enabled device over 15 seconds.	Please refer to Page 25 "Bluetooth Transmission" to retry again.
BPM cannot communicate with Bluetooth-enabled device	Bluetooth-enabled device pair with a wrong device.	Please re-pairing the BPM and Bluetooth-enabled device with each other.
	Bluetooth function is not turn on.	Please press and hold <u>START</u> <u>STOP</u> button for 3 seconds under sleep mode.
	The distance between BPM and Bluetooth-enabled device is out of transmitting range.	Please make sure the acceptable distance (≤ 10 meters) with each other.
	Use an incompatible Bluetooth-enabled device.	Please refer to Page 17 "Bluetooth compatibility" & Page 33 "RF Specification"
	Use non-Bluetooth-enabled device.	Re-insert the batteries and try again.
	Unexpected loss of electrical/mechanical integrity.	Return the device to your local distributor or importer.
Note: If "EP" appears on the display, just return the device to your local distributor or importer.		

Warranty & Recalibration

◆ Warranty For One Year from the manufacturing date

Please note that this warranty does not cover damage caused by misuse or abuse; accident; the attachment of any unauthorized accessory; alteration to the product; improper installation; unauthorized repairs or modifications; improper use of electrical/power supply; loss of power; dropped product; malfunction or damage of an operating part from failure to provide manufacturer's recommended maintenance; transportation damage; theft; neglect; vandalism; or environmental conditions; loss of use during the period the product is at a repair facility or otherwise awaiting parts or repair; or any other conditions whatsoever that are beyond the control of importers or distributors.

◆ Recalibration Notice

To ensure continued measurement precision, all digital blood pressure monitors require recalibration regularly.

After 2 years from the manufacturing date, we recommend you have your monitor recalibrate at the local distributor or importer. The recalibration service plus the charge of shipping and handling fee shall be charged accordingly.

Specifications

Model Number	HL858CB
Measurement Method	Oscillometric
RatedRange of Cuff Pressure	0~300 mmHg
RatedRange of Determination	40~280 mmHg
MeasurementRange of Heart Rate	40~199 beats/minute
Accuracy	Pressure: ± 3 mmHg Pulse: $\pm 5\%$ Max.
Inflation	Automatic Inflation (Air Pump)
Deflation	Automatic Air Release Control Valve
Display	TN LCD (with backlight)
Memory	240 Memory Total for 2 Users
Unit Dimensions	114 X 153 X 70.5 mm (L X W X H) 4.49 X 6.02 X 2.78 inch (L X W X H)
Unit Weight	393g \pm 10 g (13.86oz \pm 0.35oz) (Without Batteries)
Cuff Size	23 ~ 43 cm(9 ~17 inch)
Storage/ Transportation Environment	Temperature: -25°C ~70°C (-13°F ~158 °F) Humidity: \leq 93% R.H.
Operation Environment	Temperature: 5°C ~40°C (41°F ~104°F) Humidity: 15% ~ 93% R.H. Altitude: 700 ~ 1060 hPa
Power Supply	1. AA (LR6) (1.5V) Alkaline Battery x 4 2. 6V 1A AC Adapter (Model: Fuhua, UE08WCP-060100SPA) (Rating: Input :100-240V, 50/60Hz, 400mA Output: 6V, DC 1A)
BatteryLife	Approx. 200Measurements
Power-saving Mode	Without any operation for 1 minute, device automatically shuts off
Accessories	4 AA (LR6) Alkaline Batteries, 6V 1A AC adaptor, Arm Cuffwith Tube, Instruction Manual, Storage Pouch.

***The contents of this manual and the specifications of the device covered by this manual are subject to change for improvement without notice.**

Specifications

RF Type	Bluetooth 4.0 BLE
RF Modulation	GFSK
Effective Radiated Power	0dBm
Data Throughput	0.2Mbps
Expected Delay (Latency Range) in Wireless (RF) Communication	The latency time is less than 0.3ms from sender to receiver.
Integrity	Channel Quality-Driven Data Rate (CQDDR) technology increases the effective data rate and integrity in noisy environments.
Security	AES-128 and application layer user defined
Wireless Operation Distance	Class 2 (Maximum: 10 meter)
RF Frequency / Need for Spectrum Management	2402 - 2480 MHz (allowing for guard bands)
Maximum Limitation	Unlimited
Maximum Permitted Power	2.5 mW
Proximity of Other In-band Transmitters Used in Vicinity	up to 40 bands (2 MHz spacing; centered from 2402 to 2480 MHz)
Wireless Communication Profile	GATT – Client and Server
Wireless Coexistence	Support for 802.11 Coexistence
System requirement of the Bluetooth device	Android 4.3 or above, iPhone 4S or above

Note

 Follow instructions for use.

 BF Classification:

- The applied part is cuff
- Internally powered equipment
- BF type applied part
- IP22
- Not suitable for use in presence of flammable anesthetic mixture with air or with Oxygen or nitrous oxide
- Continuous operation with short-time loading

 To avoid inaccurate results caused by electromagnetic interference between electrical and electronic equipments, do not use the device near a mobile phone or microwave oven. At least keep a maximum output power of 2 W yields and a distance 3.3m away from this equipment.

 Discard the used product to the recycling collection point according to local regulations.

Manufacturer: HEALTH & LIFE CO., LTD.
9F, No. 186, Jian Yi Road, Zhonghe District, New Taipei City, Taiwan.
www.healthandlife.com.tw

Note

***Note !**

This equipment has been tested and found to comply with the limits for a Class B digital device, pursuant to Part 15 of the FCC Rules. These limits are designed to provide reasonable protection against harmful interference in a residential installation.

This equipment generates uses and can radiate radio frequency energy and, if not installed and used in accordance with the instructions, may cause harmful interference to radio communications. However, there is no guarantee that interference will not occur in a particular installation. If this equipment does cause harmful interference to radio or television reception, which can be determined by turning the equipment off and on, the user is encouraged to try to correct the interference by one or more of the following measures:

The user is encouraged to try to correct the interference by one or more of the following measures:

- Reorient or relocate the receiving antenna.
- Increase the separation between the equipment and the receiver.
- Connect the equipment into an outlet on a circuit different from that to which the receiver is connected.
- Consult the dealer or an experienced radio/TV technician for help.

CAUTION:

To assure continued FCC compliance:

1. Any changes or modifications not expressly approved by the grantee of this device could void the user's authority to operate the equipment.
2. This equipment complies with FCC radiation exposure limits set forth for an uncontrolled environment. This equipment should be installed and operated with minimum distance 20cm between the radiator & your body.

FCC Label Compliance Statement:

This device complies with Part 15 of the FCC Rules. Operation is subject to the following two conditions:

- (1) this device may not cause harmful interference, and
- (2) this device must accept any interference received, including interference that may cause undesired operation.

***Note !**

"Changes or modifications not expressly approved by the manufacturer could void the user's authority to operate the equipment".

Essential Performance compliance criteria:

HL858CB essential performance compliance criteria of IEC 60601-1-2 for immunity testing:

The following degradations that associated with basic safety and essential performance should not be allowed.

- Component failure;
- Change in programmable parameters;
- Reset to factory default and the unintended default would interfere with diagnosis, treatment, or monitoring;
- False alarm;
- Initiation of any unintended operation, including unintended or uncontrolled motion, even if accompanied by an alarm;
- Error of a display numerical value sufficiently large to affect diagnosis or treatment or monitoring.
- Noise on a waveform in which the noise would interfere with diagnosis or treatment or monitoring.

Appendix

◆ Guidance and manufacturer's declaration – electromagnetic emissions

The device is intended for use in the electromagnetic environments listed below, and should only be used in such environments:

Emissions test	Compliance	Electromagnetic environment – guidance
RF emissions CISPR 11	Group 1	RF energy is used only to maintain device's operation. Therefore, its RF emissions are so low that it's not likely to cause any interference in nearby electronic equipment.
RF emissions CISPR 11	Class B	The device is suitable for use in all establishments, including domestic establishments, and those directly connected to the public low-voltage power supply network that supplies buildings used for domestic purposes.
Harmonic emissions IEC 61000-3-2	Class A	
Voltage fluctuations/ flicker emissions IEC 61000-3-3	Complies	

◆ Guidance and manufacturer's declaration – electromagnetic immunity

The device is intended for use in the electromagnetic environments listed below, and should only be used in such environments:

Immunity test	IEC 60601 test level	Compliance level	Electromagnetic environment – guidance
Electrostatic discharge (ESD) IEC 61000-4-2	± 6 kV contact ± 8 kV air	± 6 kV contact ± 15 kV air	The relative humidity should be at least 5 %.
Power frequency (50/60 Hz) magnetic field IEC 61000-4-8	3 A/m	30 A/m	Power frequency magnetic fields should be at levels characteristic of a typical location in a typical commercial or hospital environment. Recommended separation distance $r = \frac{I}{188} \text{ (m)}$ where I is the current in amperes in a power bus or an appliance wire and r is the recommended separation distance between your device and the power bus or appliance wire, in meters (m).
Electrical fast transient/burst IEC 61000-4-4	± 2 kV for power supply lines ± 1 kV for input/output lines	± 2 kV for power supply lines ± 1 kV for input/output lines	Mains power quality should be that of a typical commercial or hospital environment.
Surge IEC 61000-4-5	± 1 kV line(s) to line(s) ± 2 kV line(s) to earth	± 1 kV line(s) to line(s) ± 2 kV line(s) to earth	Mains power quality should be that of a typical commercial or hospital environment.
interruptions and voltage variations on power supply input lines IEC 61000-4-11	<5 % UT (>95 % dip in UT) for 0,5 cycle 40 % UT (60 % dip in UT) for 5 cycles 70 % UT (30 % dip in UT) for 25 cycles <5 % UT (>95 % dip in UT) for 5 sec	<5 % UT (>95 % dip in UT) for 0,5 cycle 40 % UT (60 % dip in UT) for 5 cycles 70 % UT (30 % dip in UT) for 25 cycles <5 % UT (>95 % dip in UT) for 5 sec	Mains power quality should be that of a typical commercial or hospital environment. If the user of the device requires continued operation during power mains interruptions, it is recommended that the device be powered from an uninterruptible power supply or a battery.

Appendix

◆ Recommended separation distances between portable and mobile RF communication equipment and the device.

The device is intended for use in an electromagnetic environment where radiated RF disturbances are under control. User can help prevent electromagnetic interference by keeping the device at a minimum distance from portable and mobile RF communications equipment (transmitters). Below table details the maximum output power of transmitter:

Rated maximum output power of transmitter W	Separation distance according to frequency of transmitter m		
	150 kHz to 80 MHz $d = 1.2 \sqrt{P}$	80 MHz to 800 MHz $d = 1.2 \sqrt{P}$	800 MHz to 2.5 GHz $d = 2.3 \sqrt{P}$
0.01	0.12	0.12	0.23
0.1	0.38	0.38	0.73
1	1.2	1.2	2.3
10	3.8	3.8	7.3
100	12	12	23

For transmitters rated at a maximum output power not listed above, the recommended separation distance d in metres (m) can be estimated using the equation applicable to the frequency of the transmitter, where P is the maximum output power rating of the transmitter in watts (W) according to the transmitter manufacturer.

NOTE 1 At 80 MHz and 800 MHz, the separation distance for the higher frequency range applies.

NOTE 2 These guidelines may not apply in all situations. Electromagnetic propagation is affected by absorption and reflection from structures, objects and people.

◆ Guidance and manufacturer's declaration – electromagnetic immunity

The device is intended for use in the electromagnetic environments listed below, and should only be used in such environments:

Immunity test	IEC 60601 test level	Compliance level	Electromagnetic environment – guidance
Conducted RF IEC 61000-4-6	3 Vrms 150 kHz to 80 MHz	6Vrms	Portable and mobile RF communications equipment should be used no closer to any part of the device, including cables, than the recommended separation distance calculated from the equation applicable to the frequency of the transmitter. Recommended separation distance $d = 1.2 \sqrt{P}$
Radiated RF IEC 61000-4-3	3 V/m 80 MHz to 2.5 GHz	3 V/m	$d = 1.2 \sqrt{P}$ 80 MHz to 800 MHz $d = 2.3 \sqrt{P}$ 800 MHz to 2.5 GHz where P is the maximum output power rating of the transmitter in watts (W) according to the transmitter manufacturer and d is the recommended separation distance in metres (m). Field strengths from fixed RF transmitters, as determined by an electromagnetic site survey, ^a should be less than the compliance level in each frequency range. ^b Interference may occur in the vicinity of equipment marked with the following symbol: 

NOTE 1 At 80 MHz and 800 MHz, the higher frequency range applies.

NOTE 2 These guidelines may not apply in all situations. Electromagnetic propagation is affected by absorption and reflection from structures, objects and people.

^a Field strengths from fixed transmitters, such as base stations for radio (cellular/cordless) telephones and land mobile radios, amateur radio, AM and FM radio broadcast and TV broadcast cannot be predicted theoretically with accuracy. To assess the electromagnetic environment due to fixed RF transmitters, an electromagnetic site survey should be considered. If the measured field strength in the location in which the device is used exceeds the applicable RF compliance level above, the device should be observed to verify normal operation. If abnormal performance is observed, additional measures may be necessary, such as reorienting or relocating the device.

^b Over the frequency range 150 kHz to 80 MHz, field strengths should be less than 3 V/m.

Blood Pressure Diary

Date :		Time :		<input type="checkbox"/> Before Meal <input type="checkbox"/> After
Systolic / Diastolic :				Pulse :
Date :		Time :		<input type="checkbox"/> Before Meal <input type="checkbox"/> After
Systolic / Diastolic :				Pulse :
Date :		Time :		<input type="checkbox"/> Before Meal <input type="checkbox"/> After
Systolic / Diastolic :				Pulse :
Date :		Time :		<input type="checkbox"/> Before Meal <input type="checkbox"/> After
Systolic / Diastolic :				Pulse :
Date :		Time :		<input type="checkbox"/> Before Meal <input type="checkbox"/> After
Systolic / Diastolic :				Pulse :
Date :		Time :		<input type="checkbox"/> Before Meal <input type="checkbox"/> After
Systolic / Diastolic :				Pulse :
Date :		Time :		<input type="checkbox"/> Before Meal <input type="checkbox"/> After
Systolic / Diastolic :				Pulse :
Date :		Time :		<input type="checkbox"/> Before Meal <input type="checkbox"/> After
Systolic / Diastolic :				Pulse :
Date :		Time :		<input type="checkbox"/> Before Meal <input type="checkbox"/> After
Systolic / Diastolic :				Pulse :
Date :		Time :		<input type="checkbox"/> Before Meal <input type="checkbox"/> After
Systolic / Diastolic :				Pulse :

P/N : XXXXXXXXX

VER : A001

YYYYMMDD