



## TEST REPORT

### Nr. R23104601

### Federal Communication Commission (FCC)

<b>Report Reference No.</b> .....	R23104601
Date of issue: .....	29.01.2024
Total number pages: .....	58
<b>Customer name</b> .....	Elca S.r.l.
Address .....	Via del Commercio, 7/B – 36065 Mussolente (VI) – Italy
<b>Test specification:</b>	
Standards .....	FCC Rules & Regulations, Title 47:2021 Part 15 paragraph(s): 203, 204, 205, 207, 209, 215 and 247
Non-standard test method .....	N/A
<b>Test Report Form No.</b> .....	15-247_Hopping_DEKRA
Test Report Form(s) Originator ...:	DEKRA Testing and Certification S.r.l.
Master TRF .....	2023-11
<b>General disclaimer:</b>	
The test results presented in this report relate only to the object tested. This report shall not be reproduced, except in full, without the written approval of DEKRA Testing and Certification S.r.l.	
<b>(*) Test item description</b> .....	Transceiver unit
(*) Trademark .....	Elca
(*) Manufacturer .....	Elca S.r.l.
(*) Model / Type reference .....	AT BRAVO-FUNK+ 915 MHz
(*) FCC ID .....	2ABS7ATBRFUP915
(*) Rating(s) .....	7,4 Vdc from battery
<b>Report</b>	
Tested by (name + signature) .....	M. Segalla 
Approved by (name + signature) .....	F. Marenda 

(\*) information provided by the customer

**Summary**

1	Summary.....	2
2	Reference standard .....	3
3	List of attachments.....	3
4	Deviation(s) from test specification .....	3
5	Testing location.....	3
6	General description of tested item and testing condition(s) .....	5
6.1	Photos of the test item.....	6
7	Verdict summary section .....	7
8	Test conditions.....	9
8.1	General.....	9
9	Test results .....	10
9.1	Antenna requirements .....	10
9.2	Emissions in restricted frequency bands and in unrestricted frequency bands .....	11
9.3	20 dB bandwidth.....	35
9.4	Channel separation .....	38
9.5	Number of hopping channels.....	41
9.6	Time of occupancy .....	45
9.7	Band edge .....	48
9.8	Peak Output Power .....	52

<b>Reference standard</b>	
FCC Rules and Regulation Title 47 part 15:2021	--
<b>List of attachments</b>	
Attachment 1: Measurement uncertainty, judgement of compliance and quality manual references	
<b>Deviation(s) from test specification</b>	
None	
<b>Testing location</b>	
DEKRA Testing and Certification S.r.l. Via della Fisica, 20 – 36016 Thiene (VI) – Italy Test site facility's FCC registration number: 182474	

<b>Revision index</b>	<b>Date</b>	<b>Change history</b>
1.0	29.01.2024	--

Testing and sampling:	
Date of receipt of test item .....	30.05.2023
Testing start date .....	31.05.2023
Testing end date .....	18.10.2023
Sampling procedure .....	Sample used for testing chosen by the customer; DEKRA Testing and Certification S.r.l. cannot be considered responsible for the selection of the sample
Internal identification .....	Adhesive label with the product number P230512
General remarks:	
<p>This report shall not be reproduced, except in full, without the written approval of DEKRA Testing and Certification S.r.l.</p> <p>The test results presented in this report relate only to the object tested.</p> <p>“(see appended table)”: refers to a table appended to the report.</p> <p>Throughout this report a comma is used as the decimal separator.</p> <p>Tests reported in this test report marked by wording: “Test not accredited by ACCREDIA” are not part of the ACCREDIA accreditation of this laboratory.</p>	
Possible test case verdicts:	
Test case does not apply to the test object:	N/A (Not Applicable)
Test object meets the requirement:	P (Pass)
Test object does not meet the requirement:	F (Fail)
Test object was not evaluated for the requirement:	N/E (Not Executed)
Definition of symbols used in this test report:	
<input checked="" type="checkbox"/> Indicates that the listed condition, standard or equipment is applicable for this report. <input type="checkbox"/> Indicates that the listed condition, standard or equipment is not applicable for this report.	

**General description of tested item and testing condition(s)**

Description .....	Transceiver unit						
Model Number .....	AT BRAVO-FUNK+ 915 MHz						
FCC ID .....	2ABS7ATBRFUP915						
Serial Number .....	--						
Brand name .....	Elca						
Frequency band .....	902 – 928 MHz						
Nominal frequencies .....	FL: 915,050 MHz	FM: 921,500 MHz	FH: 927,875 MHz				
Test power supply.....	Voltage and Frequency		Reference poles				
			N	L1	L2	L3	PE
	<input type="checkbox"/>	AC:	<input type="checkbox"/>	<input type="checkbox"/>	<input type="checkbox"/>	<input type="checkbox"/>	<input type="checkbox"/>
	<input type="checkbox"/>	AC:	<input type="checkbox"/>	<input type="checkbox"/>	<input type="checkbox"/>	<input type="checkbox"/>	<input type="checkbox"/>
<input checked="" type="checkbox"/>	DC: 7,4 V from battery					<input type="checkbox"/>	
Pseudo randomly ordered list of hopping frequencies .....	See document OPERATIONAL DESCRIPTION FOR AT BRAVO-FUNK+915						
Type of equipment .....	<input checked="" type="checkbox"/> Transmitter unit <input checked="" type="checkbox"/> Receiver unit						
Type of station .....	<input checked="" type="checkbox"/> Portable station <input type="checkbox"/> Mobile station						
Test arrangements of EUT .....	<i>Intended operational arrangement(s) of EUT</i>		<i>Test arrangement (see basic standard)</i>				
	<input type="checkbox"/>	Table-top only	Table-top				
	<input type="checkbox"/>	Floor-standing only	Floor-standing				
	<input type="checkbox"/>	Can be floor-standing or table-top	Table-top				
	<input type="checkbox"/>	Rack mounted	In rack or table-top				
<input checked="" type="checkbox"/>	Other, for example wall mounted, ceiling mounted, handheld, body worn		Table-top				
Operating modes .....	No.	Operating mode of test item					
	1	EUT in continuous transmission at maximum power					
Declination of responsibility .....	Information relating to the description of the sample, components list, and software/hardware version (if reported) are provided by the customer. DEKRA Testing and Certification S.r.l. cannot be considered responsible for this information, for any other document sent by the customer and for any difference between the software version present in the tested sample and that present in the object intended for final sale.  In some cases, the software in the tested sample is in a version dedicated exclusively to the test, and therefore does not represent the software installed in the final version of the product.						

Photos of the test item

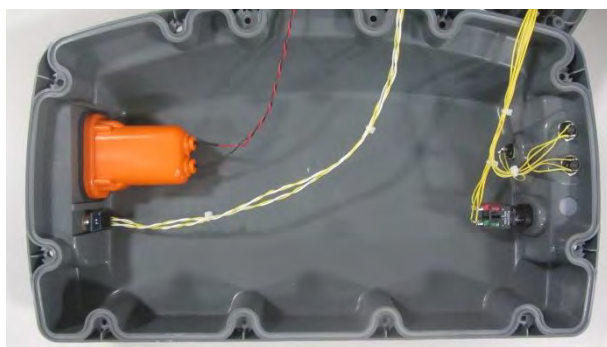

**Verdict summary section**

<b>FCC Rules &amp; Regulations, Title 47:2021</b>			
<b>Part 15 paragraph(s): 203, 204, 205, 207, 209, 215 and 247</b>			
<b>Clause</b>	<b>Requirement – Test case</b>	<b>Basic standard</b>	<b>Verdict</b>
Part 15.247 (a) (1)	Pseudo randomly ordered list of hopping frequencies	--	<b>P</b>
Part 15.203	Antenna requirements	ANSI C63.10	<b>P</b>
Part 15.207	Conducted emissions	ANSI C63.10	<b>N/A (+)</b>
Part 15.209	Radiated emissions and spurious emissions	ANSI C63.10	<b>P</b>
Part 15.247	20 dB Bandwidth	ANSI C63.10	<b>P</b>
Part 15.247	Channel Separation	ANSI C63.10	<b>P</b>
Part 15.247	Number of Hopping Channel	ANSI C63.10	<b>P</b>
Part 15.247	Time of occupancy	ANSI C63.10	<b>P</b>
Part 15.247	Band edge	ANSI C63.10	<b>P</b>
Part 15.209 and 15.247	Peak Output Power	ANSI C63.10	<b>P</b>

(+) Devices which only employ battery power. See FCC Part 15.207 (c)

<b>Normative references</b>	
<b>Reference no.</b>	<b>Description</b>
FCC Rules and Regulation Title 47 part 15:2021	--
KDB 558074 D01 15.247 Meas Guidance v05r02	Guidance for compliance measurements on Digital Transmission System, Frequency Hopping Spread Spectrum System, and Hybrid System Devices operating under section 15.247 of the FCC rules
ANSI C63.4:2014	American National Standard for Methods of Measuring of Radio-Noise Emissions from Low-Voltage Electrical and Electronic Equipment in the Range of 9 kHz – 40 GHz
ANSI C63.10:2013	American National Standard of Procedures for Compliance Testing of Unlicensed Wireless Devices



**Test conditions**

**General**

Environmental reference conditions..... :	The climatic conditions during the tests are within the limits specified by the manufacturer for the operation of the EUT and the test equipment. The climatic conditions during the tests were within the following limits:		
	<b>Temperature</b>	<b>Humidity</b>	<b>Atmospheric pressure</b>
	15 °C – 35 °C	30 % - 60 %	800 hPa – 1060 hPa
	If explicitly required in the basic standard or applied product standard the climatic values are recorded and documented separately in this test report.		
Measurement uncertainties ..... :	Attachment 1		

**Test results**

**Antenna requirements**

Tested by .....	M. Segalla	
Test date .....	31.05.2023	
Reference standards.....	FCC Rules and Regulation; Titles 47 Part. 15.203 and 15.204	
Test specification .....	<p>An intentional radiator shall be designed to ensure that no antenna other than that furnished by the responsible party shall be used with the device. The use of a permanently attached antenna or of an antenna that uses a unique coupling to the intentional radiator shall be considered sufficient to comply with the provisions of this section. The manufacturer may design the unit so that a broken antenna can be replaced by the user, but the use of a standard antenna jack or electrical connector is prohibited. This requirement does not apply to carrier current devices or to devices operated under the provisions of §§ 15.211, 15.213, 15.217, 15.219, 15.221, or § 15.236. Further, this requirement does not apply to intentional radiators that must be professionally installed, such as perimeter protection systems and some field disturbance sensors, or to other intentional radiators which, in accordance with § 15.31(d), must be measured at the installation site. However, the installer shall be responsible for ensuring that the proper antenna is employed so that the limits in this part are not exceeded</p>	
Antenna type .....	<input checked="" type="checkbox"/>	Integral antenna
	<input type="checkbox"/>	External antenna
Antenna gain .....	-1,416 dBi	
External R.F. power amplifier.....	Not Present	

**Emissions in restricted frequency bands and in unrestricted frequency bands**

Tested by .....	M. Segalla	
Test date .....	30.05.2023	
Test location (stand) .....	Semi-anechoic chamber (CMC A070)	
Reference standards.....	FCC Rules and Regulation; Titles 47 Part. 15.209 ANSI C63.10 cl. 6.3, 6.4, 6.5 and 6.6	
Test set-up description.....	<input checked="" type="checkbox"/>	Table top equipment set-up (80 cm above the reference ground plane)
	<input type="checkbox"/>	Floor standing equipment set-up (insulating material up to 12 mm thick)
	<input type="checkbox"/>	False floor installation equipment set-up (insulating material up to 34 cm above the reference ground plane)
Supplementary test set-up description.....	--	
Test method applied .....	OATS or SAC with measurement distance [m]: 10 m for frequencies below 1 GHz 3 m for frequencies above 1 GHz	
Supplementary information .....	--	

**Acceptance limits**

<b>Acceptance limits for emissions in restricted frequency bands (<math>f &lt; 1000</math> MHz)</b>		
Frequency range (MHz)	Test distance (m)	Limits [dB( $\mu$ V/m)]
0,009 to 0,490	300	$20\log(2400/F(\text{kHz}))$
0,490 to 1,705	30	$20\log(24000/F(\text{kHz}))$
1,705 to 30	30	$20\log(30)$
30 to 88	3	$20\log(100)^{**}$
88 to 216	3	$20\log(150)^{**}$
216 to 960	3	$20\log(200)^{**}$
Above 960	3	$20\log(500)$

\*\* : except as provided in paragraph (g), fundamental emissions from intentional radiators operating under this section shall not be located in the frequency bands 54 – 72 MHz, 76 – 88 MHz, 174 – 216 MHz or 470 – 806 MHz. However, operation within these frequency bands is permitted under other sections of this part, e.g., §§ 15.231 and 15.241.

Perimeter protection systems may operate in the 54 – 72 MHz and 76 – 88 MHz bands under the provisions of this section. The use of such perimeter protection systems is limited to industrial, business and commercial applications.

**Remarks:** the emission limits shown in the above table are based on measurements employing a CISPR quasi-peak detector except for the frequency bands 9 – 90 kHz and 110 – 490 kHz. Radiated emission limits in these two bands are based on measurements employing an average detector. The results have been extrapolated to the specified distance using an extrapolation factor

<b>Acceptance limits for emissions in restricted frequency bands (<math>f \geq 1000</math> MHz)</b>			
Frequency (MHz)	Test distance (m)	AV limits [dB( $\mu$ V/m)]	Peak limits [dB( $\mu$ V/m)]
> 1000	3	54	74

The restricted frequency bands are listed in the following table

<b>MHz</b>	<b>MHz</b>	<b>MHz</b>	<b>GHz</b>
0,090 – 0,110	16,42 – 16,423	399,9 – 410	4,5 – 5,15
0,495 – 0,505	16,69475 – 16,69525	608 – 614	5,35 – 5,46
2,1735 – 2,1905	16,80425 – 16,80475	960 – 1240	7,25 – 7,75
4,125 – 4,128	25,5 – 25,67	1300 – 1427	8,025 – 8,5
4,17725 – 4,17775	37,5 – 38,25	1435 – 1626,5	9,0 – 9,2
4,20725 – 4,20775	73 – 74,6	1645,5 – 1646,5	9,3 – 9,5
6,215 – 6,218	74,8 – 75,2	1660 – 1710	10,6 – 12,7
6,26775 – 6,26825	108 – 121,94	1718,8 – 1722,2	13,25 – 13,4
6,31175 – 6,31225	123 – 138	2200 – 2300	14,47 – 14,5
8,291 – 8,294	149,9 – 150,05	2310 – 2390	15,35 – 16,2
8,362 – 8,366	156,52475 – 156,52525	2483,5 – 2500	17,7 – 21,4
8,37625 – 8,38675	156,7 – 156,9	2690 – 2900	22,01 – 23,12
8,41425 – 8,41475	162,0125 – 167,17	3260 – 3267	23,6 – 24,0
12,29 – 12,293	167,72 – 173,2	3332 – 3339	31,2 – 31,8
12,51975 – 12,52025	240 – 285	3345,8 – 3358	36,43 – 36,5
12,57675 – 12,57725	322 – 335,4	3600 – 4400	Above 38,6
13,36 – 13,41			

#### **Acceptance limits for emissions in non-restricted frequency bands**

In any 100 kHz bandwidth outside the frequency band in which the spread spectrum or digitally modulated intentional radiator is operating, the radio frequency power that is produced by the intentional radiator shall be at least 20 dB below that in the 100 kHz bandwidth within the band that contains the highest level of the desired power, based on either an RF conducted or a radiated measurement, provided the transmitter demonstrates compliance with the peak conducted power limits.

**Test setup**

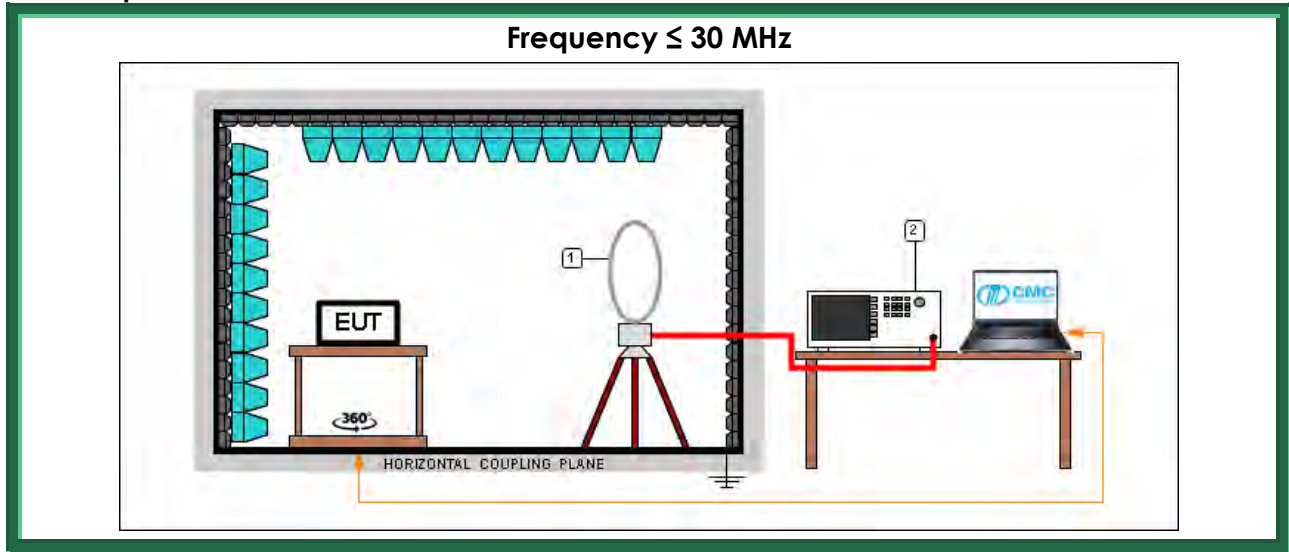

*Test setup PE004\_01*

Nr.	Id. Number	Manufacturer	Model	Serial number	Description	Last calibration date	Calibration expiration
2	CMC S353	Rohde & Schwarz	ESW26	101492	Emi Test Receiver	December 2022	December 2023
1	CMC S127	Schaffner	HLA6120	1191	Loop Antenna 9kHz - 30MHz	May 2023	May 2024

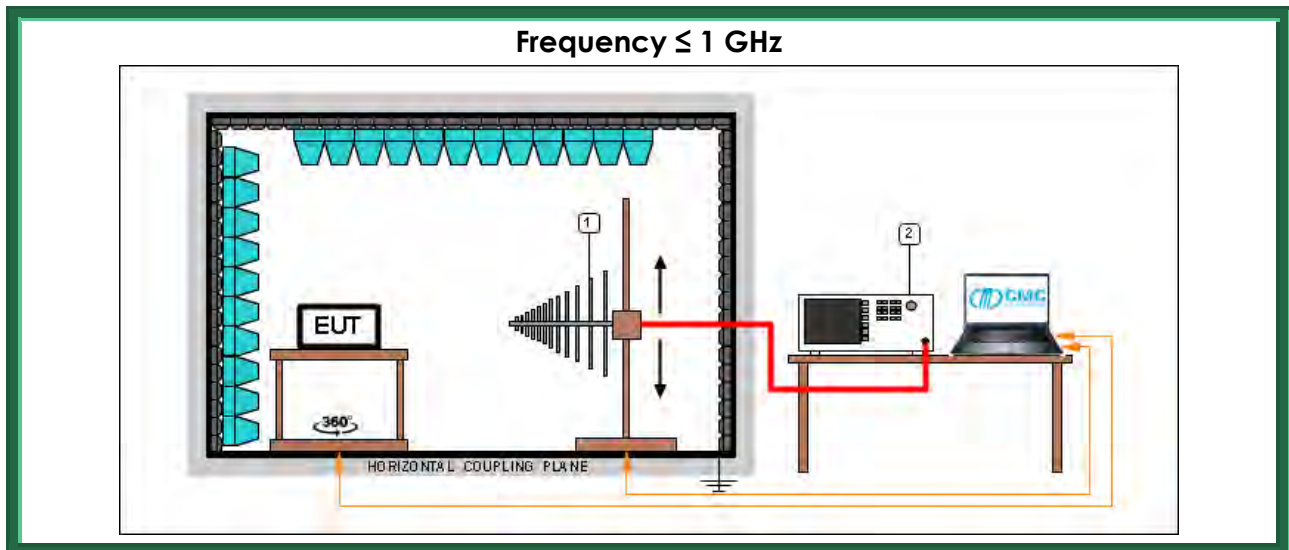

*Test setup PE004\_02*

Nr.	Id. Number	Manufacturer	Model	Serial number	Description	Last calibration date	Calibration expiration
2	CMC S353	Rohde & Schwarz	ESW26	101492	Emi Test Receiver	December 2022	December 2023
1	CMC S271	Schwarzbeck	BBA 9106 + VHBB 9124	831	Broadband Antenna	August 2022	August 2025

Test setup PE004\_03

Nr.	Id. Number	Manufacturer	Model	Serial number	Description	Last calibration date	Calibration expiration
2	CMC S353	Rohde & Schwarz	ESW26	101492	Emi Test Receiver	December 2022	December 2023
1	CMC S287	Schwarzbeck	VUSLP 9111B	9111B-203	Broadband Antenna	August 2022	August 2025

Frequency &gt; 1 GHz

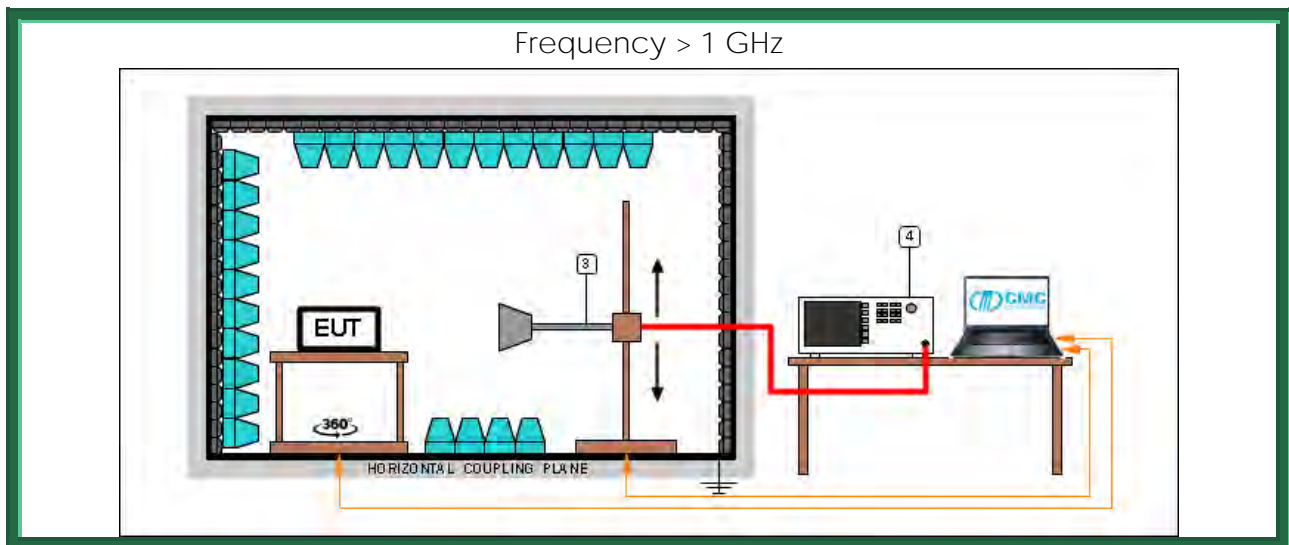

Test setup PE004\_04

Nr.	Id. Number	Manufacturer	Model	Serial number	Description	Last calibration date	Calibration expiration
4	CMC S353	Rohde & Schwarz	ESW26	101492	Emi Test Receiver	December 2022	December 2023
3	CMC S108	Emco	3115	9811-5622	Waveguide antenna	August 2022	August 2025

Test setup PE004\_05

Nr.	Id. Number	Manufacturer	Model	Serial number	Description	Last calibration date	Calibration expiration
4	CMC S353	Rohde & Schwarz	ESW26	101492	Emi Test Receiver	December 2022	December 2023
3	CMC S290	Schwarzbeck	BBHA 9170	733	Horn Antenna	October 2021	October 2026

**Result**

Transmission frequency (MHz)	Polarization	Frequency Range (MHz)	Graphs	Result
915,050	H	1000 – 10000	G23104601	P
915,050	V	1000 – 10000	G23104602	P
921,500	V	1000 – 10000	G23104603	P
921,500	H	1000 – 10000	G23104604	P
927,875	H	1000 – 10000	G23104605	P
927,875	V	1000 – 10000	G23104606	P
915,050	V	30 – 300	G23104607	P
915,050	H	30 – 300	G23104608	P
915,050	H	300 – 1000	G23104609	P
915,050	V	300 – 1000	G23104610	P
921,500	V	30 – 300	G23104611	P
921,500	H	30 – 300	G23104612	P
921,500	H	300 – 1000	G23104613	P
921,500	V	300 – 1000	G23104614	P
927,875	V	300 – 1000	G23104615	P
927,875	H	300 – 1000	G23104616	P
927,875	H	30 – 300	G23104617	P
927,875	V	30 – 300	G23104618	P
Worst case	Loop	0,009 – 30	G23104619	P

**Remarks:** EUT was tested in 3 orthogonal planes, graphs are related to the highest detected levels. Measurements at frequencies lower than 30 MHz have been performed with an EUT – antenna distance of 10 m. Measured values have been corrected with conversion factor  $40\log(\text{test distance}/10)$  based on the measuring distance provided by the standard.

Measurements at frequencies higher than 30 MHz and lower than 1000 MHz have been performed with an EUT – antenna distance of 10 m. Measured values have been corrected with conversion factor  $20\log(\text{test distance}/10)$  based on the measuring distance provided by the standard.

Peaks above the limits are caused by the nominal transmitting frequencies

**Graphs Legend**

PK: Peak; QP [1s] (quasi-peak at 1 second) values are marked with a +  
 AV: Average; AV [1s] (average at 1 second) values are marked with a X

## Graphs

Segalla 23104601

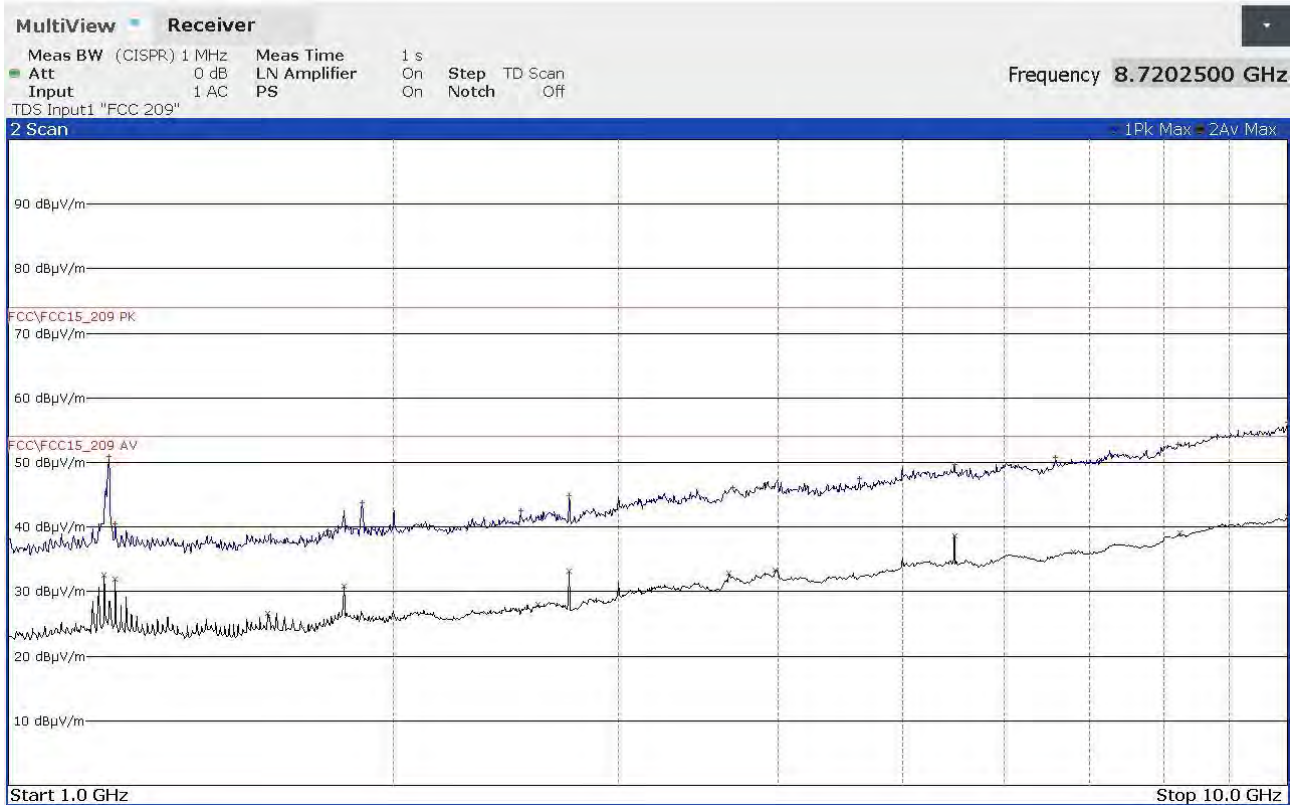

### FINAL RESULT TABLE

MAX PEAK			AVERAGE		
Freq Hz	Lev dBuV/m	Margin dB	Freq Hz	Lev dBuV/m	Margin dB
1198750000	+50,96	-23,02	1188000000	+32,49	-21,49
1212000000	+40,55	-33,43	1212000000	+31,96	-22,02
1776000000	+39,38	-34,60	1596000000	+26,63	-27,35
1890750000	+43,76	-30,22	1830000000	+30,77	-23,21
2516250000	+42,52	-31,46	2595000000	+28,02	-25,96
2745250000	+44,85	-29,13	2745000000	+33,17	-20,81
3681500000	+46,17	-27,81	3660250000	+32,85	-21,13
4630250000	+47,51	-26,47	3977250000	+33,36	-20,62
5490250000	+49,64	-24,34	5490250000	+38,57	-15,41
6583500000	+50,80	-23,18	6807000000	+36,08	-17,90
8210000000	+52,82	-21,16	8235500000	+39,17	-14,81
9998000000	+56,18	-17,80	10000000000	+41,65	-12,33

23104601\_2



Segalla 23104602

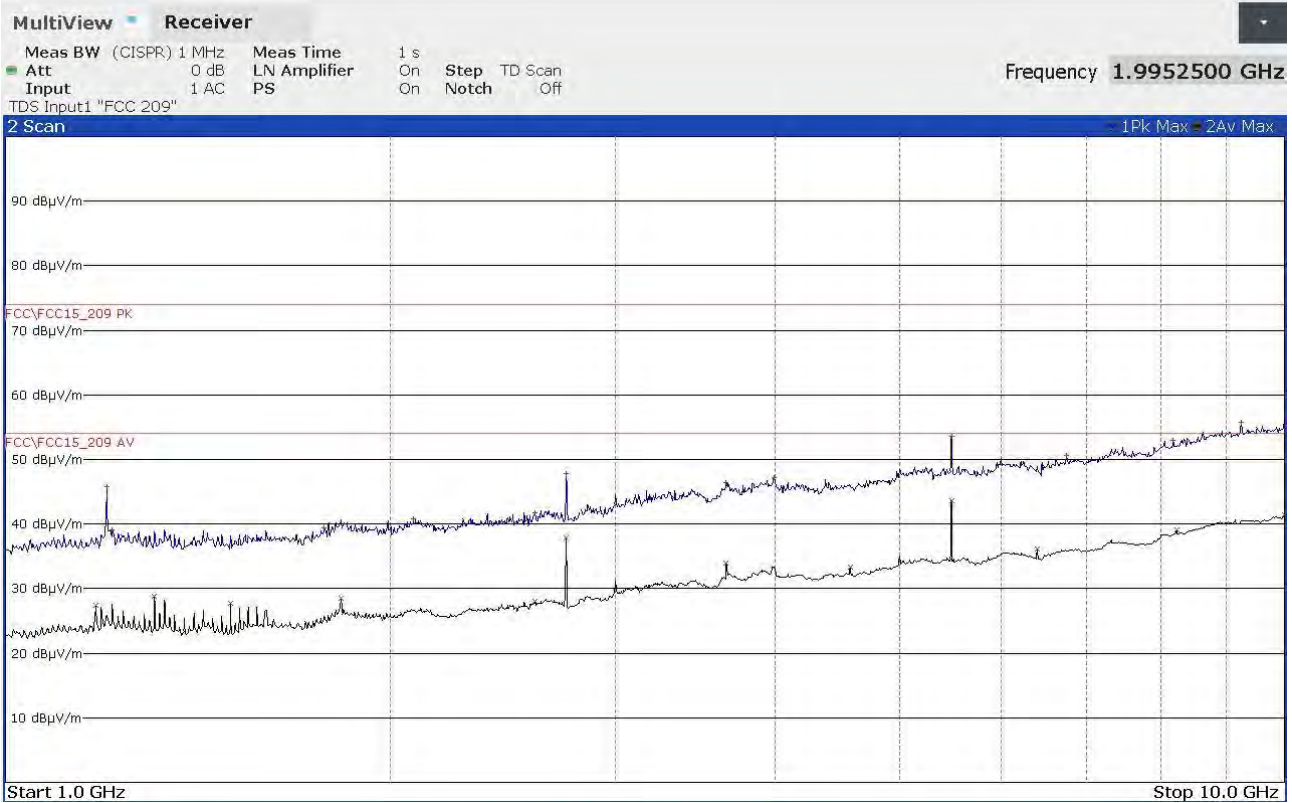

FINAL RESULT TABLE

MAX PEAK			AVERAGE		
Freq Hz	Lev dBuV/m	Margin dB	Freq Hz	Lev dBuV/m	Margin dB
1201000000	+45,83	-28,15	1176000000	+27,39	-26,59
1211750000	+39,12	-34,86	1308000000	+28,86	-25,12
1775500000	+39,39	-34,59	1500000000	+27,72	-26,26
2085500000	+40,83	-33,15	1830000000	+28,48	-25,50
2595000000	+41,74	-32,24	2595000000	+28,01	-25,97
2745250000	+47,80	-26,18	2745250000	+37,88	-16,10
3660250000	+46,48	-27,50	3660250000	+34,01	-19,97
3986250000	+47,23	-26,75	4575250000	+33,39	-20,59
5490250000	+53,54	-20,44	5490250000	+43,57	-10,41
6754500000	+50,63	-23,35	6405250000	+36,15	-17,83
8187750000	+52,91	-21,07	8235500000	+39,04	-14,94
9250000000	+55,73	-18,25	10000000000	+41,49	-12,49

23104602\_2

Segalla 23104603

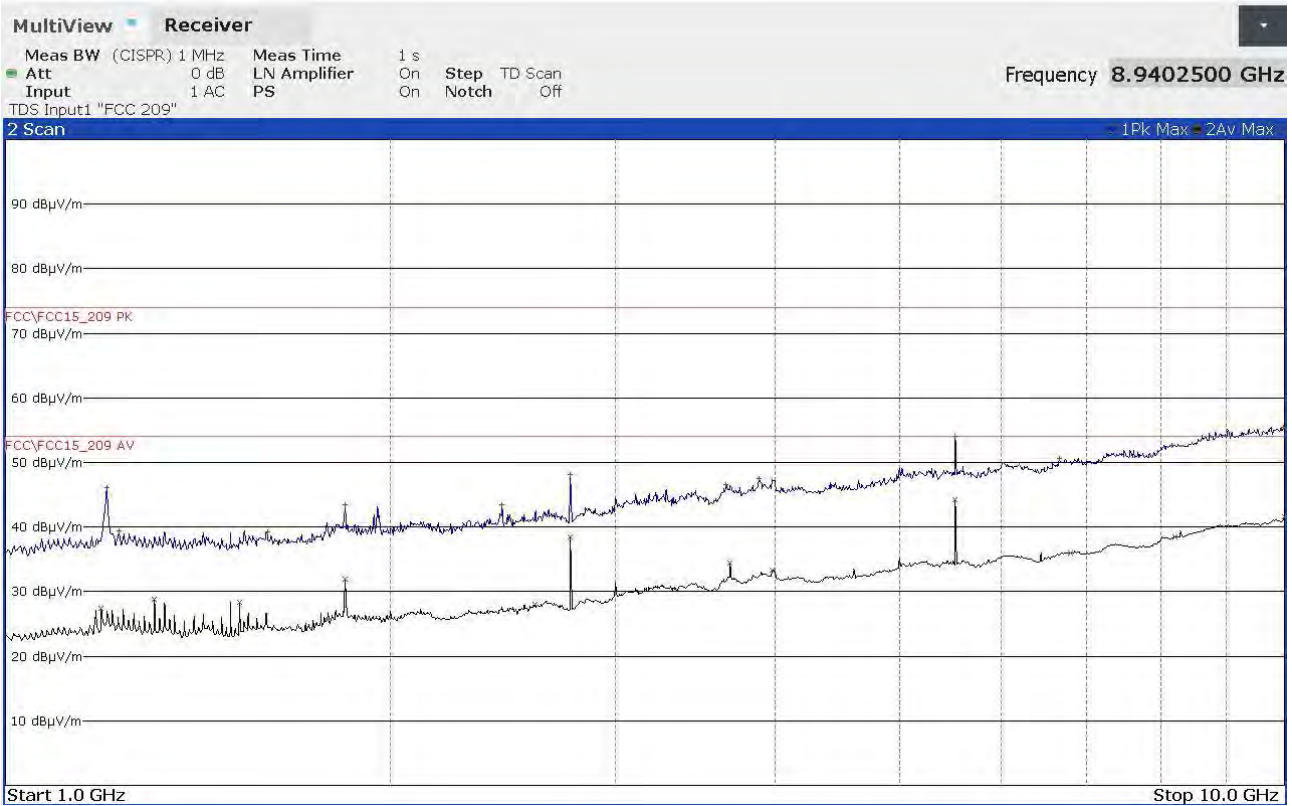

**FINAL RESULT TABLE**

MAX PEAK			AVERAGE		
Freq Hz	Lev dBuV/m	Margin dB	Freq Hz	Lev dBuV/m	Margin dB
1200000000	+46,15	-27,83	1188000000	+27,48	-26,50
1226250000	+39,38	-34,60	1308000000	+28,85	-25,13
1602500000	+39,23	-34,75	1524000000	+28,34	-25,64
1843000000	+43,39	-30,59	1843000000	+31,94	-22,04
2444250000	+43,53	-30,45	2595000000	+28,05	-25,93
2764500000	+48,17	-25,81	2764500000	+38,46	-15,52
3660250000	+46,51	-27,47	3686000000	+34,35	-19,63
3882500000	+47,47	-26,51	3977250000	+33,41	-20,57
5529000000	+53,99	-19,99	5529000000	+44,16	-9,82
6667500000	+50,58	-23,40	6807500000	+36,05	-17,93
8166500000	+52,69	-21,29	8210750000	+38,51	-15,47
9979750000	+55,48	-18,50	10000000000	+41,52	-12,46

23104603\_2

Segalla 23104604

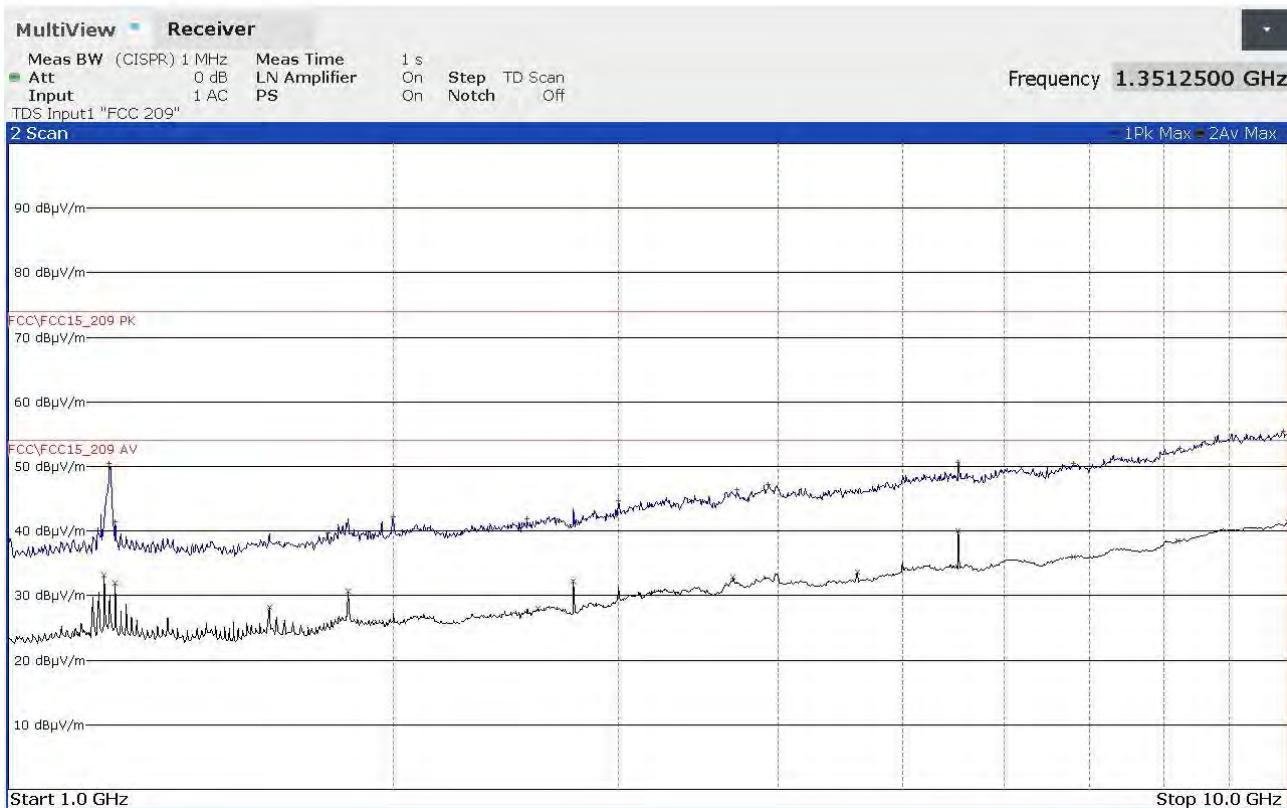

**FINAL RESULT TABLE**

MAX PEAK			AVERAGE		
Freq Hz	Lev dBuV/m	Margin dB	Freq Hz	Lev dBuV/m	Margin dB
1199000000	+50,50	-23,48	1188000000	+33,21	-20,77
1212000000	+41,43	-32,55	1212000000	+31,98	-22,00
1776000000	+39,75	-34,23	1599500000	+28,17	-25,81
1999250000	+42,25	-31,73	1843000000	+30,63	-23,35
2542500000	+41,93	-32,05	2595000000	+28,04	-25,94
2998250000	+44,70	-29,28	2764500000	+32,32	-21,66
3711500000	+46,39	-27,59	3686000000	+32,79	-21,19
3928250000	+47,21	-26,77	4607500000	+33,63	-20,35
5529000000	+50,68	-23,30	5529000000	+40,03	-13,95
6808250000	+50,54	-23,44	6807750000	+36,04	-17,94
8236250000	+52,82	-21,16	8210000000	+38,50	-15,48
9926250000	+55,46	-18,52	10000000000	+41,50	-12,48

23104604\_2

Segalla 23104605

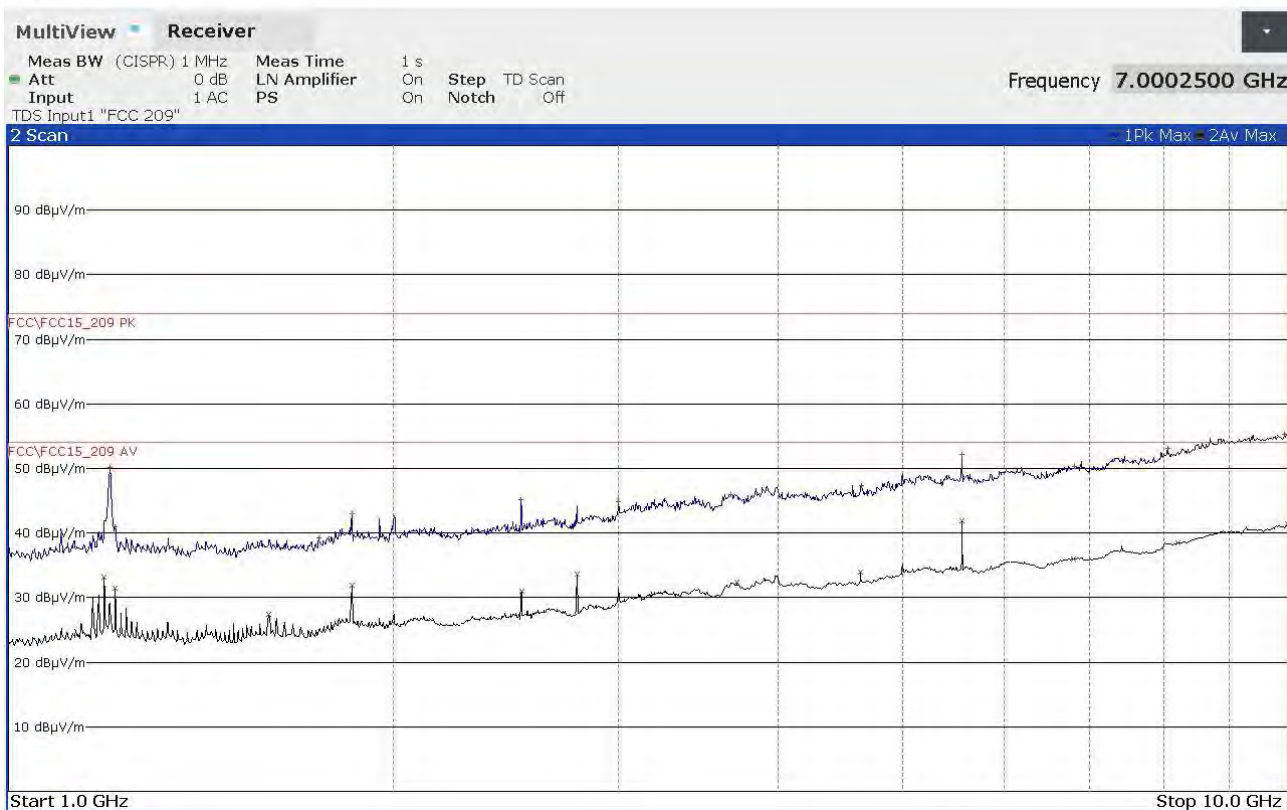

FINAL RESULT TABLE

MAX PEAK			AVERAGE		
Freq Hz	Lev dBuV/m	Margin dB	Freq Hz	Lev dBuV/m	Margin dB
1200750000	+50,22	-23,76	1188000000	+33,19	-20,79
1212250000	+40,91	-33,07	1212000000	+31,42	-22,56
1748000000	+39,32	-34,66	1599000000	+27,35	-26,63
1855750000	+43,00	-30,98	1856000000	+31,99	-21,99
2517000000	+45,20	-28,78	2518000000	+31,04	-22,94
2998250000	+44,88	-29,10	2783750000	+33,58	-20,40
3672750000	+45,97	-28,01	3711750000	+32,46	-21,52
4640250000	+47,37	-26,61	4639750000	+33,89	-20,09
5567750000	+52,20	-21,78	5567750000	+41,95	-12,03
6811750000	+50,27	-23,71	6806500000	+36,05	-17,93
8059250000	+53,14	-20,84	8213750000	+38,52	-15,46
9948250000	+55,23	-18,75	9999500000	+41,51	-12,47

23104605\_2

Segalla 23104606

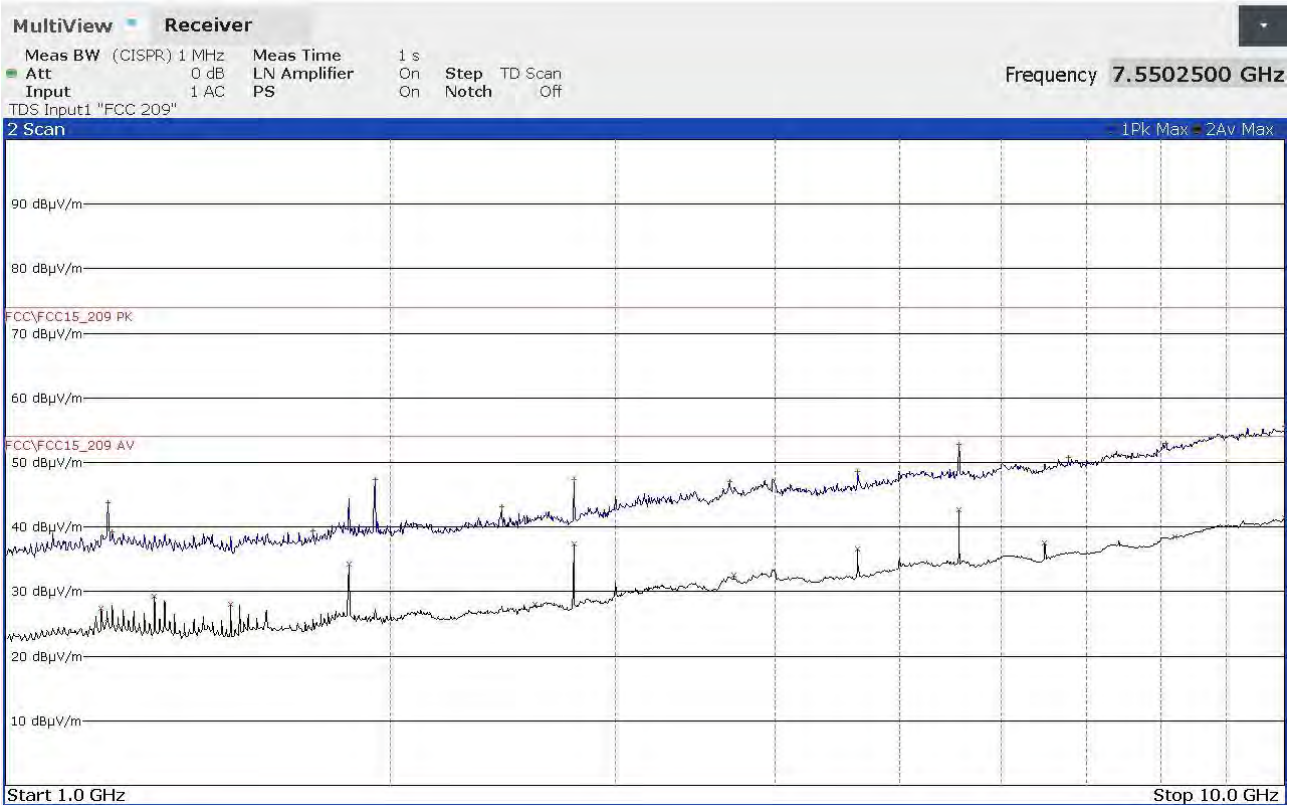

**FINAL RESULT TABLE**

MAX PEAK			AVERAGE		
Freq Hz	Lev dBuV/m	Margin dB	Freq Hz	Lev dBuV/m	Margin dB
1202250000	+43,81	-30,17	1188000000	+27,44	-26,54
1211750000	+39,18	-34,80	1308000000	+29,22	-24,76
1739000000	+39,37	-34,61	1500000000	+28,01	-25,97
1945500000	+47,30	-26,68	1856000000	+34,26	-19,72
2443000000	+43,14	-30,84	2595000000	+28,03	-25,95
2783750000	+47,29	-26,69	2783750000	+37,31	-16,67
3683500000	+47,08	-26,90	3711750000	+32,62	-21,36
4639750000	+48,60	-25,38	4639750000	+36,68	-17,30
5567750000	+52,85	-21,13	5567750000	+42,62	-11,36
6779750000	+50,71	-23,27	6495750000	+37,49	-16,49
8084250000	+52,97	-21,01	8210500000	+38,52	-15,46
9999750000	+55,60	-18,38	10000000000	+41,51	-12,47

23104606\_2

Panozzo 23104607

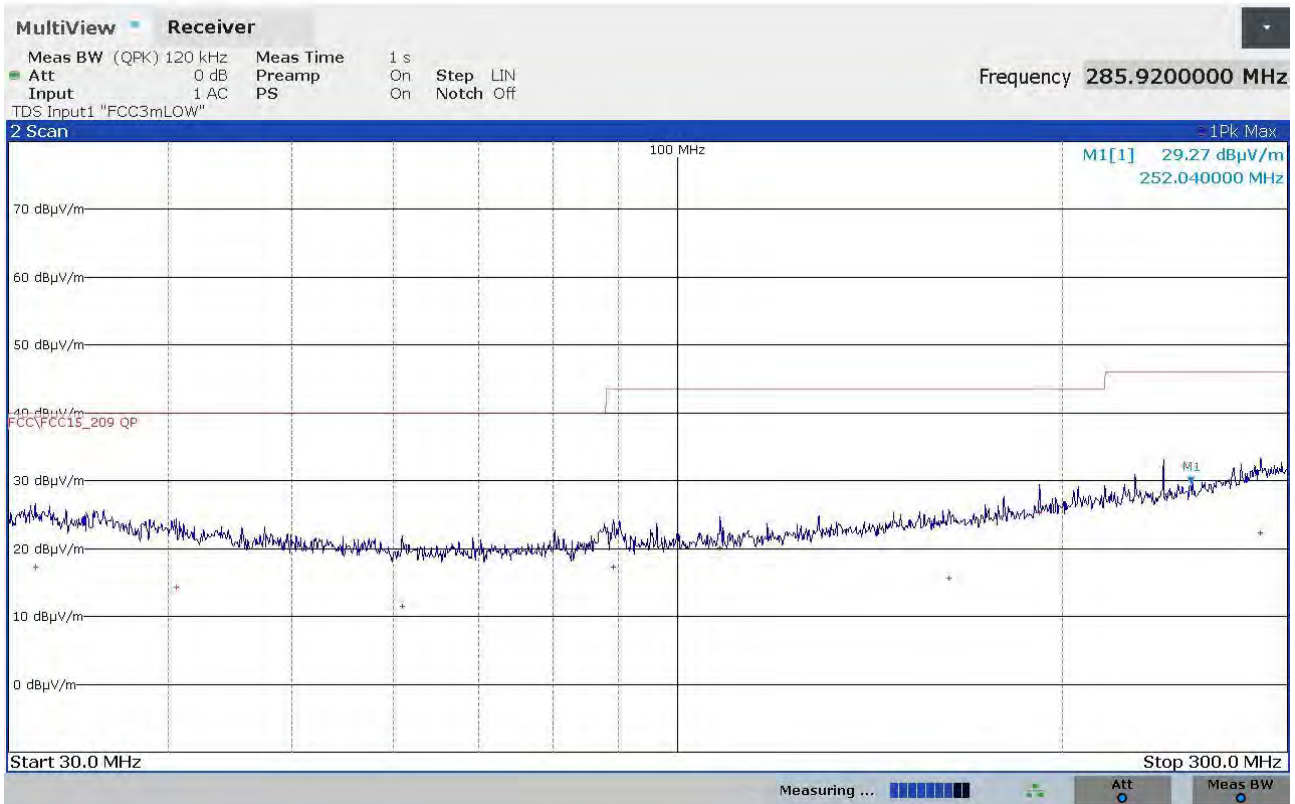

### FINAL RESULT TABLE

QUASI PEAK		
Freq Hz	Lev dBuV/m	Margin dB
31480000	+17,32	-22,68
40560000	+14,34	-25,66
60920000	+11,51	-28,49
89200000	+17,29	-26,23
108000000	+20,16	-23,36
163040000	+15,66	-27,86
192000000	+25,22	-18,30
285920000	+22,25	-23,77

23104607\_2

Panozzo 23104608

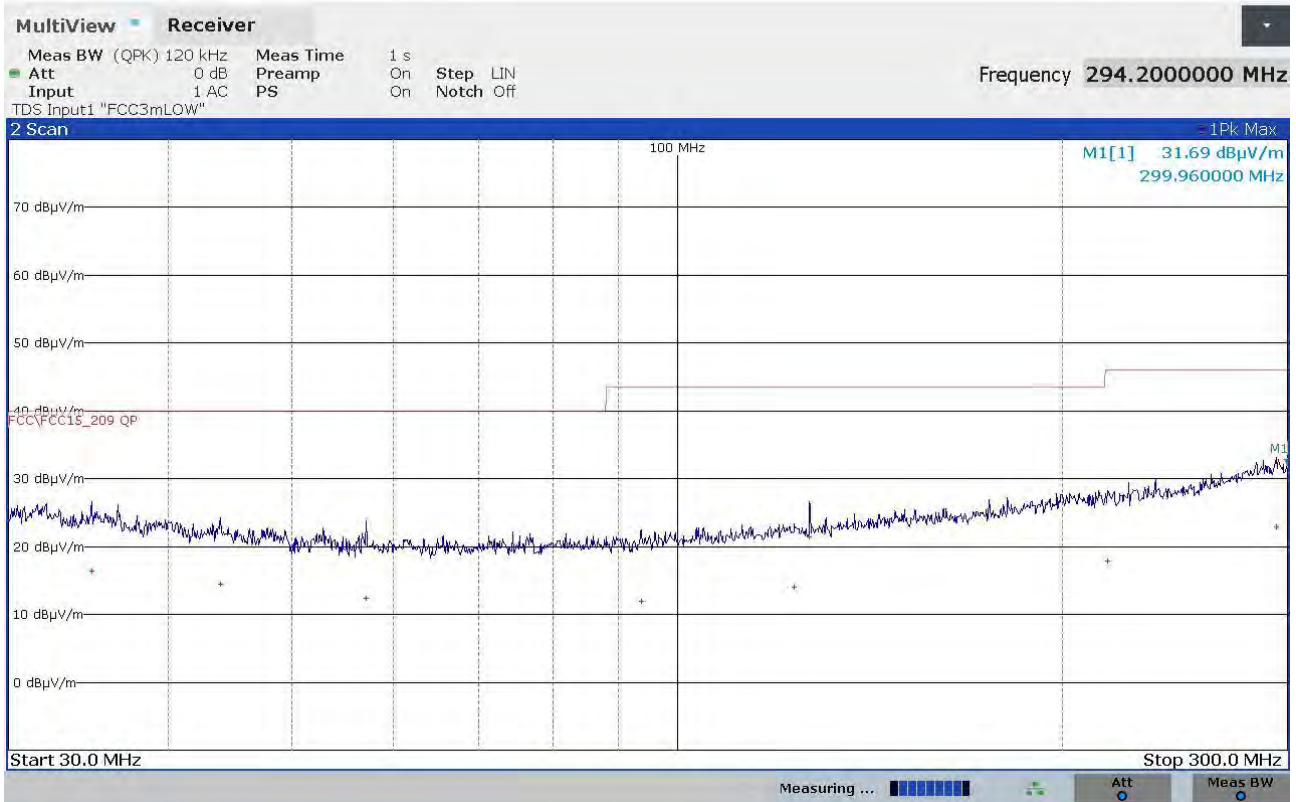

**FINAL RESULT TABLE**

QUASI PEAK		
Freq Hz	Lev dBuV/m	Margin dB
34840000	+16,38	-23,62
43920000	+14,49	-25,51
57120000	+12,44	-27,56
93680000	+12,00	-31,52
123520000	+13,96	-29,56
126920000	+21,48	-22,04
217040000	+17,94	-28,08
294200000	+22,86	-23,16

23104608\_2

Panozzo 23104609

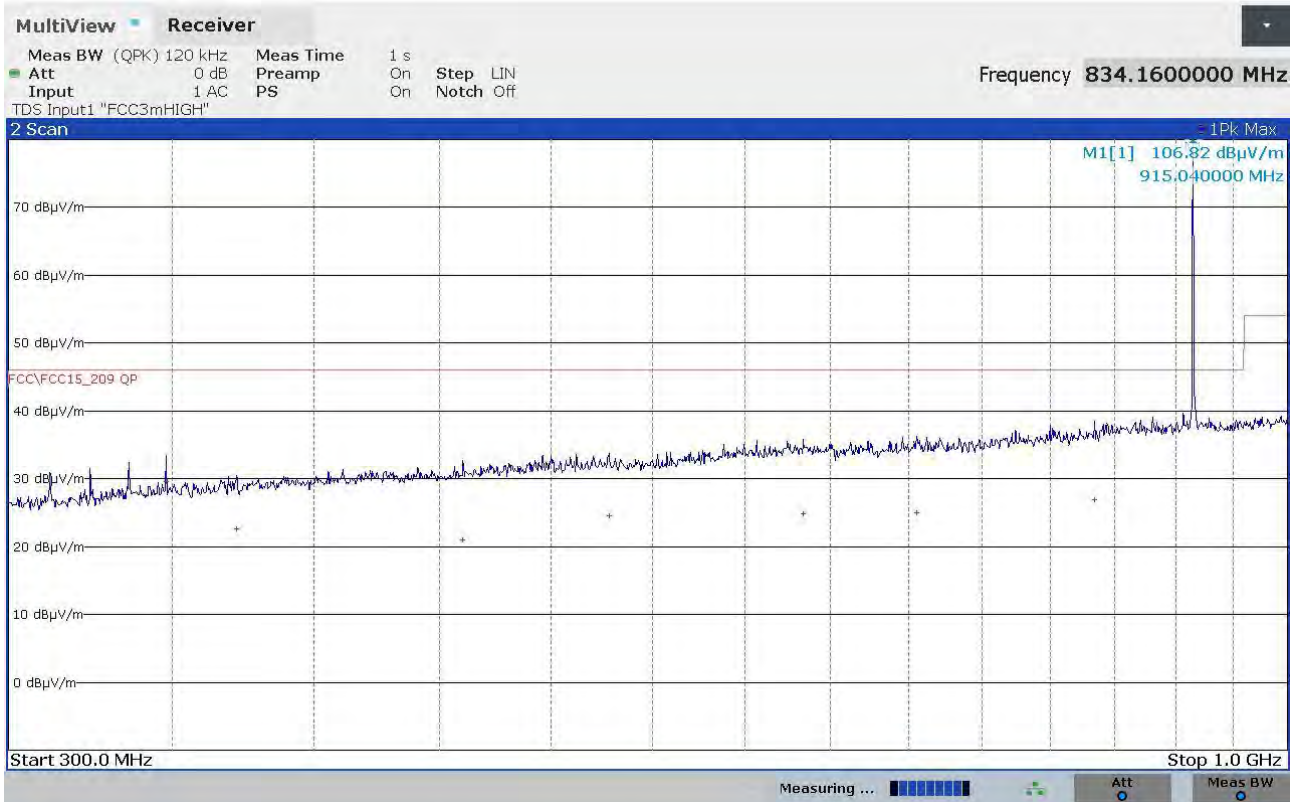

### FINAL RESULT TABLE

QUASI PEAK		
Freq Hz	Lev dBuV/m	Margin dB
348000000	+29,54	-16,48
371960000	+22,68	-23,34
460120000	+20,94	-25,08
528000000	+24,60	-21,42
633960000	+24,81	-21,21
705440000	+25,04	-20,98
834160000	+26,98	-19,04

23104609\_2



Panozzo 23104610

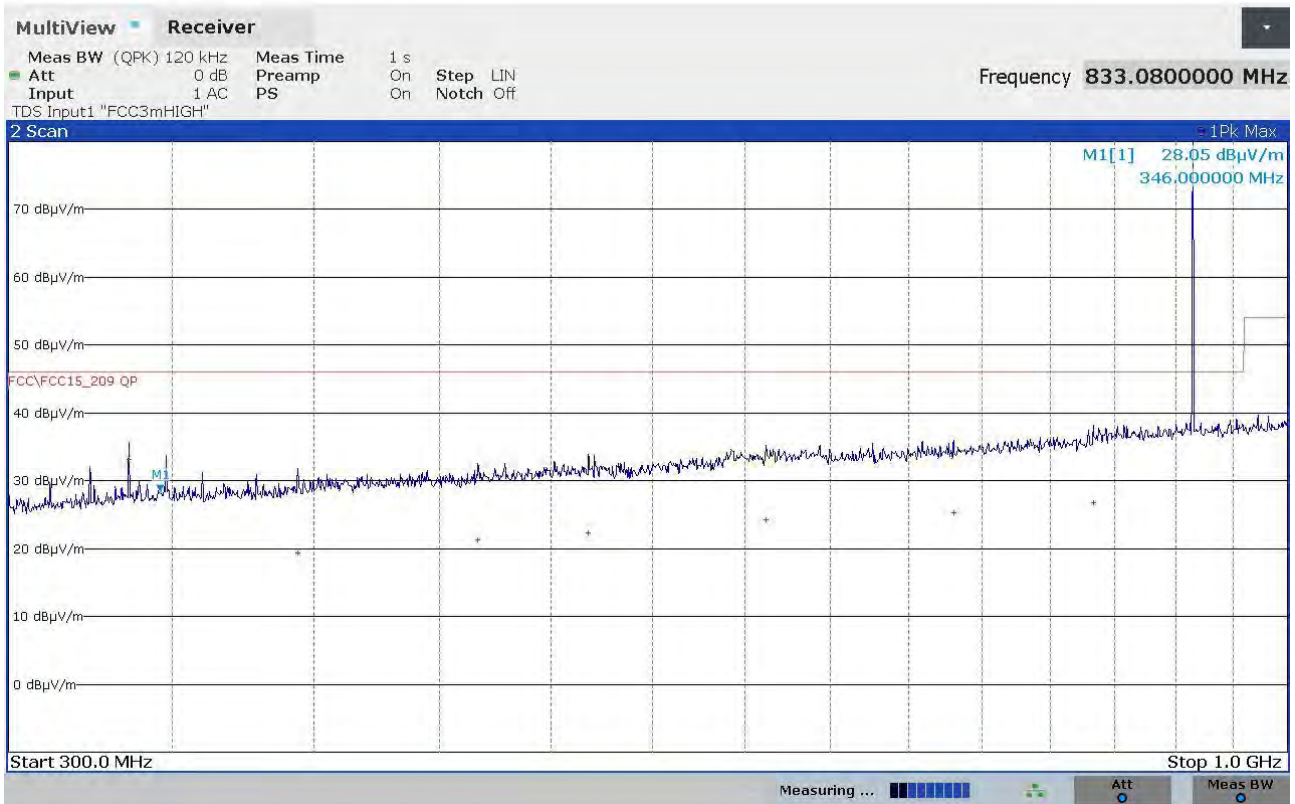

### FINAL RESULT TABLE

QUASI PEAK		
Freq Hz	Lev dBuV/m	Margin dB
336000000	+33,16	-12,86
393880000	+19,35	-26,67
466760000	+21,28	-24,74
517920000	+22,38	-23,64
612160000	+24,25	-21,77
730200000	+25,23	-20,79
833080000	+26,77	-19,25

23104610\_2

Panozzo 23104611

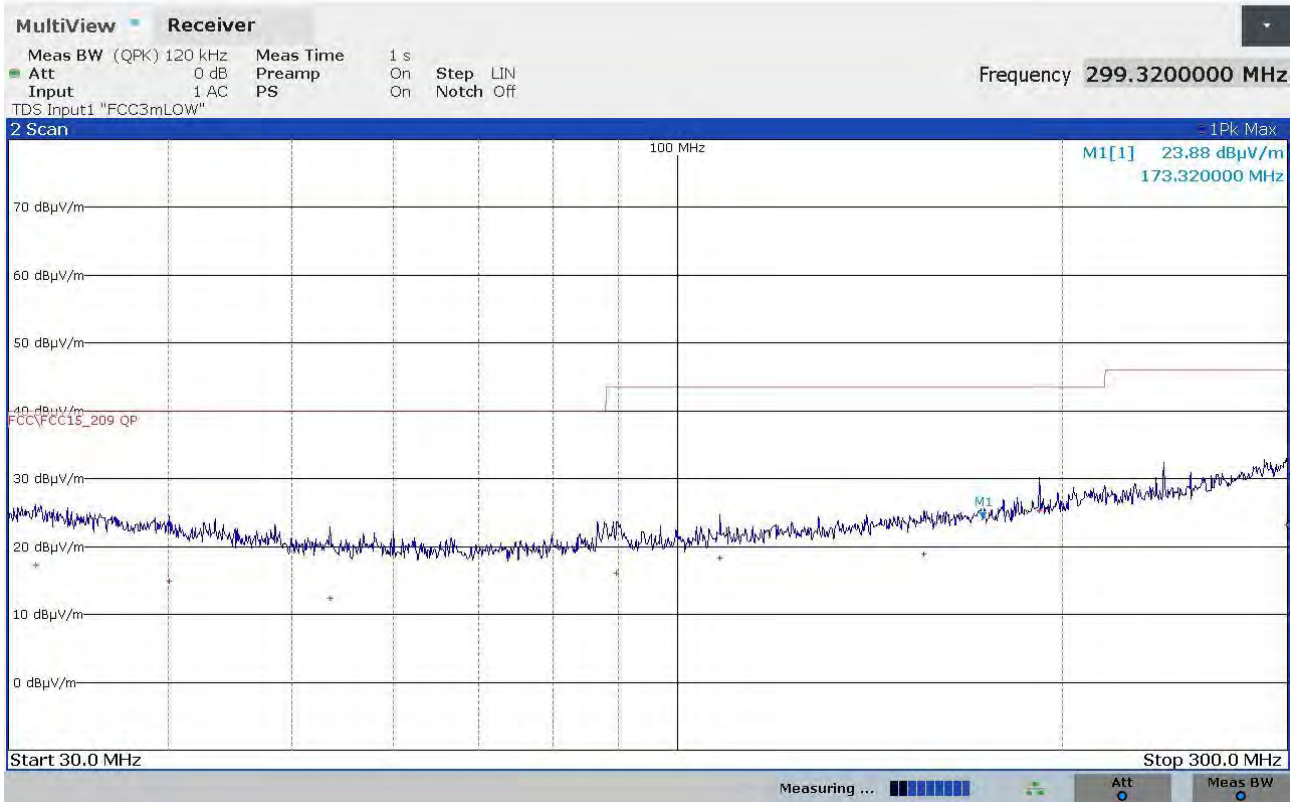

**FINAL RESULT TABLE**

QUASI PEAK		
Freq Hz	Lev dBuV/m	Margin dB
31480000	+17,35	-22,65
40080000	+14,96	-25,04
53520000	+12,37	-27,63
89680000	+16,11	-27,41
107960000	+18,32	-25,20
156000000	+18,92	-24,60
192000000	+25,22	-18,30
299320000	+23,16	-22,86

23104611\_2

Panozzo 23104612

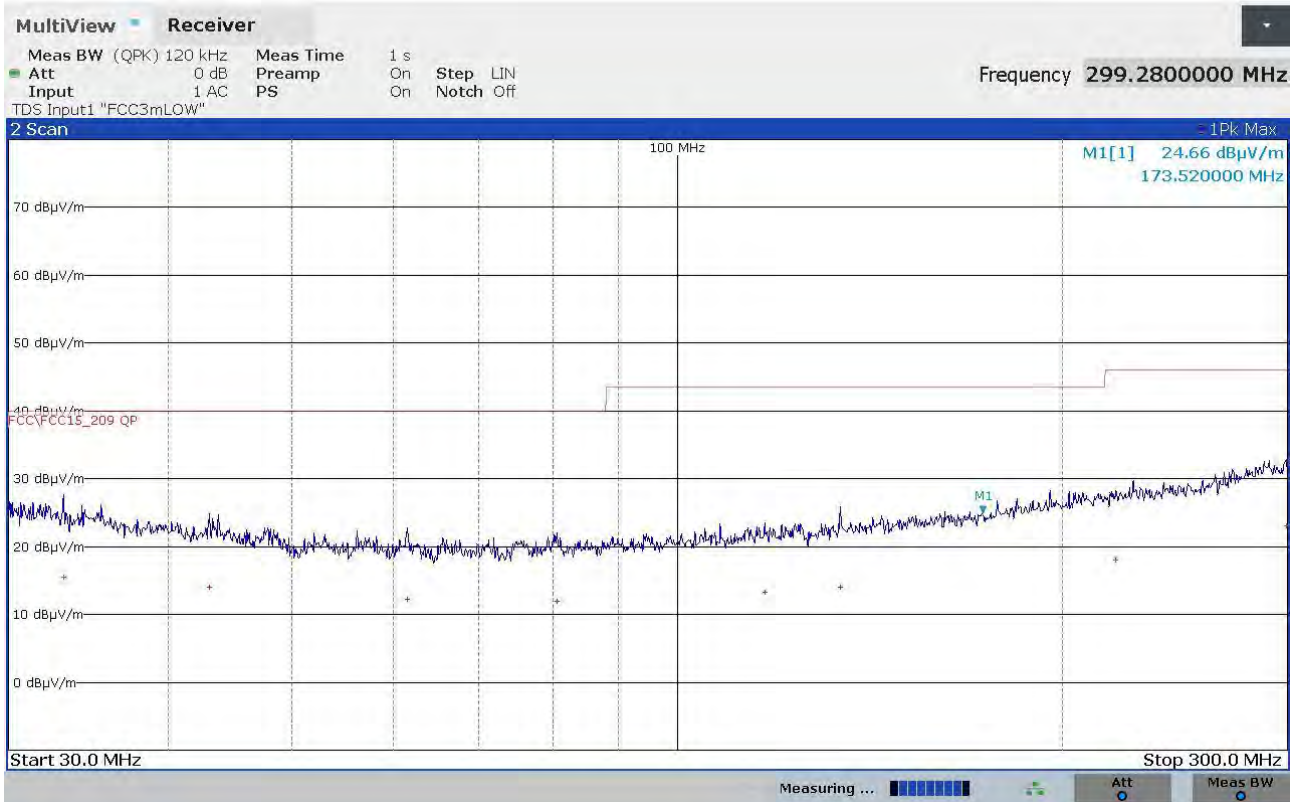

**FINAL RESULT TABLE**

QUASI PEAK		
Freq Hz	Lev dBuV/m	Margin dB
33120000	+15,49	-24,51
43080000	+14,00	-26,00
61520000	+12,18	-27,82
80520000	+11,92	-28,08
117080000	+13,23	-30,29
134080000	+13,95	-29,57
220360000	+17,95	-28,07
299280000	+23,06	-22,96

23104612\_2

Panozzo 23104613

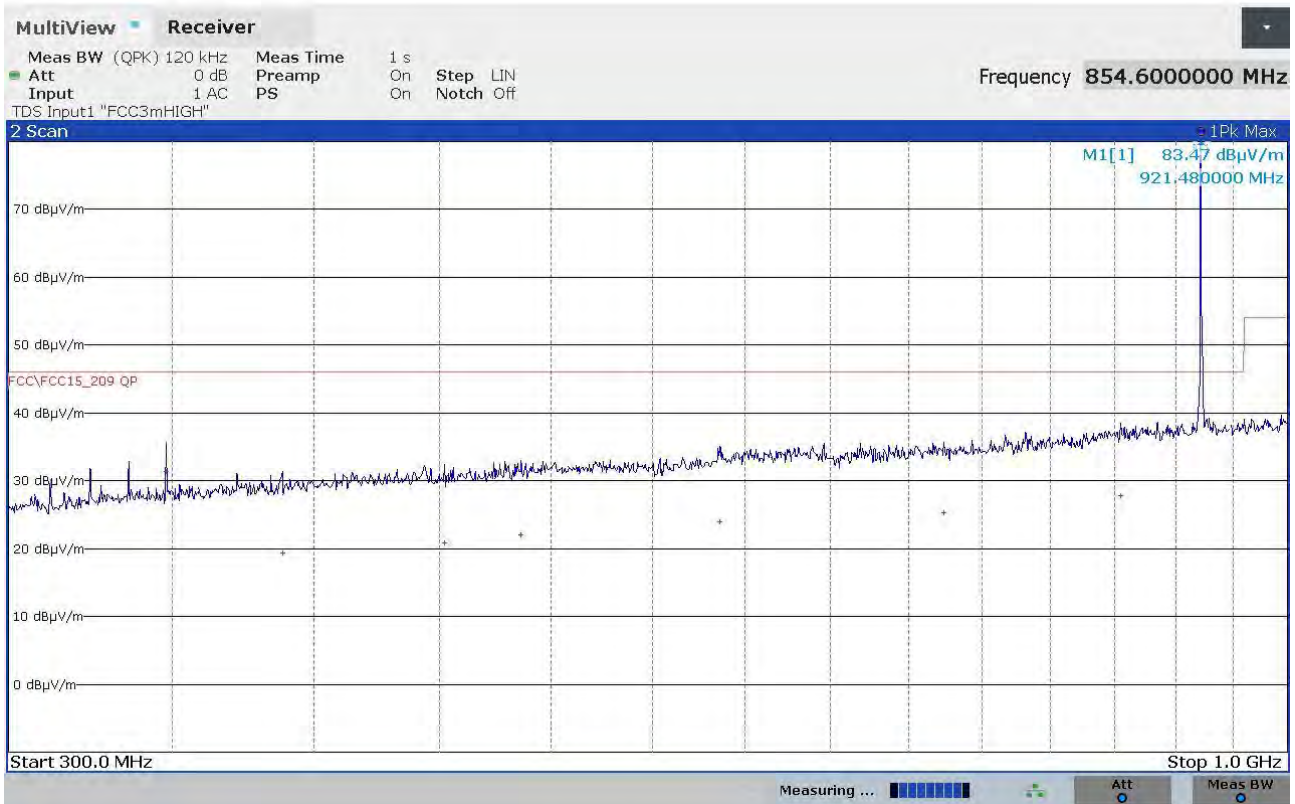

### FINAL RESULT TABLE

QUASI PEAK		
Freq Hz	Lev dBuV/m	Margin dB
348000000	+31,44	-14,58
388240000	+19,30	-26,72
452320000	+20,82	-25,20
486080000	+22,04	-23,98
586280000	+23,96	-22,06
723640000	+25,36	-20,66
854600000	+27,77	-18,25

23104613\_2

Panozzo 23104614

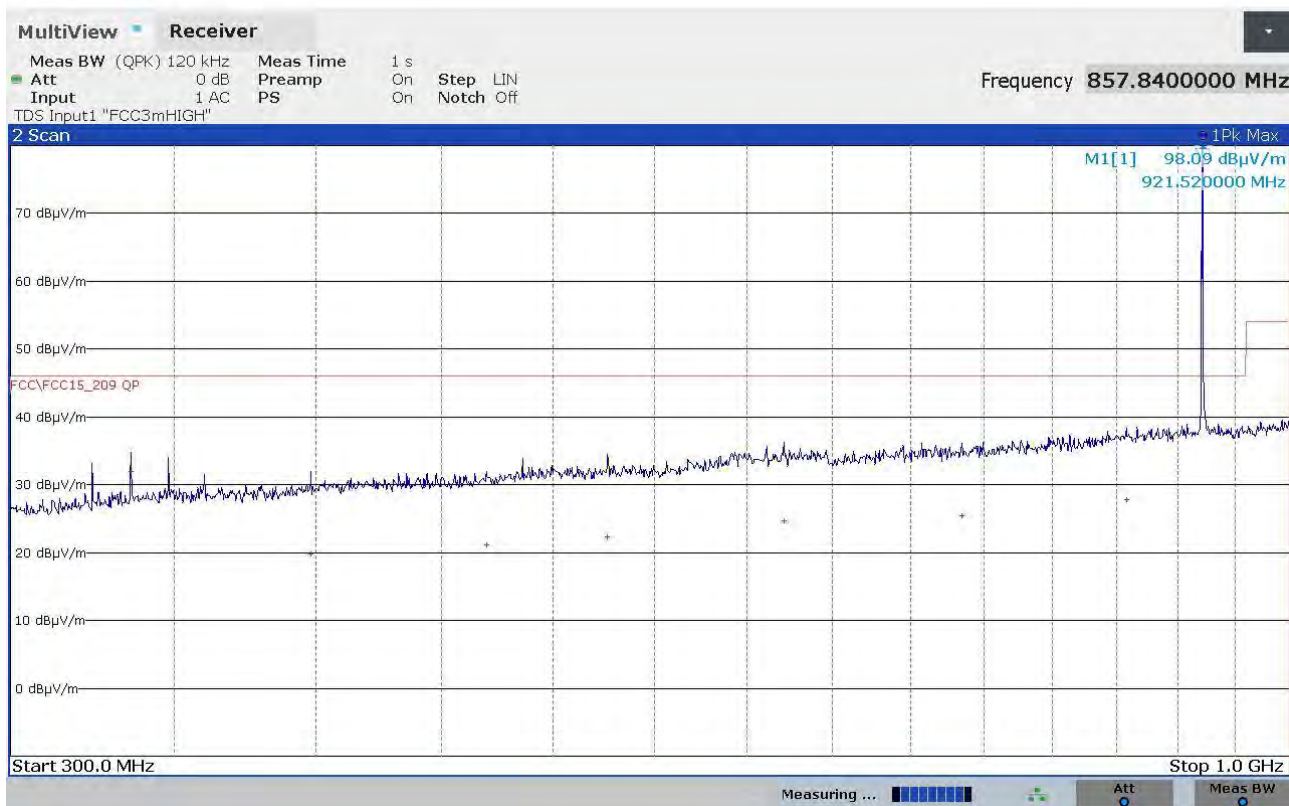

### FINAL RESULT TABLE

QUASI PEAK		
Freq Hz	Lev dBuV/m	Margin dB
336000000	+31,96	-14,06
398160000	+19,74	-26,28
469640000	+21,21	-24,81
526200000	+22,32	-23,70
621280000	+24,66	-21,36
734720000	+25,39	-20,63
857840000	+27,86	-18,16

23104614\_2

Panozzo 23104615

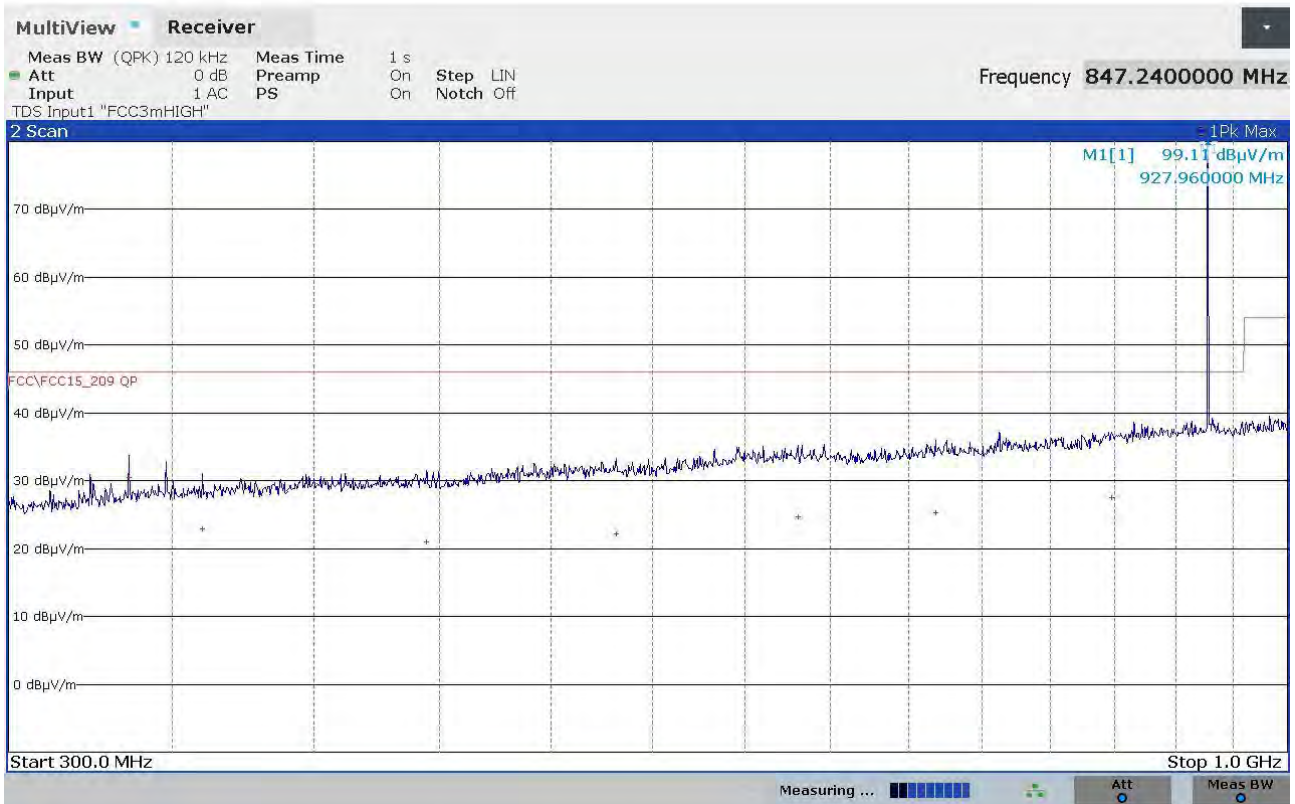

### FINAL RESULT TABLE

QUASI PEAK		
Freq Hz	Lev dBuV/m	Margin dB
336000000	+30,54	-15,48
360040000	+22,99	-23,03
444800000	+20,98	-25,04
531480000	+22,19	-23,83
630800000	+24,66	-21,36
718200000	+25,24	-20,78
847240000	+27,53	-18,49

23104615\_2

Panozzo 23104616

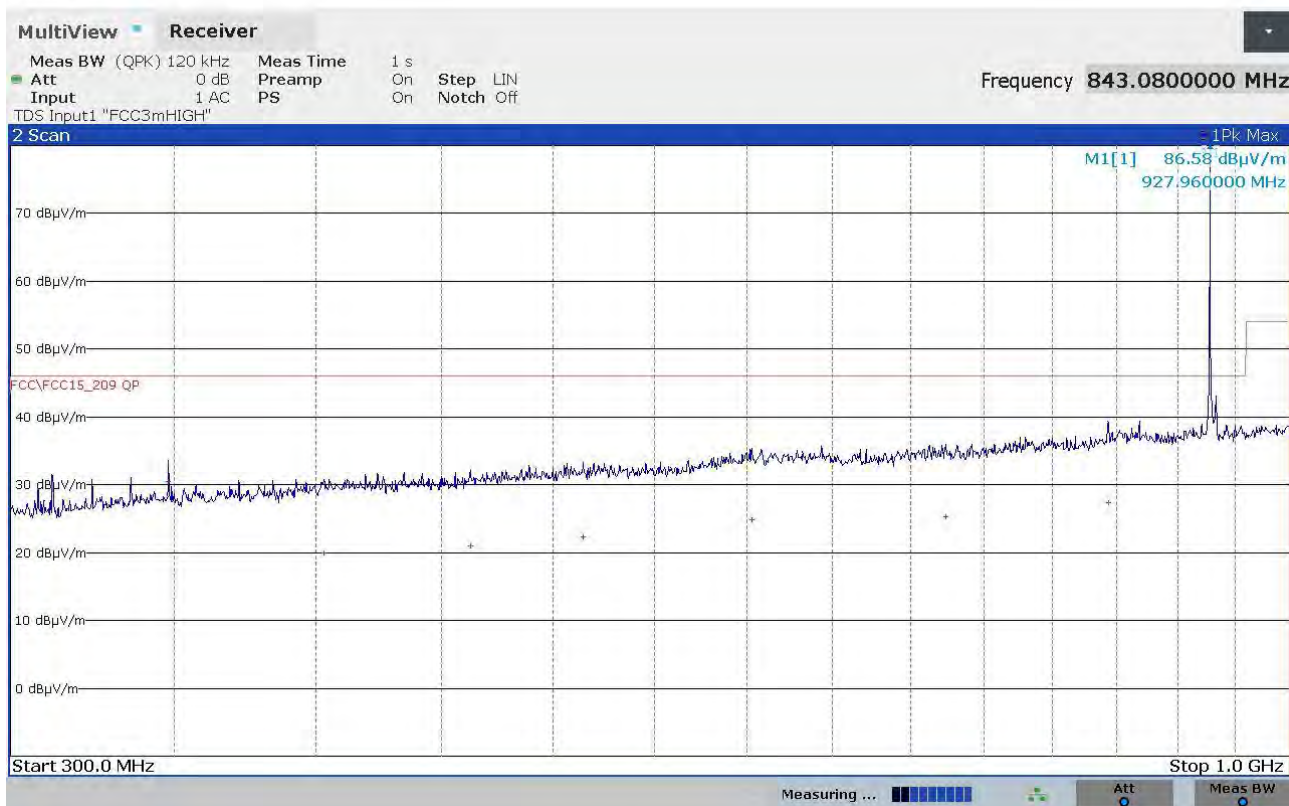

### FINAL RESULT TABLE

QUASI PEAK		
Freq Hz	Lev dBuV/m	Margin dB
348000000	+30,51	-15,51
403080000	+19,98	-26,04
462600000	+20,99	-25,03
514120000	+22,34	-23,68
602720000	+24,77	-21,25
723680000	+25,26	-20,76
843080000	+27,32	-18,70

23104616\_2

Panozzo 23104617

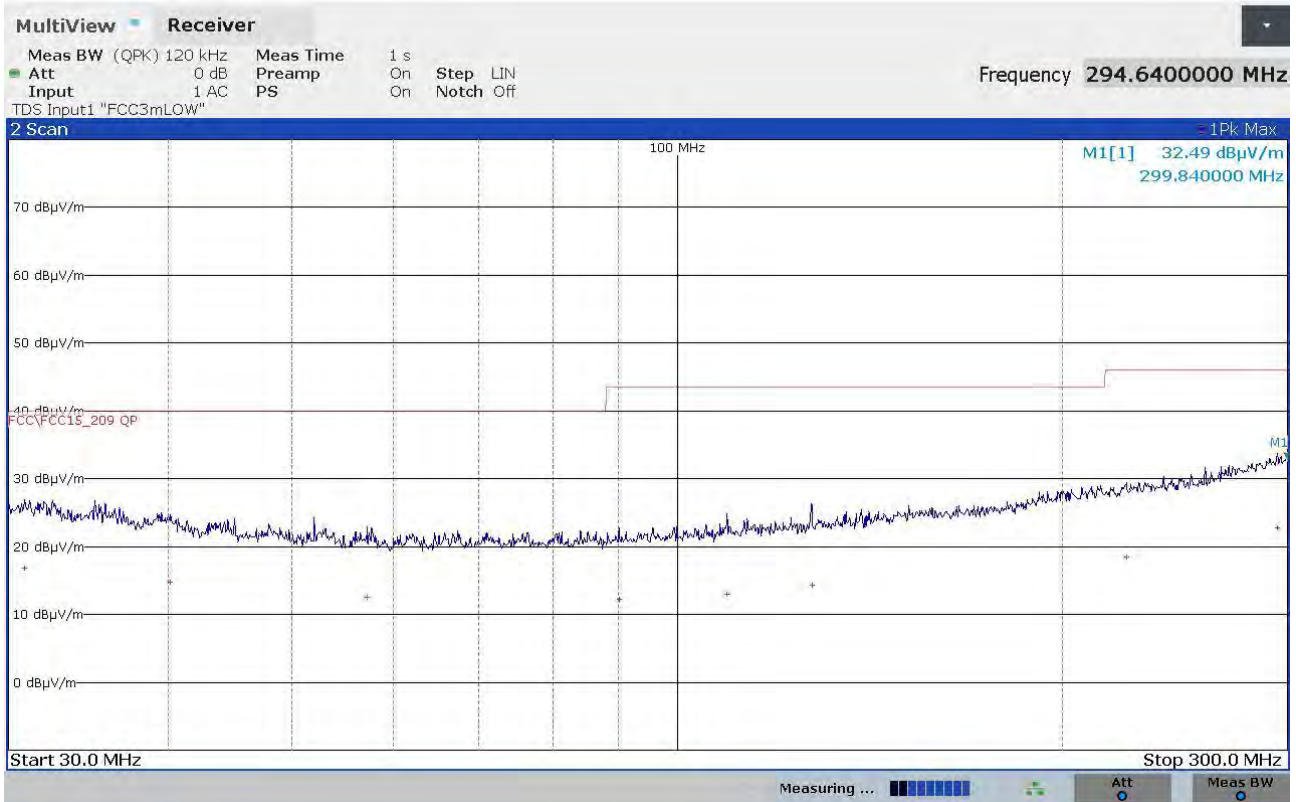

**FINAL RESULT TABLE**

QUASI PEAK		
Freq Hz	Lev dBuV/m	Margin dB
30880000	+16,89	-23,11
40160000	+14,77	-25,23
57200000	+12,54	-27,46
90040000	+12,19	-31,33
109400000	+12,96	-30,56
127400000	+14,32	-29,20
224520000	+18,48	-27,54
294640000	+22,80	-23,22

23104617\_2



Panozzo 23104618

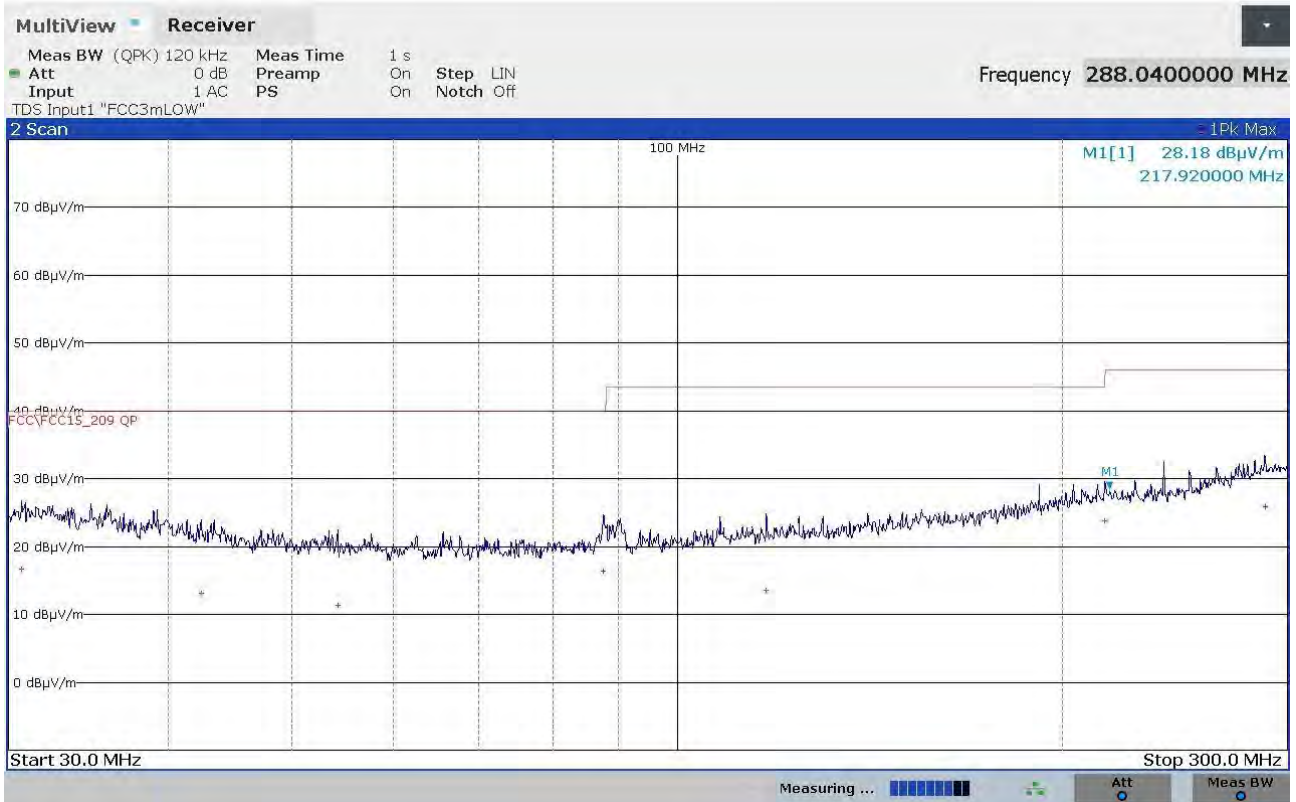

**FINAL RESULT TABLE**

QUASI PEAK		
Freq Hz	Lev dBuV/m	Margin dB
30720000	+16,66	-23,34
42440000	+13,15	-26,85
54280000	+11,31	-28,69
87600000	+16,44	-23,56
117400000	+13,57	-29,95
216000000	+23,85	-22,17
288040000	+25,82	-20,20

23104618\_2

Panozzo 23104619

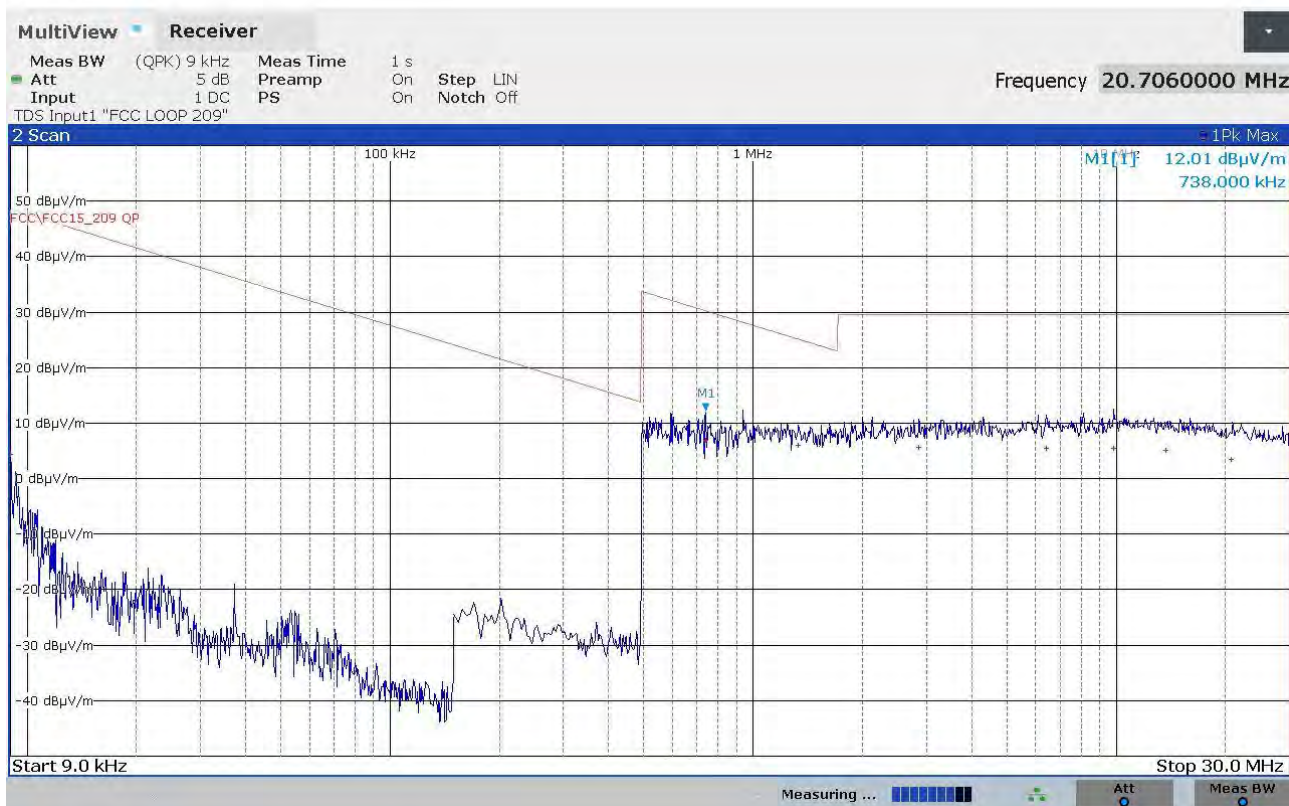

FINAL RESULT TABLE

QUASI PEAK		
Freq Hz	Lev dBuV/m	Margin dB
9000	+4,33	-44,19
518000	+7,76	-25,56
738000	+6,87	-23,37
1330000	+5,97	-19,16
2866000	+5,57	-23,97
6422000	+5,41	-24,13
9834000	+5,47	-24,07
13678000	+5,12	-24,42
20706000	+3,44	-26,10

23104619\_2

**20 dB bandwidth**

Tested by .....	M. Segalla
Test date .....	22.06.2023
Test location (stand) .....	Laboratory
Reference standards.....	FCC Rules and Regulation; Titles 47 Part. 15.215 (c) ANSI C63.10 cl. 7.8.7
Supplementary test set-up description.....	--
Supplementary information .....	--

**Test setup**

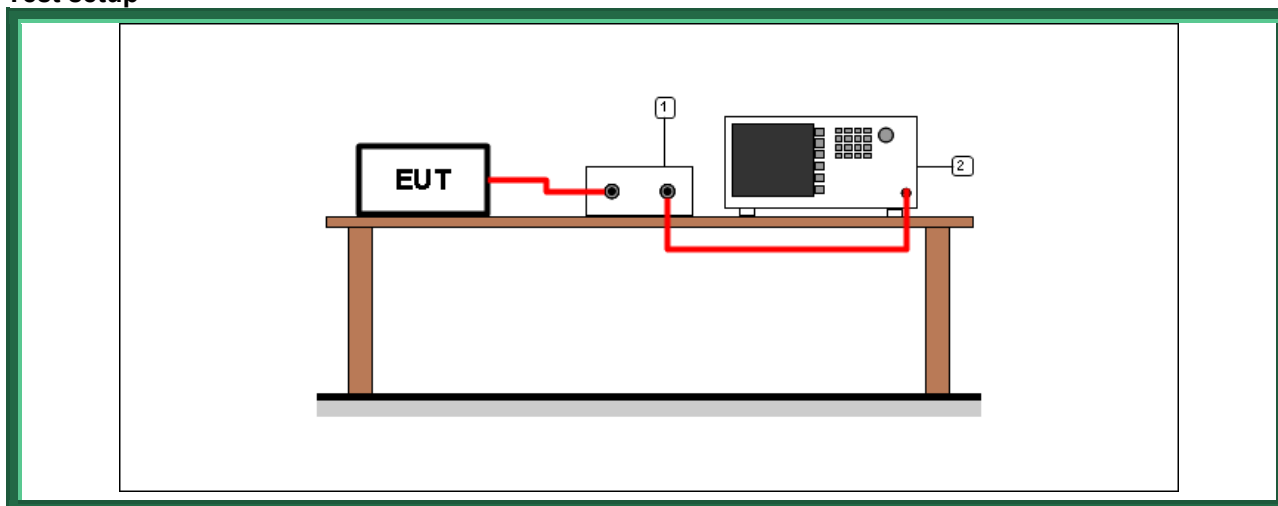

*Test setup PR002\_01*

Nr.	Id. Number	Manufacturer	Model	Serial number	Description	Last calibration date	Calibration expiration
2	CMC S295	Rohde & Schwarz	FSW43	104059	Spectrum Analyzer 43GHz	January 2023	January 2026
1	--	--	--	--	Cable + attenuator	Calibrated before the test	Calibrated before the test

**Result**

Frequency (MHz)	Graphs	20 dB bandwidth (kHz)
915,050	G23104620	22,328
921,500	G23104624	21,178
927,875	G23104632	22,927

## Graphs

Segalla 23104620



Segalla 23104624



Segalla 23104632



### Channel separation

Tested by .....	M. Segalla
Test date .....	18.10.2023
Test location (stand) .....	Laboratory
Reference standards.....	FCC Rules and Regulation; Titles 47 Part. 15.247 KDB 558074 D01 15.247 Meas Guidance v05r02 cl. 9 b) ANSI C63.10 cl. 7.8.2
Supplementary test set-up description.....	--
Supplementary information .....	--

### Acceptance limits

Frequency hopping systems shall have hopping channel carrier frequencies separated by a minimum of 25 kHz or the 20 dB bandwidth of the hopping channel, whichever is greater. Alternatively, frequency hopping systems operating in the 2400–2483.5 MHz band may have hopping channel carrier frequencies that are separated by 25 kHz or two-thirds of the 20 dB bandwidth of the hopping channel, whichever is greater, provided the systems operate with an output power no greater than 125 mW. The system shall hop to channel frequencies that are selected at the system hopping rate from a pseudo randomly ordered list of hopping frequencies. Each frequency must be used equally on the average by each transmitter. The system receivers shall have input bandwidths that match the hopping channel bandwidths of their corresponding transmitters and shall shift frequencies in synchronization with the transmitted signals.

### Test setup

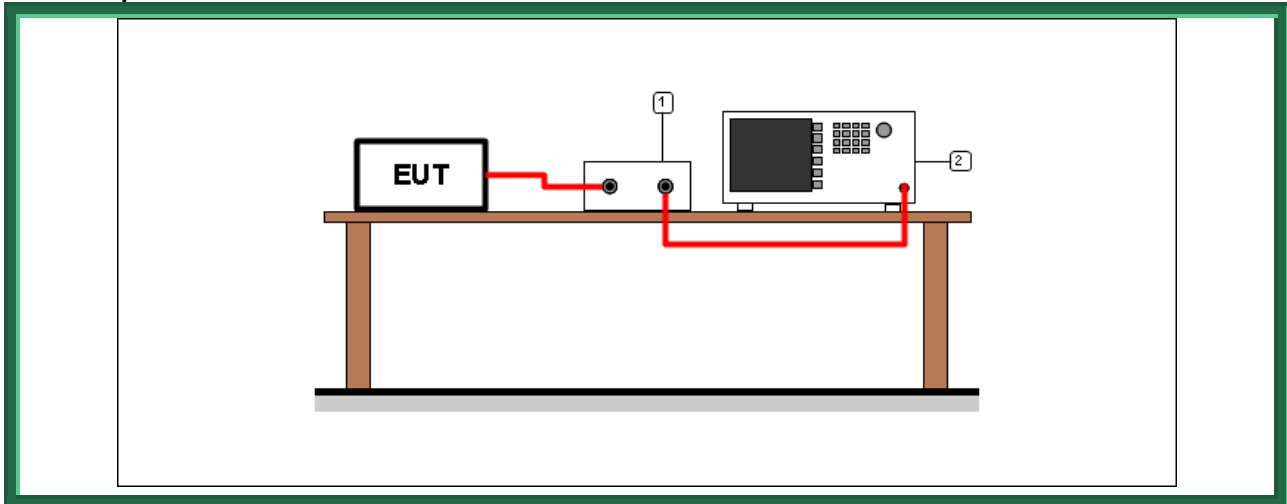

Test setup PR002\_01

Nr.	Id. Number	Manufacturer	Model	Serial number	Description	Last calibration date	Calibration expiration
2	CMC S295	Rohde & Schwarz	FSW43	104059	Spectrum Analyzer 43GHz	January 2023	January 2026
1	--	--	--	--	Cable + attenuator	Calibrated before the test	Calibrated before the test

**Result**

<i>Frequency band (MHz)</i>	<i>Graphs</i>	<i>Channel separation (kHz)</i>	<i>Minimum channel separation required (kHz)</i>	<i>Results</i>
902 – 928	G23104638	199,8	25	Complies

## Graphs

Segalla 23104638

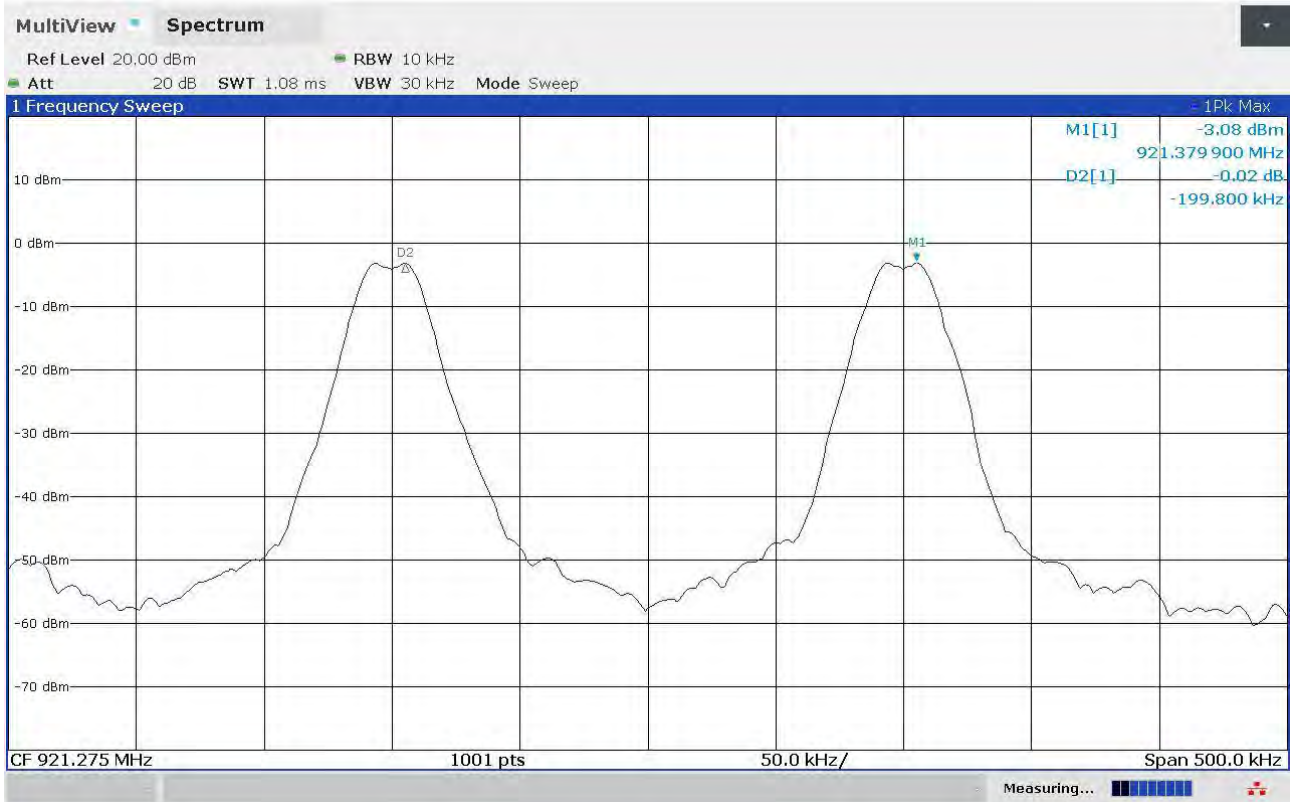



### Number of hopping channels

Tested by .....	M. Segalla
Test date .....	18.10.2023
Test location (stand) .....	Laboratory
Reference standards.....	FCC Rules and Regulation; Titles 47 Part. 15.247 KDB 558074 D01 15.247 Meas Guidance v05r02 cl. 9 b) ANSI C63.10 cl. 7.8.3
Supplementary test set-up description.....	--
Supplementary information .....	--

### Acceptance limits

For frequency hopping systems operating in the 902 – 928 MHz band: if the 20 dB bandwidth of the hopping channel is less than 250 kHz, the system shall use at least 50 hopping frequencies and the average time of occupancy on any frequency shall not be greater than 0,4 seconds within a 20 second period; if the 20 dB bandwidth of the hopping channel is 250 kHz or greater, the system shall use at least 25 hopping frequencies and the average time of occupancy on any frequency shall not be greater than 0,4 seconds within a 10 second period. The maximum allowed 20 dB bandwidth of the hopping channel is 500 kHz.

### Test setup

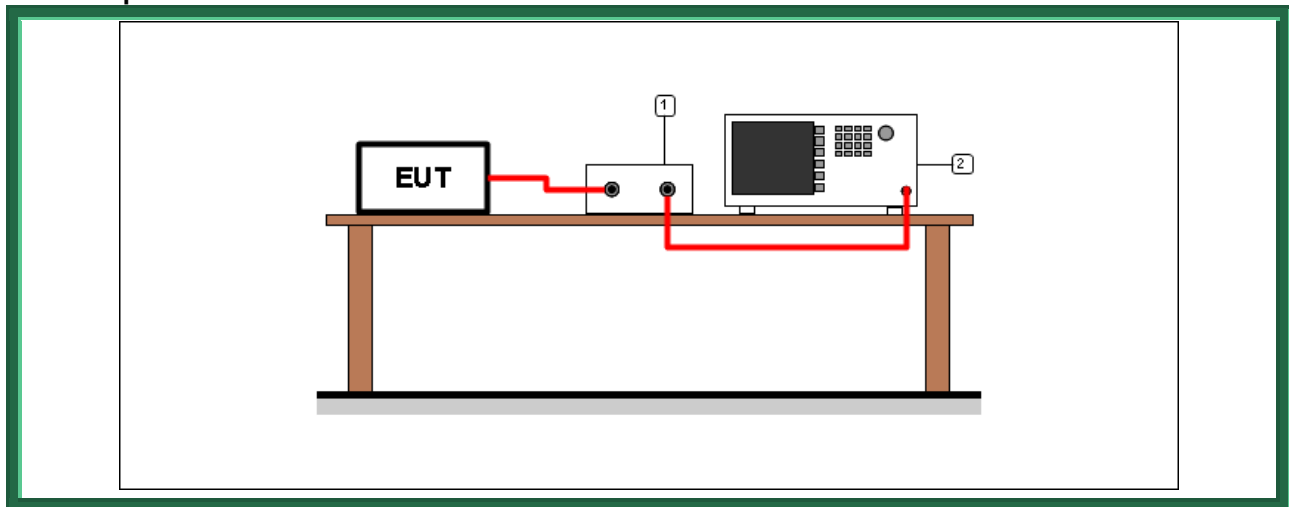

Test setup PR002\_01

Nr.	Id. Number	Manufacturer	Model	Serial number	Description	Last calibration date	Calibration expiration
2	CMC S295	Rohde & Schwarz	FSW43	104059	Spectrum Analyzer 43GHz	January 2023	January 2026
1	--	--	--	--	Cable + attenuator	Calibrated before the test	Calibrated before the test

**Result**

<i>Frequency band (MHz)</i>	<i>Graphs</i>	<i>Number of hopping channels</i>	<i>Minimum number of hopping channels required</i>	<i>Results</i>
902 – 928	G23104639 G23104640 G23104621	64	50	Complies

## Graphs

Segalla 23104639

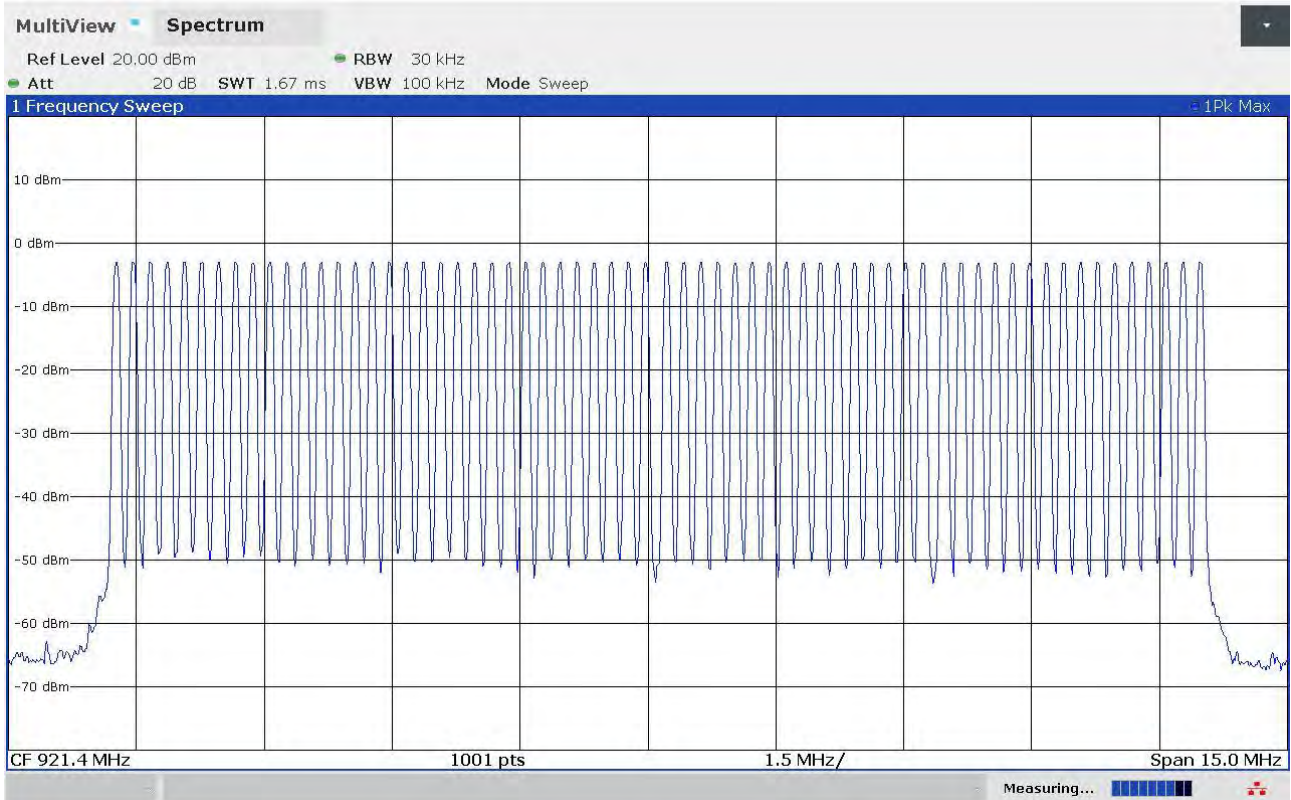

Segalla 23104640

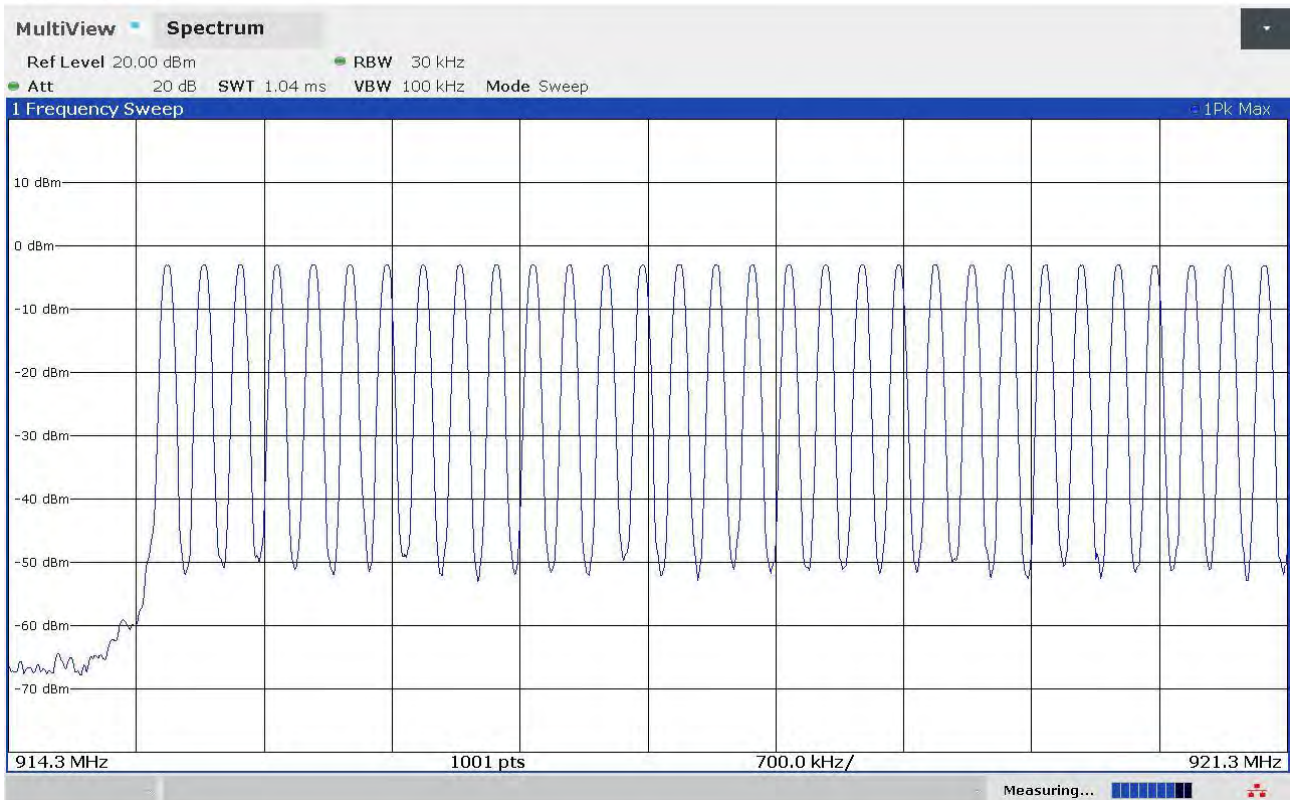

Segalla 23104641

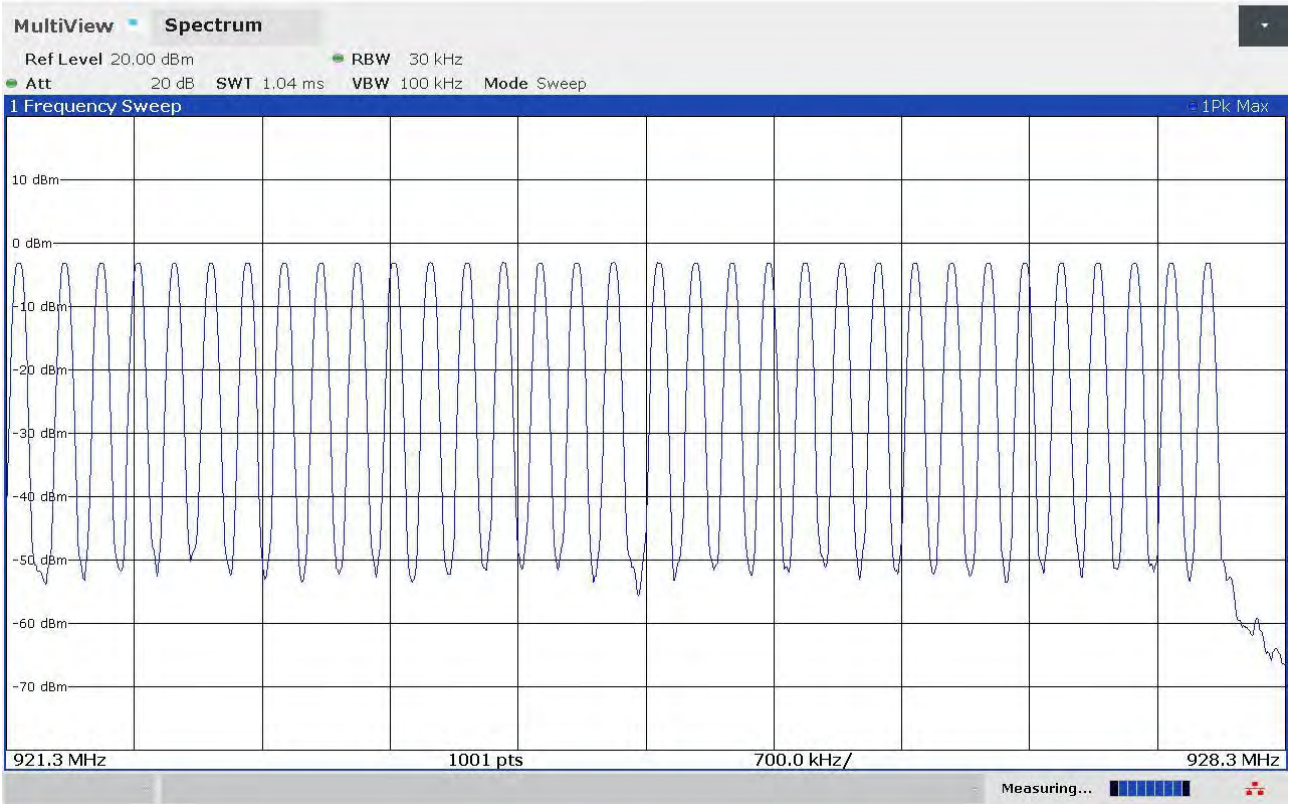

**Time of occupancy**

Tested by .....	M. Segalla
Test date .....	18.10.2023
Test location (stand) .....	Laboratory
Reference standards.....	FCC Rules and Regulation; Titles 47 Part. 15.247 KDB 558074 D01 15.247 Meas Guidance v05r02 cl. 9 b) ANSI C63.10 cl. 7.8.4
Supplementary test set-up description.....	--
Supplementary information .....	--

**Acceptance limits**

For frequency hopping systems operating in the 902 – 928 MHz band: if the 20 dB bandwidth of the hopping channel is less than 250 kHz, the system shall use at least 50 hopping frequencies and the average time of occupancy on any frequency shall not be greater than 0,4 seconds within a 20 second period; if the 20 dB bandwidth of the hopping channel is 250 kHz or greater, the system shall use at least 25 hopping frequencies and the average time of occupancy on any frequency shall not be greater than 0,4 seconds within a 10 second period. The maximum allowed 20 dB bandwidth of the hopping channel is 500 kHz.

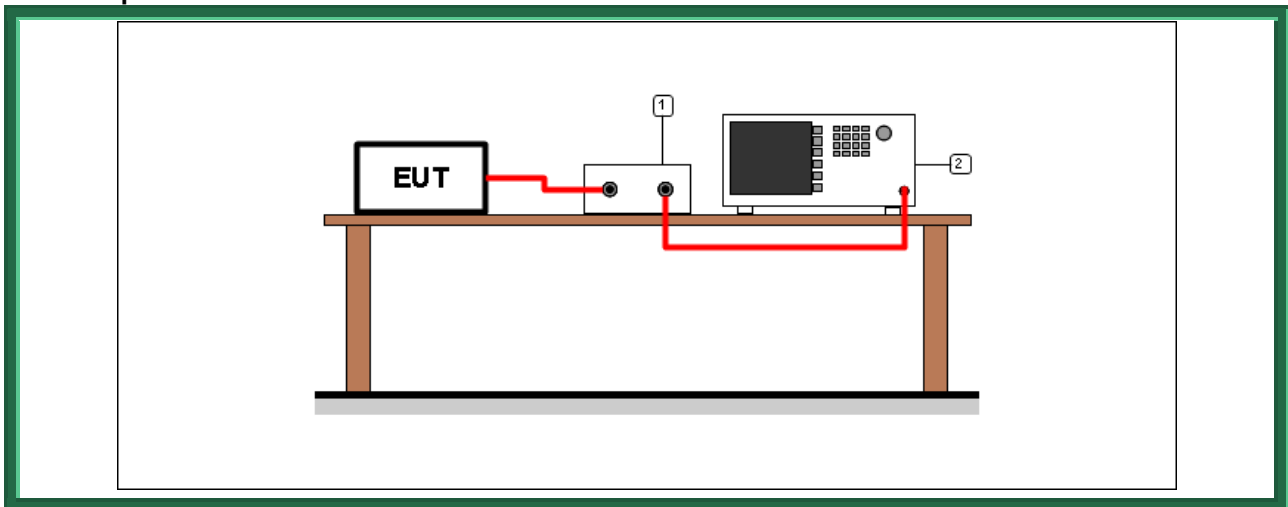
**Test setup**

Test setup PR002\_01

Nr.	Id. Number	Manufacturer	Model	Serial number	Description	Last calibration date	Calibration expiration
2	CMC S295	Rohde & Schwarz	FSW43	104059	Spectrum Analyzer 43GHz	January 2023	January 2026
1	--	--	--	--	Cable + attenuator	Calibrated before the test	Calibrated before the test

**Result**

<i>Frequency (MHz)</i>	<i>Graphs</i>	<i>Dwell time (ms)</i>
921,375	G23104642	21,10

<i>Frequency (MHz)</i>	<i>Graphs</i>	<i>Number of transmissions</i>	<i>Period</i>
921,375	G23104643	7	20 s

**Remarks:** only the highest peaks have been considered. The lowest peaks are due to the auxiliary receiver unit.

<i>Time of occupancy (Dwell time x Nr. transmissions)</i>	<i>Maximum allowed time of occupancy</i>	<i>Results</i>
147,70 ms	400 ms	Complies

## Graphs

Segalla 23104642

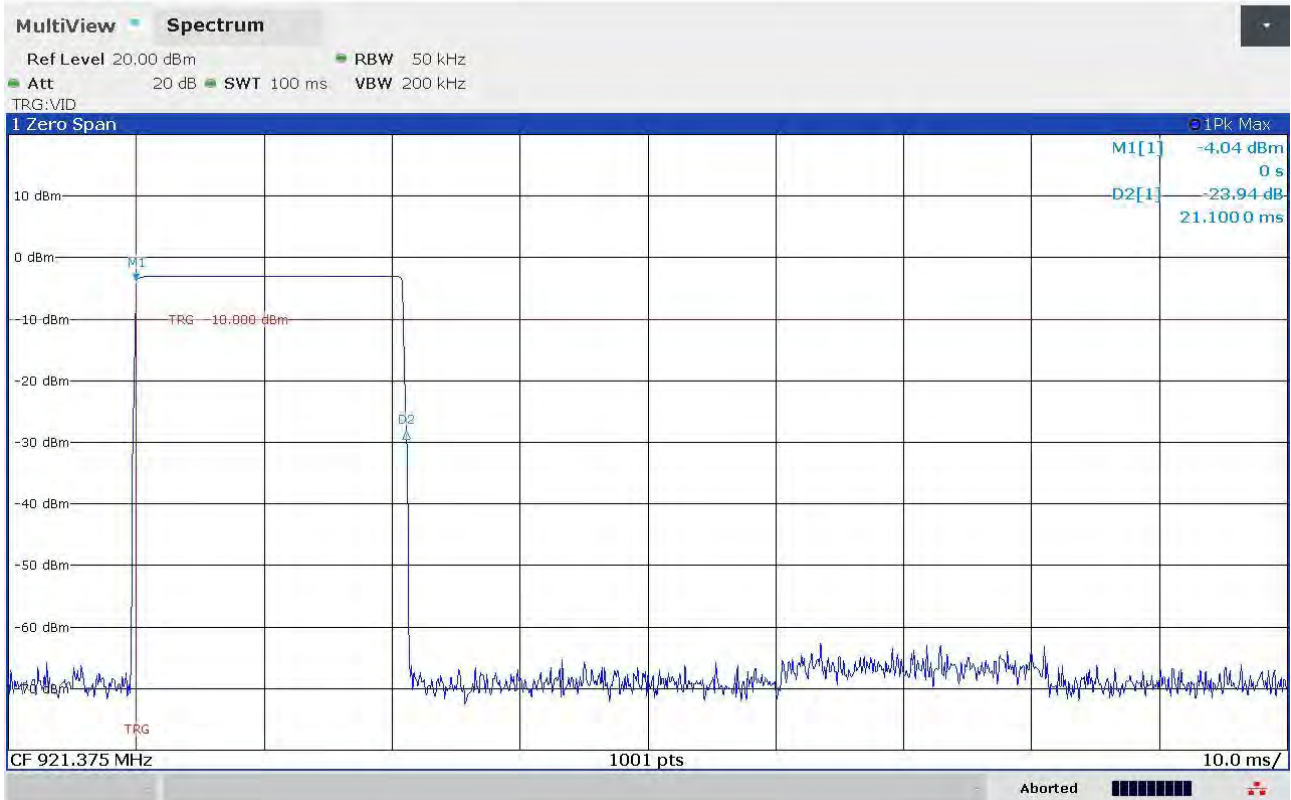

Segalla 23104643

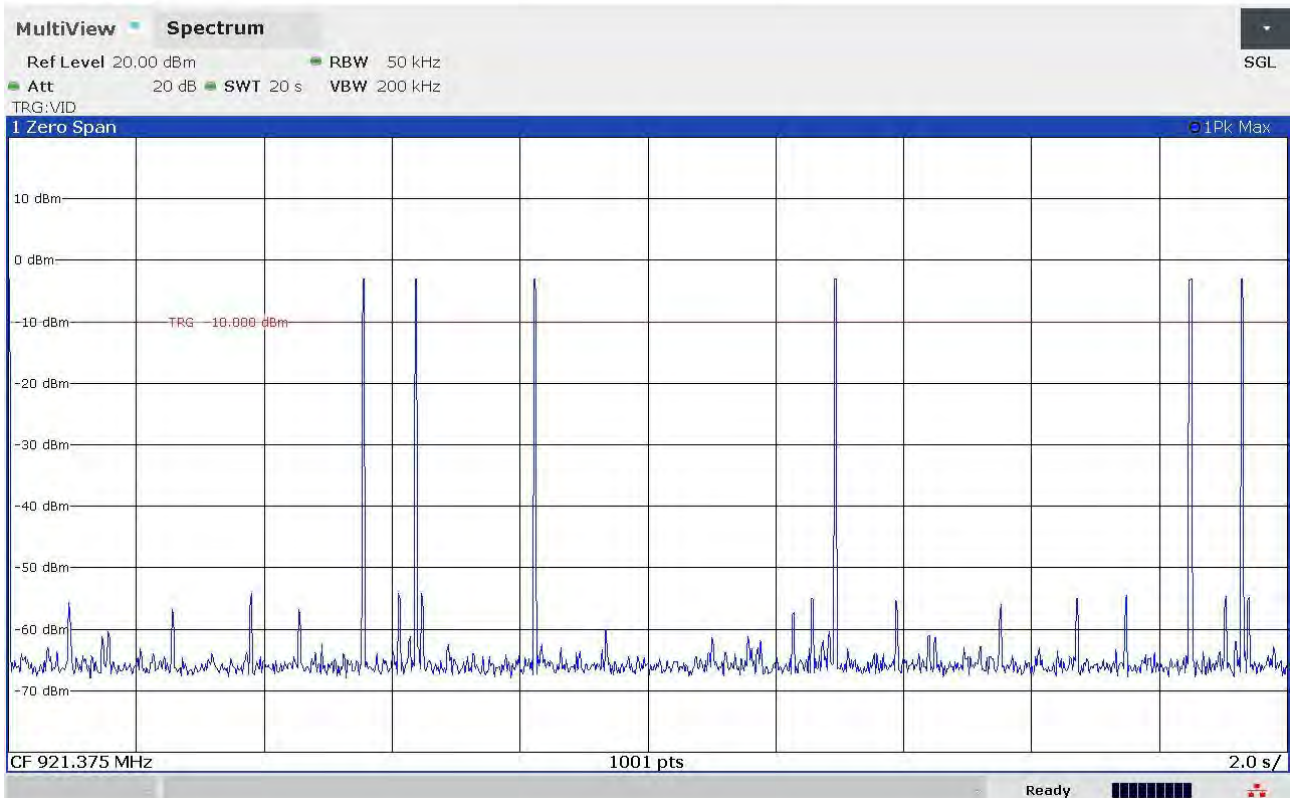

**Band edge**

Tested by .....	M. Segalla
Test date .....	18.10.2023
Test location (stand) .....	Laboratory
Reference standards.....	FCC Rules and Regulation; Titles 47 Part. 15.247 ANSI C63.10 cl. 7.8.6
Supplementary test set-up description.....	--
Supplementary information .....	--

**Acceptance limits**

In any 100 kHz bandwidth outside the frequency band in which the spread spectrum or digitally modulated intentional radiator is operating, the radio frequency power that is produced by the intentional radiator shall be at least 20 dB below that in the 100 kHz bandwidth within the band that contains the highest level of the desired power, based on either an RF conducted or a radiated measurement, provided the transmitter demonstrates compliance with the peak conducted power limits. If the transmitter complies with the conducted power limits based on the use of RMS averaging over a time interval, as permitted under paragraph (b)(3) of this section, the attenuation required under this paragraph shall be 30 dB instead of 20 dB. Attenuation below the general limits specified in § 15.209(a) is not required. In addition, radiated emissions which fall in the restricted bands, as defined in §15.205(a), must also comply with the radiated emission limits specified in § 15.209(a) (see § 15.205(c)).

Operation within the band 902 – 928 MHz ± RBW/2

**Test setup**

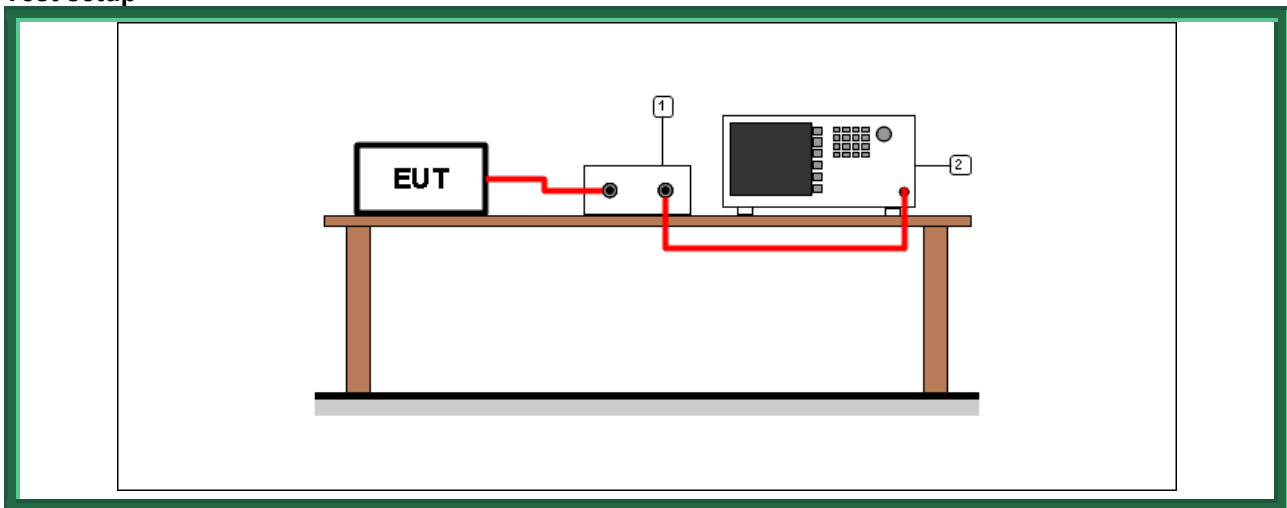

Test setup PR002_01							
Nr.	Id. Number	Manufacturer	Model	Serial number	Description	Last calibration date	Calibration expiration
2	CMC S295	Rohde & Schwarz	FSW43	104059	Spectrum Analyzer 43GHz	January 2023	January 2026
1	--	--	--	--	Cable + attenuator	Calibrated before the test	Calibrated before the test



**Result**

<i>Frequency (MHz)</i>	<i>Bandwidth</i>	<i>Graph(s) – Hopping</i>	<i>Absolute power (dBm)</i>	<i>Power limit (dBm)</i>	<i>Frequency</i>	<i>Results</i>
915,050	100 kHz	G23104637	-26,10	-23,11	F <sub>L</sub> : 914,917 MHz	Complies
927,875	100 kHz	G23104636	-23,26	-23,05	F <sub>H</sub> : 928,013 MHz	Complies

<i>Frequency (MHz)</i>	<i>Bandwidth</i>	<i>Graph(s) – No hopping</i>	<i>Absolute power (dBm)</i>	<i>Power limit (dBm)</i>	<i>Frequency</i>	<i>Results</i>
915,050	100 kHz	G23104623	-26,80	-22,88	F <sub>L</sub> : 914,887 MHz	Complies
927,875	100 kHz	G23104635	-23,75	-23,08	F <sub>H</sub> : 928,014 MHz	Complies

## Graphs

Segalla 23104623

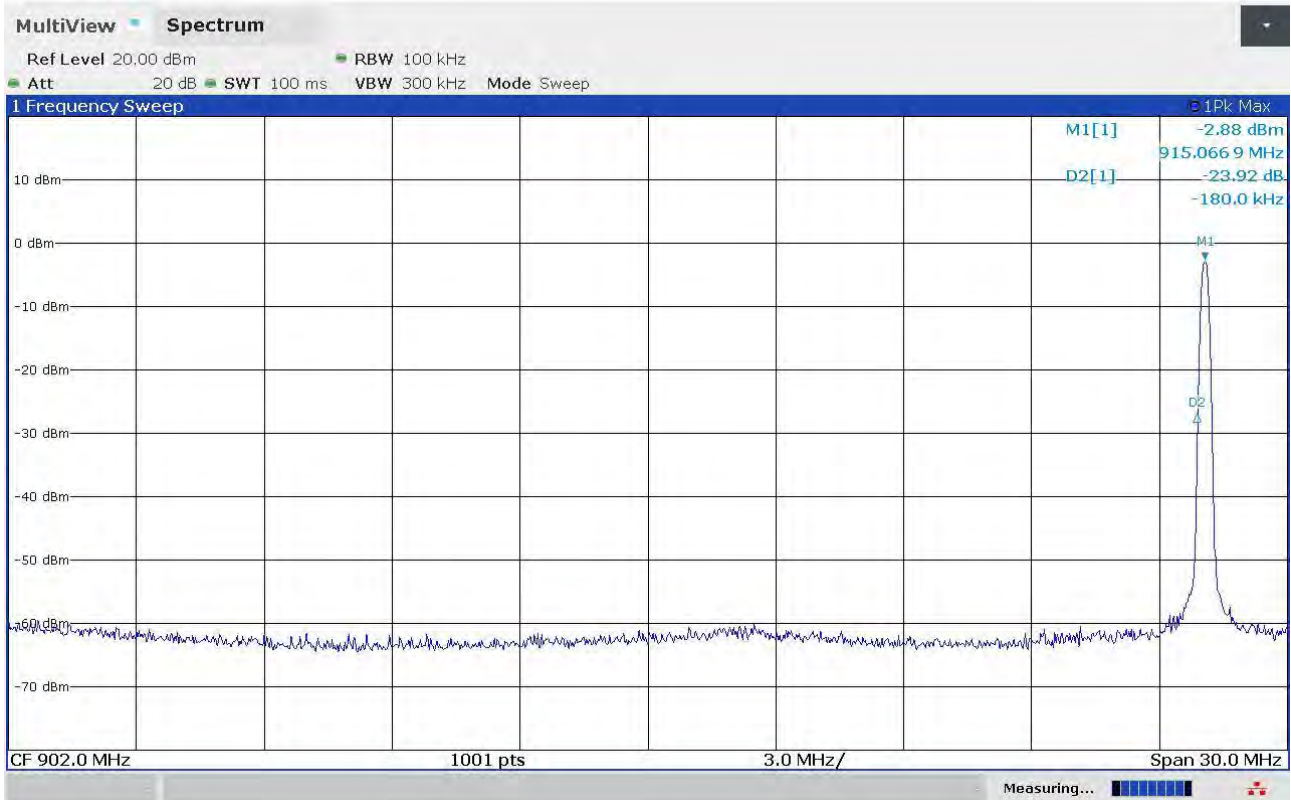

Segalla 23104635

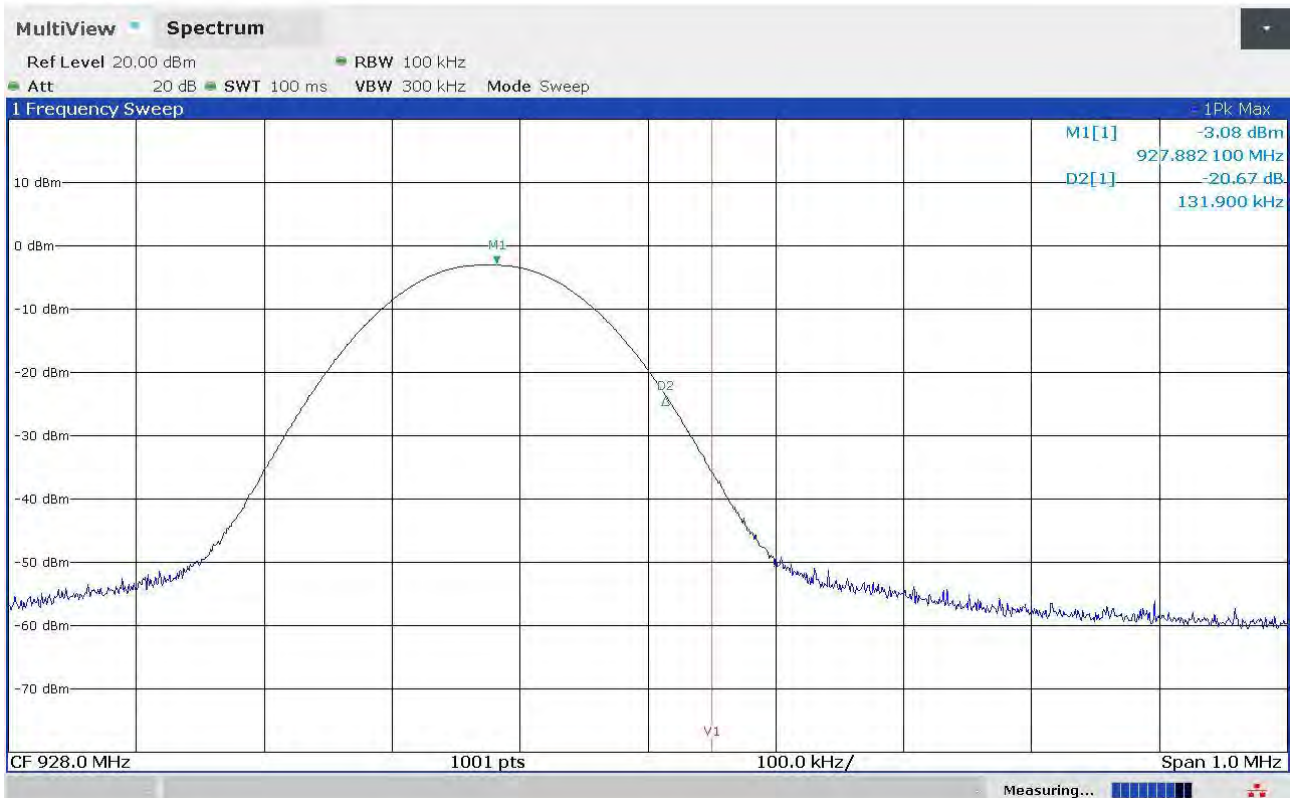

Segalla 23104636

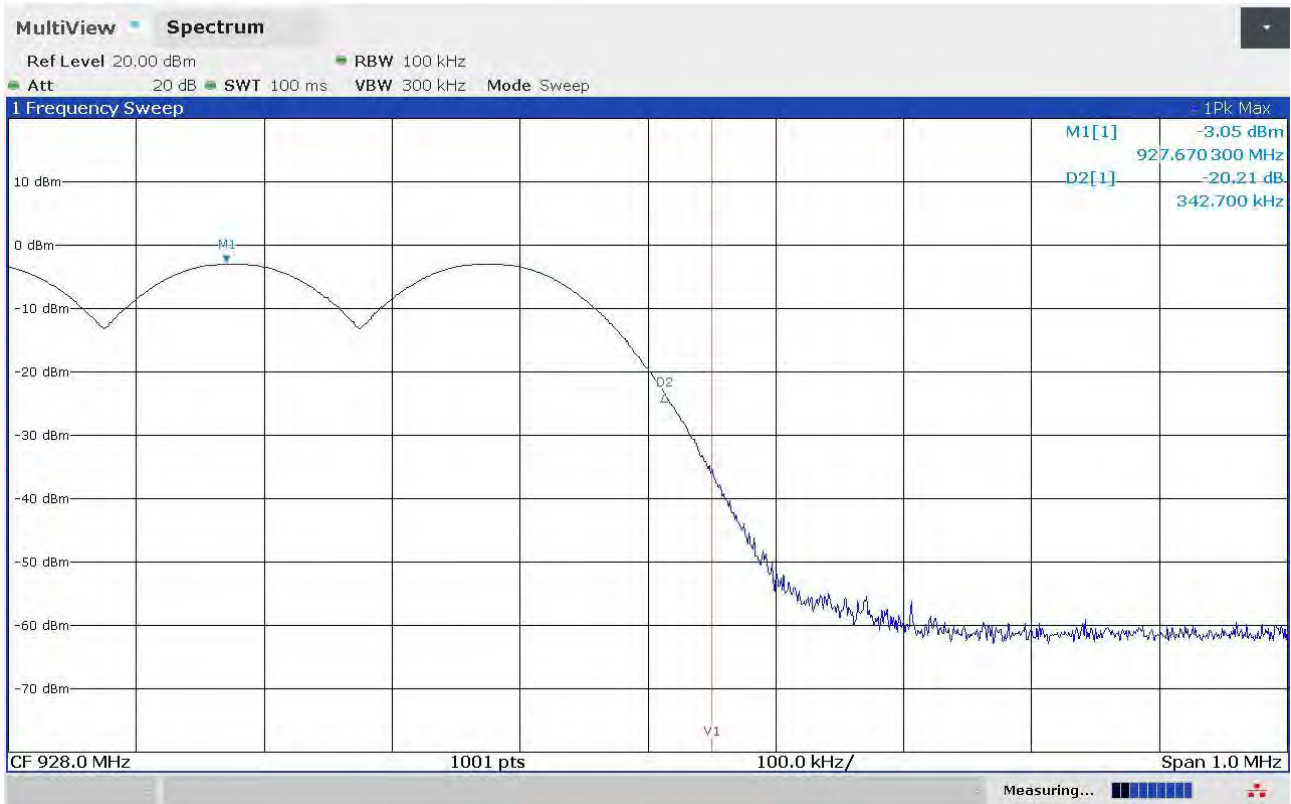

Segalla 23104637

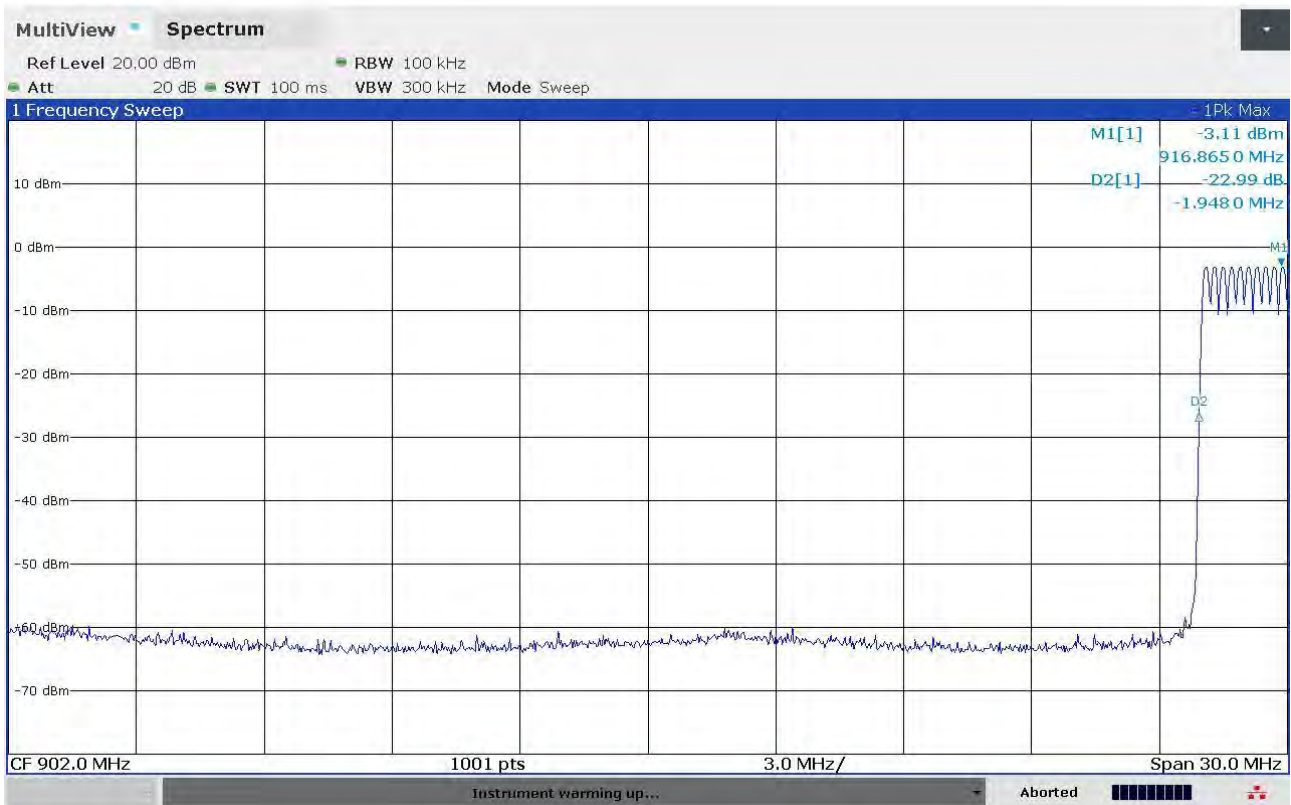

### Peak Output Power

Tested by .....	M. Segalla
Test date .....	18.10.2023
Test location (stand) .....	Laboratory
Reference standards.....	FCC Rules and Regulation; Titles 47 Part. 15.247 KDB 558074 D01 15.247 Meas Guidance v05r02 cl. 2.2 ANSI C63.10 cl. 7.8.5
Supplementary test set-up description.....	--
Supplementary information .....	--

### Acceptance limits

For frequency hopping systems operating in the 2400–2483,5 MHz band employing at least 75 non-overlapping hopping channels, and all frequency hopping systems in the 5725–5850 MHz band: 1 watt. For all other frequency hopping systems in the 2400–2483,5 MHz band: 0,125 watts.

For frequency hopping systems operating in the 902–928 MHz band: 1 watt for systems employing at least 50 hopping channels; and 0,25 watts for systems employing less than 50 hopping channels, but at least 25 hopping channels.

### Test setup

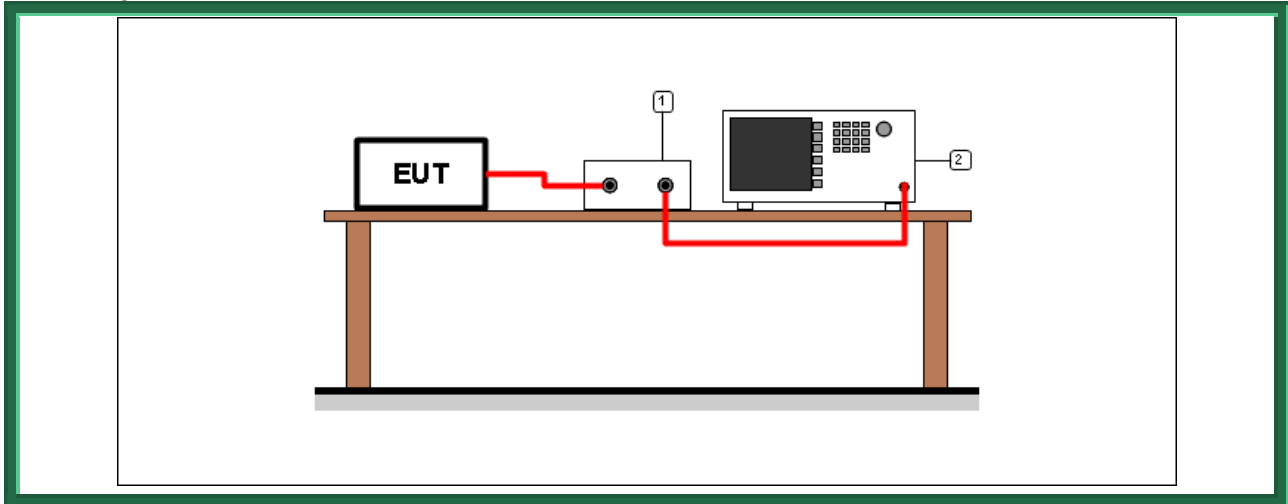

Test setup PR002\_01

Nr.	Id. Number	Manufacturer	Model	Serial number	Description	Last calibration date	Calibration expiration
2	CMC S295	Rohde & Schwarz	FSW43	104059	Spectrum Analyzer 43GHz	January 2023	January 2026
1	--	--	--	--	Cable + attenuator	Calibrated before the test	Calibrated before the test

**Result**

<i>Frequency (MHz)</i>	<i>Graphs</i>	<i>Peak Output Power (dBm)</i>	<i>Peak Output Power (mW)</i>	<i>Limit (mW)</i>
915,050	G23104622	17,33	54,08	1000
921,500	G23104626	17,25	53,09	1000
927,875	G23104634	17,15	51,88	1000

## Graphs

Segalla 23104622

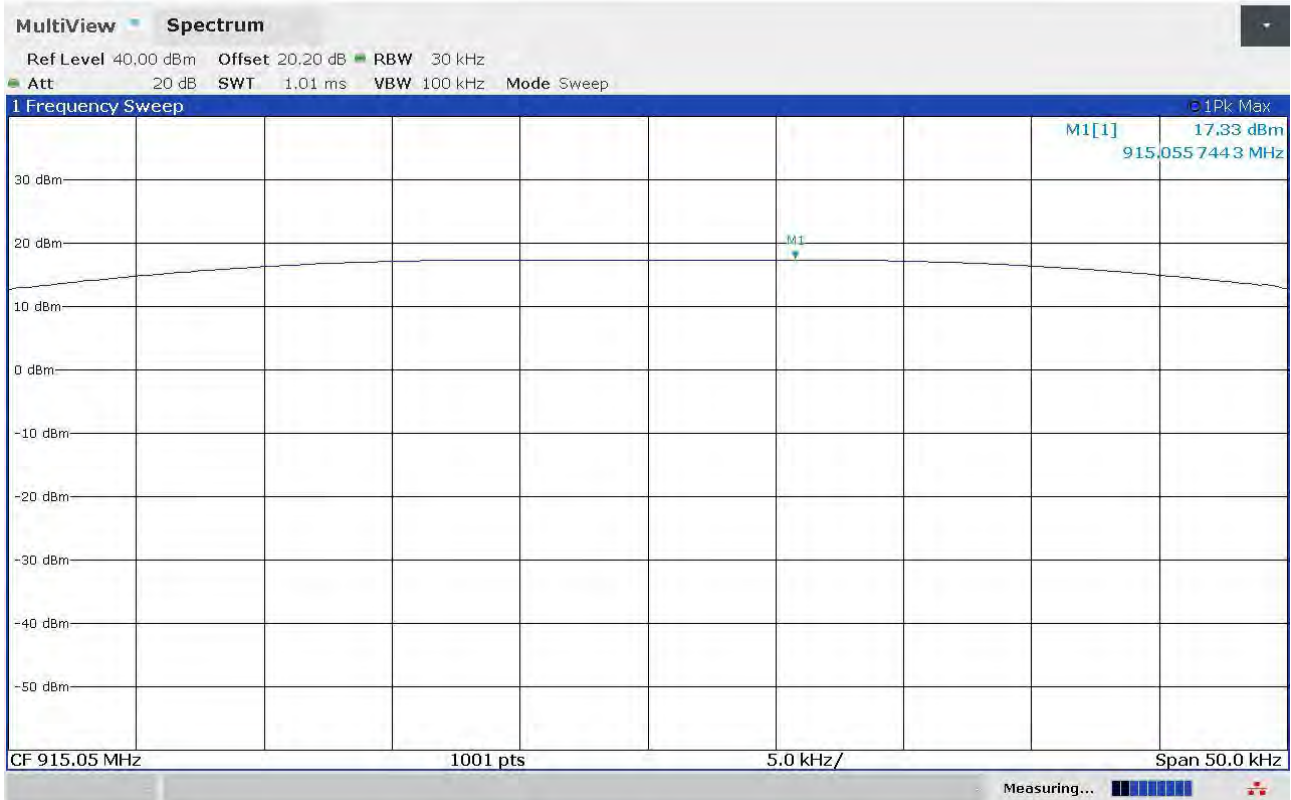

Segalla 23104626

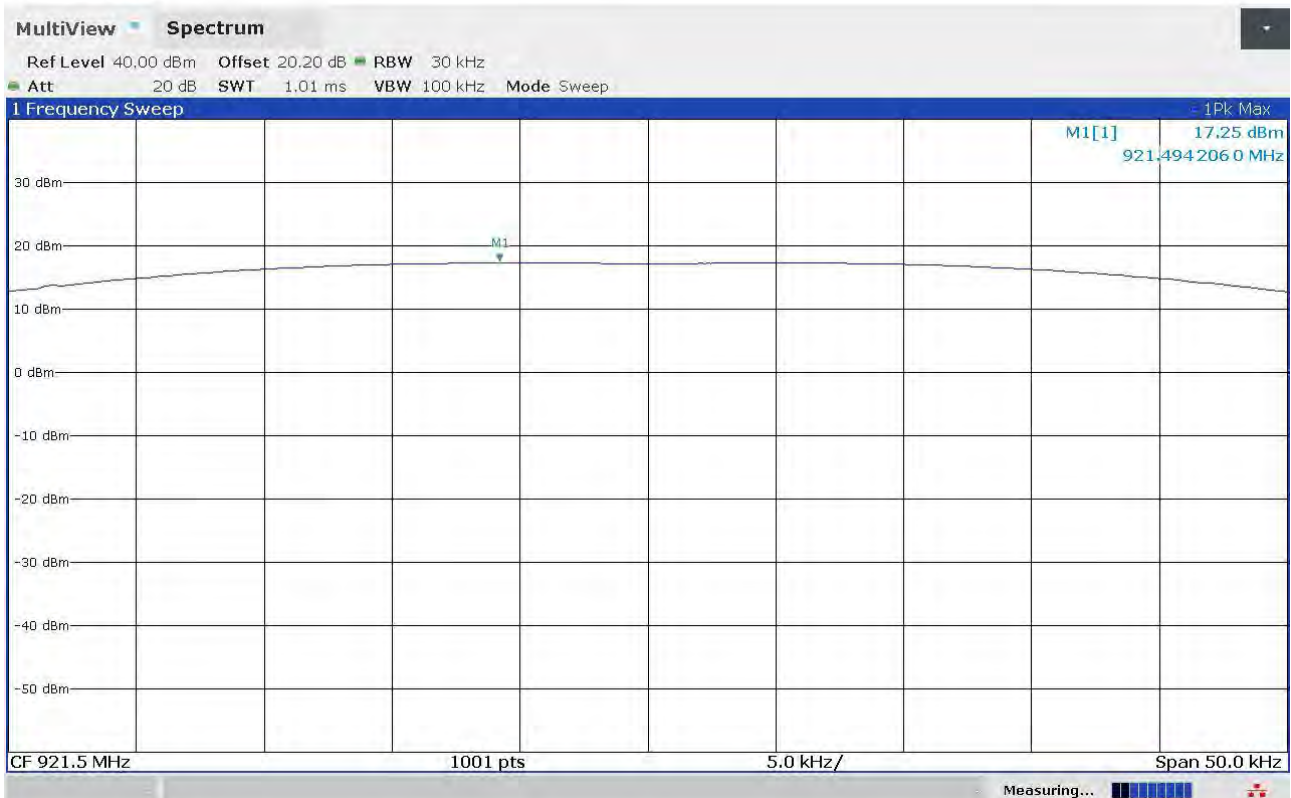

Segalla 23104634

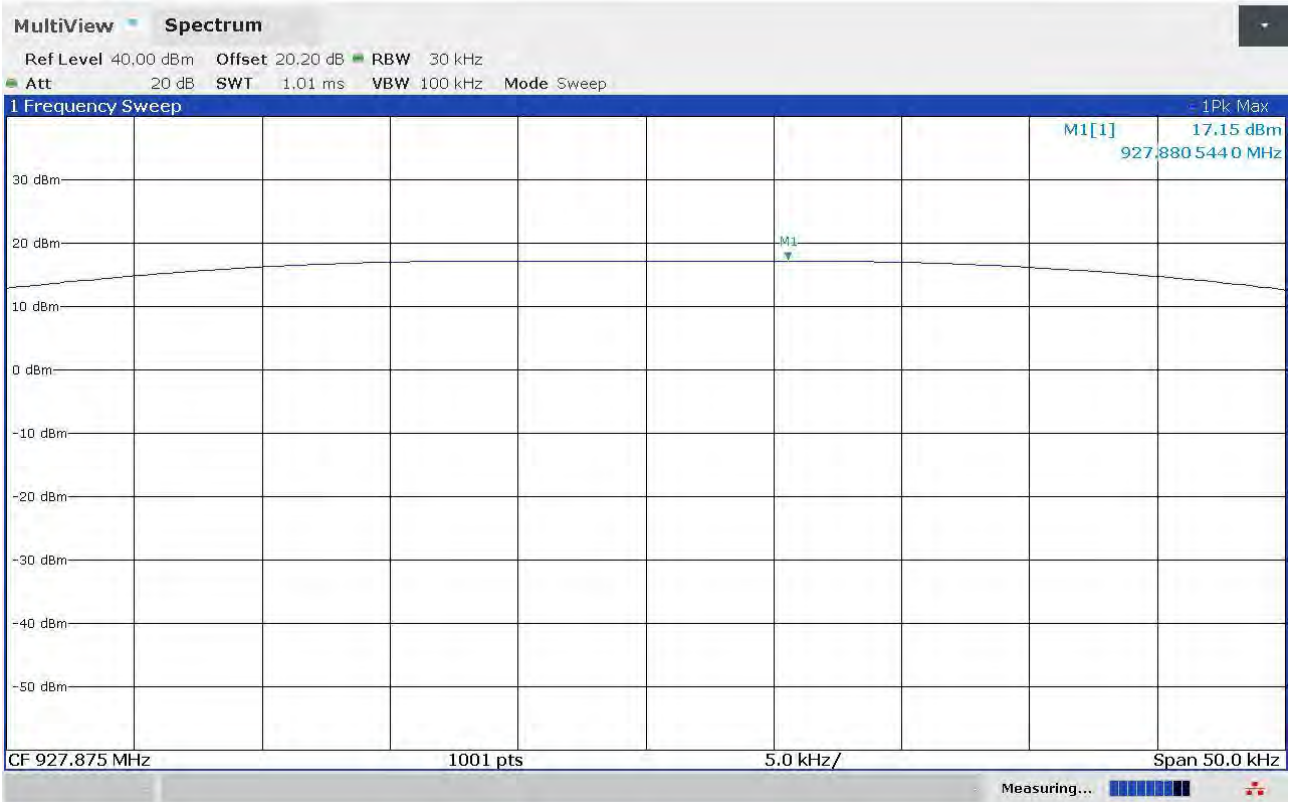

## Attachment 1

### Measurement uncertainty

Test	Test Setup	Expanded uncertainty	Note
Conducted emission CISPR 16 LISN 50uH 0,009-0,0150 MHz	PE001_01	3,4 dB	1
Conducted emission CISPR 16 LISN 50uH 0,150-30,0 MHz	PE001_01	2,9 dB	1
Conducted emission CISPR 16 Voltage Probe 0,15-30 MHz	PE001_02	2,1 dB	1
Conducted emission CISPR 16 Current Probe 0,15-30 MHz	PE001_03	2,5 dB	1
Conducted emission CISPR 16 ISN 0,15-30 MHz	PE001_04	4,7 dB	1
Clic CISPR 16 LISN 50uH 0,150-30,0 MHz	PE001_05	2,9 dB	1
Radiated Emission CDNE 30-300 MHz	PE001_06	3,3 dB	1
Disturbance Power 30-300 MHz	PE002_01	3,7 dB	1
Radiated Emission LAS 0,15-30 MHz	PE003_01	1,9 dB	1
Radiated Emission CISPR 16 Loop Ant. 0,15-30 MHz	PE004_01	4,1 dB	1
Radiated Emission CISPR 16 Bicon. Ant. 30-300 MHz	PE004_02	4,6 dB	1
Radiated Emission CISPR 16 LogP. Ant. 300-1000 MHz	PE004_03	4,5 dB	1
Radiated Emission CISPR 16 Horn Ant. 1-18 GHz	PE004_04	4,7 dB	1
Human Exposure to electromagnetic fields	PE005_01	14,2 %	1
Harmonics	PE006_01	10 mA + 2,9 %	1
Flicker	PE007_01	4,20 %	1
Radiated Immunity 80 MHz - 6 GHz	PE102_XX	2,25 dB 0,89 V/m a 3V/m	1
Conducted Immunity 0,15 - 230 MHz	PE105_XX	1,19 dB 0,44 V a 3V	1
AC Magnetic field	PE106_01	1,55 % 0,15 A/m a 10A/m	1
Pulse Magnetic field	PE107_01	6,25 % 18,8 A/m a 300A/m	1
Dumped Magnetic field	PE108_01	6,25 % 1,88 A/m a 30A/m	1
Common mode conducted immunity	PE112_01	2,22 % 0,22 V a 10V	1



## Attachment 1

Test	Test Setup	Expanded uncertainty	Note
Power/Spurious 9kHz-30MHz	PR001_01	4,1 dB	1
Power/Spurious ERP 30-1000MHz d=10m	PR001_02+03	4,7 dB	1
Misura della potenza EIRP 1-18GHz d=3m	PR001_04+05	4,7 dB	1
Misura della potenza EIRP 18-40GHz d=3m	PR001_06	5,1 dB	1
Frequency error	PR002_01+02	$< 1 \times 10^{-7}$	1
Timing zero span (1001pts.)	PR002_01+02	0,2 % SWT	1
Modulation bandwidth	PR002_01+02	$< 1 \times 10^{-7}$	1
Conducted RF power and spurious emission	PR002_01+02	1,1 dB	1
Adjacent channel power	PR002_01+02	1,1 dB	1
Blocking	PR002_01+02	1,1 dB	1

Test	Test Setup	Expanded uncertainty	Note
Electrostatic discharge immunity test	PE101_0X		2
Electrical fast transients / burst immunity test	PE103_0X		2
Surge immunity test	PE104_0X		2
Short interruption immunity test	PE109_01		2
Ring Wave immunity test	PE110_01		2
Low frequency immunity test	PE111_01		2
Dumped Oscillatory immunity test	PE113_01		2
Rev_23_01 date 20/03/2023			

**Note 1:**





The expanded uncertainty reported according to the document EA-4-02 is based on a standard uncertainty multiplied by a coverage factor of  $k=2$ , providing a level of confidence of  $p = 95\%$

**Note 2:**

It has been demonstrated that the used test equipment meets the specified requirements in the standard with at least a 95% confidence, covering factor  $k=2$

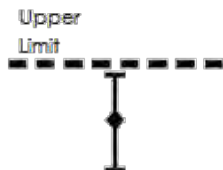
### Attachment 1

#### Judgement of compliance

Case 1	Case 2	Case 3	Case 4
 <p>The sample complies with the requirements.</p> <p>The measurement results is within the specification limit when the measurement uncertainty is taken into account.</p>	 <p>The sample complies with the requirements.</p> <p>It is not possible to state compliance using a 95% coverage probability for the expanded uncertainty although the measurement result is below the limit.</p>	 <p>The sample does not comply with the requirements.</p> <p>It is not possible to state compliance using a 95% coverage probability for the expanded uncertainty also the measurement result is upper the limit.</p>	 <p>The sample does not comply with the requirements.</p> <p>The measurement results is outside the specification limit when the measurement uncertainty is taken into account.</p>

In agreement with ILAC-G8:09/2019 cl.4.2.1 Guidelines on Decision Rules and Statements of Conformity

#### Quality manual references – Internal procedure

Internal Procedure PM001 rev. 4.0 (Quality Manual) .....	Measure procedure
Internal Procedure INC_M rev. 10.0 (Quality Manual) .....	Measurement uncertainty calculation